

---

**TABLE OF CONTENTS**

---

Elevations/Sizes: 1/4" Scale .....	4-2
Single Units .....	4-4
Glazing Options: 3" Scale .....	4-7
Trim Options: 3" Scale .....	4-8
Jamb Extender Options: 3" Scale .....	4-9
Standard Mullion Options .....	4-10
Lite Cut Information & Options .....	4-11
Vent Projections .....	4-13
Unit Sizing, Rough Openings & Masonry Openings .....	4-14
Section Details: 6" Scale .....	4-15

**GENERAL INFORMATION**

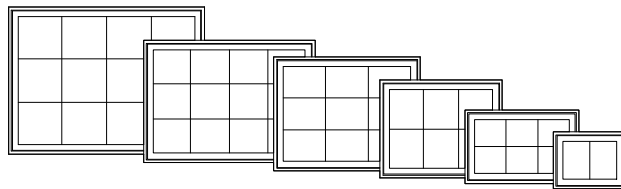
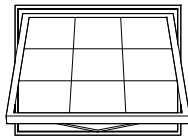

**DIMENSIONAL WINDOWS**

Wood awning windows may be specified as "dimensional" by adjusting the desired rough opening width or height in 1/4" increments from standard.

Wood awning windows are available as operating or stationary (non - venting). Operating mechanism includes corrosion resistant steel hinges and roto type operators for venting units. Sash locks are concealed unison type with an exposed locking lever and escutcheon plate. There are several interior hardware finish options. Refer to the Specifications for finish options.

**MULTIPLE ASSEMBLIES**

Wood awning windows may be mullered above, below, or beside other wood awning windows, or other wood window products. Factory assembled mulls are limited in height (100"), width (150"), and a total area (75 square feet).

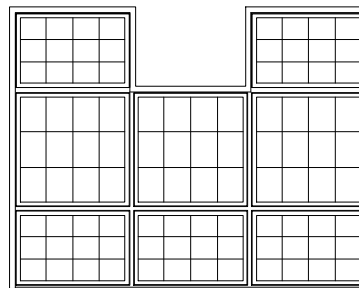
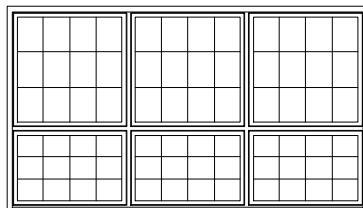
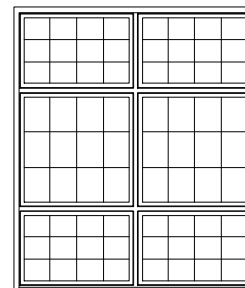
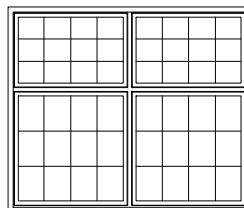
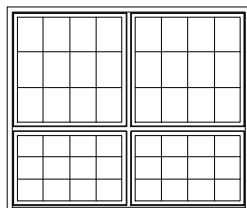

**ELEVATION NOTES**

ELEVATION DRAWINGS UTILIZE A LIMITED NUMBER OF PROJECTED LINES TO PRODUCE A RUDIMENTARY DRAWING INTENDED TO BE USED IN A SMALL GRAPHICAL SCALE. ELEVATIONS ARE VIEWED PERPENDICULAR FROM THE EXTERIOR OF THE STRUCTURE. IF MORE DIMENSIONS ARE NEEDED, USE THE SECTION DRAWINGS FOR MORE COMPLETE DEPICTIONS.

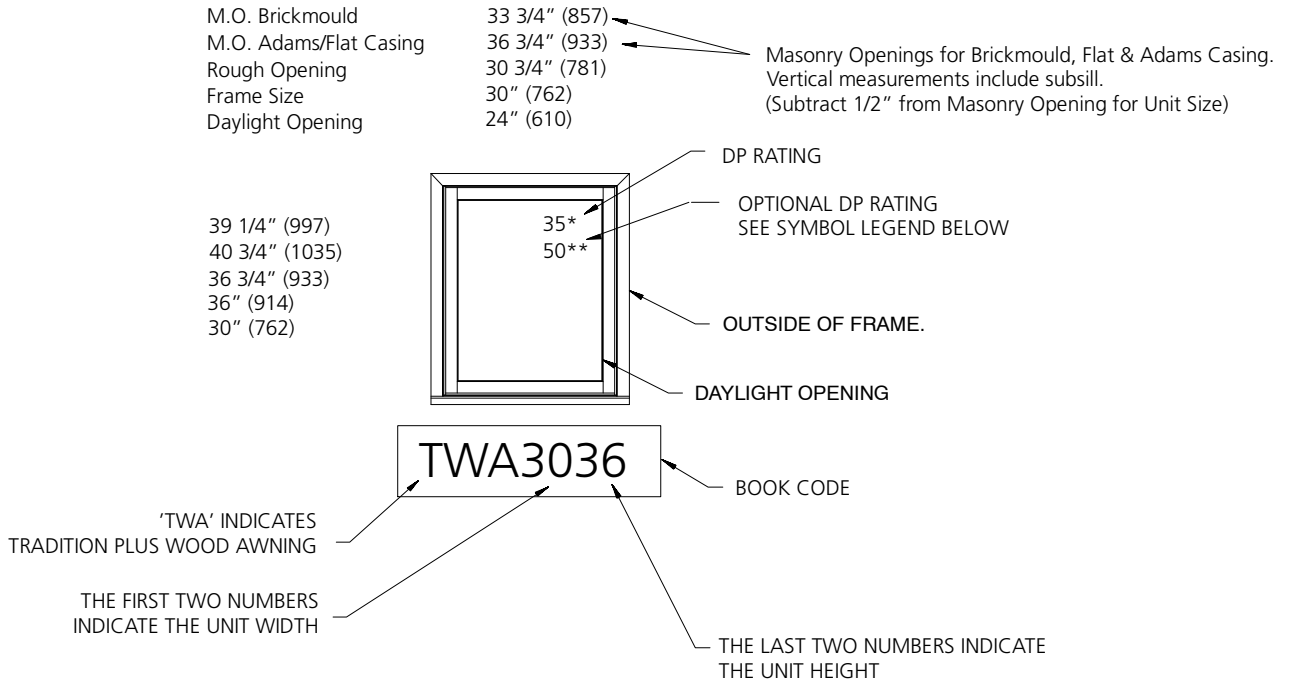

























































**GENERAL AWNING NOTES**

1. TRADITION PLUS WOOD AWNING (TWA) UNITS ARE AVAILABLE AS OPERATING OR STATIONARY UNITS.
2. UNIT ELEVATIONS ARE SHOWN WITH BRICKMOULD AND SUBSILL.
3. DIMENSIONAL VALUES IN PARENTHESES ARE MILLIMETER CONVERSIONS.
4. ALL GLASS SIZES ARE MONINAL.

**ELEVATION SYMBOL LEGEND:**

- M.O.** MASONRY OPENING
- ##\*** NUMBER INDICATES DESIGN PRESSURE (DP) RATING WITH STANDARD GLAZING ON OPERATING OR STATIONARY UNITS.
- ##\*\*** NUMBER INDICATES OPTIONAL DESIGN PRESSURE (DP) RATING ON OPERATING OR STATIONARY UNITS.
- S** STATIONARY UNIT

#### SINGLE UNITS

M.O. BRICKMOULD	20 3/4" (527)	23 3/4" (603)	27 3/4" (705)	31 3/4" (806)	33 3/4" (857)	35 3/4" (908)	39 3/4" (1010)
M.O. ADAMS/FLAT CASING	23 3/4" (603)	26 3/4" (679)	30 3/4" (781)	34 3/4" (883)	36 3/4" (933)	38 3/4" (984)	42 3/4" (1086)
ROUGH OPENING	17 3/4" (451)	20 3/4" (527)	24 3/4" (629)	28 3/4" (730)	30 3/4" (781)	32 3/4" (832)	36 3/4" (933)
FRAME SIZE	17" (432)	20" (508)	24" (610)	28" (711)	30" (762)	32" (813)	36" (914)
DAYLIGHT OPENING	11" (279)	14" (356)	18" (457)	22" (559)	24" (610)	26" (660)	30" (762)
20 1/4" (514) 21 3/4" (552) 17 3/4" (451) 17" (432) 11" (279)	 TWA1717	 TWA2017	 TWA2417	 TWA2817	 TWA3017	 TWA3217	 TWA3617
23 1/4" (591) 24 3/4" (635) 20 3/4" (527) 20" (508) 14" (356)	 TWA1720	 TWA2020	 TWA2420	 TWA2820	 TWA3020	 TWA3220	 TWA3620
27 1/4" (692) 28 3/4" (730) 24 3/4" (629) 24" (610) 18" (457)	 TWA1724	 TWA2024	 TWA2424	 TWA2824	 TWA3024	 TWA3224	 TWA3624
31 1/4" (794) 32 3/4" (832) 28 3/4" (730) 28" (711) 22" (559)	 TWA1728	 TWA2028	 TWA2428	 TWA2828	 TWA3028	 TWA3228	 TWA3628
33 1/4" (845) 34 3/4" (883) 30 3/4" (781) 30" (762) 24" (610)	 TWA1730	 TWA2030	 TWA2430	 TWA2830	 TWA3030	 TWA3230	 TWA3630
39 1/4" (997) 40 3/4" (1035) 36 3/4" (933) 36" (914) 30" (762)	 TWA1736	 TWA2036	 TWA2436	 TWA2836	 TWA3036	 TWA3236	 TWA3636
43 1/4" (1099) 44 3/4" (1137) 40 3/4" (1035) 40" (1016) 34" (864)	 TWA1740	 TWA2040	 TWA2440	 TWA2840	 TWA3040	 TWA3240	 TWA3640
51 1/4" (1302) 52 3/4" (1340) 48 3/4" (1238) 48" (1219) 42" (1067)	 TWA1748	 TWA2048	 TWA2448	 TWA2848	 TWA3048	 TWA3248	 TWA3648



**ELEVATION SYMBOL LEGEND:**

M.O. = MASONRY OPENING  
 VALUES IN ( ) ARE IN MILLIMETER CONVERSIONS  
 ### NUMBER INDICATES DESIGN PRESSURE (DP) RATING WITH STANDARD GLAZING.  
 ###\* NUMBER INDICATES OPTIONAL DESIGN PRESSURE (DP) RATING.

Note Elevations shown DO NOT have exterior trim. Subtract 3/4" (19) from M.O. (Masonry Opening) for Unit Sizes. Masonry Openings above include Sill Nose, see Trim Options page for Sill Nose specifications. For other Trim Options refer to the Unit Sizing, Rough Opening & Masonry Openings page.

SCALE: 1/4" = 1'

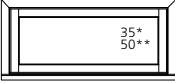
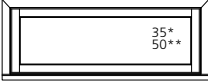
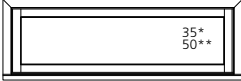
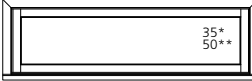
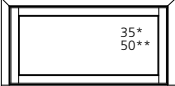
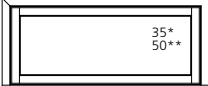
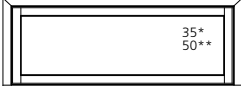
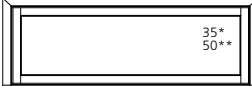
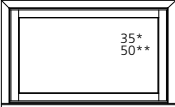
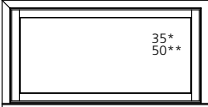
### SINGLE UNITS

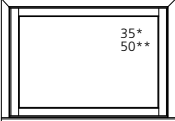
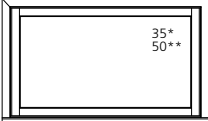
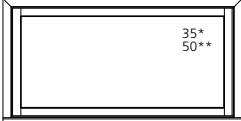
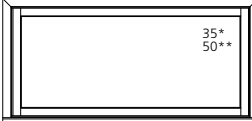
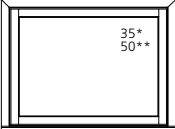
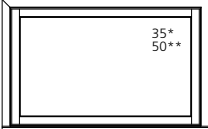
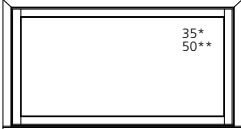
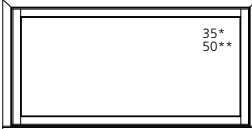
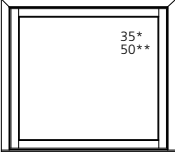
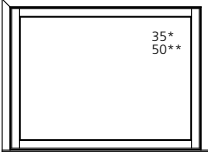
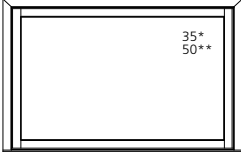
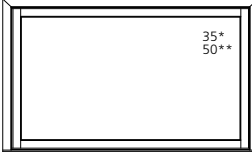
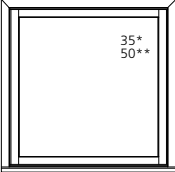
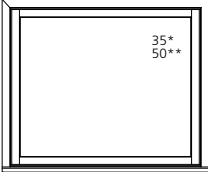
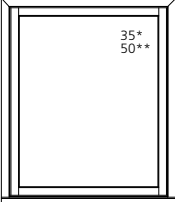
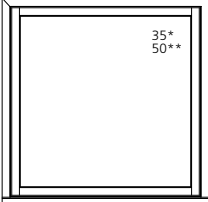
M.O. BRICKMOULD	43 3/4" (1111)	51 3/4" (1314)	59 3/4" (1518)	63 3/4" (1619)
M.O. ADAMS/FLAT CASING	46 3/4" (1187)	54 3/4" (1391)	62 3/4" (1594)	66 3/4" (1695)
ROUGH OPENING	40 3/4" (1035)	48 3/4" (1238)	56 3/4" (1441)	60 3/4" (1543)
FRAME SIZE	40" (1016)	48" (1219)	56" (1422)	60" (1524)
DAYLIGHT OPENING	34" (864)	42" (1067)	50" (1270)	54" (1372)
20 1/4" (514) 21 3/4" (552) 17 3/4" (451) 17" (432) 11" (279)	 TWA4017	 TWA4817	 TWA5617	 TWA6017
23 1/4" (591) 24 3/4" (629) 20 3/4" (527) 20" (508) 14" (356)	 TWA4020	 TWA4820	 TWA5620	 TWA6020
27 1/4" (692) 28 3/4" (730) 24 3/4" (629) 24" (610) 18" (457)	 TWA4024	 TWA4824	 TWA5624	 TWA6024
31 1/4" (794) 32 3/4" (832) 28 3/4" (730) 28" (711) 22" (559)	 TWA4028	 TWA4828	 TWA5628	 TWA6028
33 1/4" (845) 34 3/4" (883) 30 3/4" (781) 30" (762) 24" (610)	 TWA4030	 TWA4830	 TWA5630	 TWA6030
39 1/4" (997) 40 3/4" (1035) 36 3/4" (933) 36" (914) 30" (762)	 TWA4036	 TWA4836	 TWA5636	 TWA6036
43 1/4" (1099) 44 3/4" (1137) 40 3/4" (1035) 40" (1016) 34" (864)	 TWA4040	 TWA4840		
51 1/4" (1302) 52 3/4" (1340) 48 3/4" (1238) 48" (1219) 42" (1067)	 TWA4048	 TWA4848		

**ELEVATION SYMBOL LEGEND:**  
**M.O.** = MASONRY OPENING  
 VALUES IN ( ) ARE IN MILLIMETER CONVERSIONS  
**##** NUMBER INDICATES DESIGN PRESSURE (DP) RATING WITH STANDARD GLAZING.  
**###** NUMBER INDICATES OPTIONAL DESIGN PRESSURE (DP) RATING.

Note Elevations shown DO NOT have exterior trim. Subtract 3/4" (19) from M.O. (Masonry Opening) for Unit Sizes. Masonry Openings above include Sill Nose, see Trim Options page for Sill Nose specifications. For other Trim Options refer to the Unit Sizing, Rough Opening & Masonry Openings page.

SCALE: 1/4" = 1'

**SINGLE UNITS**

**M.O. BRICKMOULD**  
**M.O. ADAMS/FLAT CASING**  
**ROUGH OPENING**  
**FRAME SIZE**  
**DAYLIGHT OPENING**

67 3/4"(1721)  
70 3/4"(1797)  
64 3/4"(1645)  
64"(1626)  
58"(1473)

75 3/4"(1924)  
78 3/4"(2000)  
72 3/4"(1848)  
72"(1829)  
66"(1676)

20 1/4"(514)  
21 3/4"(552)  
17 3/4"(451)  
17"(432)  
11"(279)



TWA6417



TWA7217

23 1/4"(591)  
24 3/4"(629)  
20 3/4"(527)  
20"(508)  
14"(356)



TWA6420



TWA7220

27 1/4"(692)  
28 3/4"(730)  
24 3/4"(629)  
24"(610)  
18"(457)



TWA6424



TWA7224

**ELEVATION SYMBOL LEGEND:**

**M.O.** = MASONRY OPENING  
VALUES IN ( ) ARE IN MILLIMETER CONVERSIONS  
### NUMBER INDICATES DESIGN PRESSURE (DP) RATING WITH STANDARD GLAZING.  
**S** STATIONARY UNIT

Note Elevations shown DO NOT have exterior trim. Subtract 3/4" (19) from M.O. (Masonry Opening) for Unit Sizes. Masonry Openings above include Sill Nose, see Trim Options page for Sill Nose specifications. For other Trim Options refer to the Unit Sizing, Rough Opening & Masonry Openings page.

SCALE: 1/4" = 1'

---

**GLAZING OPTIONS**

---

**INTERIOR GLAZED**

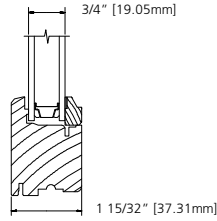

**INSULATED GLASS**

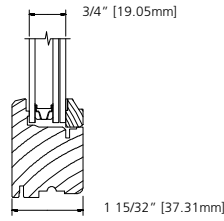

**LAMINATED INSULATED  
CLEAR OR LOW-E**  
3.0mm/6.7mm LAMINATE

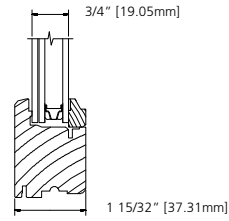

**LAMINATED INSULATED  
TINTED**  
6.7mm LAMINATE/3.0mm

**TRIM OPTIONS**

**WOOD EXTERIOR TRIM**

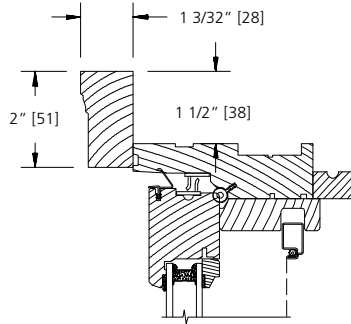

**BRICKMOULD**

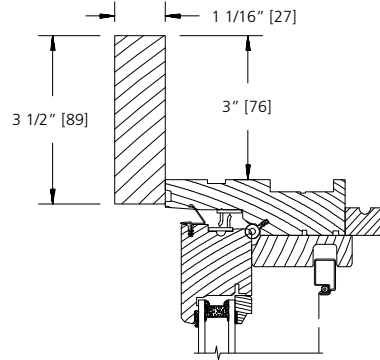

**FLAT CASING**

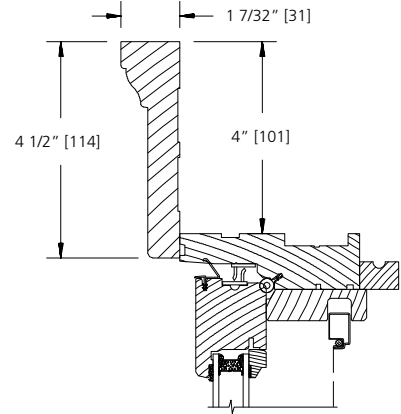

**1 X 4 BACK BAND**

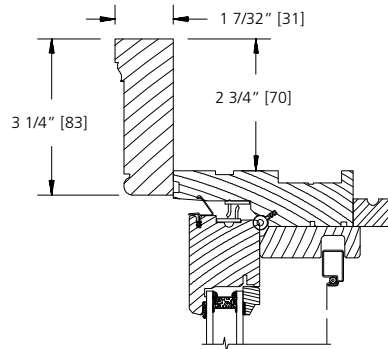

**HERITAGE**

**WOOD SUBSILL OPTIONS**

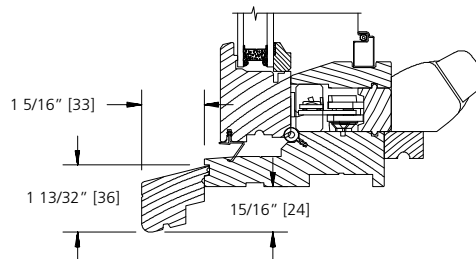

**STANDARD**

SCALE: 3" = 1'



JAMB EXTENDER OPTIONS

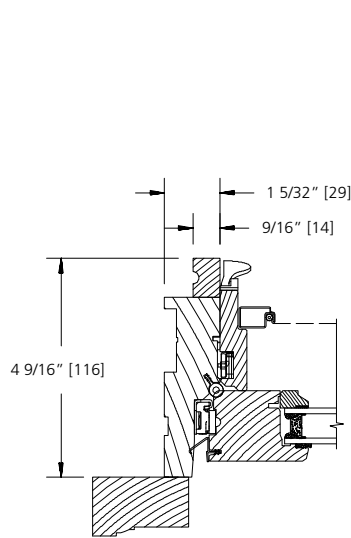

**4 9/16" WALL**

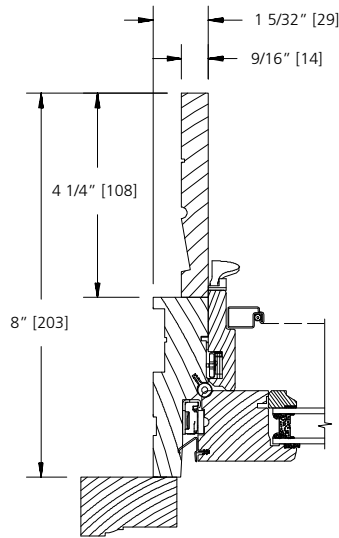

**8" WALL**

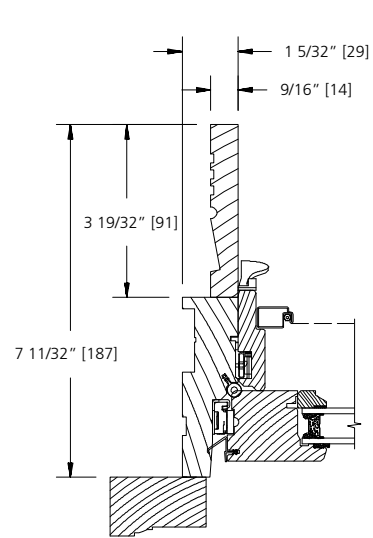

**8 7/16" WALL**

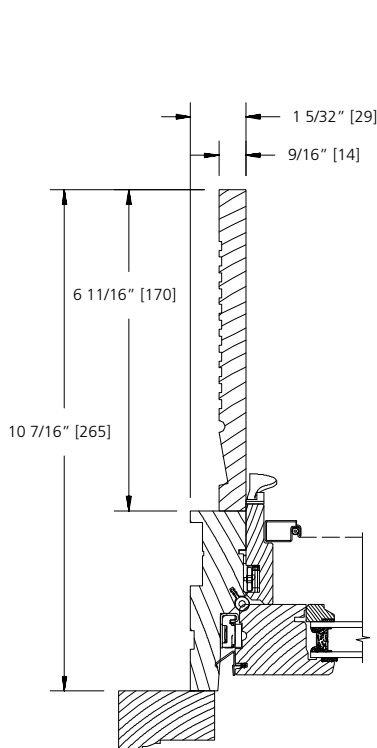

**10 7/16" WALL**

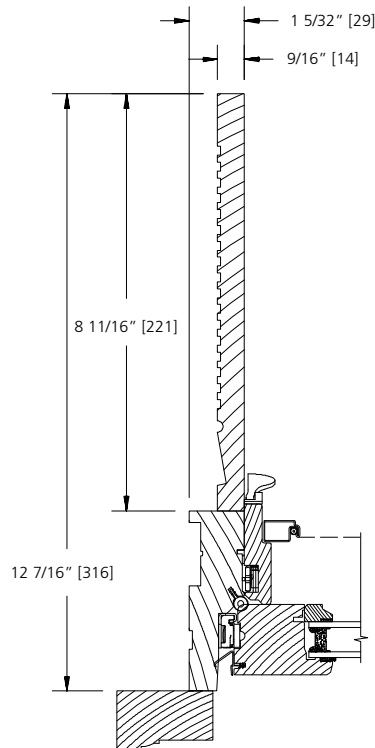

**12 7/16" WALL**

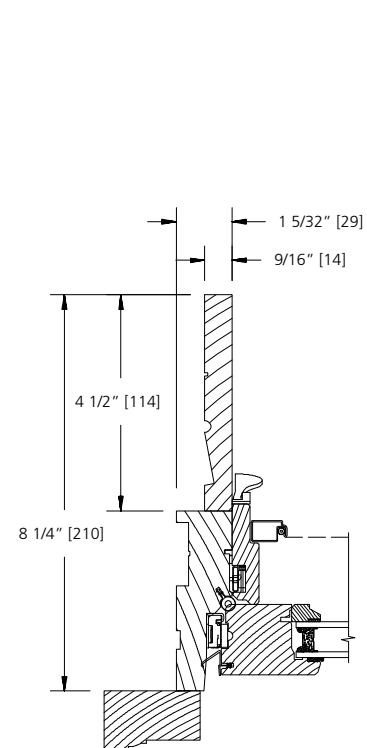

**8 1/4" WALL**

SCALE: 3" = 1'

STANDARD MULLION OPTIONS

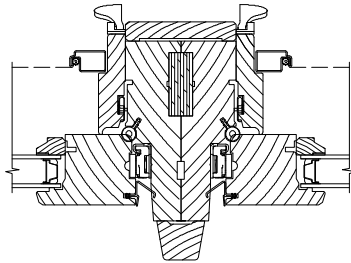

TWIN OPERATING AWNING

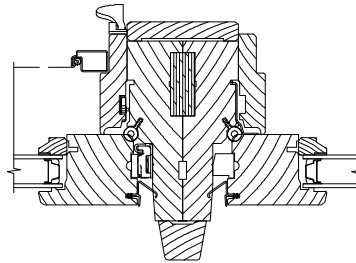

OPERATING AWNING  
NEXT TO AWNING STATIONARY

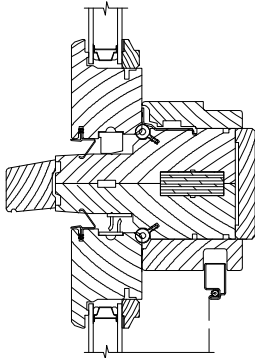

AWNING STATIONARY  
OVER AWNING

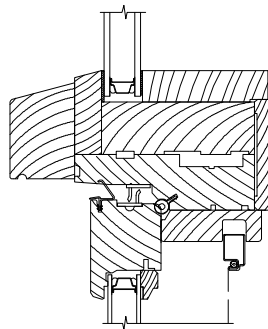

DIRECT SET GEOMETRIC  
OVER AWNING

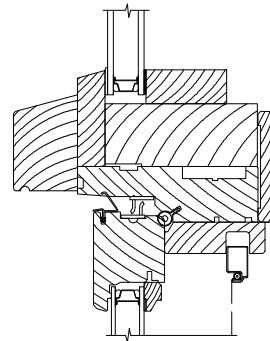

DIRECT SET RADIUS  
OVER AWNING

**LITE CUT INFORMATION**

Wood awning windows are available with removable grilles in 7/8", 1-1/8" and 1-3/8" widths, GBG (Grilles between the Glass), and Simulated Divided Lites. Standard lite cuts are rectangular.

**LITE CUT OPTIONS**

Special lite cut patterns can include a wide variety of straight line and radius patterns. The illustrations shown here represent just a few of the possibilities. Rectangular, horizontal, vertical and Prairie lite patterns are available in all standard size wood windows. Uneven, diamond, radius and Gothic lite cuts are available, subject to approval. Approvals are based on the ability to fulfill the design requirement while maintaining the construction integrity of the finished product.

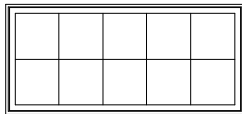

RECTANGULAR

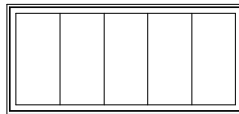

VERTICAL

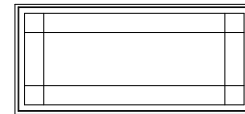

PRAIRIE

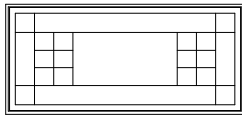

UNEVEN

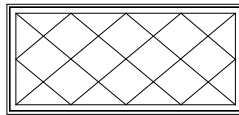

DIAMOND

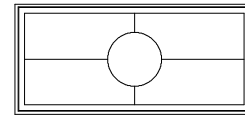

RADIUS

**BAR ALIGNMENT**

Alignment of divided lite muntin bars from one window to the next is often required by fine architectural design. Wood grilles, GBG (Grilles between the Glass), and Simulated Divided Lites may be specified with muntin bars aligned.

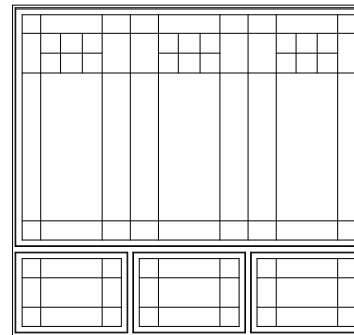

**DIVIDED LITE OPTIONS**

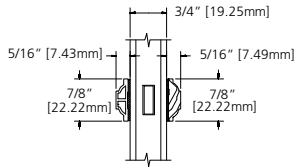

**7/8" SDL**

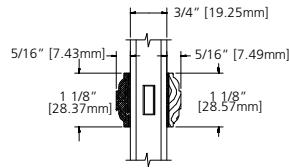

**1 1/8" SDL**

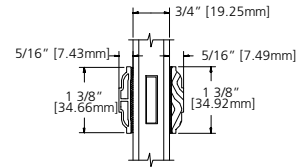

**1 3/8" SDL**

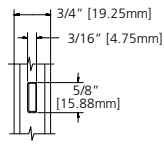

**5/8" GRILLE**

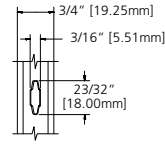

**23/32" GRILLE**

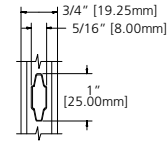

**1" GRILLE**

**VENT PROJECTIONS**

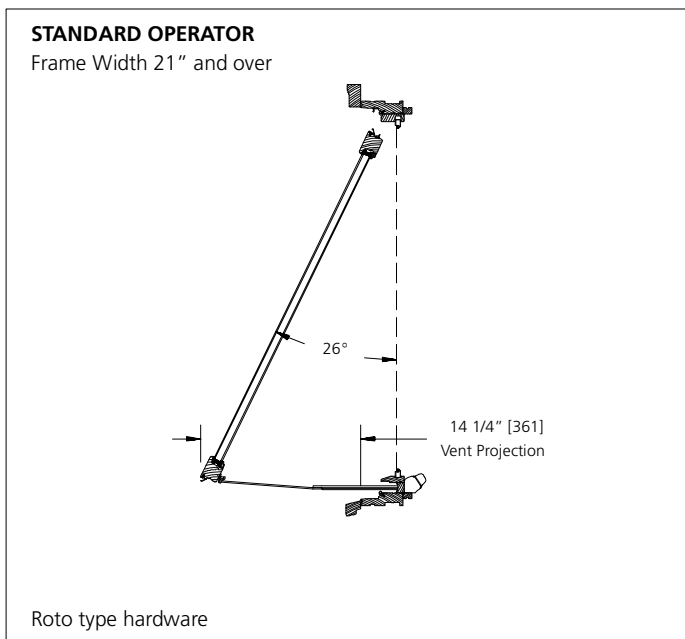
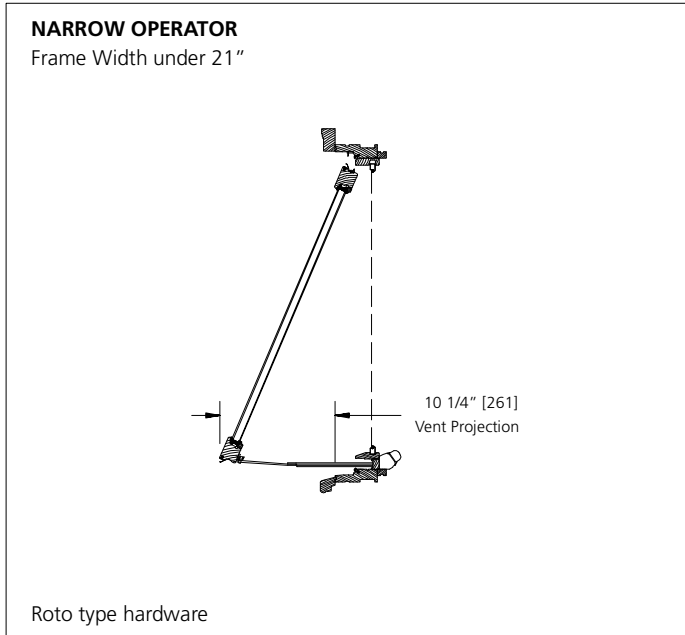

**AWNING VENT PROJECTION**

The drawings above reflect full operation. Dimensions and angles above are approximate and will vary due to frame height.

**UNIT SIZING, ROUGH OPENINGS  
& MASONRY OPENINGS**

**STANDARD OFFERING  
OF BRICKMOULD & SUBSILL**

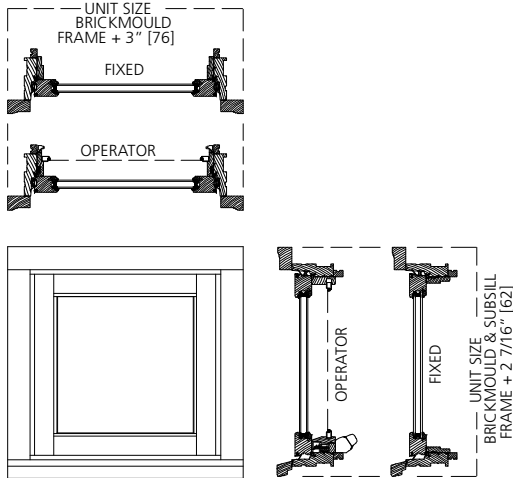

**GENERAL NOTES:**

UNITS WITH NO TRIM AND SUBSILL:  
UNIT SIZE = FRAME SIZE

UNIT SIZE IS ALWAYS THE  
EXTREME SIZE OF THE WINDOW  
WITH OR WITHOUT TRIM

MASONRY OPENING:  
MASONRY OPENING IS ALWAYS 1/2" OVER  
THE UNIT SIZE OF THE WINDOW

**ROUGH OPENING:**

ROUGH OPENING IS ALWAYS 1/2" OVER  
FRAME SIZE OF THE WINDOW

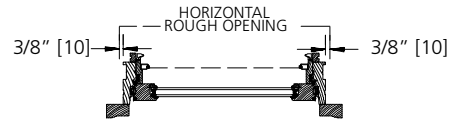

EXCEPTION: SEE DRAWING BELOW

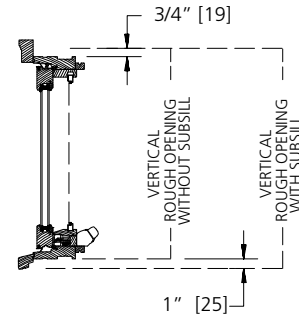

**NON-STANDARD UNIT SIZING**

EXTERIOR TRIM OFFERINGS WITH SUBSILL

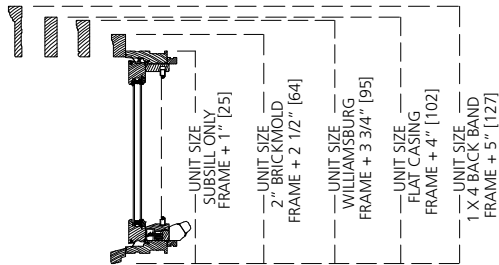

**FRAME TO TRIM  
DIMENSIONS**

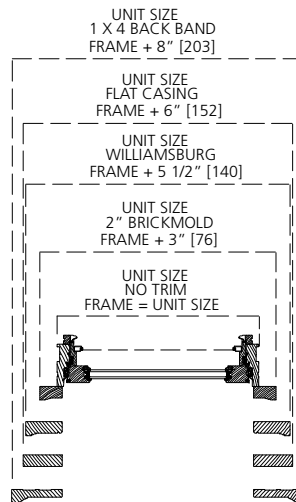
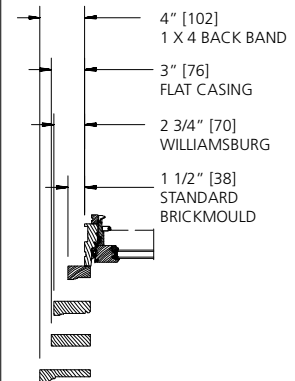

HORIZONTAL SECTION  
TRIM OFFERINGS  
ABOVE ARE THE SAME  
WITH OR WITHOUT SUBSILL

TYPICAL FOR HEAD, SILL & SIDE

**OPERATING UNIT**

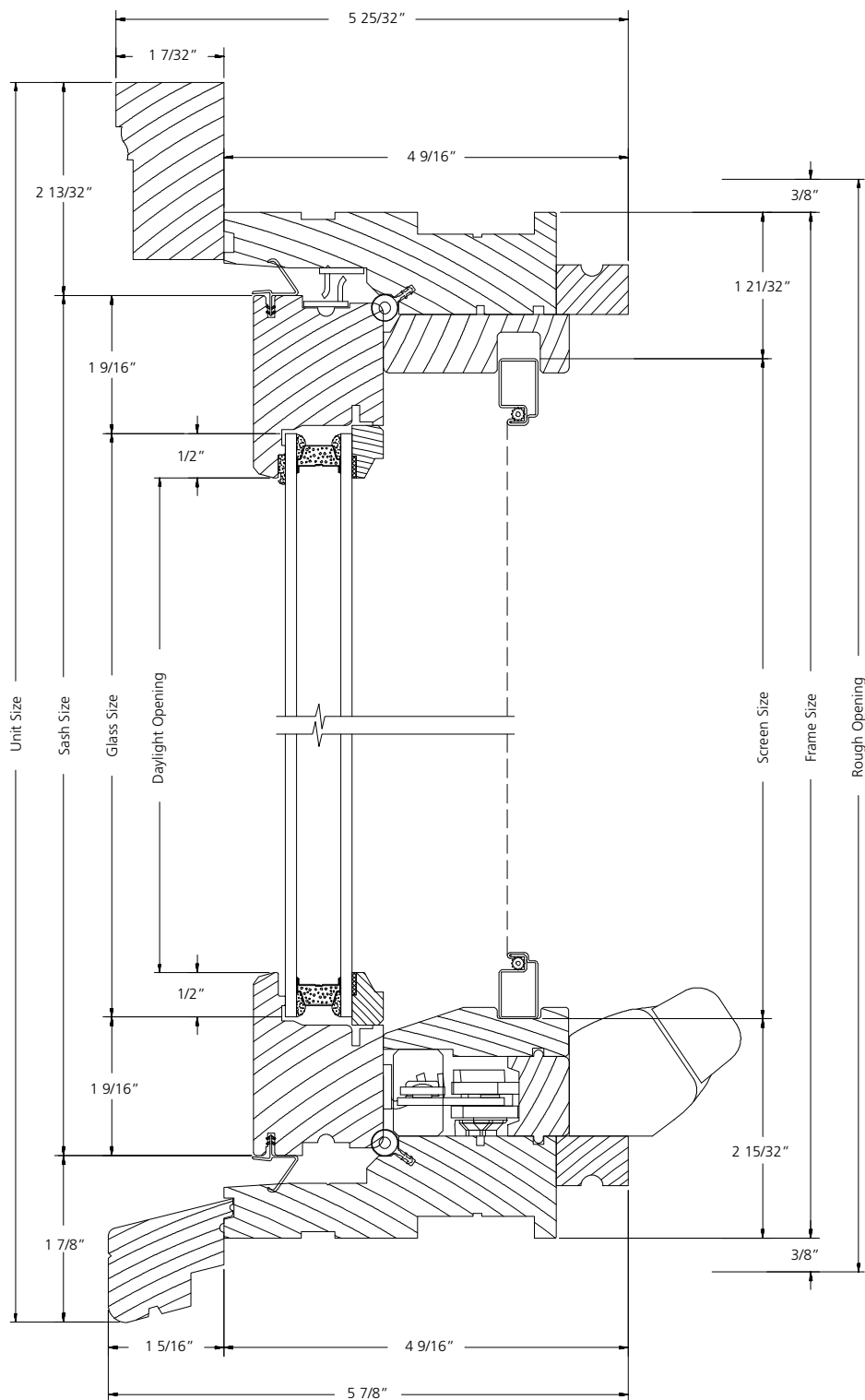

**VERTICAL SECTION**

SCALE: 6" = 1'

**OPERATING UNIT**

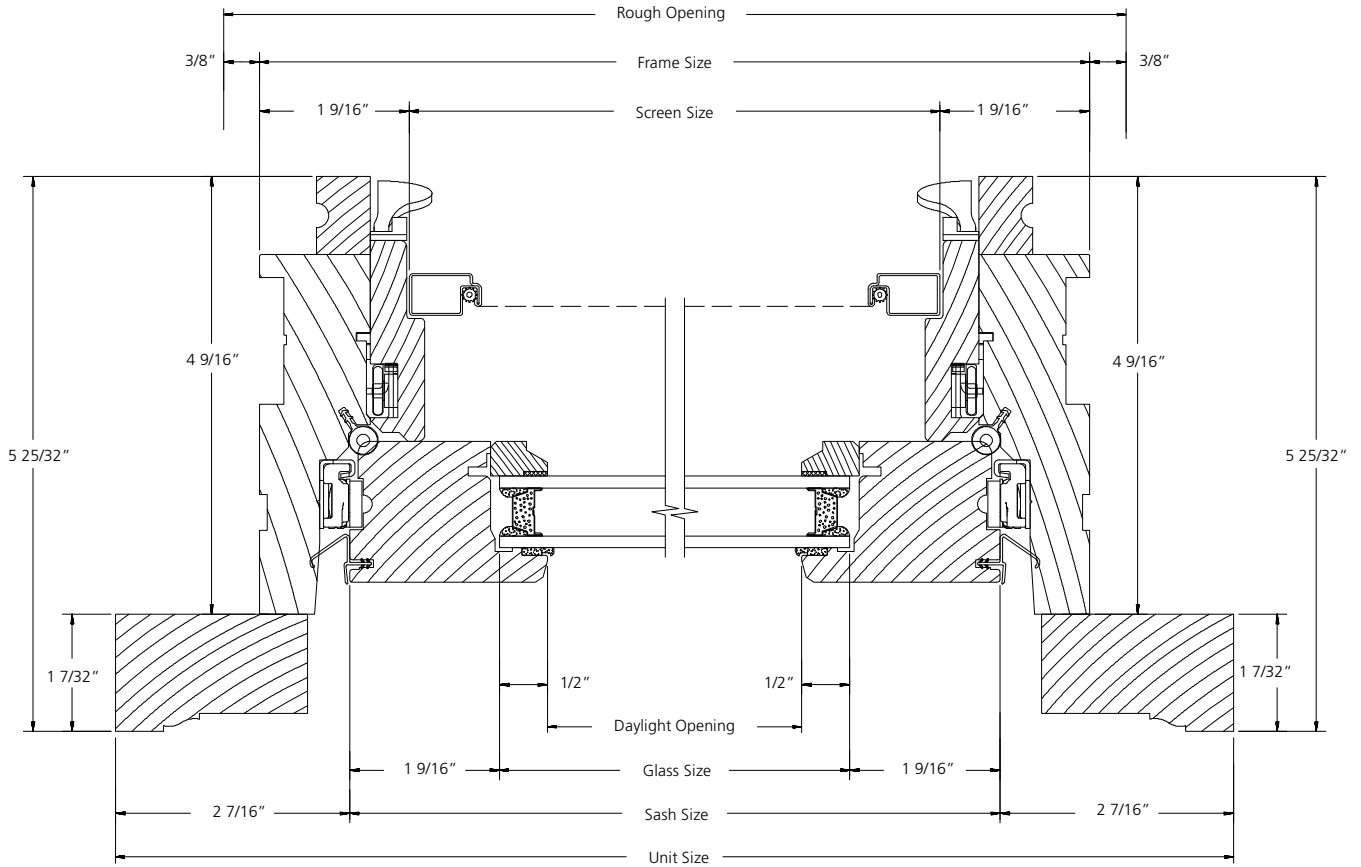

**HORIZONTAL SECTION**

SCALE: 6" = 1'