

---

**TABLE OF CONTENTS**

---

Elevations/Sizes: 1/4" Scale .....	1-2
1-Wide Units .....	1-5
2-Wide Units .....	1-7
3-Wide Units .....	1-9
4-Wide Units .....	1-11
Picture Units .....	1-14
Picture Units with Flankers .....	1-21
30° & 45° Bay Units with Flankers .....	1-27
4-, 5- & 6-Wide Bow Units .....	1-39
Glazing Options: 3" Scale .....	1-44
Trim Options: 3" Scale .....	1-45
Jamb Extender Options: 3" Scale .....	1-46
Standard Mullion Options .....	1-47
Lite Cut Information & Options .....	1-49
Unit Sizing, Rough Openings & Masonry Openings .....	1-51
Section Details: 6" Scale .....	1-52
Bay and Bow Specifications .....	1-59
Section Details (Bay & Bow): 6" Scale .....	1-61

**GENERAL INFORMATION**

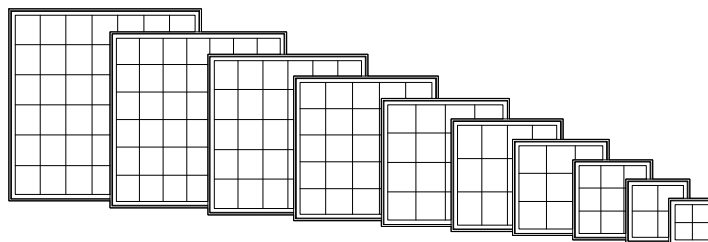

**DIMENSIONAL WINDOWS**

Clad casement windows may be specified as "dimensional", by adjusting the desired rough opening width or height in 1/8" increments from standard.

Clad casement windows are available with left or right hand operation, or stationary (non-venting). Operating mechanism includes corrosion resistant steel hinges and dual arm roto-type operator with hardened steel gears and operating arms. Sash locks are concealed unison type with an exposed locking lever and escutcheon plate. There are several interior hardware finish options. Refer to the Specifications for finish options.

**MULTIPLE ASSEMBLIES**

Clad casement windows may be mullied above, below, or beside other clad casement windows, or other clad window products. Factory assembled mulls are limited in height (100"), width (150"), and a total area (75 square feet).

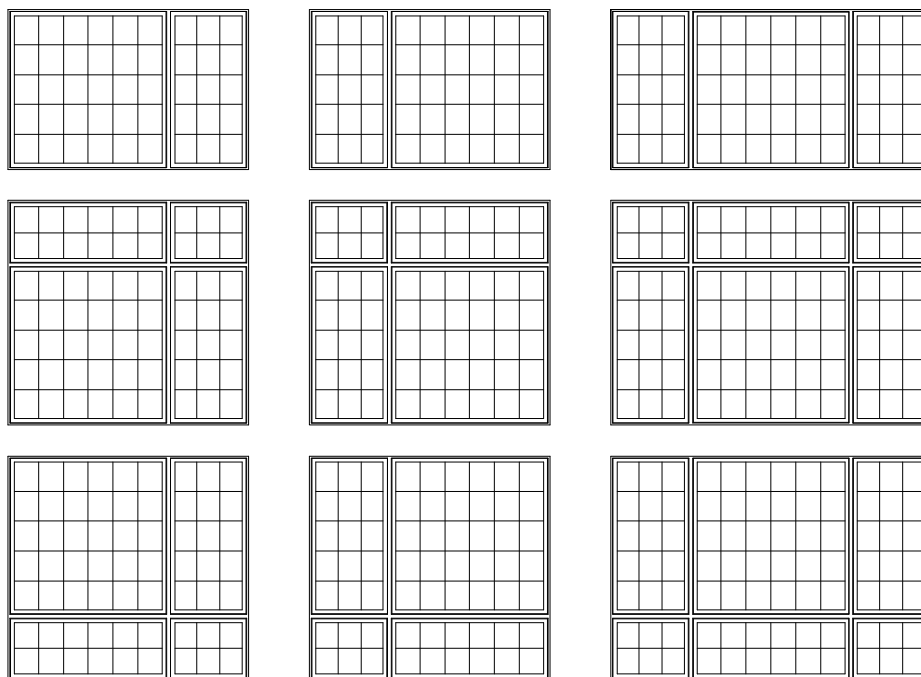

---

HANDING & OPERATION

---

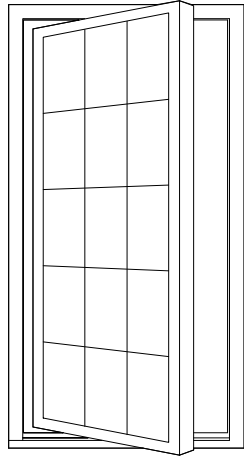

**LEFT  
HAND**

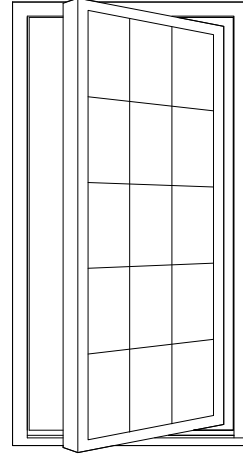

**RIGHT  
HAND**

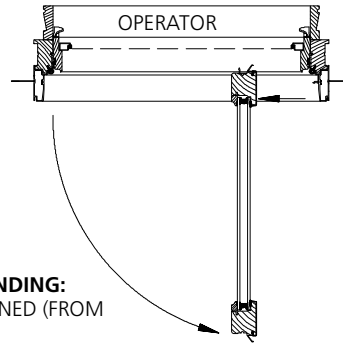
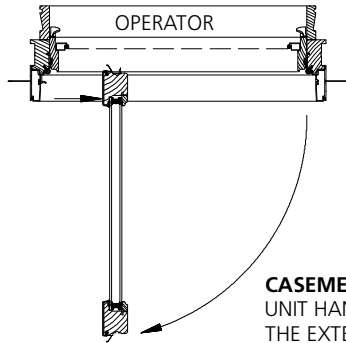

**CASEMENT UNIT HANDING:**  
UNIT HANDING IS DEFINED (FROM  
THE EXTERIOR) AS THE  
DIRECTION THE SASH OPENS.

**ELEVATION NOTES**  
**CASEMENT**

ELEVATION DRAWINGS UTILIZE A LIMITED NUMBER OF PROJECTED LINES TO PRODUCE A RUDIMENTARY DRAWING INTENDED TO BE USED IN A SMALL GRAPHICAL SCALE. ELEVATIONS ARE VIEWED PERPENDICULAR FROM THE EXTERIOR OF THE STRUCTURE. IF MORE DIMENSIONS ARE NEEDED, USE THE SECTION DRAWINGS FOR MORE COMPLETE DEPICTIONS.

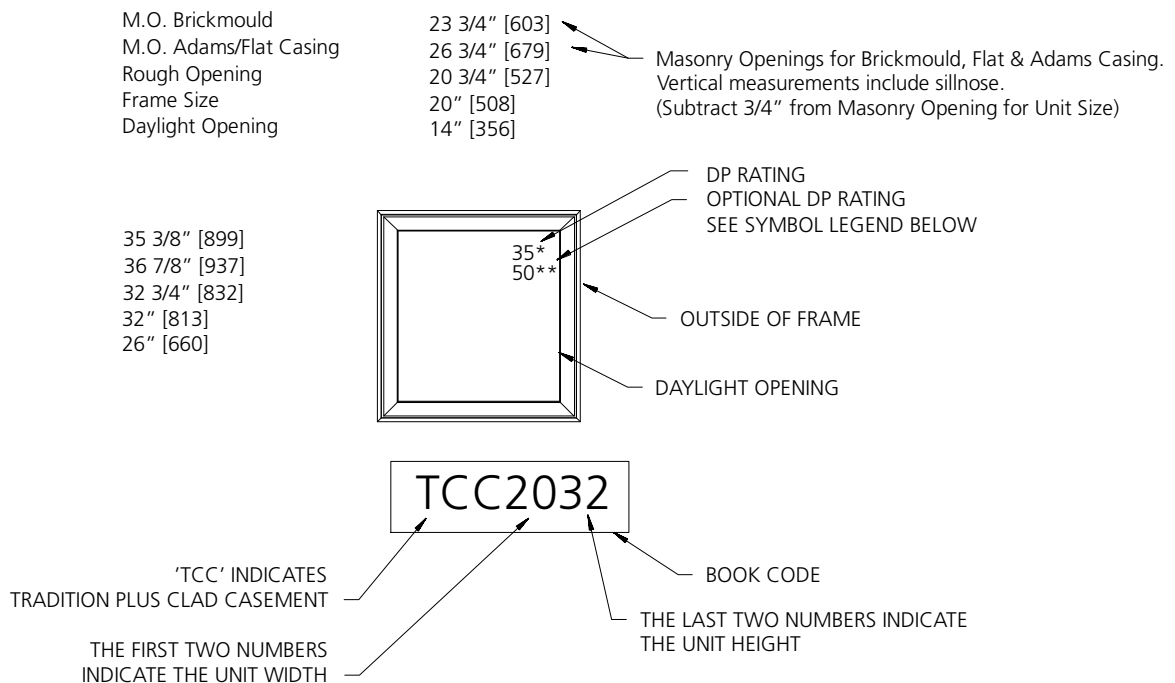

**GENERAL CASEMENT NOTES**

1. TRADITION PLUS CLAD CASEMENT (TCC) UNITS ARE AVAILABLE AS OPERATING OR STATIONARY UNITS.
2. 'TCCP' IN A BOOK CODE DENOTES THE UNIT IS A CLAD CASEMENT PICTURE (STATIONARY) UNIT.
3. UNIT ELEVATIONS ARE SHOWN WITHOUT EXTERIOR TRIM. UNIT SIZES & MASONRY OPENING DIMENSIONS WILL CHANGE WITH THE ADDITION OF EXTERIOR TRIM. SEE THE 'UNIT SIZING, ROUGH OPENINGS & MASONRY OPENINGS' PAGE FOR EXTERIOR TRIM EFFECTS.
4. OPERATING UNITS ARE AVAILABLE AS LEFT OR RIGHT HAND OPERATION.
5. DIMENSIONAL VALUES IN PARENTHESES ARE MILLIMETER CONVERSIONS.

**ELEVATION SYMBOL LEGEND:**

- M.O.** MASONRY OPENING
- E** BASIC UNIT CLEAR OPENING EXCEEDS 20" IN WIDTH, 24" IN HEIGHT & A MINIMUM OF 5.7 SQ. FT.
- +** TEMPERED GLASS, TINTED GLASS, OBSCURE GLASS ARE NOT AVAILABLE WHEN COMBINED WITH SDL OPTION.
- S** STATIONARY UNIT
- ##\*** NUMBER INDICATES DESIGN PRESSURE (DP) RATING WITH STANDARD GLAZING.
- ##\*\*** NUMBER INDICATES OPTIONAL DESIGN PRESSURE (DP) RATING.

#### 1-WIDE UNITS

M.O. BRICKMOULD	20 3/4" (527)	23 3/4" (603)	27 3/4" (705)	31 3/4" (806)	33 3/4" (857)	39 3/4" (1010)
M.O. ADAMS/FLAT CASING	23 3/4" (603)	26 3/4" (679)	30 3/4" (781)	34 3/4" (883)	36 3/4" (933)	42 3/4" (1086)
ROUGH OPENING	17 3/4" (451)	20 3/4" (527)	24 3/4" (629)	28 3/4" (730)	30 3/4" (781)	36 3/4" (933)
FRAME SIZE	17" (432)	20" (508)	24" (610)	28" (711)	30" (762)	36" (914)
DAYLIGHT OPENING	11" (279)	14" (356)	18" (457)	22" (559)	24" (610)	30" (762)
35 3/8" (899) 36 7/8" (937) 37 3/4" (932) 32" (813) 26 (660)						
TCC1732	TCC2032	TCC2432	TCC2832	TCC3032	TCC3632	
30 3/8" (1000) 40 7/8" (1038) 36 3/4" (933) 36" (914) 30" (762)						
TCC1736	TCC2036	TCC2436	TCC2836	TCC3036	TCC3636	E
43 3/8" (1102) 44 7/8" (1140) 40 3/4" (1035) 40" (1016) 34" (864)						
TCC1740	TCC2040	TCC2440	TCC2840	TCC3040	TCC3640	E
45 3/8" (1153) 46 7/8" (1191) 42 3/4" (1086) 42" (1067) 36" (914)						
TCC1742	TCC2042	TCC2442	TCC2842	TCC3042	TCC3642	E
51 3/8" (1305) 52 7/8" (1343) 48 3/4" (1238) 48" (1219) 42" (1067)						
TCC1748	TCC2048	TCC2448	TCC2848	TCC3048	TCC3648	E
57 3/8" (1457) 58 7/8" (1495) 54 3/4" (1391) 54" (1372) 48" (1219)						
TCC1754	TCC2054	TCC2454	TCC2854	TCC3054	TCC3654	E
59 3/8" (1508) 60 7/8" (1546) 56 3/4" (1441) 56" (1422) 50" (1270)						
TCC1756	TCC2056	TCC2456	TCC2856	TCC3056	TCC3656	E

#### ELEVATION SYMBOL LEGEND

M.O. = MASONRY OPENING  
 VALUES IN ( ) ARE IN MILLIMETER CONVERSIONS  
 ### NUMBER INDICATES DESIGN PRESSURE (DP) RATING WITH STANDARD GLAZING.  
 ###\* NUMBER INDICATES OPTIONAL DESIGN PRESSURE (DP) RATING.  
 E BASIC UNIT CLEAR OPENING EXCEEDS 20" IN WIDTH, 24" IN HEIGHT & A MINIMUM OF 5.7 SQ. FT.

Note Elevations shown DO NOT have exterior trim. Subtract 3/4" (19) from M.O. (Masonry Opening) for Unit Sizes. Masonry Openings above include Sill Nose, see Trim Options page for Sill Nose specifications. For other Trim Options refer to the Unit Sizing, Rough Opening & Masonry Openings page.

SCALE: 1/4" = 1'

### 1-WIDE UNITS

M.O. BRICKMOULD	20 3/4" (527)	23 3/4" (603)	27 3/4" (705)	31 3/4" (806)	33 3/4" (857)	39 3/4" (1010)
M.O. ADAMS/FLAT CASING	23 3/4" (603)	26 3/4" (679)	30 3/4" (781)	34 3/4" (883)	36 3/4" (933)	42 3/4" (1086)
ROUGH OPENING	17 3/4" (451)	20 3/4" (527)	24 3/4" (629)	28 3/4" (730)	30 3/4" (781)	36 3/4" (933)
FRAME SIZE	17" (432)	20" (508)	24" (610)	28" (711)	30" (762)	36" (914)
DAYLIGHT OPENING	11" (279)	14" (356)	18" (457)	22" (559)	24" (610)	30" (762)
63 3/8" (1609) 64 7/8" (1648) 60 3/4" (1543) 60" (1524) 54" (1372)						
TCC1760	TCC2060	TCC2460	TCC2860	TCC3060	TCC3660	
67 3/8" (1711) 68 7/8" (1749) 64 3/4" (1645) 64" (1626) 58" (1473)						
TCC1764	TCC2064	TCC2464	TCC2864	TCC3064	TCC3664	
69 3/8" (1762) 70 7/8" (1800) 66 3/4" (1695) 66" (1676) 60" (1524)						
TCC1766	TCC2066	TCC2466	TCC2866	TCC3066	TCC3666	
75 3/8" (1915) 76 7/8" (1953) 72 3/4" (1848) 72" (1829) 66" (1676)						
TCC1772	TCC2072	TCC2472	TCC2872	TCC3072	TCC3672	
87 3/8" (2219) 88 7/8" (2257) 84 3/4" (2153) 84" (2134) 78" (1981)						
TCC1784	TCC2084	TCC2484	TCC2884	TCC3084	TCC3684	

#### ELEVATION SYMBOL LEGEND

- M.O. = MASONRY OPENING
- VALUES IN () ARE IN MILLIMETER CONVERSIONS
- ##\* NUMBER INDICATES DESIGN PRESSURE (DP) RATING WITH STANDARD GLAZING.
- ###\* NUMBER INDICATES OPTIONAL DESIGN PRESSURE (DP) RATING.
- E BASIC UNIT CLEAR OPENING EXCEEDS 20" IN WIDTH, 24" IN HEIGHT & A MINIMUM OF 5.7 SQ. FT.
- S STATIONARY UNIT
- + TEMPERED GLASS, TINTED GLASS, OBSCURE GLASS ARE NOT AVAILABLE WHEN COMBINED WITH SDL OPTION.

Note Elevations shown DO NOT have exterior trim. Subtract 3/4" (19) from M.O. (Masonry Opening) for Unit Sizes. Masonry Openings above include Sill Nose, see Trim Options page for Sill Nose specifications. For other Trim Options refer to the Unit Sizing, Rough Opening & Masonry Openings page.

SCALE: 1/4" = 1'

### 2-WIDE UNITS

M.O. BRICKMOULD M.O. ADAMS/FLAT CASING ROUGH OPENING FRAME SIZE DAYLIGHT OPENING	37 3/4"(959) 40 3/4"(1035) 34 3/4"(883) 34"(864) 11"(279)[2]	43 3/4"(1111) 46 3/4"(1187) 40 3/4"(1035) 40"(1016) 14"(356)[2]	51 3/4"(1314) 54 3/4"(1391) 48 3/4"(1238) 48"(1219) 18"(457)[2]	59 3/4"(1518) 62 3/4"(1594) 56 3/4"(1441) 56"(1422) 22"(559)[2]	63 3/4"(1619) 66 3/4"(1695) 60 3/4"(1543) 60"(1524) 24"(610)[2]	75 3/4"(1924) 78 3/4"(2000) 72 3/4"(1848) 72"(1829) 30"(762)[2]
35 3/8"(899) 36 7/8"(937) 32 3/4"(832) 32"(813) 26"(660)						
TCC1732-2	TCC2032-2	TCC2432-2	TCC2832-2	TCC3032-2	TCC3632-2	
39 3/8"(1000) 40 7/8"(1038) 36 3/4"(933) 36"(914) 30"(762)						
TCC1736-2	TCC2036-2	TCC2436-2	TCC2836-2	TCC3036-2	TCC3636-2	
43 3/8"(1102) 44 7/8"(1140) 40 3/4"(1035) 40"(1016) 34"(864)						
TCC1740-2	TCC2040-2	TCC2440-2	TCC2840-2	TCC3040-2	TCC3640-2	
45 3/8"(1153) 46 7/8"(1191) 42 3/4"(1086) 42"(1067) 36"(914)						
TCC1742-2	TCC2042-2	TCC2442-2	TCC2842-2	TCC3042-2	TCC3642-2	
51 3/8"(1305) 52 7/8"(1343) 48 3/4"(1238) 48"(1219) 42"(1067)						
TCC1748-2	TCC2048-2	TCC2448-2	TCC2848-2	TCC3048-2	TCC3648-2	
57 3/8"(1457) 58 7/8"(1495) 54 3/4"(1391) 54"(1372) 48"(1219)						
TCC1754-2	TCC2054-2	TCC2454-2	TCC2854-2	TCC3054-2	TCC3654-2	
59 3/8"(1508) 60 7/8"(1546) 56 3/4"(1441) 56"(1422) 50"(1270)						
TCC1756-2	TCC2056-2	TCC2456-2	TCC2856-2	TCC3056-2	TCC3656-2	
63 3/8"(1609) 64 7/8"(1648) 60 3/4"(1543) 60"(1524) 54"(1372)						
TCC1760-2	TCC2060-2	TCC2460-2	TCC2860-2	TCC3060-2	TCC3660-2	
67 3/8"(1711) 68 7/8"(1749) 64 3/4"(1645) 64"(1626) 58"(1473)						
TCC1764-2	TCC2064-2	TCC2464-2	TCC2864-2	TCC3064-2	TCC3664-2	
69 3/8"(1762) 70 7/8"(1800) 66 3/4"(1695) 66"(1676) 60"(1524)						
TCC1766-2	TCC2066-2	TCC2466-2	TCC2866-2	TCC3066-2	TCC3666-2	

**ELEVATION SYMBOL LEGEND**

M.O. = MASONRY OPENING  
 VALUES IN ( ) ARE IN MILLIMETER CONVERSIONS  
 VALUES IN [ ] ARE NUMBER OF DAYLIGHT OPENINGS PER UNIT  
 E BASIC UNIT CLEAR OPENING EXCEEDS 20" IN WIDTH, 24" IN HEIGHT & A MINIMUM OF 5.7 SQ. FT.

Note Elevations shown DO NOT have exterior trim. Subtract 3/4" (19) from M.O. (Masonry Opening) for Unit Sizes. Masonry Openings above include Sill Nose, see Trim Options page for Sill Nose specifications. For other Trim Options refer to the Unit Sizing, Rough Opening & Masonry Openings page.

SCALE: 1/8" = 1'

### 2-WIDE UNITS

<b>M.O. BRICKMOULD</b>	37 3/4"(959)	43 3/4"(1111)	51 3/4"(1314)	59 3/4"(1518)	63 3/4"(1619)	75 3/4"(1924)
<b>M.O. ADAMS/FLAT CASING</b>	40 3/4"(1035)	46 3/4"(1187)	54 3/4"(1391)	62 3/4"(1594)	66 3/4"(1695)	78 3/4"(2000)
<b>ROUGH OPENING</b>	34 3/4"(883)	40 3/4"(1035)	48 3/4"(1238)	56 3/4"(1441)	60 3/4"(1543)	72 3/4"(1848)
<b>FRAME SIZE</b>	34"(864)	40"(1016)	48"(1219)	56"(1422)	60"(1524)	72"(1829)
<b>DAYLIGHT OPENING</b>	11"(279)[2]	14"(356)[2]	18"(457)[2]	22"(559)[2]	24"(610)[2]	30"(762)[2]

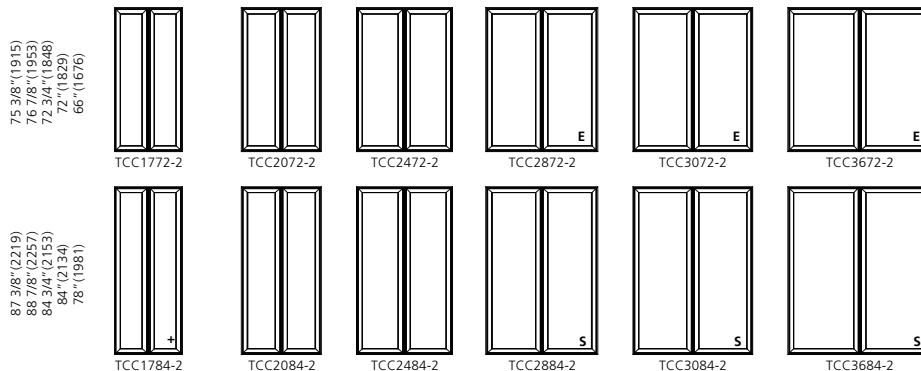

#### ELEVATION SYMBOL LEGEND

- M.O.** = MASONRY OPENING
- VALUES IN ( ) ARE IN MILLIMETER CONVERSIONS
- VALUES IN [ ] ARE NUMBER OF DAYLIGHT OPENINGS PER UNIT
- E** BASIC UNIT CLEAR OPENING EXCEEDS 20" IN WIDTH, 24" IN HEIGHT & A MINIMUM OF 5.7 SQ. FT.
- S** STATIONARY UNIT
- +** TEMPERED GLASS, TINTED GLASS, OBSCURE GLASS ARE NOT AVAILABLE WHEN COMBINED WITH SDL OPTION.

Note Elevations shown DO NOT have exterior trim. Subtract 3/4" (19) from M.O. (Masonry Opening) for Unit Sizes. Masonry Openings above include Sill Nose, see Trim Options page for Sill Nose specifications. For other Trim Options refer to the Unit Sizing, Rough Opening & Masonry Openings page.

SCALE: 1/8" = 1'



### 3-WIDE UNITS

**M.O. BRICKMOULD**  
**M.O. ADAMS/FLAT CASING**  
**ROUGH OPENING**  
**FRAME SIZE**  
**DAYLIGHT OPENING**

54 3/4"(1391)  
 57 3/4"(1467)  
 51 3/4"(1314)  
 51"(1295)  
 11"(279)[3]

63 3/4"(1619)  
 66 3/4"(1695)  
 60 3/4"(1543)  
 60"(1524)  
 146"(356)[3]

75 3/4"(1924)  
 78 3/4"(2000)  
 72 3/4"(1848)  
 72"(1829)  
 18"(457)[3]

87 3/4"(2229)  
 90 3/4"(2305)  
 84 3/4"(2153)  
 84"(2134)  
 22"(559)[3]

93 3/4"(2381)  
 96 3/4"(2457)  
 90 3/4"(2305)  
 90"(2286)  
 24"(610)[3]

111 3/4"(2838)  
 114 3/4"(2915)  
 108 3/4"(2762)  
 108"(2743)  
 30"(762)[3]

35 3/8"(899) 36 7/8"(937) 32 3/4"(832) 32"(813) 26"(660)						
	TCC1732-3	TCC2032-3	TCC2432-3	TCC2832-3	TCC3032-3	TCC3632-3
39 3/8"(1000) 40 7/8"(1038) 36 3/4"(933) 36"(914) 30"(762)						
	TCC1736-3	TCC2036-3	TCC2436-3	TCC2836-3	TCC3036-3	TCC3636-3
43 3/8"(1102) 44 7/8"(1140) 40 3/4"(1035) 40"(1016) 34"(864)						
	TCC1740-3	TCC2040-3	TCC2440-3	TCC2840-3	TCC3040-3	TCC3640-3
45 3/8"(1153) 46 7/8"(1191) 42 3/4"(1086) 42"(1067) 36"(914)						
	TCC1742-3	TCC2042-3	TCC2442-3	TCC2842-3	TCC3042-3	TCC3642-3
51 3/8"(1305) 52 7/8"(1343) 48 3/4"(1238) 48"(1219) 42"(1067)						
	TCC1748-3	TCC2048-3	TCC2448-3	TCC2848-3	TCC3048-3	TCC3648-3
57 3/8"(1457) 58 7/8"(1495) 54 3/4"(1391) 54"(1372) 48"(1219)						
	TCC1754-3	TCC2054-3	TCC2454-3	TCC2854-3	TCC3054-3	TCC3654-3
59 3/8"(1508) 60 7/8"(1546) 56 3/4"(1441) 56"(1422) 50"(1270)						
	TCC1756-3	TCC2056-3	TCC2456-3	TCC2856-3	TCC3056-3	TCC3656-3
63 3/8"(1609) 64 7/8"(1648) 60 3/4"(1543) 60"(1524) 54"(1372)						
	TCC1760-3	TCC2060-3	TCC2460-3	TCC2860-3	TCC3060-3	TCC3660-3
67 3/8"(1711) 68 7/8"(1749) 64 3/4"(1645) 64"(1626) 58"(1473)						
	TCC1764-3	TCC2064-3	TCC2464-3	TCC2864-3	TCC3064-3	TCC3664-3
69 3/8"(1762) 70 7/8"(1800) 66 3/4"(1695) 66"(1676) 60"(1524)						
	TCC1766-3	TCC2066-3	TCC2466-3	TCC2866-3	TCC3066-3	TCC3666-3

**ELEVATION SYMBOL LEGEND**

**M.O.** = MASONRY OPENING  
 VALUES IN ( ) ARE IN MILLIMETER CONVERSIONS  
 VALUES IN [ ] ARE NUMBER OF DAYLIGHT OPENINGS PER UNIT  
**E** BASIC UNIT CLEAR OPENING EXCEEDS 20" IN WIDTH, 24" IN HEIGHT & A MINIMUM OF 5.7 SQ. FT.

Note Elevations shown DO NOT have exterior trim. Subtract 3/4" (19) from M.O. (Masonry Opening) for Unit Sizes. Masonry Openings above include Sill Nose, see Trim Options page for Sill Nose specifications. For other Trim Options refer to the Unit Sizing, Rough Opening & Masonry Openings page.

SCALE: 1/8" = 1'

### 3-WIDE UNITS

<b>M.O. BRICKMOULD</b>	54 3/4"(1391)	63 3/4"(1619)	75 3/4"(1924)	87 3/4"(2229)	93 3/4"(2381)	111 3/4"(2838)
<b>M.O. ADAMS/FLAT CASING</b>	57 3/4"(1467)	66 3/4"(1695)	78 3/4"(2000)	90 3/4"(2305)	96 3/4"(2457)	114 3/4"(2915)
<b>ROUGH OPENING</b>	51 3/4"(1314)	60 3/4"(1543)	72 3/4"(1848)	84 3/4"(2153)	90 3/4"(2305)	108 3/4"(2762)
<b>FRAME SIZE</b>	51"(1295)	60"(1524)	72"(1829)	84"(2134)	90"(2286)	108"(2743)
<b>DAYLIGHT OPENING</b>	11"(279)[3]	146"(356)[3]	18"(457)[3]	22"(559)[3]	24"(610)[3]	30"(762)[3]

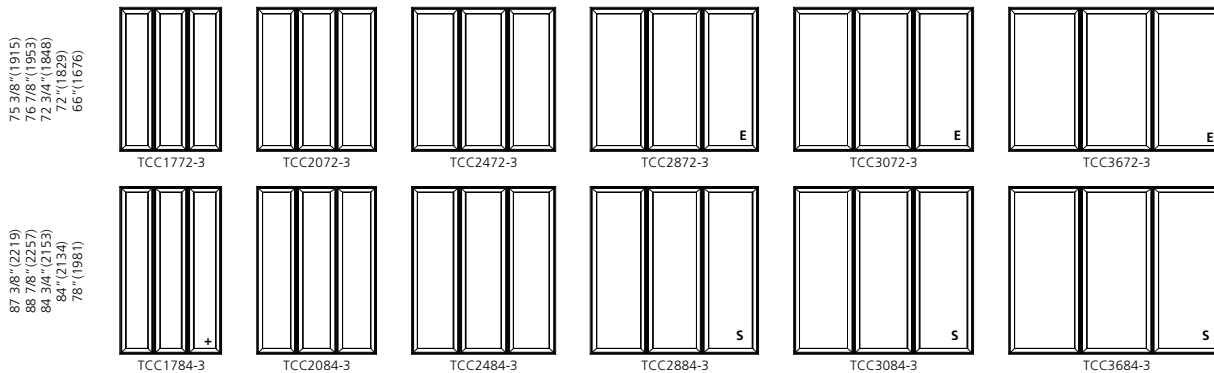

**ELEVATION SYMBOL LEGEND**  
**M.O.** = MASONRY OPENING  
 VALUES IN ( ) ARE IN MILLIMETER CONVERSIONS  
 VALUES IN [ ] ARE NUMBER OF DAYLIGHT OPENINGS PER UNIT  
**E** BASIC UNIT CLEAR OPENING EXCEEDS 20" IN WIDTH, 24" IN HEIGHT & A MINIMUM OF 5.7 SQ. FT.  
**S** STATIONARY UNIT  
 + TEMPERED GLASS, TINTED GLASS, OBSCURE GLASS ARE NOT AVAILABLE WHEN COMBINED WITH SDL OPTION.

Note Elevations shown DO NOT have exterior trim. Subtract 3/4" (19) from M.O. (Masonry Opening) for Unit Sizes. Masonry Openings above include Sill Nose, see Trim Options page for Sill Nose specifications. For other Trim Options refer to the Unit Sizing, Rough Opening & Masonry Openings page.

SCALE: 1/8" = 1'

#### 4-WIDE UNITS

M.O. BRICKMOULD M.O. ADAMS/FLAT CASING ROUGH OPENING FRAME SIZE DAYLIGHT OPENING	71 3/4" (1822) 74 3/4" (1899) 68 3/4" (1746) 68" (1727) 11" (279)[4]	83 3/4" (2127) 86 3/4" (2203) 80 3/4" (2051) 80" (2032) 14" (356)[4]	99 3/4" (2534) 102 3/4" (2610) 96 3/4" (2457) 96" (2438) 18" (457)[4]	115 3/4" (2940) 118 3/4" (3016) 112 3/4" (2864) 112" (2849) 22" (559)[4]	123 3/4" (3143) 126 3/4" (3219) 120 3/4" (3067) 120" (3048) 24" (610)[4]
35 3/8" (899) 36 7/8" (937) 32 3/4" (832) 32" (813) 26" (660)					
39 3/8" (1000) 40 7/8" (1038) 36 3/4" (933) 36" (914) 30" (762)					
43 3/8" (1102) 44 7/8" (1140) 40 3/4" (1035) 40" (1016) 34" (864)					
45 3/8" (1153) 46 7/8" (1191) 42 3/4" (1086) 42" (1067) 36" (914)					
51 3/8" (1305) 52 7/8" (1343) 48 3/4" (1238) 48" (1219) 42" (1067)					
57 3/8" (1457) 58 7/8" (1495) 54 3/4" (1391) 54" (1372) 48" (1219)					
59 3/8" (1508) 60 7/8" (1546) 56 3/4" (1441) 56" (1422) 50" (1270)					
63 3/8" (1609) 64 7/8" (1648) 60 3/4" (1543) 60" (1524) 54" (1372)					
67 3/8" (1711) 68 7/8" (1749) 64 3/4" (1645) 64" (1626) 58" (1473)					
69 3/8" (1762) 70 7/8" (1800) 66 3/4" (1695) 66" (1676) 60" (1524)					

**ELEVATION SYMBOL LEGEND**

M.O. = MASONRY OPENING  
 VALUES IN ( ) ARE IN MILLIMETER CONVERSIONS  
 VALUES IN [ ] ARE NUMBER OF DAYLIGHT OPENINGS PER UNIT  
 E BASIC UNIT CLEAR OPENING EXCEEDS 20" IN WIDTH, 24" IN HEIGHT & A MINIMUM OF 5.7 SQ. FT.

Note Elevations shown DO NOT have exterior trim. Subtract 3/4" (19) from M.O. (Masonry Opening) for Unit Sizes. Masonry Openings above include Sill Nose, see Trim Options page for Sill Nose specifications. For other Trim Options refer to the Unit Sizing, Rough Opening & Masonry Openings page.

SCALE: 1/8" = 1'

**4-WIDE UNITS**

	71 3/4" (1822)	83 3/4" (2127)	99 3/4" (2534)	115 3/4" (2940)	123 3/4" (3143)
<b>M.O. BRICKMOULD</b>	71 3/4" (1822)	83 3/4" (2127)	99 3/4" (2534)	115 3/4" (2940)	123 3/4" (3143)
<b>M.O. ADAMS/FLAT CASING</b>	74 3/4" (1899)	86 3/4" (2203)	102 3/4" (2610)	118 3/4" (3016)	126 3/4" (3219)
<b>ROUGH OPENING</b>	68 3/4" (1746)	80 3/4" (2051)	96 3/4" (2457)	112 3/4" (2864)	120 3/4" (3067)
<b>FRAME SIZE</b>	68" (1727)	80" (2032)	96" (2438)	112" (2849)	120" (3048)
<b>DAYLIGHT OPENING</b>	11" (279)[4]	14" (356)[4]	18" (457)[4]	22" (559)[4]	24" (610)[4]
75 3/8" (1915) 76 7/8" (1953) 72 3/4" (1848) 72" (1829) 66" (1676)	TCC1772-4	TCC2072-4	TCC2472-4	TCC2872-4	TCC3072-4
87 3/8" (2219) 88 7/8" (2257) 84 3/4" (2134) 84" (2134) 78" (1981)	TCC1784-4	TCC2084-4	TCC2484-4	TCC2884-4	TCC3084-4

**ELEVATION SYMBOL LEGEND**

- M.O.** = MASONRY OPENING
- VALUES IN ( ) ARE IN MILLIMETER CONVERSIONS
- VALUES IN [ ] ARE NUMBER OF DAYLIGHT OPENINGS PER UNIT
- E** BASIC UNIT CLEAR OPENING EXCEEDS 20" IN WIDTH, 24" IN HEIGHT & A MINIMUM OF 5.7 SQ. FT.
- S** STATIONARY UNIT
- +** TEMPERED GLASS, TINTED GLASS, OBSCURE GLASS ARE NOT AVAILABLE WHEN COMBINED WITH SDL OPTION.

Note Elevations shown DO NOT have exterior trim. Subtract 3/4" (19) from M.O. (Masonry Opening) for Unit Sizes. Masonry Openings above include Sill Nose, see Trim Options page for Sill Nose specifications. For other Trim Options refer to the Unit Sizing, Rough Opening & Masonry Openings page.

SCALE: 1/8" = 1'

**4-WIDE UNITS**

<b>M.O. BRICKMOULD</b>	147 3/4" (3753)	
<b>M.O. ADAMS/FLAT CASING</b>	150 3/4" (3829)	
<b>ROUGH OPENING</b>	144 3/4" (3677)	
<b>FRAME SIZE</b>	144" (3658)	
<b>DAYLIGHT OPENING</b>	30" (762) [4]	

35 3/8" (899)	
36 7/8" (937)	TCC3632-4
32 3/4" (832)	
32 1/2" (828)	
32" (813)	
26" (660)	
39 3/8" (1000)	
40 7/8" (1038)	TCC3636-4
36 1/4" (925)	
36" (914)	
30" (762)	
43 3/8" (1102)	
44 7/8" (1140)	TCC3640-4
40 3/4" (1035)	
40" (1016)	
34" (864)	
45 3/8" (1153)	
46 7/8" (1191)	TCC3642-4
42 3/4" (1086)	
42" (1067)	
36" (914)	
51 3/8" (1305)	
52 7/8" (1343)	TCC3648-4
48 3/4" (1238)	
48" (1219)	
42" (1067)	
57 3/8" (1457)	
58 7/8" (1495)	TCC3654-4
54 3/4" (1391)	
54" (1372)	
48" (1219)	
59 3/8" (1508)	
60 7/8" (1546)	TCC3656-4
56 3/4" (1441)	
56" (1422)	
50" (1270)	
63 3/8" (1609)	
64 7/8" (1648)	TCC3660-4
60 3/4" (1543)	
60" (1524)	
54" (1372)	
67 3/8" (1711)	
68 7/8" (1749)	TCC3664-4
64 3/4" (1645)	
64" (1626)	
58" (1473)	
69 3/8" (1762)	
70 7/8" (1800)	TCC3666-4
66 3/4" (1695)	
66" (1676)	
60" (1524)	

<b>M.O. BRICKMOULD</b>	147 3/4" (3753)
<b>M.O. ADAMS/FLAT CASING</b>	150 3/4" (3829)
<b>ROUGH OPENING</b>	144 3/4" (3677)
<b>FRAME SIZE</b>	144" (3658)
<b>DAYLIGHT OPENING</b>	30" (762) [4]

75 3/8" (1915)	
76 7/8" (1953)	TCC3672-4
72 3/4" (1848)	
72" (1829)	
66" (1676)	
87 3/8" (2219)	
88 7/8" (2257)	TCC3684-4
84 3/4" (2153)	
84" (2134)	
78" (1981)	

**ELEVATION SYMBOL LEGEND**

**M.O.** = MASONRY OPENING  
 VALUES IN ( ) ARE IN MILLIMETER CONVERSIONS  
 VALUES IN [ ] ARE NUMBER OF DAYLIGHT OPENINGS PER UNIT  
**E** BASIC UNIT CLEAR OPENING EXCEEDS 20" IN WIDTH, 24" IN HEIGHT & A MINIMUM OF 5.7 SQ. FT.  
**S** STATIONARY UNIT

Note Elevations shown DO NOT have exterior trim. Subtract 3/4" (19) from M.O. (Masonry Opening) for Unit Sizes. Masonry Openings above include Sill Nose, see Trim Options page for Sill Nose specifications. For other Trim Options refer to the Unit Sizing, Rough Opening & Masonry Openings page.

SCALE: 1/8" = 1'

### PICTURE UNITS

M.O. BRICKMOULD	20 3/4" (527)	23 3/4" (603)	27 3/4" (705)	31 3/4" (806)	33 3/4" (857)	35 3/4" (908)	39 3/4" (1010)
M.O. ADAMS/FLAT CASING	23 3/4" (603)	26 3/4" (679)	30 3/4" (781)	34 3/4" (883)	36 3/4" (933)	38 3/4" (984)	42 3/4" (1086)
ROUGH OPENING	17 3/4" (451)	20 3/4" (527)	24 3/4" (629)	28 3/4" (730)	30 3/4" (781)	32 3/4" (832)	36 3/4" (933)
FRAME SIZE	17" (432)	20" (508)	24" (610)	28" (711)	30" (762)	32" (813)	36" (914)
DAYLIGHT OPENING	11" (279)	14" (356)	18" (457)	22" (559)	24" (610)	26" (660)	30" (762)
43 3/8" (1102) 44 7/8" (1140) 40 3/4" (1035) 40" (1016) 34" (864)							
	TCCP1740	TCCP2040	TCCP2440	TCCP2840	TCCP3040	TCCP3240	TCCP3640
45 3/8" (1153) 46 7/8" (1191) 42 3/4" (1086) 42" (1067) 36" (914)							
	TCCP1742	TCCP2042	TCCP2442	TCCP2842	TCCP3042	TCCP3242	TCCP3642
51 3/8" (1305) 52 7/8" (1343) 48 3/4" (1238) 48" (1219) 42" (1067)							
	TCCP1748	TCCP2048	TCCP2448	TCCP2848	TCCP3048	TCCP3248	TCCP3648
57 3/8" (1457) 58 7/8" (1495) 54 3/4" (1391) 54" (1372) 48" (1219)							
	TCCP1754	TCCP2054	TCCP2454	TCCP2854	TCCP3054	TCCP3254	TCCP3654
59 3/8" (1508) 60 7/8" (1546) 56 3/4" (1441) 56" (1422) 50" (1270)							
	TCCP1756	TCCP2056	TCCP2456	TCCP2856	TCCP3056	TCCP3256	TCCP3656
63 3/8" (1609) 64 7/8" (1648) 60 3/4" (1543) 60" (1524) 54" (1372)							
	TCCP1760	TCCP2060	TCCP2460	TCCP2860	TCCP3060	TCCP3260	TCCP3660

**ELEVATION SYMBOL LEGEND:**

M.O. = MASONRY OPENING  
 VALUES IN ( ) ARE IN MILLIMETER CONVERSIONS  
 ### NUMBER INDICATES DESIGN PRESSURE (DP) RATING WITH STANDARD GLAZING.  
 #### NUMBER INDICATES OPTIONAL DESIGN PRESSURE (DP) RATING.

Note Elevations shown DO NOT have exterior trim. Subtract 3/4" (19) from M.O. (Masonry Opening) for Unit Sizes. Masonry Openings above include Sill Nose, see Trim Options page for Sill Nose specifications. For other Trim Options refer to the Unit Sizing, Rough Opening & Masonry Openings page.

SCALE: 1/4" = 1'

#### PICTURE UNITS

M.O. BRICKMOLD  
M.O. ADAMS/FLAT CASING  
ROUGH OPENING  
FRAME SIZE  
DAYLIGHT OPENING

20 3/4"(527)  
23 3/4"(603)  
17 3/4"(451)  
17"(432)  
11"(279)

23 3/4"(603)  
26 3/4"(679)  
20 3/4"(527)  
20"(508)  
14"(356)

27 3/4"(705)  
30 3/4"(781)  
24 3/4"(629)  
24"(610)  
18"(457)

31 3/4"(806)  
34 3/4"(883)  
28 3/4"(730)  
28"(711)  
22"(559)

33 3/4"(857)  
36 3/4"(933)  
30 3/4"(781)  
30"(762)  
24"(610)

35 3/4"(908)  
38 3/4"(984)  
32 3/4"(832)  
32"(813)  
26"(660)

39 3/4"(1010)  
42 3/4"(1086)  
36 3/4"(933)  
36"(914)  
30"(762)

67 3/8"(1711)  
68 7/8"(1749)  
64 3/4"(1645)  
64"(1626)  
58"(1473)

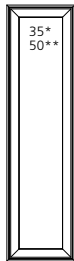

TCCP1764

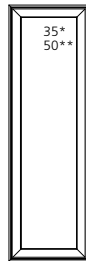

TCCP2064

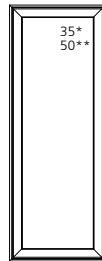

TCCP2464

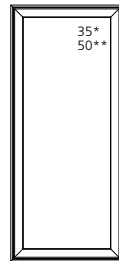

TCCP2864

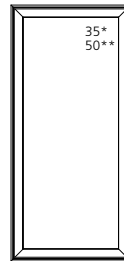

TCCP3064

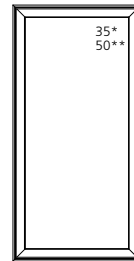

TCCP3264

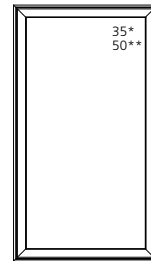

TCCP3664

69 3/8"(1763)  
70 7/8"(1800)  
66 3/4"(1695)  
66"(1676)  
60"(1524)

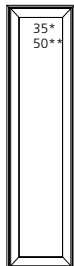

TCCP1766

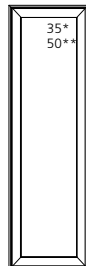

TCCP2066

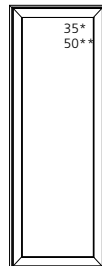

TCCP2466

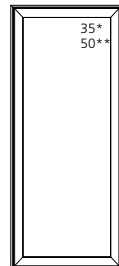

TCCP2866

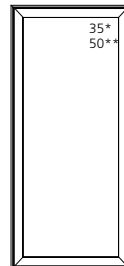

TCCP3066

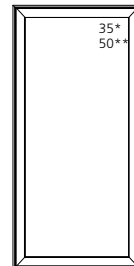

TCCP3266

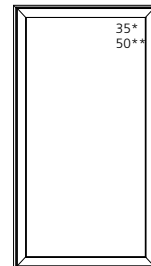

TCCP3666

75 3/8"(1915)  
76 7/8"(1953)  
72 3/4"(1848)  
72"(1829)  
66"(1676)

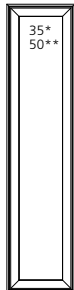

TCCP1772

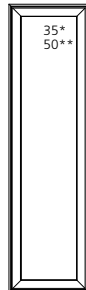

TCCP2072

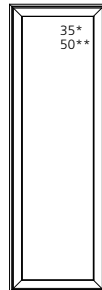

TCCP2472

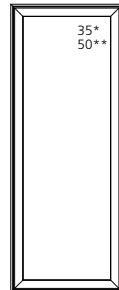

TCCP2872

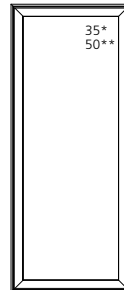

TCCP3072

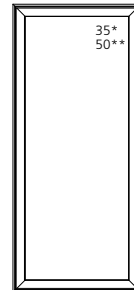

TCCP3272

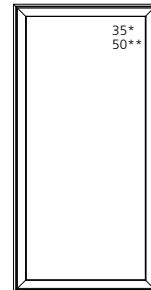

TCCP3672

87 3/8"(2219)  
88 7/8"(2257)  
84 3/4"(2153)  
84"(2134)  
78"(1981)

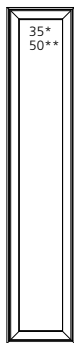

TCCP1784

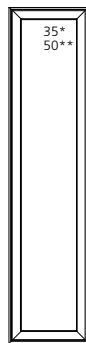

TCCP2084

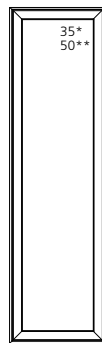

TCCP2484

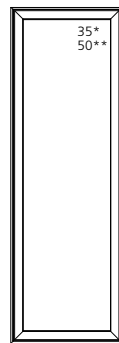

TCCP2884

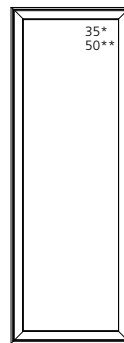

TCCP3084

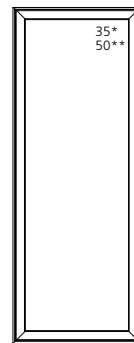

TCCP3284

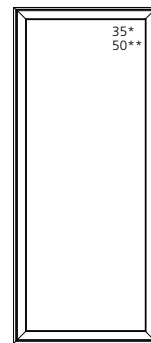

TCCP3684

**ELEVATION SYMBOL LEGEND:**

M.O. = MASONRY OPENING

VALUES IN ( ) ARE IN MILLIMETER CONVERSIONS

##\* NUMBER INDICATES DESIGN PRESSURE (DP) RATING WITH STANDARD GLAZING.

##\*\* NUMBER INDICATES OPTIONAL DESIGN PRESSURE (DP) RATING.

Note Elevations shown DO NOT have exterior trim. Subtract 3/4" (19) from M.O. (Masonry Opening) for Unit Sizes. Masonry Openings above include Sill Nose, see Trim Options page for Sill Nose specifications. For other Trim Options refer to the Unit Sizing, Rough Opening & Masonry Openings page.

SCALE: 1/4" = 1'

**PICTURE UNITS**

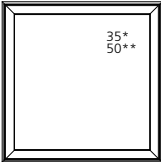
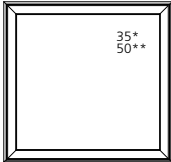
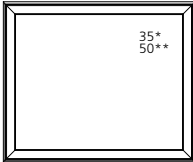
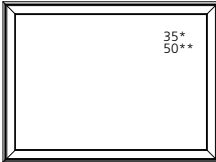
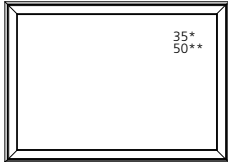
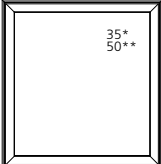
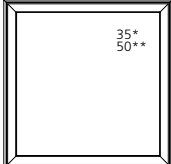
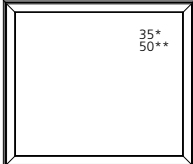
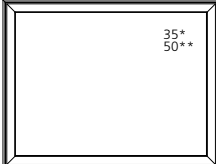
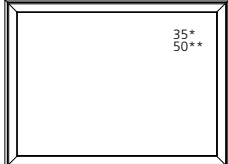
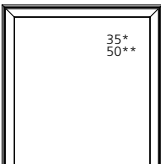
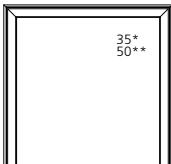
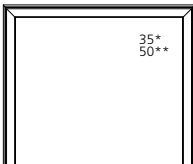
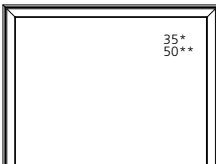
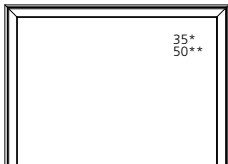
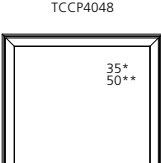
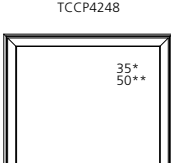
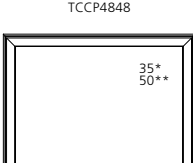
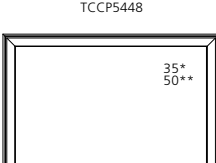
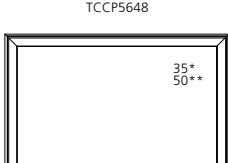
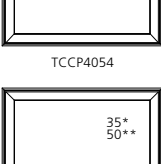
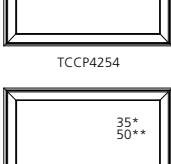
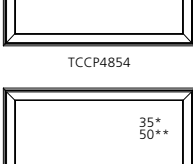
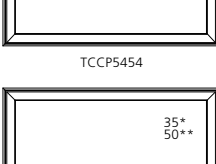
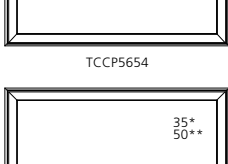
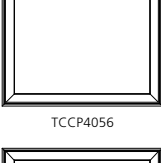
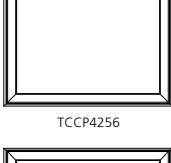
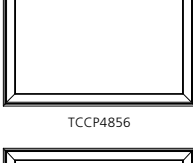
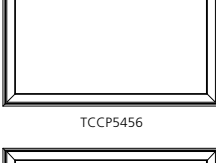
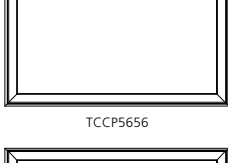
M.O. BRICKMOULD M.O. ADAMS/FLAT CASING ROUGH OPENING FRAME SIZE DAYLIGHT OPENING	43 3/4" (1111) 46 3/4" (1187) 40 3/4" (1035) 40" (1016) 34" (864)	45 3/4" (1162) 48 3/4" (1238) 42 3/4" (1086) 42" (1067) 36" (914)	51 3/4" (1314) 54 3/4" (1391) 48 3/4" (1238) 48" (1219) 42" (1067)	57 3/4" (1467) 60 3/4" (1543) 54 3/4" (1391) 54" (1372) 48" (1219)	59 3/4" (1518) 62 3/4" (1594) 56 3/4" (1441) 56" (1422) 50" (1270)
43 3/8" (1102) 44 7/8" (1140) 40 3/4" (1035) 40" (1016) 34" (864)	 35* 50**	 35* 50**	 35* 50**	 35* 50**	 35* 50**
TCCP4040	TCCP4240	TCCP4840	TCCP5440	TCCP5640	
45 3/8" (1153) 46 7/8" (1191) 42 3/4" (1086) 42" (1067) 36" (914)	 35* 50**	 35* 50**	 35* 50**	 35* 50**	 35* 50**
TCCP4042	TCCP4242	TCCP4842	TCCP5442	TCCP5642	
51 3/8" (1305) 52 7/8" (1343) 48 3/4" (1238) 48" (1219) 42" (1067)	 35* 50**	 35* 50**	 35* 50**	 35* 50**	 35* 50**
TCCP4048	TCCP4248	TCCP4848	TCCP5448	TCCP5648	
57 3/8" (1457) 58 7/8" (1495) 54 3/4" (1391) 54" (1372) 48" (1219)	 35* 50**	 35* 50**	 35* 50**	 35* 50**	 35* 50**
TCCP4054	TCCP4254	TCCP4854	TCCP5454	TCCP5654	
59 3/8" (1508) 60 7/8" (1546) 56 3/4" (1441) 56" (1422) 50" (1270)	 35* 50**	 35* 50**	 35* 50**	 35* 50**	 35* 50**
TCCP4056	TCCP4256	TCCP4856	TCCP5456	TCCP5656	
63 3/8" (1609) 64 7/8" (1647) 60 3/4" (1543) 60" (1524) 54" (1372)	 35* 50**	 35* 50**	 35* 50**	 35* 50**	 35* 50**
TCCP4060	TCCP4260	TCCP4860	TCCP5460	TCCP5660	

**ELEVATION SYMBOL LEGEND:**

M.O. = MASONRY OPENING  
VALUES IN ( ) ARE IN MILLIMETER CONVERSIONS  
## = NUMBER INDICATES DESIGN PRESSURE (DP) RATING WITH STANDARD GLAZING.  
### = NUMBER INDICATES OPTIONAL DESIGN PRESSURE (DP) RATING.

Note Elevations shown DO NOT have exterior trim. Subtract 3/4" (19) from M.O. (Masonry Opening) for Unit Sizes. Masonry Openings above include Sill Nose, see Trim Options page for Sill Nose specifications. For other Trim Options refer to the Unit Sizing, Rough Opening & Masonry Openings page.

SCALE: 1/4" = 1'



### PICTURE UNITS

M.O. BRICKMOUND  
M.O. ADAMS/FLAT CASING  
ROUGH OPENING  
FRAME SIZE  
DAYLIGHT OPENING

43 3/4"(1111)  
46 3/4"(1187)  
40 3/4"(1035)  
40"(1016)  
34"(864)

45 3/4"(1162)  
48 3/4"(1238)  
42 3/4"(1086)  
42"(1067)  
36"(914)

51 3/4"(1314)  
54 3/4"(1391)  
48 3/4"(1238)  
48"(1219)  
42"(1067)

57 3/4"(1467)  
60 3/4"(1543)  
54 3/4"(1391)  
54"(1372)  
48"(1219)

59 3/4"(1518)  
62 3/4"(1594)  
56 3/4"(1441)  
56"(1422)  
50"(1270)

67 3/8"(1711)  
68 7/8"(1749)  
64 3/4"(1645)  
64"(1626)  
58"(1473)

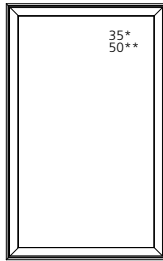

TCCP4064

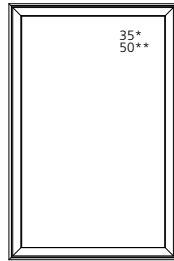

TCCP4264

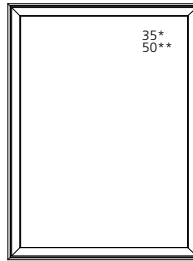

TCCP4864

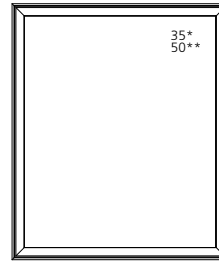

TCCP5464

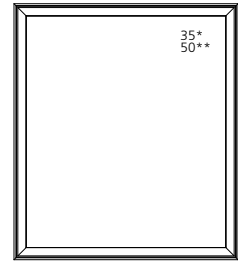

TCCP5664

60 3/8"(1562)  
70 3/8"(1802)  
66 3/4"(1695)  
66"(1676)  
60"(1524)

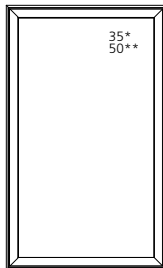

TCCP4066

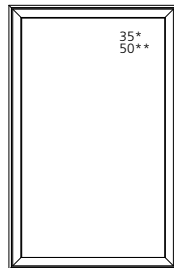

TCCP4266

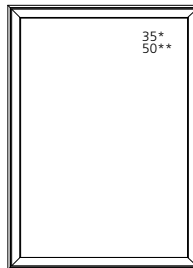

TCCP4866

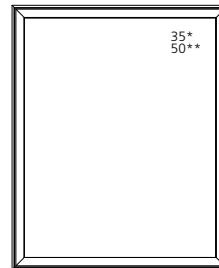

TCCP5466

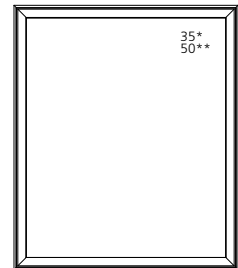

TCCP5666

75 3/8"(1915)  
76 3/8"(1953)  
72 3/4"(1848)  
72"(1829)  
66"(1676)

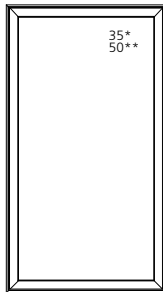

TCCP4072

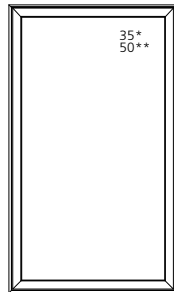

TCCP4272

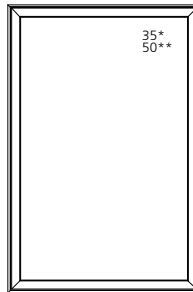

TCCP4872

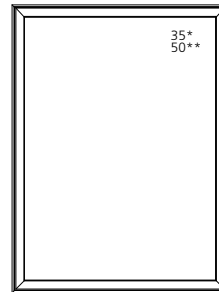

TCCP5472

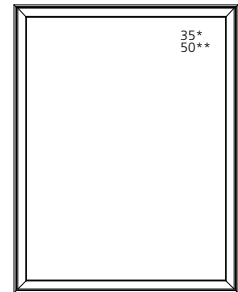

TCCP5672

87 3/8"(2219)  
88 3/8"(2257)  
84 3/4"(2153)  
84"(2134)  
78"(1981)

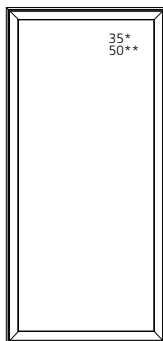

TCCP4084

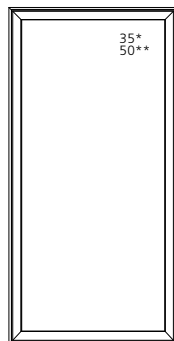

TCCP4284

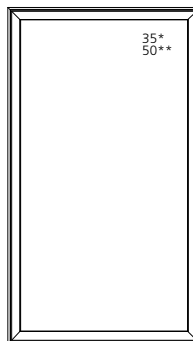

TCCP4884

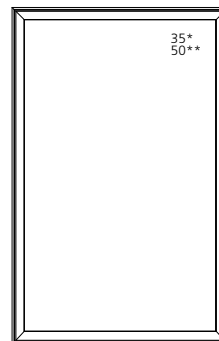

TCCP5484

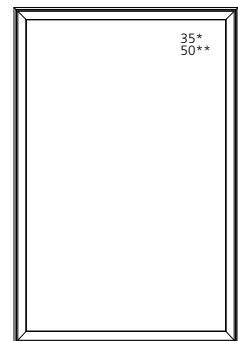

TCCP5684

**ELEVATION SYMBOL LEGEND:**

M.O. = MASONRY OPENING  
VALUES IN ( ) ARE IN MILLIMETER CONVERSIONS  
\*\*\* NUMBER INDICATES DESIGN PRESSURE (DP) RATING WITH STANDARD GLAZING.  
\*\*\*\* NUMBER INDICATES OPTIONAL DESIGN PRESSURE (DP) RATING.

Note Elevations shown DO NOT have exterior trim. Subtract 3/4" (19) from M.O. (Masonry Opening) for Unit Sizes. Masonry Openings above include Sill Nose, see Trim Options page for Sill Nose specifications. For other Trim Options refer to the Unit Sizing, Rough Opening & Masonry Openings page.

SCALE: 1/4" = 1'

**PICTURE UNITS**

**M.O. BRICKMOULD**  
**M.O. ADAMS/FLAT CASING**  
**ROUGH OPENING**  
**FRAME SIZE**  
**DAYLIGHT OPENING**

63 3/4" (1619)  
66 3/4" (1695)  
60 3/4" (1543)  
60" (1524)  
54" (1372)

67 3/4" (1721)  
70 3/4" (1797)  
64 3/4" (1645)  
64" (1626)  
58" (1473)

69 3/4" (1772)  
72 3/4" (1848)  
66 3/4" (1645)  
66" (1626)  
60" (1524)

75 3/4" (1924)  
78 3/4" (2000)  
72 3/4" (1848)  
72" (1829)  
66" (1676)

43 3/8" (1102)  
44 7/8" (1140)  
40 3/4" (1035)  
40" (1016)  
34" (864)

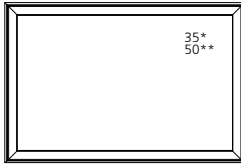

TCCP6040

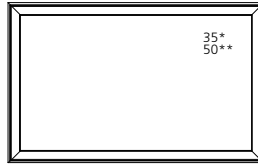

TCCP6440

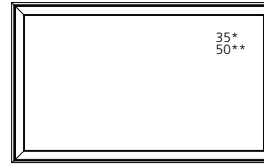

TCCP6640

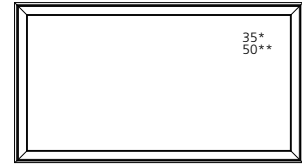

TCCP7240

45 3/8" (1153)  
46 7/8" (1191)  
42 3/4" (1086)  
42" (1067)  
36" (914)

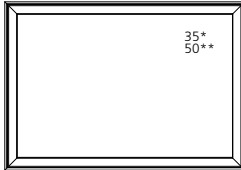

TCCP6042

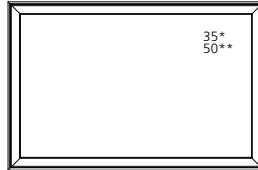

TCCP6442

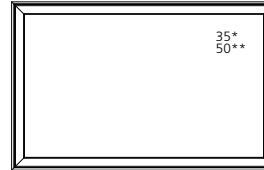

TCCP6642



TCCP7242

51 3/8" (1305)  
52 7/8" (1343)  
48 3/4" (1238)  
48" (1219)  
42" (1067)

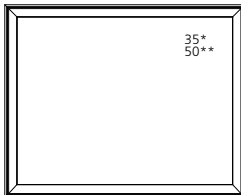

TCCP6048

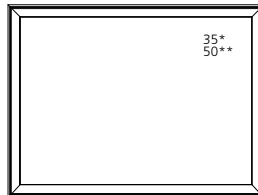

TCCP6448

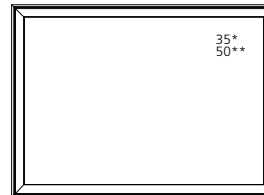

TCCP6648

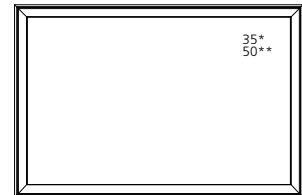

TCCP7248

57 3/8" (1457)  
58 7/8" (1495)  
54 3/4" (1391)  
54" (1372)  
48" (1219)

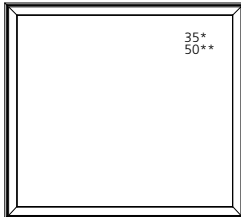

TCCP6054

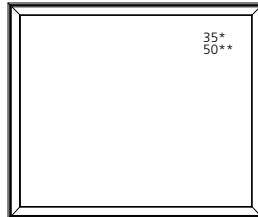

TCCP6454

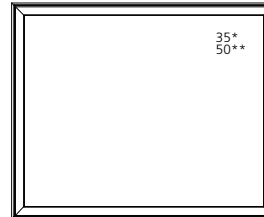

TCCP6654

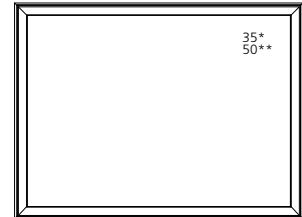

TCCP7254

59 3/8" (1508)  
60 7/8" (1546)  
56 3/4" (1441)  
56" (1422)  
50" (1270)

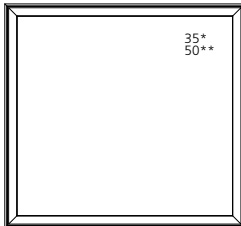

TCCP6056

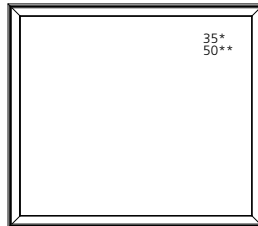

TCCP6456

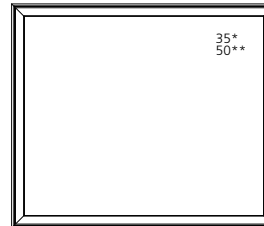

TCCP6656

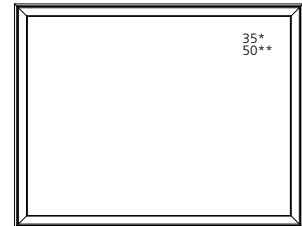

TCCP7256

63 3/8" (1609)  
64 7/8" (1648)  
60 3/4" (1543)  
60" (1524)  
54" (1372)

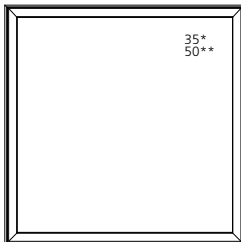

TCCP6060

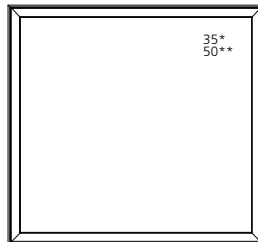

TCCP6460

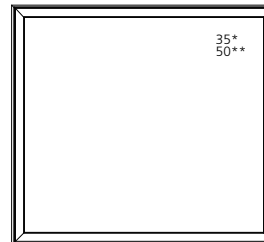

TCCP6660

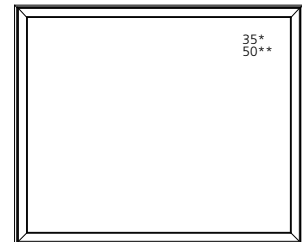

TCCP7260

**ELEVATION SYMBOL LEGEND:**

**M.O.** = MASONRY OPENING  
VALUES IN ( ) ARE IN MILLIMETER CONVERSIONS  
**##** = NUMBER INDICATES DESIGN PRESSURE (DP) RATING WITH STANDARD GLAZING.  
**###** = NUMBER INDICATES OPTIONAL DESIGN PRESSURE (DP) RATING.

Note Elevations shown DO NOT have exterior trim. Subtract 3/4" (19) from M.O. (Masonry Opening) for Unit Sizes. Masonry Openings above include Sill Nose, see Trim Options page for Sill Nose specifications. For other Trim Options refer to the Unit Sizing, Rough Opening & Masonry Openings page.

SCALE: 1/4" = 1'

**PICTURE UNITS**

M.O. BRICKMOULD  
M.O. ADAMS/FLAT CASING  
ROUGH OPENING  
FRAME SIZE  
DAYLIGHT OPENING

63 3/4" (1619)  
66 3/4" (1695)  
60 3/4" (1543)  
60" (1524)  
54" (1372)

67 3/4" (1721)  
70 3/4" (1797)  
64 3/4" (1645)  
64" (1626)  
58" (1473)

69 3/4" (1772)  
72 3/4" (1848)  
66 3/4" (1645)  
66" (1676)  
60" (1524)

75 3/4" (1924)  
78 3/4" (2000)  
72 3/4" (1848)  
72" (1829)  
66" (1676)

67 3/8" (1711)  
68 7/8" (1749)  
64 3/4" (1645)  
64" (1626)  
58" (1473)

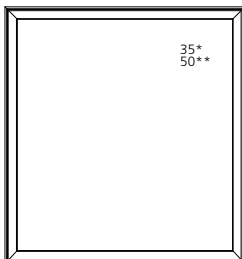

TCCP6064

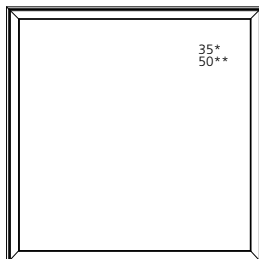

TCCP6464

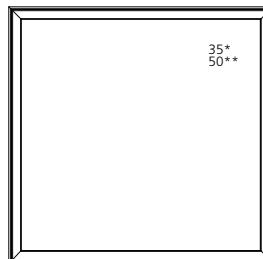

TCCP6664

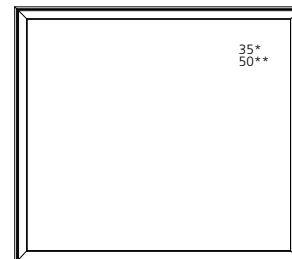

TCCP7264

69 3/8" (1762)  
70 7/8" (1800)  
66 3/4" (1695)  
66" (1676)  
60" (1524)

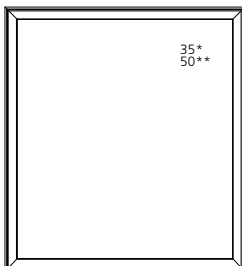

TCCP6066

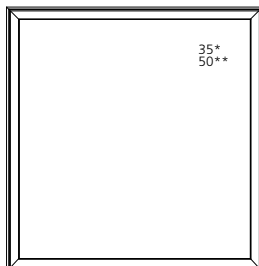

TCCP6466

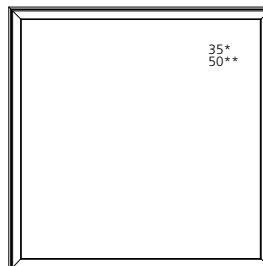

TCCP6666

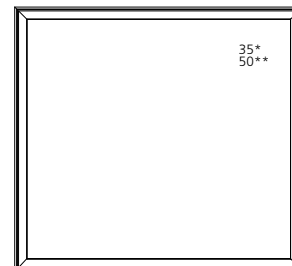

TCCP7266

75 3/8" (1915)  
76 7/8" (1953)  
72 3/4" (1848)  
72" (1829)  
66" (1676)

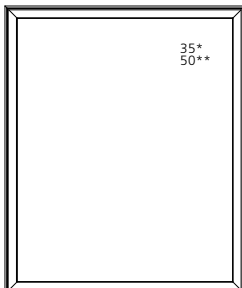

TCCP6072

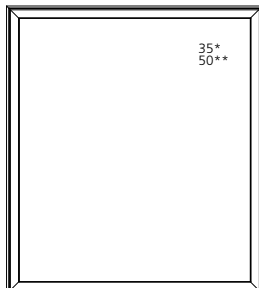

TCCP6472

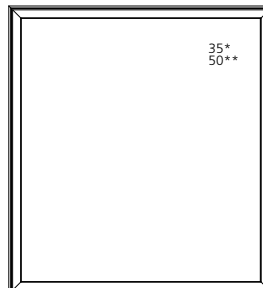

TCCP6672

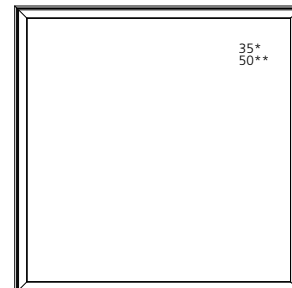

TCCP7272

87 3/8" (2219)  
88 7/8" (2257)  
84 3/4" (2153)  
84" (2134)  
78" (1981)

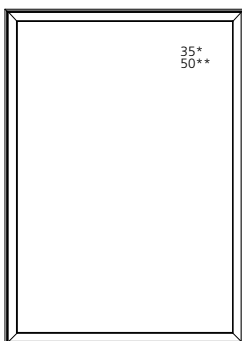

TCCP6084

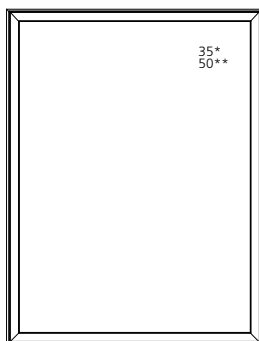

TCCP6484

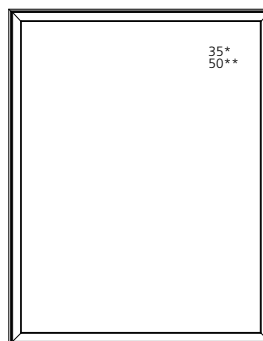

TCCP6684

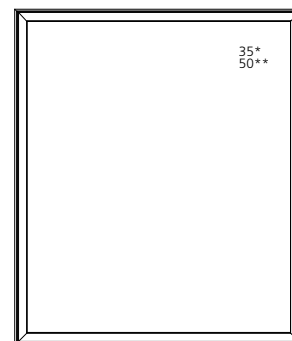

TCCP7284

**ELEVATION SYMBOL LEGEND:**

M.O. = MASONRY OPENING  
VALUES IN ( ) ARE IN MILLIMETER CONVERSIONS  
##\* NUMBER INDICATES DESIGN PRESSURE (DP) RATING WITH STANDARD GLAZING.  
##\*\* NUMBER INDICATES OPTIONAL DESIGN PRESSURE (DP) RATING.

Note Elevations shown DO NOT have exterior trim. Subtract 3/4" (19) from M.O. (Masonry Opening) for Unit Sizes. Masonry Openings above include Sill Nose, see Trim Options page for Sill Nose specifications. For other Trim Options refer to the Unit Sizing, Rough Opening & Masonry Openings page.

SCALE: 1/4" = 1'

### PICTURE UNITS

M.O. BRICKMOULD  
M.O. ADAMS/FLAT CASING  
ROUGH OPENING  
FRAME SIZE  
DAYLIGHT OPENING

87 3/4" (2229)  
90 3/4" (2305)  
84 3/4" (2153)  
84" (2134)  
78" (1981)

43 3/8" (1102)  
44 7/8" (1140)  
40 3/4" (1035)  
40" (1016)  
34" (864)

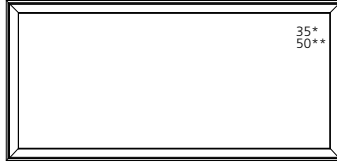

TCCP8440

45 3/8" (1153)  
46 7/8" (1191)  
42 3/4" (1086)  
42" (1067)  
36" (914)

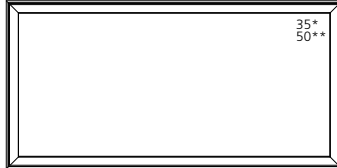

TCCP8442

51 3/8" (1305)  
52 7/8" (1343)  
48 3/4" (1238)  
48" (1219)  
42" (1067)

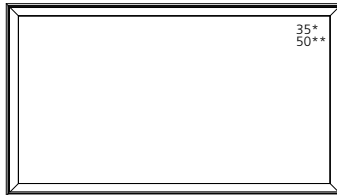

TCCP8448

57 3/8" (1457)  
58 7/8" (1495)  
54 3/4" (1391)  
54" (1372)  
48" (1219)



TCCP8454

59 3/8" (1508)  
60 7/8" (1546)  
56 3/4" (1441)  
56" (1422)  
50" (1270)

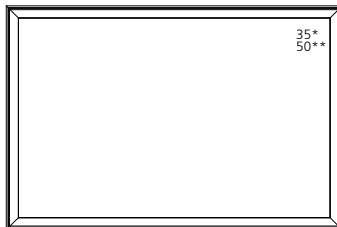

TCCP8456

63 3/8" (1609)  
64 7/8" (1648)  
60 3/4" (1543)  
60" (1524)  
54" (1372)

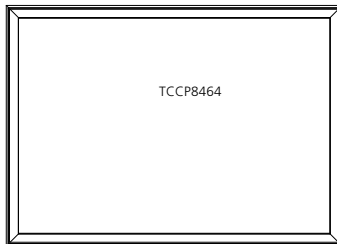

TCCP8460

M.O. BRICKMOULD  
M.O. ADAMS/FLAT CASING  
ROUGH OPENING  
FRAME SIZE  
DAYLIGHT OPENING

87 3/4" (2229)  
90 3/4" (2305)  
84 3/4" (2153)  
84" (2134)  
78" (1981)

67 3/8" (1711)  
68 7/8" (1749)  
64 3/4" (1645)  
64" (1626)  
58" (1473)

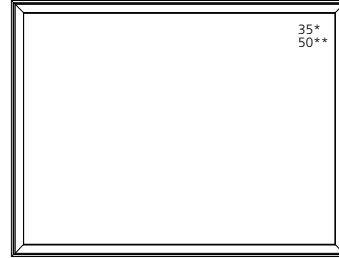

TCCP8464

69 3/8" (1762)  
70 7/8" (1800)  
66 3/4" (1695)  
66" (1676)  
60" (1524)

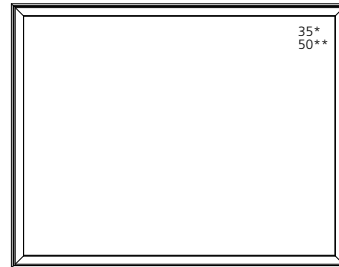

TCCP8466

75 3/8" (1915)  
76 7/8" (1953)  
72 3/4" (1848)  
72" (1829)  
66" (1676)

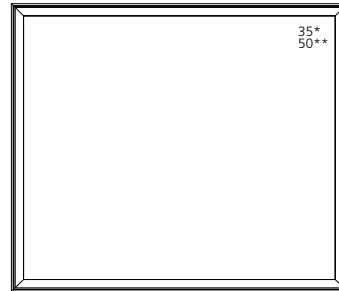

TCCP8472

**ELEVATION SYMBOL LEGEND:**

M.O. = MASONRY OPENING  
VALUES IN ( ) ARE IN MILLIMETER CONVERSIONS  
##\* NUMBER INDICATES DESIGN PRESSURE (DP) RATING WITH STANDARD GLAZING.  
###\* NUMBER INDICATES OPTIONAL DESIGN PRESSURE (DP) RATING.

Note Elevations shown DO NOT have exterior trim. Subtract 3/4" (19) from M.O. (Masonry Opening) for Unit Sizes. Masonry Openings above include Sill Nose, see Trim Options page for Sill Nose specifications. For other Trim Options refer to the Unit Sizing, Rough Opening & Masonry Openings page.

SCALE: 1/4" = 1'

**PICTURE UNIT WITH 20" FLANKERS**

M.O. BRICKMOULD M.O. ADAMS/FLAT CASING ROUGH OPENING FRAME SIZE DAYLIGHT OPENING	83 3/4"(2127) 86 3/4"(2203) 80 3/4"(2051) 80"(2032) 14"(356) 2  34"(864)	91 3/4"(2330) 94 3/4"(2407) 88 3/4"(2254) 88"(2235) 14"(356) 2  42"(1067)	99 3/4"(2534) 102 3/4"(2610) 96 3/4"(2457) 96"(2438) 14"(356) 2  50"(1270)	103 3/4"(2635) 106 3/4"(2711) 100 3/4"(2559) 100"(2540) 14"(356) 2  54"(1372)	107 3/4"(2737) 110 3/4"(2813) 104 3/4"(2661) 104"(2642) 14"(356) 2  58"(1473)
43 3/8"(1102) 44 7/8"(1140) 40 3/4"(1035) 40"(1016) 34"(864)					
TCC4040-20	TCC4840-20	TCC5640-20	TCC6040-20	TCC6440-20	
45 3/8"(1153) 46 7/8"(1191) 42 3/4"(1086) 42"(1067) 36"(914)					
TCC4042-20	TCC4842-20	TCC5642-20	TCC6042-20	TCC6442-20	
51 3/8"(1305) 52 7/8"(1343) 48 3/4"(1238) 48"(1219) 42"(1067)					
TCC4048-20	TCC4848-20	TCC5648-20	TCC6048-20	TCC6448-20	
57 3/8"(1457) 58 7/8"(1495) 54 3/4"(1391) 54"(1372) 48"(1219)					
TCC4054-20	TCC4854-20	TCC5654-20	TCC6054-20	TCC6454-20	
59 3/8"(1508) 60 7/8"(1546) 56 3/4"(1441) 56"(1422) 50"(1270)					
TCC4056-20	TCC4856-20	TCC5656-20	TCC6056-20	TCC6456-20	
63 3/8"(1609) 64 7/8"(1648) 60 3/4"(1543) 60"(1524) 54"(1372)					
TCC4060-20	TCC4860-20	TCC5660-20	TCC6060-20	TCC6460-20	
67 3/8"(1711) 68 7/8"(1749) 64 3/4"(1645) 64"(1626) 58"(1473)					
TCC4064-20	TCC4864-20	TCC5664-20	TCC6064-20	TCC6464-20	
69 3/8"(1762) 70 7/8"(1800) 66 3/4"(1695) 66"(1676) 60"(1524)					
TCC4066-20	TCC4866-20	TCC5666-20	TCC6066-20	TCC6466-20	
75 3/8"(1915) 76 7/8"(1953) 72 3/4"(1848) 72"(1829) 66"(1676)					
TCC4072-20	TCC4872-20	TCC5672-20	TCC6072-20	TCC6472-20	

**ELEVATION SYMBOL LEGEND:**  
M.O. = MASONRY OPENING  
VALUES IN ( ) ARE IN MILLIMETER CONVERSIONS  
VALUES IN [ ] ARE NUMBER OF DAYLIGHT OPENINGS PER UNIT

Note Elevations shown DO NOT have exterior trim. Subtract 3/4" (19) from M.O. (Masonry Opening) for Unit Sizes. Masonry Openings above include Sill Nose, see Trim Options page for Sill Nose specifications. For other Trim Options refer to the Unit Sizing, Rough Opening & Masonry Openings page.

SCALE: 1/8" = 1'

**PICTURE UNIT WITH 20" FLANKERS**

<b>M.O. BRICKMOULD</b>	115 3/4"(2940)
<b>M.O. ADAMS/FLAT CASING</b>	118 3/4"(3016)
<b>ROUGH OPENING</b>	112 3/4"(2864)
<b>FRAME SIZE</b>	112"(2849)
<b>DAYLIGHT OPENING</b>	14"(356)[2] 66"(1676)

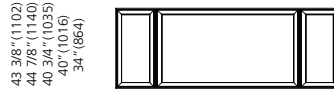

TCC7240-20

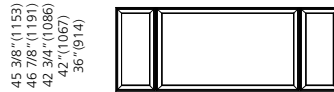

TCC7242-20

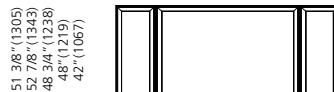

TCC7248-20

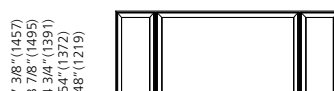

TCC7254-20

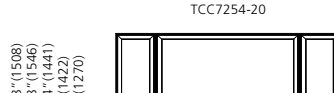

TCC7256-20



TCC7260-20



TCC7264-20



TCC7266-20



TCC7272-20

**ELEVATION SYMBOL LEGEND:**  
**M.O.** = MASONRY OPENING  
 VALUES IN ( ) ARE IN MILLIMETER CONVERSIONS  
 VALUES IN [ ] ARE NUMBER OF DAYLIGHT OPENINGS PER UNIT

Note Elevations shown DO NOT have exterior trim. Subtract 3/4" (19) from M.O. (Masonry Opening) for Unit Sizes. Masonry Openings above include Sill Nose, see Trim Options page for Sill Nose specifications. For other Trim Options refer to the Unit Sizing, Rough Opening & Masonry Openings page.

SCALE: 1/8" = 1'

**PICTURE UNIT WITH 24" FLANKERS**







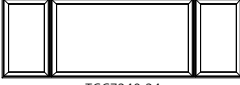
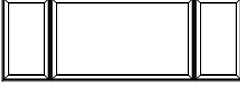

M.O. BRICKMOULD M.O. ADAMS/FLAT CASING ROUGH OPENING FRAME SIZE DAYLIGHT OPENING	91 3/4"(2330) 94 3/4"(2407) 88 3/4"(2254) 88"(2235) 18"(457) 2 34"(864)	99 3/4"(2534) 102 3/4"(2610) 96 3/4"(2457) 96"(2438) 18"(457) 2 42"(1067)	107 3/4"(2737) 110 3/4"(2813) 104 3/4"(2661) 104"(2642) 18"(457) 2 50"(1270)	111 3/4"(2838) 114 3/4"(2915) 108 3/4"(2762) 108"(2743) 18"(457) 2 54"(1372)	115 3/4"(2940) 118 3/4"(3016) 112 3/4"(2864) 112"(2849) 18"(457) 2 58"(1473)
43 3/8"(1102) 44 7/8"(1140) 40 3/4"(1035) 40"(1016) 34"(864)					
TCC4040-24	TCC4840-24	TCC5640-24	TCC6040-24	TCC6440-24	
45 3/8"(1153) 46 7/8"(1191) 42 3/4"(1086) 42"(1067) 36"(914)					
TCC4042-24	TCC4842-24	TCC5642-24	TCC6042-24	TCC6442-24	
51 3/8"(1305) 52 7/8"(1343) 48 3/4"(1238) 48"(1219) 42"(1067)					
TCC4048-24	TCC4848-24	TCC5648-24	TCC6048-24	TCC6448-24	
57 3/8"(1457) 58 7/8"(1495) 54 3/4"(1391) 54"(1372) 48"(1219)					
TCC4054-24	TCC4854-24	TCC5654-24	TCC6054-24	TCC6454-24	
59 3/8"(1508) 60 7/8"(1546) 56 3/4"(1441) 56"(1422) 50"(1270)					
TCC4056-24	TCC4856-24	TCC5656-24	TCC6056-24	TCC6456-24	
63 3/8"(1609) 64 7/8"(1648) 60 3/4"(1543) 60"(1524) 54"(1372)					
TCC4060-24	TCC4860-24	TCC5660-24	TCC6060-24	TCC6460-24	
67 3/8"(1711) 68 7/8"(1749) 64 3/4"(1645) 64"(1626) 58"(1473)					
TCC4064-24	TCC4864-24	TCC5664-24	TCC6064-24	TCC6464-24	
69 3/8"(1762) 70 7/8"(1800) 66 3/4"(1695) 66"(1676) 60"(1524)					
TCC4066-24	TCC4866-24	TCC5666-24	TCC6066-24	TCC6466-24	
75 3/8"(1915) 76 7/8"(1953) 72 3/4"(1848) 72"(1829) 66"(1676)					
TCC4072-24	TCC4872-24	TCC5672-24	TCC6072-24	TCC6472-24	

**ELEVATION SYMBOL LEGEND:**  
**M.O.** = MASONRY OPENING  
 VALUES IN ( ) ARE IN MILLIMETER CONVERSIONS  
 VALUES IN [ ] ARE NUMBER OF DAYLIGHT OPENINGS PER UNIT

Note Elevations shown DO NOT have exterior trim. Subtract 3/4" (19) from M.O. (Masonry Opening) for Unit Sizes. Masonry Openings above include Sill Nose, see Trim Options page for Sill Nose specifications. For other Trim Options refer to the Unit Sizing, Rough Opening & Masonry Openings page.

SCALE: 1/8" = 1'

**PICTURE UNIT WITH 24" FLANKERS**

M.O. BRICKMOULD	123 3/4" (3143)
M.O. ADAMS/FLAT CASING	126 3/4" (3219)
ROUGH OPENING	120 3/4" (3067)
FRAME SIZE	120" (3048)
DAYLIGHT OPENING	18" (457) [2] 66" (1676)
43 3/8" (1102) 44 7/8" (1140) 40 3/4" (1035) 40" (1016) 34" (864)	
TCC7240-24	
45 3/8" (1153) 46 7/8" (1191) 42 3/4" (1086) 42" (1067) 36" (914)	
TCC7242-24	
51 3/8" (1305) 52 7/8" (1343) 48 3/4" (1238) 48" (1219) 42" (1067)	
TCC7248-24	
57 3/8" (1457) 58 7/8" (1495) 54 3/4" (1391) 54" (1372) 48" (1219)	
TCC7254-24	
59 3/8" (1508) 60 7/8" (1546) 56 3/4" (1441) 56" (1422) 50" (1270)	
TCC7256-24	
63 3/8" (1609) 64 7/8" (1648) 60 3/4" (1543) 60" (1524) 54" (1372)	
TCC7260-24	
67 3/8" (1711) 68 7/8" (1749) 64 3/4" (1645) 64" (1626) 58" (1473)	
TCC7264-24	
69 3/8" (1762) 70 7/8" (1800) 66 3/4" (1695) 66" (1676) 60" (1524)	
TCC7266-24	
75 3/8" (1915) 76 7/8" (1953) 72 3/4" (1848) 72" (1829) 66" (1676)	
TCC7272-24	

**ELEVATION SYMBOL LEGEND:**

M.O. = MASONRY OPENING  
VALUES IN ( ) ARE IN MILLIMETER CONVERSIONS  
VALUES IN [ ] ARE NUMBER OF DAYLIGHT OPENINGS PER UNIT

Note Elevations shown DO NOT have exterior trim. Subtract 3/4" (19) from M.O. (Masonry Opening) for Unit Sizes. Masonry Openings above include Sill Nose, see Trim Options page for Sill Nose specifications. For other Trim Options refer to the Unit Sizing, Rough Opening & Masonry Openings page.

SCALE: 1/8" = 1'



**PICTURE UNIT WITH 28" FLANKERS**

M.O. BRICKMOULD M.O. ADAMS/FLAT CASING ROUGH OPENING FRAME SIZE DAYLIGHT OPENING	99 3/4"(2534) 102 3/4"(2610) 96 3/4"(2457) 96"(2438) 22"(559) 2 34"(864)	107 3/4"(2737) 110 3/4"(2813) 104 3/4"(2661) 104"(2642) 22"(559) 2 42"(1067)	115 3/4"(2940) 118 3/4"(3016) 112 3/4"(2864) 112"(2849) 22"(559) 2 50"(1270)	119 3/4"(3042) 122 3/4"(3118) 116 3/4"(2965) 116"(2946) 22"(559) 2 54"(1372)
43 3/8"(1102) 44 7/8"(1140) 40 3/4"(1035) 40"(1016) 34"(864)				
45 3/8"(1153) 46 7/8"(1191) 42 3/4"(1086) 42"(1067) 36"(914)				
51 3/8"(1305) 52 7/8"(1343) 48 3/4"(1238) 48"(1219) 42"(1067)				
57 3/8"(1457) 58 7/8"(1495) 54 3/4"(1391) 54"(1372) 48"(1219)				
59 3/8"(1508) 60 7/8"(1546) 56 3/4"(1441) 56"(1422) 50"(1270)				
63 3/8"(1609) 64 7/8"(1648) 60 3/4"(1543) 60"(1524) 54"(1372)				
67 3/8"(1711) 68 7/8"(1749) 64 3/4"(1645) 64"(1626) 58"(1473)				
69 3/8"(1762) 70 7/8"(1800) 66 3/4"(1695) 66"(1676) 60"(1524)				
75 3/8"(1915) 76 7/8"(1953) 72 3/4"(1848) 72"(1829) 66"(1676)				

**ELEVATION SYMBOL LEGEND:**  
**M.O.** = MASONRY OPENING  
 VALUES IN ( ) ARE IN MILLIMETER CONVERSIONS  
 VALUES IN [ ] ARE NUMBER OF DAYLIGHT OPENINGS PER UNIT  
**E** BASIC UNIT CLEAR OPENING EXCEEDS 20" IN WIDTH, 24" IN HEIGHT & A MINIMUM OF 5.7 SQ. FT.

Note Elevations shown DO NOT have exterior trim. Subtract 3/4" (19) from M.O. (Masonry Opening) for Unit Sizes. Masonry Openings above include Sill Nose, see Trim Options page for Sill Nose specifications. For other Trim Options refer to the Unit Sizing, Rough Opening & Masonry Openings page.

SCALE: 1/8" = 1'

**PICTURE UNIT WITH 28" FLANKERS**

M.O. BRICKMOULD M.O. ADAMS/FLAT CASING ROUGH OPENING FRAME SIZE DAYLIGHT OPENING	123 3/4"(3143) 126 3/4"(3219) 120 3/4"(3067) 120"(3048) 22"(559) 2 58"(1473)	131 3/4"(3346) 134 3/4"(3423) 128 3/4"(3270) 128"(3251) 22"(559) 2 66"(1676)
43 3/8"(1102) 44 7/8"(1140) 40 3/4"(1035) 40"(1016) 34"(864)		
45 3/8"(1153) 46 7/8"(1191) 42 3/4"(1086) 42"(1067) 36"(914)		
51 3/8"(1305) 52 7/8"(1343) 48 3/4"(1238) 48"(1219) 42"(1067)		
57 3/8"(1457) 58 7/8"(1495) 54 3/4"(1391) 54"(1372) 48"(1219)		
59 3/8"(1508) 60 7/8"(1546) 56 3/4"(1441) 56"(1422) 50"(1270)		
63 3/8"(1609) 64 7/8"(1648) 60 3/4"(1543) 60"(1524) 54"(1372)		
67 3/8"(1711) 68 7/8"(1749) 64 3/4"(1645) 64"(1626) 58"(1473)		
69 3/8"(1762) 70 7/8"(1800) 66 3/4"(1695) 66"(1676) 60"(1524)		
75 3/8"(1915) 76 7/8"(1953) 72 3/4"(1848) 72"(1829) 66"(1676)		

**ELEVATION SYMBOL LEGEND:**

M.O. = MASONRY OPENING  
VALUES IN ( ) ARE IN MILLIMETER CONVERSIONS  
VALUES IN | ARE NUMBER OF DAYLIGHT OPENINGS PER UNIT  
E BASIC UNIT CLEAR OPENING EXCEEDS 20" IN WIDTH, 24" IN HEIGHT & A MINIMUM OF 5.7 SQ. FT.

Note Elevations shown DO NOT have exterior trim. Subtract 3/4" (19) from M.O. (Masonry Opening) for Unit Sizes. Masonry Openings above include Sill Nose, see Trim Options page for Sill Nose specifications. For other Trim Options refer to the Unit Sizing, Rough Opening & Masonry Openings page.

SCALE: 1/8" = 1'

### 30° BAY UNIT WITH 20" FLANKERS

M.O. BRICKMOULD  
M.O. ADAMS/FLAT CASING  
ROUGH OPENING  
FRAME SIZE  
DAYLIGHT OPENING

72 3/16" (1834)  
75 1/4" (1911)  
78" (1978)  
81 1/2" (2067)  
84 1/2" (2143)  
87 1/2" (2220)  
90 1/2" (2297)  
93 1/2" (2374)  
96 1/2" (2451)  
99 1/2" (2528)  
102 1/2" (2605)  
105 1/2" (2682)  
108 1/2" (2759)  
111 1/2" (2836)

82 3/16" (2088)  
85 1/4" (2165)  
88" (1981)  
91 1/8" (2337)  
94 1/4" (2394)  
97 1/4" (2451)  
100 1/4" (2508)  
103 1/4" (2565)  
106 1/4" (2622)  
109 1/4" (2679)  
112 1/4" (2736)  
115 1/4" (2793)  
118 1/4" (2850)  
121 1/4" (2907)

91 3/16" (2316)  
94 1/4" (2394)  
97 1/4" (2451)  
100 1/4" (2508)  
103 1/4" (2565)  
106 1/4" (2622)  
109 1/4" (2679)  
112 1/4" (2736)  
115 1/4" (2793)  
118 1/4" (2850)  
121 1/4" (2907)  
124 1/4" (2964)  
127 1/4" (3021)  
130 1/4" (3078)

98 3/16" (2494)  
101 1/4" (2572)  
104 1/4" (2629)  
107 1/4" (2686)  
110 1/4" (2743)  
113 1/4" (2800)  
116 1/4" (2857)  
119 1/4" (2914)  
122 1/4" (2971)  
125 1/4" (3028)  
128 1/4" (3085)  
131 1/4" (3142)  
134 1/4" (3199)  
137 1/4" (3256)

102 3/16" (2596)  
105 1/4" (2673)  
108 1/4" (2730)  
111 1/4" (2787)  
114 1/4" (2844)  
117 1/4" (2901)  
120 1/4" (2958)  
123 1/4" (3015)  
126 1/4" (3072)  
129 1/4" (3129)  
132 1/4" (3186)  
135 1/4" (3243)  
138 1/4" (3300)  
141 1/4" (3357)

36 15/16" (938)  
38 1/2" (978)  
34" (864)  
33 1/2" (851)  
27 1/2" (699)  
40 15/16" (1040)  
42 1/2" (1080)  
38" (965)  
37 1/2" (953)  
31 1/2" (799)  
44 15/16" (1141)  
46 1/2" (1181)  
42" (1067)  
41 1/2" (1054)  
35 1/2" (901)  
46 15/16" (1192)  
48 1/2" (1232)  
44" (1118)  
43 1/2" (1105)  
37 1/2" (952)  
52 15/16" (1345)  
54 1/2" (1384)  
50" (1270)  
49 1/2" (1257)  
43 1/2" (1104)  
58 15/16" (1497)  
60 1/2" (1537)  
56" (1422)  
55 1/2" (1410)  
49 1/2" (1256)  
60 15/16" (1548)  
62 1/2" (1588)  
58" (1473)  
57 1/2" (1448)  
51 1/2" (1307)  
64 15/16" (1649)  
66 1/2" (1689)  
62" (1575)  
61 1/2" (1562)  
55 1/2" (1409)  
68 15/16" (1751)  
70 1/2" (1791)  
66" (1676)  
65 1/2" (1664)  
59 1/2" (1510)  
70 15/16" (1802)  
72 1/2" (1842)  
68" (1727)  
67 1/2" (1715)  
61 1/2" (1561)  
76 15/16" (1954)  
78 1/2" (1994)  
74" (1880)  
73 1/2" (1867)  
67 1/2" (1714)

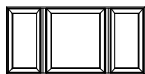

TCC3Y3032-20

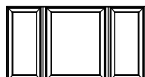

TCC3Y3036-20

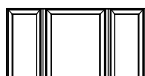

TCC3Y3040-20



TCC3Y3042-20



TCC3Y3048-20



TCC3Y3054-20



TCC3Y3056-20



TCC3Y3060-20



TCC3Y3066-20



TCC3Y3072-20

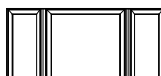

TCC3Y4040-20



TCC3Y4042-20



TCC3Y4048-20

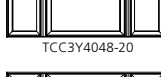

TCC3Y4054-20



TCC3Y4056-20



TCC3Y4060-20



TCC3Y4066-20



TCC3Y4072-20



TCC3Y4840-20



TCC3Y4842-20



TCC3Y4848-20

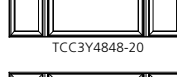

TCC3Y4854-20



TCC3Y4856-20



TCC3Y4860-20

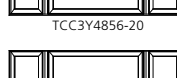

TCC3Y4866-20



TCC3Y4872-20



TCC3Y5640-20



TCC3Y5642-20

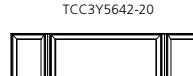

TCC3Y5648-20

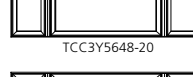

TCC3Y5654-20



TCC3Y5656-20

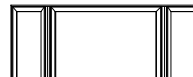

TCC3Y5660-20

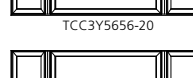

TCC3Y5666-20



TCC3Y5672-20



TCC3Y6040-20

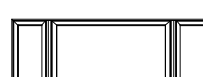

TCC3Y6042-20

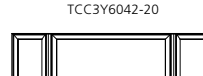

TCC3Y6048-20

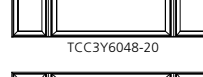

TCC3Y6054-20



TCC3Y6056-20

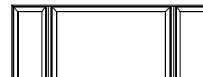

TCC3Y6060-20

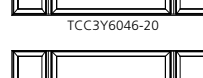

TCC3Y6066-20



TCC3Y6072-20

**ELEVATION SYMBOL LEGEND:**  
M.O. = MASONRY OPENING  
VALUES IN ( ) ARE IN MILLIMETER CONVERSIONS  
VALUES IN [ ] ARE NUMBER OF DAYLIGHT OPENINGS PER UNIT

Note Elevations shown DO NOT have exterior trim. Subtract 3/4" (19) from M.O. (Masonry Opening) for Unit Sizes. Masonry Openings above include Sill Nose, see Trim Options page for Sill Nose specifications. For other Trim Options refer to the Unit Sizing, Rough Opening & Masonry Openings page.

SCALE: 1/8" = 1'

**30° BAY UNIT WITH 20" FLANKERS**

M.O. BRICKMOULD M.O. ADAMS/FLAT CASING ROUGH OPENING FRAME SIZE DAYLIGHT OPENING	106 3/16" (2697) 109 1/4" (2775) 102" (2591) 102 7/16" (2602) 11" (279)[2] 58" (1473)	114 3/16" (2900) 117 1/4" (2978) 110" (2794) 110 7/16" (2805) 11" (279)[2] 66" (1676)
44 15/16" (1141) 46 1/2" (1181) 42" (1067) 41 1/2" (1054) 35 1/2" (901)		
46 15/16" (1192) 48 1/2" (1232) 44" (1118) 43 1/2" (1105) 37 1/2" (952)		
52 15/16" (1345) 54 1/2" (1384) 50" (1270) 49 1/2" (1257) 43 1/2" (1104)		
58 15/16" (1497) 60 1/2" (1537) 56" (1422) 55 1/2" (1410) 49 1/2" (1256)		
60 15/16" (1548) 62 1/2" (1588) 58" (1473) 57 1/2" (1448) 51 1/2" (1307)		
64 15/16" (1649) 66 1/2" (1689) 62" (1575) 61 1/2" (1562) 55 1/2" (1409)		
68 15/16" (1751) 70 1/2" (1791) 66" (1676) 65 1/2" (1664) 59 1/2" (1510)		
70 15/16" (1802) 72 1/2" (1842) 68" (1727) 67 1/2" (1715) 61 1/2" (1561)		
76 15/16" (1954) 78 1/2" (1994) 74" (1880) 73 1/2" (1867) 67 1/2" (1714)		

**ELEVATION SYMBOL LEGEND:**  
M.O. = MASONRY OPENING  
VALUES IN ( ) ARE IN MILLIMETER CONVERSIONS  
VALUES IN [ ] ARE NUMBER OF DAYLIGHT OPENINGS PER UNIT

Note Elevations shown DO NOT have exterior trim. Subtract 3/4" (19) from M.O. (Masonry Opening) for Unit Sizes. Masonry Openings above include Sill Nose, see Trim Options page for Sill Nose specifications. For other Trim Options refer to the Unit Sizing, Rough Opening & Masonry Openings page.

SCALE: 1/8" = 1'

**30° BAY UNIT WITH 24" FLANKERS**

**M.O. BRICKMOULD**  
**M.O. ADAMS/FLAT CASING**  
**ROUGH OPENING**  
**FRAME SIZE**  
**DAYLIGHT OPENING**

79 1/8"(2010)  
82 3/16"(2088)  
74 15/16"(1903)  
75 3/8"(1915)  
18"(457)[2] 24"(610)

89 1/8"(2264)  
92 3/16"(2342)  
84 15/16"(2157)  
85 3/8"(2169)  
18"(457)[2] 34"(864)

97 1/8"(2467)  
100 3/16"(2545)  
92 15/16"(2361)  
93 3/8"(2372)  
18"(457)[2] 42"(1067)

105 1/8"(2670)  
108 3/16"(2748)  
100 15/16"(2564)  
101 3/8"(2575)  
18"(457)[2] 50"(1270)

109 1/8"(2772)  
112 3/16"(2850)  
104 15/16"(2665)  
105 3/8"(2677)  
18"(457)[2] 54"(1372)









36 15/16"(938) 38 1/2"(978) 34"(864) 33 1/2"(851) 27 1/2"(699)					
TCC3Y3032-24					
40 15/16"(1040) 42 1/2"(1080) 38"(965) 37 1/2"(953) 31 1/2"(799)					
TCC3Y3036-24					
44 15/16"(1141) 46 1/2"(1181) 42"(1067) 41 1/2"(1054) 35 1/2"(901)					
TCC3Y3040-24	TCC3Y4040-24	TCC3Y4840-24	TCC3Y5640-24	TCC3Y6040-24	
46 15/16"(1192) 48 1/2"(1232) 44"(1118) 43 1/2"(1105) 37 1/2"(952)					
TCC3Y3042-24	TCC3Y4042-24	TCC3Y4842-24	TCC3Y5642-24	TCC3Y6042-24	
52 15/16"(1345) 54 1/2"(1384) 50"(1270) 49 1/2"(1257) 43 1/2"(1104)					
TCC3Y3048-24	TCC3Y4048-24	TCC3Y4848-24	TCC3Y5648-24	TCC3Y6048-24	
58 15/16"(1497) 60 1/2"(1537) 56"(1422) 55 1/2"(1410) 49 1/2"(1236)					
TCC3Y3054-24	TCC3Y4054-24	TCC3Y4854-24	TCC3Y5654-24	TCC3Y6054-24	
60 15/16"(1548) 62 1/2"(1588) 58"(1473) 57 1/2"(1448) 51 1/2"(1307)					
TCC3Y3056-24	TCC3Y4056-24	TCC3Y4856-24	TCC3Y5656-24	TCC3Y6056-24	
64 15/16"(1649) 66 1/2"(1689) 62"(1575) 61 1/2"(1562) 55 1/2"(1409)					
TCC3Y3060-24	TCC3Y4060-24	TCC3Y4860-24	TCC3Y5660-24	TCC3Y6060-24	
68 15/16"(1751) 70 1/2"(1791) 66"(1676) 65 1/2"(1664) 59 1/2"(1510)					
TCC3Y3064-24	TCC3Y4064-24	TCC3Y4864-24	TCC3Y5664-24	TCC3Y6064-24	
70 15/16"(1802) 72 1/2"(1842) 68"(1727) 67 1/2"(1715) 61 1/2"(1361)					
TCC3Y3066-24	TCC3Y4066-24	TCC3Y4866-24	TCC3Y5666-24	TCC3Y6066-24	
76 15/16"(1954) 78 1/2"(1994) 74"(1880) 73 1/2"(1867) 67 1/2"(1714)					
TCC3Y3072-24	TCC3Y4072-24	TCC3Y4872-24	TCC3Y5672-24	TCC3Y6072-24	

**ELEVATION SYMBOL LEGEND:**  
M.O. = MASONRY OPENING  
VALUES IN ( ) ARE IN MILLIMETER CONVERSIONS  
VALUES IN [ ] ARE NUMBER OF DAYLIGHT OPENINGS PER UNIT

Note Elevations shown DO NOT have exterior trim. Subtract 3/4" (19) from M.O. (Masonry Opening) for Unit Sizes. Masonry Openings above include Sill Nose, see Trim Options page for Sill Nose specifications. For other Trim Options refer to the Unit Sizing, Rough Opening & Masonry Openings page.

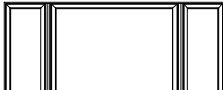
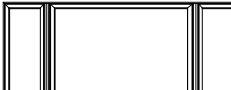
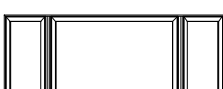
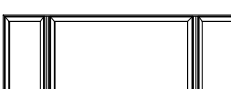
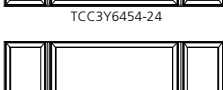
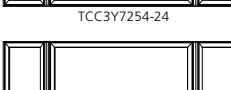
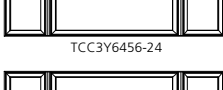
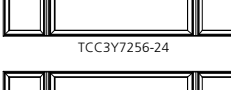
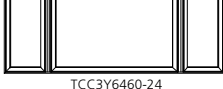
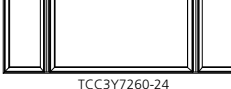
SCALE: 1/8" = 1'

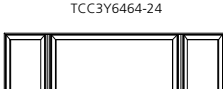
**30° BAY UNIT WITH 24" FLANKERS**

M.O. BRICKMOUND M.O. ADAMS/FLAT CASING ROUGH OPENING FRAME SIZE DAYLIGHT OPENING	113 1/8"(2873) 116 3/16"(2951) 108 15/16"(2767) 109 3/8"(2778) 18"(457)[2] 58"(1473)	121 1/8"(3077) 124 3/16"(3154) 116 15/16"(2970) 117 3/8"(2981) 18"(457)[2] 66"(1676)
44 15/16"(1141) 46 1/2"(1181) 42"(1067) 41 1/2"(1054) 35 1/2"(901)		
	TCC3Y6440-24	TCC3Y7240-24
46 15/16"(1192) 48 1/2"(1232) 44"(1118) 43 1/2"(1105) 37 1/2"(952)		
	TCC3Y6442-24	TCC3Y7242-24
52 15/16"(1345) 54 1/2"(1384) 50"(1270) 49 1/2"(1257) 43 1/2"(1104)		
	TCC3Y6448-24	TCC3Y7248-24
58 15/16"(1497) 60 1/2"(1537) 55"(1423) 55 1/2"(1410) 49 1/2"(1256)		
	TCC3Y6454-24	TCC3Y7254-24
60 15/16"(1548) 62 1/2"(1588) 58"(1473) 57 1/2"(1448) 51 1/2"(1307)		
	TCC3Y6456-24	TCC3Y7256-24
64 15/16"(1649) 66 1/2"(1689) 62"(1575) 61 1/2"(1562) 55 1/2"(1409)		
	TCC3Y6460-24	TCC3Y7260-24
68 15/16"(1751) 70 1/2"(1791) 66"(1676) 65 1/2"(1664) 59 1/2"(1510)		
	TCC3Y6464-24	TCC3Y7264-24
70 15/16"(1802) 72 1/2"(1842) 68"(1727) 67 1/2"(1715) 61 1/2"(1561)		
	TCC3Y6466-24	TCC3Y7266-24
76 15/16"(1954) 78 1/2"(1994) 74"(1880) 73 1/2"(1867) 67 1/2"(1714)		
	TCC3Y6472-24	TCC3Y7272-24

**ELEVATION SYMBOL LEGEND:**  
M.O. = MASONRY OPENING  
VALUES IN ( ) ARE IN MILLIMETER CONVERSIONS  
VALUES IN [ ] ARE NUMBER OF DAYLIGHT OPENINGS PER UNIT

Note Elevations shown DO NOT have exterior trim. Subtract 3/4" (19) from M.O. (Masonry Opening) for Unit Sizes. Masonry Openings above include Sill Nose, see Trim Options page for Sill Nose specifications. For other Trim Options refer to the Unit Sizing, Rough Opening & Masonry Openings page.

SCALE: 1/8" = 1'

**30° BAY UNIT WITH 28" FLANKERS**

<b>M.O. BRICKMOULD</b>	86 1/16" (2186)	96 1/16" (2440)	104 1/16" (2643)	112 1/16" (2846)	116 1/16" (2948)
<b>M.O. ADAMS/FLAT CASING</b>	89 1/8" (2264)	99 1/8" (2518)	107 1/8" (2721)	115 1/8" (2924)	119 1/8" (3026)
<b>ROUGH OPENING</b>	81 7/8" (2080)	91 7/8" (2334)	99 7/8" (2537)	107 7/8" (2740)	111 7/8" (2842)
<b>FRAME SIZE</b>	82 5/16" (2091)	92 5/16" (2345)	100 5/16" (2548)	108 5/16" (2751)	112 5/16" (2852)
<b>DAYLIGHT OPENING</b>	22" (559) [2] 24" (610)	22" (559) [2] 34" (864)	22" (559) [2] 42" (1067)	22" (559) [2] 50" (1270)	22" (559) [2] 54" (1372)

36 15/16" (938) 38 1/2" (978) 34" (864) 33 1/2" (851) 27 1/2" (699)					
40 15/16" (1040) 42 1/2" (1080) 38" (965) 37 1/2" (953) 31 1/2" (799)					
44 15/16" (1141) 46 1/2" (1181) 42" (1067) 41 1/2" (1054) 35 1/2" (901)					
46 15/16" (1192) 48 1/2" (1232) 44" (1118) 43 1/2" (1105) 37 1/2" (952)					
52 15/16" (1345) 54 1/2" (1384) 50" (1270) 49 1/2" (1257) 43 1/2" (1104)					
58 15/16" (1497) 60 1/2" (1537) 56" (1422) 55 1/2" (1410) 49 1/2" (1256)					
60 15/16" (1548) 62 1/2" (1588) 58" (1473) 57 1/2" (1460) 51 1/2" (1307)					
64 15/16" (1649) 66 1/2" (1689) 62" (1575) 61 1/2" (1562) 55 1/2" (1409)					
68 15/16" (1751) 70 1/2" (1791) 66" (1676) 65 1/2" (1664) 59 1/2" (1510)					
70 15/16" (1802) 72 1/2" (1842) 68" (1727) 67 1/2" (1715) 61 1/2" (1561)					
76 15/16" (1954) 78 1/2" (1994) 74" (1880) 73 1/2" (1867) 67 1/2" (1714)					

**ELEVATION SYMBOL LEGEND:**  
**M.O.** = MASONRY OPENING  
 VALUES IN ( ) ARE IN MILLIMETER CONVERSIONS  
 VALUES IN [ ] ARE NUMBER OF DAYLIGHT OPENINGS PER UNIT  
**E** BASIC UNIT CLEAR OPENING EXCEEDS 20" IN WIDTH, 24" IN HEIGHT & A MINIMUM OF 5.7 SQ. FT.

Note Elevations shown DO NOT have exterior trim. Subtract 3/4" (19) from M.O. (Masonry Opening) for Unit Sizes. Masonry Openings above include Sill Nose, see Trim Options page for Sill Nose specifications. For other Trim Options refer to the Unit Sizing, Rough Opening & Masonry Openings page.

SCALE: 1/8" = 1'

**30° BAY UNIT WITH 28" FLANKERS**

M.O. BRICKMOULD M.O. ADAMS/FLAT CASING ROUGH OPENING FRAME SIZE DAYLIGHT OPENING	120 1/16" (3050) 123 1/8" (3127) 115 7/8" (2943) 116 5/16" (2954) 22" (559)[2] 58" (1473)	128 1/16" (3253) 131 1/8" (3331) 123 7/8" (3146) 124 5/16" (3158) 22" (559)[2] 66" (1676)
44 15/16" (1141) 46 1/2" (1181) 42" (1067) 41 1/2" (1054) 35 1/2" (901)		
46 15/16" (1192) 48 1/2" (1232) 44" (1118) 43 1/2" (1105) 37 1/2" (952)		
52 15/16" (1345) 54 1/2" (1384) 50" (1270) 49 1/2" (1257) 43 1/2" (1104)		
58 15/16" (1497) 60 1/2" (1537) 56" (1422) 55 1/2" (1410) 49 1/2" (1256)		
60 15/16" (1548) 62 1/2" (1588) 58" (1473) 57 1/2" (1448) 51 1/2" (1307)		
64 15/16" (1649) 66 1/2" (1689) 62" (1575) 61 1/2" (1562) 55 1/2" (1409)		
68 15/16" (1751) 70 1/2" (1791) 66" (1676) 65 1/2" (1664) 59 1/2" (1510)		
70 15/16" (1802) 72 1/2" (1842) 68" (1727) 67 1/2" (1715) 61 1/2" (1561)		
76 15/16" (1954) 78 1/2" (1994) 74" (1880) 73 1/2" (1867) 67 1/2" (1714)		

**ELEVATION SYMBOL LEGEND:**

M.O. = MASONRY OPENING  
VALUES IN ( ) ARE IN MILLIMETER CONVERSIONS  
VALUES IN [ ] ARE NUMBER OF DAYLIGHT OPENINGS PER UNIT  
E BASIC UNIT CLEAR OPENING EXCEEDS 20" IN WIDTH, 24" IN HEIGHT & A MINIMUM OF 5.7 SQ. FT.

Note Elevations shown DO NOT have exterior trim. Subtract 3/4" (19) from M.O. (Masonry Opening) for Unit Sizes. Masonry Openings above include Sill Nose, see Trim Options page for Sill Nose specifications. For other Trim Options refer to the Unit Sizing, Rough Opening & Masonry Openings page.

SCALE: 1/8" = 1'



### 45° BAY UNIT WITH 20" FLANKERS

M.O. BRICKMOULD M.O. ADAMS/FLAT CASING ROUGH OPENING FRAME SIZE DAYLIGHT OPENING	67 7/16" (1713) 70 1/2" (1791) 62 7/8" (1597) 63 11/16" (1618) 14" (356) [2] 24 (610)	77 7/16" (1967) 80 1/2" (2045) 72 7/8" (1851) 73 11/16" (1872) 14" (356) [2] 34" (864)	85 7/16" (2170) 88 1/2" (2248) 80 7/8" (2054) 81 11/16" (2075) 14" (356) [2] 42" (1067)	93 7/16" (2373) 96 1/2" (2451) 88 7/8" (2257) 89 11/16" (2278) 14" (356) [2] 50" (1270)	97 7/16" (2475) 100 1/2" (2553) 92 7/8" (2359) 93 11/16" (2380) 14" (356) [2] 54" (1372)
36 15/16" (938) 38 1/2" (978) 34" (864) 33 1/2" (851) 27 1/2" (699)					
TCC4Y3032-20					
40 15/16" (1040) 42 1/2" (1080) 38" (965) 37 1/2" (953) 31 1/2" (799)					
TCC4Y3036-20					
44 15/16" (1141) 46 1/2" (1181) 42" (1067) 41 1/2" (1054) 35 1/2" (901)					
TCC4Y3040-20	TCC4Y4040-20	TCC4Y4840-20	TCC4Y5640-20	TCC4Y6040-20	
46 15/16" (1192) 48 1/2" (1232) 44" (1118) 43 1/2" (1105) 37 1/2" (952)					
TCC4Y3042-20	TCC4Y4042-20	TCC4Y4842-20	TCC4Y5642-20	TCC4Y6042-20	
52 15/16" (1345) 54 1/2" (1384) 50" (1270) 49 1/2" (1257) 43 1/2" (1104)					
TCC4Y3048-20	TCC4Y4048-20	TCC4Y4848-20	TCC4Y5648-20	TCC4Y6048-20	
58 15/16" (1497) 60 1/2" (1537) 56" (1422) 55 1/2" (1410) 49 1/2" (1256)					
TCC4Y3054-20	TCC4Y4054-20	TCC4Y4854-20	TCC4Y5654-20	TCC4Y6054-20	
60 15/16" (1548) 62 1/2" (1588) 58" (1473) 57 1/2" (1448) 51 1/2" (1307)					
TCC4Y3056-20	TCC4Y4056-20	TCC4Y4856-20	TCC4Y5656-20	TCC4Y6056-20	
64 15/16" (1649) 66 1/2" (1689) 62" (1575) 61 1/2" (1562) 55 1/2" (1409)					
TCC4Y3060-20	TCC4Y4060-20	TCC4Y4860-20	TCC4Y5660-20	TCC4Y6060-20	
68 15/16" (1751) 70 1/2" (1791) 66" (1676) 65 1/2" (1664) 59 1/2" (1510)					
TCC4Y3064-20	TCC4Y4064-20	TCC4Y4864-20	TCC4Y5664-20	TCC4Y6064-20	
70 15/16" (1802) 72 1/2" (1842) 68" (1727) 67 1/2" (1715) 61 1/2" (1561)					
TCC4Y3066-20	TCC4Y4066-20	TCC4Y4866-20	TCC4Y5666-20	TCC4Y6066-20	
76 15/16" (1954) 78 1/2" (1994) 74" (1880) 73 1/2" (1867) 67 1/2" (1714)					
TCC4Y3072-20	TCC4Y4072-20	TCC4Y4872-20	TCC4Y5672-20	TCC4Y6072-20	

**ELEVATION SYMBOL LEGEND:**  
**M.O.** = MASONRY OPENING  
 VALUES IN ( ) ARE IN MILLIMETER CONVERSIONS  
 VALUES IN [ ] ARE NUMBER OF DAYLIGHT OPENINGS PER UNIT

Note Elevations shown DO NOT have exterior trim. Subtract 3/4" (19) from M.O. (Masonry Opening) for Unit Sizes. Masonry Openings above include Sill Nose, see Trim Options page for Sill Nose specifications. For other Trim Options refer to the Unit Sizing, Rough Opening & Masonry Openings page.

SCALE: 1/8" = 1'

**45° BAY UNIT WITH 20" FLANKERS**

M.O. BRICKMOULD M.O. ADAMS/FLAT CASING ROUGH OPENING FRAME SIZE DAYLIGHT OPENING	101 7/16" (2577) 104 1/2" (2654) 96 7/8" (2461) 97 11/16" (2481) 14" (356)[2] 58" (1473)	109 7/16" (2780) 112 1/2" (2858) 104 7/8" (2664) 105 11/16" (2684) 14" (356)[2] 66" (1676)
44 15/16" (1141) 46 1/2" (1181) 42" (1067) 41 1/2" (1054) 35 1/2" (901)		
TCC4Y6440-20	TCC4Y7240-20	
46 15/16" (1192) 48 1/2" (1232) 44" (1118) 43 1/2" (1105) 37 1/2" (952)		
TCC4Y6442-20	TCC4Y7242-20	
52 15/16" (1345) 54 1/2" (1384) 50" (1270) 49 1/2" (1257) 43 1/2" (1104)		
TCC4Y6448-20	TCC4Y7248-20	
58 15/16" (1497) 60 1/2" (1537) 56" (1422) 55 1/2" (1410) 49 1/2" (1256)		
TCC4Y6454-20	TCC4Y7254-20	
60 15/16" (1548) 62 1/2" (1588) 58" (1473) 57 1/2" (1448) 51 1/2" (1307)		
TCC4Y6456-20	TCC4Y7256-20	
64 15/16" (1649) 66 1/2" (1689) 62" (1575) 61 1/2" (1562) 55 1/2" (1409)		
TCC4Y6460-20	TCC4Y7260-20	
68 15/16" (1751) 70 1/2" (1791) 66" (1676) 65 1/2" (1664) 59 1/2" (1510)		
TCC4Y6464-20	TCC4Y7264-20	
70 15/16" (1802) 72 1/2" (1842) 68" (1727) 67 1/2" (1715) 61 1/2" (1561)		
TCC4Y6466-20	TCC4Y7266-20	
76 15/16" (1954) 78 1/2" (1994) 74" (1880) 73 1/2" (1867) 67 1/2" (1714)		
TCC4Y6472-20	TCC4Y7272-20	

**ELEVATION SYMBOL LEGEND:**  
M.O. = MASONRY OPENING  
VALUES IN ( ) ARE IN MILLIMETER CONVERSIONS  
VALUES IN [ ] ARE NUMBER OF DAYLIGHT OPENINGS PER UNIT

Note Elevations shown DO NOT have exterior trim. Subtract 3/4" (19) from M.O. (Masonry Opening) for Unit Sizes. Masonry Openings above include Sill Nose, see Trim Options page for Sill Nose specifications. For other Trim Options refer to the Unit Sizing, Rough Opening & Masonry Openings page.

SCALE: 1/8" = 1'

**45° BAY UNIT WITH 24" FLANKERS**

**M.O. BRICKMOULD**  
**M.O. ADAMS/FLAT CASING**  
**ROUGH OPENING**  
**FRAME SIZE**  
**DAYLIGHT OPENING**

73 1/16" (1856)  
76 1/8" (1934)  
68 1/2" (1740)  
69 5/16" (1761)  
18" (457)[2] 24" (610)

83 1/16" (2110)  
86 1/8" (2188)  
78 1/2" (1994)  
79 5/16" (2015)  
18" (457)[2] 34" (864)

91 1/16" (2313)  
94 1/8" (2391)  
86 1/2" (2197)  
87 5/16" (2218)  
18" (457)[2] 42" (1067)

99 1/16" (2516)  
102 1/8" (2594)  
94 1/2" (2400)  
95 5/16" (2421)  
18" (457)[2] 50" (1270)

103 1/16" (2618)  
106 1/8" (2696)  
98 1/2" (2502)  
99 5/16" (2523)  
18" (457)[2] 54" (1372)

36 15/16" (938)  
38 1/2" (978)  
34" (864)  
33 1/2" (851)  
27 1/2" (699)

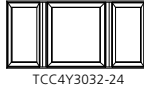

TCC4Y3032-24

40 15/16" (1040)  
42 1/2" (1080)  
38" (965)  
37 1/2" (953)  
31 1/2" (799)



TCC4Y3036-24

44 15/16" (1141)  
46 1/2" (1181)  
42" (1067)  
41 1/2" (1054)  
35 1/2" (901)

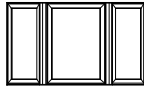

TCC4Y3040-24

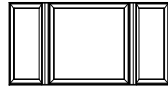

TCC4Y4040-24

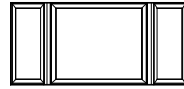

TCC4Y4840-24

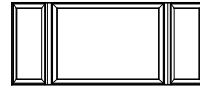

TCC4Y5640-24



TCC4Y6040-24

46 15/16" (1192)  
48 1/2" (1232)  
44" (1118)  
43 1/2" (1105)  
37 1/2" (952)

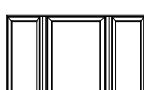

TCC4Y3042-24

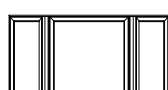

TCC4Y4042-24



TCC4Y4842-24



TCC4Y5642-24

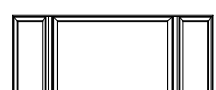

TCC4Y6042-24

52 15/16" (1345)  
54 1/2" (1384)  
50" (1270)  
49 1/2" (1257)  
43 1/2" (1104)

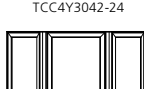

TCC4Y3048-24

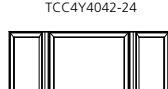

TCC4Y4048-24



TCC4Y4848-24

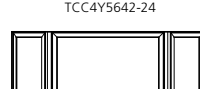

TCC4Y5648-24

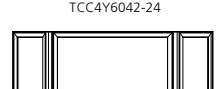

TCC4Y6048-24

58 15/16" (1497)  
60 1/2" (1537)  
56" (1423)  
55 1/2" (1410)  
49 1/2" (1256)



TCC4Y3054-24



TCC4Y4054-24



TCC4Y4854-24

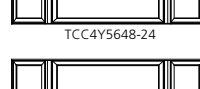

TCC4Y5654-24

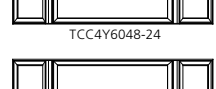

TCC4Y6054-24

60 15/16" (1548)  
62 1/2" (1588)  
58" (1473)  
57 1/2" (1460)  
51 1/2" (1307)



TCC4Y3056-24



TCC4Y4056-24



TCC4Y4856-24

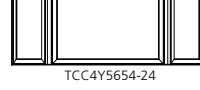

TCC4Y5656-24

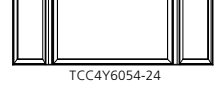

TCC4Y6056-24

64 15/16" (1649)  
66 1/2" (1689)  
62" (1575)  
61 1/2" (1562)  
55 1/2" (1409)

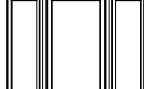

TCC4Y3060-24



TCC4Y4060-24



TCC4Y4860-24



TCC4Y5660-24



TCC4Y6060-24

68 15/16" (1751)  
70 1/2" (1791)  
66" (1676)  
65 1/2" (1664)  
59 1/2" (1510)



TCC4Y3064-24



TCC4Y4064-24



TCC4Y4864-24



TCC4Y5664-24

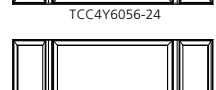

TCC4Y6064-24

70 15/16" (1802)  
72 1/2" (1842)  
68" (1727)  
67 1/2" (1715)  
61 1/2" (1561)



TCC4Y3066-24



TCC4Y4066-24



TCC4Y4866-24



TCC4Y5666-24

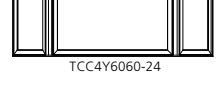

TCC4Y6066-24

76 15/16" (1954)  
78 1/2" (1994)  
74" (1880)  
73 1/2" (1867)  
67 1/2" (1714)

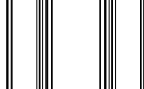

TCC4Y3072-24



TCC4Y4072-24



TCC4Y4872-24



TCC4Y5672-24



TCC4Y6072-24

**ELEVATION SYMBOL LEGEND:**  
M.O. = MASONRY OPENING  
VALUES IN ( ) ARE IN MILLIMETER CONVERSIONS  
VALUES IN [ ] ARE NUMBER OF DAYLIGHT OPENINGS PER UNIT

Note Elevations shown DO NOT have exterior trim. Subtract 3/4" (19) from M.O. (Masonry Opening) for Unit Sizes. Masonry Openings above include Sill Nose, see Trim Options page for Sill Nose specifications. For other Trim Options refer to the Unit Sizing, Rough Opening & Masonry Openings page.

SCALE: 1/8" = 1'

**45° BAY UNIT WITH 24" FLANKERS**

M.O. BRICKMOULD M.O. ADAMS/FLAT CASING ROUGH OPENING FRAME SIZE DAYLIGHT OPENING	107 1/16" (2719) 110 1/8" (2797) 102 1/2" (2604) 103 5/16" (2624) 18" (457)[2] 58" (1473)	115 1/16" (2923) 118 1/8" (3000) 110 1/2" (2807) 111 5/16" (2827) 18" (457)[2] 66" (1676)
44 15/16" (1141) 46 1/2" (1181) 42" (1067) 41 1/2" (1054) 35 1/2" (901)		
TCC4Y6440-24	TCC4Y7240-24	
46 15/16" (1192) 48 1/2" (1232) 44" (1118) 43 1/2" (1105) 37 1/2" (952)		
TCC4Y6442-24	TCC4Y7242-24	
52 15/16" (1345) 54 1/2" (1384) 50" (1270) 49 1/2" (1257) 43 1/2" (1104)		
TCC4Y6448-24	TCC4Y7248-24	
58 15/16" (1497) 60 1/2" (1537) 56" (1423) 55 1/2" (1410) 49 1/2" (1256)		
TCC4Y6454-24	TCC4Y7254-24	
60 15/16" (1548) 62 1/2" (1588) 58" (1473) 57 1/2" (1448) 51 1/2" (1307)		
TCC4Y6456-24	TCC4Y7256-24	
64 15/16" (1649) 66 1/2" (1689) 62" (1575) 61 1/2" (1562) 55 1/2" (1409)		
TCC4Y6460-24	TCC4Y7260-24	
68 15/16" (1751) 70 1/2" (1791) 66" (1676) 65 1/2" (1664) 59 1/2" (1510)		
TCC4Y6464-24	TCC4Y7264-24	
70 15/16" (1802) 72 1/2" (1842) 68" (1727) 67 1/2" (1715) 61 1/2" (1561)		
TCC4Y6466-24	TCC4Y7266-24	
76 15/16" (1954) 78 1/2" (1994) 74" (1880) 73 1/2" (1867) 67 1/2" (1714)		
TCC4Y6472-24	TCC4Y7272-24	

**ELEVATION SYMBOL LEGEND:**  
M.O. = MASONRY OPENING  
VALUES IN ( ) ARE IN MILLIMETER CONVERSIONS  
VALUES IN [ ] ARE NUMBER OF DAYLIGHT OPENINGS PER UNIT

Note Elevations shown DO NOT have exterior trim. Subtract 3/4" (19) from M.O. (Masonry Opening) for Unit Sizes. Masonry Openings above include Sill Nose, see Trim Options page for Sill Nose specifications. For other Trim Options refer to the Unit Sizing, Rough Opening & Masonry Openings page.

SCALE: 1/8" = 1'

#### 45° BAY UNIT WITH 28" FLANKERS











M.O. BRICKMOULD M.O. ADAMS/FLAT CASING ROUGH OPENING FRAME SIZE DAYLIGHT OPENING	78 3/4" (2000) 81 13/16" (2078) 74 3/16" (1884) 75" (1905) 22" (559) [2] 24" (610)	88 3/4" (2254) 91 13/16" (2332) 84 3/16" (2138) 85" (2159) 22" (559) [2] 34" (864)	96 3/4" (2457) 99 13/16" (2535) 92 3/16" (2342) 93" (2362) 22" (559) [2] 42" (1067)	104 3/4" (2661) 107 13/16" (2738) 100 3/16" (2545) 101" (2565) 22" (559) [2] 50" (1270)	108 3/4" (2762) 111 13/16" (2840) 104 3/16" (2646) 105" (2667) 22" (559) [2] 54" (1372)
36 15/16" (938) 38 1/2" (978) 34" (864)					
TCC4Y3032-28					
40 15/16" (1040) 42 1/2" (1080) 38" (965) 37 1/2" (953) 31 1/2" (799)					
TCC4Y3036-28					
44 15/16" (1141) 46 1/2" (1181) 42" (1067) 41 1/2" (1054) 35 1/2" (901)					
TCC4Y3040-28	TCC4Y4040-28	TCC4Y4840-28	TCC4Y5640-28	TCC4Y6040-28	
46 15/16" (1192) 48 1/2" (1232) 44" (1118) 43 1/2" (1105) 37 1/2" (952)					
TCC4Y3042-28	TCC4Y4042-28	TCC4Y4842-28	TCC4Y5642-28	TCC4Y6042-28	
52 15/16" (1345) 54 1/2" (1384) 50" (1270) 49 1/2" (1257) 43 1/2" (1104)					
TCC4Y3048-28	TCC4Y4048-28	TCC4Y4848-28	TCC4Y5648-28	TCC4Y6048-28	
58 15/16" (1497) 60 1/2" (1537) 56" (1422) 55 1/2" (1410) 49 1/2" (1256)					
TCC4Y3054-28	TCC4Y4054-28	TCC4Y4854-28	TCC4Y5654-28	TCC4Y6054-28	
60 15/16" (1548) 62 1/2" (1588) 58" (1473) 57 1/2" (1468) 51 1/2" (1307)					
TCC4Y3056-28	TCC4Y4056-28	TCC4Y4856-28	TCC4Y5656-28	TCC4Y6056-28	
64 15/16" (1649) 66 1/2" (1689) 62" (1575) 61 1/2" (1562) 55 1/2" (1409)					
TCC4Y3060-28	TCC4Y4060-28	TCC4Y4860-28	TCC4Y5660-28	TCC4Y6060-28	
68 15/16" (1751) 70 1/2" (1791) 66" (1676) 65 1/2" (1664) 59 1/2" (1510)					
TCC4Y3064-28	TCC4Y4064-28	TCC4Y4864-28	TCC4Y5664-28	TCC4Y6064-28	
70 15/16" (1802) 72 1/2" (1842) 68" (1727) 67 1/2" (1715) 61 1/2" (1561)					
TCC4Y3066-28	TCC4Y4066-28	TCC4Y4866-28	TCC4Y5666-28	TCC4Y6066-28	
76 15/16" (1954) 78 1/2" (1994) 74" (1880) 73 1/2" (1867) 67 1/2" (1714)					
TCC4Y3072-28	TCC4Y4072-28	TCC4Y4872-28	TCC4Y5672-28	TCC4Y6072-28	

**ELEVATION SYMBOL LEGEND:**  
**M.O.** = MASONRY OPENING  
 VALUES IN ( ) ARE IN MILLIMETER CONVERSIONS  
 VALUES IN [ ] ARE NUMBER OF DAYLIGHT OPENINGS PER UNIT  
 E BASIC UNIT CLEAR OPENING EXCEEDS 20" IN WIDTH, 24" IN HEIGHT & A MINIMUM OF 5.7 SQ. FT.

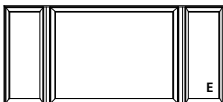
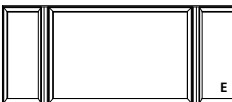
Note Elevations shown DO NOT have exterior trim. Subtract 3/4" (19) from M.O. (Masonry Opening) for Unit Sizes. Masonry Openings above include Sill Nose, see Trim Options page for Sill Nose specifications. For other Trim Options refer to the Unit Sizing, Rough Opening & Masonry Openings page.

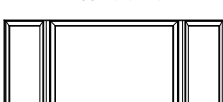
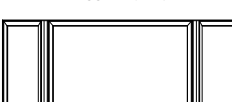
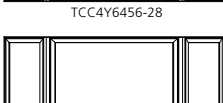
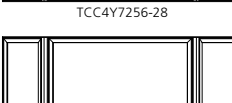
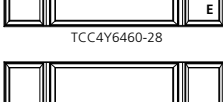
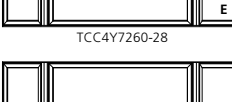
SCALE: 1/8" = 1'

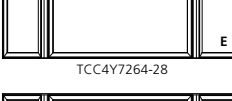
**45° BAY UNIT WITH 28" FLANKERS**

M.O. BRICKMOULD M.O. ADAMS/FLAT CASING ROUGH OPENING FRAME SIZE DAYLIGHT OPENING	112 3/4"(2864) 115 13/16"(2942) 108 3/16"(2748) 109"(2769) 22"(559)[2] 58"(1473)	120 3/4"(3067) 123 13/16"(3145) 116 3/16"(2951) 117"(2972) 22"(559)[2] 66"(1676)
44 15/16"(1141) 46 1/2"(1181) 42"(1067) 41 1/2"(1054) 35 1/2"(901)		
	TCC4Y6440-28	TCC4Y7240-28
46 15/16"(1192) 48 1/2"(1232) 44"(1118) 43 1/2"(1105) 37 1/2"(952)		
	TCC4Y6442-28	TCC4Y7242-28
52 15/16"(1345) 54 1/2"(1384) 50"(1270) 49 1/2"(1257) 43 1/2"(1104)		
	TCC4Y6448-28	TCC4Y7248-28
58 15/16"(1497) 60 1/2"(1537) 56"(1422) 55 1/2"(1410) 49 1/2"(1256)		
	TCC4Y6454-28	TCC4Y7254-28
60 15/16"(1548) 62 1/2"(1588) 58"(1473) 57 1/2"(1468) 51 1/2"(1307)		
	TCC4Y6456-28	TCC4Y7256-28
64 15/16"(1649) 66 1/2"(1689) 62"(1575) 61 1/2"(1562) 55 1/2"(1409)		
	TCC4Y6460-28	TCC4Y7260-28
68 15/16"(1751) 70 1/2"(1791) 66"(1676) 65 1/2"(1664) 59 1/2"(1510)		
	TCC4Y6464-28	TCC4Y7264-28
70 15/16"(1802) 72 1/2"(1842) 68"(1727) 67 1/2"(1715) 61 1/2"(1561)		
	TCC4Y6466-28	TCC4Y7266-28
76 15/16"(1954) 78 1/2"(1994) 74"(1880) 73 1/2"(1867) 67 1/2"(1714)		
	TCC4Y6472-28	TCC4Y7272-28

**ELEVATION SYMBOL LEGEND:**  
**M.O.** = MASONRY OPENING  
 VALUES IN ( ) ARE IN MILLIMETER CONVERSIONS  
 VALUES IN [ ] ARE NUMBER OF DAYLIGHT OPENINGS PER UNIT  
 E BASIC UNIT CLEAR OPENING EXCEEDS 20" IN WIDTH, 24" IN HEIGHT & A MINIMUM OF 5.7 SQ. FT.

Note Elevations shown DO NOT have exterior trim. Subtract 3/4" (19) from M.O. (Masonry Opening) for Unit Sizes. Masonry Openings above include Sill Nose, see Trim Options page for Sill Nose specifications. For other Trim Options refer to the Unit Sizing, Rough Opening & Masonry Openings page.

SCALE: 1/8" = 1'

#### 4-WIDE BOW UNITS

M.O. BRICKMOULD M.O. ADAMS/FLAT CASING ROUGH OPENING FRAME SIZE DAYLIGHT OPENING	72 5/8"(1844) 75 1/2"(1918) 68 13/16"(1748) 68 11/16"(1745) 11"(279)[4]	84 3/16"(2138) 87 1/4"(2216) 80 9/16"(2046) 80 7/16"(2043) 14"(356)[4]	99 7/8"(2537) 102 15/16"(2615) 96 1/4"(2445) 96 1/8"(2442) 18"(457)[4]	115 5/8"(2937) 118 11/16"(3015) 112"(2845) 111 7/8"(2841) 22"(559)[4]	123 7/16"(3135) 126 1/2"(3213) 119 13/16"(3043) 119 11/16"(3040) 24"(610)[4]
40 6 1/64"(1040) 42 3 1/64"(1079) 38"(965) 37 1/2"(953) 31 1/2"(799)					
44 6 1/64"(1142) 46 3 1/64"(1181) 42"(1067) 41 1/2"(1054) 35 1/2"(901)					
46 6 1/64"(1192) 48 3 1/64"(1231) 44"(1118) 43 1/2"(1105) 37 1/2"(952)					
52 6 1/64"(1345) 54 3 1/64"(1383) 50"(1270) 49 1/2"(1257) 43 1/2"(1104)					
58 6 1/64"(1497) 60 3 1/64"(1536) 56"(1422) 55 1/2"(1410) 49 1/2"(1256)					
60 6 1/64"(1548) 62 3 1/64"(1587) 58"(1473) 57 1/2"(1468) 51 1/2"(1307)					
64 6 1/64"(1649) 68 3 1/64"(1739) 62"(1575) 61 1/2"(1562) 55 1/2"(1409)					
68 6 1/64"(1751) 70 3 1/64"(1790) 66"(1676) 65 1/2"(1664) 59 1/2"(1510)					
70 6 1/64"(1802) 72 3 1/64"(1841) 68"(1727) 67 1/2"(1715) 61 1/2"(1561)					
76 6 1/64"(1955) 78 3 1/64"(1993) 74"(1880) 73 1/2"(1867) 67 1/2"(1714)					

**ELEVATION SYMBOL LEGEND:**  
**M.O.** = MASONRY OPENING  
 VALUES IN ( ) ARE IN MILLIMETER CONVERSIONS  
 VALUES IN [ ] ARE NUMBER OF DAYLIGHT OPENINGS PER UNIT  
 E BASIC UNIT CLEAR OPENING EXCEEDS 20" IN WIDTH, 24" IN HEIGHT & A MINIMUM OF 5.7 SQ. FT.

Note Elevations shown DO NOT have exterior trim. Subtract 3/4" (19) from M.O. (Masonry Opening) for Unit Sizes. Masonry Openings above include Sill Nose, see Trim Options page for Sill Nose specifications. For other Trim Options refer to the Unit Sizing, Rough Opening & Masonry Openings page.

SCALE: 1/8" = 1'

**5-WIDE BOW UNITS**

M.O. BRICKMOULD M.O. ADAMS/FLAT CASING ROUGH OPENING FRAME SIZE DAYLIGHT OPENING	88 13/16"(2256) 91 7/8"(2334) 85"(2159) 85 1/16"(2161) 11"(279)[5]	103 5/16"(2624) 106 3/8"(2702) 99 1/2"(2527) 99 9/16"(2529) 14"(356)[5]	122 3/4"(3118) 125 13/16"(3196) 118 15/16"(3021) 119"(3023) 18"(457)[5]	142 1/8"(3610) 145 3/16"(3688) 138 5/16"(3513) 138 3/8"(3515) 22"(559)[5]
40 6 1/64"(1040) 42 3 1/64"(1079) 38"(965) 37 1/2"(953) 31 1/2"(799)				
TCC5W1736	TCC5W2036	TCC5W2436	TCC5W2836	
44 6 1/64"(1142) 46 3 1/64"(1181) 42"(1067) 41 1/2"(1054) 35 1/2"(901)				
TCC5W1740	TCC5W2040	TCC5W2440	TCC5W2840	
46 6 1/64"(1192) 48 3 1/64"(1231) 44"(1118) 43 1/2"(1105) 37 1/2"(952)				
TCC5W1742	TCC5W2042	TCC5W2442	TCC5W2842	
52 6 1/64"(1345) 54 3 1/64"(1383) 50"(1270) 49 1/2"(1257) 43 1/2"(1104)				
TCC5W1748	TCC5W2048	TCC5W2448	TCC5W2848	E
58 6 1/64"(1497) 60 3 1/64"(1536) 56"(1422) 55 1/2"(1410) 49 1/2"(1256)				
TCC5W1754	TCC5W2054	TCC5W2454	TCC5W2854	E
60 6 1/64"(1548) 62 3 1/64"(1587) 58"(1473) 57 1/2"(1448) 51 1/2"(1307)				
TCC5W1756	TCC5W2056	TCC5W2456	TCC5W2856	E
64 6 1/64"(1649) 66 3 1/64"(1739) 62"(1575) 61 1/2"(1562) 55 1/2"(1409)				
TCC5W1760	TCC5W2060	TCC5W2460	TCC5W2860	E
68 6 1/64"(1751) 70 3 1/64"(1790) 66"(1676) 65 1/2"(1664) 59 1/2"(1510)				
TCC5W1764	TCC5W2064	TCC5W2464	TCC5W2864	E
70 6 1/64"(1802) 72 3 1/64"(1841) 68"(1727) 67 1/2"(1715) 61 1/2"(1561)				
TCC5W1766	TCC5W2066	TCC5W2466	TCC5W2866	E
76 6 1/64"(1955) 78 3 1/64"(1993) 74"(1880) 73 1/2"(1867) 67 1/2"(1714)				
TCC5W1772	TCC5W2072	TCC5W2472	TCC5W2872	E

**ELEVATION SYMBOL LEGEND:**  
**M.O.** = MASONRY OPENING  
 VALUES IN ( ) ARE IN MILLIMETER CONVERSIONS  
 VALUES IN [ ] ARE NUMBER OF DAYLIGHT OPENINGS PER UNIT  
 E BASIC UNIT CLEAR OPENING EXCEEDS 20" IN WIDTH, 24" IN HEIGHT & A MINIMUM OF 5.7 SQ. FT.

Note Elevations shown DO NOT have exterior trim. Subtract 3/4" (19) from M.O. (Masonry Opening) for Unit Sizes. Masonry Openings above include Sill Nose, see Trim Options page for Sill Nose specifications. For other Trim Options refer to the Unit Sizing, Rough Opening & Masonry Openings page.

SCALE: 1/8" = 1'



**5-WIDE BOW UNITS**

<b>M.O. BRICKMOULD</b>	151 13/16" (3856)
<b>M.O. ADAMS/FLAT CASING</b>	154 7/8" (3934)
<b>ROUGH OPENING</b>	148" (3759)
<b>FRAME SIZE</b>	148 1/16" (3761)
<b>DAYLIGHT OPENING</b>	24" (610) [5]

40 61/64" (1040) 42 31/64" (1079) 38" (965) 37 1/2" (953) 31 1/2" (799)	
TCC5W3036	
44 61/64" (1142) 46 31/64" (1181) 42" (1067) 41 1/2" (1054) 35 1/2" (901)	
TCC5W3040	
46 61/64" (1192) 48 31/64" (1231) 44" (1118) 43 1/2" (1105) 37 1/2" (952)	
TCC5W3042	
52 61/64" (1345) 54 31/64" (1383) 50" (1270) 49 1/2" (1257) 43 1/2" (1104)	
TCC5W3048	
58 61/64" (1497) 60 31/64" (1536) 56" (1422) 55 1/2" (1410) 49 1/2" (1256)	
TCC5W3054	
60 61/64" (1548) 62 31/64" (1587) 58" (1473) 57 1/2" (1448) 51 1/2" (1307)	
TCC5W3056	
64 61/64" (1649) 68 31/64" (1739) 62" (1575) 61 1/2" (1562) 55 1/2" (1409)	
TCC5W3060	
68 61/64" (1751) 70 31/64" (1790) 66" (1676) 65 1/2" (1664) 59 1/2" (1510)	
TCC5W3064	
70 61/64" (1802) 72 31/64" (1841) 68" (1727) 67 1/2" (1715) 61 1/2" (1561)	
TCC5W3066	
76 61/64" (1955) 78 31/64" (1993) 74" (1880) 73 1/2" (1867) 67 1/2" (1714)	
TCC5W3072	

**ELEVATION SYMBOL LEGEND:**  
**M.O.** = MASONRY OPENING  
 VALUES IN ( ) ARE IN MILLIMETER CONVERSIONS  
 VALUES IN [ ] ARE NUMBER OF DAYLIGHT OPENINGS PER UNIT  
**E** BASIC UNIT CLEAR OPENING EXCEEDS 20" IN WIDTH, 24" IN HEIGHT & A MINIMUM OF 5.7 SQ. FT.

Note Elevations shown DO NOT have exterior trim. Subtract 3/4" (19) from M.O. (Masonry Opening) for Unit Sizes. Masonry Openings above include Sill Nose, see Trim Options page for Sill Nose specifications. For other Trim Options refer to the Unit Sizing, Rough Opening & Masonry Openings page.

SCALE: 1/8" = 1'

**6-WIDE BOW UNITS**

**M.O. BRICKMOULD**  
**M.O. ADAMS/FLAT CASING**  
**ROUGH OPENING**  
**FRAME SIZE**  
**DAYLIGHT OPENING**

104 1/2"(2654)  
107 9/16"(2732)  
101"(2565)  
100 3/4"(2559)  
11"(279)[6]

121 11/16"(3090)  
124 3/4"(3169)  
118 1/4"(3004)  
117 15/16"(2996)  
14"(356)[6]

144 11/16"(3675)  
147 3/4"(3753)  
141 1/4"(3588)  
140 15/16"(3580)  
18"(457)[6]

167 5/8"(4258)  
170 11/16"(4335)  
164 1/8"(4169)  
163 7/8"(4162)  
22"(559)[6]

40 51/64"(1040)  
42 3/64"(1079)  
37 1/2"(953)  
31 1/2"(799)



TCC6W1736

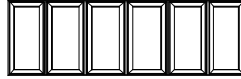

TCC6W2036

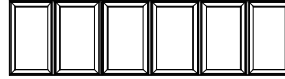

TCC6W2436

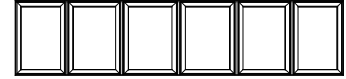

TCC6W2836

44 51/64"(1142)  
46 3/64"(1181)  
41 1/2"(1054)  
35 1/2"(901)



TCC6W1740

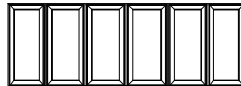

TCC6W2040

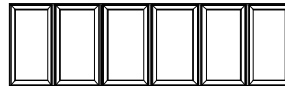

TCC6W2440

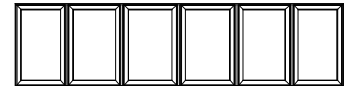

TCC6W2840

46 51/64"(1192)  
48 3/64"(1231)  
43 1/2"(1105)  
37 1/2"(952)

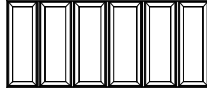

TCC6W1742

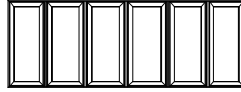

TCC6W2042

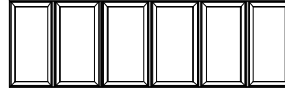

TCC6W2442

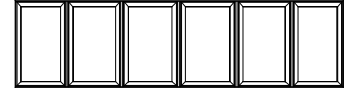

TCC6W2842

52 51/64"(1345)  
54 3/64"(1385)  
49 1/2"(1257)  
43 1/2"(1104)

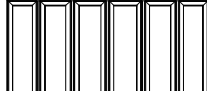

TCC6W1748

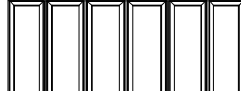

TCC6W2048



TCC6W2448

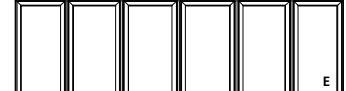

TCC6W2848

58 51/64"(1497)  
60 3/64"(1536)  
55 1/2"(1410)  
49 1/2"(1256)

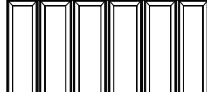

TCC6W1754

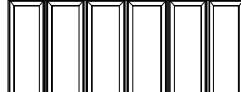

TCC6W2054



TCC6W2454

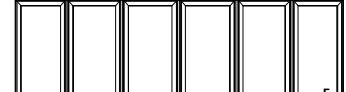

TCC6W2854

60 51/64"(1548)  
62 3/64"(1587)  
57 1/2"(1448)  
51 1/2"(1307)

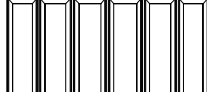

TCC6W1756

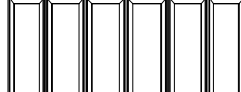

TCC6W2056

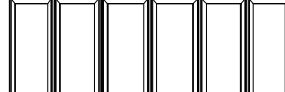

TCC6W2456

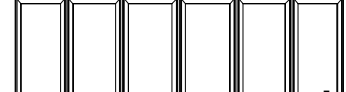

TCC6W2856

64 51/64"(1649)  
66 3/64"(1689)  
61 1/2"(1563)  
55 1/2"(1409)

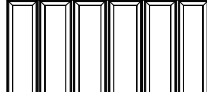

TCC6W1760

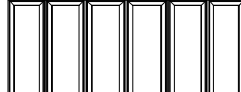

TCC6W2060



TCC6W2460

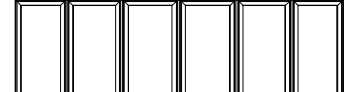

TCC6W2860

68 51/64"(1751)  
70 3/64"(1790)  
65 1/2"(1664)  
59 1/2"(1510)

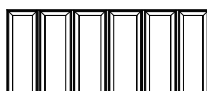

TCC6W1764

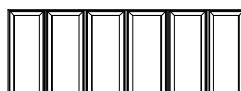

TCC6W2064

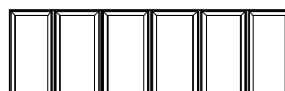

TCC6W2464

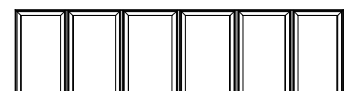

TCC6W2864

70 51/64"(1802)  
72 3/64"(1841)  
67 1/2"(1715)  
61 1/2"(1561)



TCC6W1766



TCC6W2066



TCC6W2466

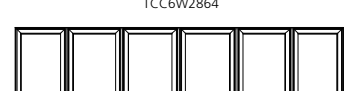

TCC6W2866

76 51/64"(1955)  
78 3/64"(1993)  
73 1/2"(1867)  
67 1/2"(1714)



TCC6W1772



TCC6W2072



TCC6W2472



TCC6W2872

**ELEVATION SYMBOL LEGEND:**

**M.O.** = MASONRY OPENING  
VALUES IN ( ) ARE IN MILLIMETER CONVERSIONS  
VALUES IN [ ] ARE NUMBER OF DAYLIGHT OPENINGS PER UNIT  
**E** BASIC UNIT CLEAR OPENING EXCEEDS 20" IN WIDTH, 24" IN HEIGHT & A MINIMUM OF 5.7 SQ. FT.

Note Elevations shown DO NOT have exterior trim. Subtract 3/4" (19) from M.O. (Masonry Opening) for Unit Sizes. Masonry Openings above include Sill Nose, see Trim Options page for Sill Nose specifications. For other Trim Options refer to the Unit Sizing, Rough Opening & Masonry Openings page.

SCALE: 1/8" = 1'

**6-WIDE BOW UNITS**

**M.O. BRICKMOULD**  
**M.O. ADAMS/FLAT CASING**  
**ROUGH OPENING**  
**FRAME SIZE**  
**DAYLIGHT OPENING**

179 1/16"(4548)  
182 1/8"(4626)  
175 9/16"(4459)  
175 5/16"(4453)  
24"(610)[6]

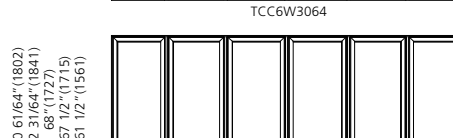
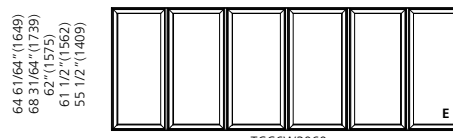
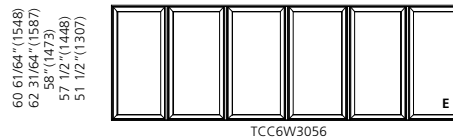
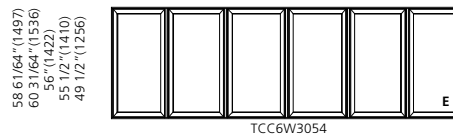
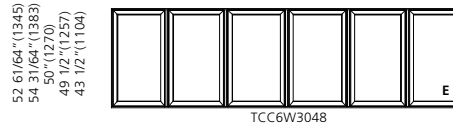
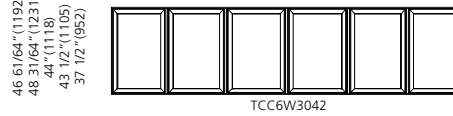
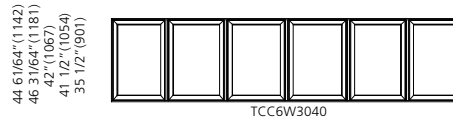
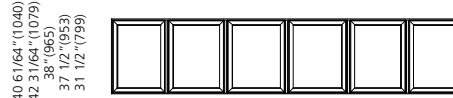

**ELEVATION SYMBOL LEGEND:**  
**M.O.** = MASONRY OPENING  
 VALUES IN ( ) ARE IN MILLIMETER CONVERSIONS  
 VALUES IN [ ] ARE NUMBER OF DAYLIGHT OPENINGS PER UNIT  
**E** BASIC UNIT CLEAR OPENING EXCEEDS 20" IN WIDTH, 24" IN HEIGHT & A MINIMUM OF 5.7 SQ. FT.

Note Elevations shown DO NOT have exterior trim. Subtract 3/4" (19) from M.O. (Masonry Opening) for Unit Sizes. Masonry Openings above include Sill Nose, see Trim Options page for Sill Nose specifications. For other Trim Options refer to the Unit Sizing, Rough Opening & Masonry Openings page.

SCALE: 1/8" = 1'

**GLAZING OPTIONS**

**INTERIOR GLAZED**

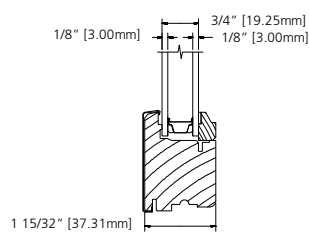

**INSULATED GLASS**

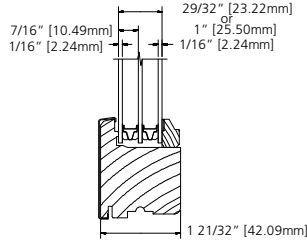

**TRIPLE GLAZE INSULATED**

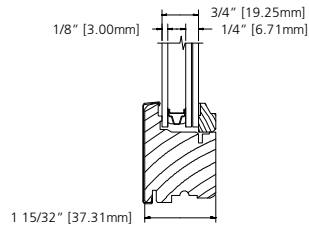

**LAMINATED INSULATED  
CLEAR OR LOW-E**  
3.0mm//6.7mm LAMINATE

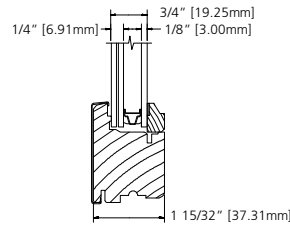

**LAMINATED INSULATED  
TINTED**  
6.7mm LAMINATE//3.0mm

SCALE: 3" = 1'

**TRIM OPTIONS**

**EXTERIOR TRIM**

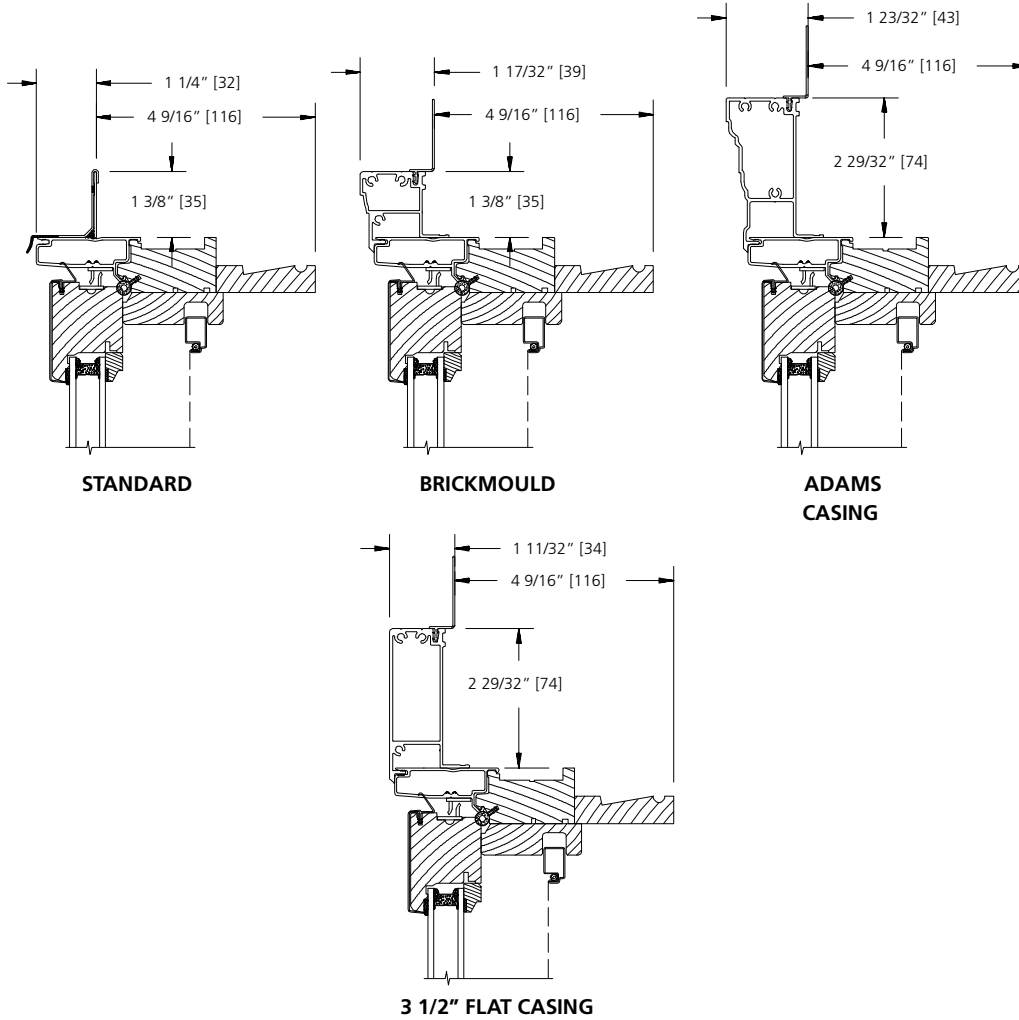

**SILL NOSE OPTIONS**

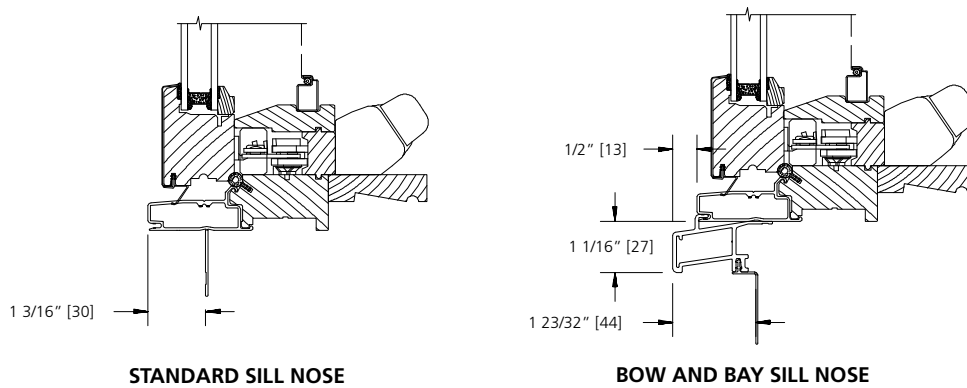

SCALE: 3" = 1'

**JAMB EXTENDER OPTIONS**

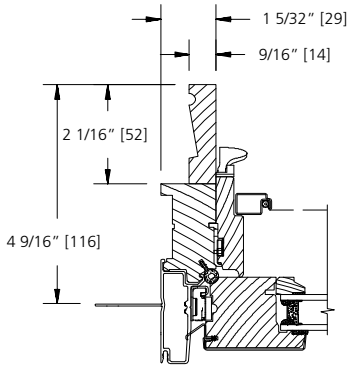

**4 9/16" WALL  
9/16" JAMB THICKNESS OPTION**

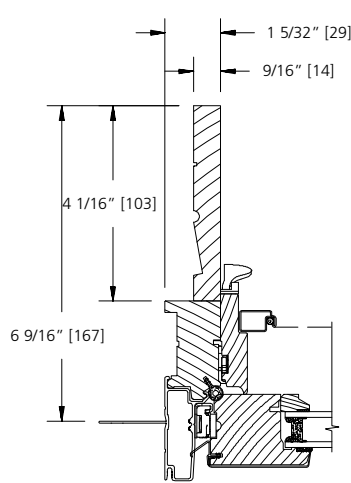

**6 9/16" WALL**

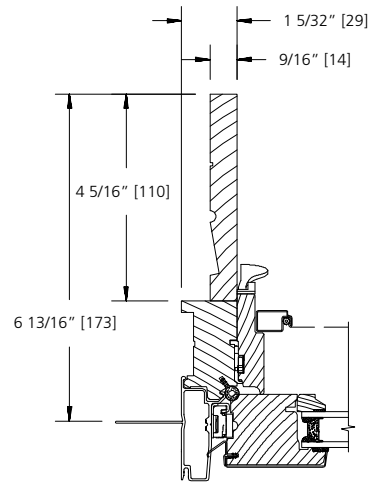

**6 13/16" WALL**

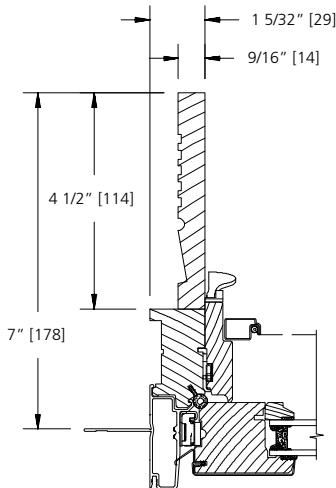

**7" WALL**

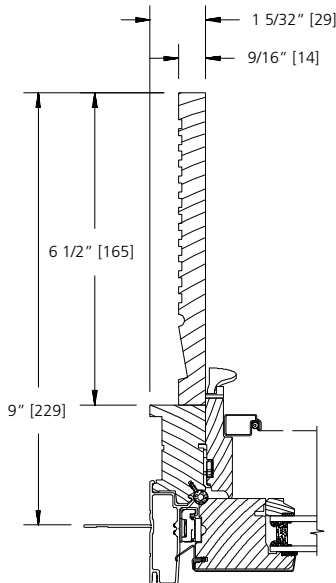

**9" WALL**

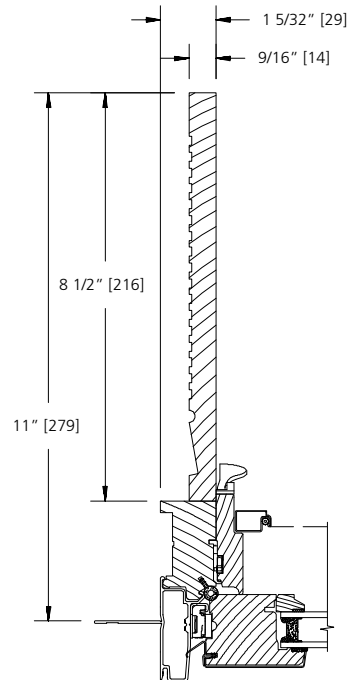

**11" WALL**

SCALE: 3" = 1'

STANDARD MULLION OPTIONS

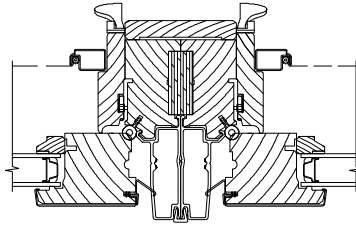

TWIN OPERATING CASEMENT

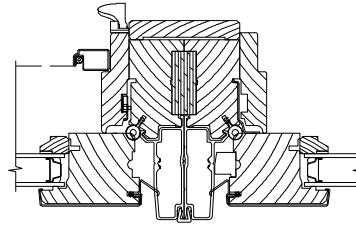

OPERATING CASEMENT  
NEXT TO CASEMENT PICTURE

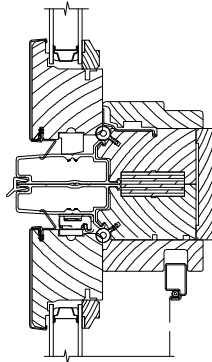

CASEMENT PICTURE  
OVER CASEMENT

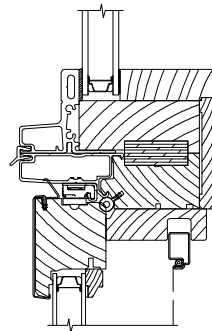

DIRECT SET RADIUS  
OVER CASEMENT

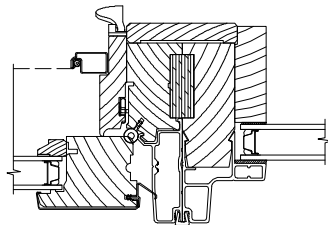

CASEMENT NEXT TO  
DIRECT SET

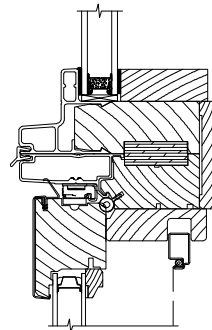

DIRECT SET GEOMETRIC  
OVER CASEMENT

STANDARD MULLION OPTIONS

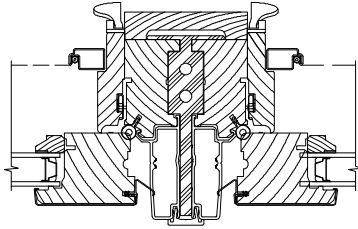

**1/4" ALUMINUM REINFORCEMENT**

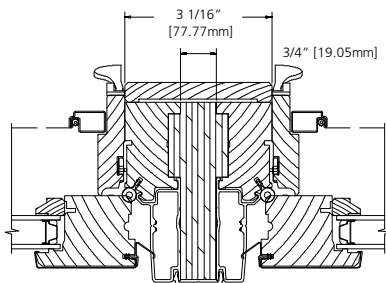

**3/4" WOOD SPREAD MULLION**

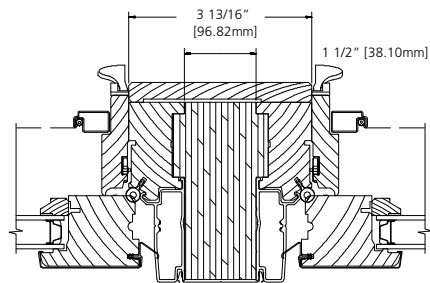

**1 1/2" WOOD SPREAD MULLION**

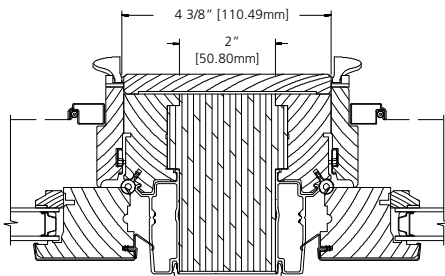

**2" WOOD SPREAD MULLION**

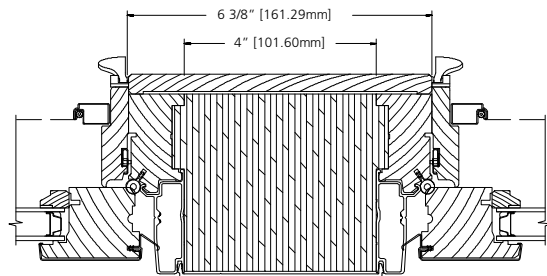

**4" WOOD SPREAD MULLION**



**LITE CUT INFORMATION**

Clad casement windows are available with removable grilles in 7/8", 1-1/8" and 1-3/8" widths, Airspace (between the panes) grilles, and Simulated Divided Lites. Standard lite cuts are rectangular.

**LITE CUT OPTIONS**

Special lite cut patterns can include a wide variety of straight line and radius patterns. The illustrations shown here represent just a few of the possibilities. Rectangular, horizontal, vertical and Prairie lite patterns are available in all standard size clad casement windows. Uneven, diamond, radius and Gothic lite cuts are available, subject to approval. Approvals are based on the ability to fulfill the design requirement while maintaining the construction integrity of the finished product.

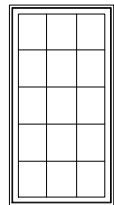

RECTANGULAR

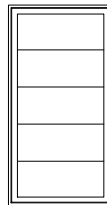

HORIZONTAL



PRAIRIE

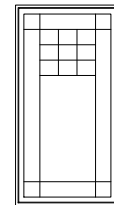

UNEVEN

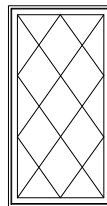

DIAMOND  
SDL ONLY

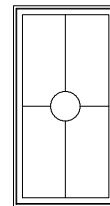

RADIUS

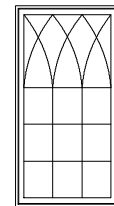

GOTHIC  
SDL ONLY

**BAR ALIGNMENT**

Alignment of divided lite muntin bars from one window to the next is often required by fine architectural design. Wood grilles, GBG (Grilles between the Glass), and Simulated Divided Lites may be specified with muntin bars aligned.

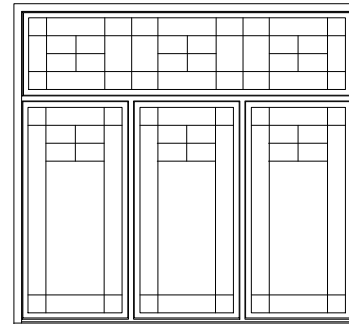

**DIVIDED LITE OPTIONS**  
**DIRECT SET**

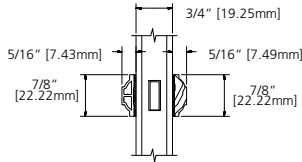

**7/8" SDL**

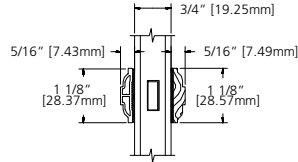

**1 1/8" SDL**

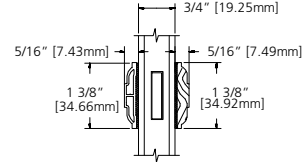

**1 3/8" SDL**

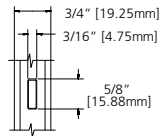

**5/8" GRILLE**

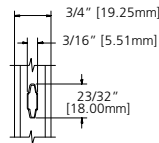

**23/32" GRILLE**

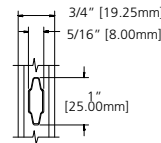

**1" GRILLE**

**UNIT SIZING, ROUGH OPENINGS  
& MASONRY OPENINGS**

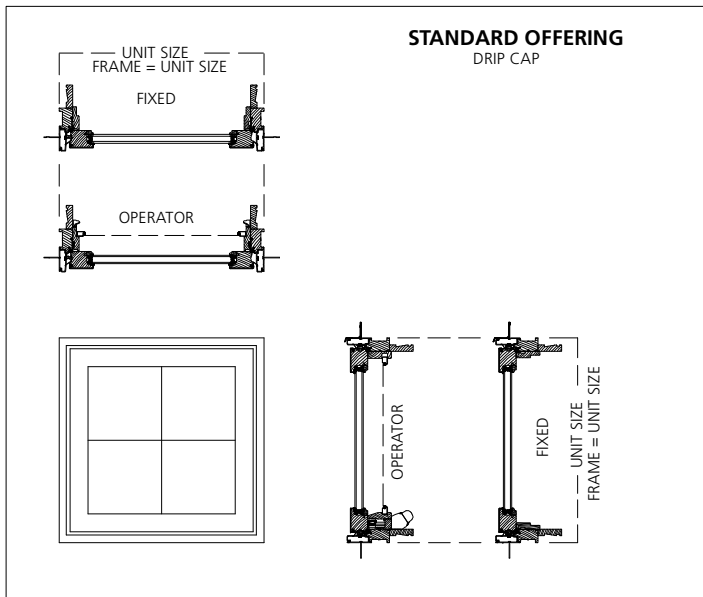

**MASONRY OPENING:**  
MASONRY OPENING IS ALWAYS 3/4" OVER  
THE UNIT SIZE OF THE WINDOW

**ROUGH OPENING:**  
ROUGH OPENING IS ALWAYS 3/4" OVER  
FRAME SIZE OF THE WINDOW

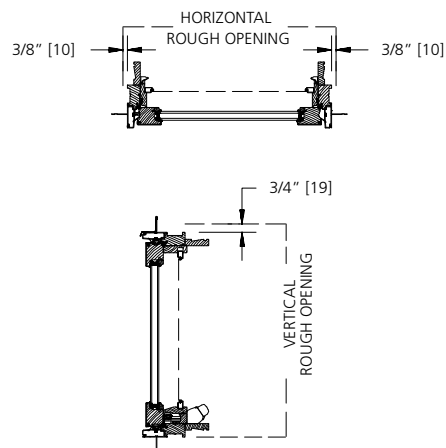

**NON-STANDARD UNIT SIZING**  
EXTERIOR TRIM OFFERINGS

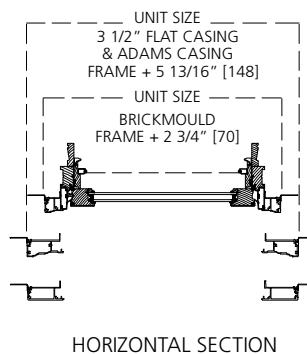
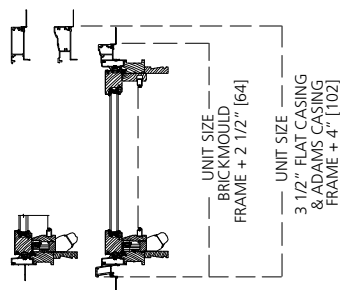

**FRAME TO TRIM  
DIMENSIONS**

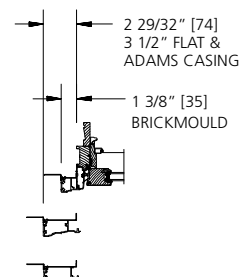

TYPICAL FOR HEAD, SILL & SIDE

**OPERATING UNIT**

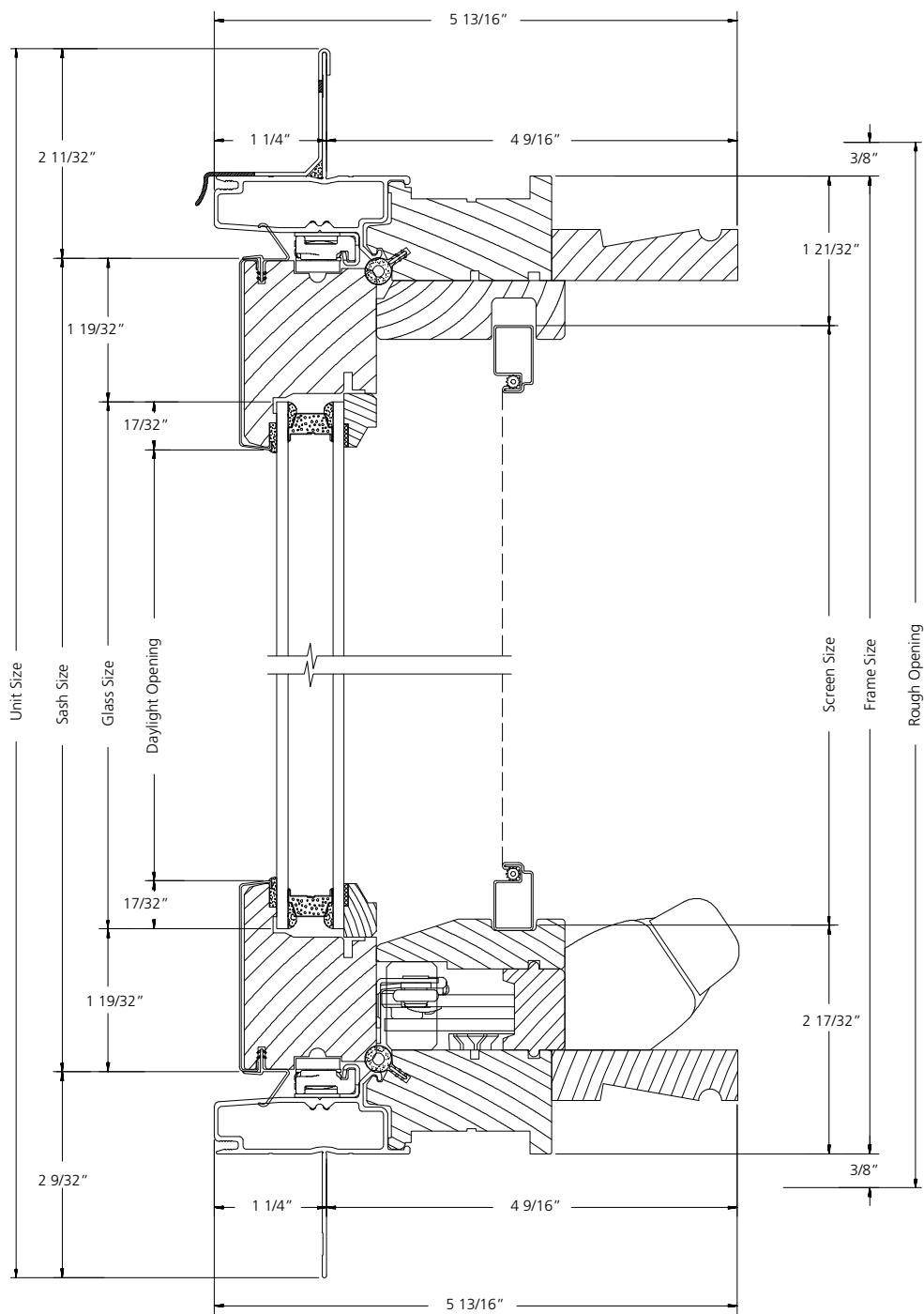

**VERTICAL SECTION**

SCALE: 6" = 1'

**OPERATING UNIT**

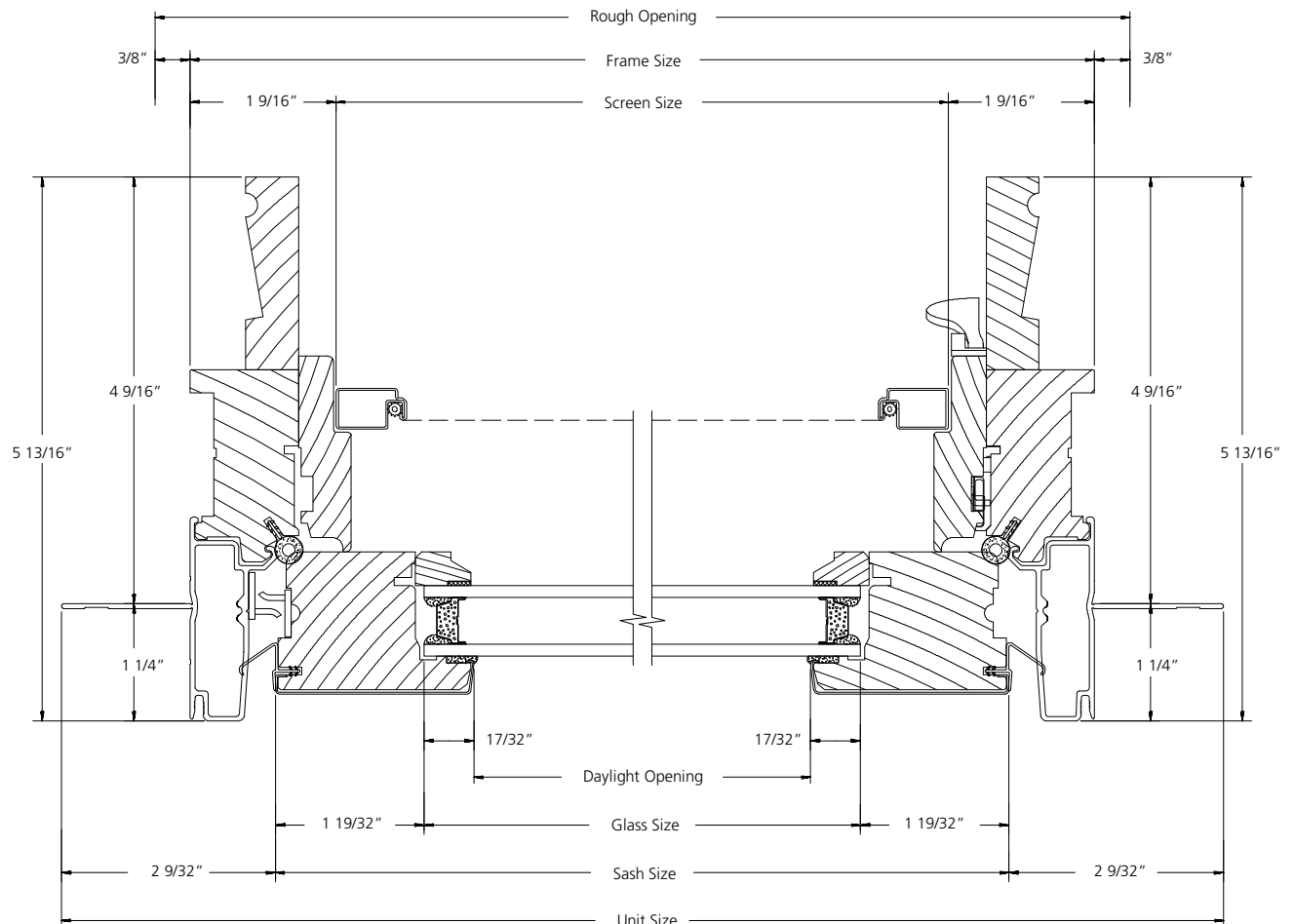

**HORIZONTAL SECTION**

SCALE: 6" = 1'

**OPERATING/OPERATING  
TWIN UNIT**

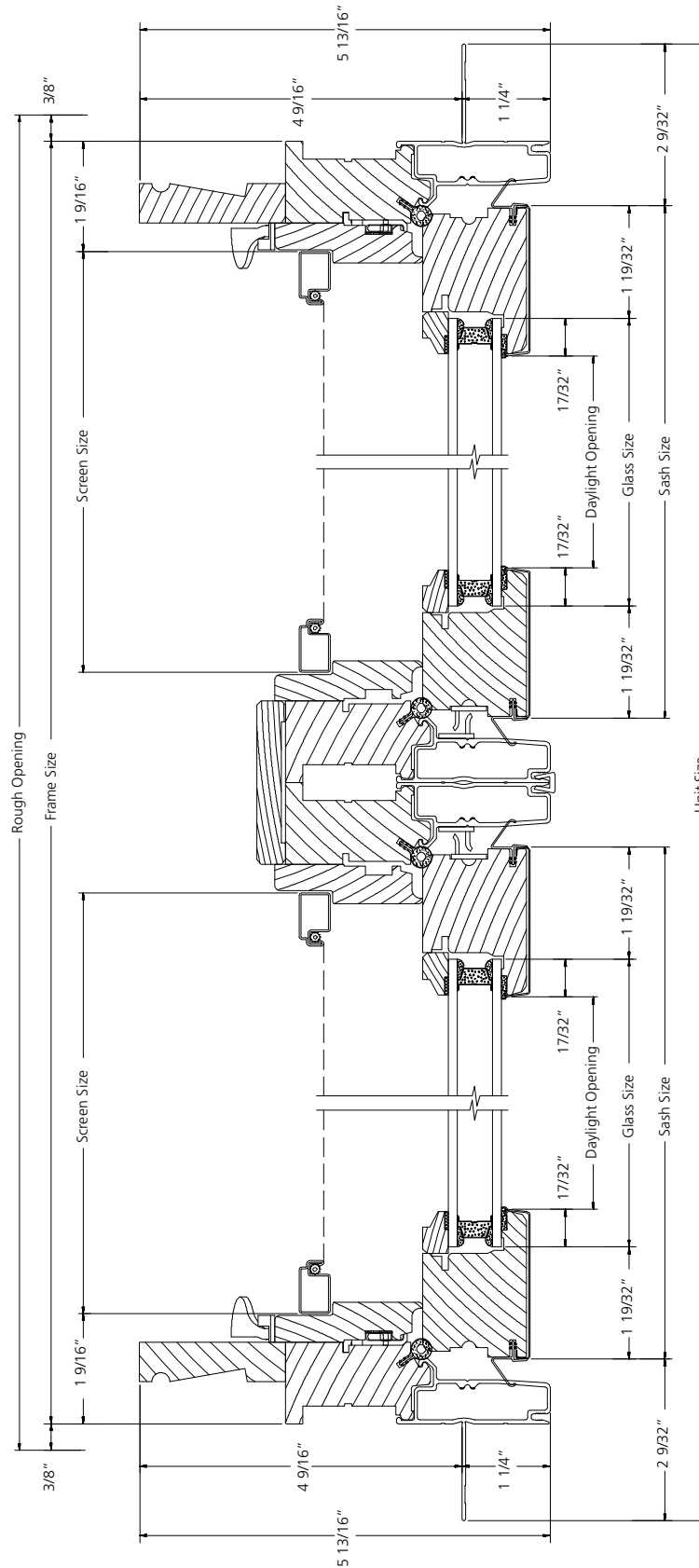

**HORIZONTAL SECTION**

SCALE: 6" = 1'

**OPERATING/STATIONARY  
COMBINATION UNIT**

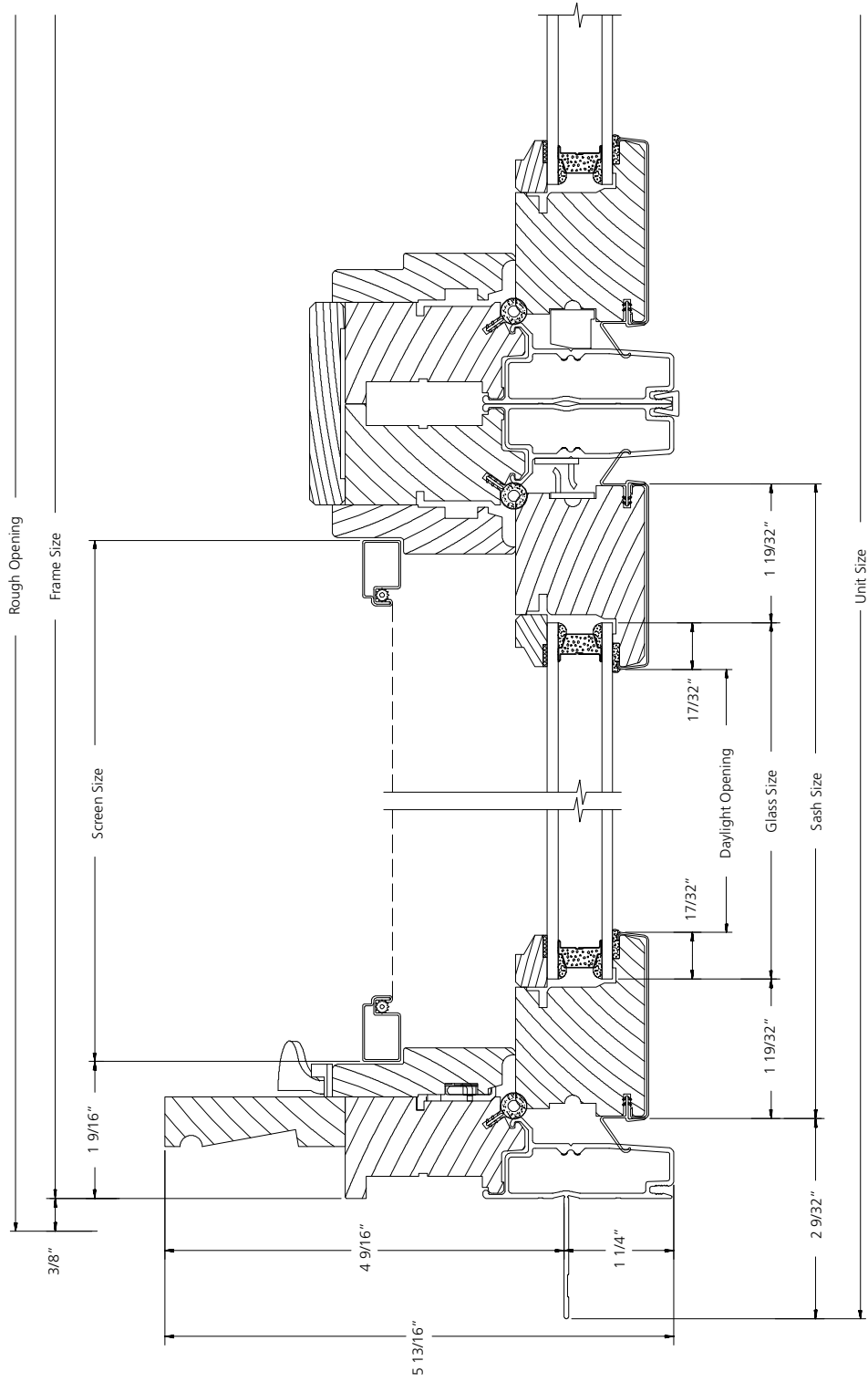

**HORIZONTAL SECTION**

SCALE: 6" = 1'

PICTURE UNIT

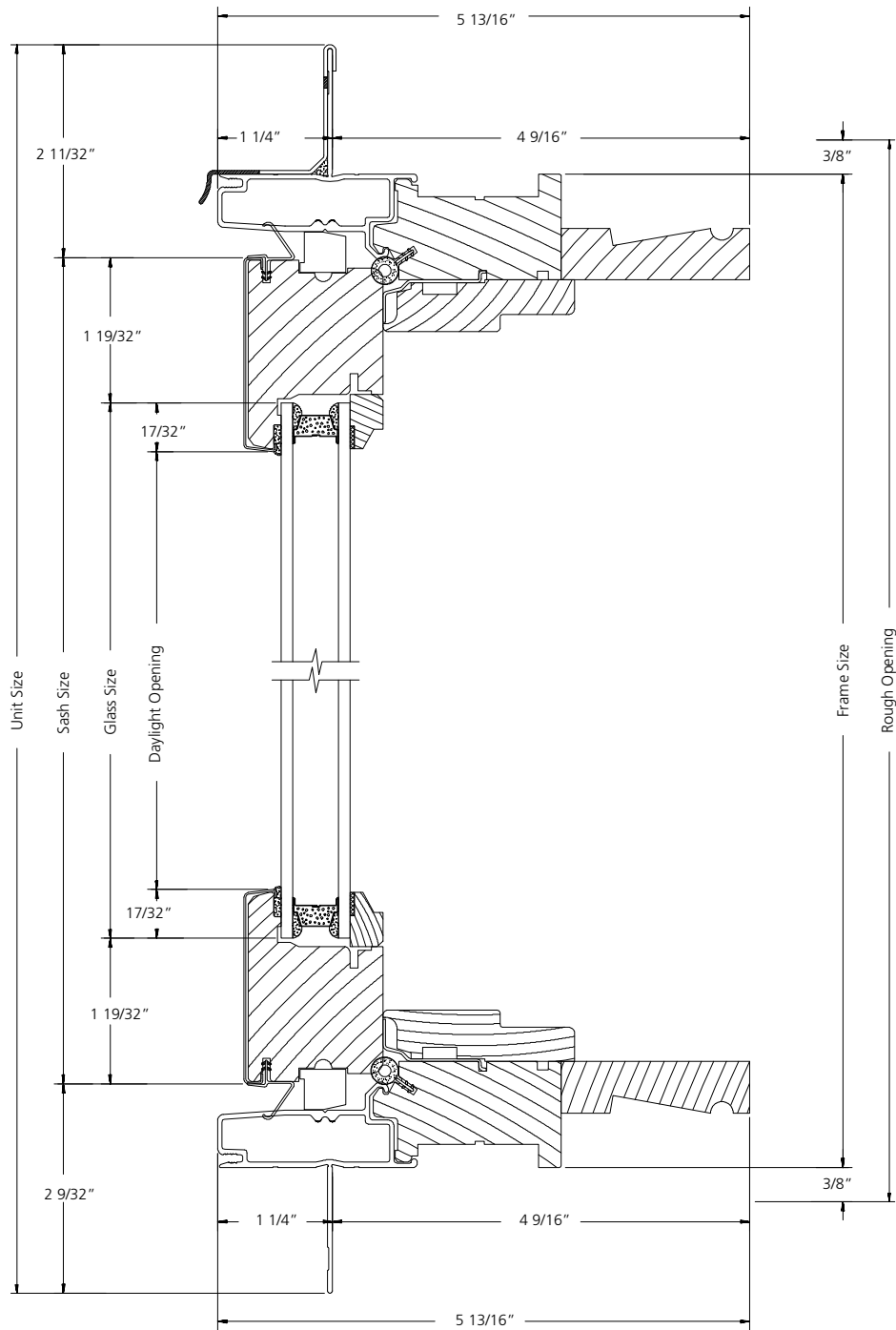

VERTICAL SECTION

SCALE: 6" = 1'



**PICTURE UNIT**

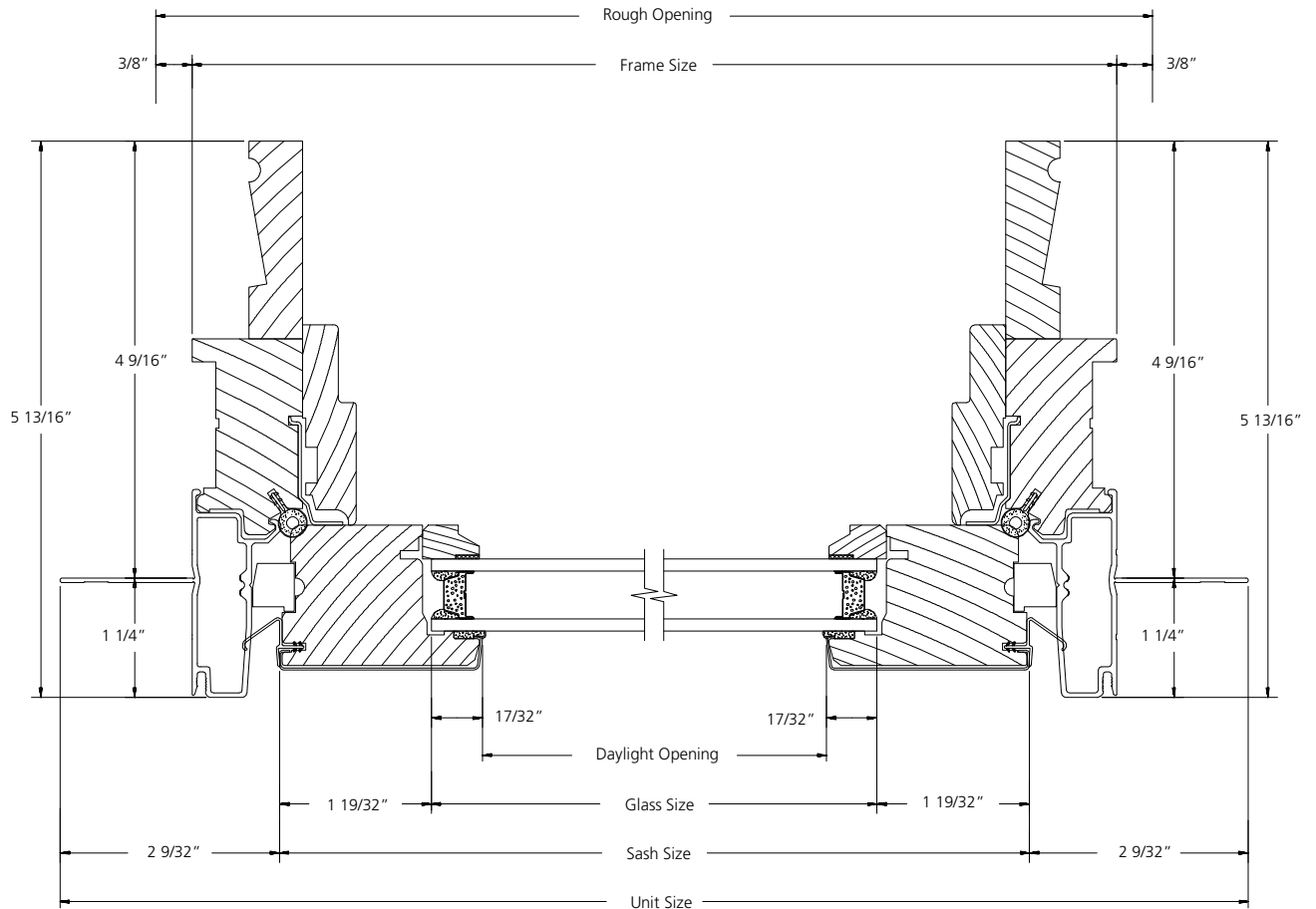

**HORIZONTAL SECTION**

SCALE: 6" = 1'

PICTURE UNIT WITH OPERATING FLANKERS

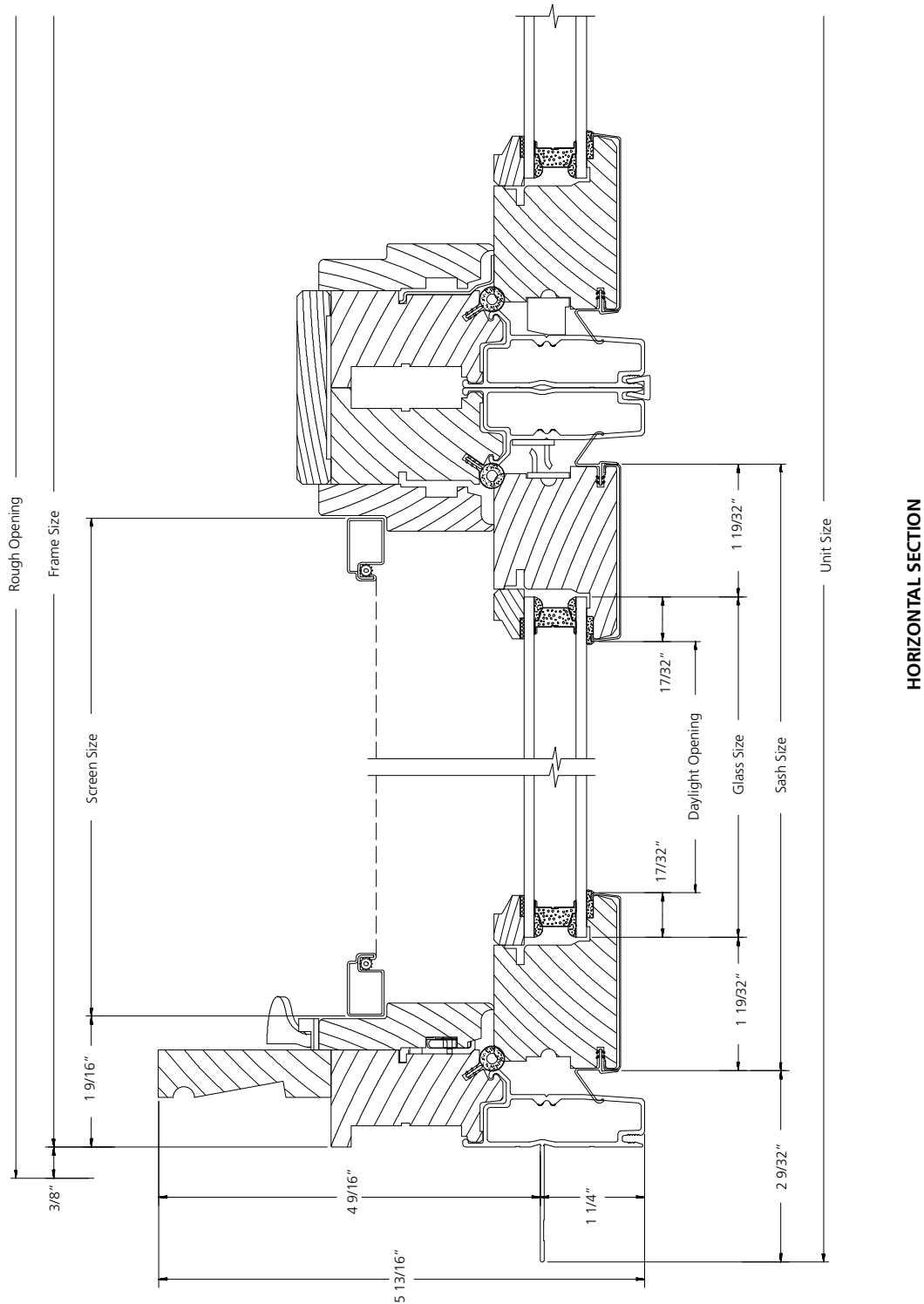

HORIZONTAL SECTION

### BOW WINDOW HORIZONTAL SPECIFICATION TABLES

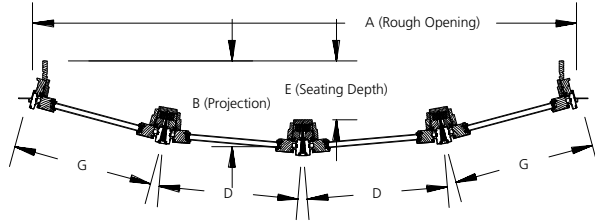

**EXTREME PERIMETER**  
Extreme Perimeter is the distance around the face of the bow, beginning at the exterior sheathing and continuing around the assembly along the extreme face of the frame.

4 WIDE BOW									
Flanker Width	A Rough Opening	F Unit Width	B Overall * Projection	C Projection Exterior Wall	E Seating* Depth	D Outside Mull To Mull	D Outside Mull To Unit	G	R
18	72 7/8	72 32/32	11 13/32	6 27/32	8	18 19/32	19 25/32	106 1/2	
24	96 7/16	96 1/2	13 15/32	8 29/32	10 3/32	24 19/32	25 25/32	140 3/8	
28	112 1/8	112 3/16	14 7/8	10 5/16	11 15/32	28 19/32	29 25/32	163 1/16	

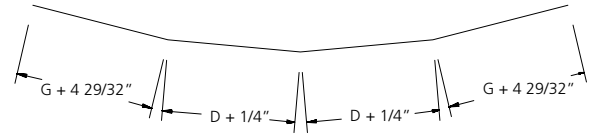

**EXTREME PERIMETER**

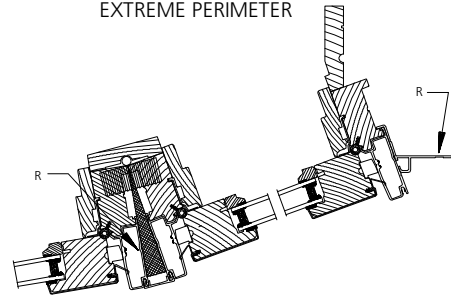

**RADIUS NOTE:** The Radius of a Bow Window is referenced from the interior of the Nailing Flange.

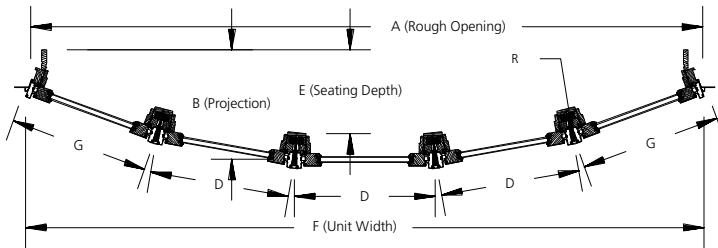

5 WIDE BOW									
Flanker Width	A Rough Opening	F Unit Width	B Overall * Projection	C Projection Exterior Wall	E Seating* Depth	D Outside Mull To Mull	D Outside Mull To Unit	G	R
18	89 15/16	90 3/8	14 5/8	10 1/16	11 7/32	18 19/32	19 25/32	106 1/2	
24	119	119 7/16	17 11/16	13 1/8	14 5/16	24 19/32	25 25/32	140 15/16	
28	138 3/8	138 27/32	19 3/4	15 3/16	16 3/8	28 19/32	29 25/32	163 1/16	

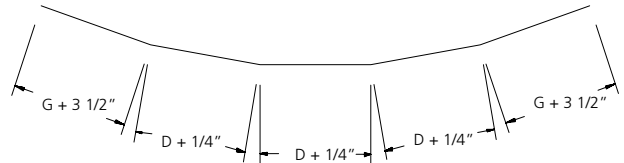

**EXTREME PERIMETER**

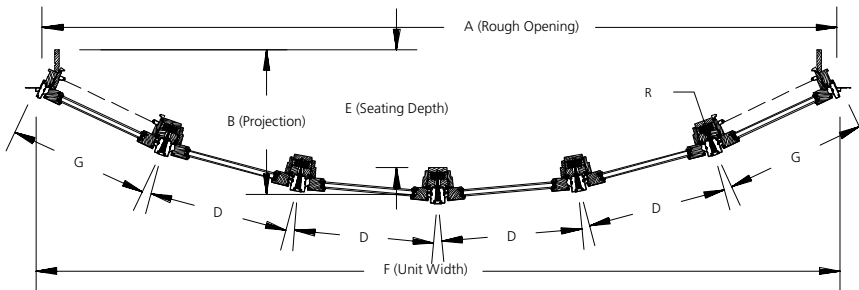

6 WIDE BOW									
Flanker Width	A Rough Opening	F Unit Width	B Overall * Projection	C Projection Exterior Wall	E Seating* Depth	D Outside Mull To Mull	D Outside Mull To Unit	G	R
18	106 1/4	107 1/16	19 3/8	14 13/16	16	18 19/32	19 25/32	106 1/2	
24	140 5/8	141 15/32	24	19 7/16	20 5/8	24 19/32	25 25/32	140 15/16	
28	163 5/8	164 7/16	27 1/16	22 1/2	23 11/16	28 19/32	29 25/32	163 1/16	

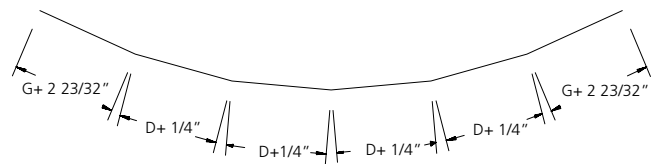

**EXTREME PERIMETER**

**4 9/16 and 6 9/16 WALL APPLICATION**

The tables above reflect a 4 9/16" wall application. To convert to 6 9/16" wall application add 2" to the figures in the columns which show an asterisk (\*), B and E.

**BAY & BOW WINDOW ROUGH OPENINGS**

**BAY & BOW WINDOW TRIM OPTIONS**

The standard offering for clad bay & bow windows is 'frame only' and brickmould and sillnose. Other trim options subject to approval. Rough & Masonry openings remain consistent with all trim options.

**VERTICAL ROUGH OPENING**

Rough Opening typical for all Units

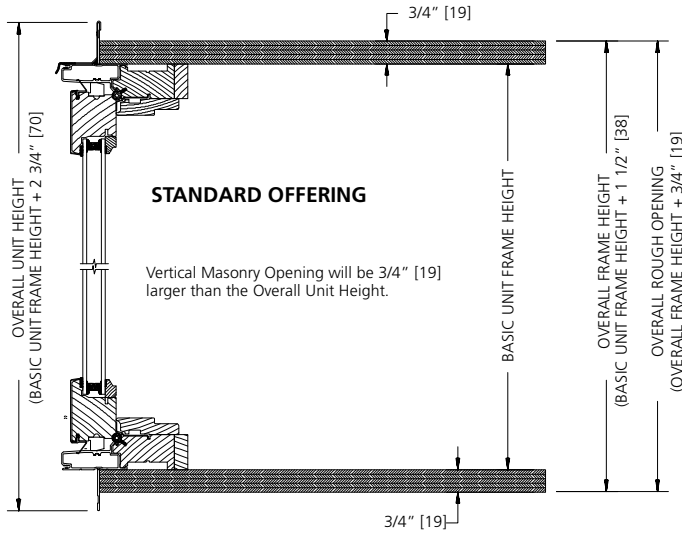

**STANDARD OFFERING**

Vertical Masonry Opening will be 3/4" [19] larger than the Overall Unit Height.

**HORIZONTAL ROUGH OPENING**

Rough Opening typical for all Units

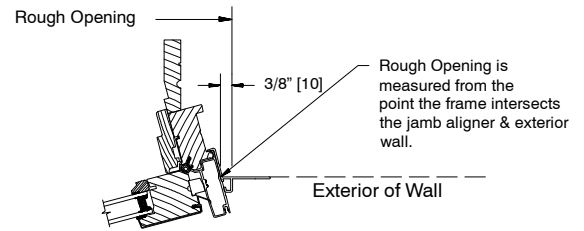

**4-, 5- & 6-WIDE BOWS**  
4-Wide Bow Shown  
with Brickmould

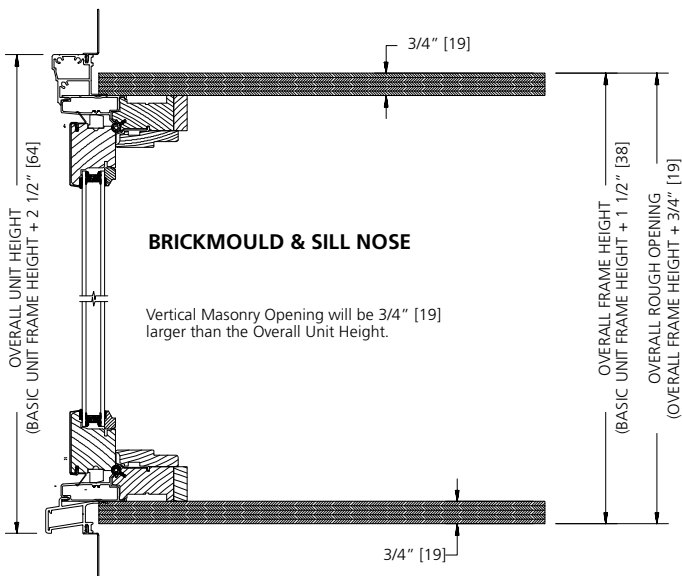

**BRICKMOULD & SILL NOSE**

Vertical Masonry Opening will be 3/4" [19] larger than the Overall Unit Height.

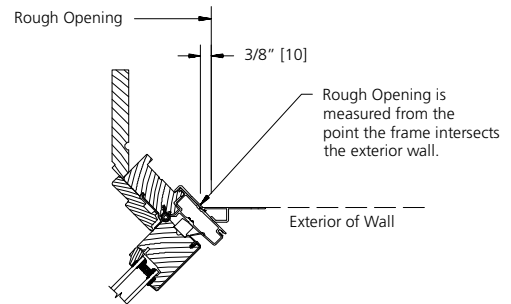

**30° & 45° BAYS**  
45° Bay Shown  
without trim

**ANGLE BAY AND BOW UNIT**

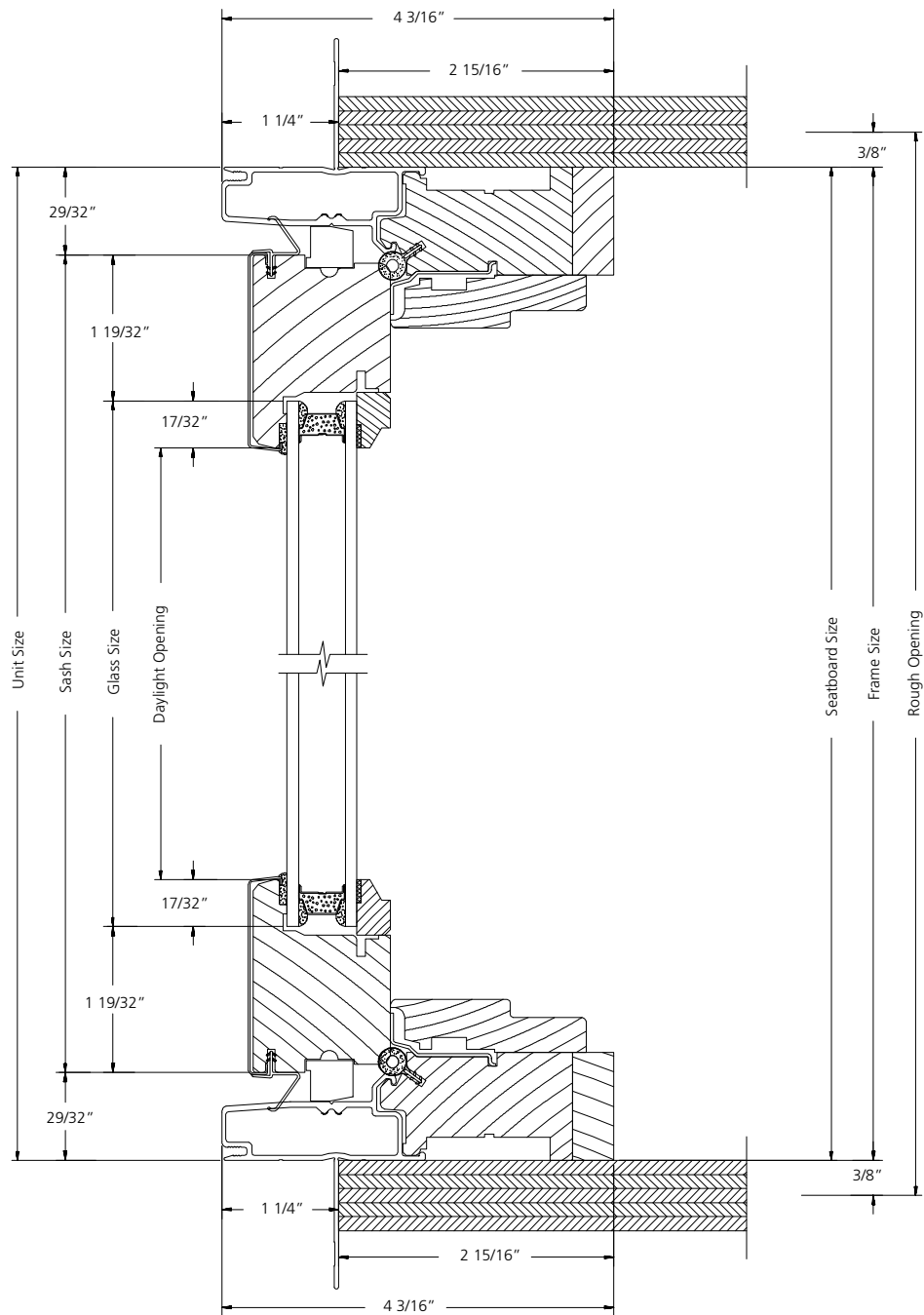

**VERTICAL SECTION**

SCALE: 3" = 1'

**ANGLE BAY AND BOW UNIT  
WITH BRICKMOULD**

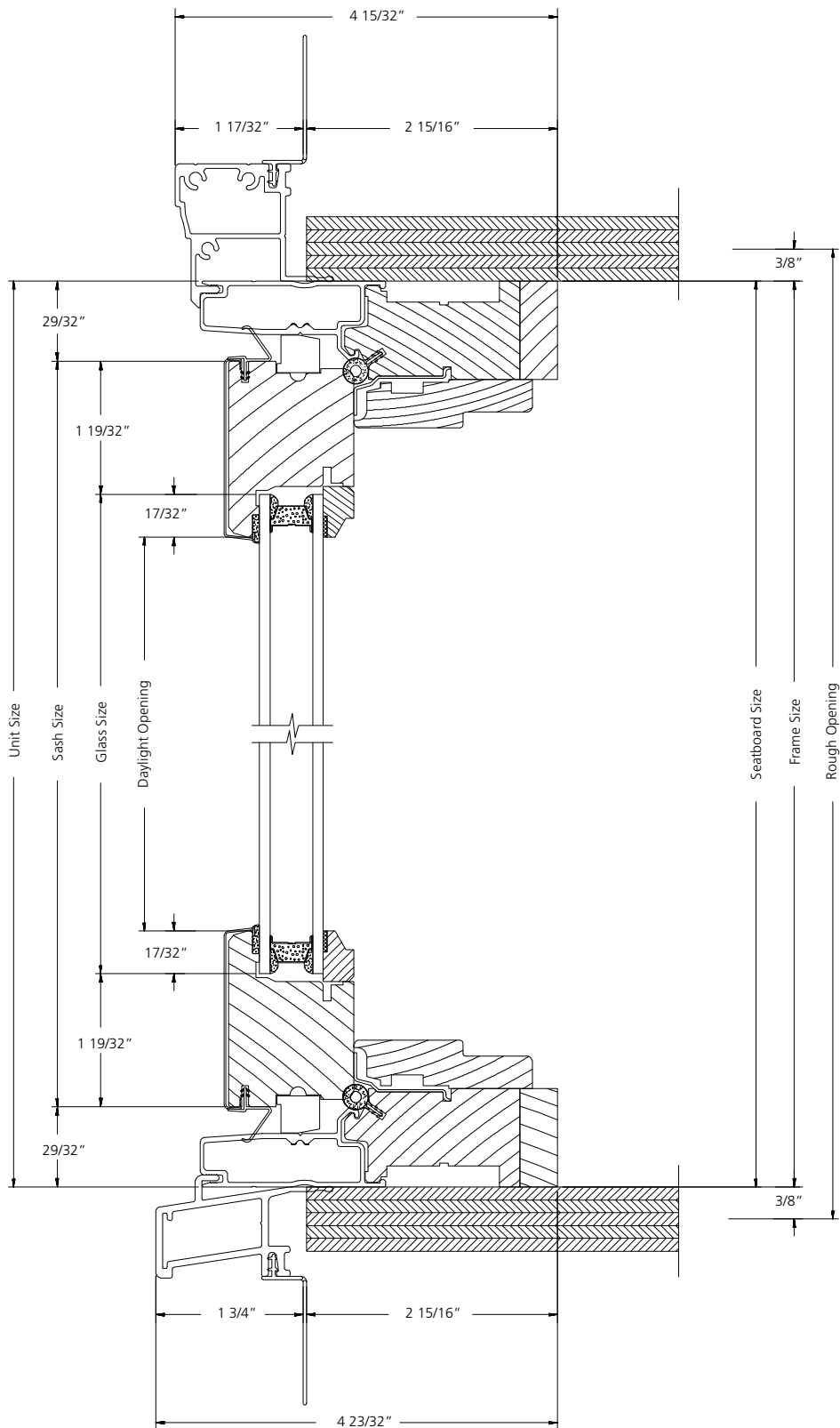

**VERTICAL SECTION**

SCALE: 3" = 1'

**30° ANGLE BAY UNIT**

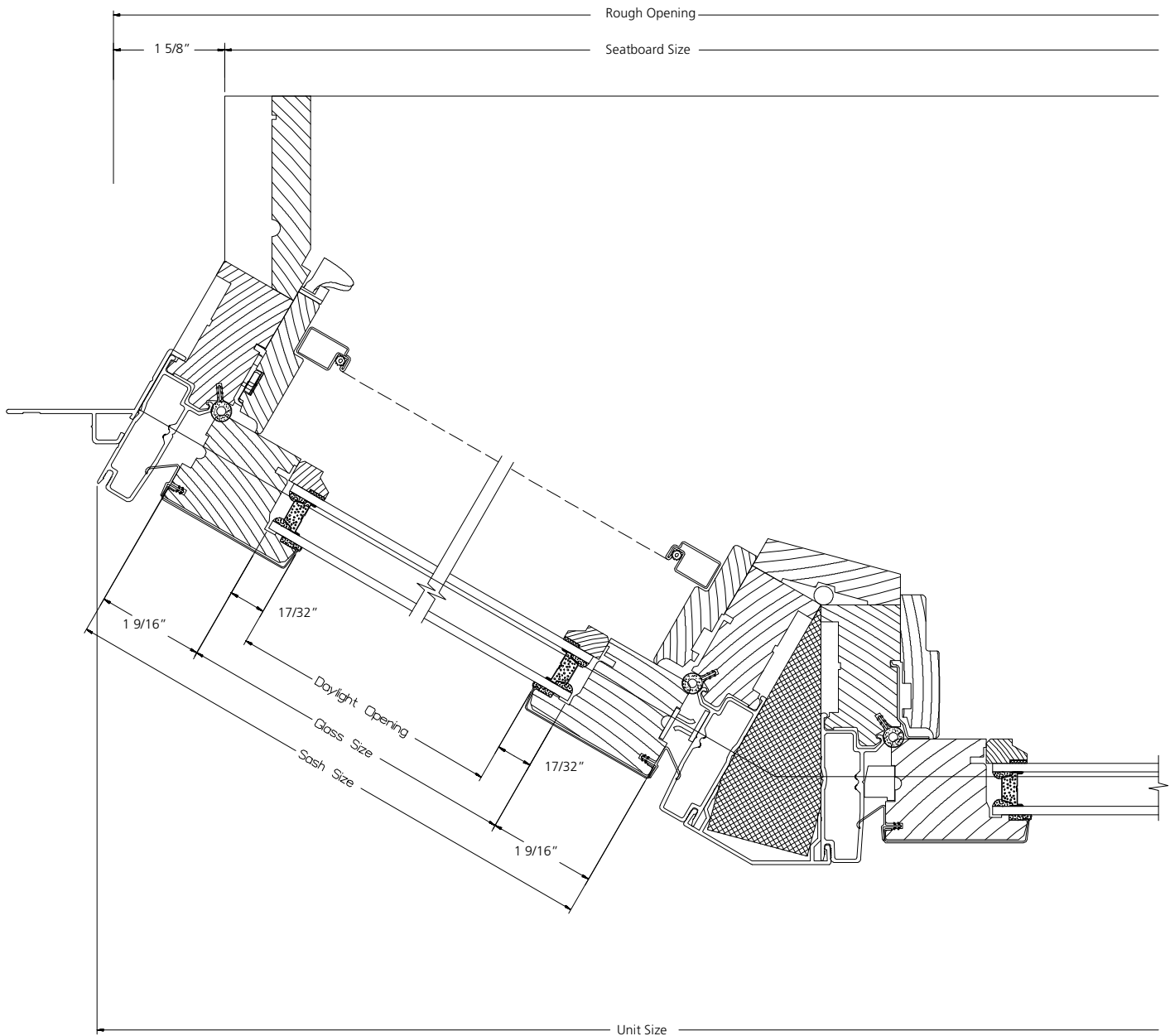

**HORIZONTAL SECTION**

SCALE: 3" = 1'

45° ANGLE BAY UNIT

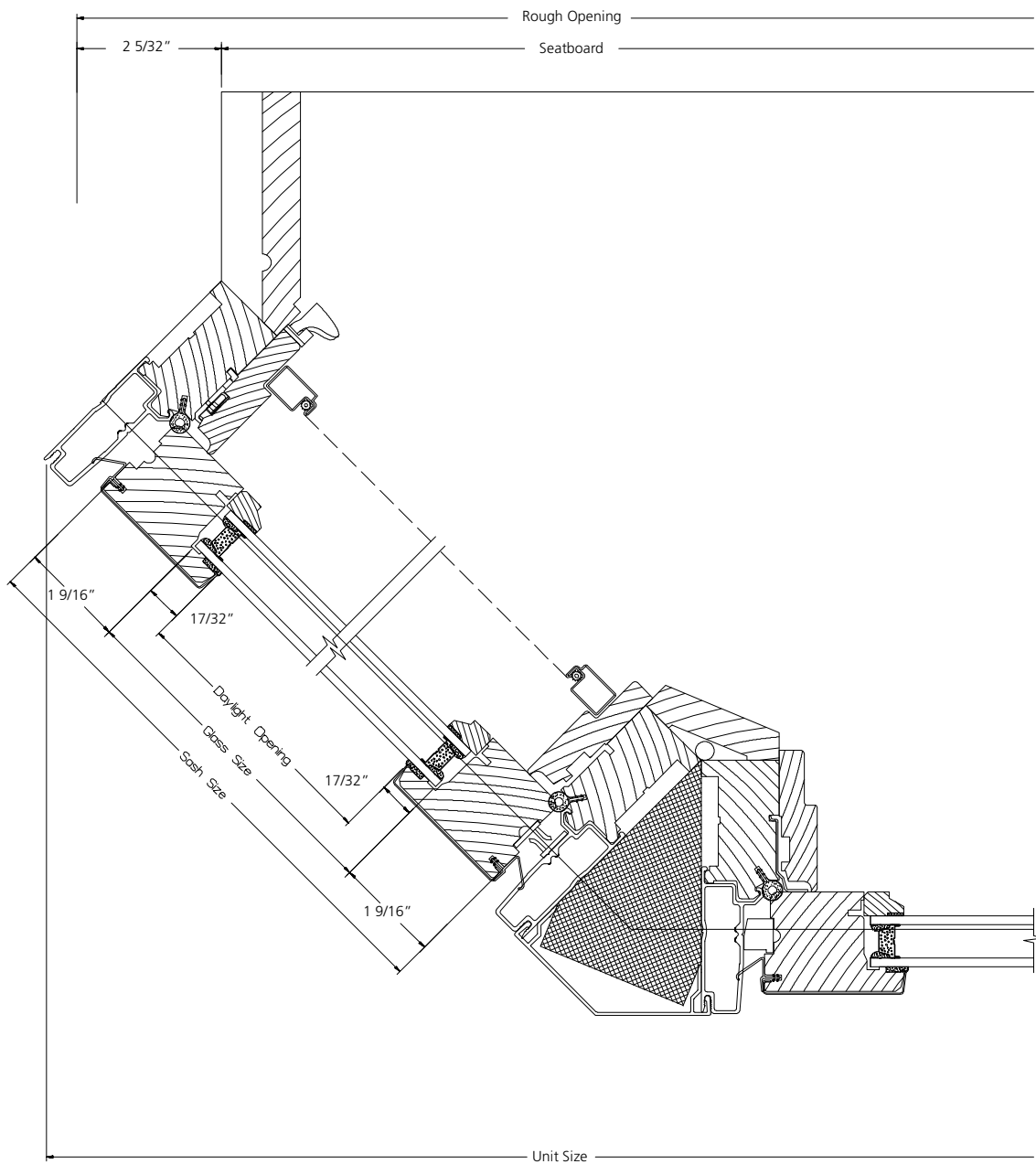

HORIZONTAL SECTION

SCALE: 3" = 1'



4-WIDE BOW

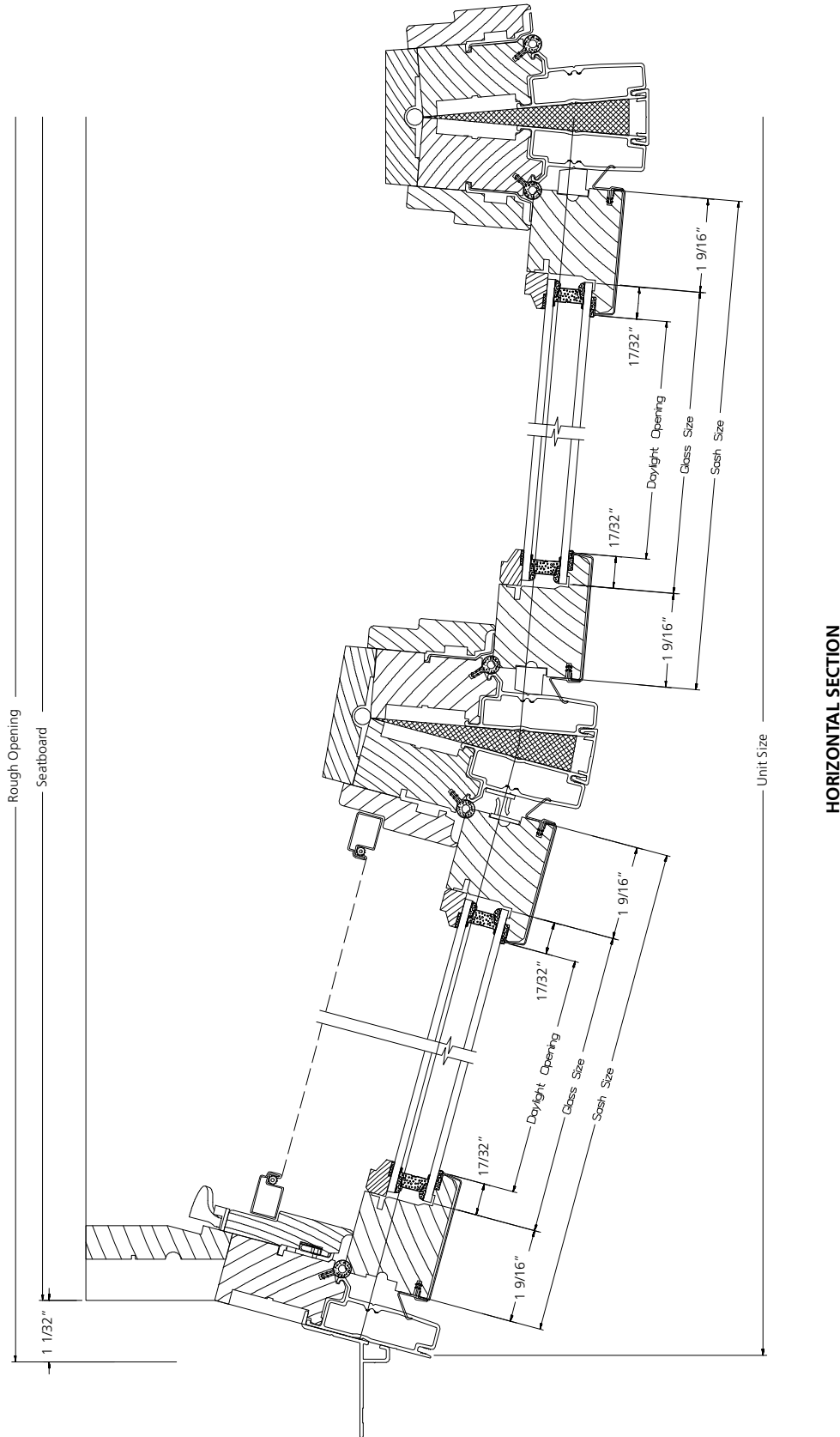

SCALE: 3" = 1'

5-WIDE BOW

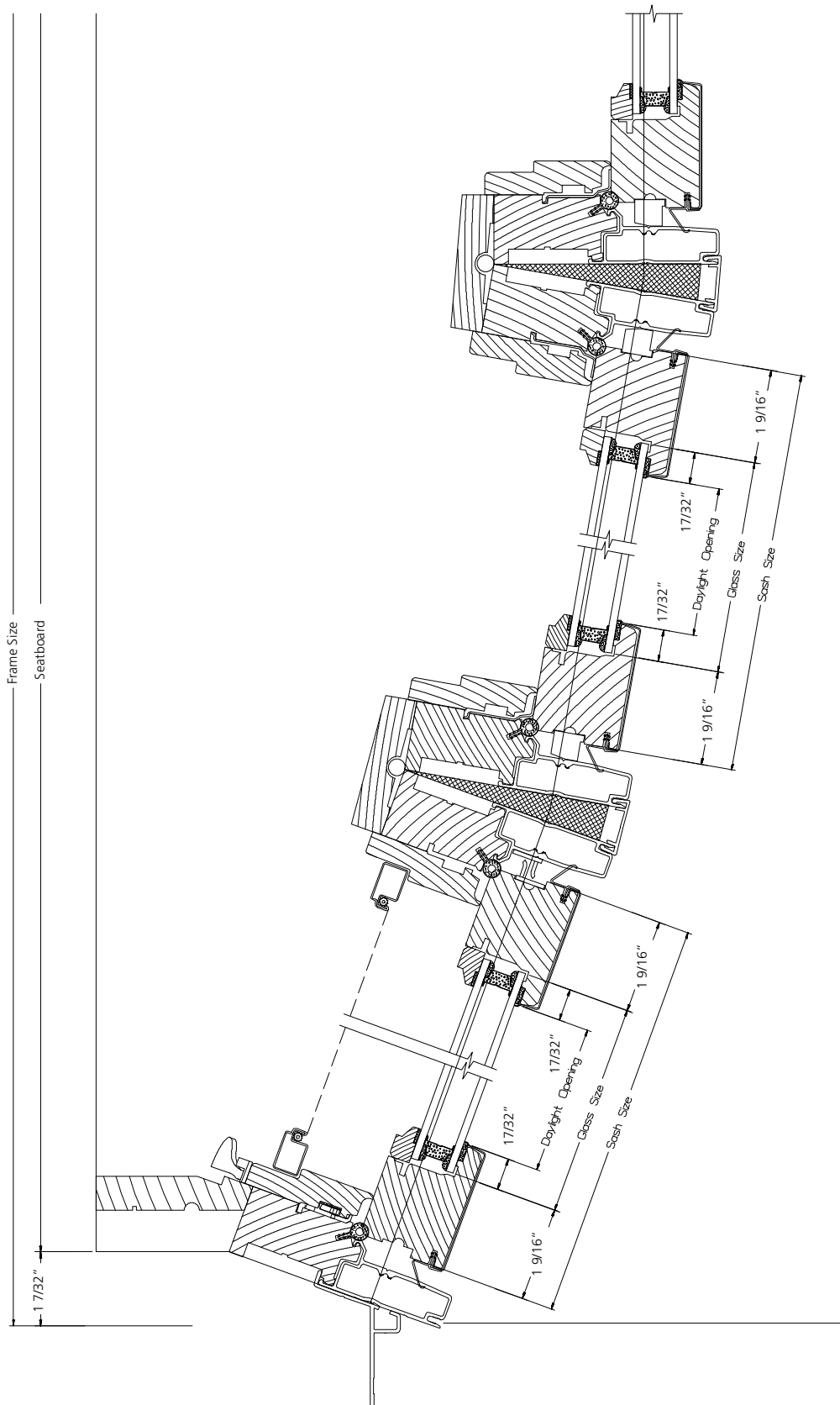

HORIZONTAL SECTION

**6-WIDE BOW**

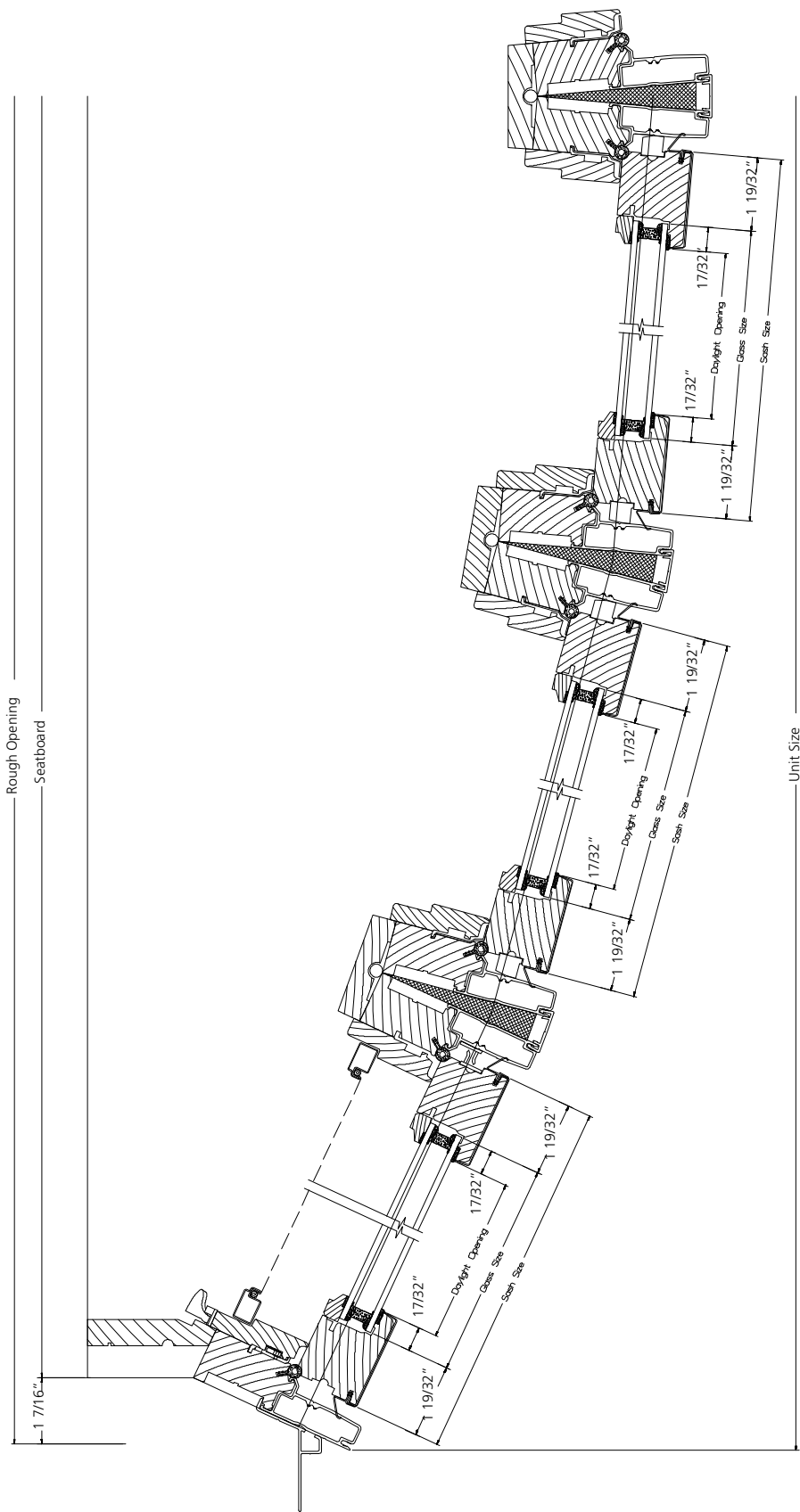

**HORIZONTAL SECTION**