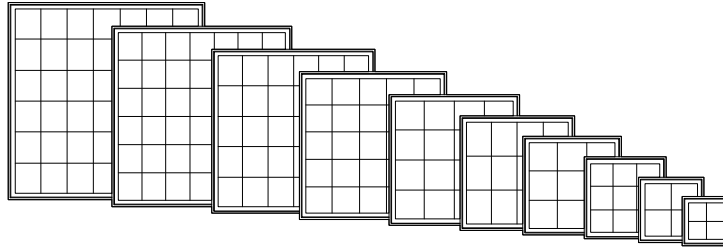

TABLE OF CONTENTS

Elevations/Sizes: 1/4" Scale	2-2
1-Wide Units	2-5
2-Wide Units	2-7
3-Wide Units	2-9
4-Wide Units	2-11
Picture Units	2-14
Picture Units with Flankers	2-21
30° & 45° Bay Units with Flankers	2-27
4-, 5- & 6-Wide Bow Units	2-39
Glazing Options: 3"Scale	2-44
Trim Options: 3" Scale	2-45
Jamb Extender Options: 3" Scale	2-46
Standard Mullion Options	2-47
Lite Cut Information & Options	2-49
Unit Sizing, Rough Openings & Masonry Openings	2-51
Section Details: 6"Scale	2-52
Bay and Bow Specifications	2-58
Section Details (Bay & Bow): 3" Scale	2-61

GENERAL INFORMATION



DIMENSIONAL WINDOWS

Wood casement windows may be specified as "dimensional" by adjusting the desired rough opening width or height in 1/8" increments from standard.

Wood casement windows are available with left or right hand operation, or stationary (non-venting). Operating mechanism includes corrosion resistant steel hinges and dual arm roto-type operator with hardened steel gears and operating arms. Sash locks are concealed unison type with an exposed locking lever and escutcheon plate. There are several interior hardware finish options. Refer to the Specifications for finish options.

MULTIPLE ASSEMBLIES

Wood casement windows may be mullied above, below, or beside other wood casement windows, or other wood window products. Factory assembled mulls are limited in height (100"), width (150"), and a total area (75 square feet).

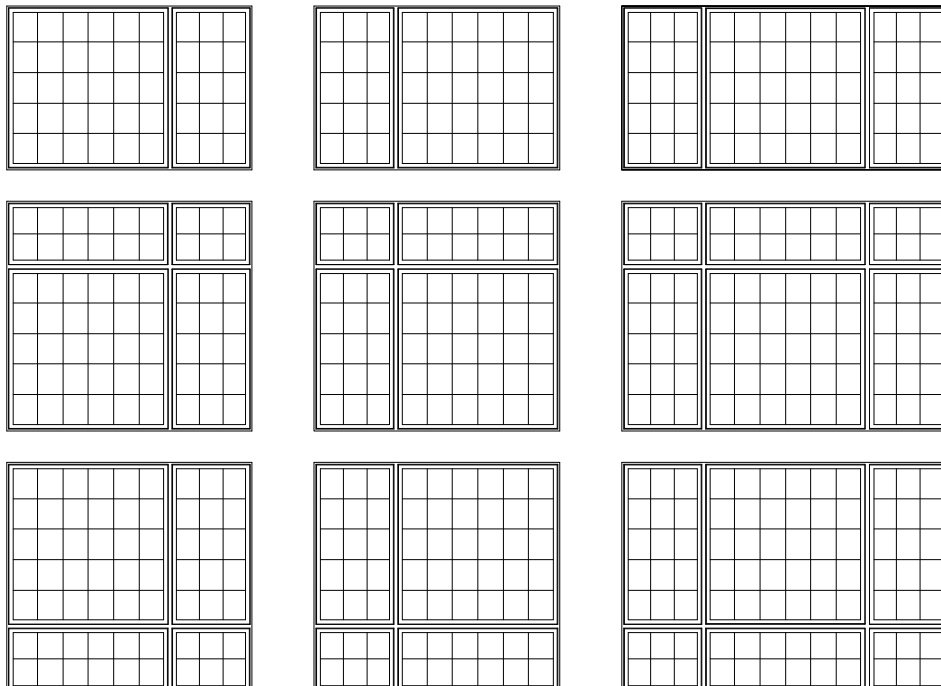

HANDING & OPERATION

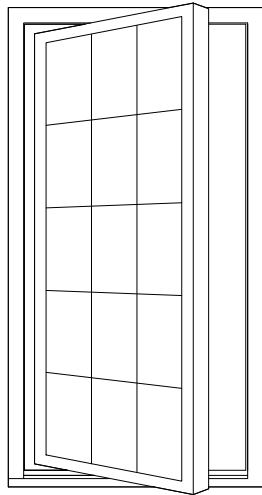

**LEFT
HAND**

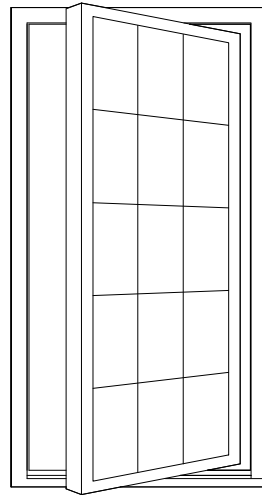

**RIGHT
HAND**

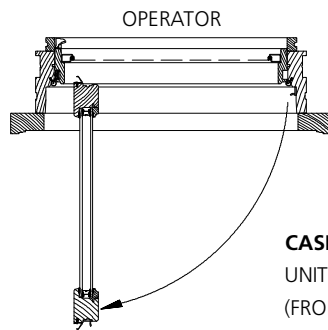

OPERATOR

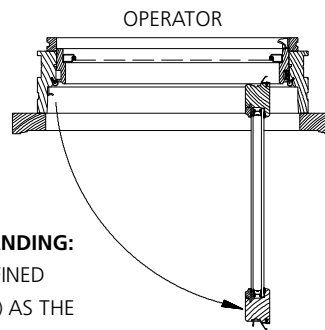

OPERATOR

CASEMENT UNIT HANDING:
UNIT HANDING IS DEFINED
(FROM THE EXTERIOR) AS THE
DIRECTION THE SASH OPENS.

ELEVATION NOTES
CASEMENT

ELEVATION DRAWINGS UTILIZE A LIMITED NUMBER OF PROJECTED LINES TO PRODUCE A RUDIMENTARY DRAWING INTENDED TO BE USED IN A SMALL GRAPHICAL SCALE. ELEVATIONS ARE VIEWED PERPENDICULAR FROM THE EXTERIOR OF THE STRUCTURE. IF MORE DIMENSIONS ARE NEEDED, USE THE SECTION DRAWINGS FOR MORE COMPLETE DEPICTIONS.

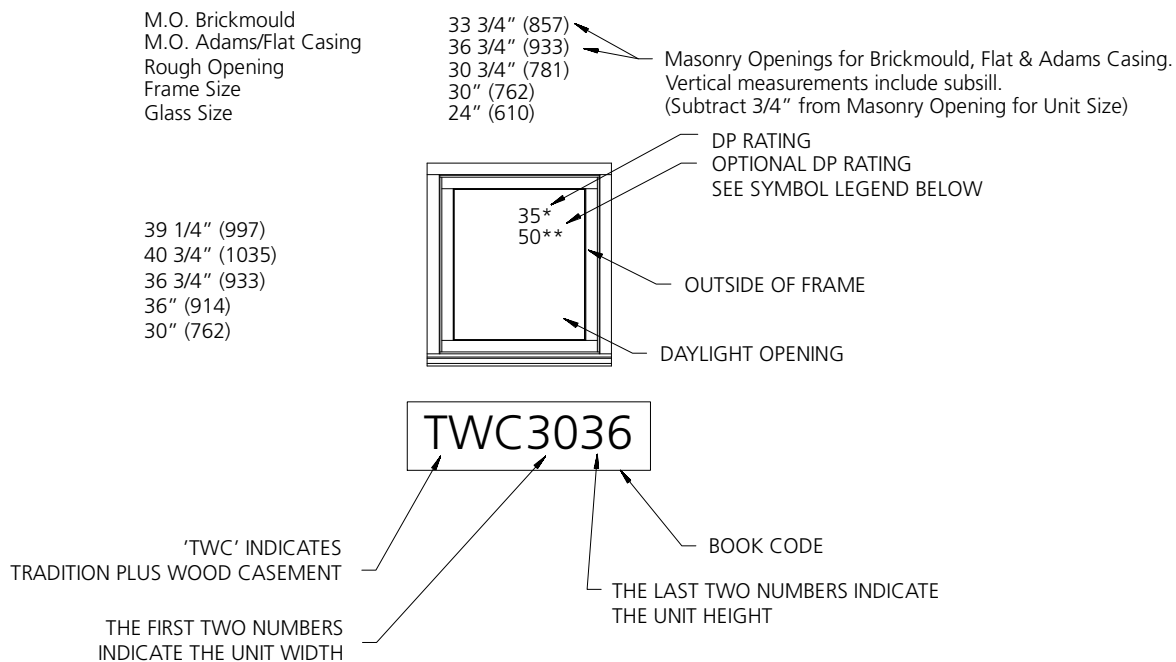

GENERAL CASEMENT NOTES

1. TRADITION PLUS WOOD CASEMENT (TWC) UNITS ARE AVAILABLE AS OPERATING OR STATIONARY UNITS.
2. 'TWCP' IN A BOOK CODE DENOTES THE UNIT IS A WOOD CASEMENT PICTURE (STATIONARY) UNIT.
3. UNIT ELEVATIONS ARE SHOWN WITH BRICKMOULD AND SUBSILL.
4. OPERATING UNITS ARE AVAILABLE AS LEFT OR RIGHT HAND OPERATION.
5. DIMENSIONAL VALUES IN PARENTHESES ARE MILLIMETER CONVERSIONS.
6. ALL GLASS SIZES ARE NOMINAL.

ELEVATION SYMBOL LEGEND:

- M.O.** MASONRY OPENING
- E** BASIC UNIT CLEAR OPENING EXCEEDS 20" IN WIDTH, 24" IN HEIGHT & A MINIMUM OF 5.7 SQ. FT.
- +** TEMPERED GLASS, TINTED GLASS, OBSCURE GLASS ARE NOT AVAILABLE WHEN COMBINED WITH SDL OPTION.
- S** STATIONARY UNIT
- ##*** NUMBER INDICATES DESIGN PRESSURE (DP) RATING WITH STANDARD GLAZING.
- ##**** NUMBER INDICATES OPTIONAL DESIGN PRESSURE (DP) RATING.

1-WIDE UNITS

M.O. BRICKMOUND M.O. ADAMS/FLAT CASING ROUGH OPENING FRAME SIZE DAYLIGHT OPENING	20 3/4" (527) 23 3/4" (603) 17 3/4" (451)	23 3/4" (603) 26 3/4" (679) 20 3/4" (527)	27 3/4" (704) 30 3/4" (781) 24 3/4" (629)	31 3/4" (806) 34 3/4" (883) 28 3/4" (730)	33 3/4" (857) 36 3/4" (933) 30 3/4" (781)	39 3/4" (1010) 42 3/4" (1086) 36 3/4" (933)
35 1/4" (895) 36 3/4" (933) 32 3/4" (832) 32" (813) 26" (660)	TWC1732	TWC2032	TWC2432	TWC2832	TWC3032	TWC3632
39 1/4" (997) 40 3/4" (1035) 36 3/4" (933) 36" (914) 30" (762)	TWC1736	TWC2036	TWC2436	TWC2836	TWC3036	TWC3636
43 1/4" (1099) 44 3/4" (1137) 40 3/4" (1035) 40" (1016) 34" (864)	TWC1740	TWC2040	TWC2440	TWC2840	TWC3040	TWC3640
45 1/4" (1149) 46 3/4" (1187) 42 3/4" (1086) 42" (1067) 36" (914)	TWC1742	TWC2042	TWC2442	TWC2842	TWC3042	TWC3642
51 1/4" (1301) 52 3/4" (1340) 48 3/4" (1238) 48" (1219) 42" (1067)	TWC1748	TWC2048	TWC2448	TWC2848	TWC3048	TWC3648
57 1/4" (1454) 58 3/4" (1492) 54 3/4" (1391) 54" (1372) 48" (1219)	TWC1754	TWC2054	TWC2454	TWC2854	TWC3054	TWC3654
59 1/4" (1505) 60 3/4" (1543) 56 3/4" (1441) 56" (1422) 50" (1270)	TWC1756	TWC2056	TWC2456	TWC2856	TWC3056	TWC3656

ELEVATION SYMBOL LEGEND:
M.O. = MASONRY OPENING
 VALUES IN () ARE IN MILLIMETER CONVERSIONS
##* NUMBER INDICATES DESIGN PRESSURE (DP) RATING WITH STANDARD GLAZING.
###* NUMBER INDICATES OPTIONAL DESIGN PRESSURE (DP) RATING.
E BASIC UNIT CLEAR OPENING EXCEEDS 20" IN WIDTH, 24" IN HEIGHT & A MINIMUM OF 5.7 SQ. FT.

Note Elevations shown DO NOT have exterior trim. Subtract 3/4" (19) from M.O. (Masonry Opening) for Unit Sizes. Masonry Openings above include Sill Nose, see Trim Options page for Sill Nose specifications. For other Trim Options refer to the Unit Sizing, Rough Opening & Masonry Openings page.

SCALE: 1/4" = 1'

1-WIDE UNITS

M.O. BRICKMOULD
M.O. ADAMS/FLAT CASING
ROUGH OPENING
FRAME SIZE
DAYLIGHT OPENING

20 3/4" (527)
23 3/4" (603)
17 3/4" (451)
17" (432)
11" (279)

23 3/4" (603)
26 3/4" (679)
20 3/4" (527)
20" (508)
14" (356)

27 3/4" (704)
30 3/4" (781)
24 3/4" (629)
24" (610)
18" (457)

31 3/4" (806)
34 3/4" (883)
28 3/4" (730)
28" (711)
22" (559)

33 3/4" (857)
36 3/4" (933)
30 3/4" (781)
30" (762)
24" (610)

39 3/4" (1010)
42 3/4" (1086)
36 3/4" (933)
36" (914)
30" (762)

63 1/4" (1607) 64 3/4" (1645) 60 3/4" (1543) 60" (1524) 54" (1372)						
67 1/4" (1708) 68 3/4" (1746) 64 3/4" (1645) 64" (1626) 58" (1473)						
69 1/4" (1759) 70 3/4" (1797) 66 3/4" (1695) 66" (1676) 60" (1524)						
75 1/4" (1911) 76 3/4" (1949) 72 3/4" (1848) 72" (1829) 66" (1676)						
87 1/4" (2216) 88 3/4" (2254) 84 3/4" (2153) 84" (2134) 78" (1981)						





























































ELEVATION SYMBOL LEGEND:

M.O. = MASONRY OPENING
VALUES IN () ARE IN MILLIMETER CONVERSIONS
NUMBER INDICATES DESIGN PRESSURE (DP) RATING WITH STANDARD GLAZING.
NUMBER INDICATES OPTIONAL DESIGN PRESSURE (DP) RATING.
E BASIC UNIT CLEAR OPENING EXCEEDS 20" IN WIDTH, 24" IN HEIGHT & A MINIMUM OF 5.7 SQ. FT.
S STATIONARY UNIT
+ TEMPERED GLASS, TINTED GLASS, OBSCURE GLASS ARE NOT AVAILABLE WHEN COMBINED WITH SDL OPTION.

Note Elevations shown DO NOT have exterior trim. Subtract 3/4" (19) from M.O. (Masonry Opening) for Unit Sizes. Masonry Openings above include Sill Nose, see Trim Options page for Sill Nose specifications. For other Trim Options refer to the Unit Sizing, Rough Opening & Masonry Openings page.

SCALE: 1/4" = 1'

2-WIDE UNITS

M.O. BRICKMOLD	37 3/4" (959)	43 3/4" (1111)	51 3/4" (1314)	59 3/4" (1518)	63 3/4" (1619)	75 3/4" (1924)
M.O. ADAMS/FLAT CASING	40 3/4" (1035)	46 3/4" (1187)	54 3/4" (1391)	62 3/4" (1594)	66 3/4" (1695)	78 3/4" (2000)
ROUGH OPENING	34 3/4" (883)	40 3/4" (1035)	48 3/4" (1238)	56 3/4" (1441)	60 3/4" (1543)	72 3/4" (1848)
FRAME SIZE	34" (864)	40" (1016)	48" (1219)	56" (1422)	60" (1524)	72" (1829)
DAYLIGHT OPENING	11" (279)[2]	14" (356)[2]	18" (457)[2]	22" (559)[2]	24" (610)[2]	30" (762)[2]
35 1/4" (895) 36 3/4" (933) 32 3/4" (832) 32" (813) 26" (660)						
TWC1732-2	TWC2032-2	TWC2432-2	TWC2832-2	TWC3032-2	TWC3632-2	
39 1/4" (997) 40 3/4" (1035) 36 3/4" (933) 36" (914) 30" (762)						
TWC1736-2	TWC2036-2	TWC2436-2	TWC2836-2	TWC3036-2	TWC3636-2	
43 1/4" (1099) 44 3/4" (1137) 40 3/4" (1035) 40" (1016) 34" (864)						
TWC1740-2	TWC2040-2	TWC2440-2	TWC2840-2	TWC3040-2	TWC3640-2	
45 1/4" (1149) 46 3/4" (1187) 42 3/4" (1086) 42" (1067) 36" (914)						
TWC1742-2	TWC2042-2	TWC2442-2	TWC2842-2	TWC3042-2	TWC3642-2	
51 1/4" (1302) 52 3/4" (1340) 48 3/4" (1238) 48" (1219) 42" (1067)						
TWC1748-2	TWC2048-2	TWC2448-2	TWC2848-2	TWC3048-2	TWC3648-2	
57 1/4" (1454) 58 3/4" (1492) 54 3/4" (1391) 54" (1372) 48" (1219)						
TWC1754-2	TWC2054-2	TWC2454-2	TWC2854-2	TWC3054-2	TWC3654-2	
59 1/4" (1505) 60 3/4" (1543) 56 3/4" (1441) 56" (1422) 50" (1270)						
TWC1756-2	TWC2056-2	TWC2456-2	TWC2856-2	TWC3056-2	TWC3656-2	
63 1/4" (1607) 64 3/4" (1645) 60 3/4" (1543) 60" (1524) 54" (1372)						
TWC1760-2	TWC2060-2	TWC2460-2	TWC2860-2	TWC3060-2	TWC3660-2	
67 1/4" (1708) 68 3/4" (1746) 64 3/4" (1645) 64" (1626) 58" (1473)						
TWC1764-2	TWC2064-2	TWC2464-2	TWC2864-2	TWC3064-2	TWC3664-2	
69 1/4" (1759) 70 3/4" (1797) 66 3/4" (1695) 66" (1676) 60" (1524)						
TWC1766-2	TWC2066-2	TWC2466-2	TWC2866-2	TWC3066-2	TWC3666-2	

ELEVATION SYMBOL LEGEND:

M.O. = MASONRY OPENING

VALUES IN () ARE IN MILLIMETER CONVERSIONS

VALUES IN [] ARE NUMBER OF DAYLIGHT OPENINGS PER UNIT

E BASIC UNIT CLEAR OPENING EXCEEDS 20" IN WIDTH, 24" IN HEIGHT & A MINIMUM OF 5.7 SQ. FT.

Note Elevations shown DO NOT have exterior trim. Subtract 3/4" (19) from M.O. (Masonry Opening) for Unit Sizes. Masonry Openings above include Sill Nose, see Trim Options page for Sill Nose specifications. For other Trim Options refer to the Unit Sizing, Rough Opening & Masonry Openings page.

SCALE: 1/8" = 1'

2-WIDE UNITS

M.O. BRICKMOULD	37 3/4"(959)	43 3/4"(1111)	51 3/4"(1314)	59 3/4"(1518)	63 3/4"(1619)	75 3/4"(1924)
M.O. ADAMS/FLAT CASING	40 3/4"(1035)	46 3/4"(1187)	54 3/4"(1391)	62 3/4"(1594)	66 3/4"(1695)	78 3/4"(2000)
ROUGH OPENING	34 3/4"(883)	40 3/4"(1035)	48 3/4"(1238)	56 3/4"(1441)	60 3/4"(1543)	72 3/4"(1848)
FRAME SIZE	34"(864)	40"(1016)	48"(1219)	56"(1422)	60"(1524)	72"(1829)
DAYLIGHT OPENING	11"(279)[2]	14"(356)[2]	18"(457)[2]	22"(559)[2]	24"(610)[2]	30"(762)[2]

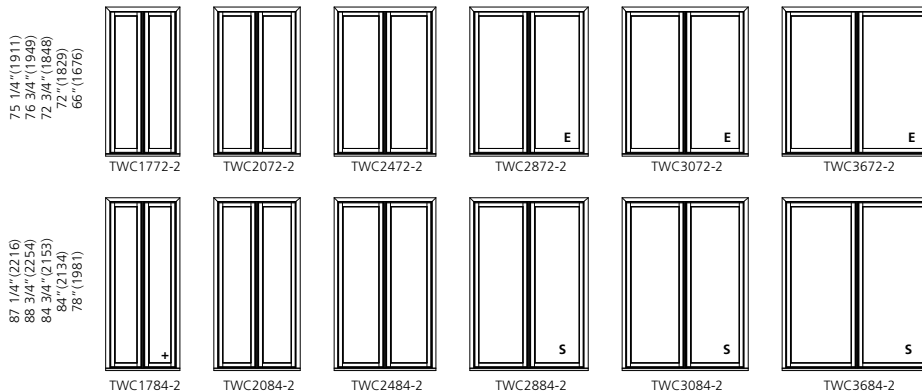

ELEVATION SYMBOL LEGEND:

- M.O. = MASONRY OPENING
- VALUES IN () ARE IN MILLIMETER CONVERSIONS
- VALUES IN [] ARE NUMBER OF DAYLIGHT OPENINGS PER UNIT
- + TEMPERED GLASS STANDARD
- E BASIC UNIT CLEAR OPENING EXCEEDS 20" IN WIDTH, 24" IN HEIGHT & A MINIMUM OF 5.7 SQ. FT.
- S STATIONARY UNIT

Note Elevations shown DO NOT have exterior trim. Subtract 3/4" (19) from M.O. (Masonry Opening) for Unit Sizes. Masonry Openings above include Sill Nose, see Trim Options page for Sill Nose specifications. For other Trim Options refer to the Unit Sizing, Rough Opening & Masonry Openings page.

3-WIDE UNITS

M.O. BRICKMOULD M.O. ADAMS/FLAT CASING ROUGH OPENING FRAME SIZE DAYLIGHT OPENING	54 3/4" (1391) 57 3/4" (1467) 51 3/4" (1314)	63 3/4" (1619) 66 3/4" (1695) 60 3/4" (1543)	75 3/4" (1924) 78 3/4" (2000) 72 3/4" (1848)	87 3/4" (2229) 90 3/4" (2305) 84 3/4" (2153)	93 3/4" (2381) 96 3/4" (2457) 90 3/4" (2305)	111 3/4" (2838) 114 3/4" (2914) 108 3/4" (2762)
35 1/4" (895) 36 3/4" (933) 35 3/4" (932) 26" (660)	TWC1732-3	TWC2032-3	TWC2432-3	TWC2832-3	TWC3032-3	TWC3632-3
39 1/4" (997) 40 3/4" (1035) 36 3/4" (933) 36" (914) 30" (762)	TWC1736-3	TWC2036-3	TWC2436-3	TWC2836-3	TWC3036-3	TWC3636-3 E
43 1/4" (1099) 44 3/4" (1137) 40 3/4" (1035) 40" (1016) 34" (864)	TWC1740-3	TWC2040-3	TWC2440-3	TWC2840-3	TWC3040-3	TWC3640-3 E
45 1/4" (1149) 46 3/4" (1187) 42 3/4" (1086) 42" (1067) 36" (914)	TWC1742-3	TWC2042-3	TWC2442-3	TWC2842-3	TWC3042-3	TWC3642-3 E
51 1/4" (1302) 52 3/4" (1340) 48 3/4" (1238) 48" (1219) 42" (1067)	TWC1748-3	TWC2048-3	TWC2448-3	TWC2848-3 E	TWC3048-3 E	TWC3648-3 E
57 1/4" (1454) 58 3/4" (1492) 54 3/4" (1391) 54" (1376) 48" (1219)	TWC1754-3	TWC2054-3	TWC2454-3	TWC2854-3 E	TWC3054-3 E	TWC3654-3 E
59 1/4" (1505) 60 3/4" (1543) 56 3/4" (1441) 56" (1422) 50" (1270)	TWC1756-3	TWC2056-3	TWC2456-3	TWC2856-3 E	TWC3056-3 E	TWC3656-3 E
63 1/4" (1607) 64 3/4" (1645) 60 3/4" (1543) 60" (1524) 54" (1372)	TWC1760-3	TWC2060-3	TWC2460-3	TWC2860-3 E	TWC3060-3 E	TWC3660-3 E
67 1/4" (1708) 68 3/4" (1746) 64 3/4" (1645) 64" (1626) 58" (1473)	TWC1764-3	TWC2064-3	TWC2464-3	TWC2864-3 E	TWC3064-3 E	TWC3664-3 E
69 1/4" (1759) 70 3/4" (1797) 66 3/4" (1695) 66" (1676) 60" (1524)	TWC1766-3	TWC2066-3	TWC2466-3	TWC2866-3 E	TWC3066-3 E	TWC3666-3 E

ELEVATION SYMBOL LEGEND:

M.O. = MASONRY OPENING
 VALUES IN () ARE IN MILLIMETER CONVERSIONS
 VALUES IN [] ARE NUMBER OF DAYLIGHT OPENINGS PER UNIT
 E BASIC UNIT CLEAR OPENING EXCEEDS 20" IN WIDTH, 24" IN HEIGHT & A MINIMUM OF 5.7 SQ. FT.

Note Elevations shown DO NOT have exterior trim. Subtract 3/4" (19) from M.O. (Masonry Opening) for Unit Sizes. Masonry Openings above include Sill Nose, see Trim Options page for Sill Nose specifications. For other Trim Options refer to the Unit Sizing, Rough Opening & Masonry Openings page.

SCALE: 1/8" = 1'

3-WIDE UNITS

M.O. BRICKMOULD	54 3/4"(1391)	63 3/4"(1619)	75 3/4"(1924)	87 3/4"(2229)	93 3/4"(2381)	111 3/4"(2838)
M.O. ADAMS/FLAT CASING	57 3/4"(1467)	66 3/4"(1695)	78 3/4"(2000)	90 3/4"(2305)	96 3/4"(2457)	114 3/4"(2914)
ROUGH OPENING	51 3/4"(1314)	60 3/4"(1543)	72 3/4"(1848)	84 3/4"(2153)	90 3/4"(2305)	108 3/4"(2762)
FRAME SIZE	51"(1295)	60"(1524)	72"(1829)	84"(2134)	90"(2286)	108"(2743)
DAYLIGHT OPENING	11"(279)[3]	14"(356)[3]	18"(457)[3]	22"(559)[3]	24"(610)[3]	30"(762)[3]

75 1/4" (1911)
76 3/4" (1949)
72 3/4" (1848)
72" (1829)
66" (1676)

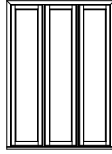

TWC1772-3

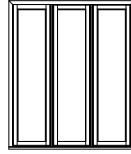

TWC2072-3

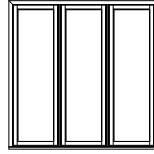

TWC2472-3

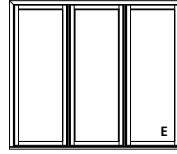

TWC2872-3

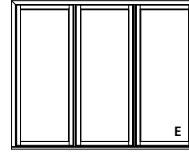

TWC3072-3

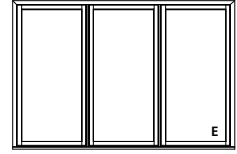

TWC3672-3

87 1/4" (2216)
88 3/4" (2254)
84 3/4" (2153)
84" (2134)
78" (1981)

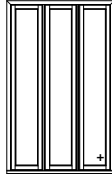

TWC1784-3

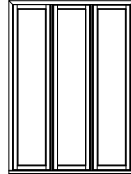

TWC2084-3

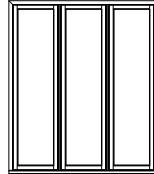

TWC2484-3

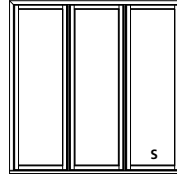

TWC2884-3

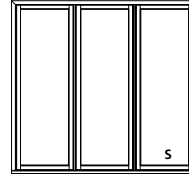

TWC3084-3

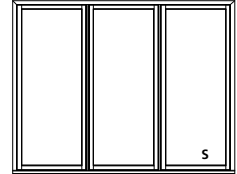

TWC3684-3

ELEVATION SYMBOL LEGEND:

- M.O. = MASONRY OPENING
- VALUES IN () ARE IN MILLIMETER CONVERSIONS
- VALUES IN [] ARE NUMBER OF DAYLIGHT OPENINGS PER UNIT
- + TEMPERED GLASS STANDARD
- E BASIC UNIT CLEAR OPENING EXCEEDS 20" IN WIDTH, 24" IN HEIGHT & A MINIMUM OF 5.7 SQ. FT.
- S STATIONARY UNIT

Note Elevations shown DO NOT have exterior trim. Subtract 3/4" (19) from M.O. (Masonry Opening) for Unit Sizes. Masonry Openings above include Sill Nose, see Trim Options page for Sill Nose specifications. For other Trim Options refer to the Unit Sizing, Rough Opening & Masonry Openings page.

SCALE: 1/8" = 1'

4-WIDE UNITS

M.O. BRICKMOULD
M.O. ADAMS/FLAT CASING
ROUGH OPENING
FRAME SIZE
DAYLIGHT OPENING

71 3/4"(1822)
74 3/4"(1899)
68 3/4"(1746)
68"(1727)
11"(279)[4]

83 3/4"(2127)
86 3/4"(2203)
80 3/4"(2051)
80"(2032)
14"(356)[4]

99 3/4"(2534)
102 3/4"(2610)
96 3/4"(2457)
96"(2438)
18"(457)[4]

115 3/4"(2940)
118 3/4"(3016)
112 3/4"(2864)
112"(2849)
22"(559)[4]

123 3/4"(3143)
126 3/4"(3219)
120 3/4"(3067)
120"(3048)
24"(610)[4]

35 1/4"(895)
36 3/4"(933)
32 3/4"(832)
32"(813)
26"(660)

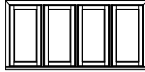

TWC1732-4

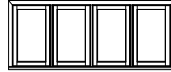

TWC2032-4

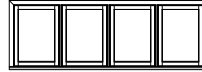

TWC2432-4

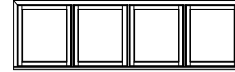

TWC2832-4

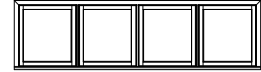

TWC3032-4

39 1/4"(997)
40 3/4"(1035)
36 3/4"(933)
36"(914)
30"(762)

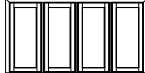

TWC1736-4

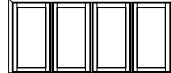

TWC2036-4

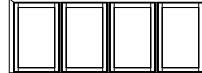

TWC2436-4



TWC2836-4



TWC3036-4

43 1/4"(1099)
44 3/4"(1137)
40 3/4"(1035)
40"(1016)
34"(864)



TWC1740-4



TWC2040-4



TWC2440-4



TWC2840-4

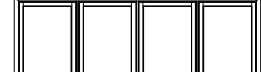

TWC3040-4

45 1/4"(1149)
46 3/4"(1187)
42 3/4"(1086)
42"(1067)
36"(914)

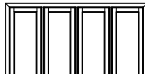

TWC1742-4

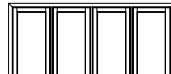

TWC2042-4



TWC2442-4

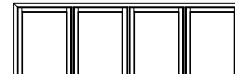

TWC2842-4

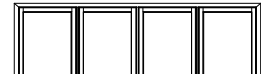

TWC3042-4

51 1/4"(1302)
52 3/4"(1340)
48 3/4"(1238)
48"(1219)
42"(1067)



TWC1748-4



TWC2048-4



TWC2448-4



TWC2848-4



TWC3048-4

57 1/4"(1454)
58 3/4"(1492)
54 3/4"(1391)
54"(1372)
48"(1219)

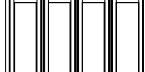

TWC1754-4



TWC2054-4

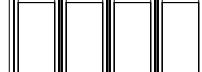

TWC2454-4

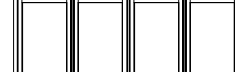

TWC2854-4

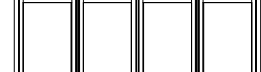

TWC3054-4

59 1/4"(1505)
60 3/4"(1543)
56 3/4"(1441)
56"(1422)
50"(1270)



TWC1756-4



TWC2056-4

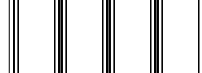

TWC2456-4

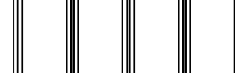

TWC2856-4

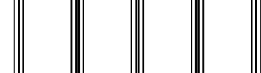

TWC3056-4

63 1/4"(1607)
64 3/4"(1645)
60 3/4"(1543)
60"(1524)
54"(1372)

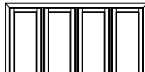

TWC1760-4



TWC2060-4

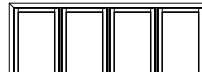

TWC2460-4

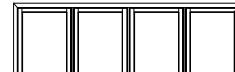

TWC2860-4

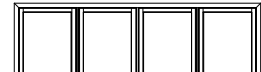

TWC3060-4

67 1/4"(1708)
68 3/4"(1746)
64 3/4"(1645)
64"(1626)
58"(1473)



TWC1764-4



TWC2064-4



TWC2464-4

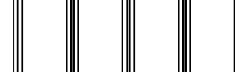

TWC2864-4

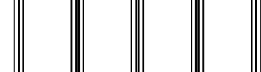

TWC3064-4

69 1/4"(1759)
70 3/4"(1797)
66 3/4"(1695)
66"(1676)
60"(1524)

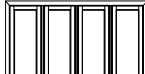

TWC1766-4



TWC2066-4



TWC2466-4



TWC2866-4



TWC3066-4

ELEVATION SYMBOL LEGEND:

M.O. = MASONRY OPENING
VALUES IN () ARE IN MILLIMETER CONVERSIONS
VALUES IN [] ARE NUMBER OF DAYLIGHT OPENINGS PER UNIT
E BASIC UNIT CLEAR OPENING EXCEEDS 20" IN WIDTH, 24" IN HEIGHT & A MINIMUM OF 5.7 SQ. FT.

Note Elevations shown DO NOT have exterior trim. Subtract 3/4" (19) from M.O. (Masonry Opening) for Unit Sizes. Masonry Openings above include Sill Nose, see Trim Options page for Sill Nose specifications. For other Trim Options refer to the Unit Sizing, Rough Opening & Masonry Openings page.

SCALE: 1/8" = 1'

4-WIDE UNITS

M.O. BRICKMOULD	71 3/4"(1822)	83 3/4"(2127)	99 3/4"(2534)	115 3/4"(2940)	123 3/4"(3143)
M.O. ADAMS/FLAT CASING	74 3/4"(1899)	86 3/4"(2203)	102 3/4"(2610)	118 3/4"(3016)	126 3/4"(3219)
ROUGH OPENING	68 3/4"(1746)	80 3/4"(2051)	96 3/4"(2457)	112 3/4"(2864)	120 3/4"(3067)
FRAME SIZE	68"(1727)	80"(2032)	96"(2438)	112"(2849)	120"(3048)
DAYLIGHT OPENING	11"(279)[4]	14"(356)[4]	18"(457)[4]	22"(559)[4]	24"(610)[4]

75 1/4"(1911)
76 3/4"(1949)
77 1/4"(1978)
77 1/2"(1978)
66"(1676)

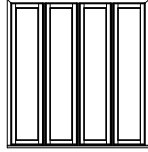

TWC1772-4

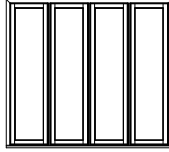

TWC2072-4

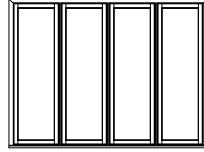

TWC2472-4

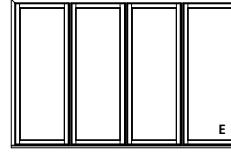

TWC2872-4

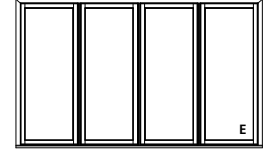

TWC3072-4

87 1/4"(2216)
88 3/4"(2254)
89 1/4"(2283)
94"(2351)
78"(1981)

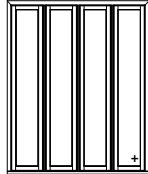

TWC1784-4

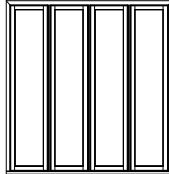

TWC2084-4

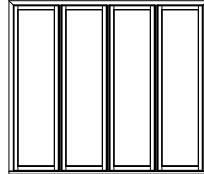

TWC2484-4

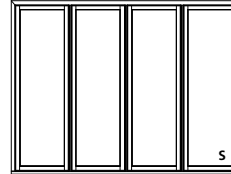

TWC2884-4

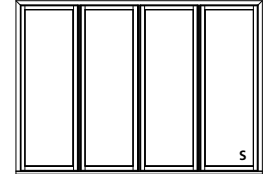

TWC3084-4

ELEVATION SYMBOL LEGEND:

- M.O.** = MASONRY OPENING
- VALUES IN () ARE IN MILLIMETER CONVERSIONS
- VALUES IN [] ARE NUMBER OF DAYLIGHT OPENINGS PER UNIT
- +** TEMPERED GLASS STANDARD
- E** BASIC UNIT CLEAR OPENING EXCEEDS 20" IN WIDTH, 24" IN HEIGHT & A MINIMUM OF 5.7 SQ. FT.
- S** STATIONARY UNIT

Note Elevations shown DO NOT have exterior trim. Subtract 3/4" (19) from M.O. (Masonry Opening) for Unit Sizes. Masonry Openings above include Sill Nose, see Trim Options page for Sill Nose specifications. For other Trim Options refer to the Unit Sizing, Rough Opening & Masonry Openings page.

SCALE: 1/8" = 1'

4-WIDE UNITS

M.O. BRICKMOULD
M.O. ADAMS/FLAT CASING
ROUGH OPENING
FRAME SIZE
DAYLIGHT OPENING

147 3/4" (3753)
150 3/4" (3829)
144 3/4" (3677)
144" (3658)
30" (762)[4]

35 1/4" (895)
36 3/4" (933)
32 3/4" (832)
32" (813)
26" (660)

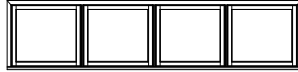

TWC3632-4

39 1/4" (997)
40 3/4" (1035)
36 3/4" (933)
36" (914)
30" (762)

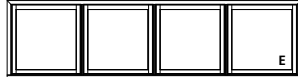

TWC3636-4

43 1/4" (1099)
44 3/4" (1137)
40 3/4" (1035)
40" (1016)
34" (864)



TWC3640-4

45 1/4" (1149)
46 3/4" (1187)
42 3/4" (1086)
42" (1067)
36" (914)

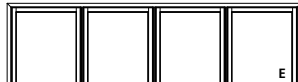

TWC3642-4

51 1/4" (1302)
52 3/4" (1340)
48 3/4" (1238)
48" (1219)
42" (1067)

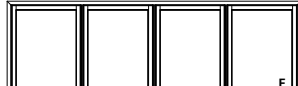

TWC3648-4

57 1/4" (1454)
58 3/4" (1492)
54 3/4" (1391)
54" (1372)
48" (1219)

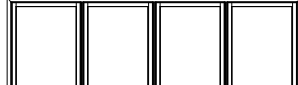

TWC3654-4

59 1/4" (1505)
60 3/4" (1543)
56 3/4" (1441)
56" (1422)
50" (1270)



TWC3656-4

63 1/4" (1607)
64 3/4" (1645)
60 3/4" (1543)
60" (1524)
54" (1372)

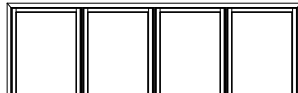

TWC3660-4

67 1/4" (1708)
68 3/4" (1746)
64 3/4" (1645)
64" (1626)
58" (1473)

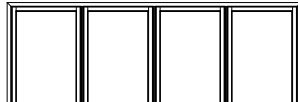

TWC3664-4

69 1/4" (1759)
70 3/4" (1797)
66 3/4" (1695)
66" (1676)
60" (1524)

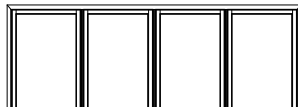

TWC3666-4

M.O. BRICKMOULD
M.O. ADAMS/FLAT CASING
ROUGH OPENING
FRAME SIZE
DAYLIGHT OPENING

147 3/4" (3753)
150 3/4" (3829)
144 3/4" (3677)
144" (3658)
30" (762)[4]

75 1/4" (1911)
76 3/4" (1949)
72 3/4" (1848)
72" (1829)
66" (1676)

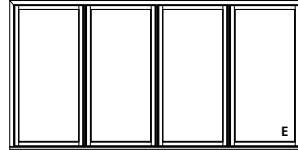

TWC3672-4

87 1/4" (2216)
88 3/4" (2254)
84 3/4" (2153)
84" (2134)
78" (1981)

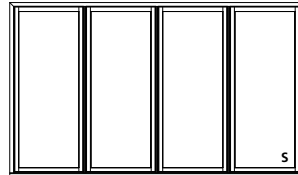

TWC3684-4

ELEVATION SYMBOL LEGEND:

M.O. = MASONRY OPENING
VALUES IN () ARE IN MILLIMETER CONVERSIONS
VALUES IN [] ARE NUMBER OF DAYLIGHT OPENINGS PER UNIT
E BASIC UNIT CLEAR OPENING EXCEEDS 20" IN WIDTH, 24" IN HEIGHT & A MINIMUM OF 5.7 SQ. FT.
S STATIONARY UNIT

Note Elevations shown DO NOT have exterior trim. Subtract 3/4" (19) from M.O. (Masonry Opening) for Unit Sizes. Masonry Openings above include Sill Nose, see Trim Options page for Sill Nose specifications. For other Trim Options refer to the Unit Sizing, Rough Opening & Masonry Openings page.

SCALE: 1/8" = 1'

PICTURE UNITS

M.O. BRICKMOULD	20 3/4"(527)	23 3/4"(603)	27 3/4"(705)	31 3/4"(806)	33 3/4"(857)	35 3/4"(908)	39 3/4"(1010)
M.O. ADAMS/FLAT CASING	23 3/4"(603)	26 3/4"(679)	30 3/4"(781)	34 3/4"(883)	36 3/4"(933)	38 3/4"(984)	42 3/4"(1086)
ROUGH OPENING	17 3/4"(451)	20 3/4"(527)	24 3/4"(629)	28 3/4"(730)	30 3/4"(781)	32 3/4"(832)	36 3/4"(933)
FRAME SIZE	17"(432)	20"(508)	24"(610)	28"(711)	30"(762)	32"(813)	36"(914)
DAYLIGHT OPENING	11"(279)	14"(356)	18"(457)	22"(559)	24"(610)	26"(660)	30"(762)
43 1/4"(1099) 44 3/4"(1137) 40 3/4"(1035) 0"(0) 34"(864)							
45 1/4"(1149) 46 3/4"(1187) 42 3/4"(1086) 42"(1067) 36"(914)							
51 1/4"(1302) 52 3/4"(1340) 48 3/4"(1238) 48"(1219) 42"(1067)							
57 1/4"(1454) 58 3/4"(1492) 54 3/4"(1391) 54"(1376) 48"(1219)							
59 1/4"(1505) 60 3/4"(1543) 56 3/4"(1441) 56"(1422) 50"(1270)							
63 1/4"(1607) 64 3/4"(1645) 60 3/4"(1543) 60"(1524) 54"(1372)							

ELEVATION SYMBOL LEGEND:

M.O. = MASONRY OPENING
VALUES IN () ARE IN MILLIMETER CONVERSIONS
NUMBER INDICATES DESIGN PRESSURE (DP) RATING WITH STANDARD GLAZING.

Note Elevations shown DO NOT have exterior trim. Subtract 3/4" (19) from M.O. (Masonry Opening) for Unit Sizes. Masonry Openings above include Sill Nose, see Trim Options page for Sill Nose specifications. For other Trim Options refer to the Unit Sizing, Rough Opening & Masonry Openings page.

SCALE: 1/4" = 1'

PICTURE UNITS

M.O. BRICKMOULD
M.O. ADAMS/FLAT CASING
ROUGH OPENING
FRAME SIZE
DAYLIGHT OPENING

20 3/4"(527)	23 3/4"(603)	27 3/4"(705)	31 3/4"(806)	33 3/4"(857)	35 3/4"(908)	39 3/4"(1010)
23 3/4"(603)	26 3/4"(679)	30 3/4"(781)	34 3/4"(883)	36 3/4"(933)	38 3/4"(984)	42 3/4"(1086)
17 3/4"(451)	20 3/4"(527)	24 3/4"(629)	28 3/4"(730)	30 3/4"(781)	32 3/4"(832)	36 3/4"(933)
17"(432)	20"(508)	24"(610)	28"(711)	30"(762)	32"(813)	36"(914)
11"(279)	14"(356)	18"(457)	22"(559)	24"(610)	26"(660)	30"(762)
67 1/4"(1708)						
68 3/4"(1746)						
64 3/4"(1645)						
58"(1473)						
TWCP1764	TWCP2064	TWCP2464	TWCP2864	TWCP3064	TWCP3264	TWCP3664
69 1/4"(1759)						
70 3/4"(1797)						
66 3/4"(1695)						
66"(1676)						
60"(1524)						
TWCP1766	TWCP2066	TWCP2466	TWCP2866	TWCP3066	TWCP3266	TWCP3666
75 1/4"(1911)						
76 3/4"(1949)						
72 3/4"(1848)						
72"(1829)						
66"(1676)						
TWCP1772	TWCP2072	TWCP2472	TWCP2872	TWCP3072	TWCP3272	TWCP3672
87 1/4"(2216)						
88 3/4"(2254)						
84 3/4"(2153)						
84"(2134)						
78"(1981)						
TWCP1784	TWCP2084	TWCP2484	TWCP2884	TWCP3084	TWCP3284	TWCP3684

ELEVATION SYMBOL LEGEND:
M.O. = MASONRY OPENING
VALUES IN () ARE IN MILLIMETER CONVERSIONS
##* NUMBER INDICATES DESIGN PRESSURE (DP) RATING WITH STANDARD GLAZING.

Note Elevations shown DO NOT have exterior trim. Subtract 3/4" (19) from M.O. (Masonry Opening) for Unit Sizes. Masonry Openings above include Sill Nose, see Trim Options page for Sill Nose specifications. For other Trim Options refer to the Unit Sizing, Rough Opening & Masonry Openings page.

SCALE: 1/4" = 1'

PICTURE UNITS

M.O. BRICKMOULD
M.O. ADAMS/FLAT CASING
ROUGH OPENING
FRAME SIZE
DAYLIGHT OPENING

43 3/4" (1111)
46 3/4" (1187)
40 3/4" (1035)
40" (1016)
34" (864)

45 3/4" (1162)
48 3/4" (1238)
42 3/4" (1086)
42" (1067)
36" (914)

51 3/4" (1314)
54 3/4" (1391)
48 3/4" (1238)
48" (1219)
42" (1067)

57 3/4" (1467)
60 3/4" (1543)
54 3/4" (1391)
54" (1372)
48" (1219)

59 3/4" (1517)
62 3/4" (1594)
56 3/4" (1441)
56" (1422)
50" (1270)

43 1/4" (1099)
44 3/4" (1137)
40 3/4" (1035)
40" (1016)
34" (864)

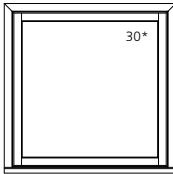

TWCP4040

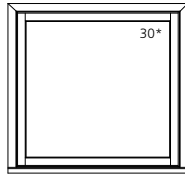

TWCP4240

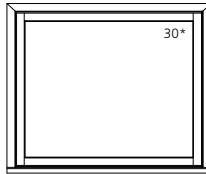

TWCP4840

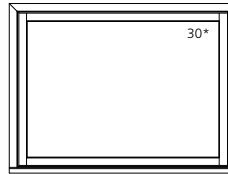

TWCP5440

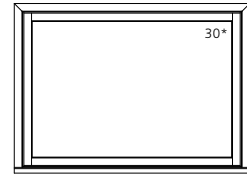

TWCP5640

45 1/4" (1149)
46 3/4" (1187)
42 3/4" (1086)
42" (1067)
36" (914)

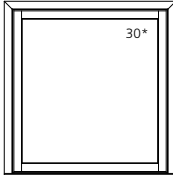

TWCP4042

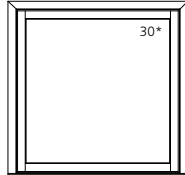

TWCP4242

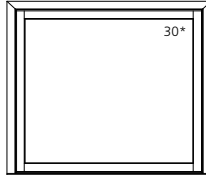

TWCP4842



TWCP5442

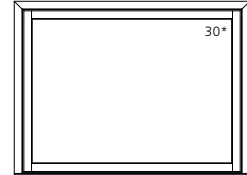

TWCP5642

51 1/4" (1302)
52 3/4" (1340)
48 3/4" (1238)
48" (1219)
42" (1067)

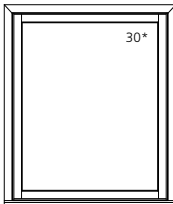

TWCP4048

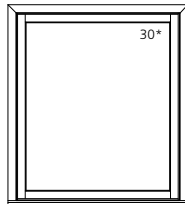

TWCP4248

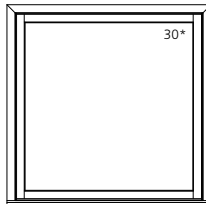

TWCP4848

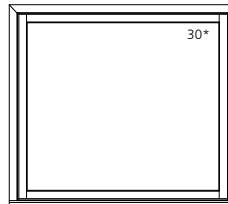

TWCP5448

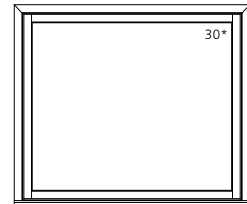

TWCP5648

57 1/4" (1454)
58 3/4" (1492)
54 3/4" (1391)
54" (1372)
48" (1219)

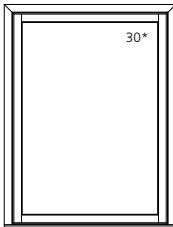

TWCP4054

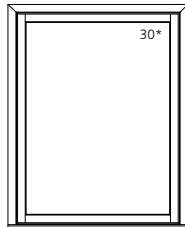

TWCP4254

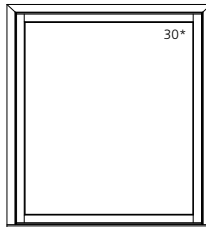

TWCP4854

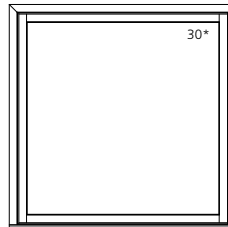

TWCP5454

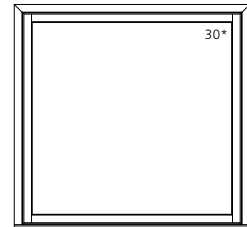

TWCP5654

59 1/4" (1505)
60 3/4" (1543)
56 3/4" (1441)
56" (1422)
50" (1270)

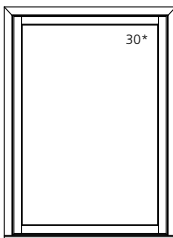

TWCP4056

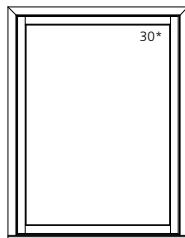

TWCP4256

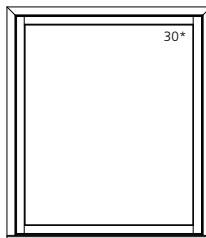

TWCP4856

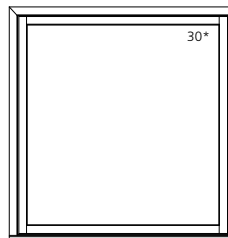

TWCP5456

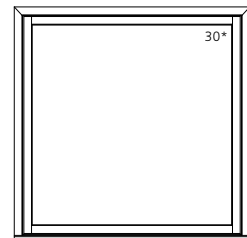

TWCP5656

63 1/4" (1607)
64 3/4" (1645)
60 3/4" (1543)
60" (1524)
54" (1372)

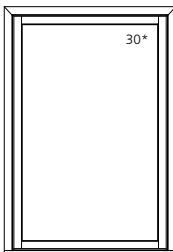

TWCP4060

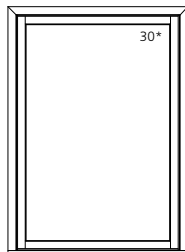

TWCP4260

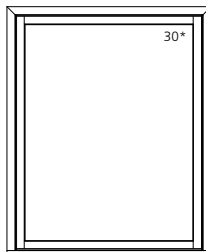

TWCP4860

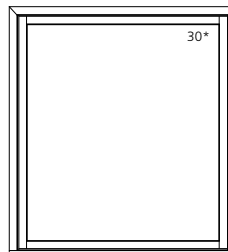

TWCP5460

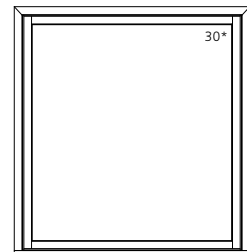

TWCP5660

ELEVATION SYMBOL LEGEND:

M.O. = MASONRY OPENING
VALUES IN () ARE IN MILLIMETER CONVERSIONS
NUMBER INDICATES DESIGN PRESSURE (DP) RATING WITH STANDARD GLAZING.

Note Elevations shown DO NOT have exterior trim. Subtract 3/4" (19) from M.O. (Masonry Opening) for Unit Sizes. Masonry Openings above include Sill Nose, see Trim Options page for Sill Nose specifications. For other Trim Options refer to the Unit Sizing, Rough Opening & Masonry Openings page.

SCALE: 1/4" = 1'

PICTURE UNITS

M.O. BRICKMOULD
M.O. ADAMS/FLAT CASING
ROUGH OPENING
FRAME SIZE
DAYLIGHT OPENING

43 3/4" (1111)
46 3/4" (1187)
40 3/4" (1035)
40" (1016)
34" (864)

45 3/4" (1162)
48 3/4" (1238)
42 3/4" (1086)
42" (1067)
36" (914)

51 3/4" (1314)
54 3/4" (1391)
48 3/4" (1238)
48" (1219)
42" (1067)

57 3/4" (1467)
60 3/4" (1543)
54 3/4" (1391)
54" (1372)
48" (1219)

59 3/4" (1517)
62 3/4" (1594)
56 3/4" (1441)
56" (1422)
50" (1270)

67 1/4" (1708)
68 3/4" (1746)
64 3/4" (1645)
64" (1626)
58" (1473)

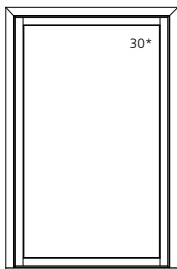

TWCP4064

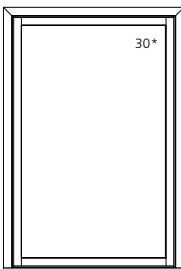

TWCP4264

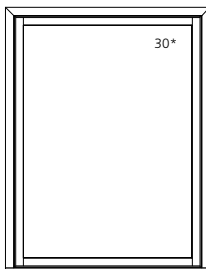

TWCP4864

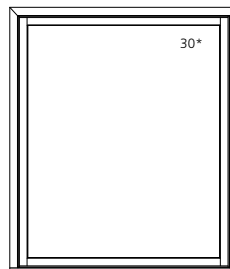

TWCP5464

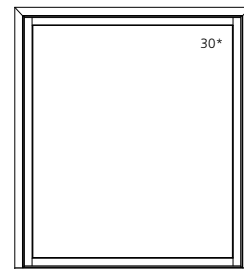

TWCP5664

69 1/4" (1759)
70 3/4" (1797)
66 3/4" (1695)
66" (1676)
60" (1524)

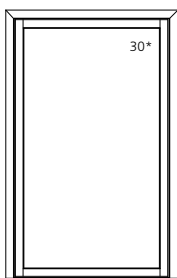

TWCP4066

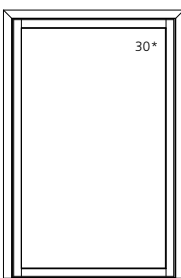

TWCP4266

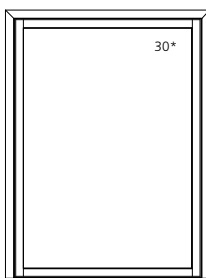

TWCP4866

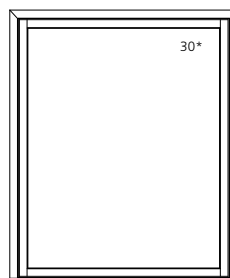

TWCP5466

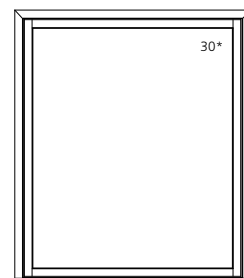

TWCP5666

75 1/4" (1911)
76 3/4" (1949)
72 3/4" (1848)
72" (1829)
66" (1676)

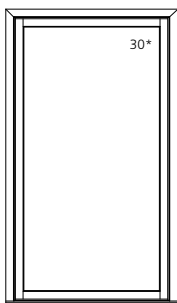

TWCP4072

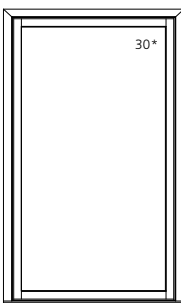

TWCP4272

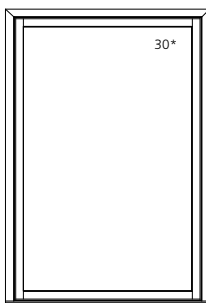

TWCP4872

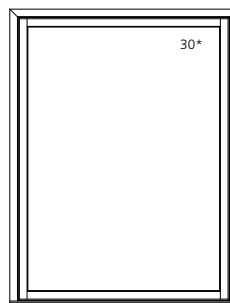

TWCP5472

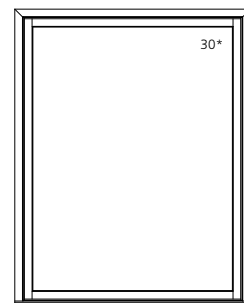

TWCP5672

87 1/4" (2216)
88 3/4" (2254)
84 3/4" (2153)
84" (2134)
78" (1981)

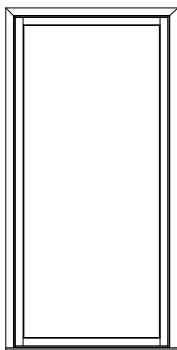

TWCP4084

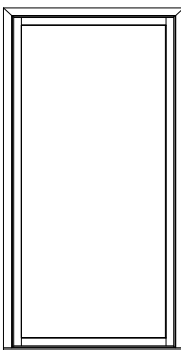

TWCP4284

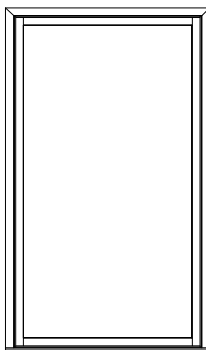

TWCP4884

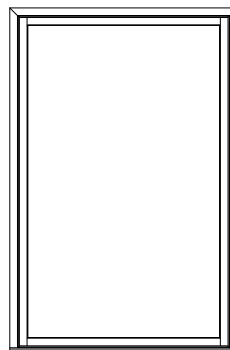

TWCP5484

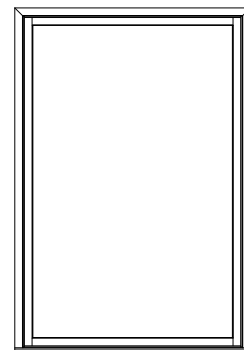

TWCP5684

ELEVATION SYMBOL LEGEND:

M.O. = MASONRY OPENING

VALUES IN () ARE IN MILLIMETER CONVERSIONS

NUMBER INDICATES DESIGN PRESSURE (DP) RATING WITH STANDARD GLAZING.

Note Elevations shown DO NOT have exterior trim. Subtract 3/4" (19) from M.O. (Masonry Opening) for Unit Sizes. Masonry Openings above include Sill Nose, see Trim Options page for Sill Nose specifications. For other Trim Options refer to the Unit Sizing, Rough Opening & Masonry Openings page.

SCALE: 1/4" = 1'

PICTURE UNITS

M.O. BRICKMOULD
M.O. ADAMS/FLAT CASING
ROUGH OPENING
FRAME SIZE
DAYLIGHT OPENING

63 3/4" (1619)
66 3/4" (1695)
60 3/4" (1543)
60" (1524)
54" (1372)

67 3/4" (1721)
70 3/4" (1797)
64 3/4" (1645)
64" (1626)
58" (1473)

69 3/4" (1772)
72 3/4" (1848)
66 3/4" (1695)
66" (1676)
60" (1524)

75 3/4" (1924)
78 3/4" (2000)
72 3/4" (1848)
72" (1829)
66" (1676)

43 1/4" (1099)
44 3/4" (1137)
40 3/4" (1035)
40" (1016)
34" (864)



TWCP6040

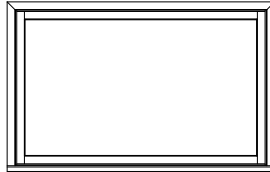

TWCP6440

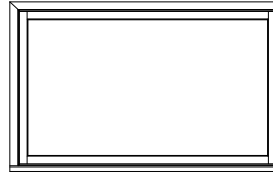

TWCP6640



TWCP7240

45 1/4" (1149)
46 3/4" (1187)
42 3/4" (1086)
42" (1067)
36" (914)

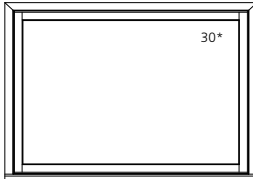

TWCP6042

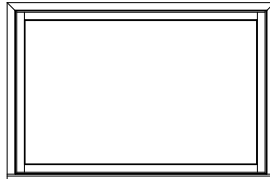

TWCP6442

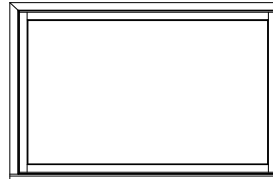

TWCP6642

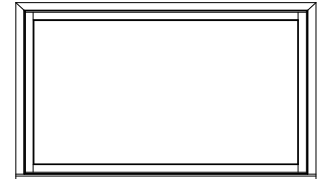

TWCP7242

51 1/4" (1302)
52 3/4" (1340)
48 3/4" (1238)
48" (1219)
42" (1067)

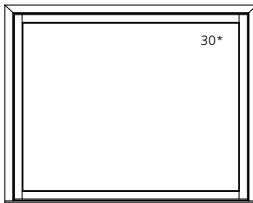

TWCP6048

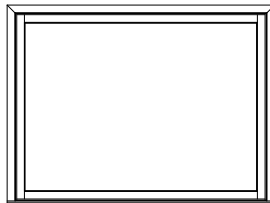

TWCP6448

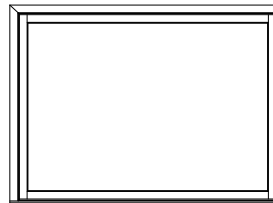

TWCP6648

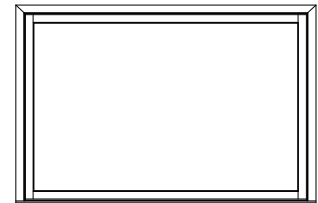

TWCP7248

57 1/4" (1454)
58 3/4" (1492)
54 3/4" (1391)
54" (1372)
48" (1219)

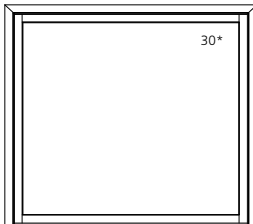

TWCP6054

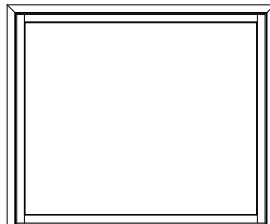

TWCP6454

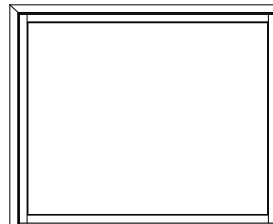

TWCP6654

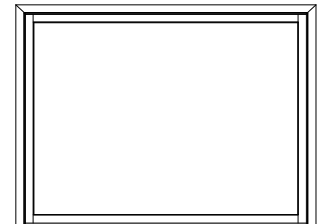

TWCP7254

59 1/4" (1505)
60 3/4" (1543)
56 3/4" (1441)
56" (1422)
50" (1270)

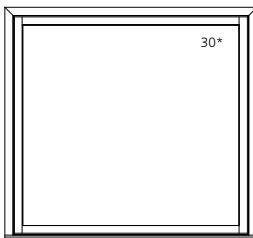

TWCP6056

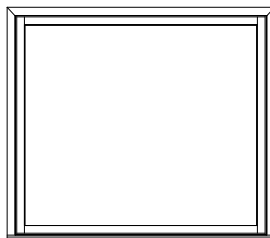

TWCP6456

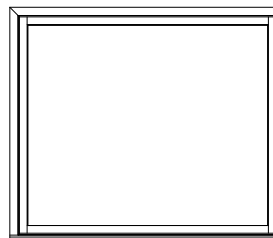

TWCP6656

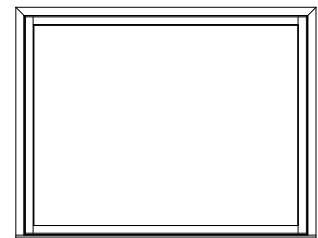

TWCP7256

63 1/4" (1607)
64 3/4" (1645)
60 3/4" (1543)
60" (1524)
54" (1372)

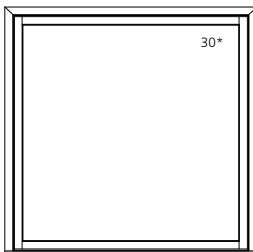

TWCP6060

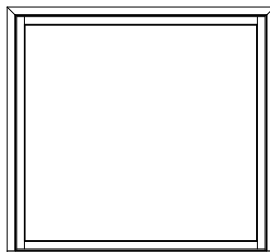

TWCP6460

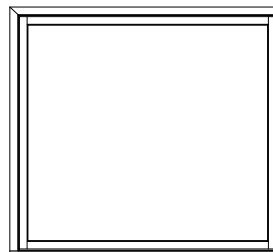

TWCP6660

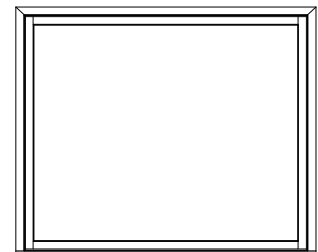

TWCP7260

ELEVATION SYMBOL LEGEND:

M.O. = MASONRY OPENING
VALUES IN () ARE IN MILLIMETER CONVERSIONS

NUMBER INDICATES DESIGN PRESSURE (DP) RATING WITH STANDARD GLAZING.

Note Elevations shown DO NOT have exterior trim. Subtract 3/4" (19) from M.O. (Masonry Opening) for Unit Sizes. Masonry Openings above include Sill Nose, see Trim Options page for Sill Nose specifications. For other Trim Options refer to the Unit Sizing, Rough Opening & Masonry Openings page.

SCALE: 1/4" = 1'

PICTURE UNITS

M.O. BRICKMOULD
M.O. ADAMS/FLAT CASING
ROUGH OPENING
FRAME SIZE
DAYLIGHT OPENING

63 3/4" (1619)
66 3/4" (1695)
60 3/4" (1543)
60" (1524)
54" (1372)

67 3/4" (1721)
70 3/4" (1797)
64 3/4" (1645)
64" (1626)
58" (1473)

69 3/4" (1772)
72 3/4" (1848)
66 3/4" (1695)
66" (1676)
60" (1524)

75 3/4" (1924)
78 3/4" (2000)
72 3/4" (1848)
72" (1829)
66" (1676)

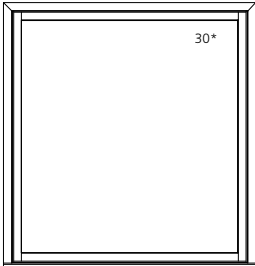
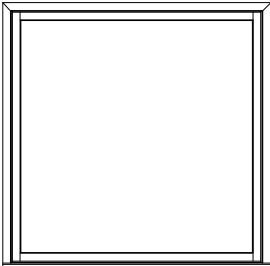
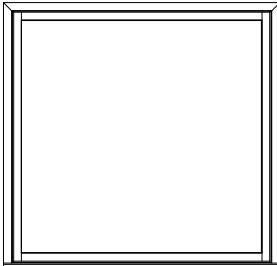
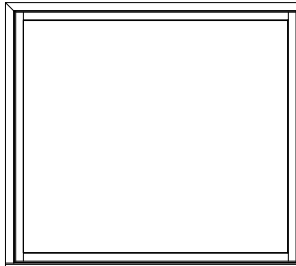
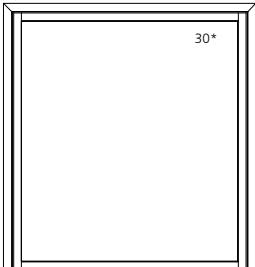
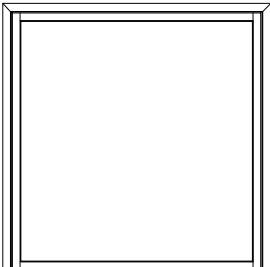
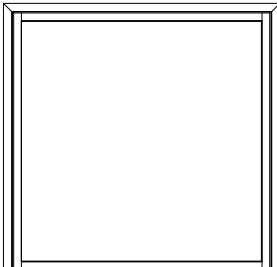
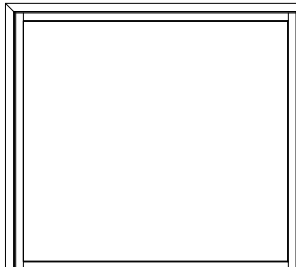
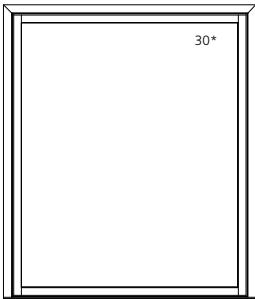
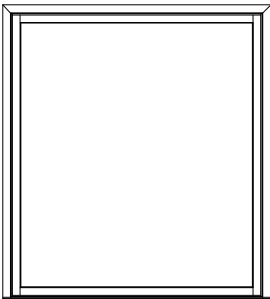
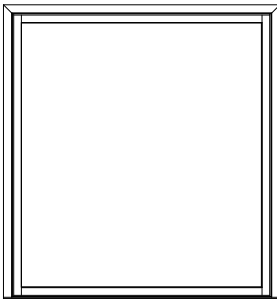
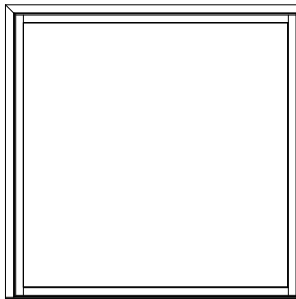
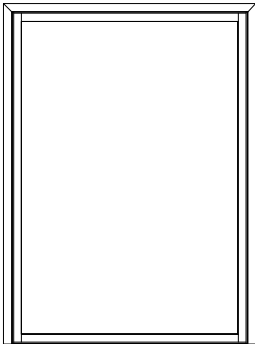
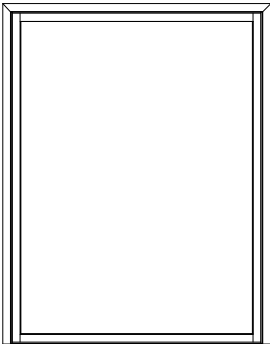
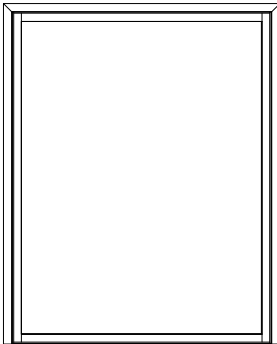
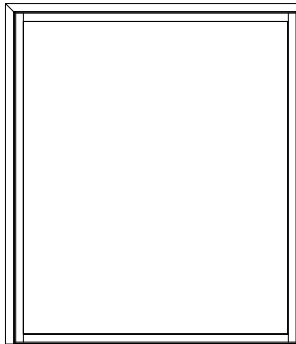
67 1/4" (1708) 68 3/4" (1746) 64 3/4" (1645) 64" (1626) 58" (1473)				
TWCP6064	TWCP6464	TWCP6664	TWCP7264	
69 1/4" (1759) 70 3/4" (1797) 66 3/4" (1695) 66" (1676) 60" (1524)				
TWCP6066	TWCP6466	TWCP6666	TWCP7266	
75 1/4" (1911) 76 3/4" (1949) 72 3/4" (1848) 72" (1829) 66" (1676)				
TWCP6072	TWCP6472	TWCP6672	TWCP7272	
87 1/4" (2216) 88 3/4" (2254) 84 3/4" (2153) 84" (2134) 78" (1981)				
TWCP6084	TWCP6484	TWCP6684	TWCP7284	

ELEVATION SYMBOL LEGEND:

M.O. = MASONRY OPENING

VALUES IN () ARE IN MILLIMETER CONVERSIONS

*** NUMBER INDICATES DESIGN PRESSURE (DP) RATING WITH STANDARD GLAZING.

Note Elevations shown DO NOT have exterior trim. Subtract 3/4" (19) from M.O. (Masonry Opening) for Unit Sizes. Masonry Openings above include Sill Nose, see Trim Options page for Sill Nose specifications. For other Trim Options refer to the Unit Sizing, Rough Opening & Masonry Openings page.

SCALE: 1/4" = 1'

PICTURE UNITS

M.O. BRICKMOULD
M.O. ADAMS/FLAT CASING
ROUGH OPENING
FRAME SIZE
DAYLIGHT OPENING

87 3/4" (2229)
90 3/4" (2305)
84 3/4" (2153)
84" (2134)
78" (1981)

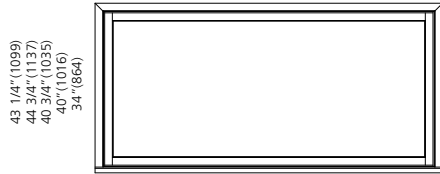

TWCP8440



TWCP8442

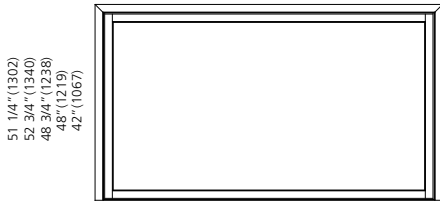

TWCP8448

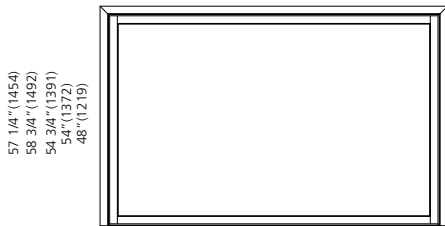

TWCP8454

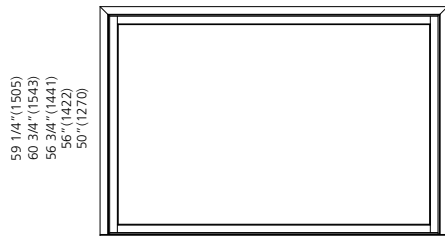

TWCP8456

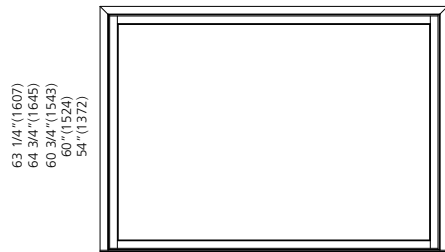

TWCP8460

M.O. BRICKMOULD
M.O. ADAMS/FLAT CASING
ROUGH OPENING
FRAME SIZE
DAYLIGHT OPENING

87 3/4" (2229)
90 3/4" (2305)
84 3/4" (2153)
84" (2134)
78" (1981)



TWCP8464

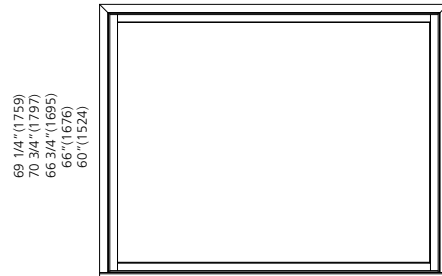

TWCP8466

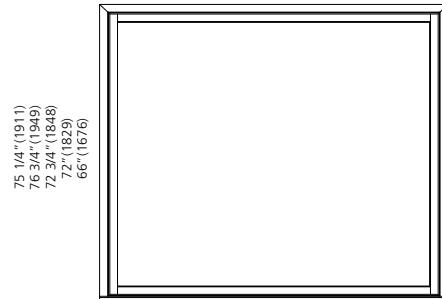

TWCP8472

ELEVATION SYMBOL LEGEND:
M.O. = MASONRY OPENING
VALUES IN () ARE IN MILLIMETER CONVERSIONS

Note Elevations shown DO NOT have exterior trim. Subtract 3/4" (19) from M.O. (Masonry Opening) for Unit Sizes. Masonry Openings above include Sill Nose, see Trim Options page for Sill Nose specifications. For other Trim Options refer to the Unit Sizing, Rough Opening & Masonry Openings page.

SCALE: 1/4" = 1'

PICTURE UNIT WITH 20" FLANKERS

M.O. BRICKMOULD	83 3/4" (2127)	91 3/4" (2330)	99 3/4" (2534)	103 3/4" (2635)	107 3/4" (2737)
M.O. ADAMS/FLAT CASING	86 3/4" (2203)	94 3/4" (2407)	102 3/4" (2610)	106 3/4" (2711)	110 3/4" (2813)
ROUGH OPENING	80 3/4" (2051)	88 3/4" (2254)	96 3/4" (2457)	100 3/4" (2559)	104 3/4" (2661)
FRAME SIZE	80" (2032)	88" (2235)	96" (2438)	100" (2540)	104" (2642)
DAYLIGHT OPENING	14" (356) [2] 34" (864)	14" (356) [2] 42" (1067)	14" (356) [2] 50" (1270)	14" (356) [2] 54" (1372)	14" (356) [2] 58" (1473)
43 1/4" (1089) 44 3/4" (1137) 40 3/4" (1035) 40" (1016) 34" (864)					
TWC4040-20	TWC4840-20	TWC5640-20	TWC6040-20	TWC6440-20	
45 1/4" (1149) 46 3/4" (1187) 43 3/4" (1086) 42" (1067) 36" (914)					
TWC4042-20	TWC4842-20	TWC5642-20	TWC6042-20	TWC6442-20	
51 1/4" (1302) 52 3/4" (1340) 48 3/4" (1238) 48" (1219) 42" (1067)					
TWC4048-20	TWC4848-20	TWC5648-20	TWC6048-20	TWC6448-20	
57 1/4" (1454) 58 3/4" (1492) 54 3/4" (1391) 54" (1372) 48" (1219)					
TWC4054-20	TWC4854-20	TWC5654-20	TWC6054-20	TWC6454-20	
59 1/4" (1505) 60 3/4" (1543) 56 3/4" (1441) 56" (1422) 50" (1270)					
TWC4056-20	TWC4856-20	TWC5656-20	TWC6056-20	TWC6456-20	
63 1/4" (1607) 63 3/4" (1645) 60 3/4" (1543) 60" (1524) 54" (1372)					
TWC4060-20	TWC4860-20	TWC5660-20	TWC6060-20	TWC6460-20	
67 1/4" (1708) 68 3/4" (1746) 64 3/4" (1645) 64" (1626) 58" (1473)					
TWC4064-20	TWC4864-20	TWC5664-20	TWC6064-20	TWC6464-20	
69 1/4" (1759) 70 3/4" (1797) 66 3/4" (1695) 66" (1676) 60" (1524)					
TWC4066-20	TWC4866-20	TWC5666-20	TWC6066-20	TWC6466-20	
75 1/4" (1911) 76 3/4" (1949) 72 3/4" (1848) 72" (1829) 66" (1676)					
TWC4072-20	TWC4872-20	TWC5672-20	TWC6072-20	TWC6472-20	

ELEVATION SYMBOL LEGEND:
M.O. = MASONRY OPENING
 VALUES IN () ARE IN MILLIMETER CONVERSIONS
 VALUES IN [] ARE NUMBER OF DAYLIGHT OPENINGS PER UNIT

Note Elevations shown DO NOT have exterior trim. Subtract 3/4" (19) from M.O. (Masonry Opening) for Unit Sizes. Masonry Openings above include Sill Nose, see Trim Options page for Sill Nose specifications. For other Trim Options refer to the Unit Sizing, Rough Opening & Masonry Openings page.

SCALE: 1/8" = 1'

PICTURE UNIT WITH 20" FLANKERS

M.O. BRICKMOULD	115 3/4" (2940)
M.O. ADAMS/FLAT CASING	118 3/4" (3016)
ROUGH OPENING	112 3/4" (2864)
FRAME SIZE	112" (2849)
DAYLIGHT OPENING	14" (356) [2] 66" (1676)

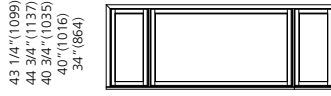

TWC7240-20

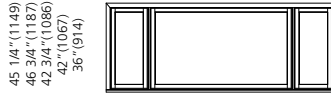

TWC7242-20



TWC7248-20

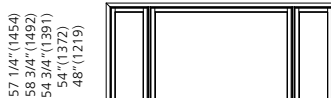

TWC7254-20

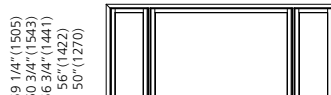

TWC7256-20

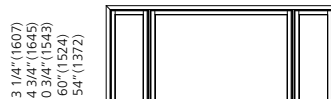

TWC7260-20

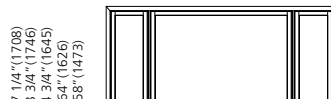

TWC7264-20

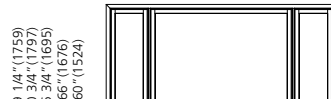

TWC7266-20

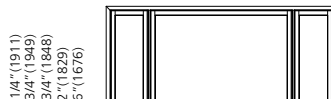

TWC7272-20

ELEVATION SYMBOL LEGEND:
M.O. = MASONRY OPENING
VALUES IN () ARE IN MILLIMETER CONVERSIONS
VALUES IN [] ARE NUMBER OF DAYLIGHT OPENINGS PER UNIT

Note Elevations shown DO NOT have exterior trim. Subtract 3/4" (19) from M.O. (Masonry Opening) for Unit Sizes. Masonry Openings above include Sill Nose, see Trim Options page for Sill Nose specifications. For other Trim Options refer to the Unit Sizing, Rough Opening & Masonry Openings page.

SCALE: 1/8" = 1'

PICTURE UNIT WITH 24" FLANKERS

M.O. BRICKMOULD M.O. ADAMS/FLAT CASING ROUGH OPENING FRAME SIZE DAYLIGHT OPENING	91 3/4"(2330) 94 3/4"(2407) 88 3/4"(2254) 88"(2235) 18"(457)[2] 34"(864)	99 3/4"(2534) 102 3/4"(2610) 96 3/4"(2457) 96"(2438) 18"(457)[2] 42"(1067)	107 3/4"(2737) 110 3/4"(2813) 104 3/4"(2661) 104"(2642) 18"(457)[2] 50"(1270)	111 3/4"(2838) 114 3/4"(2915) 108 3/4"(2762) 108"(2743) 18"(457)[2] 54"(1372)
43 1/4"(1099) 44 3/4"(1137) 40 3/4"(1035) 40"(1016) 34"(864)				
45 1/4"(1149) 46 3/4"(1187) 42 3/4"(1086) 42"(1067) 36"(914)				
51 1/4"(1302) 52 3/4"(1340) 48 3/4"(1238) 48"(1219) 42"(1067)				
57 1/4"(1454) 58 3/4"(1492) 54 3/4"(1391) 54"(1372) 48"(1219)				
59 1/4"(1505) 60 3/4"(1543) 56 3/4"(1441) 56"(1422) 50"(1270)				
63 1/4"(1607) 64 3/4"(1645) 60 3/4"(1543) 60"(1524) 54"(1372)				
67 1/4"(1708) 68 3/4"(1746) 64 3/4"(1645) 64"(1626) 58"(1473)				
69 1/4"(1759) 70 3/4"(1797) 66 3/4"(1695) 66"(1676) 60"(1524)				
75 1/4"(1911) 76 3/4"(1949) 72 3/4"(1848) 72"(1829) 66"(1676)				

ELEVATION SYMBOL LEGEND:
M.O. = MASONRY OPENING
VALUES IN () ARE IN MILLIMETER CONVERSIONS
VALUES IN [] ARE NUMBER OF DAYLIGHT OPENINGS PER UNIT

Note Elevations shown DO NOT have exterior trim. Subtract 3/4" (19) from M.O. (Masonry Opening) for Unit Sizes. Masonry Openings above include Sill Nose, see Trim Options page for Sill Nose specifications. For other Trim Options refer to the Unit Sizing, Rough Opening & Masonry Openings page.

SCALE: 1/8" = 1'

PICTURE UNIT WITH 24" FLANKERS

M.O. BRICKMOULD	115 3/4" (2940)	123 3/4" (3143)
M.O. ADAMS/FLAT CASING	118 3/4" (3016)	126 3/4" (3219)
ROUGH OPENING	112 3/4" (2864)	120 3/4" (3067)
FRAME SIZE	112" (2849)	120" (3048)
DAYLIGHT OPENING	18" (457) [2] 58" (1473)	18" (457) [2] 66" (1676)
43 1/4" (1099) 44 3/4" (1137) 40 3/4" (1035) 34" (864)		
45 1/4" (1149) 46 3/4" (1187) 42 3/4" (1086) 36" (914)		
51 1/4" (1302) 52 3/4" (1340) 48 3/4" (1238) 42" (1067)		
57 1/4" (1454) 58 3/4" (1492) 54 3/4" (1391) 48" (1219)		
59 1/4" (1505) 60 3/4" (1543) 56 3/4" (1441) 50" (1270)		
63 1/4" (1607) 64 3/4" (1645) 60 3/4" (1543) 54" (1372)		
67 1/4" (1708) 68 3/4" (1746) 64 3/4" (1645) 58" (1473)		
69 1/4" (1759) 70 3/4" (1797) 66 3/4" (1695) 60" (1524)		
75 1/4" (1911) 76 3/4" (1949) 72 3/4" (1848) 66" (1676)		

ELEVATION SYMBOL LEGEND:
M.O. = MASONRY OPENING
VALUES IN () ARE IN MILLIMETER CONVERSIONS
VALUES IN [] ARE NUMBER OF DAYLIGHT OPENINGS PER UNIT

Note Elevations shown DO NOT have exterior trim. Subtract 3/4" (19) from M.O. (Masonry Opening) for Unit Sizes. Masonry Openings above include Sill Nose, see Trim Options page for Sill Nose specifications. For other Trim Options refer to the Unit Sizing, Rough Opening & Masonry Openings page.

SCALE: 1/8" = 1'

PICTURE UNIT WITH 28" FLANKERS

M.O. BRICKMOULD
M.O. ADAMS/FLAT CASING
ROUGH OPENING
FRAME SIZE
DAYLIGHT OPENING

99 3/4" (2534) 102 3/4" (2610) 96 3/4" (2457) 96" (2438)	107 3/4" (2737) 110 3/4" (2813) 104 3/4" (2661) 104" (2642)	115 3/4" (2940) 118 3/4" (3016) 112 3/4" (2864) 112" (2849)	119 3/4" (3042) 122 3/4" (3118) 116 3/4" (2965) 116" (2946)
22" [2] (559) 34" (864)	22" [2] (559) 42" (1067)	22" [2] (559) 50" (1270)	22" [2] (559) 54" (1372)
43 1/4" (1099) 44 3/4" (1137) 40 3/4" (1035) 40" (1016) 34" (864)			
45 1/4" (1149) 46 3/4" (1187) 42 3/4" (1086) 42" (1067) 36" (914)			
51 1/4" (1302) 52 3/4" (1340) 48 3/4" (1238) 48" (1219) 42" (1067)			
57 1/4" (1454) 58 3/4" (1492) 54 3/4" (1391) 54" (1372) 48" (1219)			
59 1/4" (1505) 60 3/4" (1543) 56 3/4" (1441) 56" (1422) 50" (1270)			
63 1/4" (1607) 64 3/4" (1645) 60 3/4" (1543) 60" (1524) 54" (1372)			
67 1/4" (1708) 68 3/4" (1746) 64 3/4" (1645) 64" (1626) 58" (1473)			
69 1/4" (1759) 70 3/4" (1797) 66 3/4" (1695) 66" (1676) 60" (1524)			
75 1/4" (1911) 76 3/4" (1949) 72 3/4" (1848) 72" (1829) 66" (1676)			
TWC4040-28	TWC4840-28	TWC5640-28	TWC6040-28
TWC4042-28	TWC4842-28	TWC5642-28	TWC6042-28
TWC4048-28	TWC4848-28	TWC5648-28	TWC6048-28
TWC4054-28	TWC4854-28	TWC5654-28	TWC6054-28
TWC4056-28	TWC4856-28	TWC5656-28	TWC6056-28
TWC4060-28	TWC4860-28	TWC5660-28	TWC6060-28
TWC4064-28	TWC4864-28	TWC5664-28	TWC6064-28
TWC4066-28	TWC4866-28	TWC5666-28	TWC6066-28
TWC4072-28	TWC4872-28	TWC5672-28	TWC6072-28

ELEVATION SYMBOL LEGEND:

M.O. = MASONRY OPENING
VALUES IN () ARE IN MILLIMETER CONVERSIONS
VALUES IN [] ARE NUMBER OF DAYLIGHT OPENINGS PER UNIT
E BASIC UNIT CLEAR OPENING EXCEEDS 20" IN WIDTH, 24" IN HEIGHT & A MINIMUM OF 5.7 SQ. FT.

Note Elevations shown DO NOT have exterior trim. Subtract 3/4" (19) from M.O. (Masonry Opening) for Unit Sizes. Masonry Openings above include Sill Nose, see Trim Options page for Sill Nose specifications. For other Trim Options refer to the Unit Sizing, Rough Opening & Masonry Openings page.

SCALE: 1/8" = 1'

PICTURE UNIT WITH 28" FLANKERS

M.O. BRICKMOULD	123 3/4" (3143)	131 3/4" (3346)
M.O. ADAMS/FLAT CASING	126 3/4" (3219)	134 3/4" (3423)
ROUGH OPENING	120 3/4" (3067)	128 3/4" (3270)
FRAME SIZE	120" (3048)	128" (3251)
DAYLIGHT OPENING	22" [2] (559) 60" (1524)	22" [2] (559) 66" (1676)
43 1/4" (1099) 44 3/4" (1137) 40 3/4" (1035) 40" (1016) 34" (864)		
45 1/4" (1149) 46 3/4" (1187) 42 3/4" (1086) 42" (1067) 36" (914)		
51 1/4" (1302) 52 3/4" (1340) 48 3/4" (1238) 48" (1219) 42" (1067)		
57 1/4" (1454) 58 3/4" (1492) 54 3/4" (1391) 54" (1372) 48" (1219)		
59 1/4" (1505) 60 3/4" (1543) 56 3/4" (1441) 56" (1422) 50" (1270)		
63 1/4" (1607) 64 3/4" (1645) 60 3/4" (1543) 60" (1524) 54" (1372)		
67 1/4" (1708) 68 3/4" (1746) 64 3/4" (1645) 64" (1626) 58" (1473)		
69 1/4" (1759) 70 3/4" (1797) 66 3/4" (1695) 66" (1676) 60" (1524)		
75 1/4" (1911) 76 3/4" (1949) 72 3/4" (1848) 72" (1829) 66" (1676)		

ELEVATION SYMBOL LEGEND:

M.O. = MASONRY OPENING
VALUES IN () ARE IN MILLIMETER CONVERSIONS
VALUES IN [] ARE NUMBER OF DAYLIGHT OPENINGS PER UNIT
E BASIC UNIT CLEAR OPENING EXCEEDS 20" IN WIDTH, 24" IN HEIGHT & A MINIMUM OF 5.7 SQ. FT.

Note Elevations shown DO NOT have exterior trim. Subtract 3/4" (19) from M.O. (Masonry Opening) for Unit Sizes. Masonry Openings above include Sill Nose, see Trim Options page for Sill Nose specifications. For other Trim Options refer to the Unit Sizing, Rough Opening & Masonry Openings page.

SCALE: 1/8" = 1'

30° BAY UNIT WITH 20" FLANKERS

M.O. BRICKMOULD
M.O. ADAMS/FLAT CASING
ROUGH OPENING
FRAME SIZE
DAYLIGHT OPENING

72 3/8" (1838)
75 11/16" (1922)
78 11/16" (1945)
78 11/16" (1945)
14" (356) [2] 24" (610)

83 3/8" (2118)
85 11/16" (2176)
88 11/16" (2222)
88 11/16" (2222)
14" (356) [2] 36" (914)

91 3/8" (2321)
93 11/16" (2380)
96 11/16" (2422)
96 11/16" (2422)
14" (356) [2] 42" (1067)

99 3/8" (2524)
101 11/16" (2583)
104 11/16" (2625)
104 11/16" (2625)
14" (356) [2] 48" (1219)

103 3/8" (2626)
105 11/16" (2684)
108 11/16" (2730)
108 11/16" (2730)
14" (356) [2] 54" (1372)

35 1/4" (895)
36 3/4" (933)
38 1/4" (970)
33 1/2" (851)
26" (660)



TWC3Y3032-20

39 1/4" (997)
40 3/4" (1035)
38 1/4" (972)
37 1/2" (953)
30" (762)

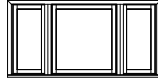

TWC3Y3036-20

43 1/4" (1099)
44 3/4" (1137)
42 1/4" (1073)
41 1/2" (1054)
34" (864)

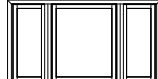

TWC3Y3040-20



TWC3Y4040-20



TWC3Y4840-20

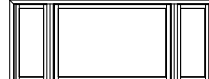

TWC3Y5640-20



TWC3Y6040-20

45 1/4" (1149)
46 3/4" (1187)
44 1/4" (1124)
43 1/2" (1105)
36" (914)

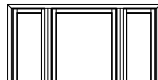

TWC3Y3042-20

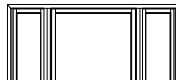

TWC3Y4042-20



TWC3Y4842-20



TWC3Y5642-20



TWC3Y6042-20

51 1/4" (1302)
52 3/4" (1340)
50 1/4" (1276)
49 1/2" (1257)
42" (1067)

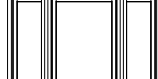

TWC3Y3048-20



TWC3Y4048-20



TWC3Y4848-20



TWC3Y5648-20



TWC3Y6048-20

57 1/4" (1454)
58 3/4" (1492)
56 1/4" (1429)
55 1/2" (1410)
48" (1219)

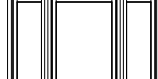

TWC3Y3054-20



TWC3Y4054-20



TWC3Y4854-20

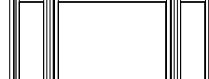

TWC3Y5654-20

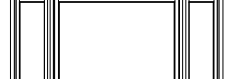

TWC3Y6054-20

59 1/4" (1505)
60 3/4" (1543)
58 1/4" (1480)
57 1/2" (1461)
50" (1270)

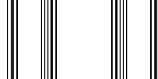

TWC3Y3056-20



TWC3Y4056-20



TWC3Y4856-20



TWC3Y5656-20



TWC3Y6056-20

63 1/4" (1607)
64 3/4" (1645)
62 1/4" (1581)
61 1/2" (1562)
54" (1372)

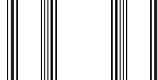

TWC3Y3060-20



TWC3Y4060-20



TWC3Y4860-20



TWC3Y5660-20



TWC3Y6060-20

67 1/4" (1708)
68 3/4" (1746)
66 1/4" (1683)
65 1/2" (1664)
58" (1473)

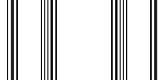

TWC3Y3064-20



TWC3Y4064-20



TWC3Y4864-20



TWC3Y5664-20



TWC3Y6064-20

69 1/4" (1759)
70 3/4" (1797)
68 1/4" (1734)
67 1/2" (1715)
60" (1524)

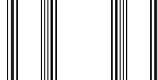

TWC3Y3066-20



TWC3Y4066-20



TWC3Y4866-20



TWC3Y5666-20



TWC3Y6066-20

75 1/4" (1911)
76 3/4" (1949)
74 1/4" (1886)
73 1/2" (1867)
66" (1676)

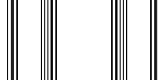

TWC3Y3072-20



TWC3Y4072-20



TWC3Y4872-20



TWC3Y5672-20



TWC3Y6072-20

ELEVATION SYMBOL LEGEND:

M.O. = MASONRY OPENING
VALUES IN () ARE IN MILLIMETER CONVERSIONS
VALUES IN [] ARE NUMBER OF DAYLIGHT OPENINGS PER UNIT

Note Elevations shown DO NOT have exterior trim. Subtract 3/4" (19) from M.O. (Masonry Opening) for Unit Sizes. Masonry Openings above include Sill Nose, see Trim Options page for Sill Nose specifications. For other Trim Options refer to the Unit Sizing, Rough Opening & Masonry Openings page.

SCALE: 1/8" = 1'

30° BAY UNIT WITH 20" FLANKERS

M.O. BRICKMOULD M.O. ADAMS/FLAT CASING ROUGH OPENING FRAME SIZE DAYLIGHT OPENING	107 3/8" (2727) 109 11/16" (2768) 102 11/16" (2608) 102 11/16" (2608) 14" (356) [2] 60" (1524)	115 3/8" (2931) 117 11/16" (2989) 110 11/16" (2811) 110 11/16" (2811) 14" (356) [2] 66" (1676)
43 1/4" (1099) 44 3/4" (1137) 42 1/4" (1073) 41 1/2" (1054) 34 (864)		
45 1/4" (1149) 46 3/4" (1187) 44 1/4" (1124) 43 1/2" (1105) 36 (914)		
51 1/4" (1302) 52 3/4" (1340) 50 1/4" (1276) 49 1/2" (1257) 42 (1067)		
57 1/4" (1454) 58 3/4" (1492) 56 1/4" (1429) 55 1/2" (1410) 48 (1219)		
59 1/4" (1505) 60 3/4" (1543) 58 1/4" (1480) 57 1/2" (1468) 50 (1270)		
63 1/4" (1607) 64 3/4" (1645) 62 1/4" (1581) 61 1/2" (1562) 54 (1372)		
67 1/4" (1708) 68 3/4" (1746) 66 1/4" (1683) 65 1/2" (1664) 58 (1473)		
69 1/4" (1759) 70 3/4" (1797) 68 1/4" (1734) 67 1/2" (1715) 60 (1524)		
75 1/4" (1911) 76 3/4" (1949) 74 1/4" (1886) 73 1/2" (1867) 66 (1676)		

ELEVATION SYMBOL LEGEND:
M.O. = MASONRY OPENING
VALUES IN () ARE IN MILLIMETER CONVERSIONS
VALUES IN [] ARE NUMBER OF DAYLIGHT OPENINGS PER UNIT

Note Elevations shown DO NOT have exterior trim. Subtract 3/4" (19) from M.O. (Masonry Opening) for Unit Sizes. Masonry Openings above include Sill Nose, see Trim Options page for Sill Nose specifications. For other Trim Options refer to the Unit Sizing, Rough Opening & Masonry Openings page.

SCALE: 1/8" = 1'

30° BAY UNIT WITH 24" FLANKERS

M.O. BRICKMOULD
M.O. ADAMS/FLAT CASING
ROUGH OPENING
FRAME SIZE
DAYLIGHT OPENING

80 5/16" (2040)
82 5/8" (2099)
75 5/8" (1921)
75 5/8" (1921)
18" (457) [2] 24" (610)

90 5/16" (2294)
92 5/8" (2353)
85 5/8" (2175)
85 5/8" (2175)
18" (457) [2] 36" (914)

98 5/16" (2497)
100 5/8" (2556)
93 5/8" (2378)
93 5/8" (2378)
18" (457) [2] 42" (1067)

106 5/16" (2700)
108 5/8" (2759)
101 5/8" (2581)
101 5/8" (2581)
18" (457) [2] 48" (1219)

110 5/16" (2802)
112 5/8" (2861)
105 5/8" (2683)
105 5/8" (2683)
18" (457) [2] 54" (1372)

35 1/4" (895)
36 3/4" (933)
34 1/4" (851)
33 1/2" (851)
26" (660)

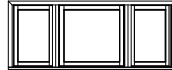

TWC3Y3032-24

39 1/4" (997)
40 3/4" (1035)
38 1/4" (972)
37 1/2" (953)
30" (762)

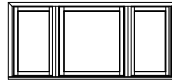

TWC3Y3036-24

43 1/4" (1099)
44 3/4" (1137)
42 1/4" (1073)
41 1/2" (1054)
34" (864)

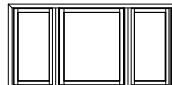

TWC3Y3040-24



TWC3Y4040-24

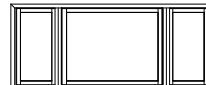

TWC3Y4840-24



TWC3Y5640-24



TWC3Y6040-24

45 1/4" (1149)
46 3/4" (1187)
44 1/4" (1124)
43 1/2" (1105)
36" (914)

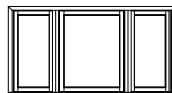

TWC3Y3042-24

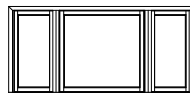

TWC3Y4042-24

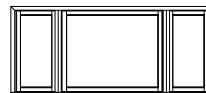

TWC3Y4842-24



TWC3Y5642-24



TWC3Y6042-24

51 1/4" (1302)
52 3/4" (1340)
50 1/4" (1276)
49 1/2" (1257)
42" (1067)

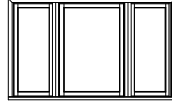

TWC3Y3048-24

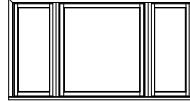

TWC3Y4048-24

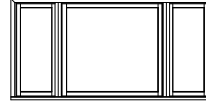

TWC3Y4848-24

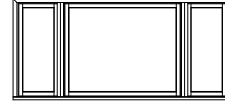

TWC3Y5648-24



TWC3Y6048-24

57 1/4" (1454)
58 3/4" (1492)
56 1/4" (1429)
55 1/2" (1410)
48" (1219)

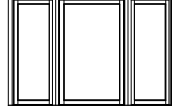

TWC3Y3054-24

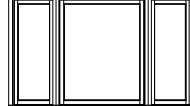

TWC3Y4054-24

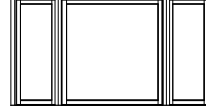

TWC3Y4854-24

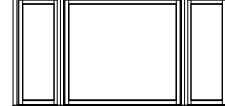

TWC3Y5654-24



TWC3Y6054-24

59 1/4" (1505)
60 3/4" (1543)
58 1/4" (1480)
57 1/2" (1461)
50" (1270)

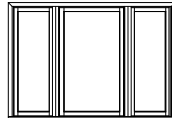

TWC3Y3056-24

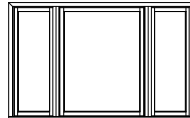

TWC3Y4056-24

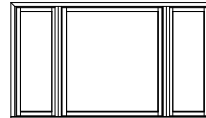

TWC3Y4856-24

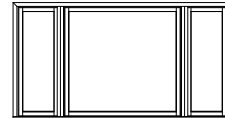

TWC3Y5656-24

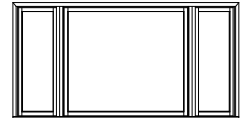

TWC3Y6056-24

63 1/4" (1607)
64 3/4" (1645)
62 1/4" (1581)
61 1/2" (1562)
54" (1372)

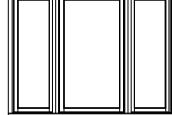

TWC3Y3060-24

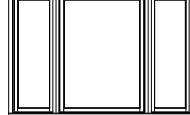

TWC3Y4060-24

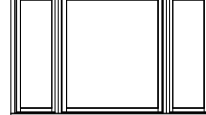

TWC3Y4860-24

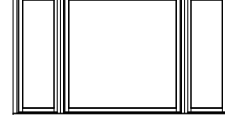

TWC3Y5660-24



TWC3Y6060-24

67 1/4" (1708)
68 3/4" (1746)
66 1/4" (1683)
65 1/2" (1664)
58" (1473)

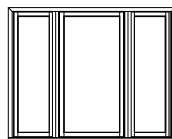

TWC3Y3064-24

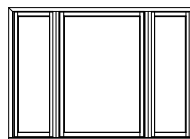

TWC3Y4064-24

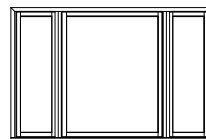

TWC3Y4864-24

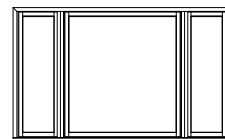

TWC3Y5664-24

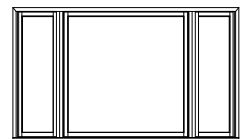

TWC3Y6064-24

69 1/4" (1759)
70 3/4" (1797)
68 1/4" (1734)
67 1/2" (1715)
60" (1524)

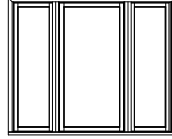

TWC3Y3066-24

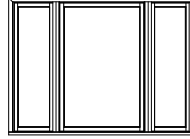

TWC3Y4066-24

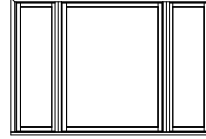

TWC3Y4866-24

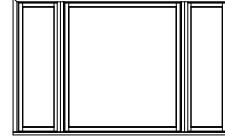

TWC3Y5666-24

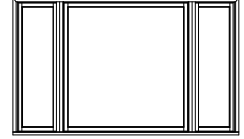

TWC3Y6066-24

75 1/4" (1911)
76 3/4" (1949)
74 1/4" (1886)
73 1/2" (1867)
66" (1676)

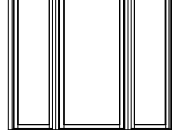

TWC3Y3072-24

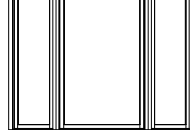

TWC3Y4072-24

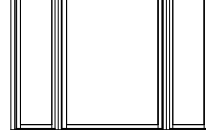

TWC3Y4872-24

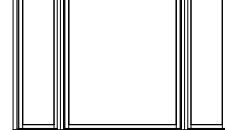

TWC3Y5672-24

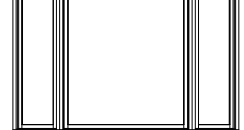

TWC3Y6072-24

ELEVATION SYMBOL LEGEND:

M.O. = MASONRY OPENING
VALUES IN () ARE IN MILLIMETER CONVERSIONS
VALUES IN [] ARE NUMBER OF DAYLIGHT OPENINGS PER UNIT

Note Elevations shown DO NOT have exterior trim. Subtract 3/4" (19) from M.O. (Masonry Opening) for Unit Sizes. Masonry Openings above include Sill Nose, see Trim Options page for Sill Nose specifications. For other Trim Options refer to the Unit Sizing, Rough Opening & Masonry Openings page.

SCALE: 1/8" = 1'

30° BAY UNIT WITH 24" FLANKERS

M.O. BRICKMOULD M.O. ADAMS/FLAT CASING ROUGH OPENING FRAME SIZE DAYLIGHT OPENING	114 5/16" (2904) 116 5/8" (2963) 109 5/8" (2784) 109 5/8" (2784) 18" (457) [2] 60" (1524)	122 5/16" (3107) 124 5/8" (3166) 117 5/8" (2988) 117 5/8" (2988) 18" (457) [2] 66" (1676)
43 1/4" (1099) 44 3/4" (1137) 42 1/4" (1073) 41 1/2" (1054) 34" (864)		
TWC3Y6440-24	TWC3Y7240-24	
45 1/4" (1149) 46 3/4" (1187) 44 1/4" (1124) 43 1/2" (1105) 36" (914)		
TWC3Y6442-24	TWC3Y7242-24	
51 1/4" (1302) 52 3/4" (1340) 50 1/4" (1276) 49 1/2" (1257) 42" (1067)		
TWC3Y6448-24	TWC3Y7248-24	
57 1/4" (1454) 58 3/4" (1492) 56 1/4" (1429) 55 1/2" (1410) 48" (1219)		
TWC3Y6454-24	TWC3Y7254-24	
59 1/4" (1505) 60 3/4" (1543) 58 1/4" (1480) 57 1/2" (1461) 50" (1270)		
TWC3Y6456-24	TWC3Y7256-24	
63 1/4" (1607) 64 3/4" (1645) 62 1/4" (1581) 61 1/2" (1562) 54" (1372)		
TWC3Y6460-24	TWC3Y7260-24	
67 1/4" (1708) 68 3/4" (1746) 66 1/4" (1683) 65 1/2" (1664) 58" (1473)		
TWC3Y6464-24	TWC3Y7264-24	
69 1/4" (1759) 70 3/4" (1797) 68 1/4" (1734) 67 1/2" (1715) 60" (1524)		
TWC3Y6466-24	TWC3Y7266-24	
75 1/4" (1911) 76 3/4" (1949) 74 1/4" (1886) 73 1/2" (1867) 66" (1676)		
TWC3Y6472-24	TWC3Y7272-24	

ELEVATION SYMBOL LEGEND:
M.O. = MASONRY OPENING
VALUES IN () ARE IN MILLIMETER CONVERSIONS
VALUES IN [] ARE NUMBER OF DAYLIGHT OPENINGS PER UNIT

Note Elevations shown DO NOT have exterior trim. Subtract 3/4" (19) from M.O. (Masonry Opening) for Unit Sizes. Masonry Openings above include Sill Nose, see Trim Options page for Sill Nose specifications. For other Trim Options refer to the Unit Sizing, Rough Opening & Masonry Openings page.

SCALE: 1/8" = 1'

30° BAY UNIT WITH 28" FLANKERS

M.O. BRICKMOULD	87 3/16" (2215)	97 3/16" (2469)	105 3/16" (2672)	113 3/16" (2875)	117 3/16" (2977)
M.O. ADAMS/FLAT CASING	89 9/16" (2275)	99 9/16" (2529)	107 9/16" (2732)	115 9/16" (2935)	119 9/16" (3037)
ROUGH OPENING	82 9/16" (2097)	92 9/16" (2351)	100 9/16" (2554)	108 9/16" (2757)	112 9/16" (2859)
FRAME SIZE	82 9/16" (2097)	92 9/16" (2351)	100 9/16" (2554)	108 9/16" (2757)	112 9/16" (2859)
DAYLIGHT OPENING	22" (559)[2] 24" (610)	22" (559)[2] 36" (914)	22" (559)[2] 42" (1067)	22" (559)[2] 48" (1219)	22" (559)[2] 54" (1372)

35 1/4" (895) 36 3/4" (933) 37 1/4" (940) 37 1/2" (951) 26" (660)					
TWC3Y3032-28					
39 1/4" (997) 39 3/4" (1005) 39 1/4" (997) 37 1/2" (953) 30" (762)					
TWC3Y3036-28					
43 1/4" (1099) 44 3/4" (1137) 44 1/4" (1125) 41 1/2" (1054) 34" (864)					
TWC3Y3040-28	TWC3Y4040-28	TWC3Y4840-28	TWC3Y5640-28	TWC3Y6040-28	
45 1/4" (1149) 46 3/4" (1187) 46 1/4" (1175) 43 1/2" (1105) 36" (914)					
TWC3Y3042-28	TWC3Y4042-28	TWC3Y4842-28	TWC3Y5642-28	TWC3Y6042-28	
51 1/4" (1302) 52 3/4" (1340) 52 1/4" (1328) 49 1/2" (1257) 42" (1067)					
TWC3Y3048-28	TWC3Y4048-28	TWC3Y4848-28	TWC3Y5648-28	TWC3Y6048-28	
57 1/4" (1454) 58 3/4" (1492) 58 1/4" (1480) 55 1/2" (1410) 48" (1219)					
TWC3Y3054-28	TWC3Y4054-28	TWC3Y4854-28	TWC3Y5654-28	TWC3Y6054-28	
59 1/4" (1505) 60 3/4" (1543) 60 1/4" (1531) 57 1/2" (1460) 50" (1270)					
TWC3Y3056-28	TWC3Y4056-28	TWC3Y4856-28	TWC3Y5656-28	TWC3Y6056-28	
63 1/4" (1607) 64 3/4" (1645) 64 1/4" (1633) 61 1/2" (1562) 54" (1372)					
TWC3Y3060-28	TWC3Y4060-28	TWC3Y4860-28	TWC3Y5660-28	TWC3Y6060-28	
67 1/4" (1708) 68 3/4" (1746) 68 1/4" (1734) 65 1/2" (1664) 58" (1473)					
TWC3Y3064-28	TWC3Y4064-28	TWC3Y4864-28	TWC3Y5664-28	TWC3Y6064-28	
69 1/4" (1759) 70 3/4" (1797) 70 1/4" (1785) 67 1/2" (1715) 60" (1524)					
TWC3Y3066-28	TWC3Y4066-28	TWC3Y4866-28	TWC3Y5666-28	TWC3Y6066-28	
75 1/4" (1911) 76 3/4" (1949) 76 1/4" (1937) 73 1/2" (1867) 66" (1676)					
TWC3Y3072-28	TWC3Y4072-28	TWC3Y4872-28	TWC3Y5672-28	TWC3Y6072-28	

ELEVATION SYMBOL LEGEND:
M.O. = MASONRY OPENING
 VALUES IN () ARE IN MILLIMETER CONVERSIONS
 VALUES IN [] ARE NUMBER OF DAYLIGHT OPENINGS PER UNIT
E BASIC UNIT CLEAR OPENING EXCEEDS 20" IN WIDTH, 24" IN HEIGHT & A MINIMUM OF 5.7 SQ. FT.

Note Elevations shown DO NOT have exterior trim. Subtract 3/4" (19) from M.O. (Masonry Opening) for Unit Sizes. Masonry Openings above include Sill Nose, see Trim Options page for Sill Nose specifications. For other Trim Options refer to the Unit Sizing, Rough Opening & Masonry Openings page.

SCALE: 1/8" = 1'

30° BAY UNIT WITH 28" FLANKERS

M.O. BRICKMOULD	121 3/16" (3078)	129 3/16" (3281)
M.O. ADAMS/FLAT CASING	123 9/16" (3136)	131 9/16" (3342)
ROUGH OPENING	116 9/16" (2961)	124 9/16" (3164)
FRAME SIZE	116 9/16" (2961)	124 9/16" (3164)
DAYLIGHT OPENING	22" (559)[2] 60" (1524)	22" (559)[2] 66" (1676)
43 1/4" (1099) 44 3/4" (1137) 42 1/4" (1073) 41 1/2" (1054) 34" (864)		
45 1/4" (1149) 46 3/4" (1187) 44 1/4" (1124) 43 1/2" (1105) 36" (914)		
51 1/4" (1302) 52 3/4" (1340) 50 1/4" (1276) 49 1/2" (1257) 42" (1067)		
57 1/4" (1454) 58 3/4" (1492) 56 1/4" (1429) 55 1/2" (1410) 48" (1219)		
59 1/4" (1505) 60 3/4" (1543) 58 1/4" (1480) 57 1/2" (1468) 50" (1270)		
63 1/4" (1607) 64 3/4" (1645) 62 1/4" (1581) 61 1/2" (1562) 54" (1372)		
67 1/4" (1708) 68 3/4" (1746) 66 1/4" (1683) 65 1/2" (1664) 58" (1473)		
69 1/4" (1759) 70 3/4" (1797) 68 1/4" (1734) 67 1/2" (1715) 60" (1524)		
75 1/4" (1911) 76 3/4" (1949) 74 1/4" (1886) 73 1/2" (1867) 66" (1676)		











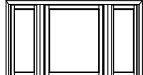



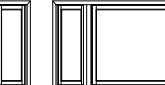
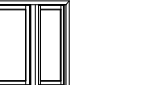
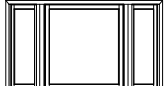

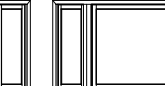
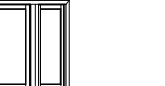
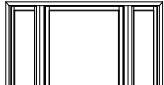

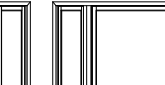

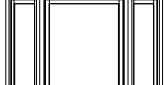

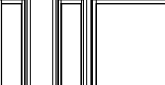
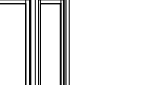
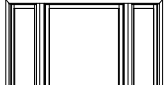

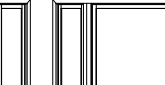
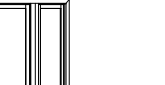
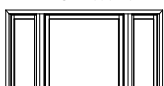

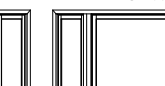





ELEVATION SYMBOL LEGEND:
M.O. = MASONRY OPENING
 VALUES IN () ARE IN MILLIMETER CONVERSIONS
 VALUES IN [] ARE NUMBER OF DAYLIGHT OPENINGS PER UNIT
 E BASIC UNIT CLEAR OPENING EXCEEDS 20" IN WIDTH, 24" IN HEIGHT & A MINIMUM OF 5.7 SQ. FT.

Note Elevations shown DO NOT have exterior trim. Subtract 3/4" (19) from M.O. (Masonry Opening) for Unit Sizes. Masonry Openings above include Sill Nose, see Trim Options page for Sill Nose specifications. For other Trim Options refer to the Unit Sizing, Rough Opening & Masonry Openings page.

SCALE: 1/8" = 1'

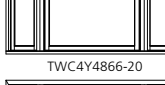
45° BAY UNIT WITH 20" FLANKERS

M.O. BRICKMOULD
M.O. ADAMS/FLAT CASING
ROUGH OPENING
FRAME SIZE
DAYLIGHT OPENING

68 9/16" (1741) 70 11/16" (1795) 62 13/16" (1595) 63 7/8" (1622) 14" (356) [2] 24" (610)	78 9/16" (1995) 80 11/16" (2049) 72 13/16" (1849) 73 7/8" (1876) 14" (356) [2] 36" (914)	86 9/16" (2199) 88 11/16" (2253) 80 13/16" (2053) 81 7/8" (2080) 14" (356) [2] 42" (1067)	94 9/16" (2402) 96 11/16" (2456) 88 13/16" (2256) 89 7/8" (2283) 14" (356) [2] 48" (1219)	98 9/16" (2503) 100 11/16" (2557) 92 13/16" (2357) 93 7/8" (2384) 14" (356) [2] 54" (1372)	
35 1/4" (895) 36 3/4" (933) 34 1/4" (870) 33 1/2" (851) 26" (660)					
TWC4Y3032-20					
39 1/4" (997) 40 3/4" (1035) 38 1/4" (972) 37 1/2" (953) 30" (762)					
TWC4Y3036-20					
43 1/4" (1099) 44 3/4" (1137) 42 1/4" (1073) 41 1/2" (1054) 34" (864)					
TWC4Y3040-20	TWC4Y4040-20	TWC4Y4840-20	TWC4Y5640-20	TWC4Y6040-20	
45 1/4" (1149) 46 3/4" (1187) 44 1/4" (1124) 43 1/2" (1105) 36" (914)					
TWC4Y3042-20	TWC4Y4042-20	TWC4Y4842-20	TWC4Y5642-20	TWC4Y6042-20	
51 1/4" (1302) 52 3/4" (1340) 50 1/4" (1276) 49 1/2" (1257) 42" (1067)					
TWC4Y3048-20	TWC4Y4048-20	TWC4Y4848-20	TWC4Y5648-20	TWC4Y6048-20	
57 1/4" (1454) 58 3/4" (1492) 56 1/4" (1429) 55 1/2" (1410) 48" (1219)					
TWC4Y3054-20	TWC4Y4054-20	TWC4Y4854-20	TWC4Y5654-20	TWC4Y6054-20	
59 1/4" (1505) 60 3/4" (1543) 58 1/4" (1480) 57 1/2" (1461) 50" (1270)					
TWC4Y3056-20	TWC4Y4056-20	TWC4Y4856-20	TWC4Y5656-20	TWC4Y6056-20	
63 1/4" (1607) 64 3/4" (1645) 62 1/4" (1581) 61 1/2" (1562) 54" (1372)					
TWC4Y3060-20	TWC4Y4060-20	TWC4Y4860-20	TWC4Y5660-20	TWC4Y6060-20	
67 1/4" (1708) 68 3/4" (1746) 66 1/4" (1683) 65 1/2" (1664) 58" (1473)					
TWC4Y3064-20	TWC4Y4064-20	TWC4Y4864-20	TWC4Y5664-20	TWC4Y6064-20	
69 1/4" (1759) 70 3/4" (1797) 68 1/4" (1734) 67 1/2" (1715) 60" (1524)					
TWC4Y3066-20	TWC4Y4066-20	TWC4Y4866-20	TWC4Y5666-20	TWC4Y6066-20	
75 1/4" (1911) 76 3/4" (1949) 74 1/4" (1886) 73 1/2" (1867) 66" (1676)					
TWC4Y3072-20	TWC4Y4072-20	TWC4Y4872-20	TWC4Y5672-20	TWC4Y6072-20	

ELEVATION SYMBOL LEGEND:

M.O. = MASONRY OPENING
VALUES IN () ARE IN MILLIMETER CONVERSIONS
VALUES IN [] ARE NUMBER OF DAYLIGHT OPENINGS PER UNIT

Note Elevations shown DO NOT have exterior trim. Subtract 3/4" (19) from M.O. (Masonry Opening) for Unit Sizes. Masonry Openings above include Sill Nose, see Trim Options page for Sill Nose specifications. For other Trim Options refer to the Unit Sizing, Rough Opening & Masonry Openings page.

SCALE: 1/8" = 1'

45° BAY UNIT WITH 20" FLANKERS











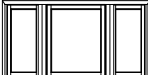
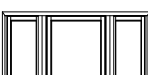
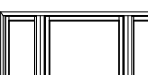
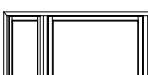
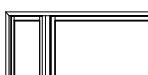
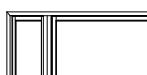







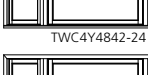







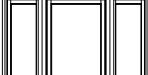











M.O. BRICKMOULD M.O. ADAMS/FLAT CASING ROUGH OPENING FRAME SIZE DAYLIGHT OPENING	102 9/16" (2605) 104 11/16" (2659) 96 13/16" (2459) 97 7/8" (2486) 14" (356)[2] 60" (1524)	110 9/16" (2808) 112 11/16" (2862) 104 13/16" (2662) 105 7/8" (2689) 14" (356)[2] 66" (1676)
43 1/4" (1099) 44 3/4" (1137) 42 1/4" (1073) 41 1/2" (1054) 34" (864)		
TWC4Y6440-20	TWC4Y7240-20	
45 1/4" (1149) 46 3/4" (1187) 44 1/4" (1124) 43 1/2" (1105) 36" (914)		
TWC4Y6442-20	TWC4Y7242-20	
51 1/4" (1302) 52 3/4" (1340) 50 1/4" (1276) 49 1/2" (1257) 42" (1067)		
TWC4Y6448-20	TWC4Y7248-20	
57 1/4" (1454) 58 3/4" (1492) 56 1/4" (1429) 55 1/2" (1410) 48" (1219)		
TWC4Y6454-20	TWC4Y7254-20	
59 1/4" (1505) 60 3/4" (1543) 58 1/4" (1480) 57 1/2" (1461) 50" (1270)		
TWC4Y6456-20	TWC4Y7256-20	
63 1/4" (1607) 64 3/4" (1645) 62 1/4" (1581) 61 1/2" (1562) 54" (1372)		
TWC4Y6460-20	TWC4Y7260-20	
67 1/4" (1708) 68 3/4" (1746) 66 1/4" (1683) 65 1/2" (1664) 58" (1473)		
TWC4Y6464-20	TWC4Y7264-20	
69 1/4" (1759) 70 3/4" (1797) 68 1/4" (1734) 67 1/2" (1715) 60" (1524)		
TWC4Y6466-20	TWC4Y7266-20	
75 1/4" (1911) 76 3/4" (1949) 74 1/4" (1886) 73 1/2" (1867) 66" (1676)		
TWC4Y6472-20	TWC4Y7272-20	

ELEVATION SYMBOL LEGEND:
M.O. = MASONRY OPENING
VALUES IN () ARE IN MILLIMETER CONVERSIONS
VALUES IN [] ARE NUMBER OF DAYLIGHT OPENINGS PER UNIT

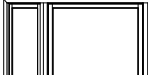
Note Elevations shown DO NOT have exterior trim. Subtract 3/4" (19) from M.O. (Masonry Opening) for Unit Sizes. Masonry Openings above include Sill Nose, see Trim Options page for Sill Nose specifications. For other Trim Options refer to the Unit Sizing, Rough Opening & Masonry Openings page.

SCALE: 1/8" = 1'

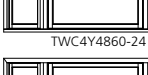
45° BAY UNIT WITH 24" FLANKERS











M.O. BRICKMOULD M.O. ADAMS/FLAT CASING ROUGH OPENING FRAME SIZE DAYLIGHT OPENING	74 1/4"(1886) 76 3/8"(1940) 68 7/16"(1738) 69 1/2"(1765) 18"(457)[2] 24"(610)	84 1/4"(2140) 86 3/8"(2194) 78 7/16"(1992) 79 1/2"(2019) 18"(457)[2] 36"(914)	92 1/4"(2343) 94 3/8"(2397) 86 7/16"(2196) 87 1/2"(2223) 18"(457)[2] 42"(1067)	100 1/4"(2546) 102 3/8"(2600) 94 7/16"(2399) 95 1/2"(2426) 18"(457)[2] 48"(1219)	104 1/4"(2648) 106 3/8"(2702) 98 7/16"(2500) 99 1/2"(2527) 18"(457)[2] 54"(1372)
35 1/4"(895) 36 3/4"(933) 34 1/4"(870) 33 1/2"(851) 26"(660)					
TWC4Y3032-24					
39 1/4"(997) 40 3/4"(1035) 38 1/4"(972) 37 1/2"(953) 30"(762)					
TWC4Y3036-24					
43 1/4"(1099) 44 3/4"(1137) 42 1/4"(1073) 41 1/2"(1054) 34"(864)					
TWC4Y3040-24	TWC4Y4040-24	TWC4Y4840-24	TWC4Y5640-24	TWC4Y6040-24	
45 1/4"(1149) 46 3/4"(1187) 44 1/4"(1124) 43 1/2"(1105) 36"(914)					
TWC4Y3042-24	TWC4Y4042-24	TWC4Y4842-24	TWC4Y5642-24	TWC4Y6042-24	
51 1/4"(1302) 52 3/4"(1340) 50 1/4"(1276) 49 1/2"(1257) 42"(1067)					
TWC4Y3048-24	TWC4Y4048-24	TWC4Y4848-24	TWC4Y5648-24	TWC4Y6048-24	
57 1/4"(1454) 58 3/4"(1492) 56 1/4"(1429) 55 1/2"(1410) 48"(1219)					
TWC4Y3054-24	TWC4Y4054-24	TWC4Y4854-24	TWC4Y5654-24	TWC4Y6054-24	
59 1/4"(1505) 60 3/4"(1543) 58 1/4"(1480) 57 1/2"(1468) 50"(1270)					
TWC4Y3056-24	TWC4Y4056-24	TWC4Y4856-24	TWC4Y5656-24	TWC4Y6056-24	
63 1/4"(1607) 64 3/4"(1645) 62 1/4"(1581) 61 1/2"(1562) 54"(1372)					
TWC4Y3060-24	TWC4Y4060-24	TWC4Y4860-24	TWC4Y5660-24	TWC4Y6060-24	
67 1/4"(1708) 68 3/4"(1746) 66 1/4"(1683) 65 1/2"(1664) 58"(1473)					
TWC4Y3064-24	TWC4Y4064-24	TWC4Y4864-24	TWC4Y5664-24	TWC4Y6064-24	
69 1/4"(1759) 70 3/4"(1797) 68 1/4"(1734) 67 1/2"(1715) 60"(1524)					
TWC4Y3066-24	TWC4Y4066-24	TWC4Y4866-24	TWC4Y5666-24	TWC4Y6066-24	
75 1/4"(1911) 76 3/4"(1949) 74 1/4"(1886) 73 1/2"(1867) 66"(1676)					
TWC4Y3072-24	TWC4Y4072-24	TWC4Y4872-24	TWC4Y5672-24	TWC4Y6072-24	

ELEVATION SYMBOL LEGEND:
M.O. = MASONRY OPENING
VALUES IN () ARE IN MILLIMETER CONVERSIONS
VALUES IN [] ARE NUMBER OF DAYLIGHT OPENINGS PER UNIT

Note Elevations shown DO NOT have exterior trim. Subtract 3/4" (19) from M.O. (Masonry Opening) for Unit Sizes. Masonry Openings above include Sill Nose, see Trim Options page for Sill Nose specifications. For other Trim Options refer to the Unit Sizing, Rough Opening & Masonry Openings page.

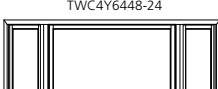
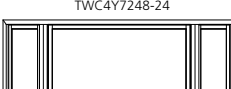
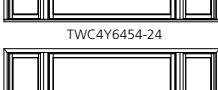
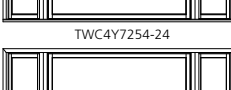
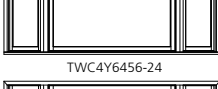
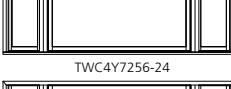
SCALE: 1/8" = 1'

45° BAY UNIT WITH 24" FLANKERS

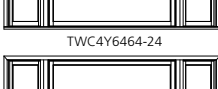
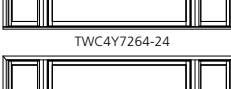
M.O. BRICKMOULD M.O. ADAMS/FLAT CASING ROUGH OPENING FRAME SIZE DAYLIGHT OPENING	108 1/4"(2750) 110 3/8"(2804) 102 7/16"(2602) 103 1/2"(2629) 18"(457)[2] 60"(1524)	116 1/4"(2953) 118 3/8"(3007) 110 7/16"(2805) 111 1/2"(2832) 18"(457)[2] 66"(1676)
43 1/4"(1099) 44 3/4"(1137) 42 1/4"(1073) 41 1/2"(1054) 34"(864)		
	TWC4Y6440-24	TWC4Y7240-24
45 1/4"(1149) 46 3/4"(1187) 44 1/4"(1124) 43 1/2"(1105) 36"(914)		
	TWC4Y6442-24	TWC4Y7242-24
51 1/4"(1302) 52 3/4"(1340) 50 1/4"(1276) 49 1/2"(1257) 42"(1067)		
	TWC4Y6448-24	TWC4Y7248-24
57 1/4"(1454) 58 3/4"(1492) 56 1/4"(1429) 55 1/2"(1410) 48"(1219)		
	TWC4Y6454-24	TWC4Y7254-24
59 1/4"(1505) 60 3/4"(1543) 58 1/4"(1480) 57 1/2"(1461) 50"(1270)		
	TWC4Y6456-24	TWC4Y7256-24
63 1/4"(1607) 64 3/4"(1645) 62 1/4"(1581) 61 1/2"(1562) 54"(1372)		
	TWC4Y6460-24	TWC4Y7260-24
67 1/4"(1708) 68 3/4"(1746) 66 1/4"(1683) 65 1/2"(1664) 58"(1473)		
	TWC4Y6464-24	TWC4Y7264-24
69 1/4"(1759) 70 3/4"(1797) 68 1/4"(1734) 67 1/2"(1715) 60"(1524)		
	TWC4Y6466-24	TWC4Y7266-24
75 1/4"(1911) 76 3/4"(1949) 74 1/4"(1886) 73 1/2"(1867) 66"(1676)		
	TWC4Y6472-24	TWC4Y7272-24











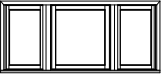
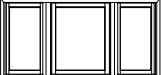
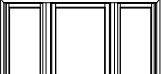

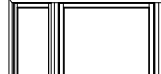

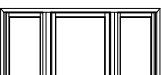
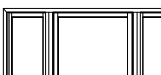
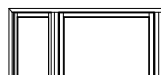
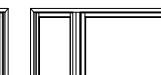

















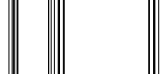
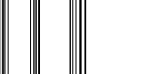



ELEVATION SYMBOL LEGEND:

M.O. = MASONRY OPENING
VALUES IN () ARE IN MILLIMETER CONVERSIONS
VALUES IN [] ARE NUMBER OF DAYLIGHT OPENINGS PER UNIT

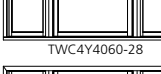
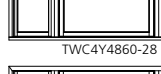
Note Elevations shown DO NOT have exterior trim. Subtract 3/4" (19) from M.O. (Masonry Opening) for Unit Sizes. Masonry Openings above include Sill Nose, see Trim Options page for Sill Nose specifications. For other Trim Options refer to the Unit Sizing, Rough Opening & Masonry Openings page.

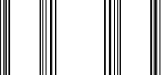
SCALE: 1/8" = 1'

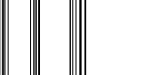
45° BAY UNIT WITH 28" FLANKERS

M.O. BRICKMOULD M.O. ADAMS/FLAT CASING ROUGH OPENING FRAME SIZE DAYLIGHT OPENING	79 7/8" (2029) 82" (2083) 74 1/8" (1883) 75 3/16" (1910) 22" (559)[2] 24" (610)	89 7/8" (2283) 92" (2337) 84 1/8" (2137) 85 3/16" (2164) 22" (559)[2] 36" (914)	97 7/8" (2486) 100" (2540) 92 1/8" (2340) 93 3/16" (2367) 22" (559)[2] 42" (1067)	105 7/8" (2689) 108" (2743) 100 1/8" (2543) 101 3/16" (2570) 22" (559)[2] 48" (1219)	109 7/8" (2791) 112" (2849) 104 1/8" (2645) 105 3/16" (2672) 22" (559)[2] 54" (1372)
35 1/4" (895) 36 3/4" (933) 34 1/4" (870) 33 1/2" (851) 26" (660)					
	TWC4Y3032-28				
39 1/4" (997) 40 3/4" (1035) 38 1/4" (972) 37 1/2" (953) 30" (762)					
	TWC4Y3036-28				
43 1/4" (1099) 44 3/4" (1137) 42 1/4" (1073) 41 1/2" (1054) 34" (864)					
	TWC4Y3040-28	TWC4Y4040-28	TWC4Y4840-28	TWC4Y5640-28	TWC4Y6040-28
45 1/4" (1149) 46 3/4" (1187) 44 1/4" (1124) 43 1/2" (1105) 36" (914)					
	TWC4Y3042-28	TWC4Y4042-28	TWC4Y4842-28	TWC4Y5642-28	TWC4Y6042-28
51 1/4" (1302) 52 3/4" (1340) 50 1/4" (1276) 49 1/2" (1257) 42" (1067)					
	TWC4Y3048-28	TWC4Y4048-28	TWC4Y4848-28	TWC4Y5648-28	TWC4Y6048-28
57 1/4" (1454) 58 3/4" (1492) 56 1/4" (1429) 55 1/2" (1410) 48" (1219)					
	TWC4Y3054-28	TWC4Y4054-28	TWC4Y4854-28	TWC4Y5654-28	TWC4Y6054-28
59 1/4" (1505) 60 3/4" (1543) 58 1/4" (1480) 57 1/2" (1468) 50" (1270)					
	TWC4Y3056-28	TWC4Y4056-28	TWC4Y4856-28	TWC4Y5656-28	TWC4Y6056-28
63 1/4" (1607) 64 3/4" (1645) 62 1/4" (1581) 61 1/2" (1562) 54" (1372)					
	TWC4Y3060-28	TWC4Y4060-28	TWC4Y4860-28	TWC4Y5660-28	TWC4Y6060-28
67 1/4" (1708) 68 3/4" (1746) 66 1/4" (1683) 65 1/2" (1664) 58" (1473)					
	TWC4Y3064-28	TWC4Y4064-28	TWC4Y4864-28	TWC4Y5664-28	TWC4Y6064-28
69 1/4" (1759) 70 3/4" (1797) 68 1/4" (1734) 67 1/2" (1715) 60" (1524)					
	TWC4Y3066-28	TWC4Y4066-28	TWC4Y4866-28	TWC4Y5666-28	TWC4Y6066-28
75 1/4" (1911) 76 3/4" (1949) 74 1/4" (1886) 73 1/2" (1867) 66" (1676)					
	TWC4Y3072-28	TWC4Y4072-28	TWC4Y4872-28	TWC4Y5672-28	TWC4Y6072-28

ELEVATION SYMBOL LEGEND:
M.O. = MASONRY OPENING
VALUES IN () ARE IN MILLIMETER CONVERSIONS
VALUES IN [] ARE NUMBER OF DAYLIGHT OPENINGS PER UNIT
E BASIC UNIT CLEAR OPENING EXCEEDS 20" IN WIDTH, 24" IN HEIGHT & A MINIMUM OF 5.7 SQ. FT.

Note Elevations shown DO NOT have exterior trim. Subtract 3/4" (19) from M.O. (Masonry Opening) for Unit Sizes. Masonry Openings above include Sill Nose, see Trim Options page for Sill Nose specifications. For other Trim Options refer to the Unit Sizing, Rough Opening & Masonry Openings page.

SCALE: 1/8" = 1'

45° BAY UNIT WITH 28" FLANKERS

M.O. BRICKMOULD M.O. ADAMS/FLAT CASING ROUGH OPENING FRAME SIZE DAYLIGHT OPENING	113 7/8"(2892) 116"(2946) 108 1/8"(2746) 109 3/16"(2773) 22"(559)[2] 60"(1524)	121 7/8"(3096) 124"(3150) 116 1/8"(2950) 117 3/16"(2977) 22"(559)[2] 66"(1676)
43 1/4"(1099) 44 3/4"(1137) 42 1/4"(1073) 41 1/2"(1054) 34"(864)		
45 1/4"(1149) 46 3/4"(1187) 44 1/4"(1124) 43 1/2"(1105) 36"(914)		
51 1/4"(1302) 52 3/4"(1340) 50 1/4"(1276) 49 1/2"(1257) 42"(1067)		
57 1/4"(1454) 58 3/4"(1492) 56 1/4"(1429) 55 1/2"(1410) 48"(1219)		
59 1/4"(1505) 60 3/4"(1543) 58 1/4"(1480) 57 1/2"(1461) 50"(1270)		
63 1/4"(1607) 64 3/4"(1645) 62 1/4"(1581) 61 1/2"(1562) 54"(1372)		
67 1/4"(1708) 68 3/4"(1746) 66 1/4"(1683) 65 1/2"(1664) 58"(1473)		
69 1/4"(1759) 70 3/4"(1797) 68 1/4"(1734) 67 1/2"(1715) 60"(1524)		
75 1/4"(1911) 76 3/4"(1949) 74 1/4"(1886) 73 1/2"(1867) 66"(1676)		

ELEVATION SYMBOL LEGEND:
M.O. = MASONRY OPENING
 VALUES IN () ARE IN MILLIMETER CONVERSIONS
 VALUES IN [] ARE NUMBER OF DAYLIGHT OPENINGS PER UNIT
E BASIC UNIT CLEAR OPENING EXCEEDS 20" IN WIDTH, 24" IN HEIGHT & A MINIMUM OF 5.7 SQ. FT.

Note Elevations shown DO NOT have exterior trim. Subtract 3/4" (19) from M.O. (Masonry Opening) for Unit Sizes. Masonry Openings above include Sill Nose, see Trim Options page for Sill Nose specifications. For other Trim Options refer to the Unit Sizing, Rough Opening & Masonry Openings page.

SCALE: 1/8" = 1'

4-WIDE BOW UNITS

M.O. BRICKMOULD M.O. ADAMS/FLAT CASING ROUGH OPENING FRAME SIZE DAYLIGHT OPENING	73 1/4"(1861) 76 3/16"(1935) 69 1/2"(1765) 68 15/16"(1751) 11"(279)[4]	85 1/16"(2161) 87 15/16"(2234) 81 1/4"(2064) 80 11/16"(2049) 14"(356)[4]	100 3/4"(2559) 103 5/8"(2632) 96 15/16"(2462) 96 3/8"(2448) 18"(457)[4]	116 7/16"(2958) 119 5/8"(3031) 112 11/16"(2862) 112 1/8"(2848) 22"(559)[4]	124 1/4"(3156) 127 3/16"(3231) 120 1/2"(3061) 119 15/16"(3046) 24"(610)[4]
39 1/4"(997) 40 3/4"(1035) 38 1/4"(972) 37 1/2"(953) 30"(762)					
43 1/4"(1099) 44 3/4"(1137) 42 1/4"(1073) 41 1/2"(1054) 34"(864)					
45 1/4"(1149) 46 3/4"(1187) 44 1/4"(1124) 43 1/2"(1105) 36"(914)					
51 1/4"(1302) 52 3/4"(1340) 50 1/4"(1276) 49 1/2"(1257) 42"(1067)					
57 1/4"(1454) 58 3/4"(1492) 56 1/4"(1429) 55 1/2"(1410) 48"(1219)					
59 1/4"(1505) 60 3/4"(1543) 58 1/4"(1480) 57 1/2"(1468) 50"(1270)					
63 1/4"(1607) 64 3/4"(1645) 62 1/4"(1581) 61 1/2"(1562) 54"(1372)					
67 1/4"(1708) 68 3/4"(1746) 66 1/4"(1683) 65 1/2"(1664) 58"(1473)					
69 1/4"(1759) 70 3/4"(1797) 68 1/4"(1734) 67 1/2"(1715) 60"(1524)					
75 1/4"(1911) 76 3/4"(1949) 74 1/4"(1886) 73 1/2"(1867) 66"(1676)					

ELEVATION SYMBOL LEGEND:
M.O. = MASONRY OPENING
 VALUES IN () ARE IN MILLIMETER CONVERSIONS
 VALUES IN [] ARE NUMBER OF DAYLIGHT OPENINGS PER UNIT
 E BASIC UNIT CLEAR OPENING EXCEEDS 20" IN WIDTH, 24" IN HEIGHT & A MINIMUM OF 5.7 SQ. FT.

Note Elevations shown DO NOT have exterior trim. Subtract 3/4" (19) from M.O. (Masonry Opening) for Unit Sizes. Masonry Openings above include Sill Nose, see Trim Options page for Sill Nose specifications. For other Trim Options refer to the Unit Sizing, Rough Opening & Masonry Openings page.

SCALE: 1/8" = 1'

5-WIDE BOW UNITS

M.O. BRICKMOULD M.O. ADAMS/FLAT CASING ROUGH OPENING FRAME SIZE DAYLIGHT OPENING	89 13/16" (2281) 92 5/8" (2353) 85 13/16" (2180) 85 3/8" (2169) 11" (279)[5]	104 3/8" (2651) 107 3/16" (2723) 100 3/8" (2550) 99 15/16" (2538) 14" (356)[5]	123 3/4" (3143) 126 5/8" (3216) 119 3/4" (3042) 119 5/16" (3031) 18" (457)[5]	143 3/16" (3637) 146" (3708) 139 1/8" (3534) 138 11/16" (3523) 22" (559)[5]
39 1/4" (997) 40 3/4" (1035) 38 1/4" (972) 37 1/2" (953) 30" (762)				
TWC5W1736	TWC5W2036	TWC5W2436	TWC5W2836	
43 1/4" (1099) 44 3/4" (1137) 42 1/4" (1073) 41 1/2" (1054) 34" (864)				
TWC5W1740	TWC5W2040	TWC5W2440	TWC5W2840	
45 1/4" (1149) 46 3/4" (1187) 44 1/4" (1124) 43 1/2" (1105) 36" (914)				
TWC5W1742	TWC5W2042	TWC5W2442	TWC5W2842	
51 1/4" (1302) 52 3/4" (1340) 50 1/4" (1276) 49 1/2" (1257) 42" (1067)				
TWC5W1748	TWC5W2048	TWC5W2448	TWC5W2848	E
57 1/4" (1454) 58 3/4" (1492) 56 1/4" (1429) 55 1/2" (1410) 48" (1219)				
TWC5W1754	TWC5W2054	TWC5W2454	TWC5W2854	E
59 1/4" (1505) 60 3/4" (1543) 58 1/4" (1480) 57 1/2" (1461) 50" (1270)				
TWC5W1756	TWC5W2056	TWC5W2456	TWC5W2856	E
63 1/4" (1607) 64 3/4" (1645) 62 1/4" (1581) 61 1/2" (1562) 54" (1372)				
TWC5W1760	TWC5W2060	TWC5W2460	TWC5W2860	E
67 1/4" (1708) 68 3/4" (1746) 66 1/4" (1683) 65 1/2" (1664) 58" (1473)				
TWC5W1764	TWC5W2064	TWC5W2464	TWC5W2860	E
69 1/4" (1759) 70 3/4" (1797) 68 1/4" (1734) 67 1/2" (1715) 60" (1524)				
TWC5W1766	TWC5W2066	TWC5W2466	TWC5W2860	E
75 1/4" (1911) 76 3/4" (1949) 74 1/4" (1886) 73 1/2" (1867) 66" (1676)				
TWC5W1772	TWC5W2072	TWC5W2472	TWC5W2872	E

ELEVATION SYMBOL LEGEND:
M.O. = MASONRY OPENING
 VALUES IN () ARE IN MILLIMETER CONVERSIONS
 VALUES IN [] ARE NUMBER OF DAYLIGHT OPENINGS PER UNIT
 E BASIC UNIT CLEAR OPENING EXCEEDS 20" IN WIDTH, 24" IN HEIGHT & A MINIMUM OF 5.7 SQ. FT.





Note Elevations shown DO NOT have exterior trim. Subtract 3/4" (19) from M.O. (Masonry Opening) for Unit Sizes. Masonry Openings above include Sill Nose, see Trim Options page for Sill Nose specifications. For other Trim Options refer to the Unit Sizing, Rough Opening & Masonry Openings page.

SCALE: 1/8" = 1'

5-WIDE BOW UNITS

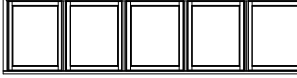
M.O. BRICKMOULD
M.O. ADAMS/FLAT CASING
ROUGH OPENING
FRAME SIZE
DAYLIGHT OPENING

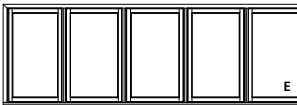
152 7/8"(3883)
155 11/16"(3954)
148 13/16"(3780)
148 3/8"(3769)
24"(610)[5]

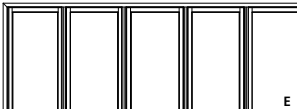
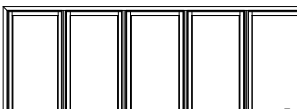
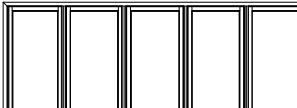
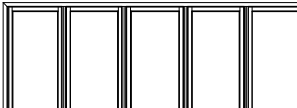
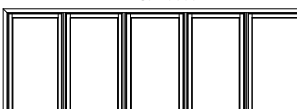
39 1/4"(997) 40 3/4"(1035) 38 1/4"(972) 37 1/2"(953) 30"(762)	
	TWC5W3036
43 1/4"(1099) 44 3/4"(1137) 42 1/4"(1073) 41 1/2"(1054) 34"(864)	
	TWC5W3040
45 1/4"(1149) 46 3/4"(1187) 44 1/4"(1124) 43 1/2"(1105) 36"(914)	
	TWC5W3042
51 1/4"(1302) 52 3/4"(1340) 50 1/4"(1276) 49 1/2"(1257) 42"(1067)	
	TWC5W3048
57 1/4"(1454) 58 3/4"(1492) 56 1/4"(1429) 55 1/2"(1410) 48"(1219)	
	TWC5W3054
59 1/4"(1505) 60 3/4"(1543) 58 1/4"(1480) 57 1/2"(1461) 50"(1270)	
	TWC5W3056
63 1/4"(1607) 64 3/4"(1645) 62 1/4"(1581) 61 1/2"(1562) 54"(1372)	
	TWC5W3060
67 1/4"(1708) 68 3/4"(1746) 66 1/4"(1683) 65 1/2"(1664) 58"(1473)	
	TWC5W3060
69 1/4"(1759) 70 3/4"(1797) 68 1/4"(1734) 67 1/2"(1715) 60"(1524)	
	TWC5W3060
75 1/4"(1911) 76 3/4"(1949) 74 1/4"(1886) 73 1/2"(1867) 66"(1676)	
	TWC5W3072

ELEVATION SYMBOL LEGEND:

M.O. = MASONRY OPENING
VALUES IN () ARE IN MILLIMETER CONVERSIONS
VALUES IN [] ARE NUMBER OF DAYLIGHT OPENINGS PER UNIT
E BASIC UNIT CLEAR OPENING EXCEEDS 20" IN WIDTH, 24" IN HEIGHT & A MINIMUM OF 5.7 SQ. FT.

Note Elevations shown DO NOT have exterior trim. Subtract 3/4" (19) from M.O. (Masonry Opening) for Unit Sizes. Masonry Openings above include Sill Nose, see Trim Options page for Sill Nose specifications. For other Trim Options refer to the Unit Sizing, Rough Opening & Masonry Openings page.

SCALE: 1/8" = 1'

6-WIDE BOW UNITS

M.O. BRICKMOULD
M.O. ADAMS/FLAT CASING
ROUGH OPENING
FRAME SIZE
DAYLIGHT OPENING

105 3/4" (2686)
108 7/16" (2754)
101 3/8" (2575)
100 1/8" (2543)
11" (279)[6]

122 15/16" (3123)
125 11/16" (3192)
118 5/8" (3013)
118 3/8" (3007)
14" (356)[6]

145 7/8" (3705)
148 5/8" (3775)
141 9/16" (3596)
141 5/16" (3589)
18" (457)[6]

168 13/16" (4288)
171 9/16" (4358)
164 1/2" (4178)
164 1/4" (4172)
22" (559)[6]

39 1/4" (997)
40 3/4" (1035)
38 1/4" (972)
37 1/2" (953)
30" (762)

43 1/4" (1099)
44 3/4" (1137)
42 1/4" (1073)
41 1/2" (1054)
34" (864)

45 1/4" (1149)
46 3/4" (1187)
44 1/4" (1124)
43 1/2" (1105)
36" (914)

51 1/4" (1302)
52 3/4" (1340)
50 1/4" (1276)
49 1/2" (1257)
42" (1067)

57 1/4" (1454)
58 3/4" (1492)
56 1/4" (1429)
55 1/2" (1410)
48" (1219)

59 1/4" (1505)
60 3/4" (1543)
58 1/4" (1480)
57 1/2" (1461)
50" (1270)

63 1/4" (1607)
64 3/4" (1645)
62 1/4" (1581)
61 1/2" (1562)
54" (1372)

67 1/4" (1708)
68 3/4" (1746)
66 1/4" (1683)
65 1/2" (1664)
58" (1473)

69 1/4" (1759)
70 3/4" (1797)
68 1/4" (1734)
67 1/2" (1715)
60" (1524)

75 1/4" (1911)
76 3/4" (1949)
74 1/4" (1886)
73 1/2" (1867)
66" (1676)

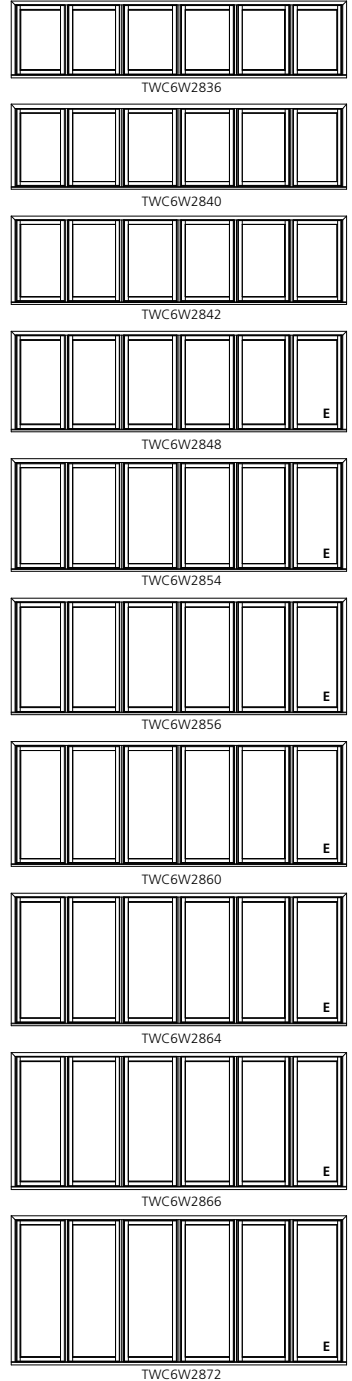
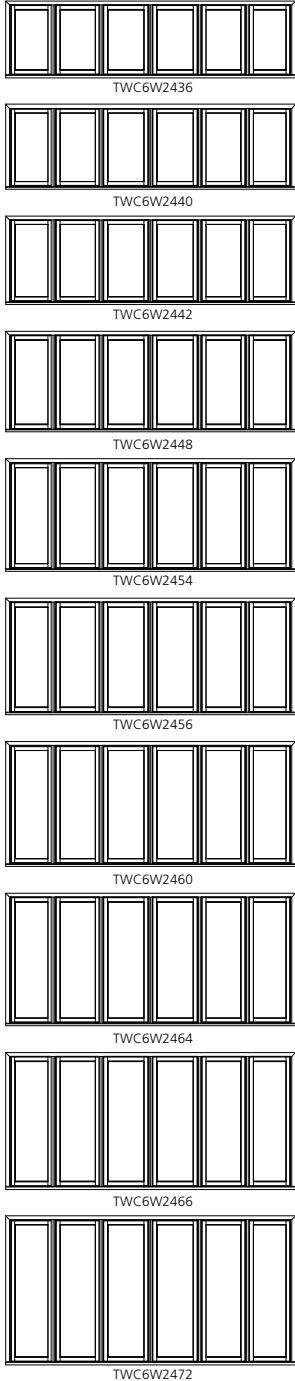
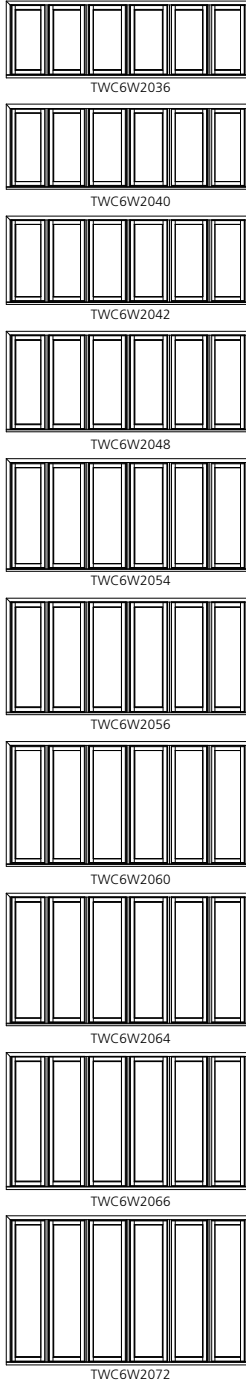
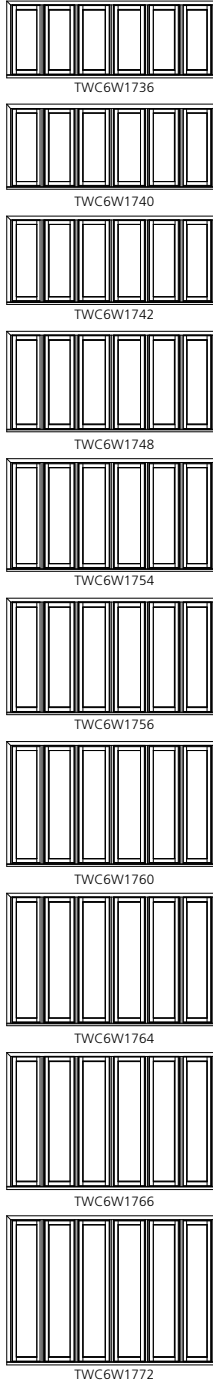

ELEVATION SYMBOL LEGEND:
M.O. = MASONRY OPENING
VALUES IN () ARE IN MILLIMETER CONVERSIONS
VALUES IN [] ARE NUMBER OF DAYLIGHT OPENINGS PER UNIT
E BASIC UNIT CLEAR OPENING EXCEEDS 20" IN WIDTH, 24" IN HEIGHT & A MINIMUM OF 5.7 SQ. FT.



Note Elevations shown DO NOT have exterior trim. Subtract 3/4" (19) from M.O. (Masonry Opening) for Unit Sizes. Masonry Openings above include Sill Nose, see Trim Options page for Sill Nose specifications. For other Trim Options refer to the Unit Sizing, Rough Opening & Masonry Openings page.

SCALE: 1/8" = 1'

6-WIDE BOW UNITS

M.O. BRICKMOULD
M.O. ADAMS/FLAT CASING
ROUGH OPENING
FRAME SIZE
DAYLIGHT OPENING

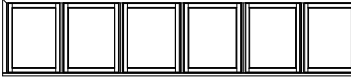
180 5/16"(4580)
183 1/16"(4650)
176"(4470)
175 3/4"(4464)
30"(610)[6]

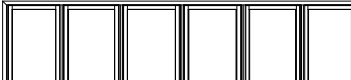
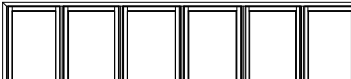
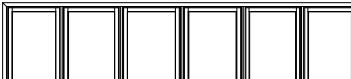
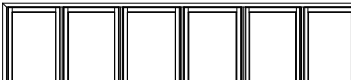
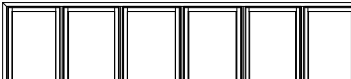
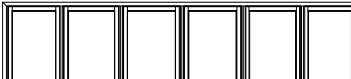
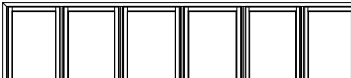
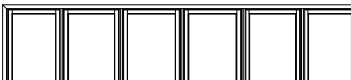
39 1/4"(987) 40 3/4"(1035) 39 1/4"(987) 37 1/2"(953) 30"(762)	
	TWC6W3036
43 1/4"(1099) 44 3/4"(1137) 43 1/4"(1073) 41 1/2"(1054) 34"(864)	
	TWC6W3040
45 1/4"(1149) 46 3/4"(1187) 45 1/4"(1121) 43 1/2"(1105) 36"(914)	
	TWC6W3042
51 1/4"(1302) 52 3/4"(1340) 51 1/4"(1275) 49 1/2"(1257) 42"(1067)	
	TWC6W3048
57 1/4"(1454) 58 3/4"(1492) 57 1/4"(1427) 55 1/2"(1410) 48"(1219)	
	TWC6W3054
59 1/4"(1505) 60 3/4"(1543) 59 1/4"(1478) 57 1/2"(1460) 50"(1270)	
	TWC6W3056
63 1/4"(1607) 64 3/4"(1645) 63 1/4"(1580) 61 1/2"(1562) 54"(1372)	
	TWC6W3060
67 1/4"(1708) 68 3/4"(1746) 67 1/4"(1681) 65 1/2"(1664) 58"(1473)	
	TWC6W3064
69 1/4"(1759) 70 3/4"(1797) 69 1/4"(1732) 67 1/2"(1715) 60"(1524)	
	TWC6W3066
75 1/4"(1911) 76 3/4"(1949) 75 1/4"(1884) 73 1/2"(1867) 66"(1676)	
	TWC6W3072

ELEVATION SYMBOL LEGEND:

M.O. = MASONRY OPENING
VALUES IN () ARE IN MILLIMETER CONVERSIONS
VALUES IN [] ARE NUMBER OF DAYLIGHT OPENINGS PER UNIT
E BASIC UNIT CLEAR OPENING EXCEEDS 20" IN WIDTH, 24" IN HEIGHT & A MINIMUM OF 5.7 SQ. FT.

Note Elevations shown DO NOT have exterior trim. Subtract 3/4" (19) from M.O. (Masonry Opening) for Unit Sizes. Masonry Openings above include Sill Nose, see Trim Options page for Sill Nose specifications. For other Trim Options refer to the Unit Sizing, Rough Opening & Masonry Openings page.

SCALE: 1/8" = 1'

GLAZING OPTIONS

INTERIOR GLAZED

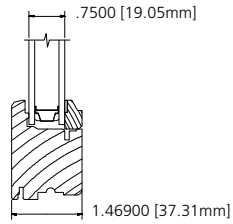

INSULATED GLASS

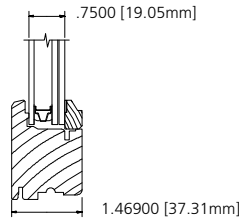

**LAMINATED INSULATED
CLEAR OR LOW-E**

3.0mm//6.7mm LAMINATE

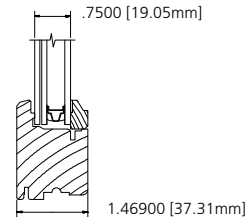

**LAMINATED INSULATED
TINTED**

6.7mm LAMINATE//3.0mm

TRIM OPTIONS

WOOD EXTERIOR TRIM

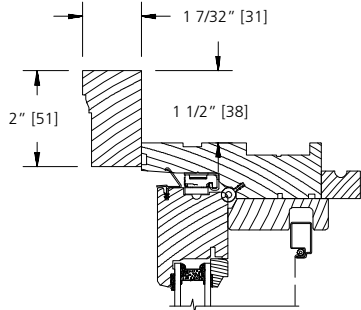

BRICKMOULD

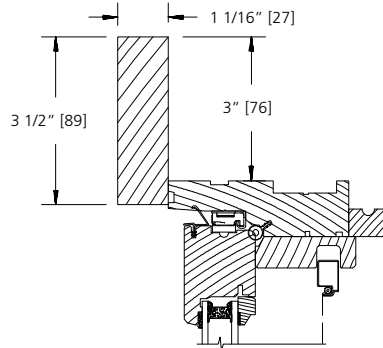

FLAT CASING

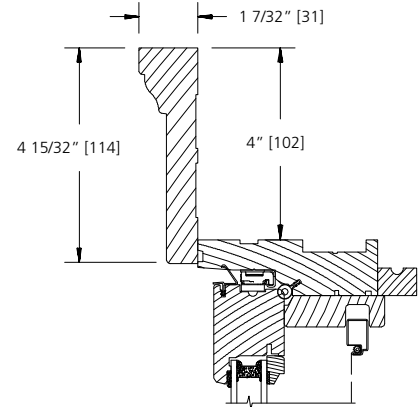

1 X 4 BACK BAND

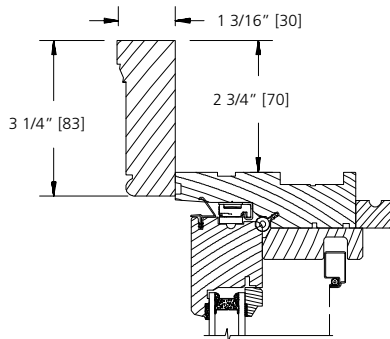

HERITAGE

WOOD SUBSILL OPTIONS

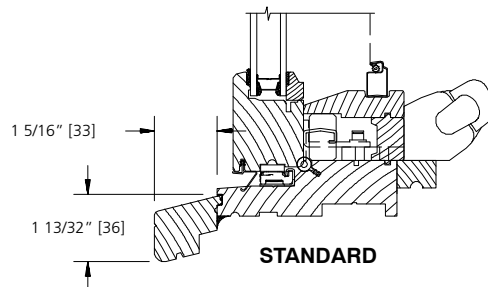

STANDARD

SCALE: 3" = 1'

**JAMB EXTENDER &
STUCCO TRIM OPTIONS**

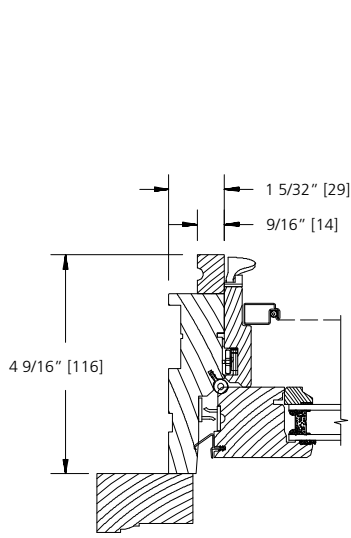

4 9/16" WALL

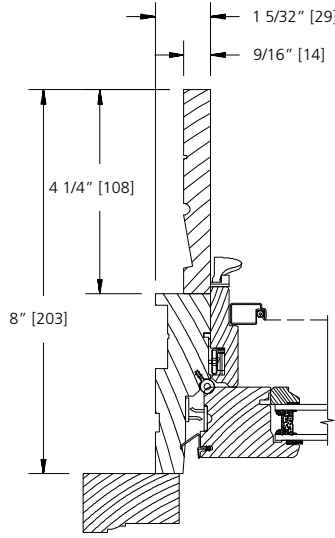

8" WALL

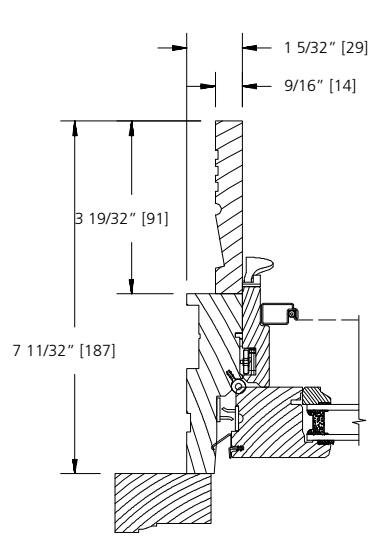

8 7/16" WALL

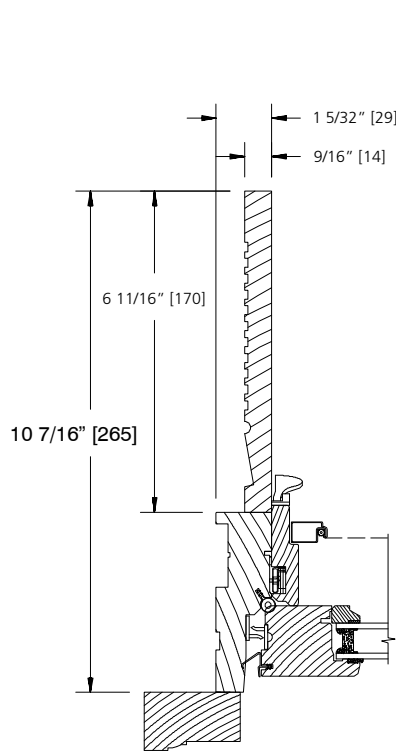

10 7/16" WALL

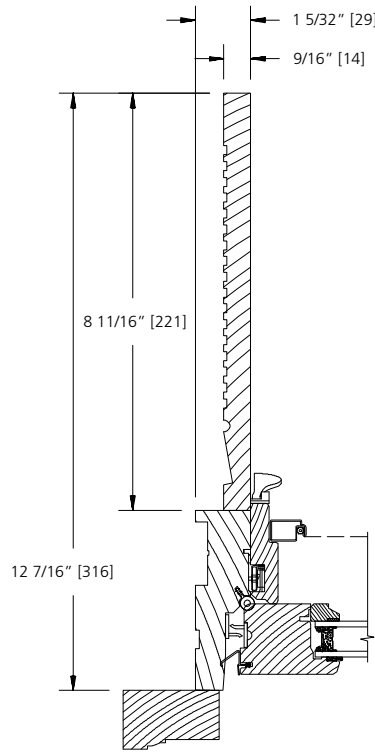

12 7/16" WALL

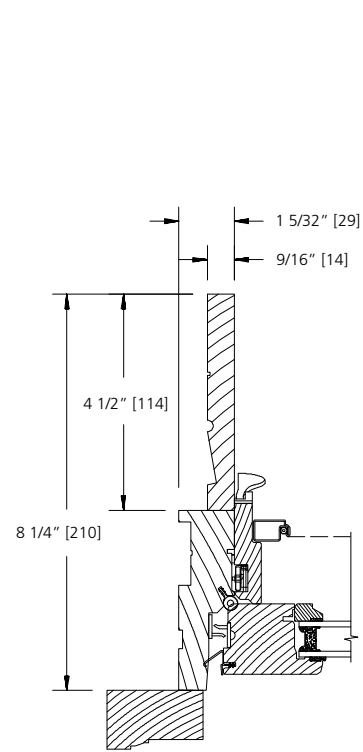

8 1/4" WALL

SCALE: 3" = 1'

STANDARD MULLION OPTIONS

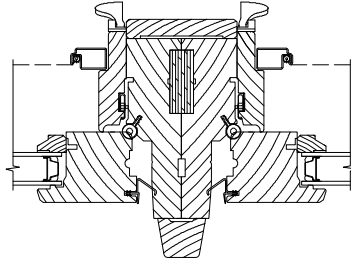

TWIN OPERATING CASEMENT

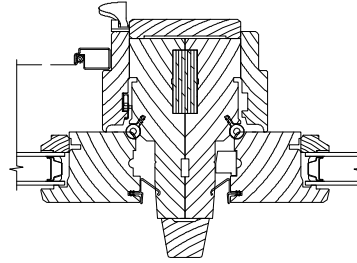

**OPERATING CASEMENT
NEXT TO CASEMENT PICTURE**

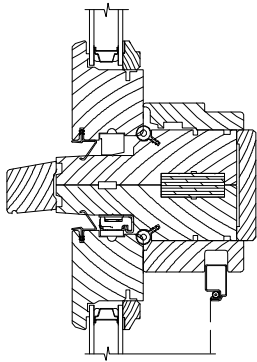

**CASEMENT PICTURE
OVER CASEMENT**

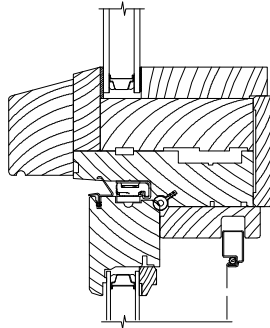

**DIRECT SET GEOMETRIC
OVER CASEMENT**

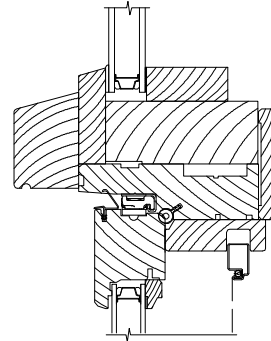

**DIRECT SET RADIUS
OVER CASEMENT**

STANDARD MULLION OPTIONS
SPREAD MULL

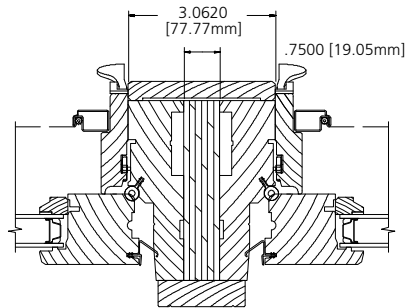

3/4" WOOD SPREAD MULL

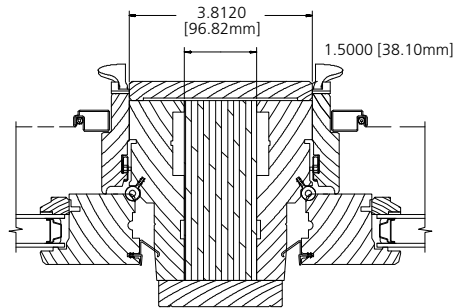

1 1/2" WOOD SPREAD MULL

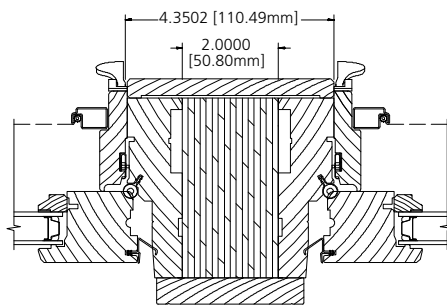

2" WOOD SPREAD MULL

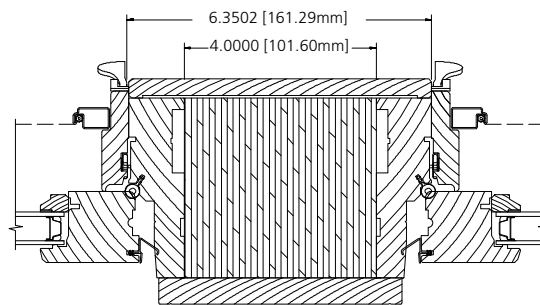

4" WOOD SPREAD MULL

SCALE: 3" = 1'

LITE CUT INFORMATION

Wood casement windows are available with removable grilles in 7/8", 1-1/8" and 1-3/8" widths, Airspace (between the panes) grilles, and Simulated Divided Lites. Standard lite cuts are rectangular.

LITE CUT OPTIONS

Special lite cut patterns can include a wide variety of straight line and radius patterns. The illustrations shown here represent just a few of the possibilities. Rectangular, horizontal, vertical and Prairie lite patterns are available in all standard size wood casement windows. Uneven, diamond, radius and Gothic lite cuts are available, subject to approval. Approvals are based on the ability to fulfill the design requirement while maintaining the construction integrity of the finished product.

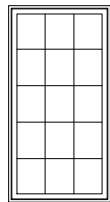

RECTANGULAR

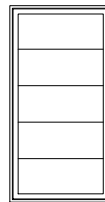

HORIZONTAL

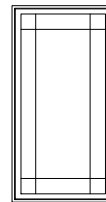

PRAIRIE

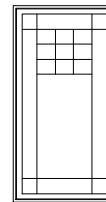

UNEVEN

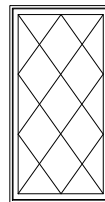

DIAMOND
SDL ONLY

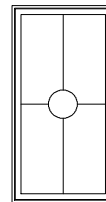

RADIUS

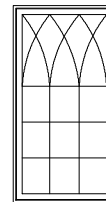

GOTHIC
SDL ONLY

BAR ALIGNMENT

Alignment of divided lite muntin bars from one window to the next is often required by fine architectural design. Wood grilles, Grilles between the glass, and Simulated Divided Lites may be specified with muntin bars aligned.

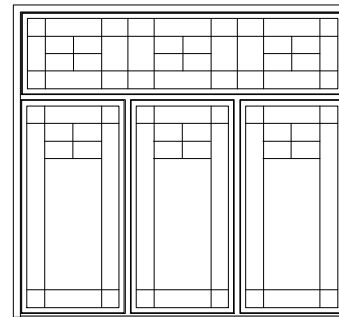

DIVIDED LITE OPTIONS

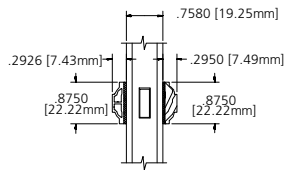

7/8" SDL

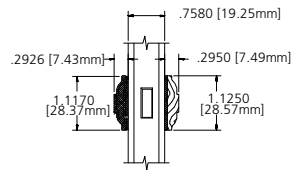

1 1/8" SDL

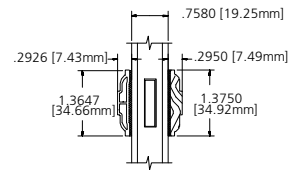

1 3/8" SDL

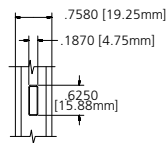

5/8" GRILLE

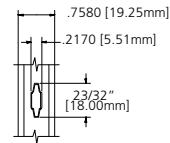

23/32" GRILLE

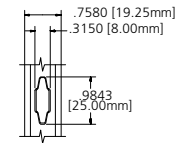

1" GRILLE

**UNIT SIZING, ROUGH OPENINGS
& MASONRY OPENINGS**

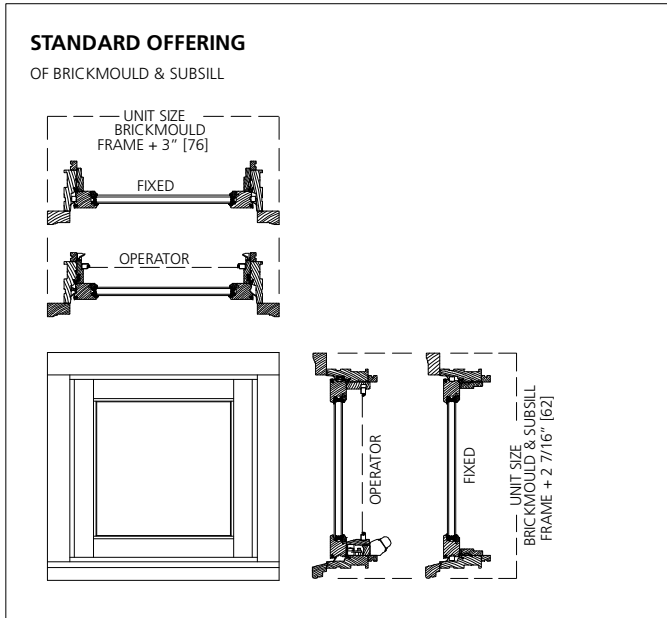

GENERAL NOTES:

UNITS WITH NO TRIM AND SUBSILL:
UNIT SIZE = FRAME SIZE

UNIT SIZE IS ALWAYS THE
EXTREME SIZE OF THE WINDOW
WITH OR WITHOUT TRIM

MASONRY OPENING:
MASONRY OPENING IS ALWAYS 3/4" OVER
THE UNIT SIZE OF THE WINDOW

ROUGH OPENING:

ROUGH OPENING IS ALWAYS 3/4" OVER
FRAME SIZE OF THE WINDOW

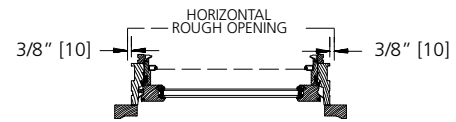

EXCEPTION: SEE DRAWING BELOW

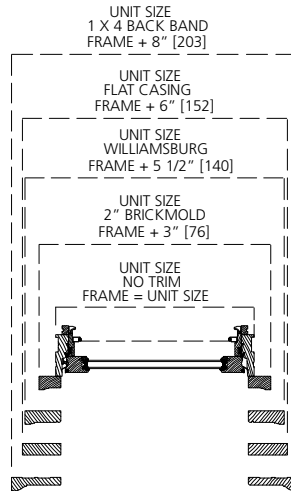
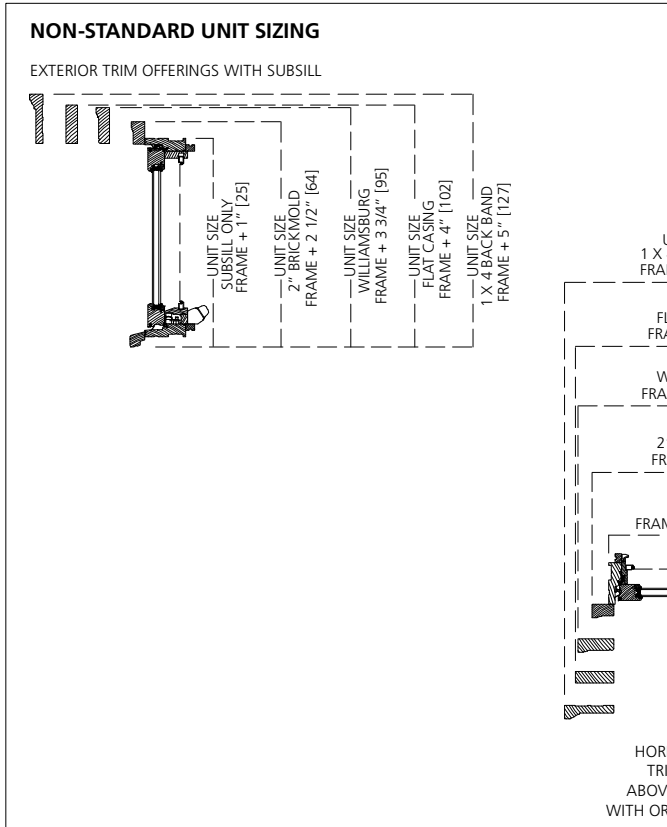
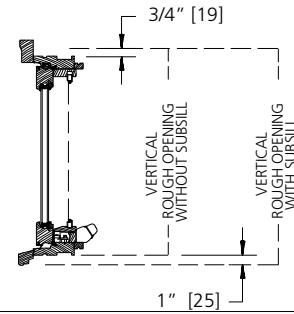

HORIZONTAL SECTION
TRIM OFFERINGS
ABOVE ARE THE SAME
WITH OR WITHOUT SUBSILL

**FRAME TO TRIM
DIMENSIONS**

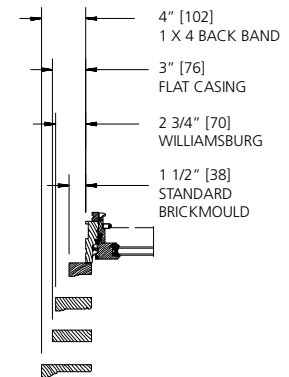

TYPICAL FOR HEAD & SIDE

OPERATING UNIT

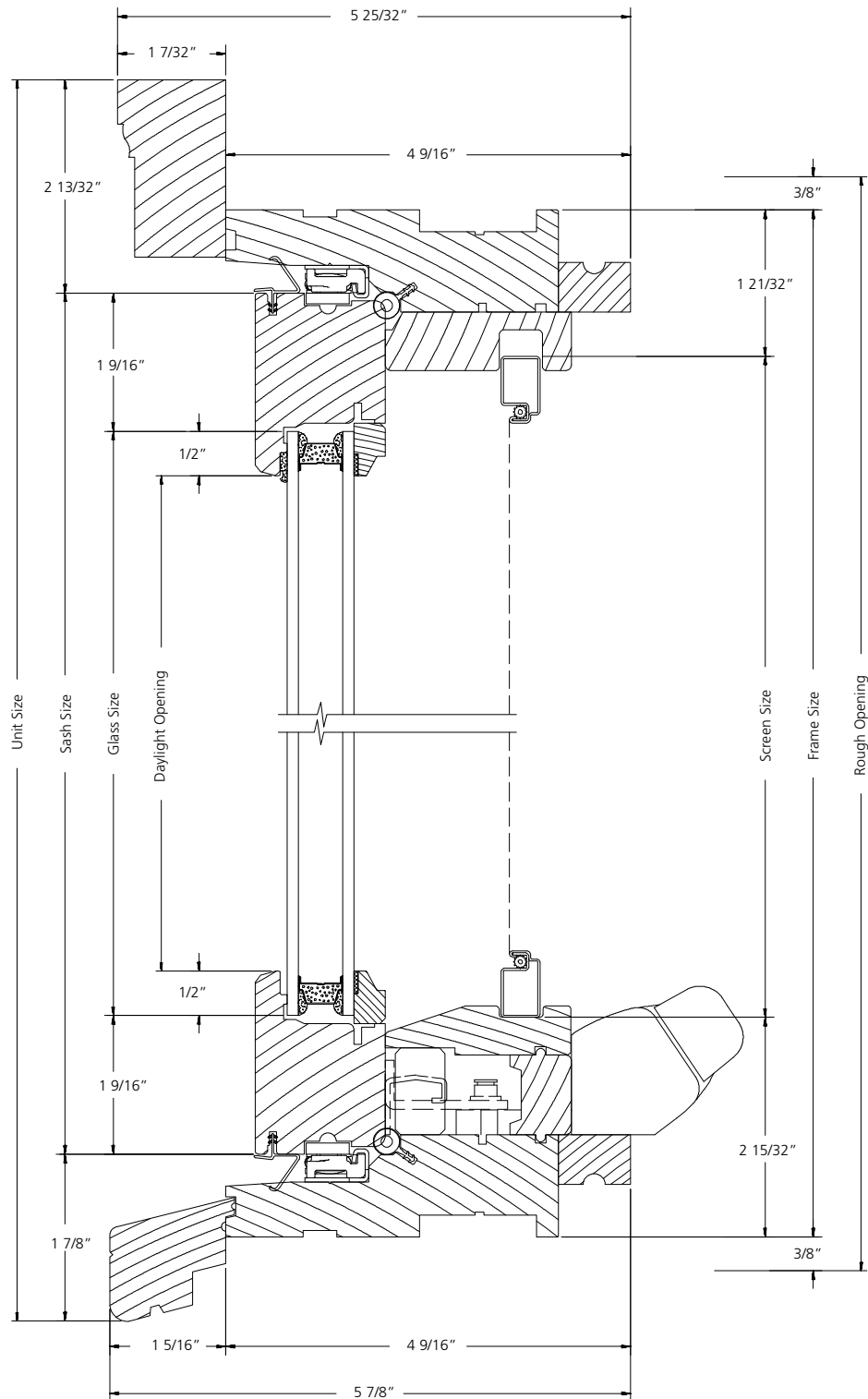

VERTICAL SECTION

SCALE: 6" = 1'

OPERATING UNIT
1-WIDE

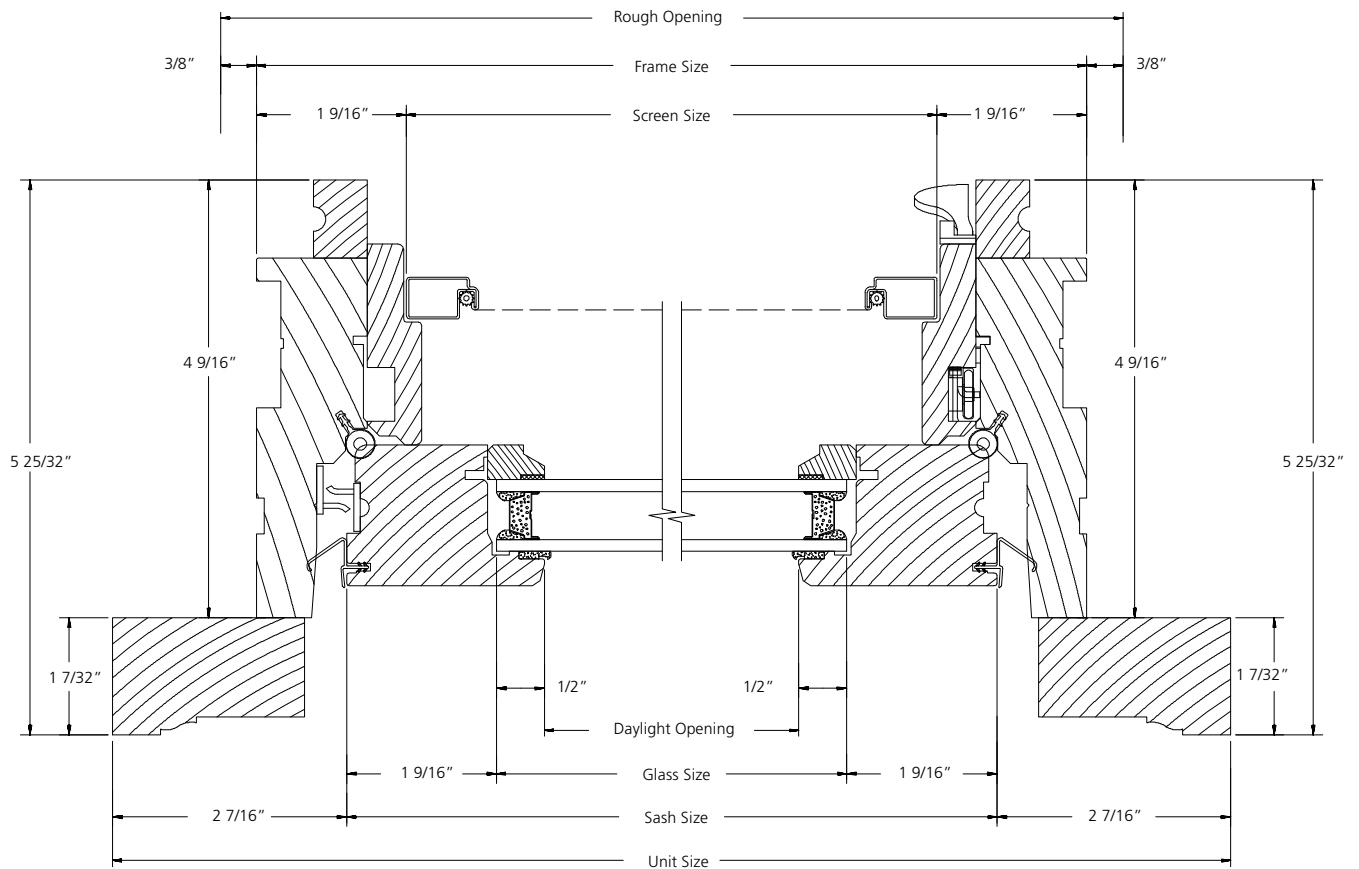

HORIZONTAL SECTION

SCALE: 6" = 1'

**OPERATING UNIT
2-WIDE**

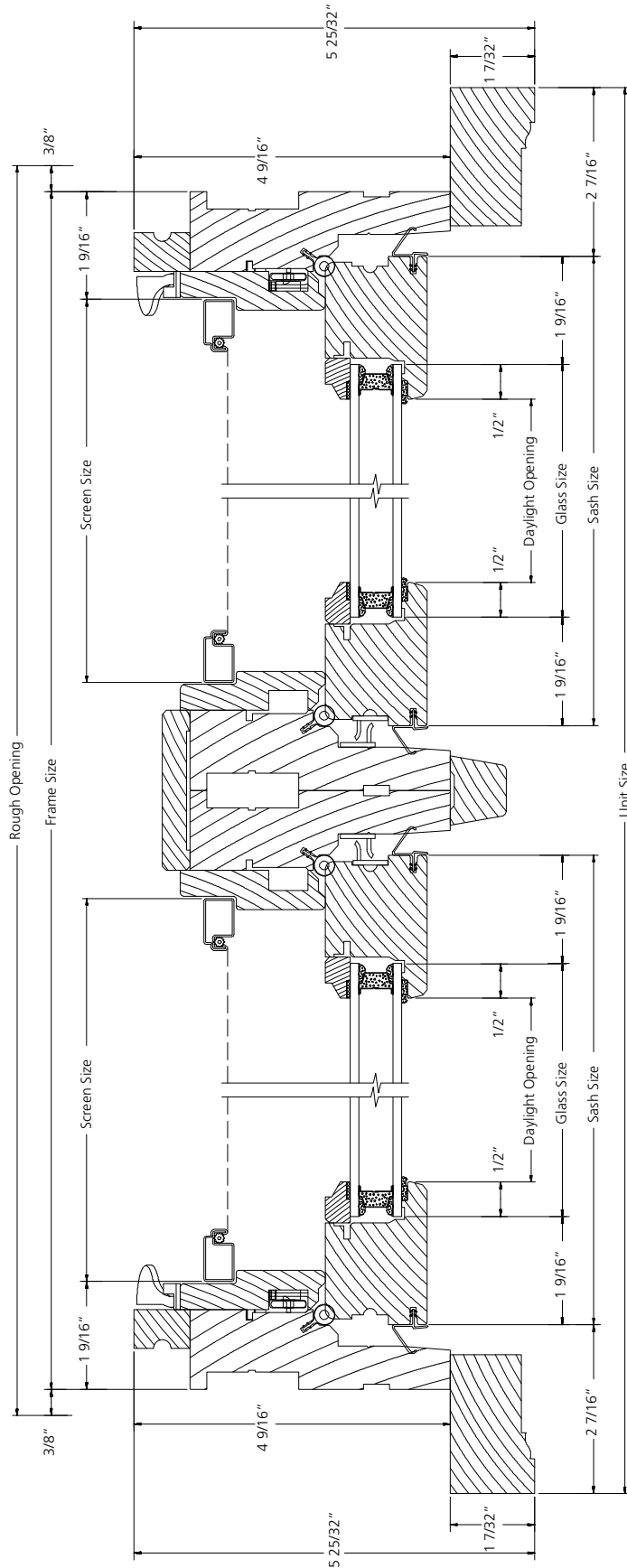

HORIZONTAL SECTION

SCALE: 6" = 1'

PICTURE UNIT

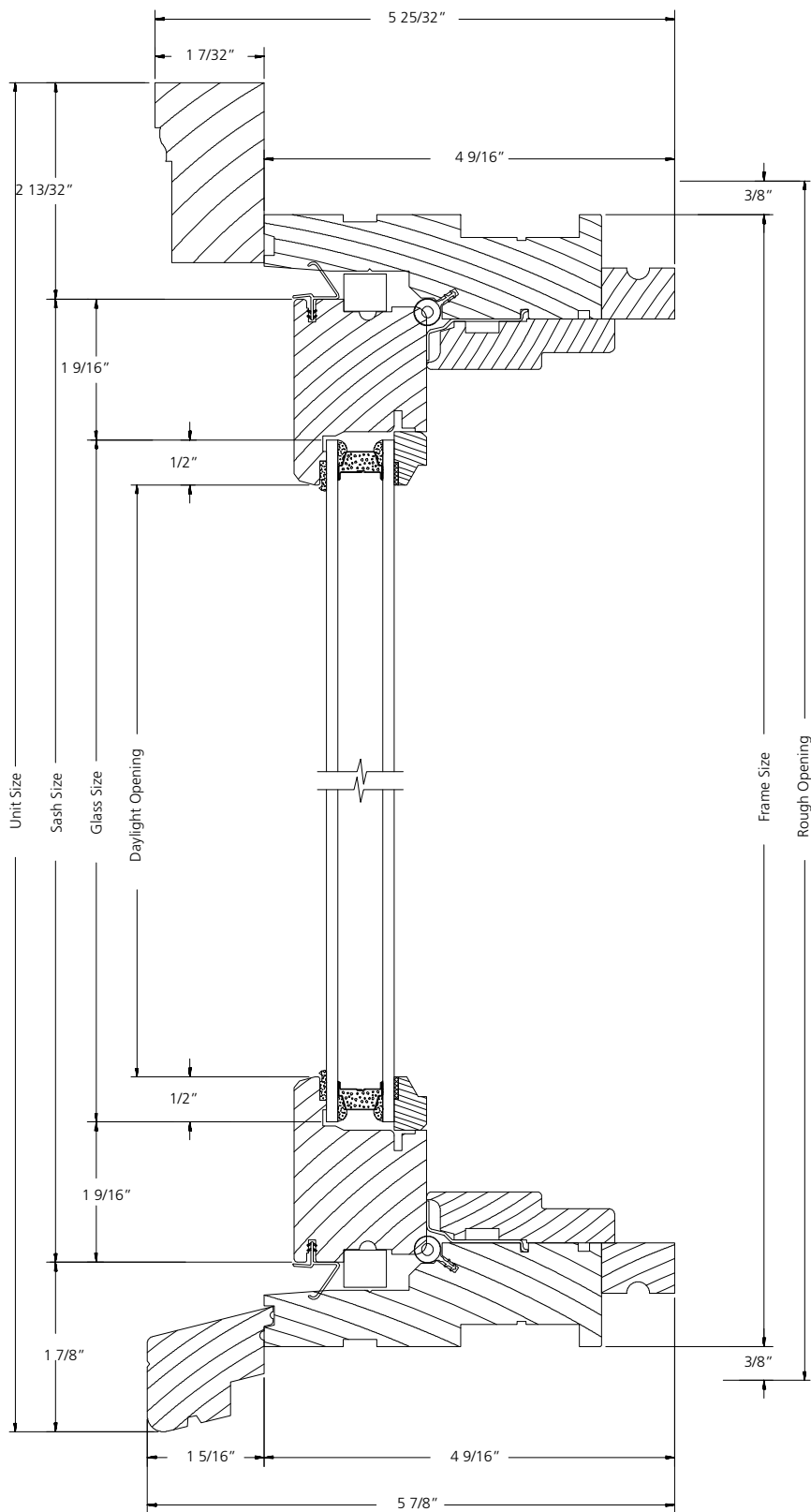

VERTICAL SECTION

SCALE: 6" = 1'

PICTURE UNIT

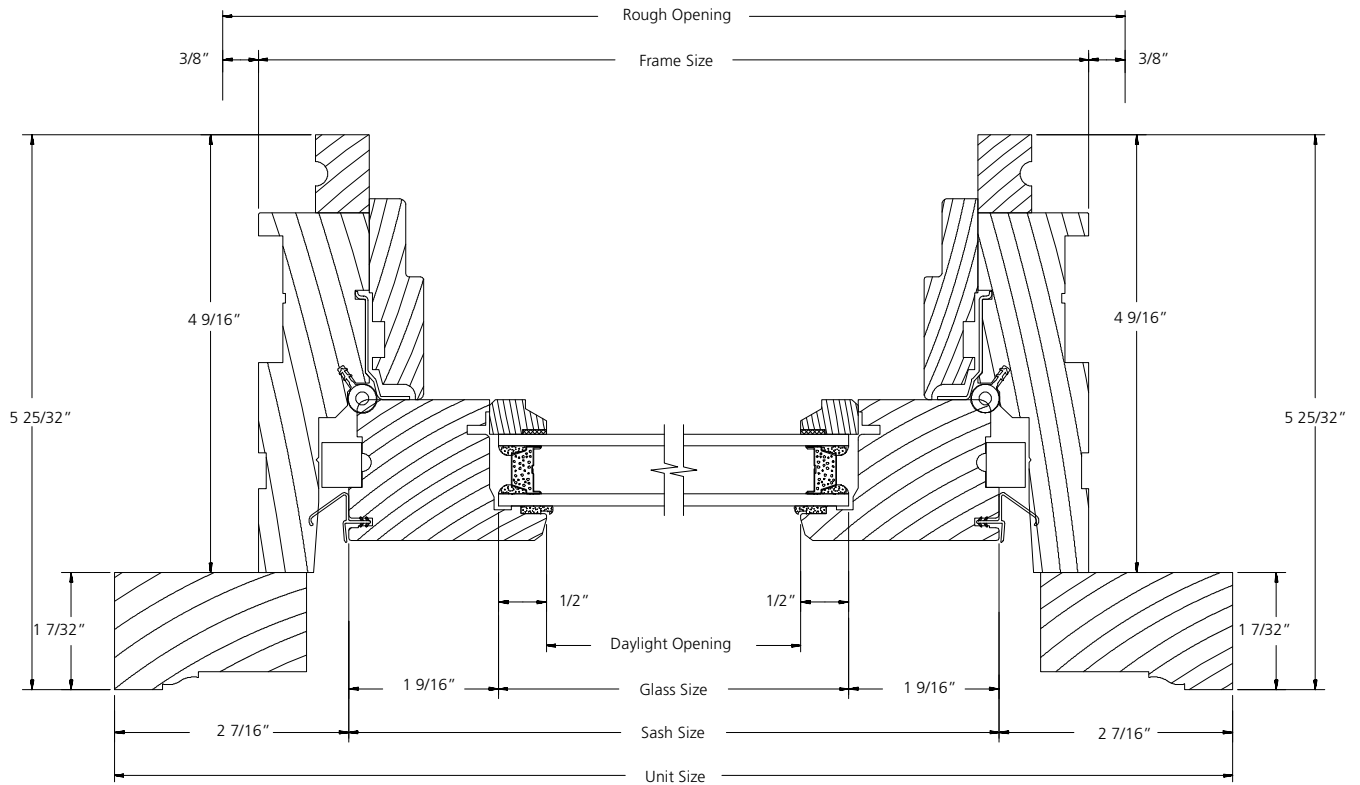

HORIZONTAL SECTION

SCALE: 6" = 1'

PICTURE UNIT WITH OPERATING FLANKERS

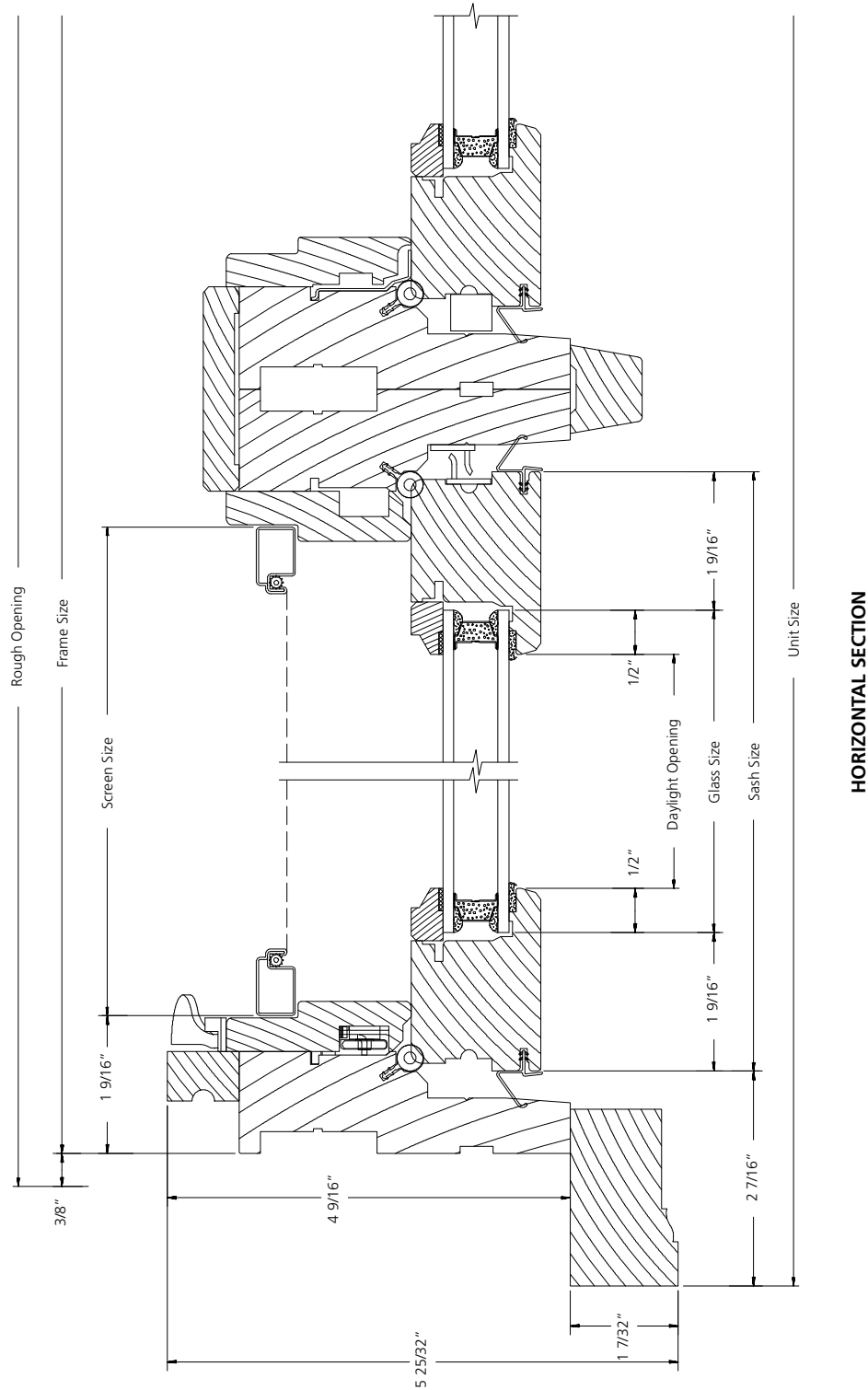

HORIZONTAL SECTION

SCALE: 6" = 1'

BOW WINDOW HORIZONTAL SPECIFICATION TABLES

BOW WINDOW HORIZONTAL SPECIFICATION TABLES

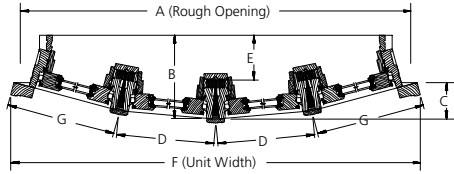

EXTREME PERIMETER
Extreme Perimeter is the distance around the face of the bow, beginning at the exterior sheathing and continuing around the assembly along the extreme face of the brickmould.

4 WIDE BOW									
Flanker Width	A Rough Opening	F Unit Width	B Overall * Projection	C Projection Exterior Wall	E Seating* Depth	D Outside Mull To Mull	G Outside Mull To Unit	R Radius	
18	73 9/16	76 15/64	11 21/64	6 49/64	6 49/64	18 13/16	19 25/32	107 15/16	
24	97 1/8	99 25/32	13 25/64	8 53/64	8 53/64	24 13/16	25 25/32	142 3/8	
28	112 13/16	115 15/32	14 25/32	10 7/32	10 7/32	28 13/16	29 25/32	165 5/16	

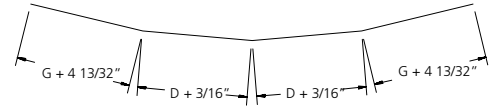

EXTREME PERIMETER

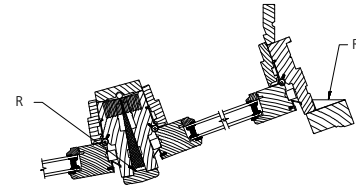
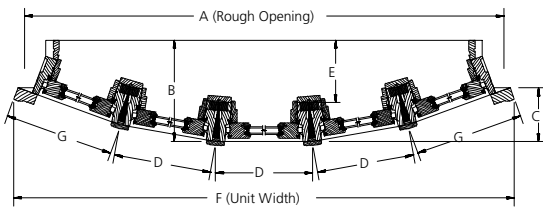

RADIUS NOTE: The Radius of a Bow Window is referenced from the interior of the Brickmould.

5 WIDE BOW									
Flanker Width	A Rough Opening	F Unit Width	B Overall * Projection	C Projection Exterior Wall	E Seating* Depth	D Outside Mull To Mull	G Outside Mull To Unit	R Radius	
18	90 7/8	93 25/32	14 19/32	10 1/32	10 1/32	18 13/16	19 25/32	107 15/16	
24	119 15/16	122 1/16	17 11/16	13 1/8	13 1/8	24 13/16	25 25/32	142 3/8	
28	139 5/16	142 17/64	19 3/4	15 3/16	15 3/16	28 13/16	29 25/32	165 5/16	

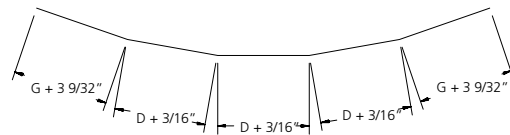

EXTREME PERIMETER

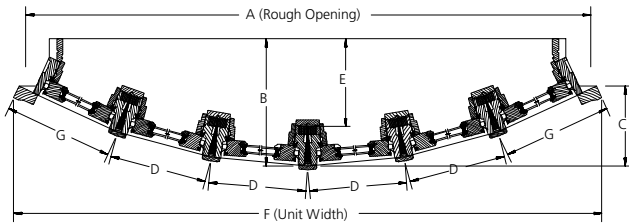

6 WIDE BOW									
Flanker Width	A Rough Opening	F Unit Width	B Overall * Projection	C Projection Exterior Wall	E Seating* Depth	D Outside Mull To Mull	G Outside Mull To Unit	R Radius	
18	107 3/8	110 39/64	19 27/64	14 55/64	14 55/64	18 13/16	19 25/32	107 15/16	
24	141 13/16	145 1/32	24 3/64	19 31/64	19 31/64	24 13/16	25 25/32	142 3/8	
28	164 3/4	167 31/32	27 7/64	22 35/64	22 35/64	28 13/16	29 25/32	165 5/16	



EXTREME PERIMETER

4 9/16 and 6 9/16 WALL APPLICATION

The tables above reflect a 4 9/16" wall application. To convert to 6 9/16" wall application add 2" to the figures in the columns which show an asterisk (*), B and E.

BAY & BOW WINDOW ROUGH OPENINGS

BAY & BOW WINDOW TRIM OPTIONS

The standard offering for wood bay & bow windows is 'frame only,' brickmould and subsill. Other trim options subject to approval. Rough & Masonry openings remain consistent with all trim options.

VERTICAL ROUGH OPENING

Rough Opening typical for all Units

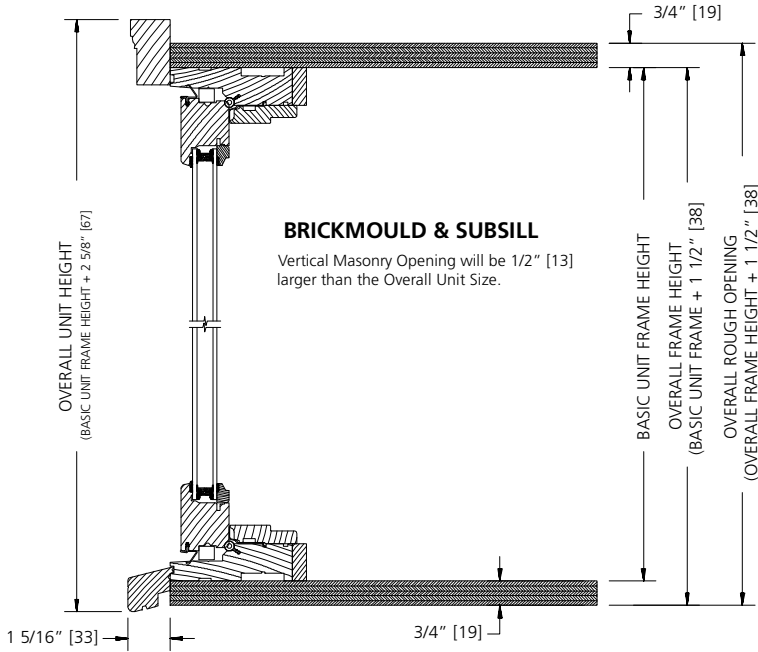

HORIZONTAL ROUGH OPENING

Rough Opening typical for all Units

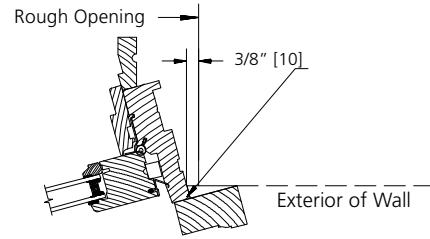

4-, 5- & 6-WIDE BOWS

4-Wide Bow Shown without trim

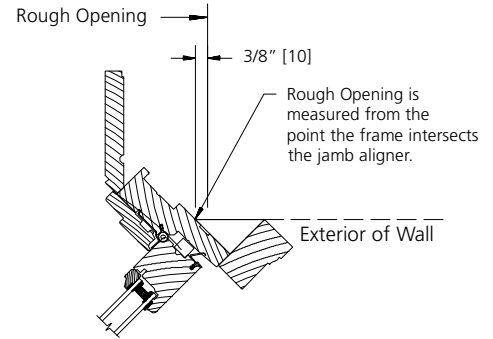

30° & 45° BAYS

45° Bay Shown with Brickmould

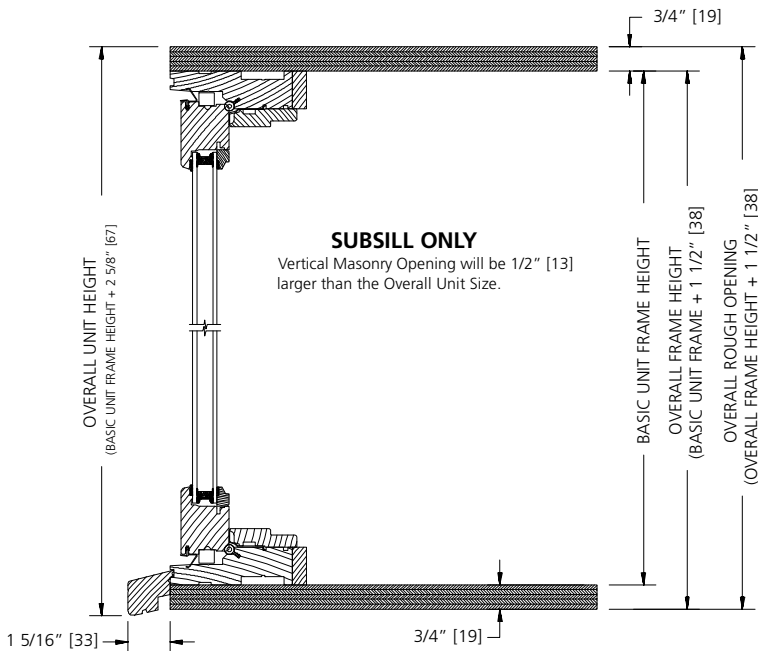

BAY & BOW WINDOW ROUGH OPENINGS

VERTICAL ROUGH OPENING

Rough Opening typical for all Units

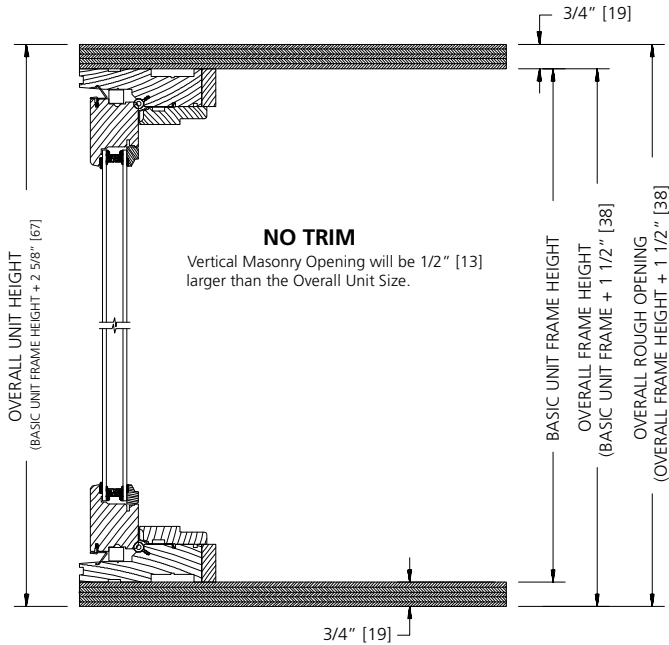

HORIZONTAL ROUGH OPENING

Rough Opening typical for all Units

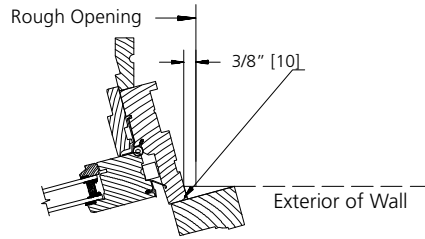

4-, 5- & 6-WIDE BOWS

4-Wide Bow Shown without trim

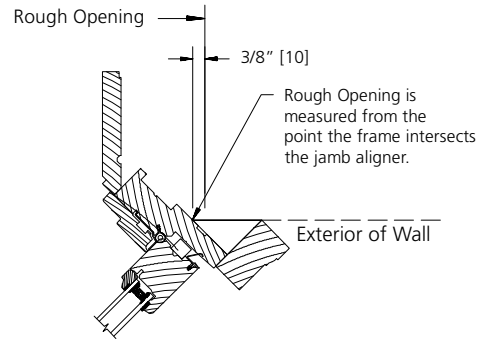

30° & 45° BAYS

45° Bay Shown with Brickmould

ANGLE BAY AND BOW UNITS

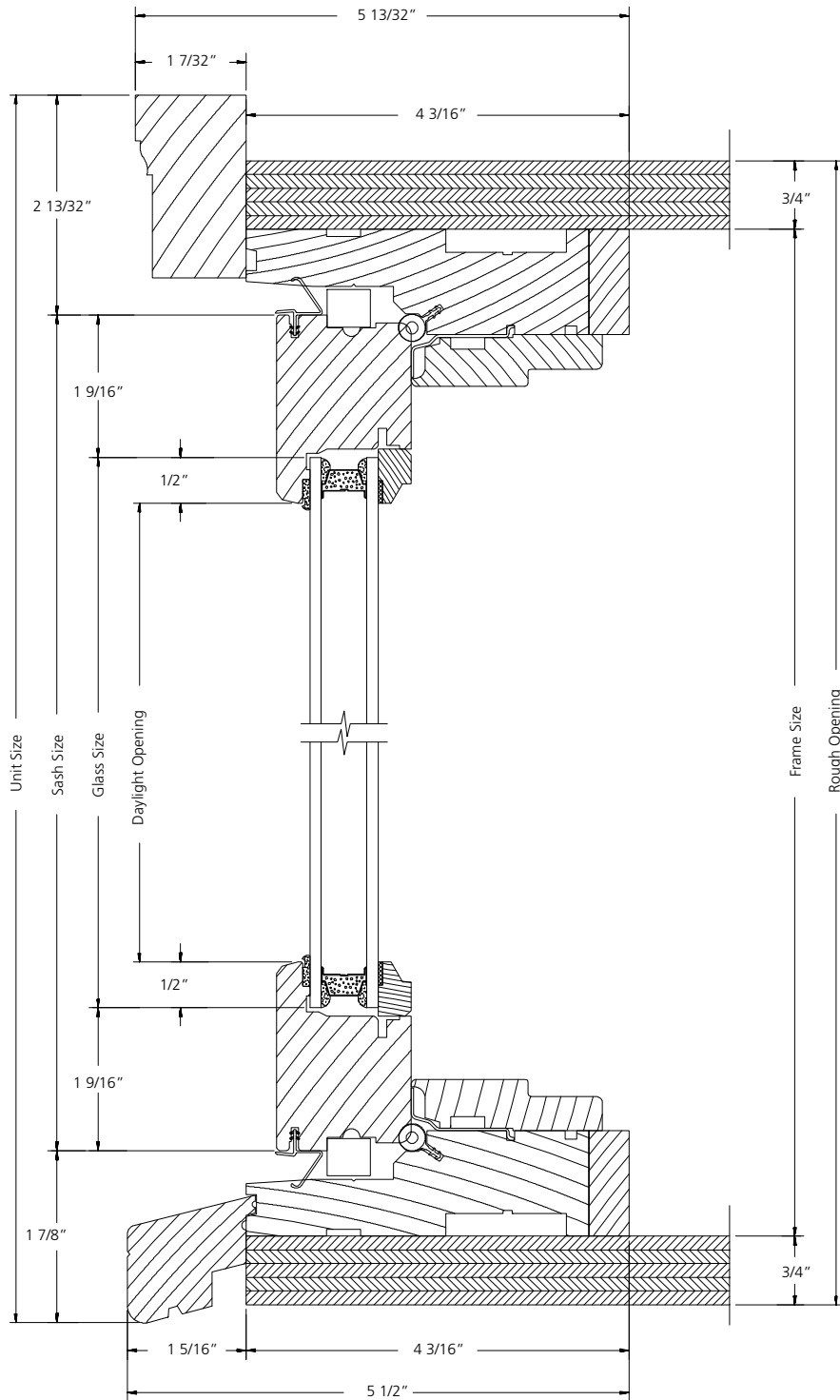

VERTICAL SECTION

SCALE: 6" = 1'

30° ANGLE BAY UNIT

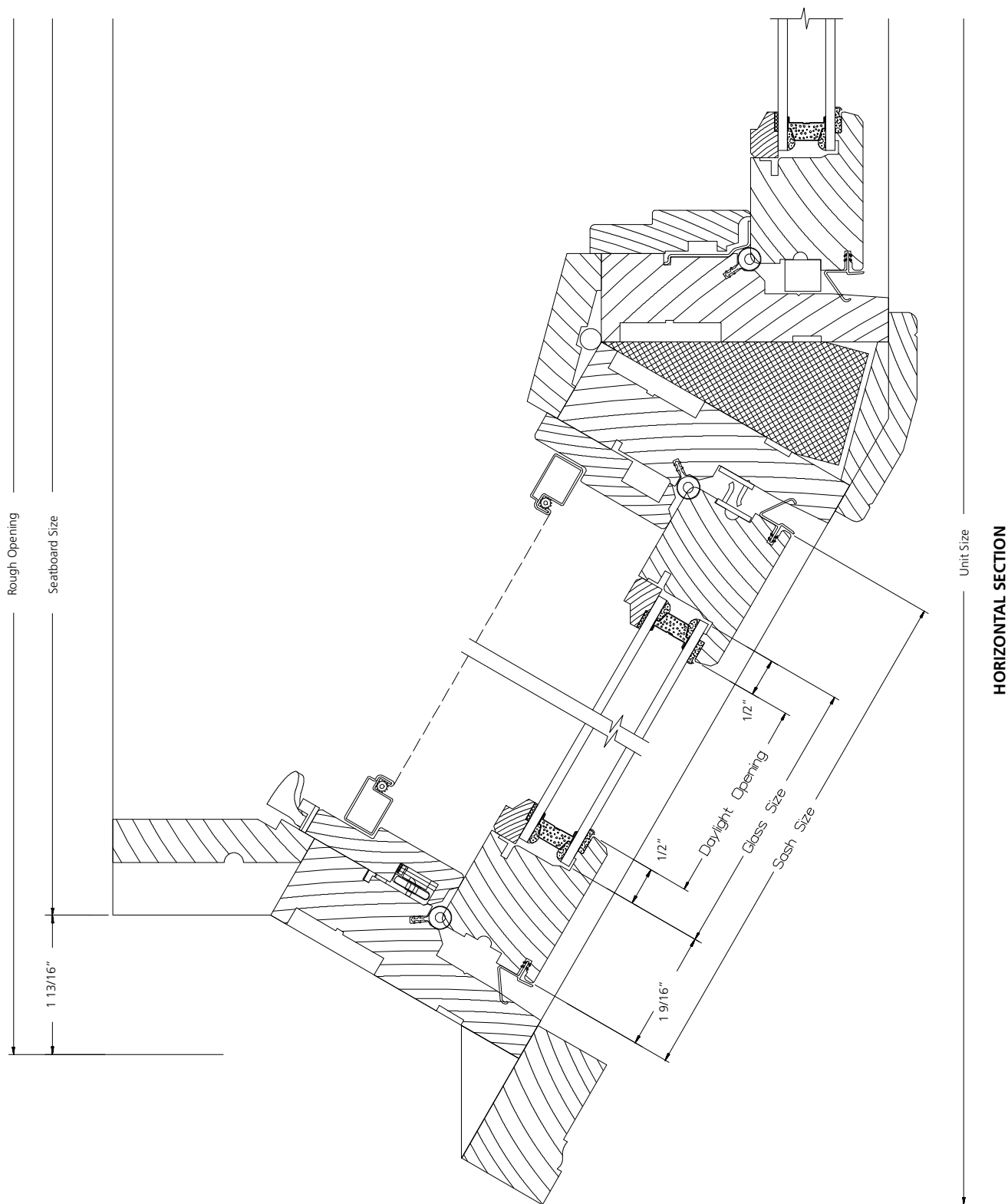

SCALE: 6" = 1'

45° ANGLE BAY UNIT

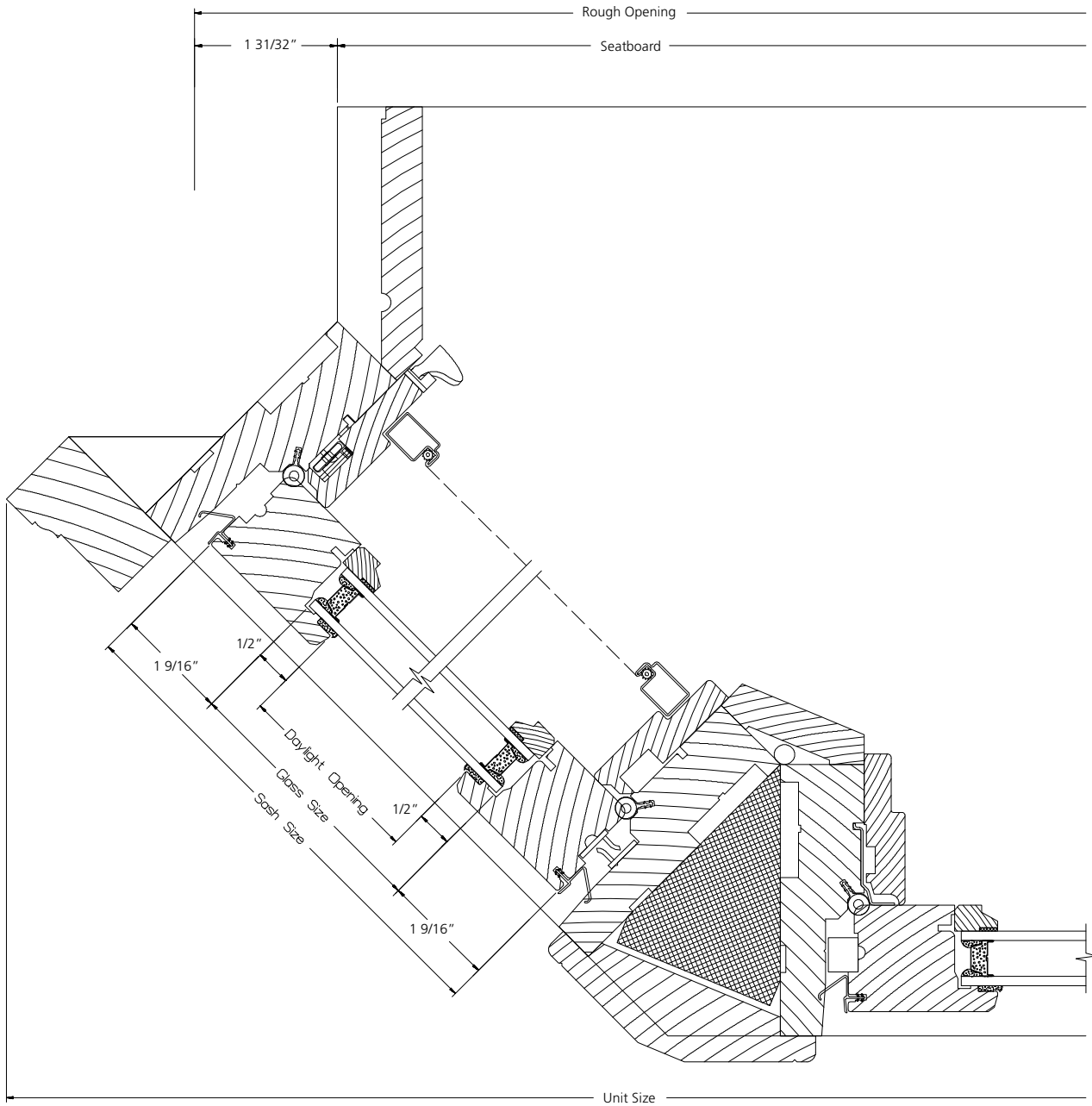

HORIZONTAL SECTION

SCALE: 6" = 1'

4-WIDE BOW UNIT

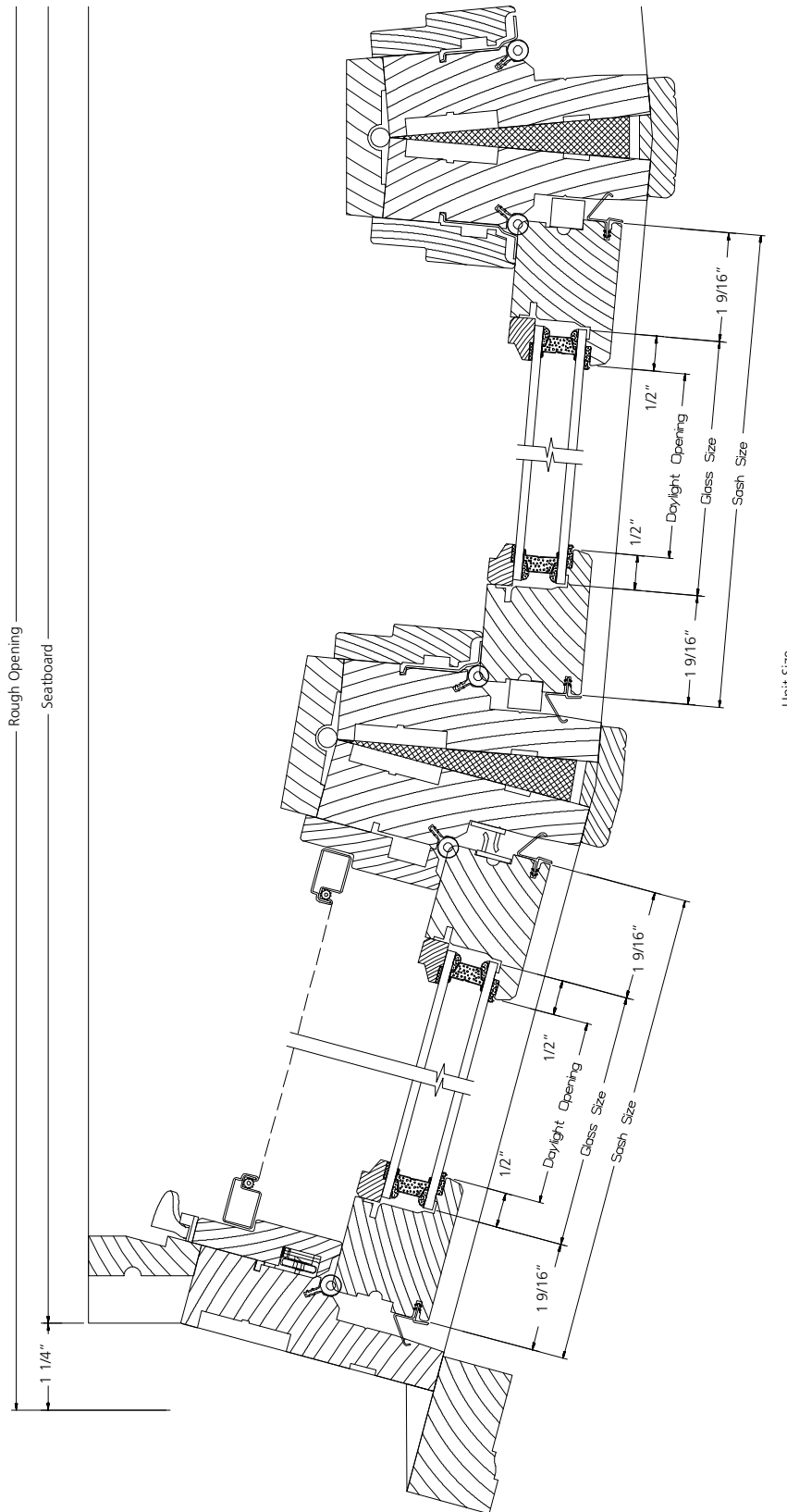

HORIZONTAL SECTION

5-WIDE BOW UNIT

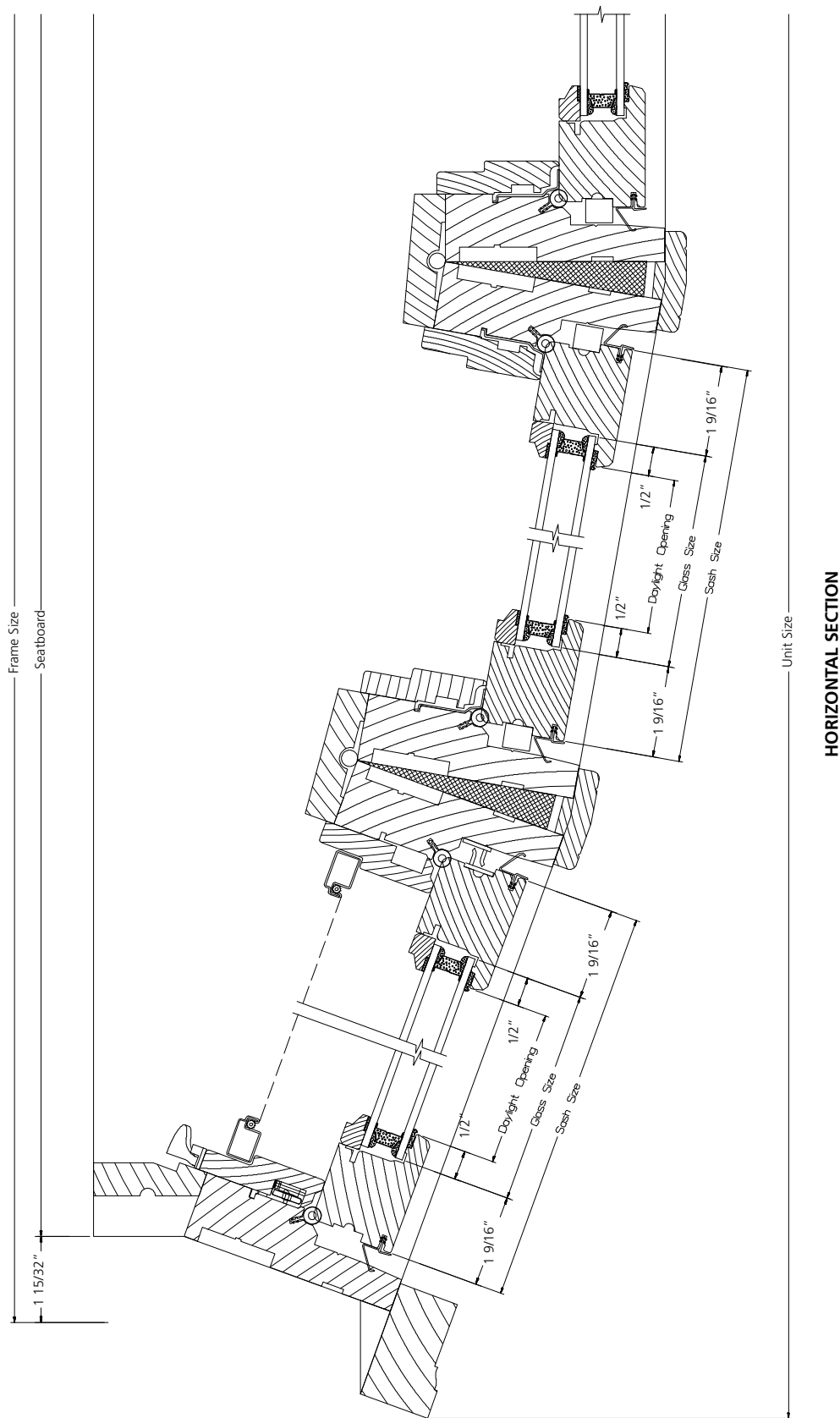

HORIZONTAL SECTION

SCALE: 3" = 1'

6-WIDE BOW UNIT

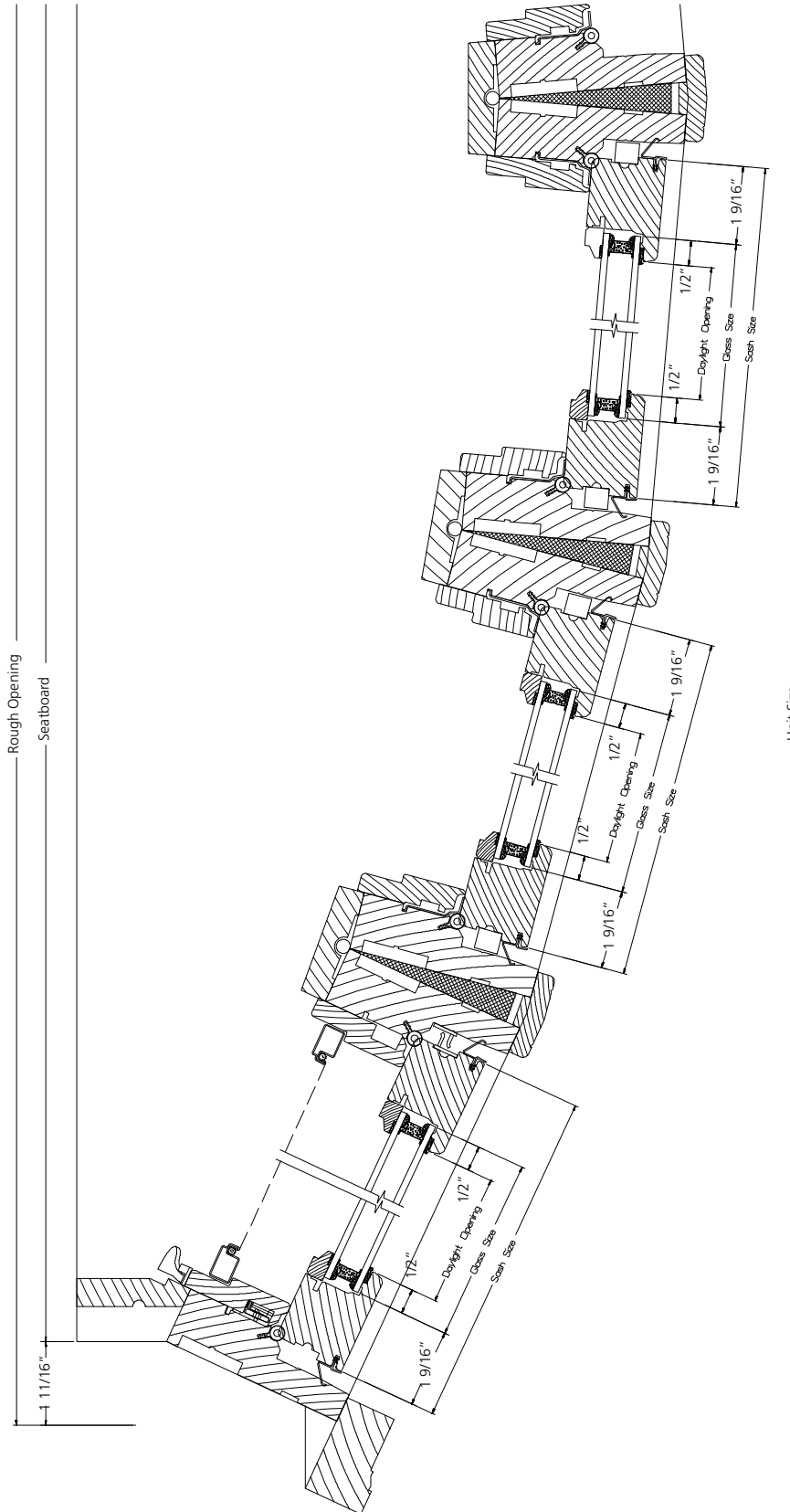

HORIZONTAL SECTION

Unit Size