

---

**TABLE OF CONTENTS**

---

Elevations/Sizes: 1/4" Scale .....	5-2
1-Wide Units .....	5-5
2-Wide Units .....	5-8
3-Wide Units .....	5-10
Picture Units .....	5-14
Picture Units with Flankers .....	5-23
Angle Bay Units with Flankers .....	5-26
Transom Units .....	5-32
Pocket Window .....	5-35
Glazing Options .....	5-37
Trim Options: 3" Scale .....	5-38
Jamb Extender Options: 3" Scale .....	5-39
Standard Mullion Options .....	5-40
Lite Cut Information & Options .....	5-42
Unit Sizing, Rough Openings & Masonry Openings .....	5-44
Section Details: 6" Scale .....	5-45
Angle Bay Rough Opening Information .....	5-57
Section Details: 6" Scale (Angle Bay) .....	5-58

---

**GENERAL INFORMATION**

---

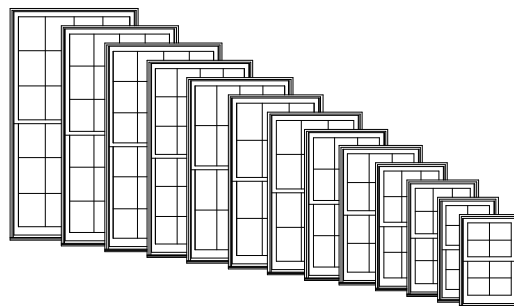

**DIMENSIONAL WINDOWS**

Clad double-hung windows may be specified as "dimensional" by adjusting the the desired rough opening width or height in 1/8" increments from standard.

Clad double-hung windows feature fully operating upper and lower sash. Counterbalancing is achieved with block and tackle spring extension systems hidden in weatherable PVC jamb liners. Operating units are supplied with cam-type sash locks installed. Die-cast lower sash lifts supplied for field installation are an option. Recessed sash retainers provide simple sash installation and removal. There are several hardware finish options. Refer to the Specifications for available finish options.

**MULTIPLE ASSEMBLIES**

Clad double-hung windows may be mullied beside other clad double-hungs or clad picture windows, or below clad transom windows, to fulfill a wide variety of needs. Factory assembled mulls are limited in height (100"), width (114"), and a total area (75 square feet).

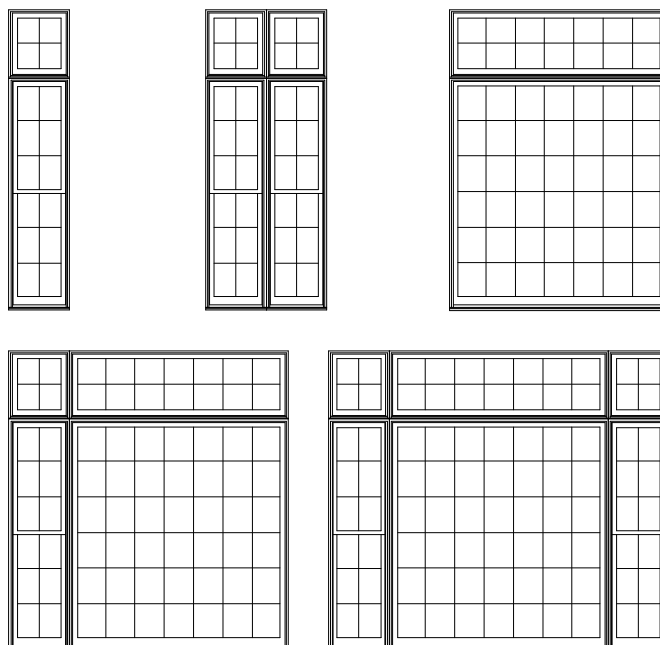

---

**HANDING & OPERATION**

---

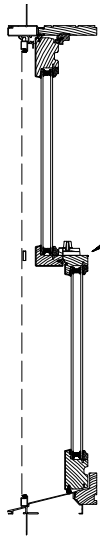

**DOUBLE-HUNG OPERATION:**  
When the sash are locked at the check rails the sash are closed and sealed in the sash opening of the frame.

When the sash are unlocked the lower sash travels vertically to any position desired. The upper sash can also be positioned as desired.

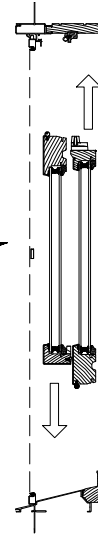

**SASH TILTING FOR WASHING**

The Tradition Plus Double-Hung window will allow the sash to be tilted or removed for easy cleaning.

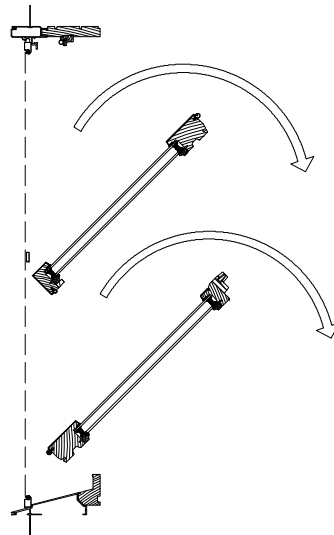

**ELEVATION NOTES**  
**DOUBLE-HUNG**

ELEVATION DRAWINGS UTILIZE A LIMITED NUMBER OF PROJECTED LINES TO PRODUCE A RUDIMENTARY DRAWING INTENDED TO BE USED IN A SMALL GRAPHICAL SCALE. ELEVATIONS ARE VIEWED PERPENDICULAR FROM THE EXTERIOR OF THE STRUCTURE. IF MORE DIMENSIONS ARE NEEDED, USE THE SECTION DRAWINGS FOR MORE COMPLETE DEPICTIONS.

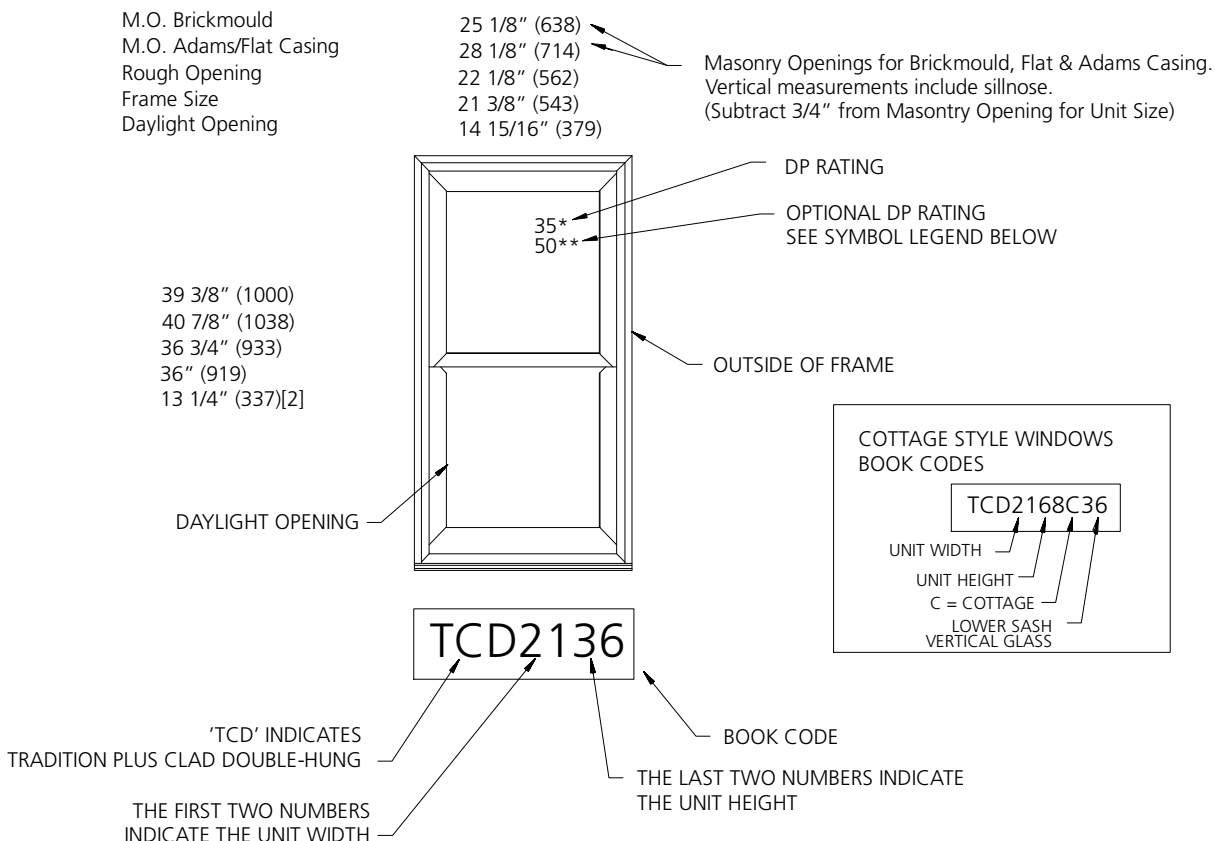











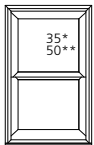
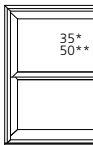

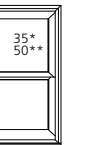
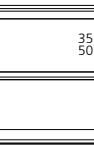

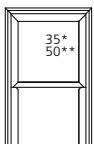
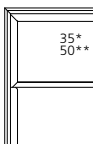
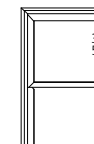

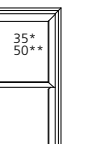
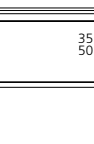

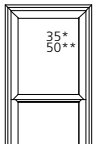
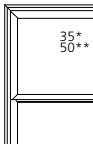

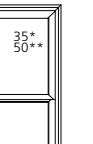
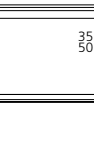

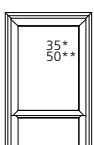
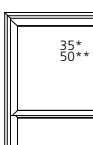

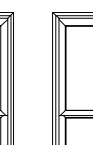

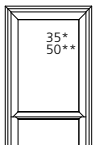
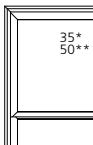

**GENERAL DOUBLE-HUNG NOTES**

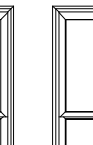
1. ALL UNITS SHOWN ARE AVAILABLE AS OPERATORS ONLY.
2. UNIT ELEVATIONS ARE SHOWN WITH BRICKMOULD AND SUBSILL.
3. DIMENSIONAL VALUES IN PARENTHESES ARE MILLIMETER CONVERSIONS.
4. VALUES IN BRACKETS ARE NUMBER OF DAYLIGHT OPENINGS.

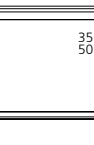
**ELEVATION SYMBOL LEGEND:**

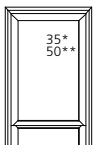
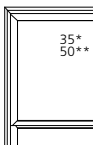
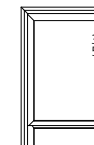
- M.O.** MASONRY OPENING
- E** BASIC UNIT CLEAR OPENING EXCEEDS 20" IN WIDTH, 24" IN HEIGHT & A MINIMUM OF 5.7 SQ. FT.
- ##\*** NUMBER INDICATES DESIGN PRESSURE (DP) RATING WITH STANDARD GLAZING.
- ##\*\*** NUMBER INDICATES OPTIONAL DESIGN PRESSURE (DP) RATING
- ++** TEMPERED GLASS, TINTED GLASS, OBSCURE GLASS AND/OR SDL OPTIONS REQUIRE A HEAVY DUTY JAMB LINER.

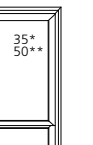
### 1-WIDE UNITS

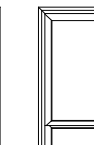
M.O. BRICKMOULD	25 1/8"(638)	29 1/8"(740)	33 1/8"(841)	37 1/8"(943)	41 1/8"(1045)	45 1/8"(1146)	49 1/8"(1248)
M.O. ADAMS/FLAT CASING	28 1/8"(714)	32 1/8"(816)	36 1/8"(918)	40 1/8"(1019)	44 1/8"(1121)	48 1/8"(1222)	52 1/8"(1324)
ROUGH OPENING	22 1/8"(562)	26 1/8"(664)	30 1/8"(765)	34 1/8"(867)	38 1/8"(968)	42 1/8"(1070)	46 1/8"(1172)
FRAME SIZE	21 3/8"(543)	25 3/8"(645)	29 3/8"(746)	33 3/8"(848)	37 3/8"(949)	41 3/8"(1051)	45 3/8"(1153)
DAYLIGHT OPENING	14 15/16"(379)	18 15/16"(481)	22 15/16"(583)	26 15/16"(684)	30 15/16"(786)	34 15/16"(887)	38 15/16"(989)
39 3/8"(1000) 40 7/8"(1038) 36 3/4"(933) 36"(914) 13 1/4"(337)[2]							
TCD2136	TCD2536	TCD2936	TCD3336	TCD3736	TCD4136	TCD4536	
43 3/8"(1102) 44 7/8"(1140) 40 3/4"(1035) 40"(1016) 15 1/4"(387)[2]							
TCD2140	TCD2540	TCD2940	TCD3340	TCD3740	TCD4140	TCD4540	
51 3/8"(1305) 52 7/8"(1343) 48 3/4"(1238) 48"(1219) 19 1/4"(489)[2]							
TCD2148	TCD2548	TCD2948	TCD3348	TCD3748	TCD4148	TCD4548	
55 3/8"(1407) 56 7/8"(1445) 52 3/4"(1340) 52"(1321) 21 1/4"(540)[2]							
TCD2152	TCD2552	TCD2952	TCD3352	TCD3752	TCD4152	TCD4552	
59 3/8"(1508) 60 7/8"(1546) 56 3/4"(1441) 56"(1422) 23 1/4"(591)[2]							
TCD2156	TCD2556	TCD2956	TCD3356	TCD3756	TCD4156	TCD4556	
63 3/8"(1609) 64 7/8"(1648) 60 3/4"(1543) 60"(1524) 25 1/4"(641)[2]							
TCD2160	TCD2560	TCD2960	TCD3360	TCD3760	TCD4160	TCD4560	

**ELEVATION SYMBOL LEGEND:**

M.O. = MASONRY OPENING  
 VALUES IN ( ) ARE IN MILLIMETER CONVERSIONS  
 VALUES IN [ ] ARE NUMBER OF DAYLIGHT OPENINGS PER UNIT  
 ### NUMBER INDICATES DESIGN PRESSURE (DP) RATING WITH STANDARD GLAZING.  
 ###\* NUMBER INDICATES OPTIONAL DESIGN PRESSURE (DP) RATING.  
 E BASIC UNIT CLEAR OPENING EXCEEDS 20" IN WIDTH, 24" IN HEIGHT & A MINIMUM OF 5.7 SQ. FT.

Note Elevations shown DO NOT have exterior trim. Subtract 3/4" (19) from M.O. (Masonry Opening) for Unit Sizes. Masonry Openings above include Sill Nose, see Trim Options page for Sill Nose specifications. For other Trim Options refer to the Unit Sizing, Rough Opening & Masonry Openings page.

SCALE: 1/4" = 1'

### 1-WIDE UNITS

M.O. BRICKMOLD	25 1/8"(638)	29 1/8"(740)	33 1/8"(841)	37 1/8"(943)	41 1/8"(1045)	45 1/8"(1146)	49 1/8"(1248)
M.O. ADAMS/FLAT CASING	28 1/8"(714)	32 1/8"(816)	36 1/8"(918)	40 1/8"(1019)	44 1/8"(1121)	48 1/8"(1222)	52 1/8"(1324)
ROUGH OPENING	21 3/8"(543)	26 1/8"(664)	30 1/8"(765)	34 1/8"(867)	38 1/8"(968)	42 1/8"(1070)	46 1/8"(1172)
FRAME SIZE	21 3/8"(543)	25 3/8"(645)	29 3/8"(746)	33 3/8"(848)	37 3/8"(949)	41 3/8"(1051)	45 3/8"(1153)
DAYLIGHT OPENING	14 15/16"(379)	18 15/16"(481)	22 15/16"(583)	26 15/16"(684)	30 15/16"(786)	34 15/16"(887)	38 15/16"(989)
67 3/8"(1711) 68 7/8"(1749) 64 3/4"(1645) 64"(1626) 27 1/4"(692)[2]							
71 3/8"(1813) 72 7/8"(1851) 68 3/4"(1746) 68"(1727) 45 1/4"(1149)13 1/4"(337)[2]							
71 3/8"(1813) 72 7/8"(1851) 68 3/4"(1746) 68"(1727) 29 1/4"(743)[2]							
75 3/8"(1915) 76 7/8"(1953) 72 3/4"(1848) 72"(1829) 31 1/4"(794)[2]							
79 3/8"(2016) 80 7/8"(2054) 76 3/4"(1949) 76"(1930) 33 1/4"(845)[2]							

**ELEVATION SYMBOL LEGEND:**  
**M.O.** = MASONRY OPENING  
 VALUES IN ( ) ARE IN MILLIMETER CONVERSIONS  
 VALUES IN [ ] ARE NUMBER OF DAYLIGHT OPENINGS PER UNIT  
 ### NUMBER INDICATES DESIGN PRESSURE (DP) RATING WITH STANDARD GLAZING.  
 #### NUMBER INDICATES OPTIONAL DESIGN PRESSURE (DP) RATING.  
 ++ TEMPERED GLASS, TINTED GLASS, OBSCURE GLASS AND/OR SDL OPTIONS REQUIRE A HEAVY DUTY JAMB LINER.  
 E BASIC UNIT CLEAR OPENING EXCEEDS 20" IN WIDTH, 24" IN HEIGHT & A MINIMUM OF 5.7 SQ. FT.

Note Elevations shown DO NOT have exterior trim. Subtract 3/4" (19) from M.O. (Masonry Opening) for Unit Sizes. Masonry Openings above include Sill Nose, see Trim Options page for Sill Nose specifications. For other Trim Options refer to the Unit Sizing, Rough Opening & Masonry Openings page.

SCALE: 1/4" = 1'

### 1-WIDE UNITS

<b>M.O. BRICKMOULD</b>	25 1/8"(638)	29 1/8"(740)	33 1/8"(841)	37 1/8"(943)	41 1/8"(1045)	45 1/8"(1146)	49 1/8"(1248)
<b>M.O. ADAMS/FLAT CASING</b>	28 1/8"(714)	32 1/8"(816)	36 1/8"(918)	40 1/8"(1019)	44 1/8"(1121)	48 1/8"(1222)	52 1/8"(1324)
<b>ROUGH OPENING</b>	22 1/8"(562)	26 1/8"(664)	30 1/8"(765)	34 1/8"(867)	38 1/8"(968)	42 1/8"(1070)	46 1/8"(1172)
<b>FRAME SIZE</b>	21 3/8"(543)	25 3/8"(645)	29 3/8"(746)	33 3/8"(848)	37 3/8"(949)	41 3/8"(1051)	45 3/8"(1153)
<b>DAYLIGHT OPENING</b>	14 15/16"(379)	18 15/16"(481)	22 15/16"(583)	26 15/16"(684)	30 15/16"(786)	34 15/16"(887)	38 15/16"(989)

83 3/8"(2118)  
84 7/8"(2155)  
80 3/4"(2051)  
80"(2032)  
35 1/4"(895)[2]

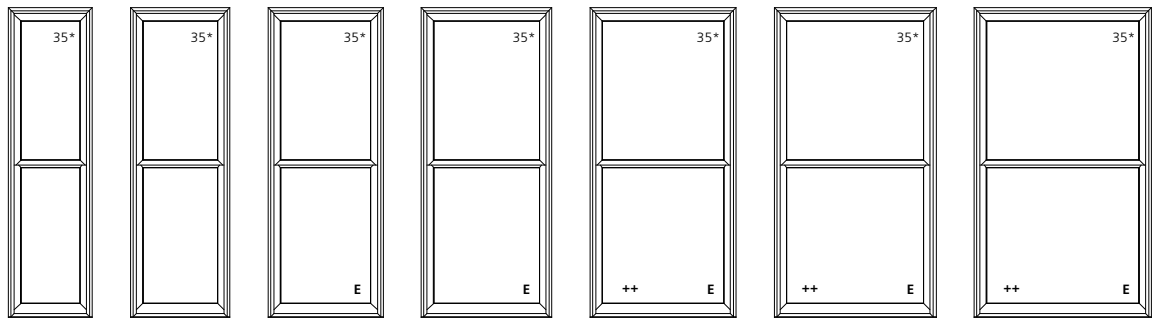

TCD2180      TCD2580      TCD2980      TCD3380      TCD3780      TCD4180      TCD4580

91 3/8"(2321)  
92 7/8"(2359)  
88 3/4"(2254)  
88"(2235)  
39 1/4"(997)[2]

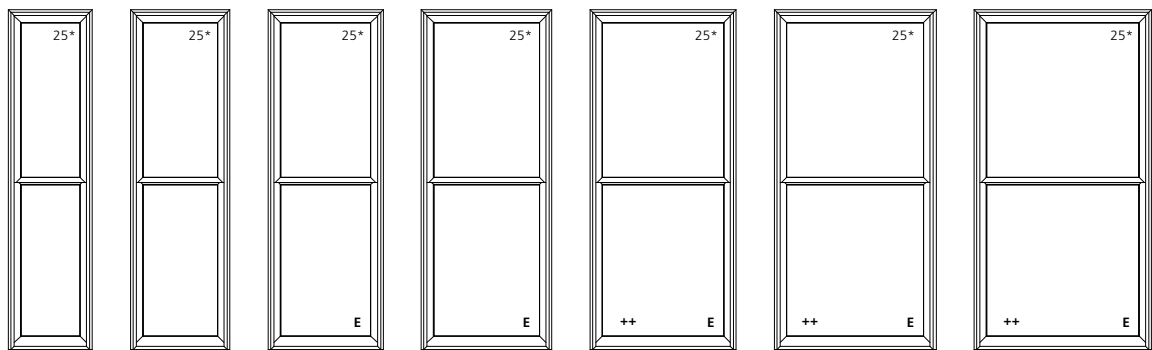

TCD2188      TCD2588      TCD2988      TCD3388      TCD3788      TCD4188      TCD4588

95 3/8"(2423)  
96 7/8"(2461)  
92 3/4"(2356)  
92"(2337)  
41 1/4"(1048)[2]

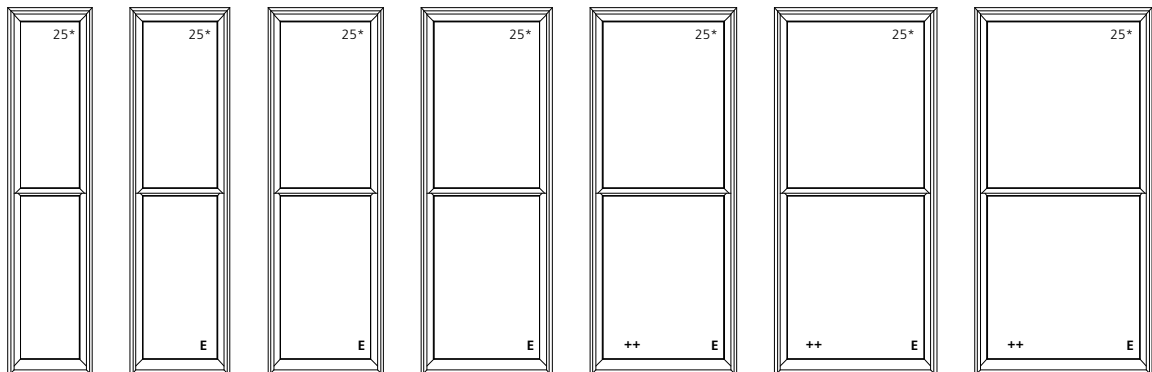

TCD2192      TCD2592      TCD2992      TCD3392      TCD3792      TCD4192      TCD4592

**ELEVATION SYMBOL LEGEND:**

- M.O. = MASONRY OPENING
- VALUES IN ( ) ARE IN MILLIMETER CONVERSIONS
- VALUES IN [ ] ARE NUMBER OF DAYLIGHT OPENINGS PER UNIT
- ### NUMBER INDICATES DESIGN PRESSURE (DP) RATING WITH STANDARD GLAZING.
- ++ TEMPERED GLASS, TINTED GLASS, OBSCURE GLASS AND/OR SDL OPTIONS REQUIRE A HEAVY DUTY JAMB LINER.
- E BASIC UNIT CLEAR OPENING EXCEEDS 20" IN WIDTH, 24" IN HEIGHT & A MINIMUM OF 5.7 SQ. FT.

Note Elevations shown DO NOT have exterior trim. Subtract 3/4" (19) from M.O. (Masonry Opening) for Unit Sizes. Masonry Openings above include Sill Nose, see Trim Options page for Sill Nose specifications. For other Trim Options refer to the Unit Sizing, Rough Opening & Masonry Openings page.

SCALE: 1/4" = 1'

### 2-WIDE UNITS

M.O. BRICKMOULD M.O. ADAMS/FLAT CASING ROUGH OPENING FRAME SIZE DAYLIGHT OPENING	46 1/2" (1181) 49 1/2" (1257) 43 1/2" (1105) 42 3/4" (1086)	54 1/2" (1384) 57 1/2" (1448) 51 1/2" (1308) 50 3/4" (1289)	62 1/2" (1588) 65 1/2" (1664) 59 1/2" (1511) 58 3/4" (1492)	70 1/2" (1791) 73 1/2" (1867) 67 1/2" (1715) 66 3/4" (1695)	78 1/2" (1994) 81 1/2" (2070) 75 1/2" (1918) 74 3/4" (1899)	86 1/2" (2197) 89 1/2" (2273) 83 1/2" (2121) 82 3/4" (2102)	94 1/2" (2400) 97 1/2" (2477) 91 1/2" (2324) 90 3/4" (2305)
39 3/8" (1000) 40 7/8" (1036) 36 5/8" (933) 13 1/4" (337) [2]							
43 3/8" (1102) 44 7/8" (1140) 40 3/4" (1035) 15 1/4" (387) [2]							
51 3/8" (1305) 52 7/8" (1343) 48 3/4" (1238) 19 1/4" (489) [2]							
55 3/8" (1407) 56 7/8" (1445) 52 3/4" (1340) 21 1/4" (540) [2]							
59 3/8" (1508) 60 7/8" (1546) 56 3/4" (1441) 23 1/4" (591) [2]							
63 3/8" (1609) 64 7/8" (1648) 60 3/4" (1543) 25 1/4" (641) [2]							
67 3/8" (1711) 68 7/8" (1749) 64 3/4" (1645) 27 1/4" (692) [2]							
71 3/8" (1813) 72 7/8" (1851) 68 3/4" (1746) 45 1/4" (1149) 13 1/4" (337)							
71 3/8" (1813) 72 7/8" (1851) 68 3/4" (1746) 29 1/4" (737) [2]							
75 3/8" (1915) 76 7/8" (1953) 72 3/4" (1849) 31 1/4" (790) [2]							

**ELEVATION SYMBOL LEGEND:**

M.O. = MASONRY OPENING  
 VALUES IN ( ) ARE IN MILLIMETER CONVERSIONS  
 VALUES IN [ ] ARE NUMBER OF DAYLIGHT OPENINGS PER UNIT  
 E BASIC UNIT CLEAR OPENING EXCEEDS 20" IN WIDTH, 24" IN HEIGHT & A MINIMUM OF 5.7 SQ. FT.

Note Elevations shown DO NOT have exterior trim. Subtract 3/4" (19) from M.O. (Masonry Opening) for Unit Sizes. Masonry Openings above include Sill Nose, see Trim Options page for Sill Nose specifications. For other Trim Options refer to the Unit Sizing, Rough Opening & Masonry Openings page.

SCALE: 1/8" = 1'



### 2-WIDE UNITS

M.O. BRICKMOULD  
M.O. ADAMS/FLAT CASING  
ROUGH OPENING  
FRAME SIZE  
DAYLIGHT OPENING

46 1/2" (1181)  
49 1/2" (1257)  
43 1/2" (1105)  
42 3/4" (1086)  
14 15/16" (379) [2]

54 1/2" (1384)  
57 1/2" (1448)  
51 1/2" (1308)  
50 3/4" (1289)  
18 15/16" (481) [2]

62 1/2" (1588)  
65 1/2" (1664)  
59 1/2" (1511)  
58 3/4" (1492)  
22 15/16" (583) [2]

70 1/2" (1791)  
73 1/2" (1867)  
67 1/2" (1715)  
66 3/4" (1695)  
26 15/16" (684) [2]

78 1/2" (1994)  
81 1/2" (2070)  
75 1/2" (1918)  
74 3/4" (1899)  
30 15/16" (786) [2]

86 1/2" (2197)  
89 1/2" (2273)  
83 1/2" (2121)  
82 3/4" (2102)  
34 15/16" (887) [2]

94 1/2" (2400)  
97 1/2" (2477)  
91 1/2" (2324)  
90 3/4" (2305)  
38 15/16" (989) [2]

79 3/8" (2016)  
80 7/8" (2054)  
76 3/4" (1949)  
76" (1930)  
33 1/4" (845) [2]

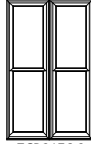

TCD2176-2

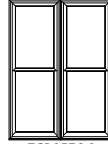

TCD2576-2

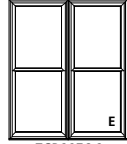

TCD2976-2

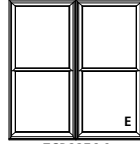

TCD3376-2

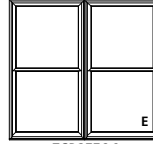

TCD3776-2

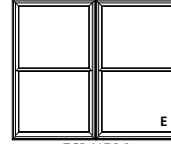

TCD4176-2

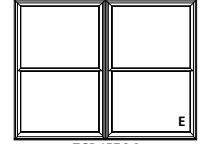

TCD4576-2

83 3/8" (2118)  
84 7/8" (2155)  
80 3/4" (2051)  
80" (2032)  
35 1/4" (895) [2]

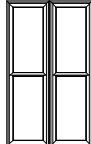

TCD2180-2



TCD2580-2

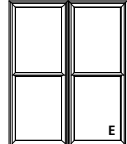

TCD2980-2

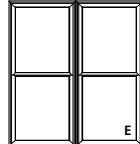

TCD3380-2

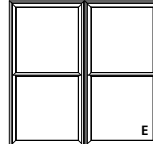

TCD3780-2



TCD4180-2

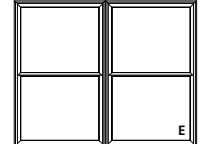

TCD4580-2

91 3/8" (2321)  
92 7/8" (2359)  
88 3/4" (2254)  
88" (2235)  
39 1/4" (997) [2]

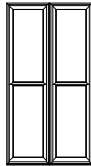

TCD2188-2



TCD2588-2

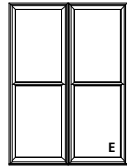

TCD2988-2

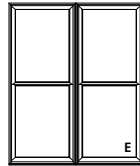

TCD3388-2

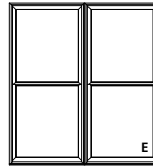

TCD3788-2

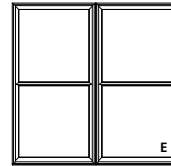

TCD4188-2

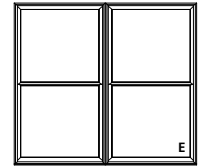

TCD4588-2

95 3/8" (2423)  
96 7/8" (2461)  
92 3/4" (2356)  
92" (2337)  
41 1/4" (1048) [2]



TCD2192-2

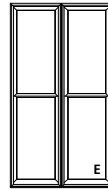

TCD2592-2

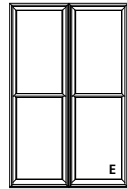

TCD2992-2

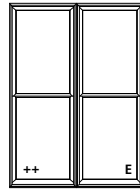

TCD3392-2

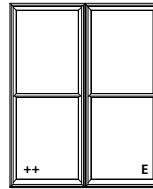

TCD3792-2

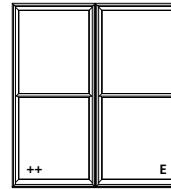

TCD4192-2

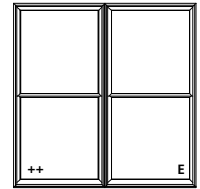

TCD4592-2

**ELEVATION SYMBOL LEGEND:**

M.O. = MASONRY OPENING  
VALUES IN ( ) ARE IN MILLIMETER CONVERSIONS  
VALUES IN [ ] ARE NUMBER OF DAYLIGHT OPENINGS PER UNIT

++ TEMPERED GLASS, TINTED GLASS, OBSCURE GLASS AND/OR SDL OPTIONS REQUIRE A HEAVY DUTY JAMB LINER.

E BASIC UNIT CLEAR OPENING EXCEEDS 20" IN WIDTH, 24" IN HEIGHT & A MINIMUM OF 5.7 SQ. FT.

Note Elevations shown DO NOT have exterior trim. Subtract 3/4" (19) from M.O. (Masonry Opening) for Unit Sizes. Masonry Openings above include Sill Nose, see Trim Options page for Sill Nose specifications. For other Trim Options refer to the Unit Sizing, Rough Opening & Masonry Openings page.

SCALE: 1/8" = 1'

### 3-WIDE UNITS

**M.O. BRICKMOLD**  
**M.O. ADAMS/FLAT CASING**  
**ROUGH OPENING**  
**FRAME SIZE**  
**DAYLIGHT OPENING**

67 7/8" (1724)  
70 7/8" (1800)  
64 7/8" (1648)  
64 1/8" (1629)  
14 15/16" (379)[3]

79 7/8" (2029)  
82 7/8" (2105)  
76 7/8" (1953)  
76 1/8" (1934)  
18 15/16" (481)[3]

91 7/8" (2334)  
94 7/8" (2410)  
88 7/8" (2257)  
88 1/8" (2238)  
22 15/16" (583)[3]

103 7/8" (2638)  
106 7/8" (2715)  
100 7/8" (2562)  
100 1/8" (2543)  
26 15/16" (684)[3]

115 7/8" (2943)  
118 7/8" (3019)  
112 7/8" (2867)  
112 1/8" (2848)  
30 15/16" (786)[3]

39 3/8" (1000)  
40 7/8" (1038)  
36 3/4" (933)  
36" (914)  
13 1/4" (337)[2]

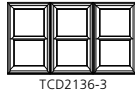

TCD2136-3

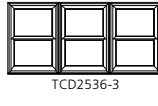

TCD2536-3

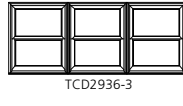

TCD2936-3

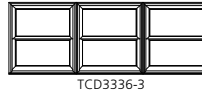

TCD3336-3

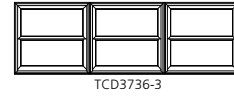

TCD3736-3

43 3/8" (1102)  
44 7/8" (1140)  
40 3/4" (1035)  
40" (1016)  
15 1/4" (387)[2]

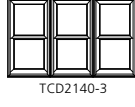

TCD2140-3



TCD2540-3



TCD2940-3



TCD3340-3



TCD3740-3

51 3/8" (1305)  
52 7/8" (1343)  
48 3/4" (1238)  
48" (1219)  
19 1/4" (489)[2]



TCD2148-3



TCD2548-3



TCD2948-3



TCD3348-3



TCD3748-3

55 3/8" (1407)  
56 7/8" (1445)  
52 3/4" (1340)  
52" (1321)  
21 1/4" (540)[2]



TCD2152-3



TCD2552-3



TCD2952-3



TCD3352-3



TCD3752-3

59 3/8" (1508)  
60 7/8" (1546)  
56 3/4" (1441)  
56" (1422)  
23 1/4" (591)[2]



TCD2156-3



TCD2556-3



TCD2956-3



TCD3356-3



TCD3756-3

E

63 3/8" (1609)  
64 7/8" (1648)  
60 3/4" (1543)  
60" (1524)  
25 1/4" (641)[2]



TCD2160-3



TCD2560-3



TCD2960-3



TCD3360-3



TCD3760-3

E

67 3/8" (1711)  
68 7/8" (1749)  
64 3/4" (1645)  
64" (1626)  
27 1/4" (692)[2]



TCD2164-3



TCD2564-3



TCD2964-3



TCD3364-3



TCD3764-3

E

E

71 3/8" (1813)  
72 7/8" (1851)  
68 3/4" (1746)  
68" (1727)  
45 1/4" (1149) 13 1/4" (337)



TCD2168C36-3



TCD2568C36-3



TCD2968C36-3



TCD3368C36-3



TCD3768C36-3

++ E

71 3/8" (1813)  
72 7/8" (1851)  
68 3/4" (1746)  
68" (1727)  
29 1/4" (337)[2]



TCD2168-3



TCD2568-3



TCD2968-3



TCD3368-3



TCD3768-3

E

E

75 3/8" (1915)  
76 7/8" (1953)  
72 3/4" (1829)  
72" (1829)  
31 1/4" (794)[2]



TCD2172-3



TCD2572-3



TCD2972-3



TCD3372-3



TCD3772-3

E

E

E

**ELEVATION SYMBOL LEGEND:**

**M.O.** = MASONRY OPENING

VALUES IN ( ) ARE IN MILLIMETER CONVERSIONS

VALUES IN [ ] ARE NUMBER OF DAYLIGHT OPENINGS PER UNIT

++ TEMPERED GLASS, TINTED GLASS, OBSCURE GLASS AND/OR SDL OPTIONS REQUIRE A HEAVY DUTY JAMB LINER.

E BASIC UNIT CLEAR OPENING EXCEEDS 20" IN WIDTH, 24" IN HEIGHT & A MINIMUM OF 5.7 SQ. FT.

Note Elevations shown DO NOT have exterior trim. Subtract 3/4" (19) from M.O. (Masonry Opening) for Unit Sizes. Masonry Openings above include Sill Nose, see Trim Options page for Sill Nose specifications. For other Trim Options refer to the Unit Sizing, Rough Opening & Masonry Openings page.

SCALE: 1/8" = 1'

**3-WIDE UNITS**

**M.O. BRICKMOULD**  
**M.O. ADAMS/FLAT CASING**  
**ROUGH OPENING**  
**FRAME SIZE**  
**DAYLIGHT OPENING**

67 7/8" (1724)	79 7/8" (2029)	91 7/8" (2334)	103 7/8" (2638)	115 7/8" (2943)
70 7/8" (1800)	82 7/8" (2105)	94 7/8" (2410)	106 7/8" (2715)	118 7/8" (3019)
64 7/8" (1648)	76 7/8" (1953)	88 7/8" (2257)	100 7/8" (2562)	112 7/8" (2867)
64 1/8" (1629)	76 1/8" (1934)	88 1/8" (2238)	100 1/8" (2543)	112 1/8" (2848)
14 15/16" (379)[3]	18 15/16" (481)[3]	22 15/16" (583)[3]	26 15/16" (684)[3]	30 15/16" (786)[3]

79 3/8" (2016) 80 7/8" (2054) 76 3/4" (1949) 76" (1930) 33 1/4" (845)[2]					
	TCD2176-3	TCD2576-3	TCD2976-3	TCD3376-3	TCD3776-3
83 3/8" (2118) 84 7/8" (2155) 80 3/4" (2051) 80" (2032) 35 1/4" (895)[2]					
	TCD2180-3	TCD2580-3	TCD2980-3	TCD3380-3	TCD3780-3
91 3/8" (2321) 92 7/8" (2359) 88 3/4" (2254) 88" (2235) 39 1/4" (997)[2]					
	TCD2188-3	TCD2588-3	TCD2988-3	TCD3388-3	TCD3788-3

**ELEVATION SYMBOL LEGEND:**  
**M.O.** = MASONRY OPENING  
 VALUES IN ( ) ARE IN MILLIMETER CONVERSIONS  
 VALUES IN [ ] ARE NUMBER OF DAYLIGHT OPENINGS PER UNIT  
 ++ TEMPERED GLASS, TINTED GLASS, OBSCURE GLASS AND/OR SDL OPTIONS REQUIRE A HEAVY DUTY JAMB LINER.  
 E BASIC UNIT CLEAR OPENING EXCEEDS 20" IN WIDTH, 24" IN HEIGHT & A MINIMUM OF 5.7 SQ. FT.

Note Elevations shown DO NOT have exterior trim. Subtract 3/4" (19) from M.O. (Masonry Opening) for Unit Sizes. Masonry Openings above include Sill Nose, see Trim Options page for Sill Nose specifications. For other Trim Options refer to the Unit Sizing, Rough Opening & Masonry Openings page.

SCALE: 1/8" = 1'

**3-WIDE UNITS**

M.O. BRICKMOULD  
M.O. ADAMS/FLAT CASING  
ROUGH OPENING  
FRAME SIZE  
DAYLIGHT OPENING

127 7/8" (3248)  
130 7/8" (3324)  
124 7/8" (3172)  
124 1/8" (3153)  
34 15/16" (887)[3]

139 7/8" (3553)  
142 7/8" (3629)  
136 7/8" (3477)  
136 1/8" (3458)  
38 15/16" (989)[3]

39 3/8" (1000)  
40 7/8" (1038)  
36 3/4" (933)  
36" (914)  
13 1/4" (337)[2]

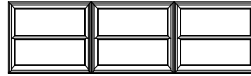

TCD4136-3

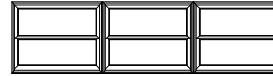

TCD4536-3

43 3/8" (1102)  
44 7/8" (1140)  
40 3/4" (1035)  
40" (1016)  
15 1/4" (387)[2]

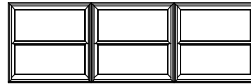

TCD4140-3

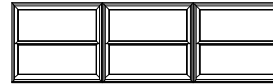

TCD4540-3

51 3/8" (1305)  
52 7/8" (1343)  
48 3/4" (1238)  
48" (1219)  
19 1/4" (489)[2]

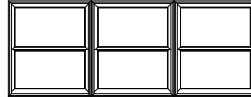

TCD4148-3



TCD4548-3

55 3/8" (1407)  
56 7/8" (1445)  
52 3/4" (1340)  
52" (1321)  
21 1/4" (540)[2]

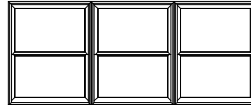

TCD4152-3

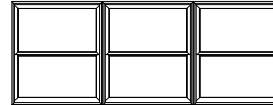

TCD4552-3

59 3/8" (1508)  
60 7/8" (1546)  
56 3/4" (1441)  
56" (1422)  
23 1/4" (591)[2]

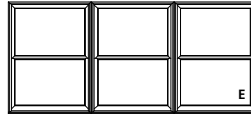

TCD4156-3

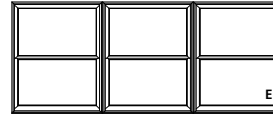

TCD4556-3

63 3/8" (1609)  
64 7/8" (1648)  
60 3/4" (1543)  
60" (1524)  
25 1/4" (641)[2]

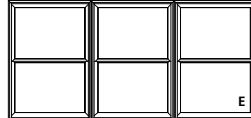

TCD4160-3

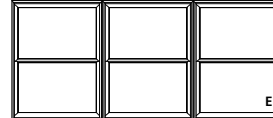

TCD4560-3

67 3/8" (1711)  
68 7/8" (1749)  
64 3/4" (1645)  
64" (1626)  
27 1/4" (692)[2]

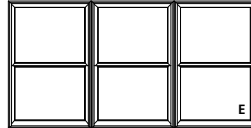

TCD4164-3

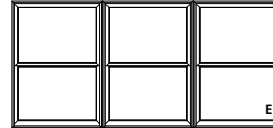

TCD4564-3

71 3/8" (1813)  
72 7/8" (1851)  
68 3/4" (1746)  
68" (1727)  
45 1/4" (1149) 13 1/4" (337)

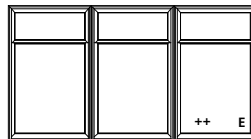

TCD4168C36-3

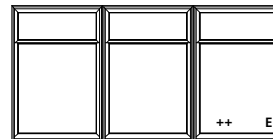

TCD4568C36-3

71 3/8" (1813)  
72 7/8" (1851)  
68 3/4" (1746)  
68" (1727)  
29 1/4" (337)[2]

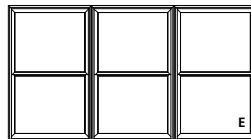

TCD4168-3

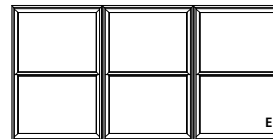

TCD4568-3

75 3/8" (1915)  
76 7/8" (1953)  
72 3/4" (1829)  
72" (1829)  
31 1/4" (794)[2]

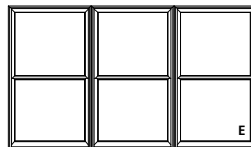

TCD4172-3

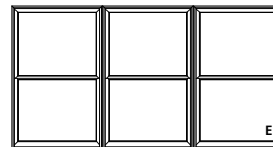

TCD4572-3

**ELEVATION SYMBOL LEGEND:**

M.O. = MASONRY OPENING

VALUES IN ( ) ARE IN MILLIMETER CONVERSIONS

VALUES IN [ ] ARE NUMBER OF DAYLIGHT OPENINGS PER UNIT

++ TEMPERED GLASS, TINTED GLASS, OBSCURE GLASS AND/OR SDL OPTIONS REQUIRE A HEAVY DUTY JAMB LINER.

E BASIC UNIT CLEAR OPENING EXCEEDS 20" IN WIDTH, 24" IN HEIGHT & A MINIMUM OF 5.7 SQ. FT.

Note Elevations shown DO NOT have exterior trim. Subtract 3/4" (19) from M.O. (Masonry Opening) for Unit Sizes. Masonry Openings above include Sill Nose, see Trim Options page for Sill Nose specifications. For other Trim Options refer to the Unit Sizing, Rough Opening & Masonry Openings page.

SCALE: 1/8" = 1'

**3-WIDE UNITS**

<b>M.O. BRICKMOULD</b>	127 7/8"(3248)	139 7/8"(3553)
<b>M.O. ADAMS/FLAT CASING</b>	130 7/8"(3324)	142 7/8"(3629)
<b>ROUGH OPENING</b>	124 7/8"(3172)	136 7/8"(3477)
<b>FRAME SIZE</b>	124 1/8"(3153)	136 1/8"(3458)
<b>DAYLIGHT OPENING</b>	34 15/16"(887)[3]	38 15/16"(989)[3]

79 3/8"(2016)  
80 7/8"(2054)  
76 3/4"(1949)  
76"(1930)  
33 1/4"(845)[2]

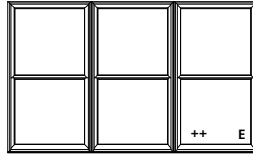

TCD4176-3

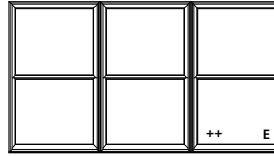

TCD4576-3

83 3/8"(2118)  
84 7/8"(2155)  
80 3/4"(2051)  
80"(2032)  
35 1/4"(895)[2]

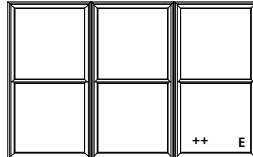

TCD4180-3

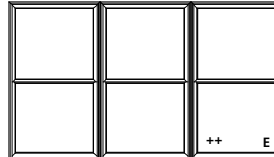

TCD4580-3

91 3/8"(2321)  
92 7/8"(2359)  
88 3/4"(2254)  
88"(2235)  
39 1/4"(997)[2]

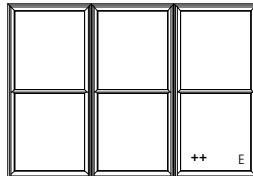

TCD4188-3

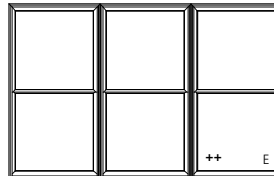

TCD4588-3

**ELEVATION SYMBOL LEGEND:**

**M.O.** = MASONRY OPENING

VALUES IN ( ) ARE IN MILLIMETER CONVERSIONS

VALUES IN [ ] ARE NUMBER OF DAYLIGHT OPENINGS PER UNIT

**++** TEMPERED GLASS, TINTED GLASS, OBSCURE GLASS AND/OR SDLOPTIONS REQUIRE A HEAVY DUTY JAMB LINER.

**E** BASIC UNIT CLEAR OPENING EXCEEDS 20" IN WIDTH, 24" IN HEIGHT & A MINIMUM OF 5.7 SQ. FT.

Note Elevations shown DO NOT have exterior trim. Subtract 3/4" (19) from M.O. (Masonry Opening) for Unit Sizes. Masonry Openings above include Sill Nose, see Trim Options page for Sill Nose specifications. For other Trim Options refer to the Unit Sizing, Rough Opening & Masonry Openings page.

SCALE: 1/8" = 1'

**ELEVATION NOTES**  
**DOUBLE-HUNG PICTURE**

ELEVATION DRAWINGS UTILIZE A LIMITED NUMBER OF PROJECTED LINES TO PRODUCE A RUDIMENTARY DRAWING INTENDED TO BE USED IN A SMALL GRAPHICAL SCALE. ELEVATIONS ARE VIEWED PERPENDICULAR FROM THE EXTERIOR OF THE STRUCTURE. IF MORE DIMENSIONS ARE NEEDED, USE THE SECTION DRAWINGS FOR MORE COMPLETE DEPICTIONS.

M.O. Brickmould	21 1/8" (537)	Masonry Openings for Brickmould, Flat & Adams Casing. Vertical measurements include sillnose. (Subtract 1/2" from Masonry Opening for Unit Size)
M.O. Adams/Flat Casing	24 1/4" (613)	
Rough Opening	18 1/8" (460)	
Frame Size	17 3/8" (441)	
Daylight Opening	10 15/16" (276)	

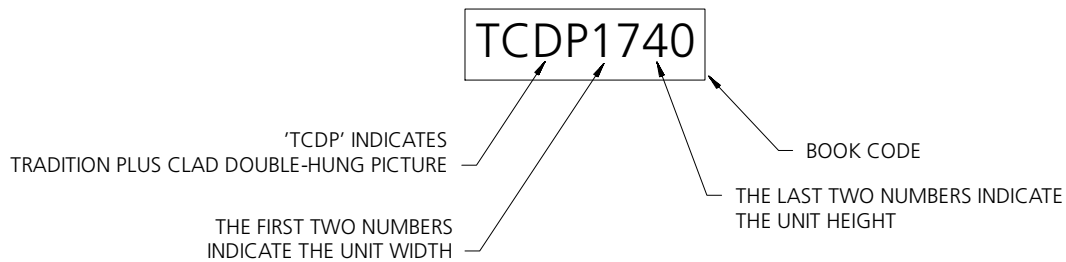
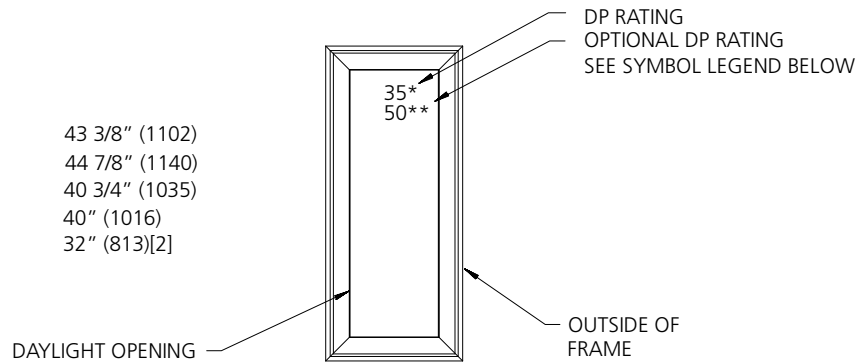











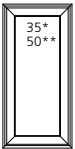
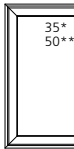
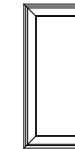
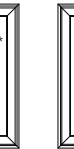
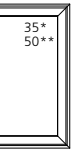

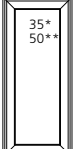
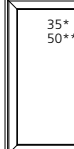
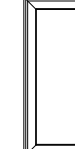
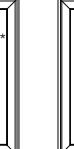
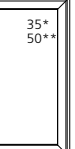
**GENERAL DOUBLE-HUNG PICTURE NOTES**

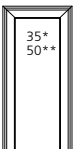
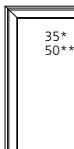
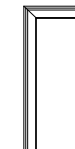
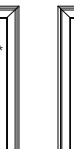
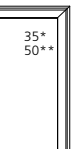
1. ALL UNITS SHOWN ARE AVAILABLE AS STATIONARY ONLY.
2. UNIT ELEVATIONS ARE SHOWN WITH BRICKMOULD AND SUBSILL.
3. DIMENSIONAL VALUES IN PARENTHESES ARE MILLIMETER CONVERSIONS.
4. VALUES IN BRACKETS ARE NUMBER OF DAYLIGHT OPENINGS.

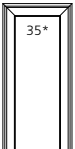
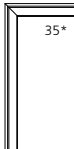
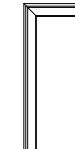
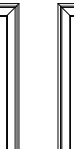
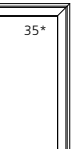
**ELEVATION SYMBOL LEGEND:**

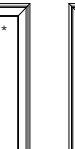
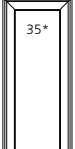
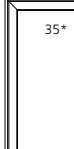
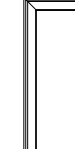
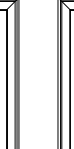
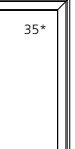
- M.O.** MASONRY OPENING  
**##\*** NUMBER INDICATES STANDARD DESIGN PRESSURE (DP) RATING.  
**##\*\*** NUMBER INDICATES OPTIONAL DESIGN PRESSURE (DP) RATING.

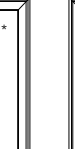
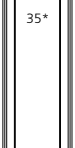
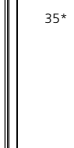
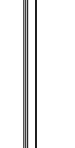
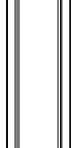
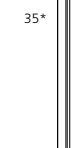
### PICTURE UNITS

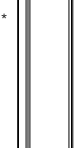
M.O. BRICKMOULD	21 1/8" (537)	25 1/8" (638)	29 1/8" (740)	33 1/8" (841)	37 1/8" (943)	41 1/8" (1045)	45 1/8" (1146)
M.O. ADAMS/FLAT CASING	24 1/8" (613)	28 1/8" (714)	32 1/8" (816)	36 1/8" (918)	40 1/8" (1019)	44 1/8" (1121)	48 1/8" (1222)
ROUGH OPENING	18 3/8" (460)	22 1/8" (562)	26 1/8" (664)	30 1/8" (765)	34 1/8" (867)	38 1/8" (968)	42 1/8" (1070)
FRAME SIZE	17 3/8" (441)	21 3/8" (543)	25 3/8" (645)	29 3/8" (746)	33 3/8" (848)	37 3/8" (949)	41 3/8" (1051)
DAYLIGHT OPENING	10 15/16" (276)	14 15/16" (379)	18 15/16" (481)	22 15/16" (583)	26 15/16" (684)	30 15/16" (786)	34 15/16" (887)
30 3/8" (1000) 43 7/8" (1089) 36 3/4" (933) 36" (914) 28" (711)	 35* 50**	 35* 50**	 35* 50**	 35* 50**	 35* 50**	 35* 50**	 35* 50**
	TCDP1736	TCDP2136	TCDP2536	TCDP2936	TCDP3336	TCDP3736	TCDP4136
43 3/8" (1102) 44 7/8" (1140) 40 3/4" (1035) 40" (1016) 32" (813)	 35* 50**	 35* 50**	 35* 50**	 35* 50**	 35* 50**	 35* 50**	 35* 50**
	TCDP1740	TCDP2140	TCDP2540	TCDP2940	TCDP3340	TCDP3740	TCDP4140
51 3/8" (1305) 52 7/8" (1343) 48 3/4" (1238) 48" (1219) 40" (1016)	 35* 50**	 35* 50**	 35* 50**	 35* 50**	 35* 50**	 35* 50**	 35* 50**
	TCDP1748	TCDP2148	TCDP2548	TCDP2948	TCDP3348	TCDP3748	TCDP4148
55 3/8" (1407) 56 7/8" (1445) 52 3/4" (1340) 52" (1321) 44" (1118)	 35*	 35*	 35*	 35*	 35*	 35*	 35*
	TCDP1752	TCDP2152	TCDP2552	TCDP2952	TCDP3352	TCDP3752	TCDP4152
59 3/8" (1508) 60 7/8" (1546) 56 3/4" (1441) 56" (1422) 48" (1219)	 35*	 35*	 35*	 35*	 35*	 35*	 35*
	TCDP1756	TCDP2156	TCDP2556	TCDP2956	TCDP3356	TCDP3756	TCDP4156
63 3/8" (1609) 64 7/8" (1648) 60 3/4" (1543) 60" (1524) 52" (1321)	 35*	 35*	 35*	 35*	 35*	 35*	 35*
	TCDP1760	TCDP2160	TCDP2560	TCDP2960	TCDP3360	TCDP3760	TCDP4160

#### ELEVATION SYMBOL LEGEND

M.O. = MASONRY OPENING

VALUES IN ( ) ARE IN MILLIMETER CONVERSIONS

##\* NUMBER INDICATES DESIGN PRESSURE (DP) RATING WITH STANDARD GLAZING.

###\* NUMBER INDICATES OPTIONAL DESIGN PRESSURE (DP) RATING.

Note Elevations shown DO NOT have exterior trim. Subtract 3/4" (19) from M.O. (Masonry Opening) for Unit Sizes. Masonry Openings above include Sill Nose, see Trim Options page for Sill Nose specifications. For other Trim Options refer to the Unit Sizing, Rough Opening & Masonry Openings page.

SCALE: 1/4" = 1'

### PICTURE UNITS

M.O. BRICKMOUND  
M.O. ADAMS/FLAT CASING  
ROUGH OPENING  
FRAME SIZE  
DAYLIGHT OPENING

21 1/8" (537)	25 1/8" (638)	29 1/8" (740)	33 1/8" (841)	37 1/8" (943)	41 1/8" (1045)	45 1/8" (1146)
24 1/8" (613)	28 1/8" (714)	32 1/8" (816)	36 1/8" (918)	40 1/8" (1019)	44 1/8" (1121)	48 1/8" (1222)
18 1/8" (460)	22 1/8" (562)	26 1/8" (664)	30 1/8" (765)	34 1/8" (867)	38 1/8" (968)	42 1/8" (1070)
17 3/8" (441)	21 3/8" (543)	25 3/8" (645)	29 3/8" (746)	33 3/8" (848)	37 3/8" (949)	41 3/8" (1051)
10 15/16" (276)	14 15/16" (379)	18 15/16" (481)	22 15/16" (583)	26 15/16" (684)	30 15/16" (786)	34 15/16" (887)

67 3/8" (1711) 68 7/8" (1749) 64 3/4" (1645) 64" (1626) 56" (1422)	35*	35*	35*	35*	35*	35*
71 3/8" (1813) 72 7/8" (1851) 68 3/4" (1746) 68" (1727) 60" (1524)	35*	35*	35*	35*	35*	35*
75 3/8" (1915) 76 7/8" (1953) 72 3/4" (1848) 72" (1829) 66" (1676)	35*	35*	35*	35*	35*	35*
79 3/8" (2016) 80 7/8" (2054) 76 3/4" (1949) 76" (1930) 68" (1727)	35*	35*	35*	35*	35*	35*
83 3/8" (2118) 84 7/8" (2155) 80 3/4" (2051) 80" (2032) 72" (1829)	35*	35*	35*	35*	35*	35*
TCDP1764	TCDP2164	TCDP2564	TCDP2964	TCDP3364	TCDP3764	TCDP4164
TCDP1768	TCDP2168	TCDP2568	TCDP2968	TCDP3368	TCDP3768	TCDP4168
TCDP1772	TCDP2172	TCDP2572	TCDP2972	TCDP3372	TCDP3772	TCDP4172
TCDP1776	TCDP2176	TCDP2576	TCDP2976	TCDP3376	TCDP3776	TCDP4176
TCDP1780	TCDP2180	TCDP2580	TCDP2980	TCDP3380	TCDP3780	TCDP4180

**ELEVATION SYMBOL LEGEND**

M.O. = MASONRY OPENING  
VALUES IN ( ) ARE IN MILLIMETER CONVERSIONS  
### NUMBER INDICATES DESIGN PRESSURE (DP) RATING WITH STANDARD GLAZING.

Note Elevations shown DO NOT have exterior trim. Subtract 3/4" (19) from M.O. (Masonry Opening) for Unit Sizes. Masonry Openings above include Sill Nose, see Trim Options page for Sill Nose specifications. For other Trim Options refer to the Unit Sizing, Rough Opening & Masonry Openings page.

SCALE: 1/4" = 1'



### PICTURE UNITS

M.O. BRICKMOUND  
M.O. ADAMS/FLAT CASING  
ROUGH OPENING  
FRAME SIZE  
DAYLIGHT OPENING

21 1/8" (537)	25 1/8" (638)	29 1/8" (740)	33 1/8" (841)	37 1/8" (943)	41 1/8" (1045)	45 1/8" (1146)
24 1/8" (613)	28 1/8" (714)	32 1/8" (816)	36 1/8" (918)	40 1/8" (1019)	44 1/8" (1121)	48 1/8" (1222)
18 1/8" (460)	22 1/8" (562)	26 1/8" (664)	30 1/8" (765)	34 1/8" (867)	38 1/8" (968)	42 1/8" (1070)
17 3/8" (441)	21 3/8" (543)	25 3/8" (645)	29 3/8" (746)	33 3/8" (848)	37 3/8" (949)	41 3/8" (1051)
10 15/16" (276)	14 15/16" (379)	18 15/16" (481)	22 15/16" (583)	26 15/16" (684)	30 15/16" (786)	34 15/16" (887)

61 3/8" (2321)  
62 7/8" (2360)  
68 3/4" (2354)  
88" (2315)  
80" (2032)

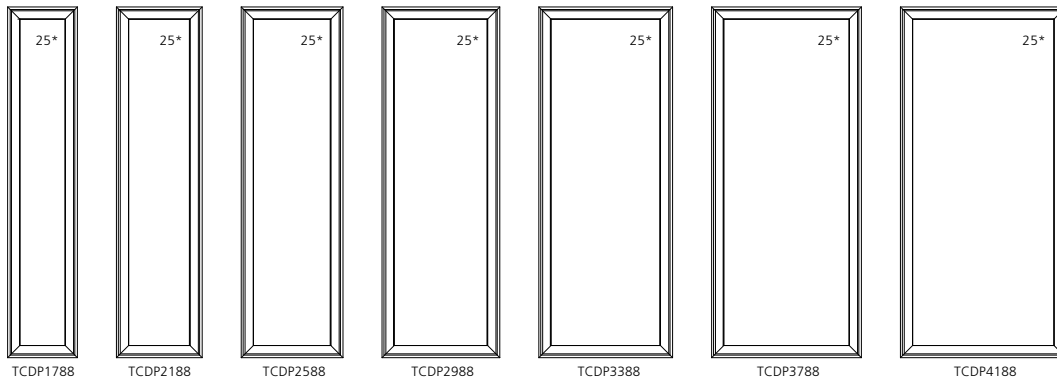

**ELEVATION SYMBOL LEGEND**

M.O. = MASONRY OPENING  
VALUES IN () ARE IN MILLIMETER CONVERSIONS  
### NUMBER INDICATES DESIGN PRESSURE (DP) RATING WITH STANDARD GLAZING.

Note Elevations shown DO NOT have exterior trim. Subtract 3/4" (19) from M.O. (Masonry Opening) for Unit Sizes. Masonry Openings above include Sill Nose, see Trim Options page for Sill Nose specifications. For other Trim Options refer to the Unit Sizing, Rough Opening & Masonry Openings page.

SCALE: 1/4" = 1'

### PICTURE UNITS

	M.O. BRICKMOULD M.O. ADAMS/FLAT CASING ROUGH OPENING FRAME SIZE DAYLIGHT OPENING	49 1/8"(1248) 52 1/8"(1324) 46 1/8"(1172) 45 3/8"(1153) 38 15/16"(989)	53 1/8"(1349) 56 1/8"(1426) 50 1/8"(1273) 49 3/8"(1254) 42 15/16"(1091)	57 1/8"(1451) 60 1/8"(1527) 54 1/8"(1375) 53 3/8"(1355) 46 15/16"(1192)	65 1/8"(1654) 68 1/8"(1730) 62 1/8"(1578) 61 3/8"(1559) 54 15/16"(1395)
39 3/8"(1000) 42 7/8"(1089) 36 3/4"(953) 36"(914) 28"(711)	35* 50**	35*	35*	35*	35*
TCDP4536	TCDP4936	TCDP5336	TCDP6136		
43 3/8"(1102) 44 7/8"(1140) 40 3/4"(1035) 40"(1016) 32"(813)	35* 50**	35*	35*	35*	35*
TCDP4540	TCDP4940	TCDP5340	TCDP6140		
51 3/8"(1305) 52 7/8"(1343) 48 3/4"(1238) 48"(1219) 40"(1016)	35* 50**	35*	35*	35*	35*
TCDP4548	TCDP4948	TCDP5348	TCDP6148		
55 3/8"(1407) 56 7/8"(1445) 52 3/4"(1340) 52"(1321) 44"(1118)	35*	35*	35*	35*	35*
TCDP4552	TCDP4952	TCDP5352	TCDP6152		
59 3/8"(1508) 60 7/8"(1546) 56 3/4"(1441) 56"(1422) 48"(1219)	35*	35*	35*	35*	35*
TCDP4556	TCDP4956	TCDP5356	TCDP6156		
63 3/8"(1609) 64 7/8"(1648) 60 3/4"(1543) 60"(1524) 52"(1321)	35*	35*	35*	35*	35*
TCDP4560	TCDP4960	TCDP5360	TCDP6160		

#### ELEVATION SYMBOL LEGEND

M.O. = MASONRY OPENING  
 VALUES IN ( ) ARE IN MILLIMETER CONVERSIONS  
 \*\*\* NUMBER INDICATES DESIGN PRESSURE (DP) RATING WITH STANDARD GLAZING.  
 \*\*\*\* NUMBER INDICATES OPTIONAL DESIGN PRESSURE (DP) RATING.

Note Elevations shown DO NOT have exterior trim. Subtract 3/4" (19) from M.O. (Masonry Opening) for Unit Sizes. Masonry Openings above include Sill Nose, see Trim Options page for Sill Nose specifications. For other Trim Options refer to the Unit Sizing, Rough Opening & Masonry Openings page.

SCALE: 1/4" = 1'

### PICTURE UNITS

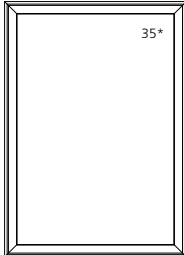
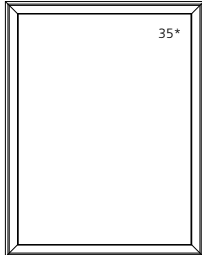
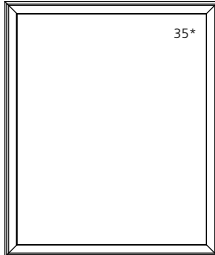
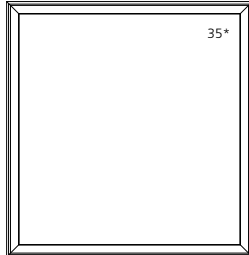
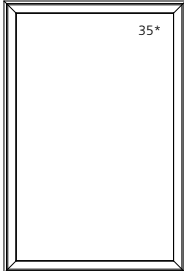
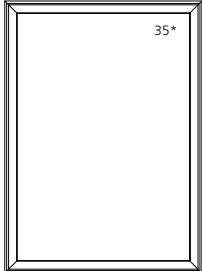
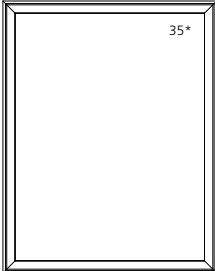
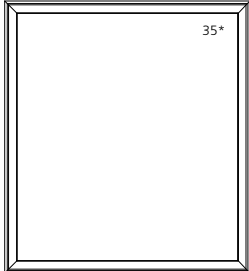
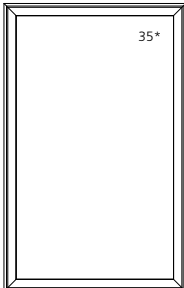
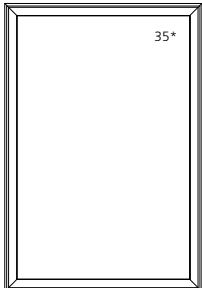
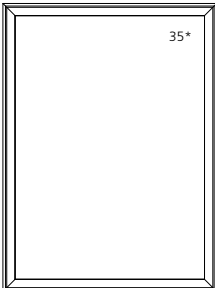
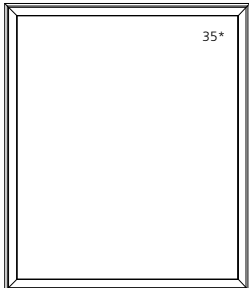
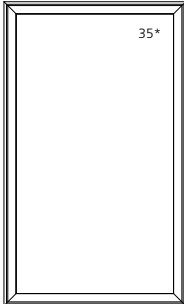
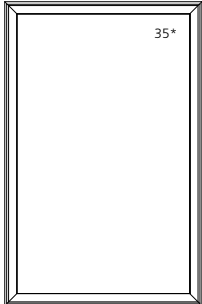
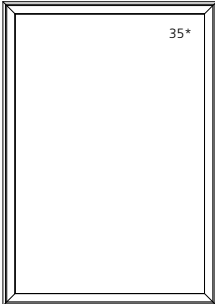
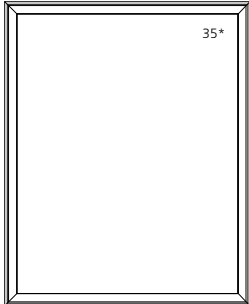
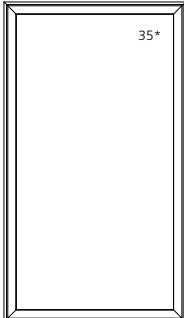
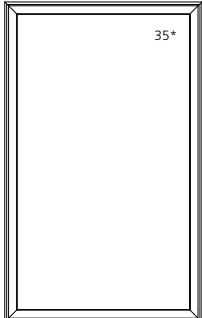
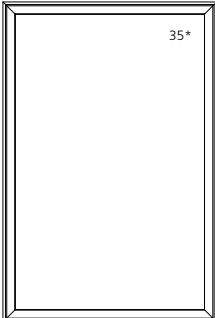
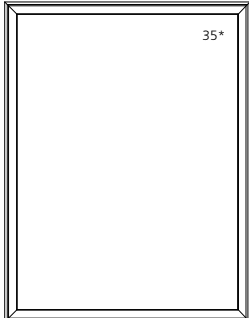
M.O. BRICKMOULD	49 1/8" (1248)	53 1/8" (1349)	57 1/8" (1451)	65 1/8" (1654)
M.O. ADAMS/FLAT CASING	52 1/8" (1324)	56 1/8" (1426)	60 1/8" (1527)	68 1/8" (1730)
ROUGH OPENING	46 1/8" (1172)	50 1/8" (1273)	54 1/8" (1375)	62 1/8" (1578)
FRAME SIZE	45 3/8" (1153)	49 3/8" (1254)	53 3/8" (1355)	61 3/8" (1559)
DAYLIGHT OPENING	38 15/16" (989)	42 15/16" (1091)	46 15/16" (1192)	54 15/16" (1395)
67 3/8" (1711) 68 7/8" (1749) 64 3/4" (1645) 64" (1626) 56" (1422)				
	TCDP4564	TCDP4964	TCDP5364	TCDP6164
71 3/8" (1813) 72 7/8" (1851) 68 3/4" (1746) 68" (1727) 60" (1524)				
	TCDP4568	TCDP4968	TCDP5368	TCDP6168
75 3/8" (1915) 76 7/8" (1953) 72 3/4" (1848) 72" (1829) 66" (1676)				
	TCDP4572	TCDP4972	TCDP5372	TCDP6172
79 3/8" (2016) 80 7/8" (2054) 76 3/4" (1949) 76" (1930) 68" (1727)				
	TCDP4576	TCDP4976	TCDP5376	TCDP6176
83 3/8" (2118) 84 7/8" (2155) 80 3/4" (2051) 80" (2032) 72" (1829)				
	TCDP4580	TCDP4980	TCDP5380	TCDP6180

**ELEVATION SYMBOL LEGEND**

M.O. = MASONRY OPENING  
 VALUES IN () ARE IN MILLIMETER CONVERSIONS  
 ### NUMBER INDICATES DESIGN PRESSURE (DP) RATING WITH STANDARD GLAZING.

Note Elevations shown DO NOT have exterior trim. Subtract 3/4" (19) from M.O. (Masonry Opening) for Unit Sizes. Masonry Openings above include Sill Nose, see Trim Options page for Sill Nose specifications. For other Trim Options refer to the Unit Sizing, Rough Opening & Masonry Openings page.

SCALE: 1/4" = 1'

**PICTURE UNITS**

<b>M.O. BRICKMOULD</b>	49 1/8"(1248)	53 1/8"(1349)	57 1/8"(1451)	65 1/8"(1654)
<b>M.O. ADAMS/FLAT CASING</b>	52 1/8"(1324)	56 1/8"(1426)	60 1/8"(1527)	68 1/8"(1730)
<b>ROUGH OPENING</b>	46 1/8"(1172)	50 1/8"(1273)	54 1/8"(1375)	62 1/8"(1578)
<b>FRAME SIZE</b>	45 3/8"(1153)	49 3/8"(1254)	53 3/8"(1355)	61 3/8"(1559)
<b>DAYLIGHT OPENING</b>	38 15/16"(989)	42 15/16"(1091)	46 15/16"(1192)	54 15/16"(1395)

91 3/8"(2321)  
94 7/8"(2359)  
88 3/4"(2254)  
88"(2235)  
80"(2032)

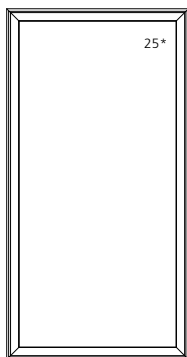

TCDP4588

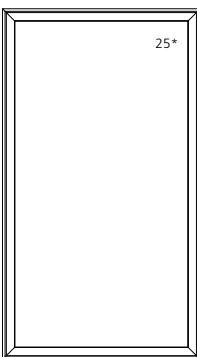

TCDP4988

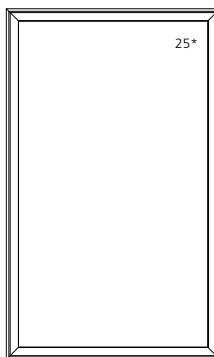

TCDP5388

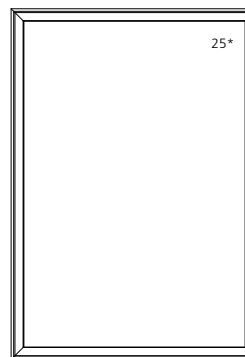

TCDP6188

**ELEVATION SYMBOL LEGEND**  
M.O. = MASONRY OPENING  
VALUES IN ( ) ARE IN MILLIMETER CONVERSIONS  
\*\*\* NUMBER INDICATES DESIGN PRESSURE (DP) RATING WITH STANDARD GLAZING.

Note Elevations shown DO NOT have exterior trim. Subtract 3/4" (19) from M.O. (Masonry Opening) for Unit Sizes. Masonry Openings above include Sill Nose, see Trim Options page for Sill Nose specifications. For other Trim Options refer to the Unit Sizing, Rough Opening & Masonry Openings page.

SCALE: 1/4" = 1'

### PICTURE UNITS

M.O. BRICKMOULD  
M.O. ADAMS/FLAT CASING  
ROUGH OPENING  
FRAME SIZE  
DAYLIGHT OPENING

77 1/8" (1959)  
80 1/8" (2035)  
74 1/8" (1883)  
73 3/8" (1864)  
66 15/16" (1700)



TCDP7336

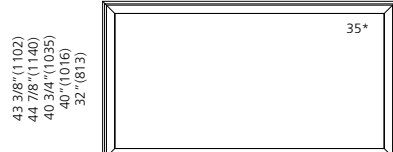

TCDP7340



TCDP7348



TCDP7352



TCDP7356



TCDP7360

M.O. BRICKMOULD  
M.O. ADAMS/FLAT CASING  
ROUGH OPENING  
FRAME SIZE  
DAYLIGHT OPENING

77 1/8" (1959)  
80 1/8" (2035)  
74 1/8" (1883)  
73 3/8" (1864)  
66 15/16" (1700)

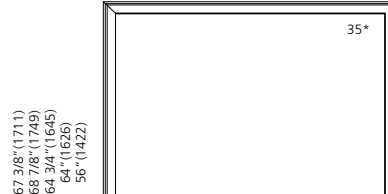

TCDP7364

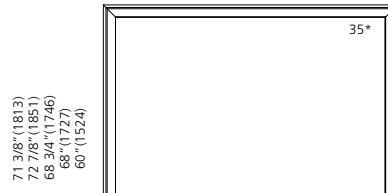

TCDP7368

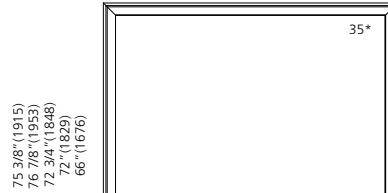

TCDP7372

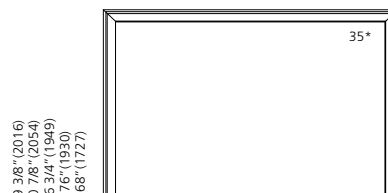

TCDP7376

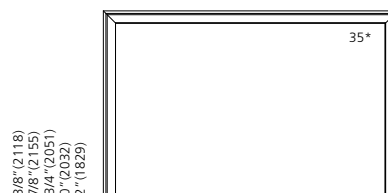

TCDP7380

**ELEVATION SYMBOL LEGEND**

M.O. = MASONRY OPENING

VALUES IN ( ) ARE IN MILLIMETER CONVERSIONS

### NUMBER INDICATES DESIGN PRESSURE (DP) RATING WITH STANDARD GLAZING.

#### NUMBER INDICATES OPTIONAL DESIGN PRESSURE (DP) RATING.

Note Elevations shown DO NOT have exterior trim. Subtract 3/4" (19) from M.O. (Masonry Opening) for Unit Sizes. Masonry Openings above include Sill Nose, see Trim Options page for Sill Nose specifications. For other Trim Options refer to the Unit Sizing, Rough Opening & Masonry Openings page.

SCALE: 1/4" = 1'

**PICTURE UNITS**

M.O. BRICKMOULD	77 1/8"(1959)
M.O. ADAMS/FLAT CASING	80 1/8"(2035)
ROUGH OPENING	74 1/8"(1883)
FRAME SIZE	73 3/8"(1864)
DAYLIGHT OPENING	66 15/16"(1700)

91 3/8"(2321)  
92 7/8"(2359)  
88 3/4"(2254)  
88"(2235)  
80"(2032)

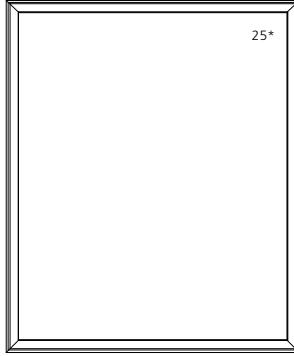

TCDP7388

**ELEVATION SYMBOL LEGEND**

M.O. = MASONRY OPENING  
VALUES IN () ARE IN MILLIMETER CONVERSIONS  
### NUMBER INDICATES DESIGN PRESSURE (DP) RATING WITH STANDARD GLAZING.

Note Elevations shown DO NOT have exterior trim. Subtract 3/4" (19) from M.O. (Masonry Opening) for Unit Sizes. Masonry Openings above include Sill Nose, see Trim Options page for Sill Nose specifications. For other Trim Options refer to the Unit Sizing, Rough Opening & Masonry Openings page.

SCALE: 1/4" = 1'

**PICTURE UNITS WITH 21" FLANKERS**

M.O. BRICKMOUND M.O. ADAMS/FLAT CASING ROUGH OPENING FRAME SIZE DAYLIGHT OPENING	95 7/8"(2435) 98 7/8"(2511) 92 7/8"(2359) 92 1/8"(2340)	99 7/8"(2537) 102 7/8"(2613) 96 7/8"(2461) 96 1/8"(2442)	107 7/8"(2740) 110 7/8"(2816) 104 7/8"(2664) 104 1/8"(2645)	119 7/8"(3045) 122 7/8"(3121) 116 7/8"(2968) 116 1/8"(2950)
	14 15/16"(379)[2] 42 15/16"(1091)	14 15/16"(379)[2] 46 15/16"(1192)	14 15/16"(379)[2] 54 15/16"(1395)	14 15/16"(379)[2] 66 15/16"(1700)
51 3/8"(1305) 52 7/8"(1343) 48 3/4"(1238) 48"(1219) 19 1/4"(489)[2] 40"(1016)				
55 3/8"(1407) 56 7/8"(1445) 52 3/4"(1340) 52"(1321) 21 1/4"(540)[2] 44"(1118)				
59 3/8"(1508) 60 7/8"(1546) 56 3/4"(1441) 56"(1422) 23 1/4"(591)[2] 48"(1219)				
67 3/8"(1711) 68 7/8"(1749) 64 3/4"(1645) 64"(1626) 27 1/4"(692)[2] 56"(1422)				
71 3/8"(1813) 72 7/8"(1851) 68 3/4"(1746) 68"(1727) 29 1/4"(743)[2] 60"(1524)				
79 3/8"(2016) 80 7/8"(2054) 76 3/4"(1949) 76"(1930) 33 1/4"(845)[2] 68"(1727)				











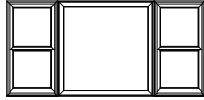
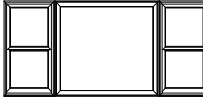
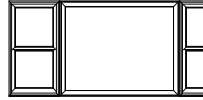
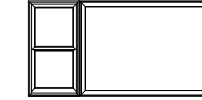
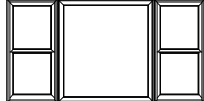
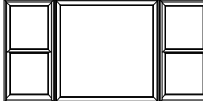
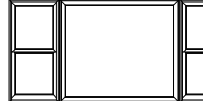
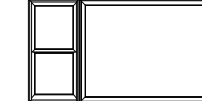
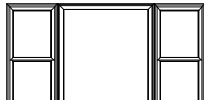

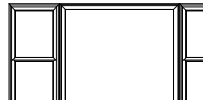
**ELEVATION SYMBOL LEGEND:**  
M.O. = MASONRY OPENING  
VALUES IN ( ) ARE IN MILLIMETER CONVERSIONS  
VALUES IN [ ] ARE NUMBER OF DAYLIGHT OPENINGS PER UNIT

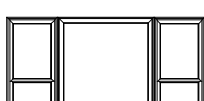
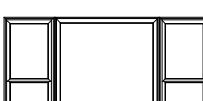
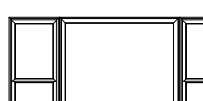
Note Elevations shown DO NOT have exterior trim. Subtract 3/4" (19) from M.O. (Masonry Opening) for Unit Sizes. Masonry Openings above include Sill Nose, see Trim Options page for Sill Nose specifications. For other Trim Options refer to the Unit Sizing, Rough Opening & Masonry Openings page.

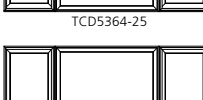
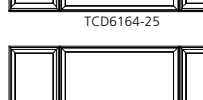
SCALE: 1/8" = 1'

**PICTURE UNITS WITH 25" FLANKERS**

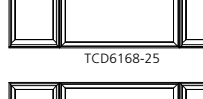
**M.O. BRICKMOULD**  
**M.O. ADAMS/FLAT CASING**  
**ROUGH OPENING**  
**FRAME SIZE**  
**DAYLIGHT OPENING**

	103 7/8" (2638) 106 7/8" (2715) 100 7/8" (2562) 100 1/8" (2543)	107 7/8" (2740) 110 7/8" (2816) 104 7/8" (2664) 104 1/8" (2645)	115 7/8" (2943) 118 7/8" (3019) 112 7/8" (2867) 112 1/8" (2848)	127 7/8" (3248) 130 7/8" (3324) 124 7/8" (3171) 124 1/8" (3153)
	18 15/16" (481)[2] 42 15/16" (1091)	18 15/16" (481)[2] 46 15/16" (1192)	18 15/16" (481)[2] 54 15/16" (1395)	18 15/16" (481)[2] 66 15/16" (1700)
51 3/8" (1305) 52 7/8" (1343) 48 3/4" (1238) 48" (1219) 19 1/4" (489)[2] 40" (1016)	 TCD4948-25	 TCD5348-25	 TCD6148-25	 TCD7348-25
55 3/8" (1407) 56 7/8" (1445) 52 3/4" (1340) 52" (1321) 21 1/4" (540)[2] 44" (1118)	 TCD4952-25	 TCD5352-25	 TCD6152-25	 TCD7352-25
59 3/8" (1508) 60 7/8" (1546) 56 3/4" (1441) 56" (1422) 23 1/4" (591)[2] 48" (1219)	 TCD4956-25	 TCD5356-25	 TCD6156-25	 TCD7356-25
67 3/8" (1711) 68 7/8" (1749) 64 3/4" (1645) 64" (1626) 27 1/4" (692)[2] 56" (1422)	 TCD4964-25	 TCD5364-25	 TCD6164-25	 TCD7364-25
71 3/8" (1813) 72 7/8" (1851) 68 3/4" (1746) 68" (1727) 29 1/4" (743)[2] 60" (1524)	 TCD4968-25	 TCD5368-25	 TCD6168-25	 TCD7368-25
79 3/8" (2016) 80 7/8" (2054) 76 3/4" (1949) 76" (1930) 33 1/4" (845)[2] 68" (1727)	 TCD4976-25	 TCD5376-25	 TCD6176-25	 TCD7376-25

**ELEVATION SYMBOL LEGEND:**  
M.O. = MASONRY OPENING  
VALUES IN ( ) ARE IN MILLIMETER CONVERSIONS  
VALUES IN [ ] ARE NUMBER OF DAYLIGHT OPENINGS PER UNIT

Note Elevations shown DO NOT have exterior trim. Subtract 3/4" (19) from M.O. (Masonry Opening) for Unit Sizes. Masonry Openings above include Sill Nose, see Trim Options page for Sill Nose specifications. For other Trim Options refer to the Unit Sizing, Rough Opening & Masonry Openings page.

SCALE: 1/8" = 1'



#### PICTURE UNITS WITH 29" FLANKERS

M.O. BRICKMOULD  
M.O. ADAMS/FLAT CASING  
ROUGH OPENING  
FRAME SIZE  
DAYLIGHT OPENING

	111 7/8" (2842) 114 7/8" (2918) 108 7/8" (2765) 108 1/8" (2746)	115 7/8" (2943) 118 7/8" (3019) 112 7/8" (2867) 112 1/8" (2848)	123 7/8" (3146) 126 7/8" (3223) 120 7/8" (3070) 120 1/8" (3051)	135 7/8" (3451) 138 7/8" (3527) 132 7/8" (3375) 132 1/8" (3356)
	22 15/16" (583)[2] 42 15/16" (1091)	22 15/16" (583)[2] 46 15/16" (1192)	22 15/16" (583)[2] 54 15/16" (1395)	22 15/16" (583)[2] 66 15/16" (1700)
51 3/8" (1305) 52 7/8" (1343) 48 3/4" (1238) 48" (1219) 19 1/4" (489)[2] 40" (1016)				
	TCD4948-29	TCD5348-29	TCD6148-29	TCD7348-29
55 3/8" (1407) 56 7/8" (1445) 52 3/4" (1340) 52" (1321) 21 1/4" (540)[2] 44" (1118)				
	TCD4952-29	TCD5352-29	TCD6152-29	TCD7352-29
59 3/8" (1508) 60 7/8" (1546) 56 3/4" (1441) 56" (1422) 23 1/4" (591)[2] 48" (1219)				
	TCD4956-29	TCD5356-29	TCD6156-29	TCD7356-29
67 3/8" (1711) 68 7/8" (1749) 64 3/4" (1645) 64" (1626) 27 1/4" (692)[2] 56" (1422)				
	TCD4964-29	TCD5364-29	TCD6164-29	TCD7364-29
71 3/8" (1813) 72 7/8" (1851) 68 3/4" (1746) 68" (1727) 29 1/4" (743)[2] 60" (1524)				
	TCD4968-29	TCD5368-29	TCD6168-29	TCD7368-29
79 3/8" (2016) 80 7/8" (2054) 76 3/4" (1949) 76" (1930) 33 1/4" (845)[2] 68" (1727)				
	TCD4976-29	TCD5376-29	TCD6176-29	TCD7376-29

**ELEVATION SYMBOL LEGEND:**

M.O. = MASONRY OPENING  
VALUES IN ( ) ARE IN MILLIMETER CONVERSIONS  
VALUES IN [ ] ARE NUMBER OF DAYLIGHT OPENINGS PER UNIT  
E = BASIC UNIT CLEAR OPENING EXCEEDS 20" IN WIDTH, 24" IN HEIGHT & A MINIMUM OF 5.7 SQ. FT.

Note Elevations shown DO NOT have exterior trim. Subtract 3/4" (19) from M.O. (Masonry Opening) for Unit Sizes. Masonry Openings above include Sill Nose, see Trim Options page for Sill Nose specifications. For other Trim Options refer to the Unit Sizing, Rough Opening & Masonry Openings page.

SCALE: 1/8" = 1'

### 30° ANGLE BAY UNITS WITH 21" FLANKERS

**M.O. BRICKMOULD**  
**M.O. ADAMS/FLAT CASING**  
**ROUGH OPENING**  
**FRAME SIZE**  
**DAYLIGHT OPENING**

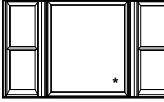
	83 15/16" (2132) 86" (2184) 79 3/4" (2026) 80 3/16" (2037)	87 15/16" (2234) 90" (2286) 83 3/4" (2127) 84 3/16" (2138)	95 15/16" (2437) 98" (2489) 91 3/4" (2330) 92 3/16" (2342)	99 15/16" (2538) 102" (2591) 95 3/4" (2432) 96 3/16" (2443)	107 15/16" (2742) 110" (2794) 103 3/4" (2635) 104 3/16" (2646)
	15 3/16" (368)[2] 32 51/64" (883)	15 3/16" (368)[2] 36 51/64" (935)	15 3/16" (368)[2] 44 51/64" (1138)	15 3/16" (368)[2] 48 51/64" (1239)	15 3/16" (368)[2] 56 51/64" (1443)
52 61/64" (1345) 54 31/64" (1384) 50" (1270) 49 1/2" (1257) 19 21/32" (499) 43 29/64" (1108)					
	TCD3Y3748-21	TCD3Y4148-21	TCD3Y4948-21	TCD3Y5348-21	TCD3Y6148-21
56 61/64" (1447) 58 31/64" (1486) 54" (1372) 53 1/2" (1359) 21 21/32" (550) 47 29/64" (1205)					
	TCD3Y3752-21	TCD3Y4152-21	TCD3Y4952-21	TCD3Y5352-21	TCD3Y6152-21
60 61/64" (1548) 62 31/64" (1587) 58" (1473) 57 1/2" (1460) 23 21/32" (601) 51 29/64" (1307)					
	TCD3Y3756-21	TCD3Y4156-21	TCD3Y4956-21	TCD3Y5356-21	TCD3Y6156-21
68 61/64" (1751) 70 31/64" (1790) 66" (1676) 65 1/2" (1664) 27 21/32" (702) 59 29/64" (1510)					
	TCD3Y3764-21	TCD3Y4164-21	TCD3Y4964-21	TCD3Y5364-21	TCD3Y6164-21
72 61/64" (1853) 74 31/64" (1892) 70" (1778) 69 1/2" (1765) 29 21/32" (753) 63 29/64" (1612)					
	TCD3Y3768-21	TCD3Y4168-21	TCD3Y4968-21	TCD3Y5368-21	TCD3Y6168-21
80 61/64" (2056) 82 31/64" (2095) 78" (1981) 77 1/2" (1969) 33 21/32" (855) 71 29/64" (1815)					
	TCD3Y3776-21	TCD3Y4176-21	TCD3Y4976-21	TCD3Y5376-21	TCD3Y6176-21

**ELEVATION SYMBOL LEGEND:**

**M.O.** = MASONRY OPENING  
 VALUES IN ( ) ARE IN MILLIMETER CONVERSIONS  
 VALUES IN [ ] ARE NUMBER OF DAYLIGHT OPENINGS PER UNIT  
 \* OPERABLE CENTER UNIT  
 E BASIC UNIT CLEAR OPENING EXCEEDS 20" IN WIDTH, 24" IN HEIGHT & A MINIMUM OF 5.7 SQ. FT.

Note Elevations shown DO NOT have exterior trim. Subtract 3/4" (19) from M.O. (Masonry Opening) for Unit Sizes. Masonry Openings above include Sill Nose, see Trim Options page for Sill Nose specifications. For other Trim Options refer to the Unit Sizing, Rough Opening & Masonry Openings page.

SCALE: 1/8" = 1'

### 30° ANGLE BAY UNITS WITH 25" FLANKERS

M.O. BRICKMOULD M.O. ADAMS/FLAT CASING ROUGH OPENING FRAME SIZE DAYLIGHT OPENING	90 7/8" (2308) 93 15/16" (2386) 86 3/4" (2203) 87 1/8" (2213)	94 7/8" (2410) 97 15/16" (2488) 90 3/4" (2305) 91 1/8" (2315)	102 7/8" (2613) 105 15/16" (2691) 98 3/4" (2508) 99 1/8" (2518)	106 7/8" (2715) 109 15/16" (2792) 102 3/4" (2610) 103 1/8" (2619)	114 7/8" (2918) 117 15/16" (2996) 110 3/4" (2813) 111 1/8" (2823)
	19 3/16" (487) [2] 26 5/32" (664)	19 3/16" (487) [2] 36 5/32" (918)	19 3/16" (487) [2] 44 5/32" (1122)	19 3/16" (487) [2] 48 5/32" (1223)	19 3/16" (487) [2] 56 5/32" (1426)
52 61/64" (1345) 54 31/64" (1384) 50" (1270) 49 1/2" (1257) 19 21/32" (499) 43 29/64" (1108)					
	TCD3Y3748-25	TCD3Y4148-25	TCD3Y4948-25	TCD3Y5348-25	TCD3Y6148-25
56 61/64" (1447) 58 31/64" (1486) 54" (1372) 53 1/2" (1359) 21 21/32" (550) 47 29/64" (1205)					
	TCD3Y3752-25	TCD3Y4152-25	TCD3Y4952-25	TCD3Y5352-25	TCD3Y6152-25
60 61/64" (1548) 62 31/64" (1587) 58" (1473) 57 1/2" (1448) 23 21/32" (601) 51 29/64" (1307)					
	TCD3Y3756-25	TCD3Y4156-25	TCD3Y4956-25	TCD3Y5356-25	TCD3Y6156-25
68 61/64" (1751) 70 31/64" (1790) 66" (1676) 65 1/2" (1664) 27 21/32" (702) 59 29/64" (1510)					
	TCD3Y3764-25	TCD3Y4164-25	TCD3Y4964-25	TCD3Y5364-25	TCD3Y6164-25
72 61/64" (1853) 74 31/64" (1892) 70" (1778) 69 1/2" (1765) 29 21/32" (753) 63 29/64" (1612)					
	TCD3Y3768-25	TCD3Y4168-25	TCD3Y4968-25	TCD3Y5368-25	TCD3Y6168-25
80 61/64" (2056) 82 31/64" (2095) 78" (1981) 77 1/2" (1969) 33 21/32" (855) 71 29/64" (1815)					
	TCD3Y3776-25	TCD3Y4176-25	TCD3Y4976-25	TCD3Y5376-25	TCD3Y6176-25

**ELEVATION SYMBOL LEGEND:**  
**M.O.** = MASONRY OPENING  
 VALUES IN ( ) ARE IN MILLIMETER CONVERSIONS  
 VALUES IN [ ] ARE NUMBER OF DAYLIGHT OPENINGS PER UNIT  
 \* OPERABLE CENTER UNIT  
 E BASIC UNIT CLEAR OPENING EXCEEDS 20" IN WIDTH, 24" IN HEIGHT & A MINIMUM OF 5.7 SQ. FT.

Note Elevations shown DO NOT have exterior trim. Subtract 3/4" (19) from M.O. (Masonry Opening) for Unit Sizes. Masonry Openings above include Sill Nose, see Trim Options page for Sill Nose specifications. For other Trim Options refer to the Unit Sizing, Rough Opening & Masonry Openings page.

SCALE: 1/8" = 1'

### 30° ANGLE BAY UNITS WITH 29" FLANKERS

M.O. BRICKMOUND	97 13/16" (2484)	101 13/16" (2586)	109 13/16" (2789)	113 13/16" (2891)	121 13/16" (3094)
M.O. ADAMS/FLAT CASING	100 7/8" (2562)	104 7/8" (2664)	112 7/8" (2867)	116 7/8" (2968)	124 7/8" (3172)
ROUGH OPENING	93 5/8" (2378)	97 5/8" (2479)	105 5/8" (2683)	109 5/8" (2784)	117 5/8" (2988)
FRAME SIZE	94 1/16" (2389)	98 1/16" (2491)	106 1/16" (2694)	110 1/16" (2796)	118 1/16" (2999)
DAYLIGHT OPENING	23 3/16" (589)[2] 29 11/64" (741)	23 3/16" (589)[2] 36 11/64" (919)	23 3/16" (589)[2] 44 11/64" (1122)	23 3/16" (589)[2] 48 11/64" (1224)	23 3/16" (589)[2] 56 11/64" (1427)
52 61/64" (1345) 54 31/64" (1384) 50" (1270) 49 1/2" (1257) 19 21/32" (499) 43 29/64" (1108)					
56 61/64" (1447) 58 31/64" (1486) 54" (1372) 53 1/2" (1359) 21 21/32" (550) 47 29/64" (1205)					
60 61/64" (1548) 62 31/64" (1587) 58" (1473) 57 1/2" (1448) 23 21/32" (601) 51 29/64" (1307)					
68 61/64" (1751) 70 31/64" (1790) 66" (1676) 65 1/2" (1664) 27 21/32" (702) 59 29/64" (1510)					
72 61/64" (1853) 74 31/64" (1892) 70" (1778) 69 1/2" (1765) 29 21/32" (753) 63 29/64" (1612)					
80 61/64" (2056) 82 31/64" (2095) 78" (1981) 77 1/2" (1969) 33 21/32" (855) 71 29/64" (1815)					











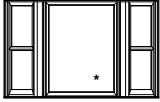
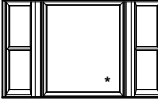
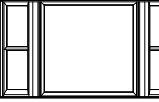
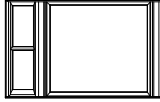
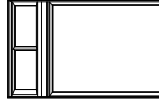
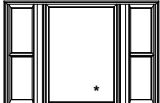
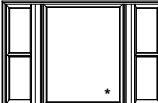



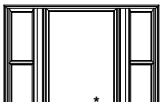
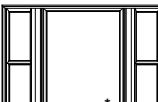

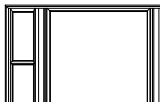

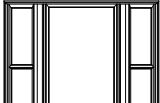

**ELEVATION SYMBOL LEGEND:**

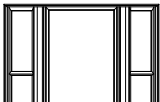
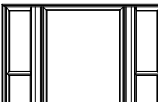
M.O. = MASONRY OPENING  
 VALUES IN ( ) ARE IN MILLIMETER CONVERSIONS  
 VALUES IN [ ] ARE NUMBER OF DAYLIGHT OPENINGS PER UNIT  
 \* OPERABLE CENTER UNIT  
 E BASIC UNIT CLEAR OPENING EXCEEDS 20" IN WIDTH, 24" IN HEIGHT & A MINIMUM OF 5.7 SQ. FT.

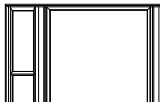
Note Elevations shown DO NOT have exterior trim. Subtract 3/4" (19) from M.O. (Masonry Opening) for Unit Sizes. Masonry Openings above include Sill Nose, see Trim Options page for Sill Nose specifications. For other Trim Options refer to the Unit Sizing, Rough Opening & Masonry Openings page.

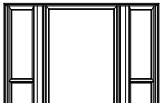
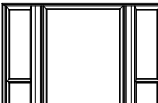
SCALE: 1/8" = 1'

#### 45° ANGLE BAY UNITS WITH 21" FLANKERS











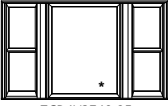
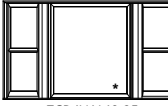
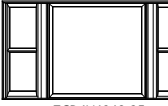

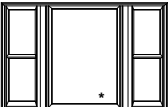
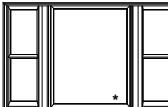



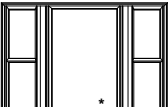
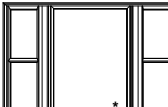

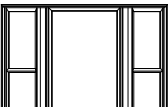
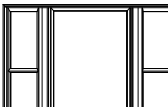

M.O. BRICKMOULD	79 9/16" (2021)	83 9/16" (2122)	91 9/16" (2326)	95 9/16" (2427)	103 9/16" (2630)
M.O. ADAMS/FLAT CASING	82 5/8" (2099)	86 5/8" (2200)	94 5/8" (2403)	98 5/8" (2505)	106 5/8" (2708)
ROUGH OPENING	74 7/8" (1902)	78 7/8" (2003)	86 7/8" (2207)	90 7/8" (2308)	98 7/8" (2511)
FRAME SIZE	75 13/16" (1926)	79 13/16" (2027)	87 13/16" (2230)	91 13/16" (2332)	99 13/16" (2535)
DAYLIGHT OPENING	15 3/16" (368) [2] 32 21/32" (829)	15 3/16" (368) [2] 36 21/32" (931)	15 3/16" (368) [2] 44 21/32" (1134)	15 3/16" (368) [2] 48 21/32" (1236)	15 3/16" (368) [2] 56 21/32" (1439)
52 61/64" (1345) 54 31/64" (1384) 50" (1270) 49 1/2" (1257) 19 21/32" (499) 43 29/64" (1108)	 TCD4Y3748-21	 TCD4Y4148-21	 TCD4Y4948-21	 TCD4Y5348-21	 TCD4Y6148-21
56 61/64" (1447) 58 31/64" (1486) 54" (1372) 53 1/2" (1359) 21 21/32" (550) 47 29/64" (1205)	 TCD4Y3752-21	 TCD4Y4152-21	 TCD4Y4952-21	 TCD4Y5352-21	 TCD4Y6152-21
60 61/64" (1548) 62 31/64" (1587) 58" (1473) 57 1/2" (1460) 23 21/32" (601) 51 29/64" (1307)	 TCD4Y3756-21	 TCD4Y4156-21	 TCD4Y4956-21	 TCD4Y5356-21	 TCD4Y6156-21
68 61/64" (1751) 70 31/64" (1790) 66" (1676) 65 1/2" (1664) 27 21/32" (702) 59 29/64" (1510)	 TCD4Y3764-21	 TCD4Y4164-21	 TCD4Y4964-21	 TCD4Y5364-21	 TCD4Y6164-21
72 61/64" (1853) 74 31/64" (1892) 70" (1778) 69 1/2" (1765) 29 21/32" (753) 63 29/64" (1612)	 TCD4Y3768-21	 TCD4Y4168-21	 TCD4Y4968-21	 TCD4Y5368-21	 TCD4Y6168-21
80 61/64" (2056) 82 31/64" (2095) 78" (1981) 77 1/2" (1969) 33 21/32" (855) 71 29/64" (1815)	 TCD4Y3776-21	 TCD4Y4176-21	 TCD4Y4976-21	 TCD4Y5376-21	 TCD4Y6176-21

**ELEVATION SYMBOL LEGEND:**  
**M.O.** = MASONRY OPENING  
 VALUES IN ( ) ARE IN MILLIMETER CONVERSIONS  
 VALUES IN [ ] ARE NUMBER OF DAYLIGHT OPENINGS PER UNIT  
 \* = OPERABLE CENTER UNIT  
 E = BASIC UNIT CLEAR OPENING EXCEEDS 20" IN WIDTH, 24" IN HEIGHT & A MINIMUM OF 5.7 SQ. FT.

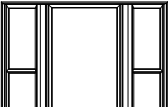
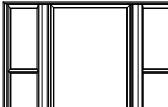
Note Elevations shown DO NOT have exterior trim. Subtract 3/4" (19) from M.O. (Masonry Opening) for Unit Sizes. Masonry Openings above include Sill Nose, see Trim Options page for Sill Nose specifications. For other Trim Options refer to the Unit Sizing, Rough Opening & Masonry Openings page.

SCALE: 1/8" = 1'

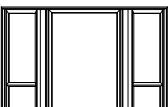
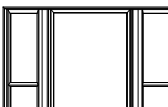
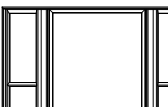
#### 45° ANGLE BAY UNITS WITH 25" FLANKERS

M.O. BRICKMOULD	85 3/16" (2164)	89 3/16" (2265)	97 3/16" (2469)	101 3/16" (2570)	109 3/16" (2773)
M.O. ADAMS/FLAT CASING	88 1/4" (2242)	92 1/4" (2343)	100 1/4" (2546)	104 1/4" (2648)	112 1/4" (2851)
ROUGH OPENING	80 1/2" (2045)	84 1/2" (2146)	92 1/2" (2350)	96 1/2" (2451)	104 1/2" (2654)
FRAME SIZE	81 7/16" (2069)	85 7/16" (2170)	93 7/16" (2373)	97 7/16" (2475)	105 7/16" (2678)
DAYLIGHT OPENING	19 3/16" (487) [2] 32 5/8" (829)	19 3/16" (487) [2] 36 5/8" (930)	19 3/16" (487) [2] 44 5/8" (1133)	19 3/16" (487) [2] 48 5/8" (1235)	19 3/16" (487) [2] 56 5/8" (1438)
52 61/64" (1345) 54 31/64" (1384) 50" (1270) 49 1/2" (1257) 19 21/32" (499) 43 29/64" (1108)					
	TCD4Y3748-25	TCD4Y4148-25	TCD4Y4948-25	TCD4Y5348-25	TCD4Y6148-25
56 61/64" (1447) 58 31/64" (1486) 54" (1372) 53 1/2" (1359) 21 21/32" (550) 47 29/64" (1205)					
	TCD4Y3752-25	TCD4Y4152-25	TCD4Y4952-25	TCD4Y5352-25	TCD4Y6152-25
60 61/64" (1548) 62 31/64" (1587) 58" (1473) 57 1/2" (1464) 23 21/32" (601) 51 29/64" (1307)					
	TCD4Y3756-25	TCD4Y4156-25	TCD4Y4956-25	TCD4Y5356-25	TCD4Y6156-25
68 61/64" (1751) 70 31/64" (1790) 66" (1676) 65 1/2" (1664) 27 21/32" (702) 59 29/64" (1510)					
	TCD4Y3764-25	TCD4Y4164-25	TCD4Y4964-25	TCD4Y5364-25	TCD4Y6164-25
72 61/64" (1853) 74 31/64" (1892) 70" (1778) 69 1/2" (1765) 29 21/32" (753) 63 29/64" (1612)					
	TCD4Y3768-25	TCD4Y4168-25	TCD4Y4968-25	TCD4Y5368-25	TCD4Y6168-25
80 61/64" (2056) 82 31/64" (2095) 78" (1981) 77 1/2" (1969) 33 21/32" (855) 71 29/64" (1815)					
	TCD4Y3776-25	TCD4Y4176-25	TCD4Y4976-25	TCD4Y5376-25	TCD4Y6176-25











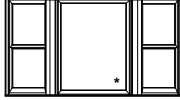
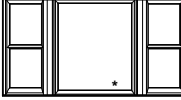
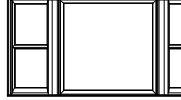
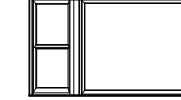

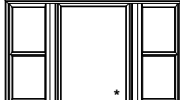
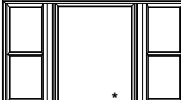
**ELEVATION SYMBOL LEGEND:**

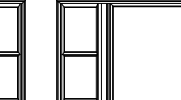
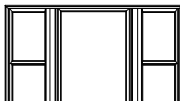
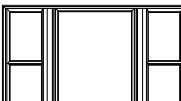
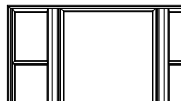
M.O. = MASONRY OPENING  
 VALUES IN ( ) ARE IN MILLIMETER CONVERSIONS  
 VALUES IN [ ] ARE NUMBER OF DAYLIGHT OPENINGS PER UNIT  
 \* OPERABLE CENTER UNIT  
 E BASIC UNIT CLEAR OPENING EXCEEDS 20" IN WIDTH, 24" IN HEIGHT & A MINIMUM OF 5.7 SQ. FT.

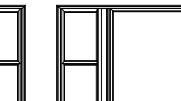
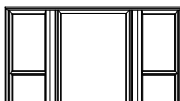
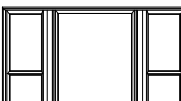
Note Elevations shown DO NOT have exterior trim. Subtract 3/4" (19) from M.O. (Masonry Opening) for Unit Sizes. Masonry Openings above include Sill Nose, see Trim Options page for Sill Nose specifications. For other Trim Options refer to the Unit Sizing, Rough Opening & Masonry Openings page.

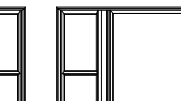
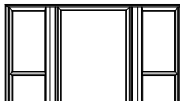
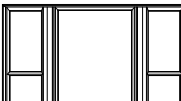
SCALE: 1/8" = 1'

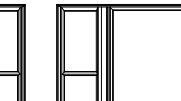
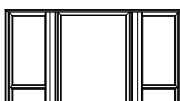
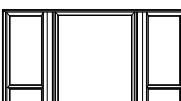
#### 45° ANGLE BAY UNITS WITH 29" FLANKERS

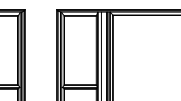
M.O. BRICKMOULD	90 7/8" (2308)	94 7/8" (2410)	102 7/8" (2613)	106 7/8" (2715)	114 7/8" (2918)
M.O. ADAMS/FLAT CASING	93 15/16" (2386)	97 15/16" (2488)	105 15/16" (2691)	109 15/16" (2792)	117 15/16" (2996)
ROUGH OPENING	86 3/16" (2189)	90 3/16" (2291)	98 3/16" (2494)	102 3/16" (2596)	110 3/16" (2799)
FRAME SIZE	87 1/8" (2213)	91 1/8" (2315)	99 1/8" (2518)	103 1/8" (2619)	111 1/8" (2823)
DAYLIGHT OPENING	23 3/16" (589)[2] 32 21/64" (829)	23 3/16" (589)[2] 36 21/64" (931)	23 3/16" (589)[2] 44 21/64" (1134)	23 3/16" (589)[2] 48 21/64" (1236)	23 3/16" (589)[2] 56 21/64" (1439)
52 61/64" (1345) 54 31/64" (1384) 50" (1270) 49 1/2" (1257) 19 21/32" (499) 43 29/64" (1108)	 TCD4Y3748-29	 TCD4Y4148-29	 TCD4Y4948-29	 TCD4Y5348-29	 TCD4Y6148-29
56 61/64" (1447) 58 31/64" (1486) 54" (1372) 53 1/2" (1359) 21 21/32" (550) 47 29/64" (1205)	 TCD4Y3752-29	 TCD4Y4152-29	 TCD4Y4952-29	 TCD4Y5352-29	 TCD4Y6152-29
60 61/64" (1548) 62 31/64" (1587) 58" (1473) 57 1/2" (1448) 23 21/32" (601) 51 29/64" (1307)	 TCD4Y3756-29	 TCD4Y4156-29	 TCD4Y4956-29	 TCD4Y5356-29	 TCD4Y6156-29
68 61/64" (1751) 70 31/64" (1790) 66" (1676) 65 1/2" (1664) 27 21/32" (702) 59 29/64" (1510)	 TCD4Y3764-29	 TCD4Y4164-29	 TCD4Y4964-29	 TCD4Y5364-29	 TCD4Y6164-29
72 61/64" (1853) 74 31/64" (1892) 70" (1778) 69 1/2" (1765) 29 21/32" (753) 63 29/64" (1612)	 TCD4Y3768-29	 TCD4Y4168-29	 TCD4Y4968-29	 TCD4Y5368-29	 TCD4Y6168-29
80 61/64" (2056) 82 31/64" (2095) 78" (1981) 77 1/2" (1969) 33 21/32" (855) 71 29/64" (1815)	 TCD4Y3776-29	 TCD4Y4176-29	 TCD4Y4976-29	 TCD4Y5376-29	 TCD4Y6176-29

**ELEVATION SYMBOL LEGEND:**  
M.O. = MASONRY OPENING  
VALUES IN ( ) ARE IN MILLIMETER CONVERSIONS  
VALUES IN [ ] ARE NUMBER OF DAYLIGHT OPENINGS PER UNIT  
\* = OPERABLE CENTER UNIT  
E = BASIC UNIT CLEAR OPENING EXCEEDS 20" IN WIDTH, 24" IN HEIGHT & A MINIMUM OF 5.7 SQ. FT.

Note Elevations shown DO NOT have exterior trim. Subtract 3/4" (19) from M.O. (Masonry Opening) for Unit Sizes. Masonry Openings above include Sill Nose, see Trim Options page for Sill Nose specifications. For other Trim Options refer to the Unit Sizing, Rough Opening & Masonry Openings page.

SCALE: 1/8" = 1'

**ELEVATION NOTES**  
**DOUBLE-HUNG TRANSOM**

ELEVATION DRAWINGS UTILIZE A LIMITED NUMBER OF PROJECTED LINES TO PRODUCE A RUDIMENTARY DRAWING INTENDED TO BE USED IN A SMALL GRAPHICAL SCALE. ELEVATIONS ARE VIEWED PERPENDICULAR FROM THE EXTERIOR OF THE STRUCTURE. IF MORE DIMENSIONS ARE NEEDED, USE THE SECTION DRAWINGS FOR MORE COMPLETE DEPICTIONS.

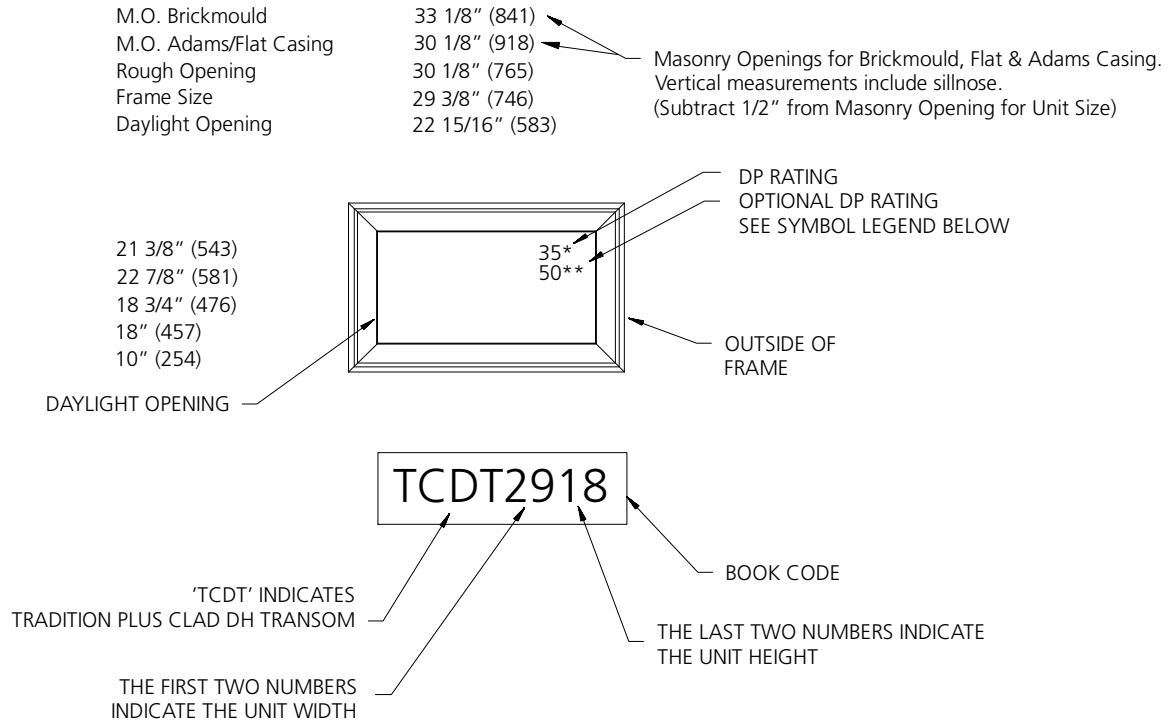

**GENERAL DOUBLE-HUNG TRANSOM NOTES**

1. ALL UNITS SHOWN ARE AVAILABLE AS STATIONARY ONLY.
2. UNIT ELEVATIONS ARE SHOWN WITH BRICKMOULD AND SUBSILL.
3. DIMENSIONAL VALUES IN PARENTHESES ARE MILLIMETER CONVERSIONS.

**ELEVATION SYMBOL LEGEND:**

- M.O.** MASONRY OPENING
- ##\*** NUMBER INDICATES STANDARD DESIGN PRESSURE (DP) RATING.
- ##\*\*** NUMBER INDICATES OPTIONAL DESIGN PRESSURE (DP) RATING.



### TRANSOM UNITS

M.O. BRICKMOULD	25 1/8" (638)	29 1/8" (740)	33 1/8" (841)	37 1/8" (943)	41 1/8" (1045)	45 1/8" (1146)	46 1/2" (1181)
M.O. ADAMS/FLAT CASING	28 1/8" (714)	32 1/8" (816)	36 1/8" (918)	40 1/8" (1019)	44 1/8" (1121)	48 1/8" (1222)	49 1/2" (1257)
ROUGH OPENING	22 1/8" (562)	26 1/8" (664)	30 1/8" (765)	34 1/8" (867)	38 1/8" (968)	42 1/8" (1070)	43 1/2" (1105)
FRAME SIZE	21 3/8" (543)	25 3/8" (645)	29 3/8" (746)	33 3/8" (848)	37 3/8" (949)	41 3/8" (1051)	42 3/4" (1086)
DAYLIGHT OPENING	14 15/16" (379)	18 15/16" (481)	22 15/16" (583)	26 15/16" (684)	30 15/16" (786)	34 15/16" (887)	36 5/16" (922)
18 3/8" (467) 19 7/8" (505) 15 3/4" (400) 15" (381) 7" (227)							
21 3/8" (543) 22 7/8" (581) 18 3/4" (476) 18" (457) 10" (254)							
27 3/8" (695) 28 7/8" (733) 24 3/4" (629) 24" (610) 17" (432)							
39 3/8" (1000) 40 7/8" (1038) 36 3/4" (933) 36" (914) 28" (711)							

M.O. BRICKMOULD	49 1/8" (1248)	53 1/8" (1349)	54 1/2" (1384)	57 1/8" (1451)
M.O. ADAMS/FLAT CASING	52 1/8" (1324)	56 1/8" (1426)	57 1/2" (1448)	60 1/8" (1527)
ROUGH OPENING	46 1/8" (1172)	50 1/8" (1273)	51 1/2" (1308)	54 1/8" (1375)
FRAME SIZE	45 3/8" (1153)	49 3/8" (1254)	50 3/4" (1289)	53 3/8" (1355)
DAYLIGHT OPENING	38 15/16" (989)	42 15/16" (1091)	44 5/16" (1126)	46 15/16" (1192)

18 3/8" (467) 19 7/8" (505) 15 3/4" (400) 15" (381) 7" (227)				
21 3/8" (543) 22 7/8" (581) 18 3/4" (476) 18" (457) 10" (254)				
27 3/8" (695) 28 7/8" (733) 24 3/4" (629) 24" (610) 17" (432)				
39 3/8" (1000) 40 7/8" (1038) 36 3/4" (933) 36" (914) 28" (711)				

**ELEVATION SYMBOL LEGEND:**

M.O. = MASONRY OPENING

VALUES IN ( ) ARE IN MILLIMETER CONVERSIONS

##\* NUMBER INDICATES DESIGN PRESSURE (DP) RATING WITH STANDARD GLAZING.

###\* NUMBER INDICATES OPTIONAL DESIGN PRESSURE (DP) RATING.

Note Elevations shown DO NOT have exterior trim. Subtract 3/4" (19) from M.O. (Masonry Opening) for Unit Sizes. Masonry Openings above include Sill Nose, see Trim Options page for Sill Nose specifications. For other Trim Options refer to the Unit Sizing, Rough Opening & Masonry Openings page.

SCALE: 1/4" = 1'

### TRANSOM UNITS

**M.O. BRICKMOULD**  
**M.O. ADAMS/FLAT CASING**  
**ROUGH OPENING**  
**FRAME SIZE**  
**DAYLIGHT OPENING**

62 1/2" (1588)  
 65 1/2" (1664)  
 59 1/2" (1511)  
 58 3/4" (1492)  
 52 5/16" (1329)

65 1/8" (1654)  
 68 1/8" (1730)  
 62 1/8" (1578)  
 61 3/8" (1559)  
 54 15/16" (1395)

70 1/2" (1791)  
 73 1/2" (1867)  
 67 1/2" (1715)  
 66 3/4" (1695)  
 60 5/16" (1532)

77 1/8" (1959)  
 80 1/8" (2035)  
 74 1/8" (1883)  
 73 3/8" (1864)  
 66 15/16" (1700)

18 3/8" (467)  
 19 7/8" (505)  
 15 3/4" (400)  
 15 (381)  
 7 (227)



TCDT5815

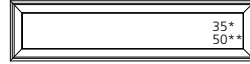

TCDT6115



TCDT6615



TCDT7315

21 3/8" (543)  
 22 7/8" (581)  
 18 3/4" (476)  
 18 (457)  
 10 (254)



TCDT5818



TCDT6118



TCDT6618



TCDT7318

27 3/8" (695)  
 28 7/8" (733)  
 24 3/4" (629)  
 24 (610)  
 17 (432)

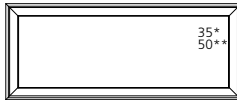

TCDT5824

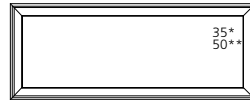

TCDT6124

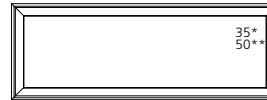

TCDT6624

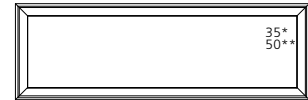

TCDT7324

39 3/8" (1000)  
 40 7/8" (1038)  
 36 3/4" (933)  
 36 (914)  
 28 (711)

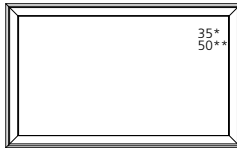

TCDT5836

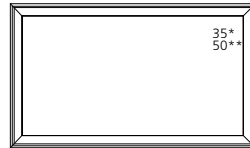

TCDT6136

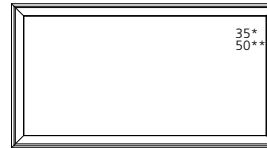

TCDT6636

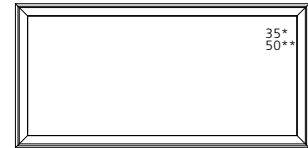

TCDT7336

**M.O. BRICKMOULD**  
**M.O. ADAMS/FLAT CASING**  
**ROUGH OPENING**  
**FRAME SIZE**  
**DAYLIGHT OPENING**

78 1/2" (1994)  
 81 1/2" (2070)  
 75 1/2" (1918)  
 74 3/4" (1899)  
 68 5/16" (1735)

18 3/8" (467)  
 19 7/8" (505)  
 15 3/4" (400)  
 15 (381)  
 7 (227)



TCDT7415

21 3/8" (543)  
 22 7/8" (581)  
 18 3/4" (476)  
 18 (457)  
 10 (254)



TCDT7418

27 3/8" (695)  
 28 7/8" (733)  
 24 3/4" (629)  
 24 (610)  
 17 (432)

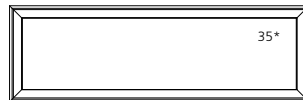

TCDT7424

39 3/8" (1000)  
 40 7/8" (1038)  
 36 3/4" (933)  
 36 (914)  
 28 (711)

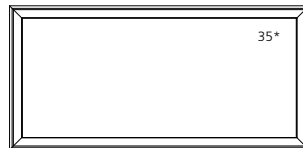

TCDT7436

**ELEVATION SYMBOL LEGEND:**

M.O. = MASONRY OPENING  
 VALUES IN ( ) ARE IN MILLIMETER CONVERSIONS  
 \*\*\* NUMBER INDICATES DESIGN PRESSURE (DP) RATING WITH STANDARD GLAZING.  
 \*\*\*\* NUMBER INDICATES OPTIONAL DESIGN PRESSURE (DP) RATING.

Note Elevations shown DO NOT have exterior trim. Subtract 3/4" (19) from M.O. (Masonry Opening) for Unit Sizes. Masonry Openings above include Sill Nose, see Trim Options page for Sill Nose specifications. For other Trim Options refer to the Unit Sizing, Rough Opening & Masonry Openings page.

SCALE: 1/4" = 1'

---

**POCKET WINDOW  
DOUBLE-HUNG**

---

**DOUBLE HUNG MINIMUM/MAXIMUM SIZES**

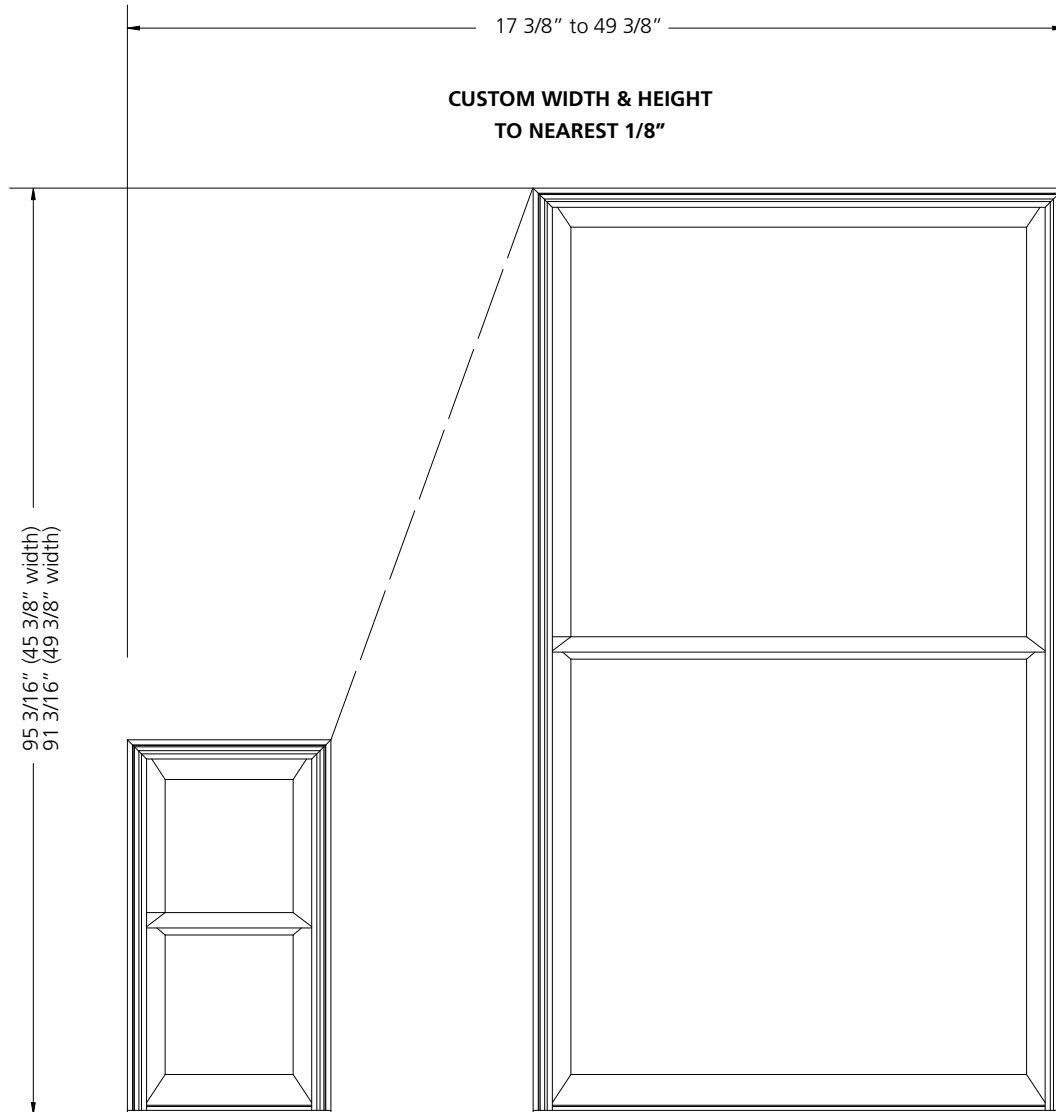

**MAXIMUM DP RATED SIZE: 45 3/8" x 95 3/16"  
49 3/8" x 91 3/16"**

---

**POCKET WINDOW  
PICTURE**

---

**TRANSOM/PICTURE MINIMUM/MAXIMUM SIZES**

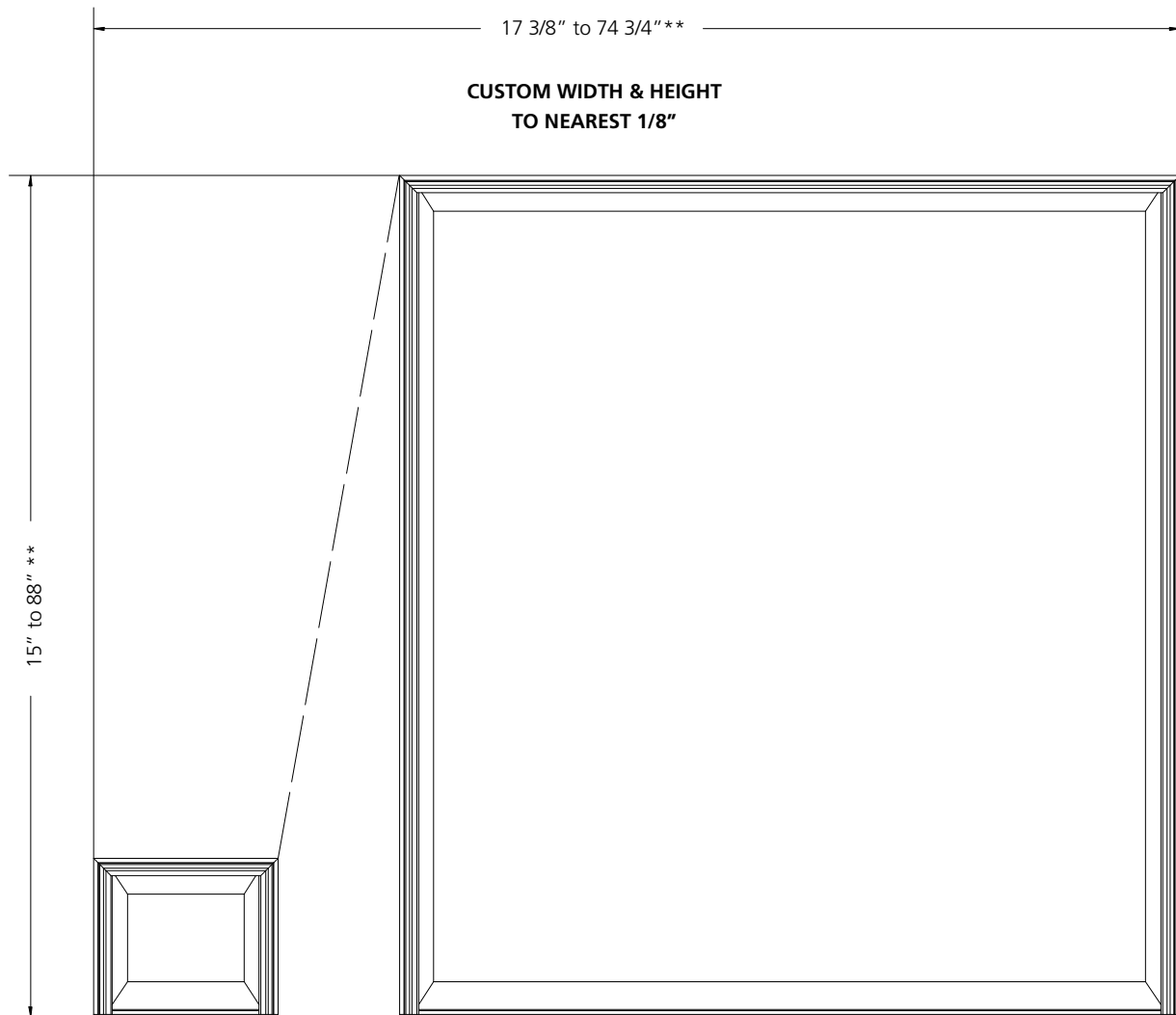

**\*\* TRANSOM SIZES:  $17 \frac{3}{8}''$  TO  $45 \frac{3}{8}''$  WIDE  
 $15''$  TO  $48''$  HIGH**

**\*\* PICTURE SIZES:  $45 \frac{1}{2}''$  TO  $74 \frac{3}{4}''$  WIDE  
 $48 \frac{1}{8}''$  TO  $88''$  HIGH**

**MAXIMUM DP RATED SIZE:  $73 \frac{3}{8}''$  X  $79 \frac{3}{16}''$**

**GLAZING OPTIONS**

**INTERIOR GLAZING**

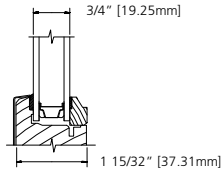

**INSULATED GLASS**

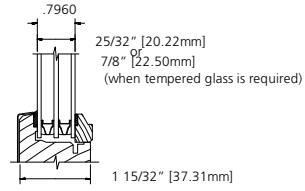

**TRIPLE GLAZE INSULATED**

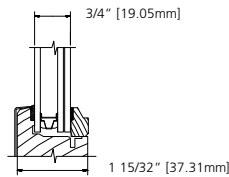

**LAMINATED INSULATED  
CLEAR OR LOW-E**  
3.0mm//6.7mm LAMINATE

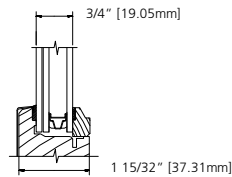

**LAMINATED INSULATED  
TINTED**  
6.7mm LAMINATE//3.0mm

**TRIM OPTIONS**

**EXTERIOR TRIM**

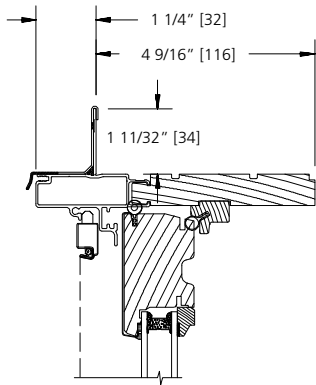

**STANDARD**

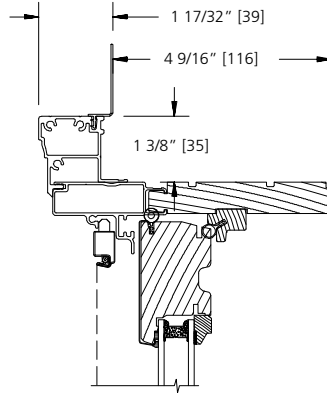

**BRICKMOULD**

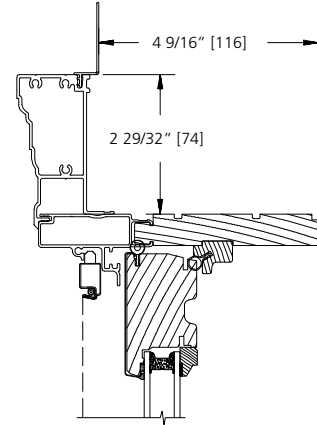

**ADAMS CASING**

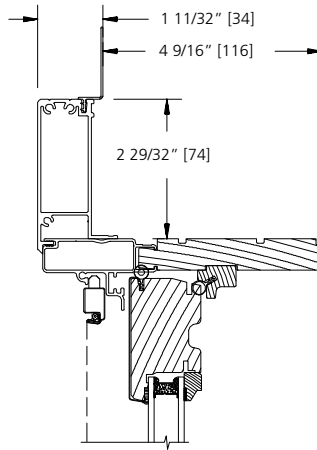

**3 1/2\"/>**

**SILL OPTIONS**

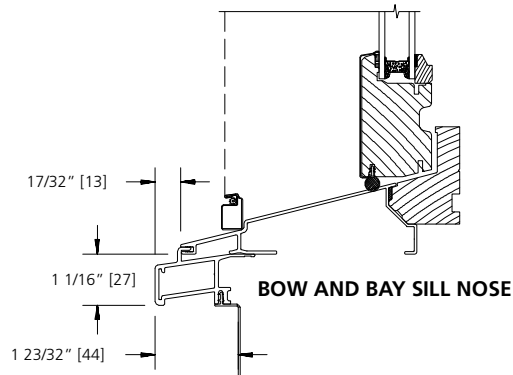
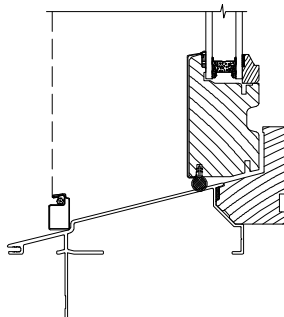

**BOW AND BAY SILL NOSE**

THESE OPTIONS ARE NOT AVAILABLE FOR THE DOUBLE HUNG POCKET WINDOW.

SCALE: 3" = 1'

**JAMB EXTENDER OPTIONS**

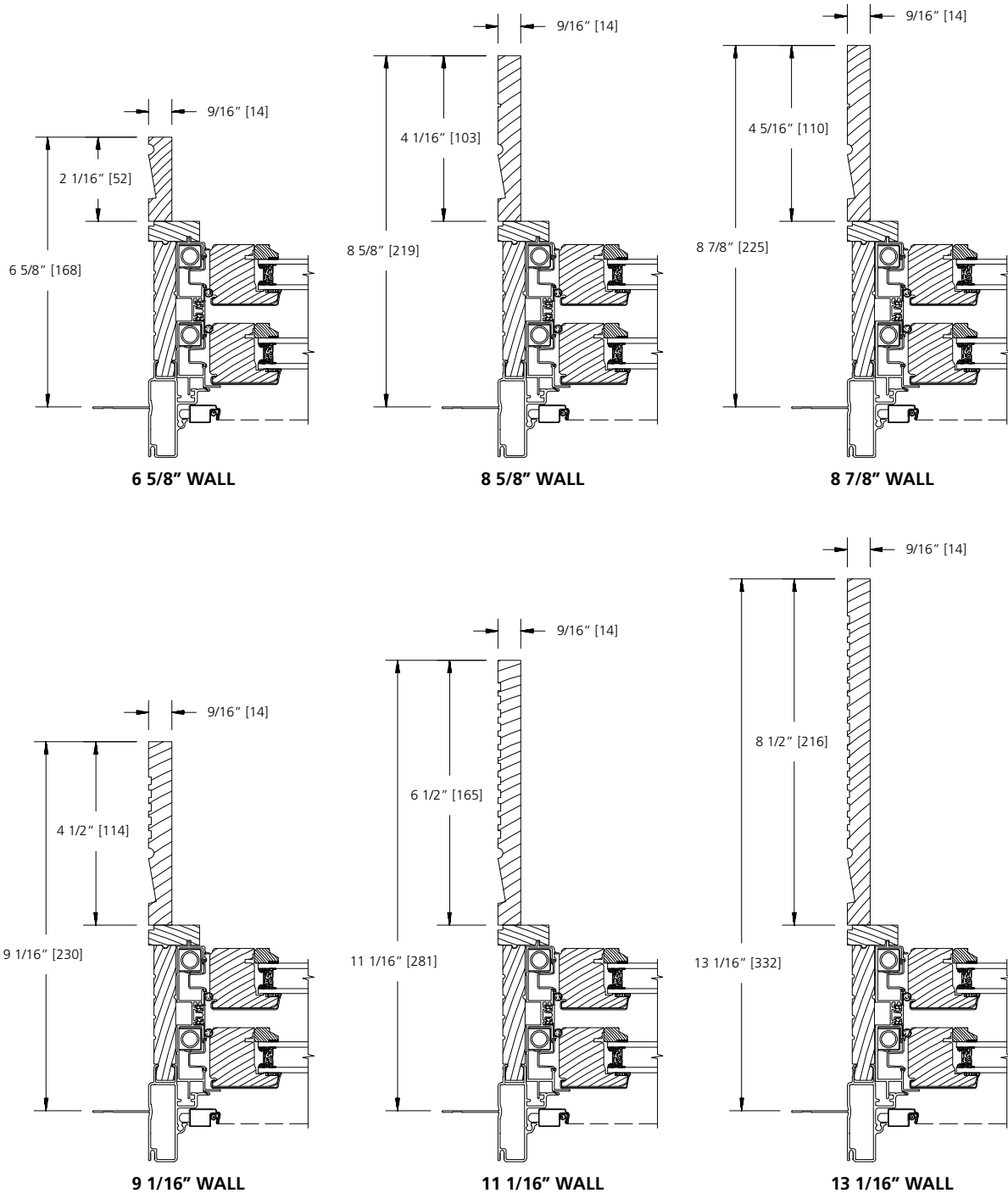

THESE OPTIONS ARE NOT AVAILABLE FOR THE DOUBLE HUNG POCKET WINDOW.

SCALE: 3" = 1'

STANDARD MULLION OPTIONS

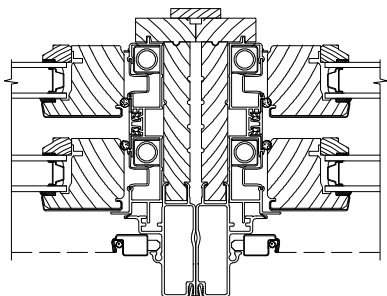

TWIN OPERATING DOUBLE HUNG

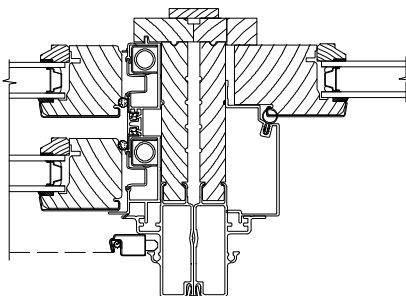

OPERATING DOUBLE HUNG  
NEXT TO DOUBLE HUNG PICTURE

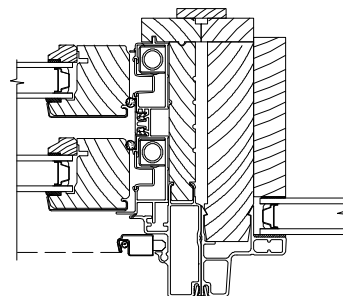

OPERATING DOUBLE HUNG  
NEXT TO DIRECT SET

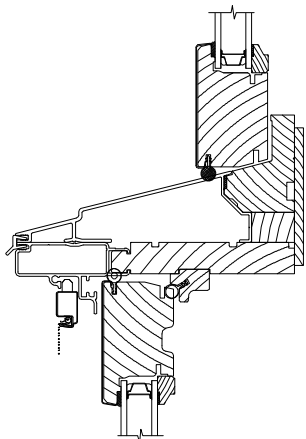

DOUBLE HUNG TRANSOM  
OVER DOUBLE HUNG

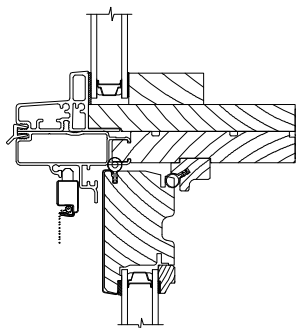

DIRECT SET RADIUS  
OVER DOUBLE HUNG

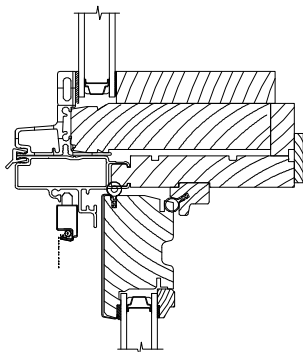

DIRECT SET EXTENDED RADIUS  
OVER DOUBLE HUNG

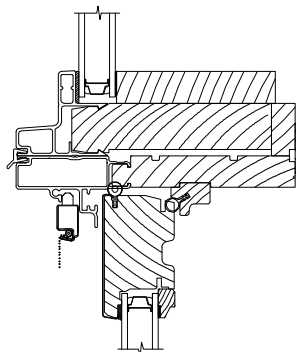

DIRECT SET GEOMETRIC  
OVER DOUBLE HUNG

SCALE: 3" = 1'



STANDARD MULLION OPTIONS

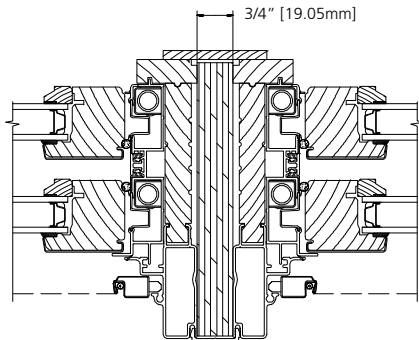

3/4" WOOD SPREAD MULL

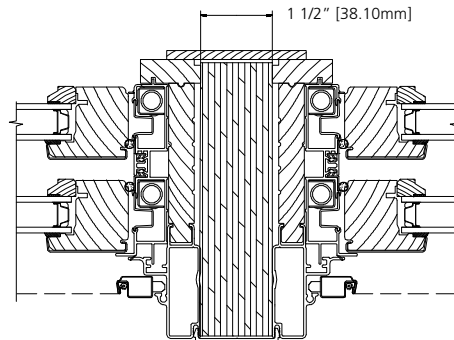

1 1/2" WOOD SPREAD MULL

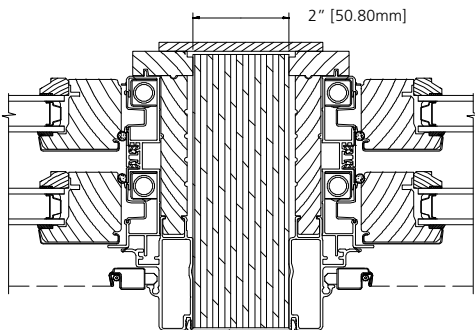

2" WOOD SPREAD MULL

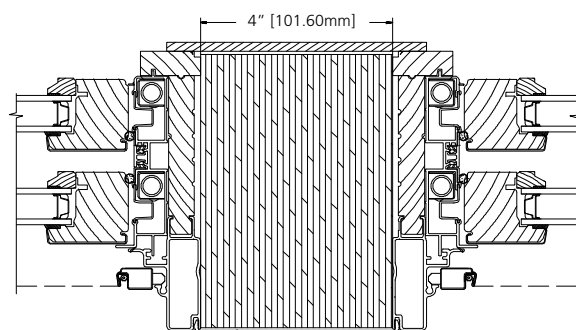

4" WOOD SPREAD MULL

**LITE CUT INFORMATION**

Clad double-hung windows are available with removable grilles in 7/8", 1-1/8" and 1-3/8" widths, grilles between the glass (GBG) and Simulated Divided Lites. Standard lite cuts are rectangular.

**LITE CUT OPTIONS**

Special lite cut patterns can include a wide variety of straight line and radius patterns. The illustrations shown here represent just a few of the possibilities. Rectangular, horizontal, vertical and Prairie lite patterns are available in all standard size clad double-hung windows. Uneven, diamond, radius and Gothic lite cuts are available, subject to approval. Approvals are based on the ability to fulfill the design requirement while maintaining the construction integrity of the finished product.

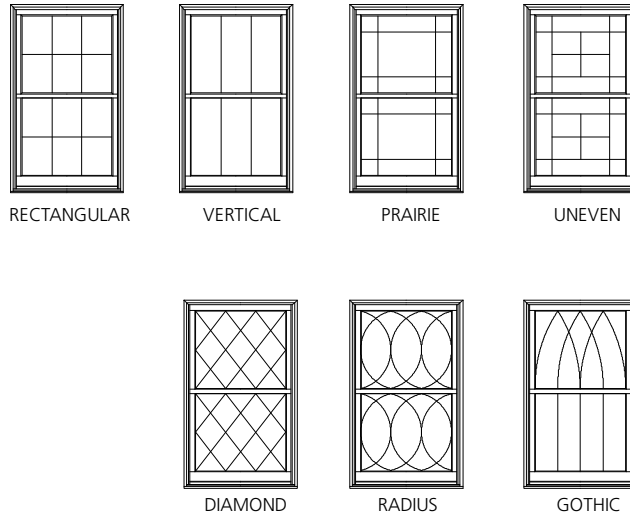

**BAR ALIGNMENT**

Alignment of divided lite muntin bars from one window to the next is often required by fine architectural design. Wood grilles, GBG (Grilles between the Glass), and Simulated Divided Lites may be specified with muntin bars aligned.

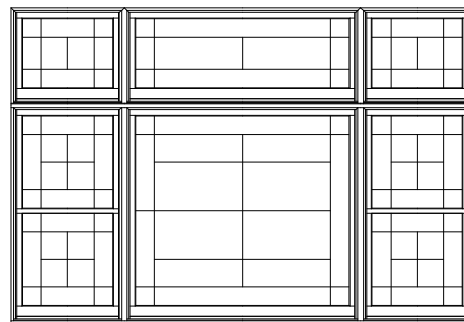

**DIVIDED LITE OPTIONS**

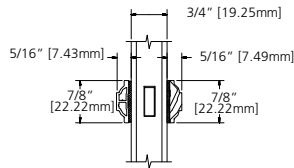

**7/8" SDL**

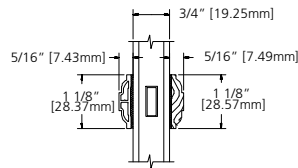

**1 1/8" SDL**

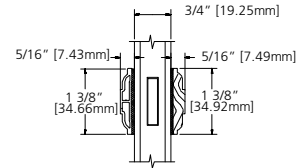

**1 3/8" SDL**

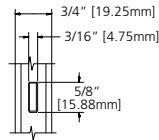

**5/8" GRILLE**

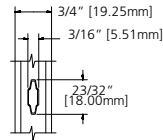

**23/32" GRILLE**

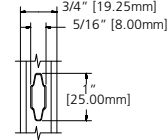

**1" GRILLE**

**UNIT SIZING, ROUGH OPENINGS  
& MASONRY OPENINGS**

**STANDARD OFFERING**

DRIP CAP & NAILING FLANGE

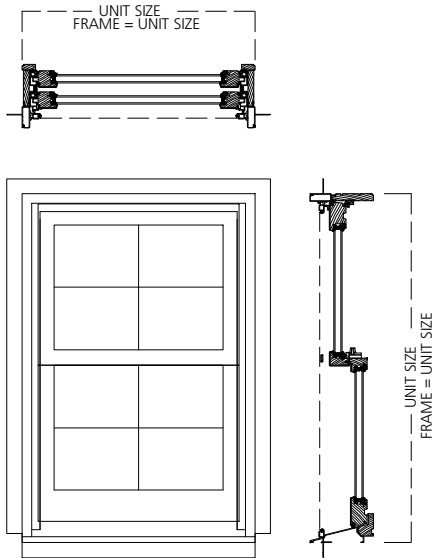

**GENERAL NOTES:**

UNITS WITH NO TRIM AND SILL NOSE:  
UNIT SIZE = FRAME SIZE

UNIT SIZE IS ALWAYS THE  
EXTREME SIZE OF THE WINDOW  
WITH OR WITHOUT TRIM  
(DRIP CAP & NAILING FLANGE ARE  
NOT ADDED TO ANY UNIT SIZING)

MASONRY OPENING:  
MASONRY OPENING IS ALWAYS 1/2" OVER  
THE UNIT SIZE OF THE WINDOW

**ROUGH OPENING:**

ROUGH OPENING IS ALWAYS 3/4" OVER  
FRAME SIZE OF THE WINDOW

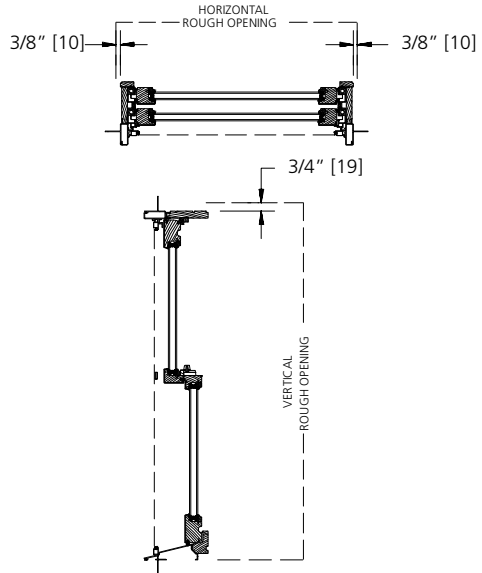

**NON-STANDARD UNIT SIZING**

EXTERIOR TRIM OFFERINGS WITH SILL NOSE  
EXTERIOR TRIM MUST USE SILL NOSE

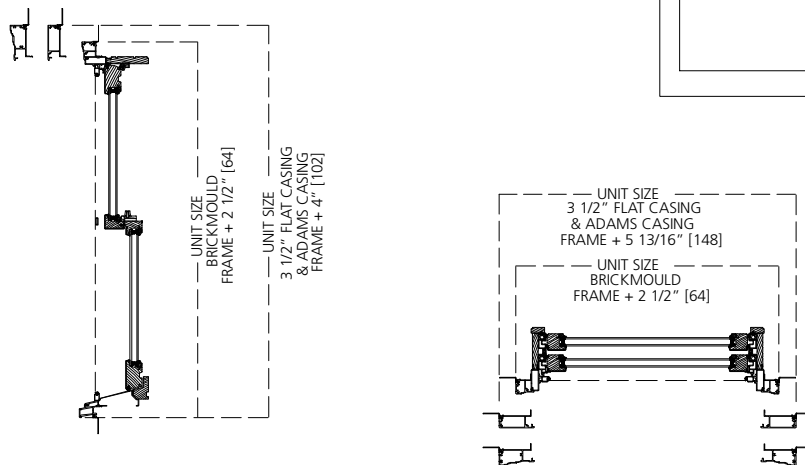

**FRAME TO TRIM DIMENSIONS**

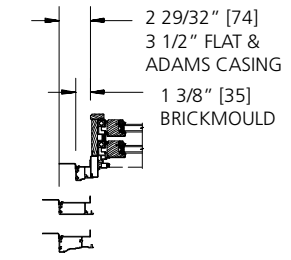

TYPICAL FOR HEAD & SIDES

**1-WIDE UNIT**

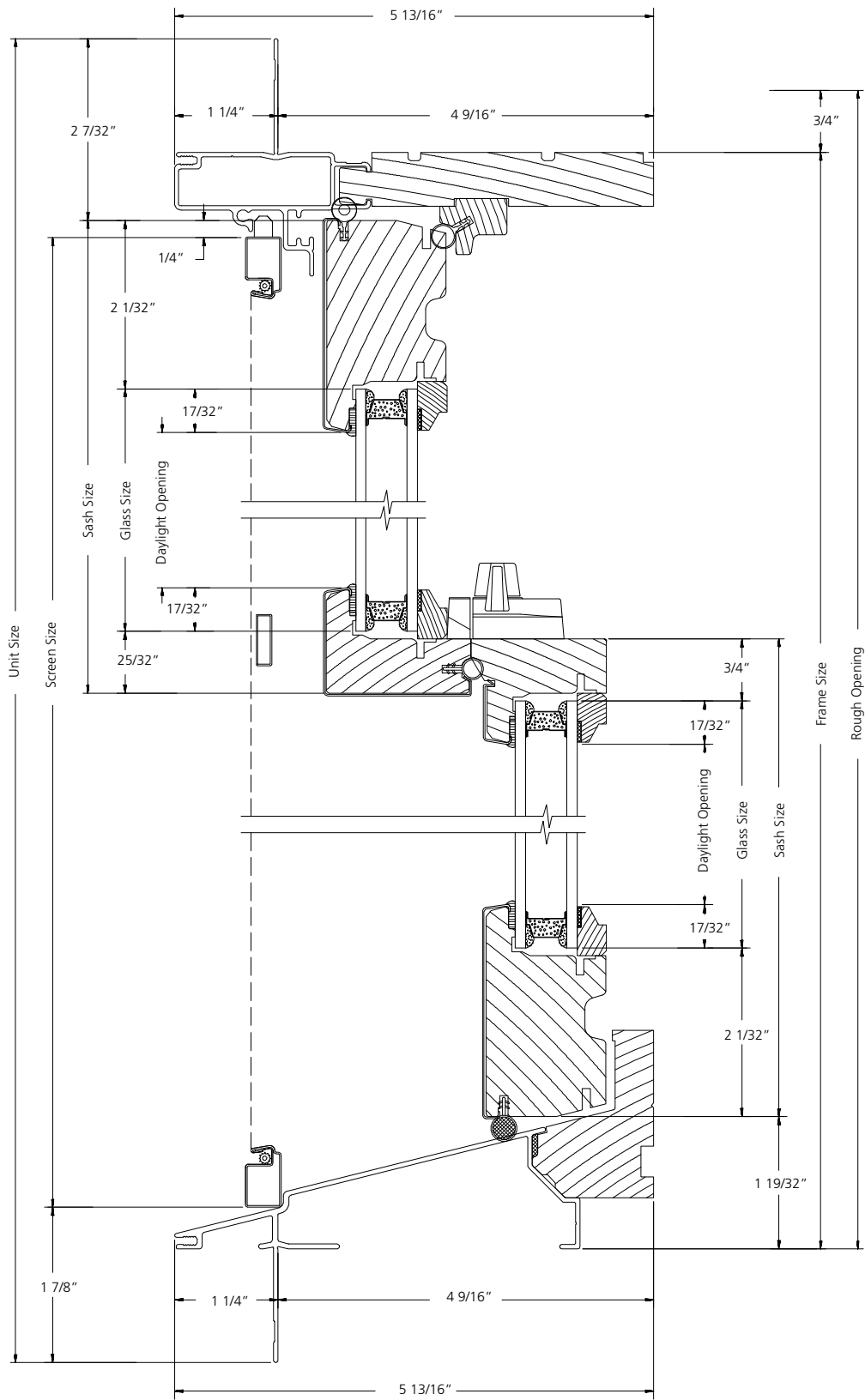

**VERTICAL SECTION**

SCALE: 6" = 1'

**1-WIDE UNIT**

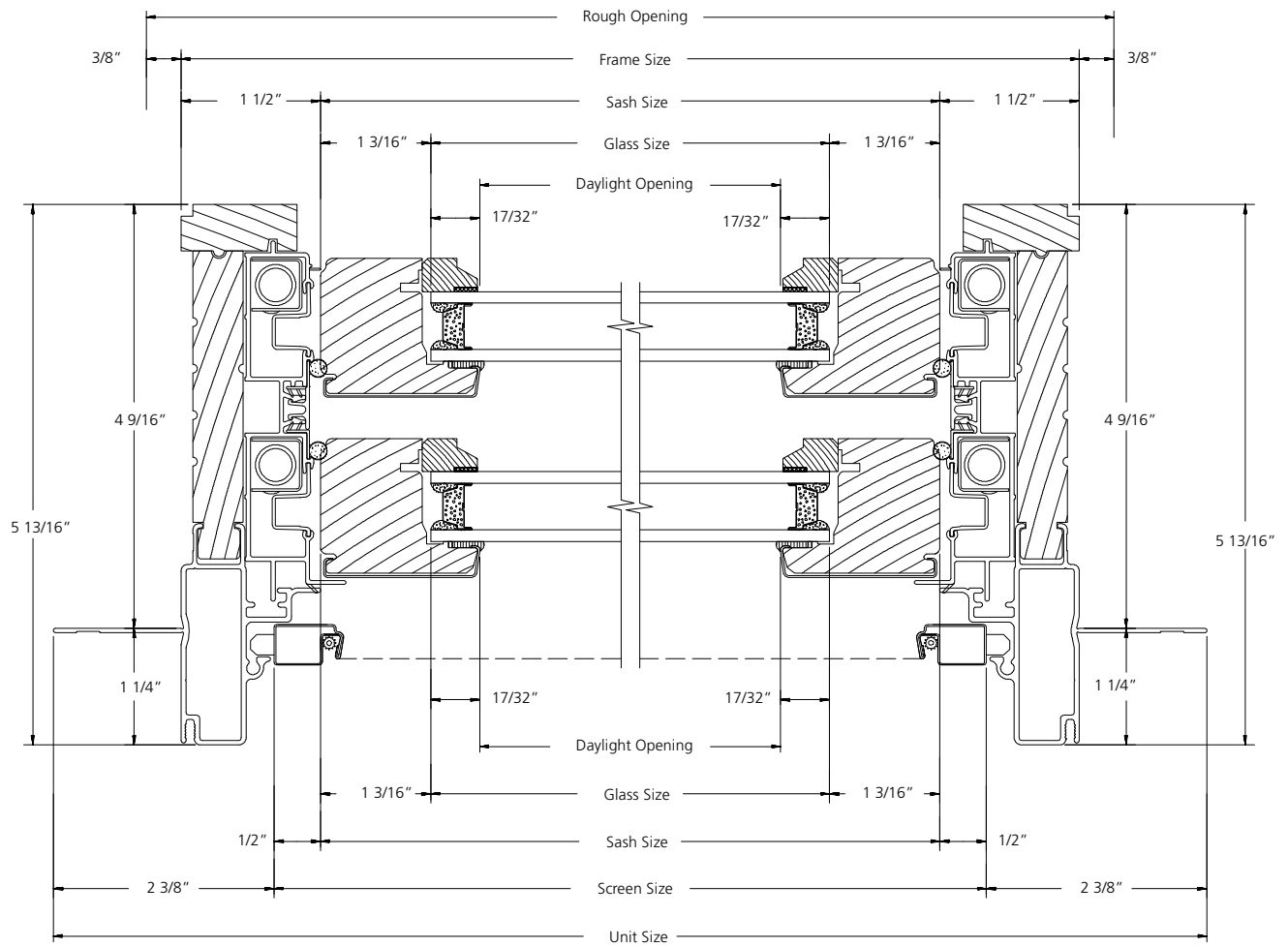

**HORIZONTAL SECTION**

SCALE: 6" = 1'

**COMBINATION UNIT**

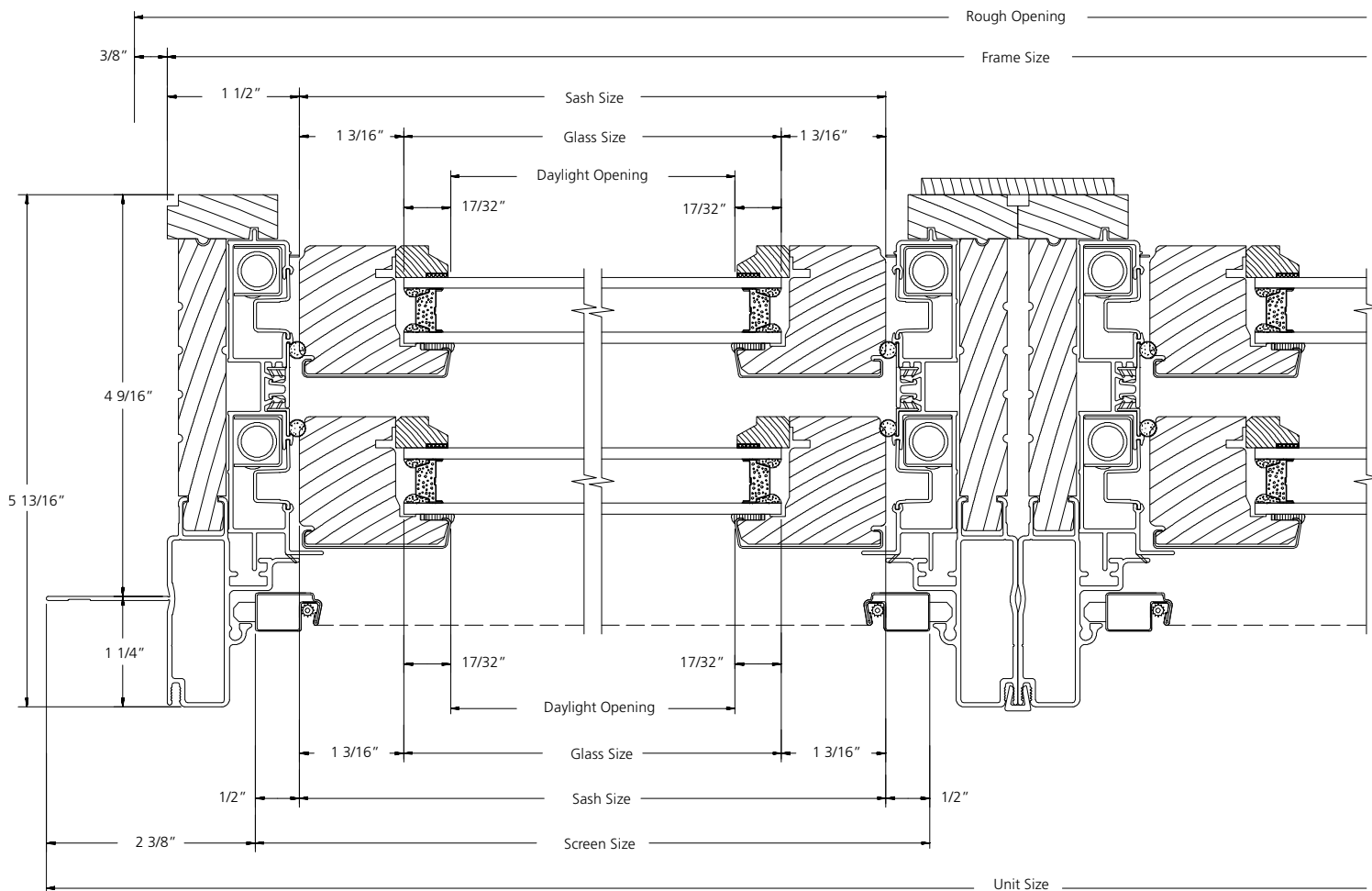

**HORIZONTAL SECTION**

SCALE: 6" = 1'

PICTURE UNIT

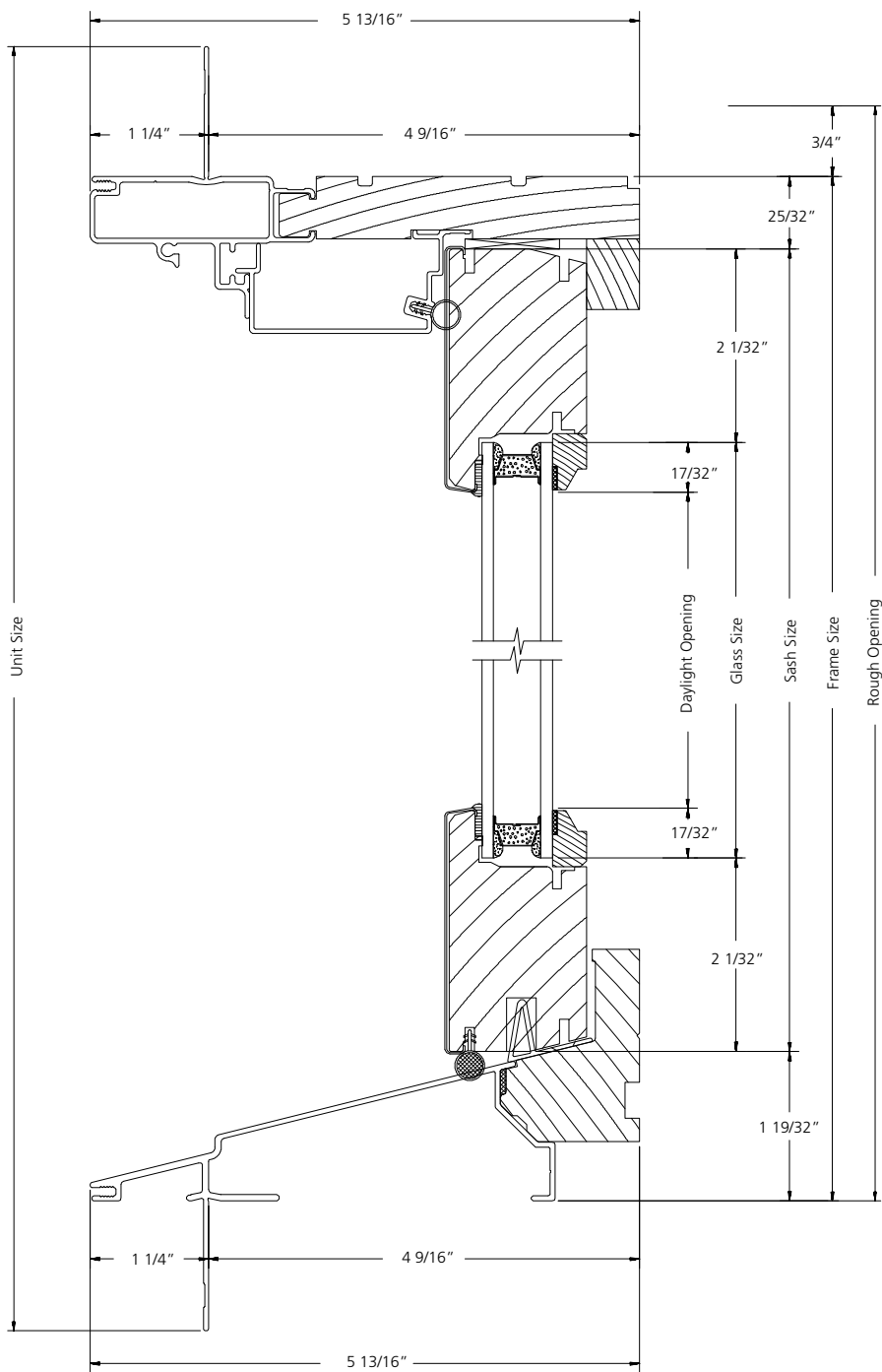

VERTICAL SECTION

SCALE: 6" = 1'



**PICTURE UNIT**

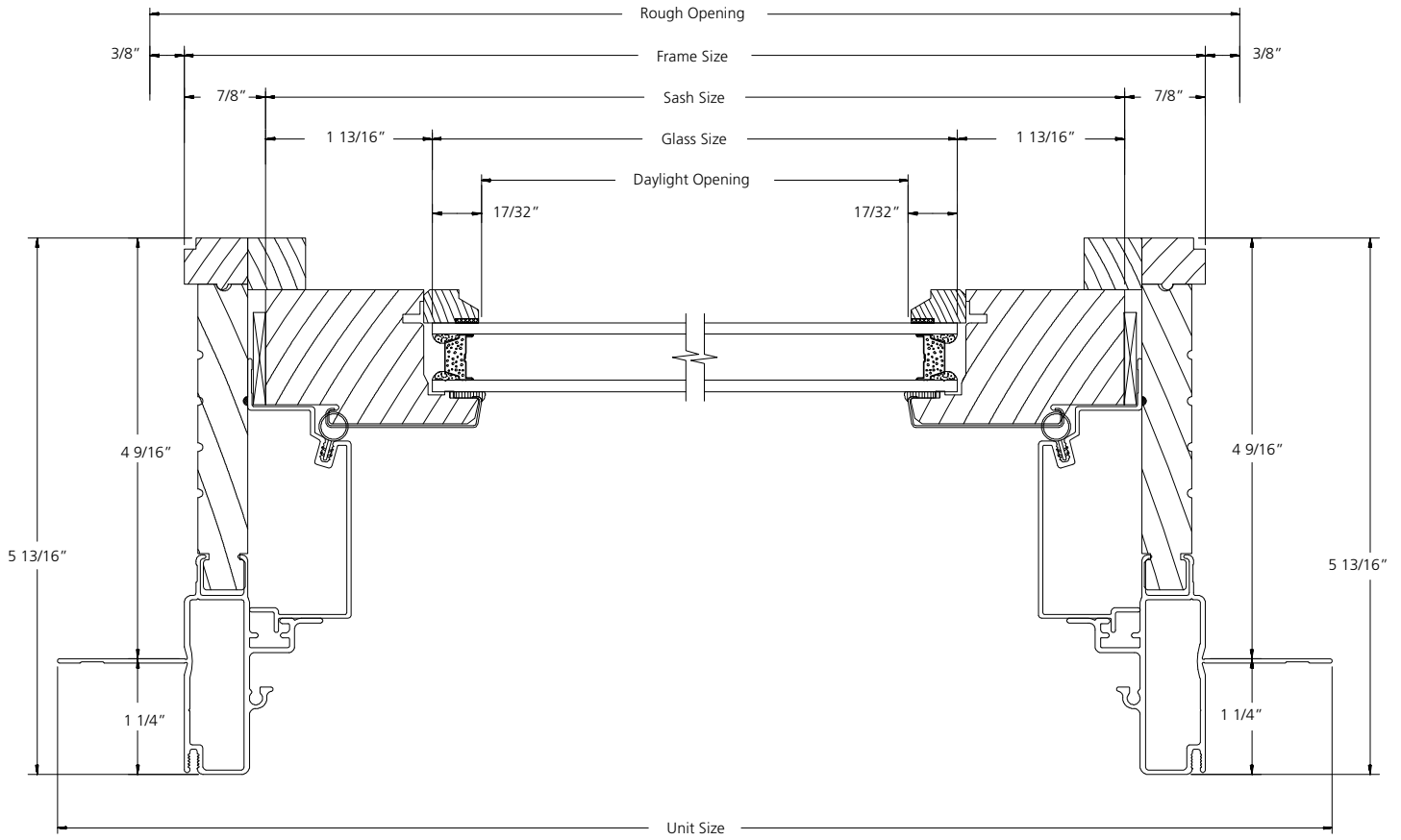

**HORIZONTAL SECTION**

SCALE: 6" = 1'

PICTURE UNIT WITH FLANKERS

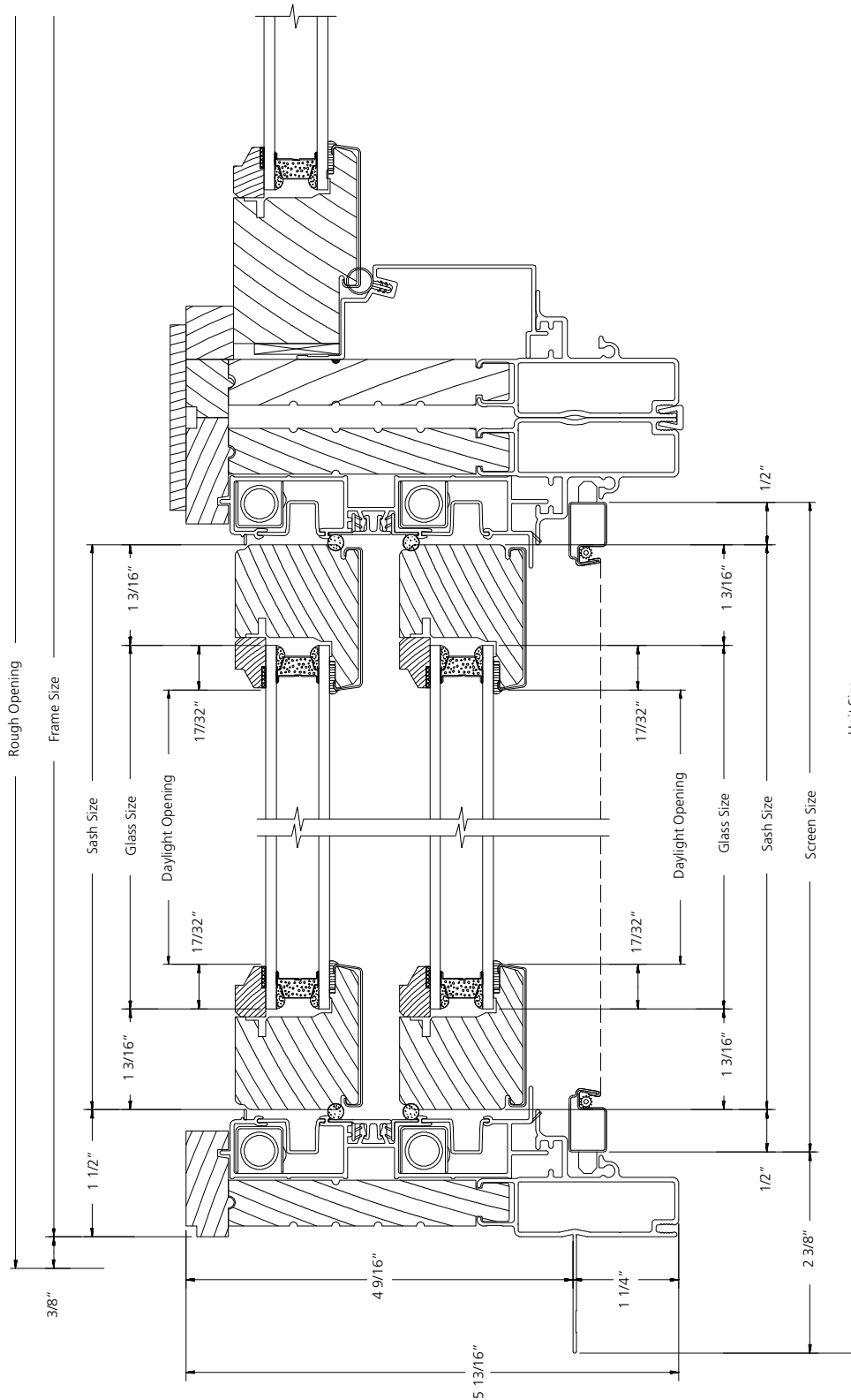

HORIZONTAL SECTION

SCALE: 6" = 1'

**TRANSOM UNIT**

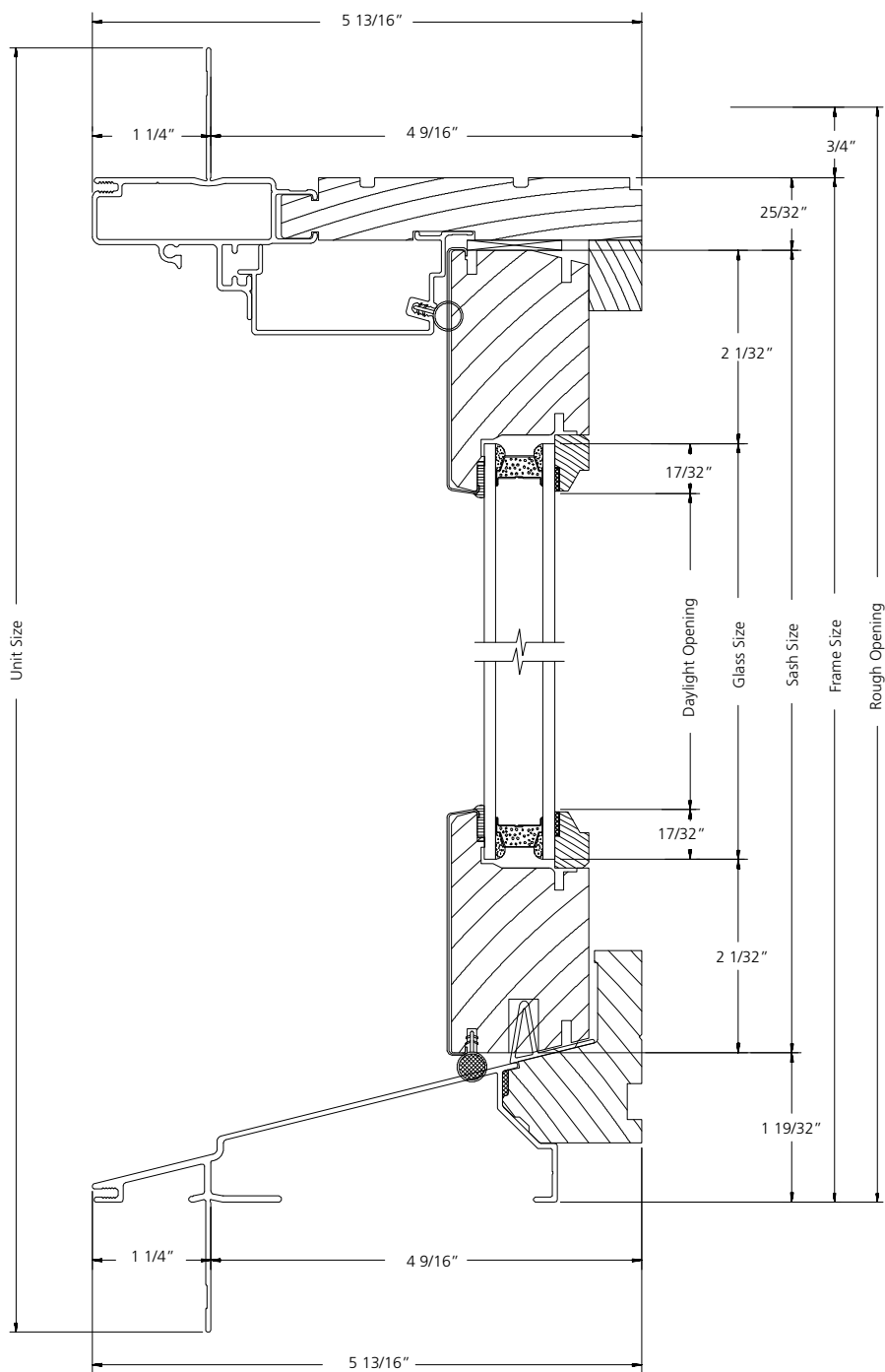

**VERTICAL SECTION**

SCALE: 6" = 1'

**TRANSOM UNIT**

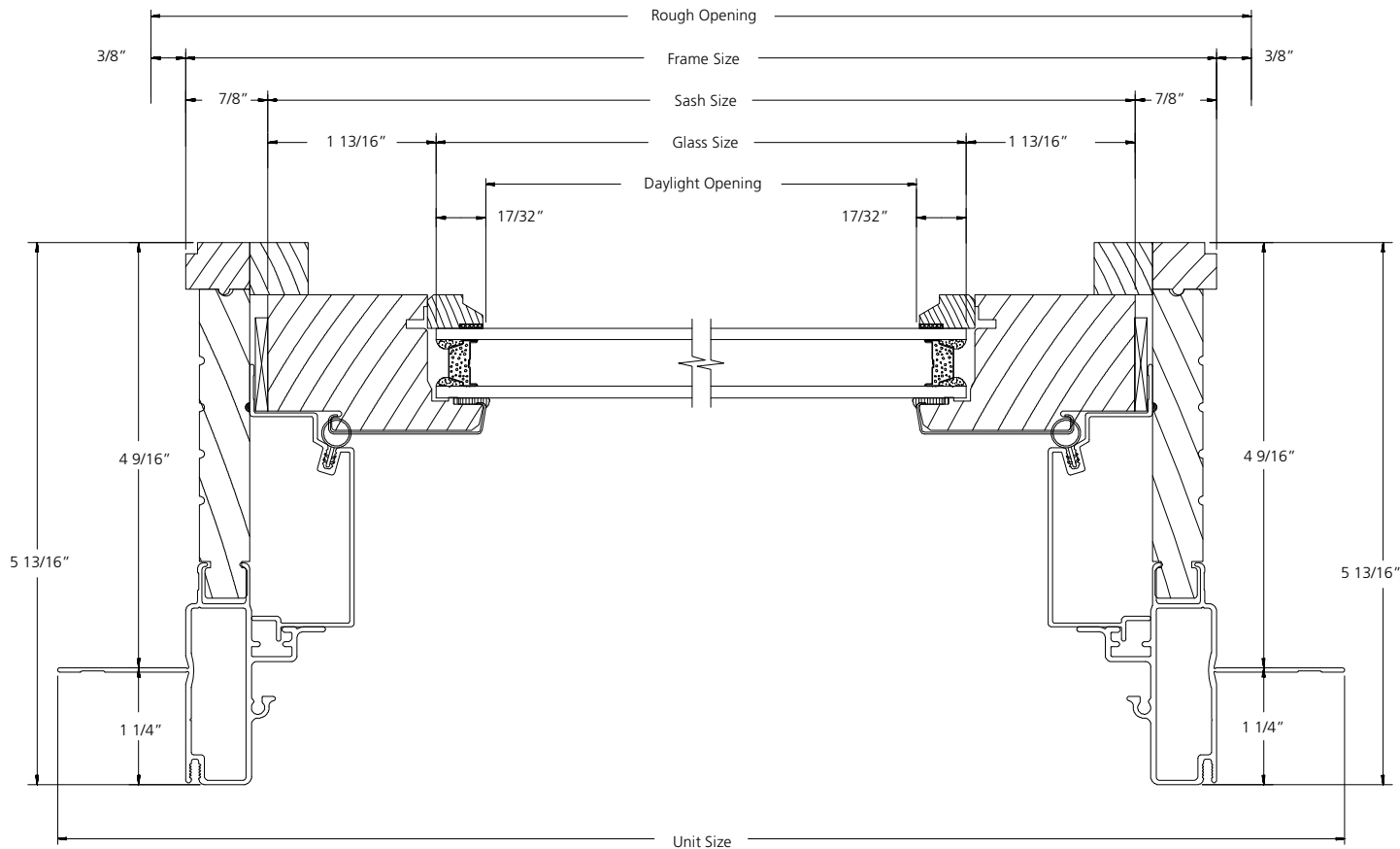

**HORIZONTAL SECTION**

SCALE: 6" = 1'

**POCKET WINDOW  
DOUBLE-HUNG**

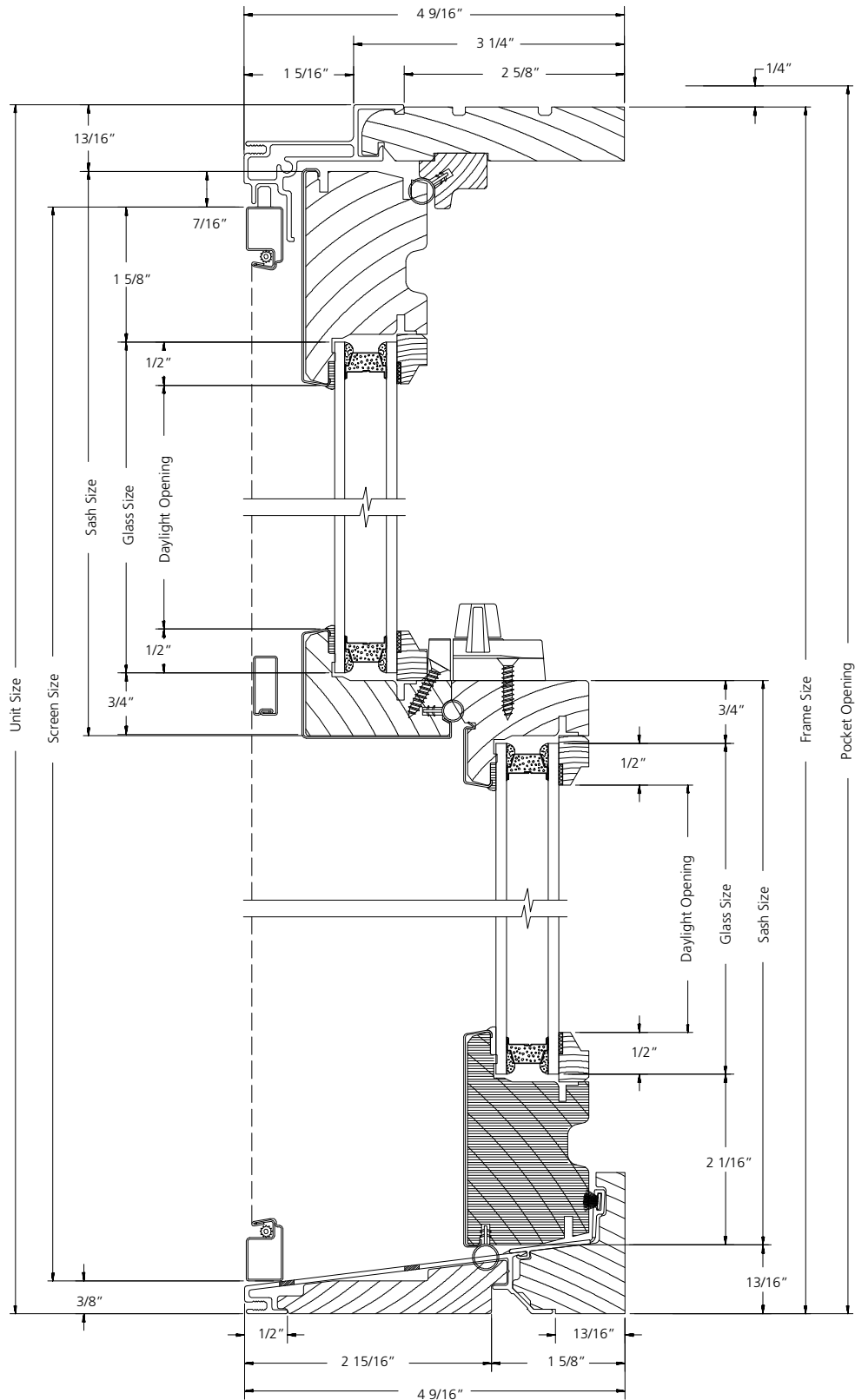

**VERTICAL SECTION**

SCALE: 6" = 1'

**POCKET WINDOW  
DOUBLE-HUNG**

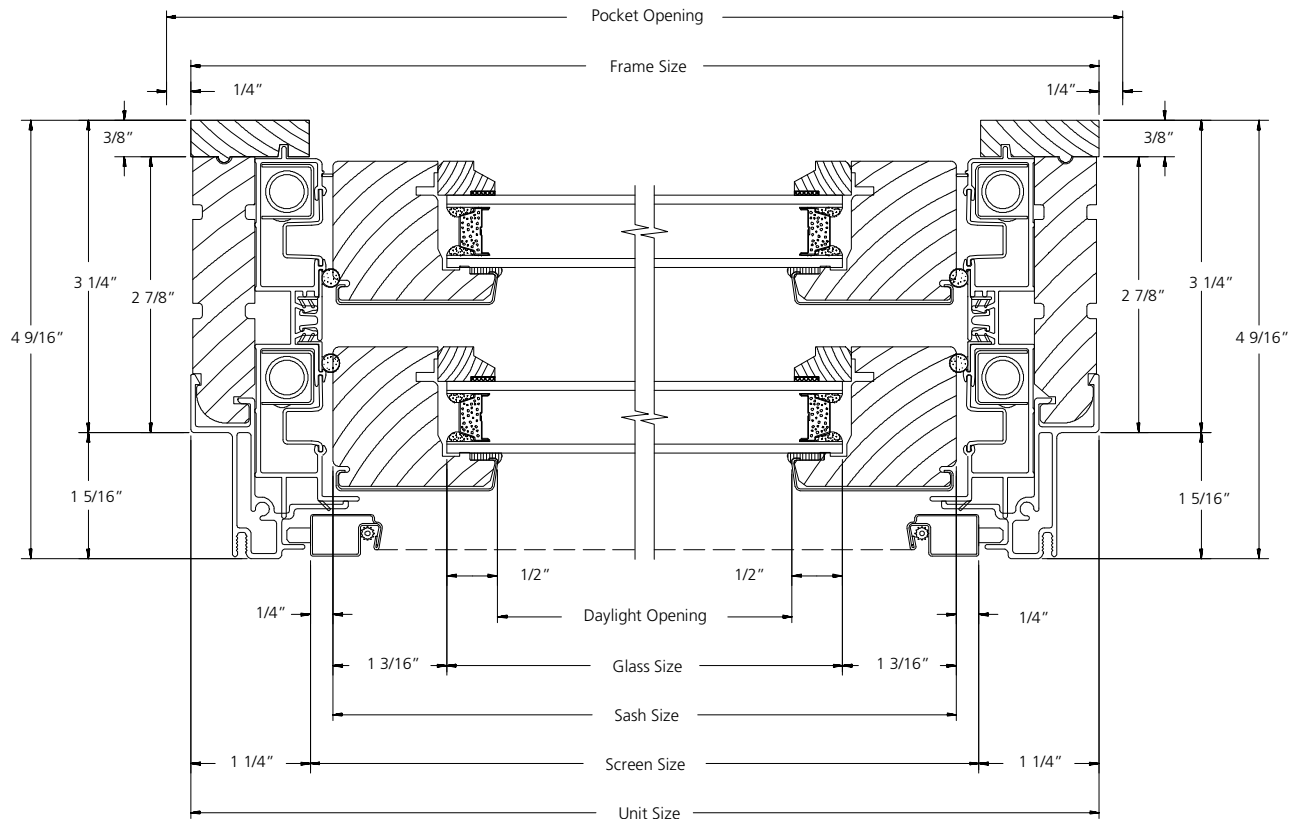

**HORIZONTAL SECTION**

SCALE: 6" = 1'

**POCKET WINDOW  
PICTURE**

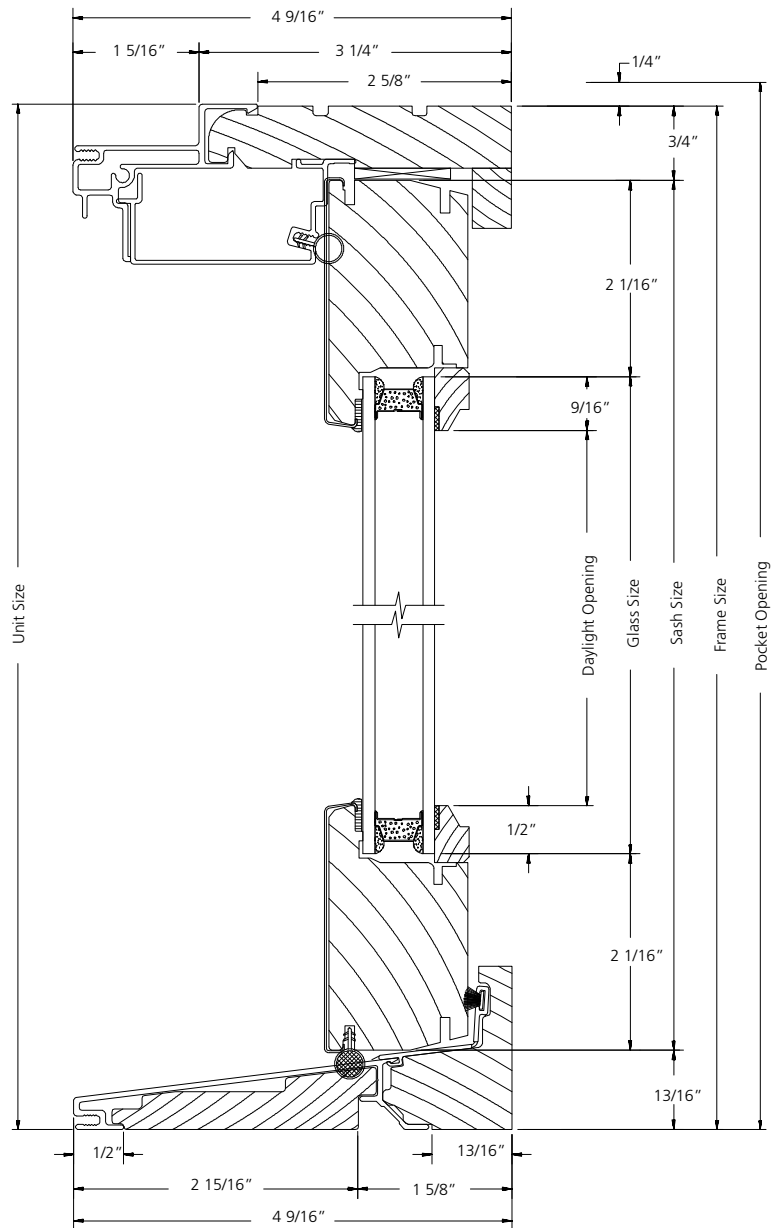

**VERTICAL SECTION**

SCALE: 6" = 1'

**POCKET WINDOW  
PICTURE**

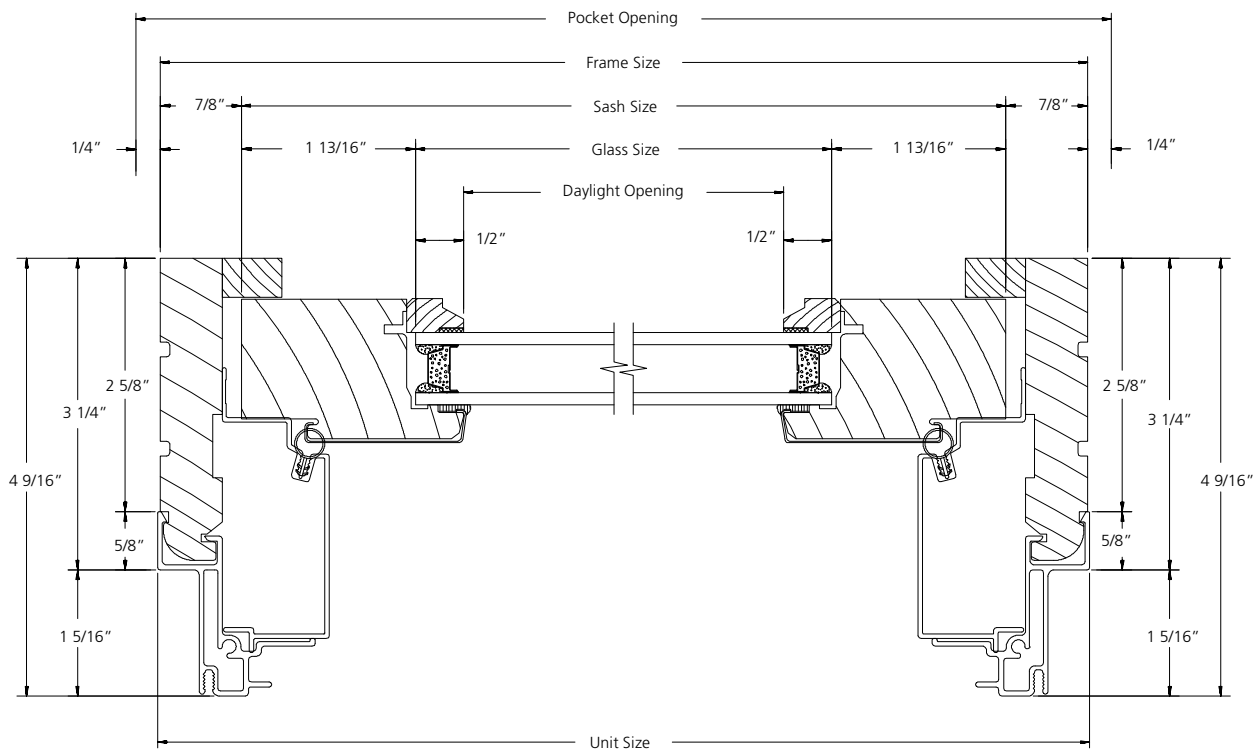

**HORIZONTAL SECTION**

SCALE: 6" = 1'



**BAY WINDOW ROUGH OPENINGS**

**BAY WINDOW TRIM OPTIONS**

The standard offerings for clad double-hung bay windows is 'frame only' and brickmould and sillnose. Other trim options subject to approval.

**VERTICAL ROUGH OPENING**

Rough Opening typical for all Units

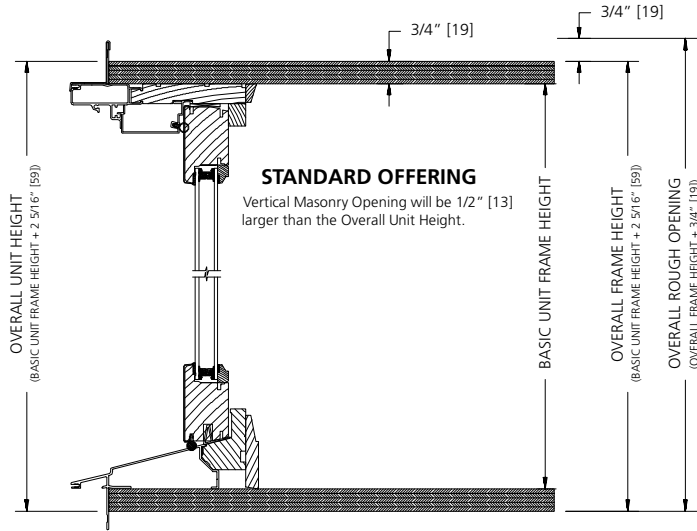

**HORIZONTAL ROUGH OPENING**

Rough Opening typical for all Units

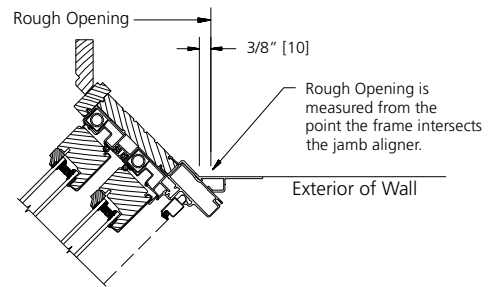

**30° & 45° BAYS**

45° Bay shown without trim

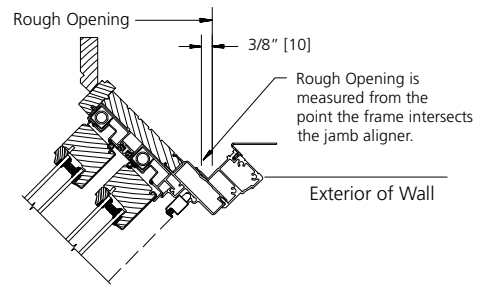
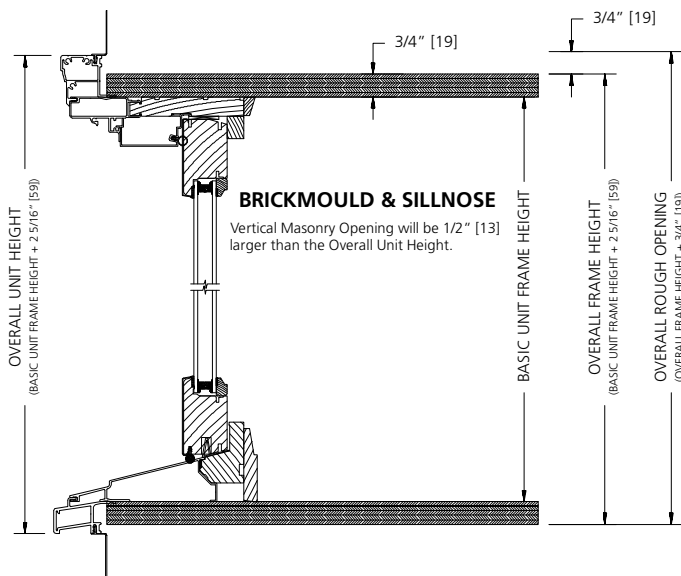

**30° & 45° BAYS**

30° Bay shown with Brickmould

SCALE: 3" = 1'

30° ANGLE BAY UNIT

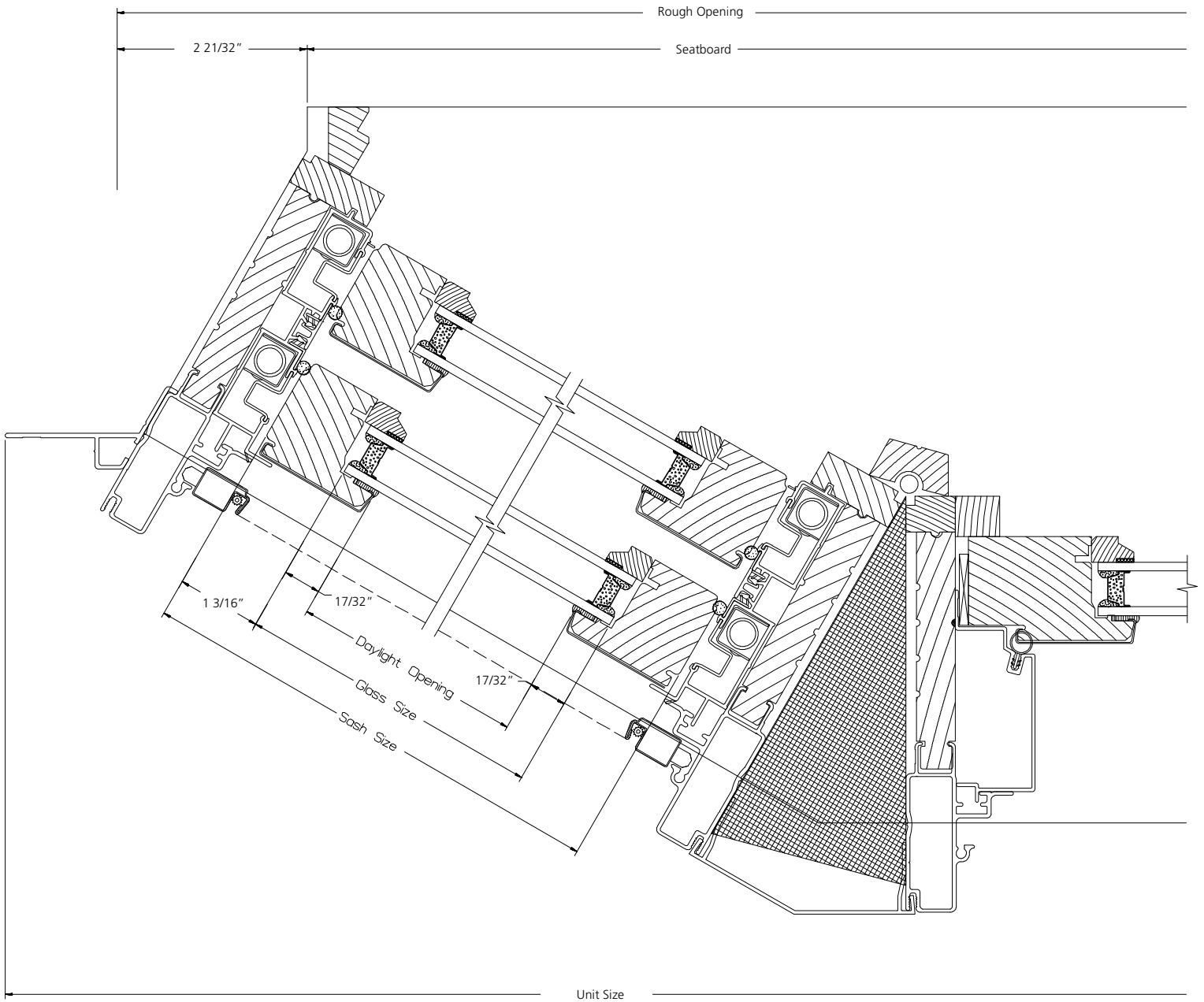

HORIZONTAL SECTION

SCALE: 6" = 1'

**45° ANGLE BAY UNIT**

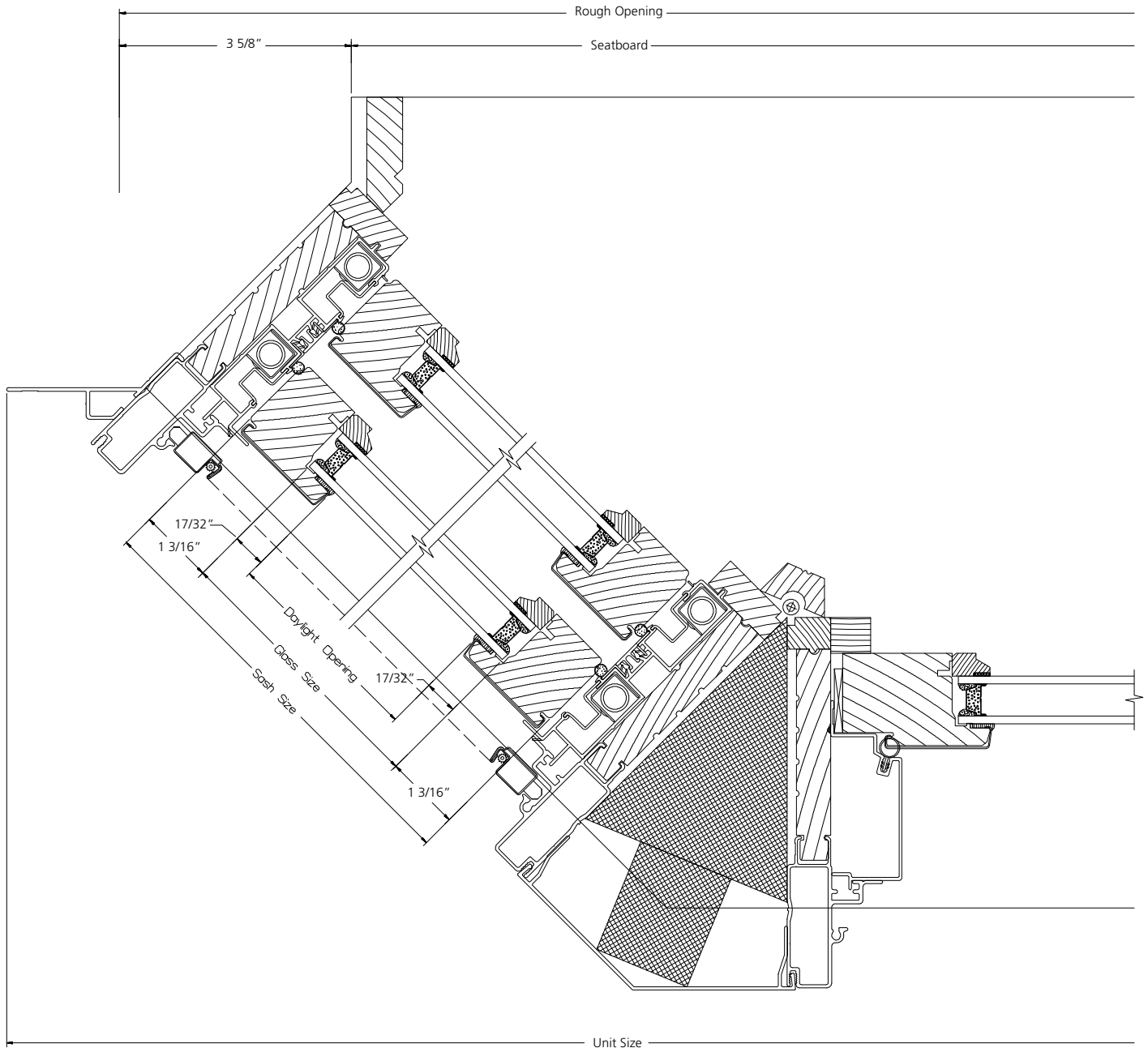

**HORIZONTAL SECTION**

SCALE: 6" = 1'