TABLE OF CONTENTS

Elevations: 1/8" Scale

2-6 Width Door

2, 3 & 4 Door Configurations

5 Door Configurations

6 Door Configurations

7 Door Configurations

8 Door Configurations

2-8 Width Door

2, 3 & 4 Door Configurations

5 Door Configurations

6 Door Configurations

7 Door Configurations

8 Door Configurations

3-0 Width Door

2, 3 & 4 Door Configurations

5 Door Configurations

6 Door Configurations

7 Door Configurations

8 Door Configurations

3-6 Width Door

2, 3 & 4 Door Configurations

5 Door Configurations

6 Door Configurations

7 Door Configurations

8 Door Configurations

Section Details

EXTERIOR FOLDING SYSTEM NOTES

All elevations viewed from exterior.

Hinges, flushbolts & carrier hardware included. Lockets not included, but available at an additional charge.

Frame Height = Door Height + 3 9/16"
 Standard Frame Heights:
 80" Door - 83 9/16" Frame
 84" Door - 87 9/16" Frame
 96" Door - 99 9/16" Frame
 108" Door - 111 9/16" Frame
 120" Door - 123 9/16" Frame

* Indicates a system configuration that does not require a lock. These systems will not be accessible from the exterior when the flushbolts are engaged, therefore are not recommended unless an additional exit door is nearby. Dummy trim set options are available.

^ Indicates a system configuration that will require an active lock only. The end panel will be active (manned door).

**^ Indicates a system configuration that will require an active lock and an optional dummy trim set. In odd-odd configurations, the customer may choose which door will be active (manned door). In odd-even configurations, the leading odd panel will be active (manned door).

2 DOOR CONFIGURATIONS

2L*

Frame Width:
62 5/16" [1583]
With Raised Moulding

62 1/4" [1581]
No Raised Moulding

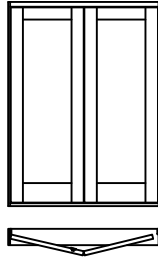

2R*

Frame Width:
62 5/16" [1583]
With Raised Moulding

62 1/4" [1581]
No Raised Moulding

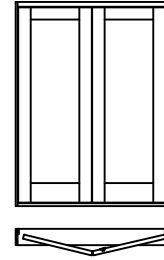

3 DOOR CONFIGURATIONS

2L1R**^

Frame Width:
92 5/8" [2353]
With Raised Moulding

92 1/2" [2350]
No Raised Moulding

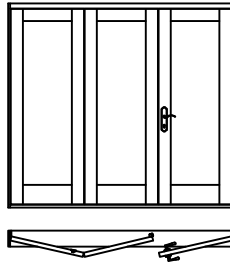

1L2R**^

Frame Width:
92 5/8" [2353]
With Raised Moulding

92 1/2" [2350]
No Raised Moulding

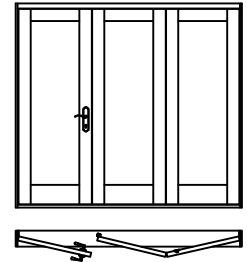

3L^

Frame Width:
92 3/8" [2346]
With Raised Moulding

92 1/4" [2343]
No Raised Moulding

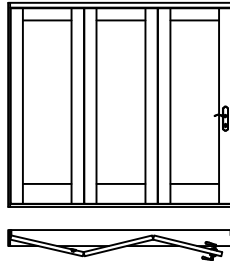

3R^

Frame Width:
92 3/8" [2346]
With Raised Moulding

92 1/4" [2343]
No Raised Moulding

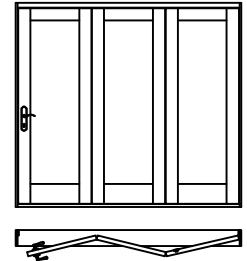

4 DOOR CONFIGURATIONS

2L2R*

Frame Width:
122 15/16" [3123]
With Raised Moulding

122 13/16" [3119]
No Raised Moulding

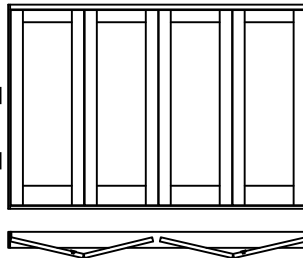

3L1R**^

Frame Width:
122 11/16" [3116]
With Raised Moulding

122 9/16" [3113]
No Raised Moulding

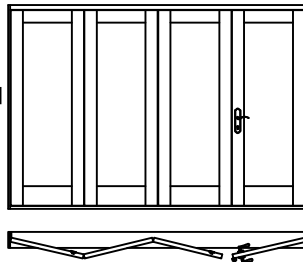

1L3R**^

Frame Width:
122 11/16" [3116]
With Raised Moulding

122 9/16" [3113]
No Raised Moulding

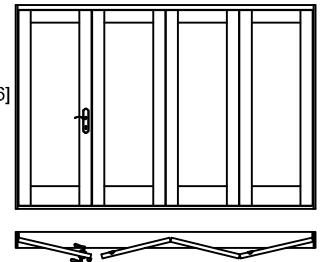

4L*

Frame Width:
122 11/16" [3116]
With Raised Moulding

122 9/16" [3113]
No Raised Moulding

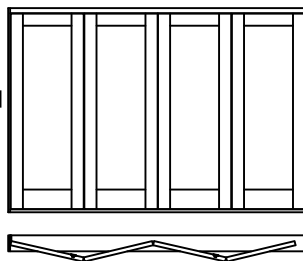

4R*

Frame Width:
122 11/16" [3116]
With Raised Moulding

122 9/16" [3113]
No Raised Moulding

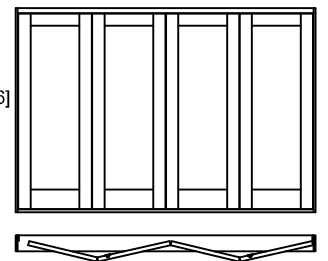

EXTERIOR FOLDING SYSTEM NOTES

All elevations viewed from exterior.

Hinges, flushbolts & carrier hardware included. Lockets not included, but available at an additional charge.

Frame Height = Door Height + 3 9/16"
 Standard Frame Heights:
 80" Door - 83 9/16" Frame
 84" Door - 87 9/16" Frame
 96" Door - 99 9/16" Frame
 108" Door - 111 9/16" Frame
 120" Door - 123 9/16" Frame

* Indicates a system configuration that does not require a lock. These systems will not be accessible from the exterior when the flushbolts are engaged, therefore are not recommended unless an additional exit door is nearby. Dummy trim set options are available.

^ Indicates a system configuration that will require an active lock only. The end panel will be active (manned door).

**^ Indicates a system configuration that will require an active lock and an optional dummy trim set. In odd-odd configurations, the customer may choose which door will be active (manned door). In odd-even configurations, the leading odd panel will be active (manned door).

5 DOOR CONFIGURATIONS

1L4R**^

Frame Width:
153" [3886]
With Raised Moulding

152 13/16" [3881]
No Raised Moulding

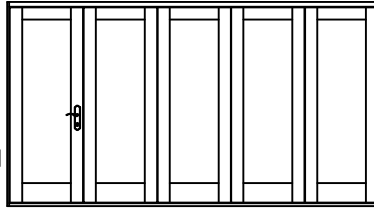

4L1R**^

Frame Width:
153" [3886]
With Raised Moulding

152 13/16" [3881]
No Raised Moulding

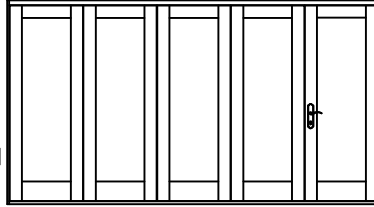

2L3R**^

Frame Width:
153" [3886]
With Raised Moulding

152 13/16" [3881]
No Raised Moulding

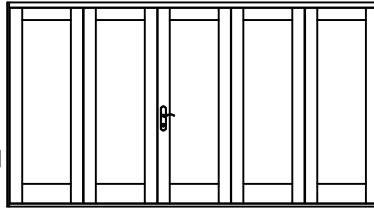

3L2R**^

Frame Width:
153" [3886]
With Raised Moulding

152 13/16" [3881]
No Raised Moulding

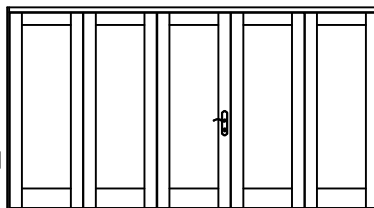

5L^

Frame Width:
152 3/4" [3880]
With Raised Moulding

152 9/16" [3875]
No Raised Moulding

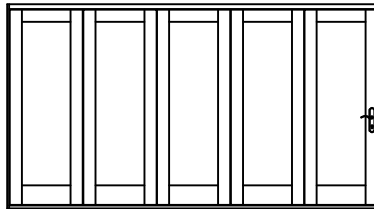

5R^

Frame Width:
152 3/4" [3880]
With Raised Moulding

152 9/16" [3875]
No Raised Moulding

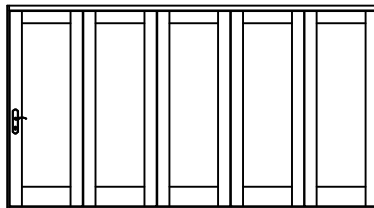

EXTERIOR FOLDING SYSTEM NOTES

All elevations viewed from exterior.

Hinges, flushbolts & carrier hardware included. Lockets not included, but available at an additional charge.

Frame Height = Door Height + 3 9/16"
 Standard Frame Heights:
 80" Door - 83 9/16" Frame
 84" Door - 87 9/16" Frame
 96" Door - 99 9/16" Frame
 108" Door - 111 9/16" Frame
 120" Door - 123 9/16" Frame

* Indicates a system configuration that does not require a lock. These systems will not be accessible from the exterior when the flushbolts are engaged, therefore are not recommended unless an additional exit door is nearby. Dummy trim set options are available.

^ Indicates a system configuration that will require an active lock only. The end panel will be active (manned door).

**^ Indicates a system configuration that will require an active lock and an optional dummy trim set. In odd-odd configurations, the customer may choose which door will be active (manned door). In odd-even configurations, the leading odd panel will be active (manned door).

6 DOOR CONFIGURATIONS

1L5R**^

Frame Width:
183 1/16" [4650]
With Raised Moulding

182 7/8" [4645]
No Raised Moulding

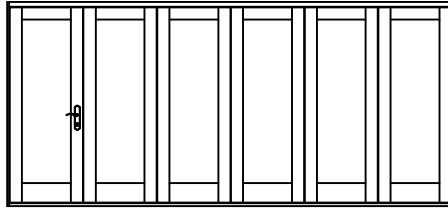

5L1R**^

Frame Width:
183 1/16" [4650]
With Raised Moulding

182 7/8" [4645]
No Raised Moulding

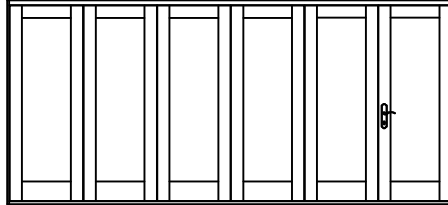

2L4R*

Frame Width:
183 5/16 [4656]
With Raised Moulding

183 1/8" [4651]
No Raised Moulding

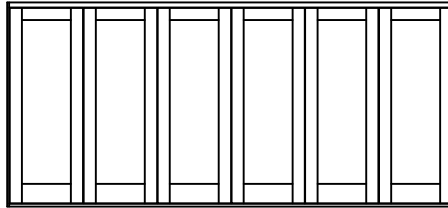

4L2R*

Frame Width:
183 5/16 [4656]
With Raised Moulding

183 1/8" [4651]
No Raised Moulding

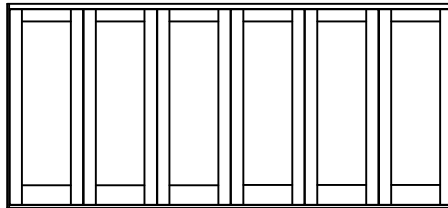

3L3R**^

Frame Width:
183 1/16" [4650]
With Raised Moulding

182 7/8" [4645]
No Raised Moulding

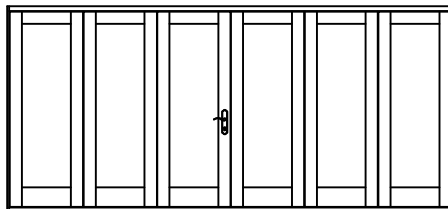

6L*

Frame Width:
183 1/16" [4650]
With Raised Moulding

182 7/8" [4645]
No Raised Moulding

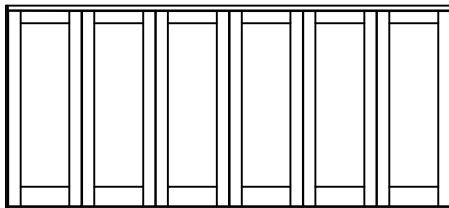

6R*

Frame Width:
183 1/16" [4650]
With Raised Moulding

182 7/8" [4645]
No Raised Moulding

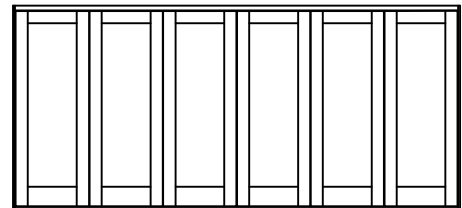

EXTERIOR FOLDING SYSTEM NOTES

All elevations viewed from exterior.

Hinges, flushbolts & carrier hardware included. Lockets not included, but available at an additional charge.

Frame Height = Door Height + 3 9/16"
 Standard Frame Heights:
 80" Door - 83 9/16" Frame
 84" Door - 87 9/16" Frame
 96" Door - 99 9/16" Frame
 108" Door - 111 9/16" Frame
 120" Door - 123 9/16" Frame

* Indicates a system configuration that does not require a lock. These systems will not be accessible from the exterior when the flushbolts are engaged, therefore are not recommended unless an additional exit door is nearby. Dummy trim set options are available.

^ Indicates a system configuration that will require an active lock only. The end panel will be active (manned door).

**^ Indicates a system configuration that will require an active lock and an optional dummy trim set. In odd-odd configurations, the customer may choose which door will be active (manned door). In odd-even configurations, the leading odd panel will be active (manned door).

7 DOOR CONFIGURATIONS

1L6R**^

Frame Width:
 213 3/8" [5420]
 With Raised Moulding

213 1/8" [5413]
 No Raised Moulding

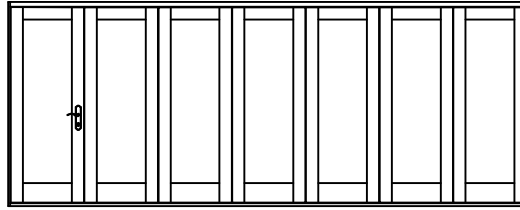

6L1R**^

Frame Width:
 213 3/8" [5420]
 With Raised Moulding

213 1/8" [5413]
 No Raised Moulding

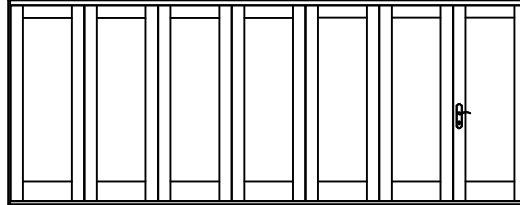

2L5R**^

Frame Width:
 213 3/8" [5420]
 With Raised Moulding

213 1/8" [5413]
 No Raised Moulding

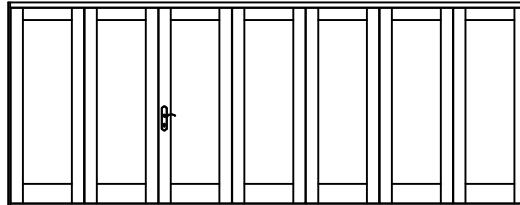

5L2R**^

Frame Width:
 213 3/8" [5420]
 With Raised Moulding

213 1/8" [5413]
 No Raised Moulding

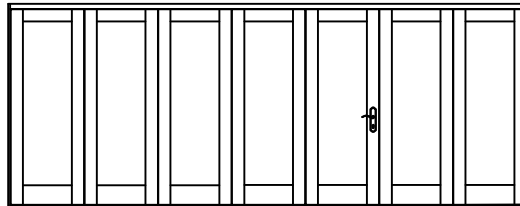

3L4R**^ Frame Width: 213 3/8" [5420] With Raised Moulding
 213 1/8" [5413] No Raised Moulding

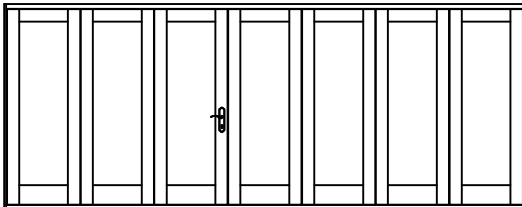

4L3R**^ Frame Width: 213 3/8" [5420] With Raised Moulding
 213 1/8" [5413] No Raised Moulding

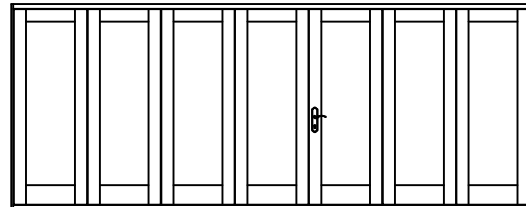

7L^ Frame Width: 213 1/8" [5413] With Raised Moulding
 212 7/8" [5407] No Raised Moulding

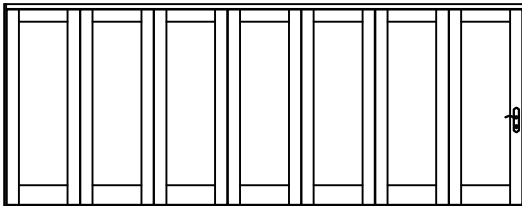

7R^ Frame Width: 213 1/8" [5413] With Raised Moulding
 212 7/8" [5407] No Raised Moulding

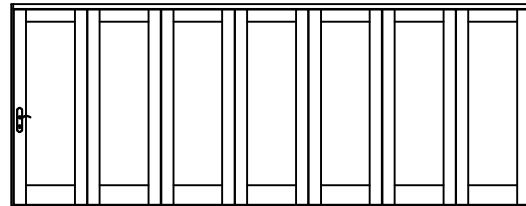

EXTERIOR FOLDING SYSTEM NOTES

All elevations viewed from exterior.

Hinges, flushbolts & carrier hardware included. Lockets not included, but available at an additional charge.

Frame Height = Door Height + 3 9/16"
 Standard Frame Heights:
 80" Door - 83 9/16" Frame
 84" Door - 87 9/16" Frame
 96" Door - 99 9/16" Frame
 108" Door - 111 9/16" Frame
 120" Door - 123 9/16" Frame

* Indicates a system configuration that does not require a lock. These systems will not be accessible from the exterior when the flushbolts are engaged, therefore are not recommended unless an additional exit door is nearby. Dummy trim set options are available.

^ Indicates a system configuration that will require an active lock only. The end panel will be active (manned door).

**^ Indicates a system configuration that will require an active lock and an optional dummy trim set. In odd-odd configurations, the customer may choose which door will be active (manned door). In odd-even configurations, the leading odd panel will be active (manned door).

8 DOOR CONFIGURATIONS

2L6R*

Frame Width:
 243 11/16" [6190]
 With Raised Moulding

243 7/16" [6183]
 No Raised Moulding

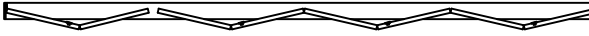
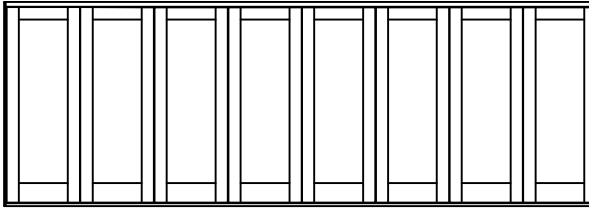

6L2R*

Frame Width:
 243 11/16" [6190]
 With Raised Moulding

243 7/16" [6183]
 No Raised Moulding

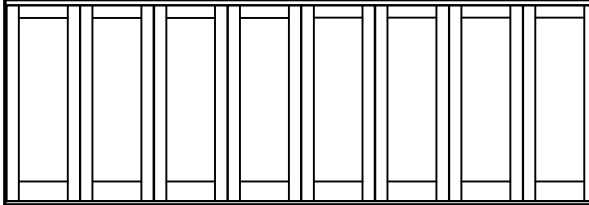

4L4R*

Frame Width:
 243 11/16" [6190]
 With Raised Moulding

243 7/16" [6183]
 No Raised Moulding

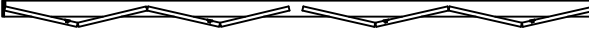
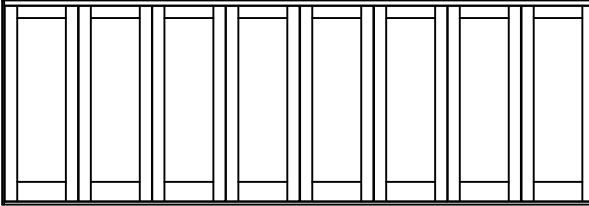

1L7R**^ Frame Width: 243 7/16" [6183] With Raised Moulding
 243 3/16" [6177] No Raised Moulding

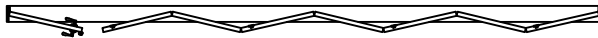
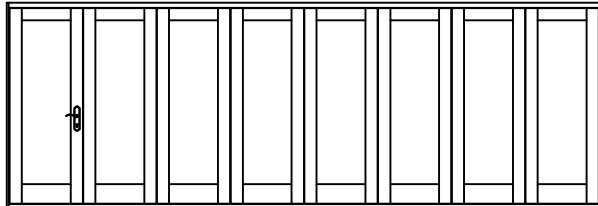

7L1R**^ Frame Width: 243 7/16" [6183] With Raised Moulding
 243 3/16" [6177] No Raised Moulding

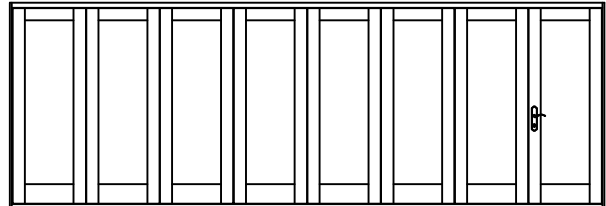

3L5R**^ Frame Width: 243 7/16" [6183] With Raised Moulding
 243 3/16" [6177] No Raised Moulding

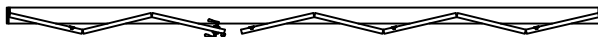
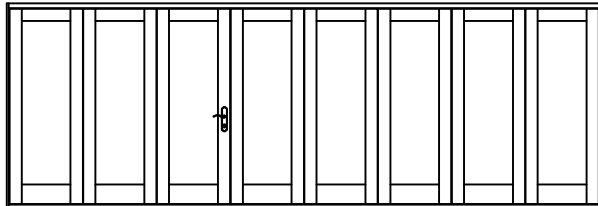

5L3R**^ Frame Width: 243 7/16" [6183] With Raised Moulding
 243 3/16" [6177] No Raised Moulding

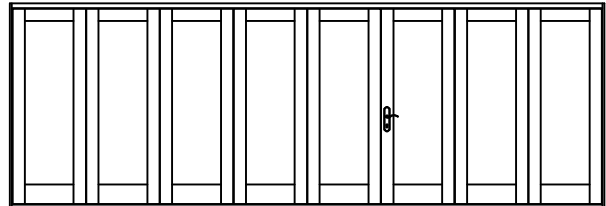

8L* Frame Width: 243 7/16" [6183] With Raised Moulding
 243 3/16" [6177] No Raised Moulding

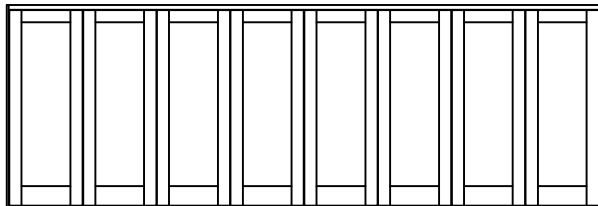

8R* Frame Width: 243 7/16" [6183] With Raised Moulding
 243 3/16" [6177] No Raised Moulding

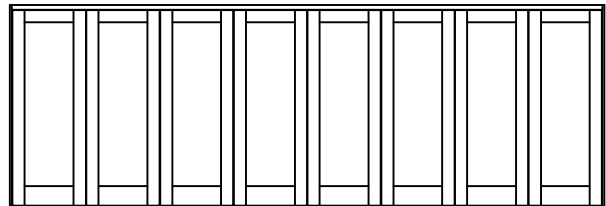

EXTERIOR FOLDING SYSTEM NOTES

All elevations viewed from exterior.

Hinges, flushbolts & carrier hardware included. Lockets not included, but available at an additional charge.

Frame Height = Door Height + 3 9/16"
 Standard Frame Heights:
 80" Door - 83 9/16" Frame
 84" Door - 87 9/16" Frame
 96" Door - 99 9/16" Frame
 108" Door - 111 9/16" Frame
 120" Door - 123 9/16" Frame

* Indicates a system configuration that does not require a lock. These systems will not be accessible from the exterior when the flushbolts are engaged, therefore are not recommended unless an additional exit door is nearby. Dummy trim set options are available.

^ Indicates a system configuration that will require an active lock only. The end panel will be active (manned door).

**^ Indicates a system configuration that will require an active lock and an optional dummy trim set. In odd-odd configurations, the customer may choose which door will be active (manned door). In odd-even configurations, the leading odd panel will be active (manned door).

2 DOOR CONFIGURATIONS

2L*

Frame Width:
66 5/16" [1684]
With Raised Moulding

66 1/4" [1683]
No Raised Moulding

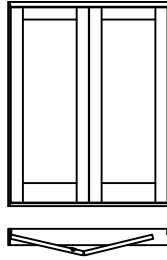

2R*

Frame Width:
66 5/16" [1684]
With Raised Moulding

66 1/4" [1683]
No Raised Moulding

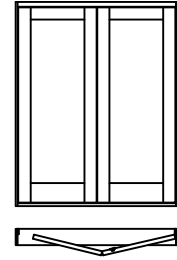

3 DOOR CONFIGURATIONS

2L1R**^

Frame Width:
98 5/8" [2505]
With Raised Moulding

98 1/2" [2502]
No Raised Moulding

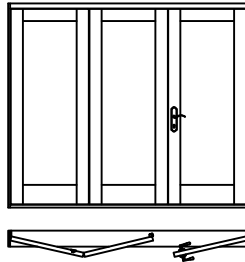

1L2R**^

Frame Width:
98 5/8" [2505]
With Raised Moulding

98 1/2" [2502]
No Raised Moulding

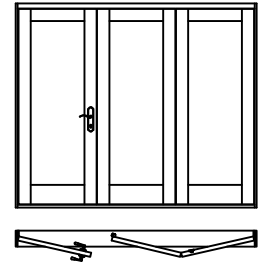

3L^

Frame Width:
98 3/8" [2499]
With Raised Moulding

98 1/4" [2496]
No Raised Moulding

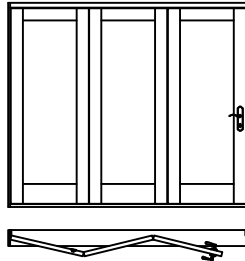

3R^

Frame Width:
98 3/8" [2499]
With Raised Moulding

98 1/4" [2496]
No Raised Moulding

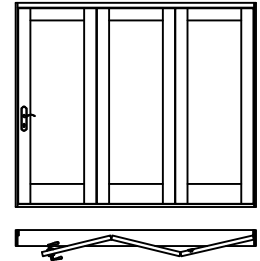

4 DOOR CONFIGURATIONS

2L2R*

Frame Width:
130 15/16" [3326]
With Raised Moulding

130 13/16" [3323]
No Raised Moulding

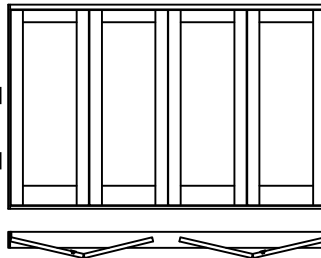

3L1R**^

Frame Width:
130 11/16" [3319]
With Raised Moulding

130 9/16" [3316]
No Raised Moulding

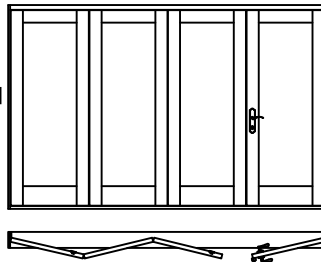

1L3R**^

Frame Width:
130 11/16" [3319]
With Raised Moulding

130 9/16" [3316]
No Raised Moulding

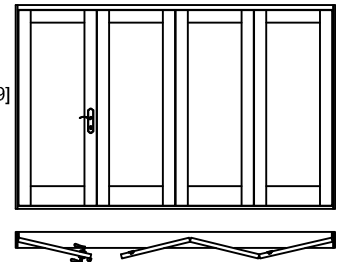

4L*

Frame Width:
130 11/16" [3319]
With Raised Moulding

130 9/16" [3316]
No Raised Moulding

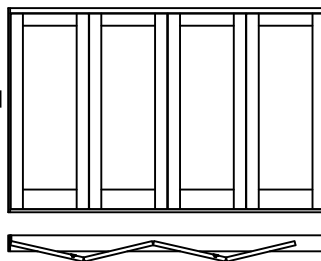

4R*

Frame Width:
130 11/16" [3319]
With Raised Moulding

130 9/16" [3316]
No Raised Moulding

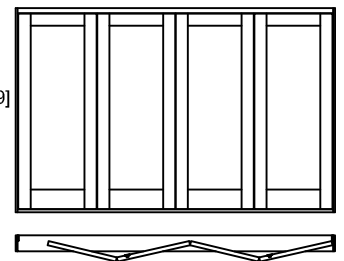

EXTERIOR FOLDING SYSTEM NOTES

All elevations viewed from exterior.

Hinges, flushbolts & carrier hardware included. Lockets not included, but available at an additional charge.

Frame Height = Door Height + 3 9/16"

Standard Frame Heights:

- 80" Door - 83 9/16" Frame
- 84" Door - 87 9/16" Frame
- 96" Door - 99 9/16" Frame
- 108" Door - 111 9/16" Frame
- 120" Door - 123 9/16" Frame

* Indicates a system configuration that does not require a lock. These systems will not be accessible from the exterior when the flushbolts are engaged, therefore are not recommended unless an additional exit door is nearby. Dummy trim set options are available.

^ Indicates a system configuration that will require an active lock only. The end panel will be active (manned door).

**^ Indicates a system configuration that will require an active lock and an optional dummy trim set. In odd-odd configurations, the customer may choose which door will be active (manned door). In odd-even configurations, the leading odd panel will be active (manned door).

5 DOOR CONFIGURATIONS

1L4R**^

Frame Width:
163" [4140]
With Raised Moulding

162 13/16" [4135]
No Raised Moulding

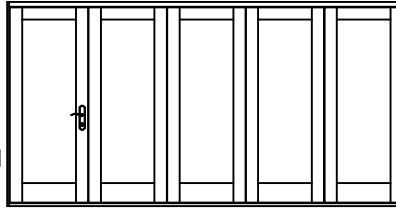

4L1R**^

Frame Width:
163" [4140]
With Raised Moulding

162 13/16" [4135]
No Raised Moulding

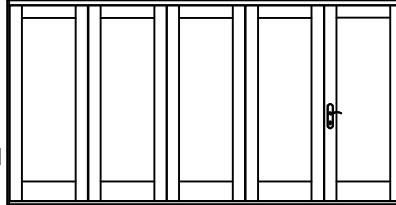

2L3R**^

Frame Width:
163" [4140]
With Raised Moulding

162 13/16" [4135]
No Raised Moulding

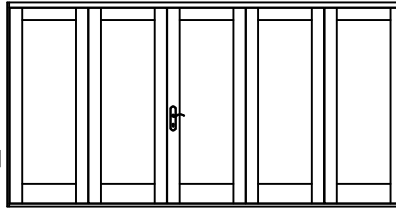

3L2R**^

Frame Width:
163" [4140]
With Raised Moulding

162 13/16" [4135]
No Raised Moulding

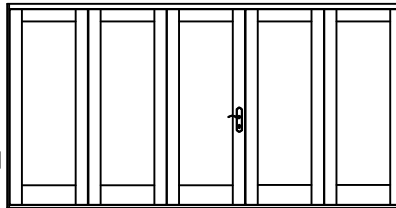

5L^

Frame Width:
162 3/4" [4134]
With Raised Moulding

162 9/16" [4129]
No Raised Moulding

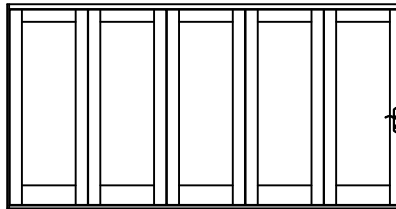

5R^

Frame Width:
162 3/4" [4134]
With Raised Moulding

162 9/16" [4129]
No Raised Moulding

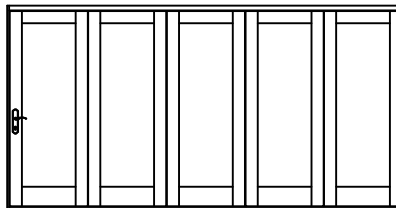

EXTERIOR FOLDING SYSTEM NOTES

All elevations viewed from exterior.

Hinges, flushbolts & carrier hardware included. Lockets not included, but available at an additional charge.

Frame Height = Door Height + 3 9/16"
 Standard Frame Heights:
 80" Door - 83 9/16" Frame
 84" Door - 87 9/16" Frame
 96" Door - 99 9/16" Frame
 108" Door - 111 9/16" Frame
 120" Door - 123 9/16" Frame

* Indicates a system configuration that does not require a lock. These systems will not be accessible from the exterior when the flushbolts are engaged, therefore are not recommended unless an additional exit door is nearby. Dummy trim set options are available.

^ Indicates a system configuration that will require an active lock only. The end panel will be active (manned door).

**^ Indicates a system configuration that will require an active lock and an optional dummy trim set. In odd-odd configurations, the customer may choose which door will be active (manned door). In odd-even configurations, the leading odd panel will be active (manned door).

6 DOOR CONFIGURATIONS

1L5R**^

Frame Width:
195 1/16" [4955]
With Raised Moulding

194 7/8" [4950]
No Raised Moulding

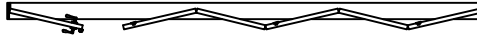
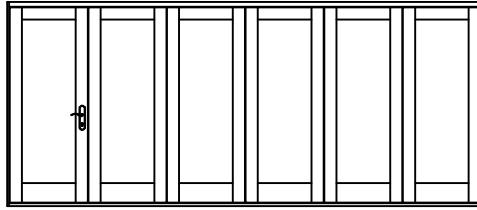

5L1R**^

Frame Width:
195 1/16" [4955]
With Raised Moulding

194 7/8" [4950]
No Raised Moulding

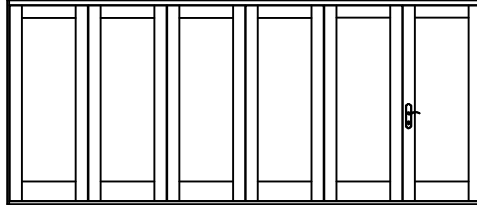

2L4R*

Frame Width:
195 5/16 [4961]
With Raised Moulding

195 1/8" [4956]
No Raised Moulding

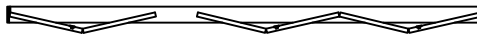
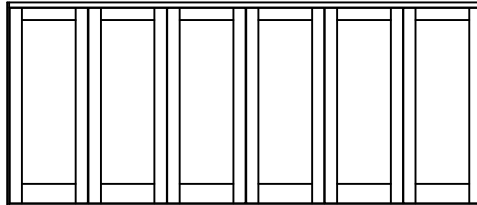

4L2R*

Frame Width:
195 5/16 [4961]
With Raised Moulding

195 1/8" [4956]
No Raised Moulding

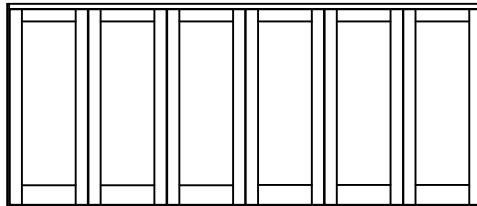

3L3R**^

Frame Width:
195 1/16" [4955]
With Raised Moulding

194 7/8" [4950]
No Raised Moulding

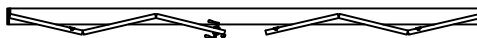
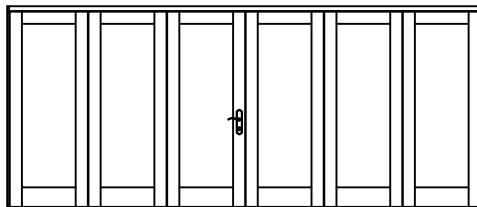

6L*

Frame Width:
195 1/16" [4955]
With Raised Moulding

194 7/8" [4950]
No Raised Moulding

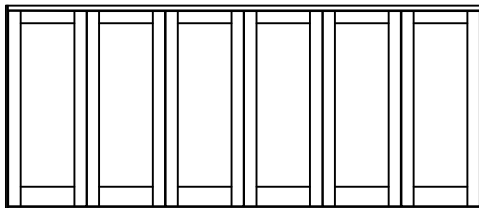

6R*

Frame Width:
195 1/16" [4955]
With Raised Moulding

194 7/8" [4950]
No Raised Moulding

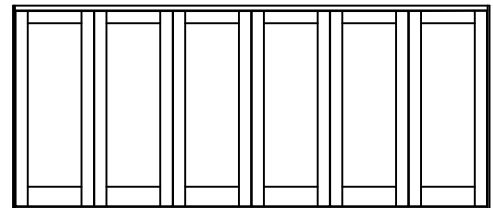

EXTERIOR FOLDING SYSTEM NOTES

All elevations viewed from exterior.

Hinges, flushbolts & carrier hardware included. Lockets not included, but available at an additional charge.

Frame Height = Door Height + 3 9/16"
 Standard Frame Heights:
 80" Door - 83 9/16" Frame
 84" Door - 87 9/16" Frame
 96" Door - 99 9/16" Frame
 108" Door - 111 9/16" Frame
 120" Door - 123 9/16" Frame

* Indicates a system configuration that does not require a lock. These systems will not be accessible from the exterior when the flushbolts are engaged, therefore are not recommended unless an additional exit door is nearby. Dummy trim set options are available.

^ Indicates a system configuration that will require an active lock only. The end panel will be active (manned door).

**^ Indicates a system configuration that will require an active lock and an optional dummy trim set. In odd-odd configurations, the customer may choose which door will be active (manned door). In odd-even configurations, the leading odd panel will be active (manned door).

7 DOOR CONFIGURATIONS

1L6R**^

Frame Width:
 227 3/8" [5775]
 With Raised Moulding

227 1/8" [5769]
 No Raised Moulding

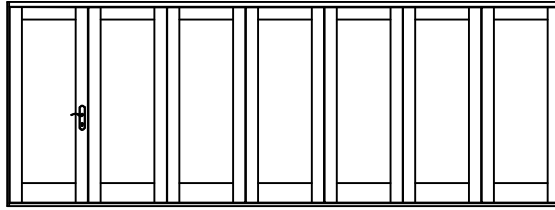

6L1R**^

Frame Width:
 227 3/8" [5775]
 With Raised Moulding

227 1/8" [5769]
 No Raised Moulding

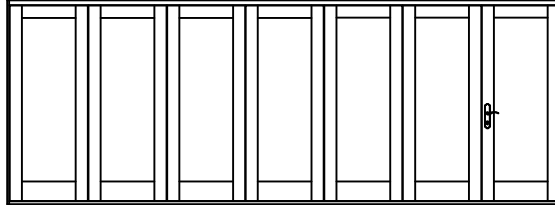

2L5R**^

Frame Width:
 227 3/8" [5775]
 With Raised Moulding

227 1/8" [5769]
 No Raised Moulding

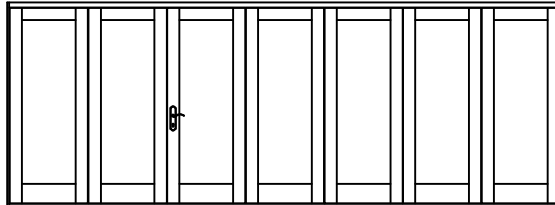

5L2R**^

Frame Width:
 227 3/8" [5775]
 With Raised Moulding

227 1/8" [5769]
 No Raised Moulding

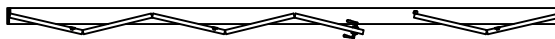
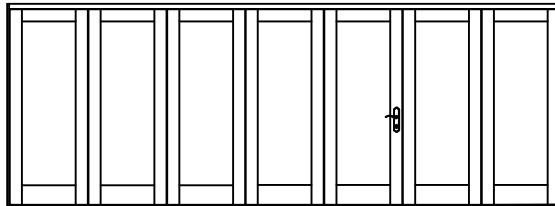

3L4R**^ Frame Width: 227 3/8" [5775] With Raised Moulding
 227 1/8" [5769] No Raised Moulding

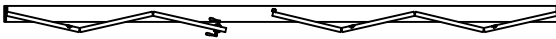
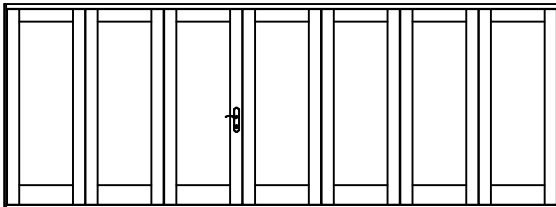

4L3R**^ Frame Width: 227 3/8" [5775] With Raised Moulding
 227 1/8" [5769] No Raised Moulding

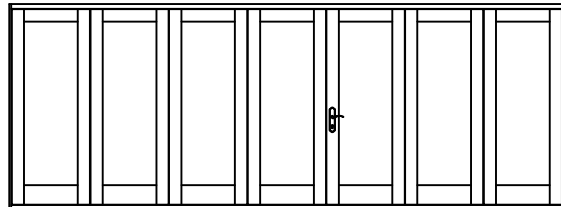

7L^ Frame Width: 227 1/8" [5769] With Raised Moulding
 226 7/8" [5763] No Raised Moulding

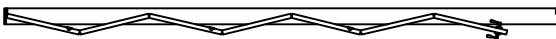
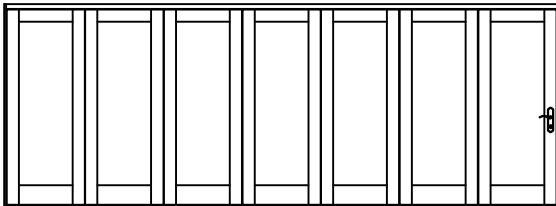

7R^ Frame Width: 227 1/8" [5769] With Raised Moulding
 226 7/8" [5763] No Raised Moulding

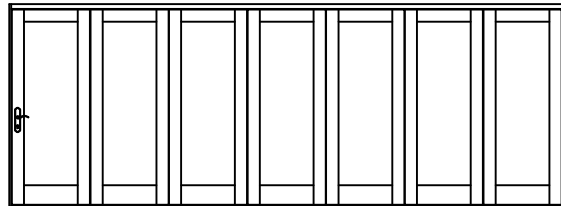

EXTERIOR FOLDING SYSTEM NOTES

All elevations viewed from exterior.

Hinges, flushbolts & carrier hardware included. Lockets not included, but available at an additional charge.

Frame Height = Door Height + 3 9/16"
 Standard Frame Heights:
 80" Door - 83 9/16" Frame
 84" Door - 87 9/16" Frame
 96" Door - 99 9/16" Frame
 108" Door - 111 9/16" Frame
 120" Door - 123 9/16" Frame

* Indicates a system configuration that does not require a lock. These systems will not be accessible from the exterior when the flushbolts are engaged, therefore are not recommended unless an additional exit door is nearby. Dummy trim set options are available.

^ Indicates a system configuration that will require an active lock only. The end panel will be active (manned door).

**^ Indicates a system configuration that will require an active lock and an optional dummy trim set. In odd-odd configurations, the customer may choose which door will be active (manned door). In odd-even configurations, the leading odd panel will be active (manned door).

8 DOOR CONFIGURATIONS

2L6R*

Frame Width:
 259 11/16" [6596]
 With Raised Moulding

259 7/16" [6590]
 No Raised Moulding

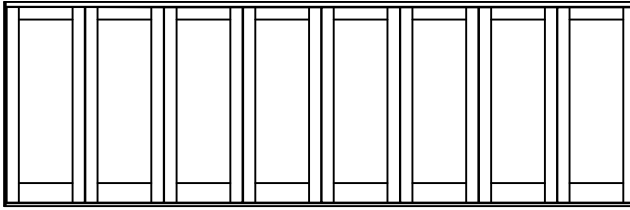

6L2R*

Frame Width:
 259 11/16" [6596]
 With Raised Moulding

259 7/16" [6590]
 No Raised Moulding

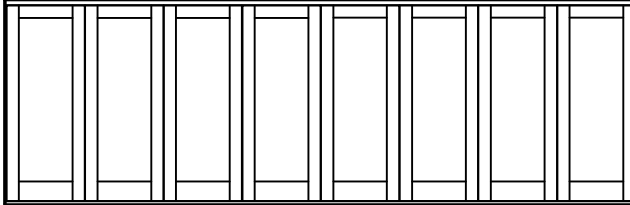

4L4R*

Frame Width:
 259 11/16" [6596]
 With Raised Moulding

259 7/16" [6590]
 No Raised Moulding

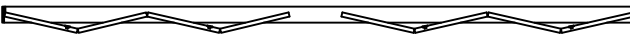
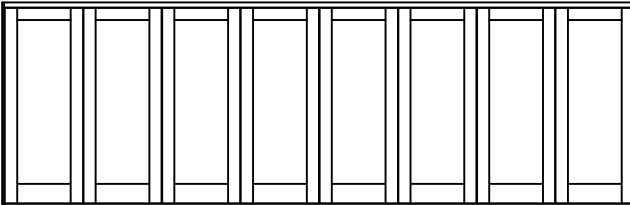

1L7R**^ Frame Width: 259 7/16" [6590] With Raised Moulding
 259 3/16" [6583] No Raised Moulding

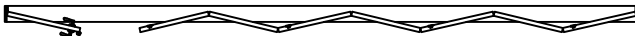
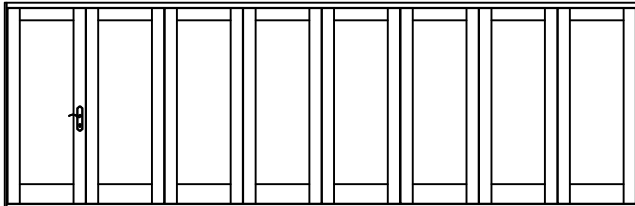

7L1R**^ Frame Width: 259 7/16" [6590] With Raised Moulding
 259 3/16" [6583] No Raised Moulding

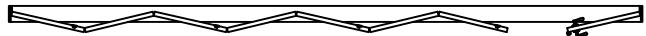
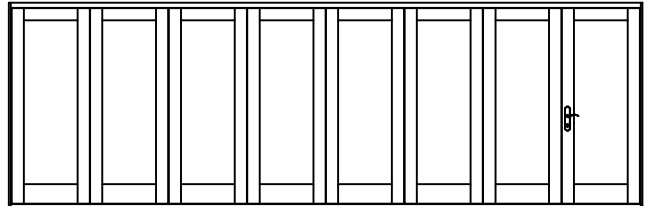

3L5R**^ Frame Width: 259 7/16" [6590] With Raised Moulding
 259 3/16" [6583] No Raised Moulding

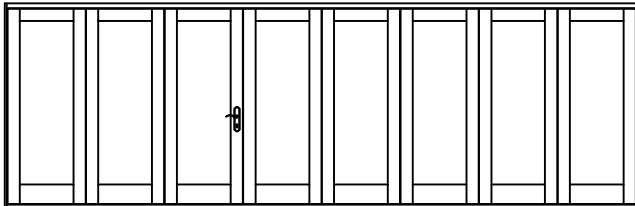

5L3R**^ Frame Width: 259 7/16" [6590] With Raised Moulding
 259 3/16" [6583] No Raised Moulding

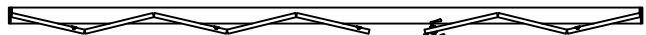
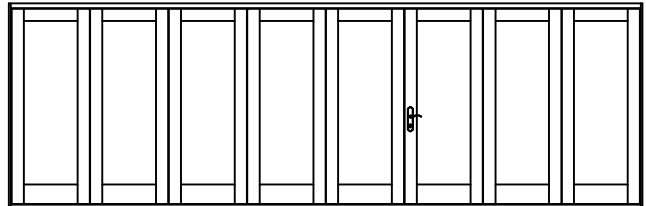

8L* Frame Width: 259 7/16" [6590] With Raised Moulding
 259 3/16" [6583] No Raised Moulding

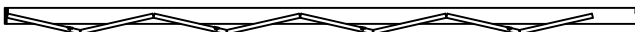
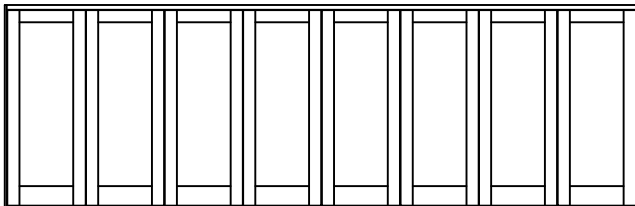

8R* Frame Width: 259 7/16" [6590] With Raised Moulding
 259 3/16" [6583] No Raised Moulding

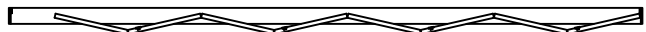
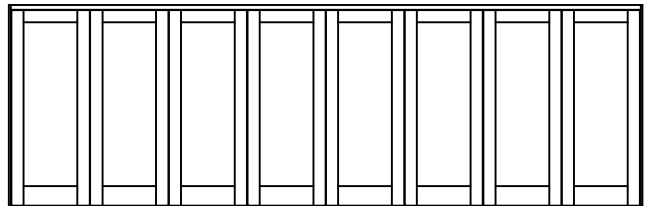

EXTERIOR FOLDING SYSTEM NOTES

All elevations viewed from exterior.

Hinges, flushbolts & carrier hardware included. Lockets not included, but available at an additional charge.

Frame Height = Door Height + 3 9/16"
 Standard Frame Heights:
 80" Door - 83 9/16" Frame
 84" Door - 87 9/16" Frame
 96" Door - 99 9/16" Frame
 108" Door - 111 9/16" Frame
 120" Door - 123 9/16" Frame

* Indicates a system configuration that does not require a lock. These systems will not be accessible from the exterior when the flushbolts are engaged, therefore are not recommended unless an additional exit door is nearby. Dummy trim set options are available.

^ Indicates a system configuration that will require an active lock only. The end panel will be active (manned door).

**^ Indicates a system configuration that will require an active lock and an optional dummy trim set. In odd-odd configurations, the customer may choose which door will be active (manned door). In odd-even configurations, the leading odd panel will be active (manned door).

2 DOOR CONFIGURATIONS

2L*

Frame Width:
74 5/16" [1888]
With Raised Moulding

74 1/4" [1886]
No Raised Moulding

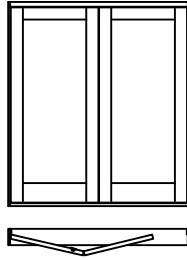

2R*

Frame Width:
74 5/16" [1888]
With Raised Moulding

74 1/4" [1886]
No Raised Moulding

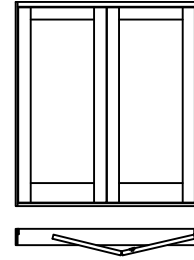

3 DOOR CONFIGURATIONS

2L1R**^

Frame Width:
110 5/8" [2810]
With Raised Moulding

110 1/2" [2807]
No Raised Moulding

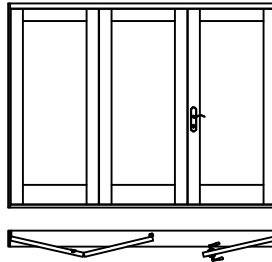

1L2R**^

Frame Width:
110 5/8" [2810]
With Raised Moulding

110 1/2" [2807]
No Raised Moulding

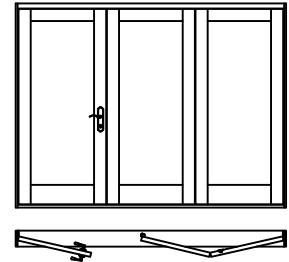

3L^

Frame Width:
110 3/8" [2804]
With Raised Moulding

110 1/4" [2800]
No Raised Moulding

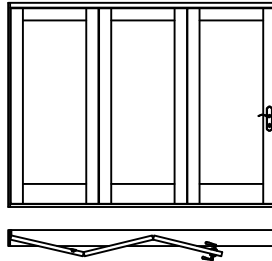

3R^

Frame Width:
110 3/8" [2804]
With Raised Moulding

110 1/4" [2800]
No Raised Moulding

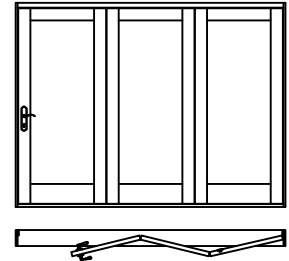

4 DOOR CONFIGURATIONS

2L2R*

Frame Width:
146 15/16" [3732]
With Raised Moulding

146 13/16" [3729]
No Raised Moulding

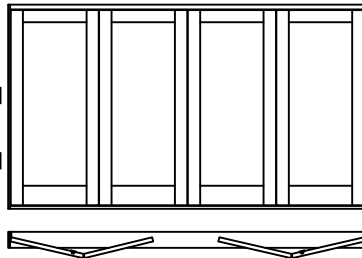

3L1R**^

Frame Width:
146 11/16" [3726]
With Raised Moulding

146 9/16" [3723]
No Raised Moulding

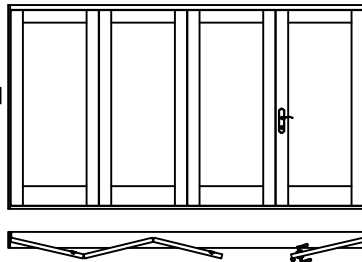

1L3R**^

Frame Width:
146 11/16" [3726]
With Raised Moulding

146 9/16" [3723]
No Raised Moulding

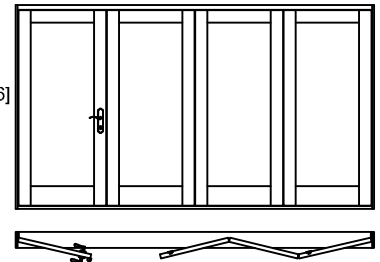

4L*

Frame Width:
146 11/16" [3726]
With Raised Moulding

146 9/16" [3723]
No Raised Moulding

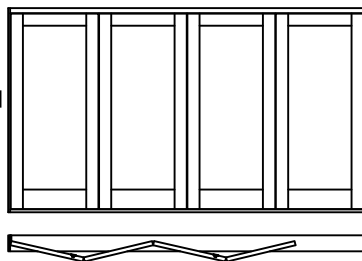

4R*

Frame Width:
146 11/16" [3726]
With Raised Moulding

146 9/16" [3723]
No Raised Moulding

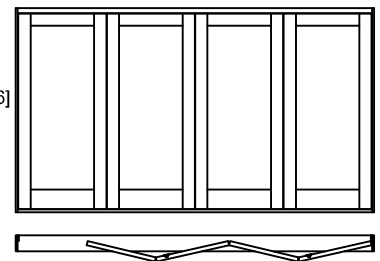

EXTERIOR FOLDING SYSTEM NOTES

All elevations viewed from exterior.

Hinges, flushbolts & carrier hardware included. Lockets not included, but available at an additional charge.

Frame Height = Door Height + 3 9/16"

Standard Frame Heights:

- 80" Door - 83 9/16" Frame
- 84" Door - 87 9/16" Frame
- 96" Door - 99 9/16" Frame
- 108" Door - 111 9/16" Frame
- 120" Door - 123 9/16" Frame

* Indicates a system configuration that does not require a lock. These systems will not be accessible from the exterior when the flushbolts are engaged, therefore are not recommended unless an additional exit door is nearby. Dummy trim set options are available.

^ Indicates a system configuration that will require an active lock only. The end panel will be active (manned door).

**^ Indicates a system configuration that will require an active lock and an optional dummy trim set. In odd-odd configurations, the customer may choose which door will be active (manned door). In odd-even configurations, the leading odd panel will be active (manned door).

5 DOOR CONFIGURATIONS

1L4R**^

Frame Width:
183" [4648]
With Raised Moulding

182 13/16" [4643]
No Raised Moulding

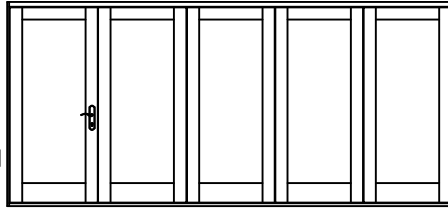

4L1R**^

Frame Width:
183" [4648]
With Raised Moulding

182 13/16" [4643]
No Raised Moulding

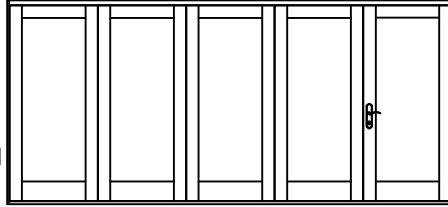

2L3R**^

Frame Width:
183" [4648]
With Raised Moulding

182 13/16" [4643]
No Raised Moulding

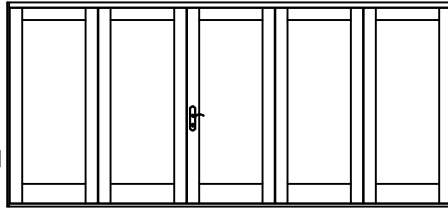

3L2R**^

Frame Width:
183" [4648]
With Raised Moulding

182 13/16" [4643]
No Raised Moulding

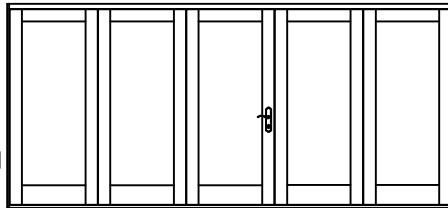

5L^

Frame Width:
182 3/4" [4642]
With Raised Moulding

182 9/16" [4637]
No Raised Moulding

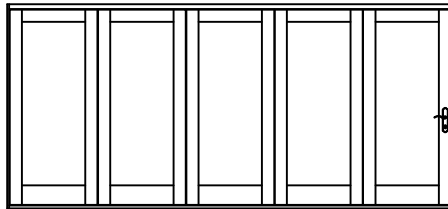

5R^

Frame Width:
182 3/4" [4642]
With Raised Moulding

182 9/16" [4637]
No Raised Moulding

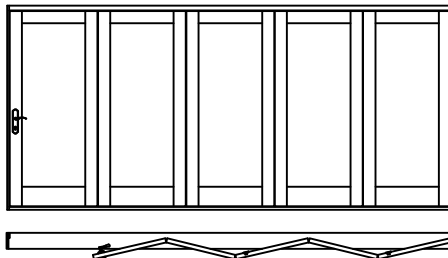

EXTERIOR FOLDING SYSTEM NOTES

All elevations viewed from exterior.

Hinges, flushbolts & carrier hardware included. Lockets not included, but available at an additional charge.

Frame Height = Door Height + 3 9/16"
 Standard Frame Heights:
 80" Door - 83 9/16" Frame
 84" Door - 87 9/16" Frame
 96" Door - 99 9/16" Frame
 108" Door - 111 9/16" Frame
 120" Door - 123 9/16" Frame

* Indicates a system configuration that does not require a lock. These systems will not be accessible from the exterior when the flushbolts are engaged, therefore are not recommended unless an additional exit door is nearby. Dummy trim set options are available.

^ Indicates a system configuration that will require an active lock only. The end panel will be active (manned door).

**^ Indicates a system configuration that will require an active lock and an optional dummy trim set. In odd-odd configurations, the customer may choose which door will be active (manned door). In odd-even configurations, the leading odd panel will be active (manned door).

6 DOOR CONFIGURATIONS

1L5R**^

Frame Width:
219 1/16" [5564]
With Raised Moulding

218 7/8" [5559]
No Raised Moulding

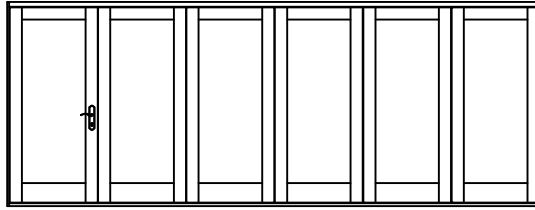

5L1R**^

Frame Width:
219 1/16" [5564]
With Raised Moulding

218 7/8" [5559]
No Raised Moulding

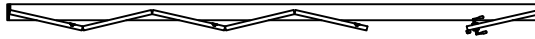
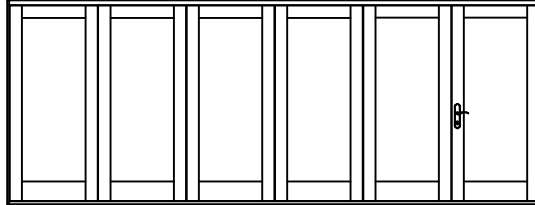

2L4R*

Frame Width:
219 5/16 [5571]
With Raised Moulding

219 1/8" [5566]
No Raised Moulding

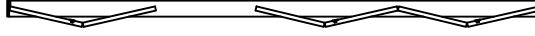
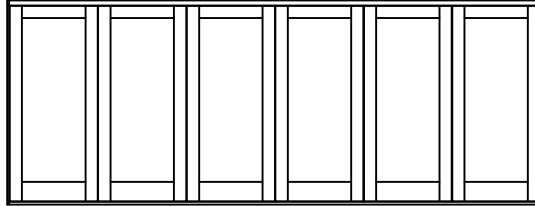

4L2R*

Frame Width:
219 5/16 [5571]
With Raised Moulding

219 1/8" [5566]
No Raised Moulding

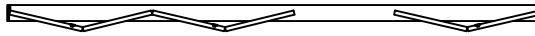
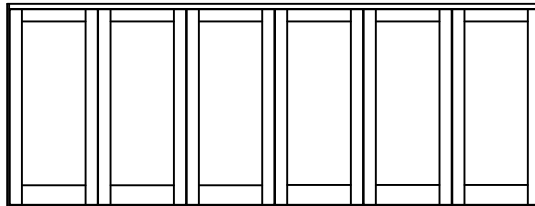

3L3R**^

Frame Width:
219 1/16" [5564]
With Raised Moulding

218 7/8" [5559]
No Raised Moulding

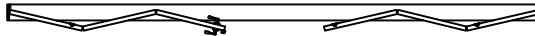
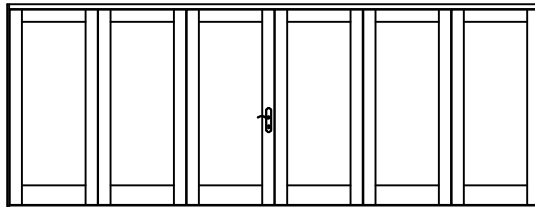

6L*

Frame Width:
219 1/16" [5564]
With Raised Moulding

218 7/8" [5559]
No Raised Moulding

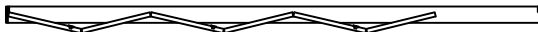
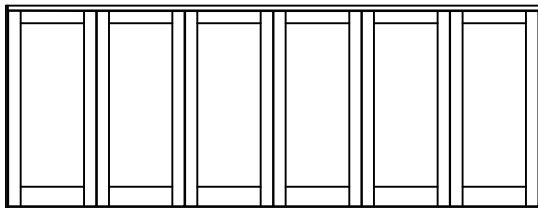

6R*

Frame Width:
219 1/16" [5564]
With Raised Moulding

218 7/8" [5559]
No Raised Moulding

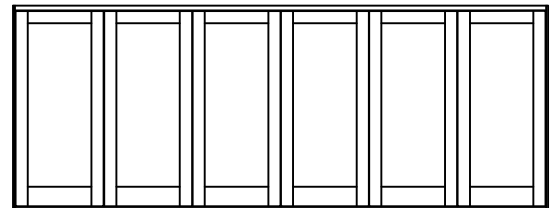

EXTERIOR FOLDING SYSTEM NOTES

All elevations viewed from exterior.

Hinges, flushbolts & carrier hardware included. Lockets not included, but available at an additional charge.

Frame Height = Door Height + 3 9/16"
 Standard Frame Heights:
 80" Door - 83 9/16" Frame
 84" Door - 87 9/16" Frame
 96" Door - 99 9/16" Frame
 108" Door - 111 9/16" Frame
 120" Door - 123 9/16" Frame

* Indicates a system configuration that does not require a lock. These systems will not be accessible from the exterior when the flushbolts are engaged, therefore are not recommended unless an additional exit door is nearby. Dummy trim set options are available.

^ Indicates a system configuration that will require an active lock only. The end panel will be active (manned door).

**^ Indicates a system configuration that will require an active lock and an optional dummy trim set. In odd-odd configurations, the customer may choose which door will be active (manned door). In odd-even configurations, the leading odd panel will be active (manned door).

7 DOOR CONFIGURATIONS

1L6R**^

Frame Width:
255 3/8" [6487]
With Raised Moulding

255 1/8" [6480]
No Raised Moulding

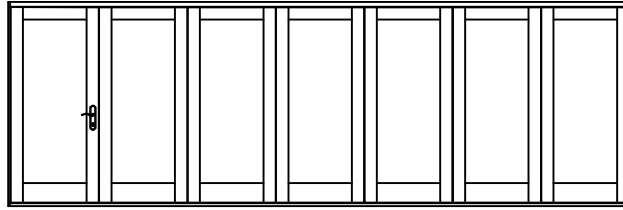

6L1R**^

Frame Width:
255 3/8" [6487]
With Raised Moulding

255 1/8" [6480]
No Raised Moulding

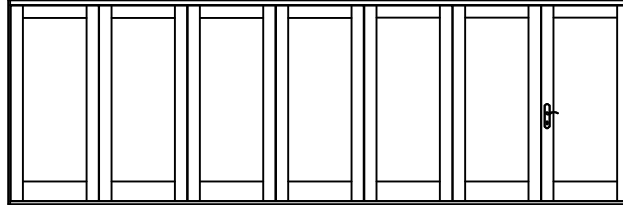

2L5R**^

Frame Width:
255 3/8" [6487]
With Raised Moulding

255 1/8" [6480]
No Raised Moulding

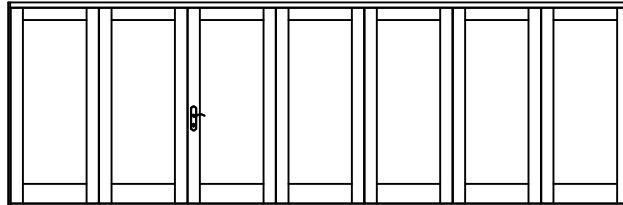

5L2R**^

Frame Width:
255 3/8" [6487]
With Raised Moulding

255 1/8" [6480]
No Raised Moulding

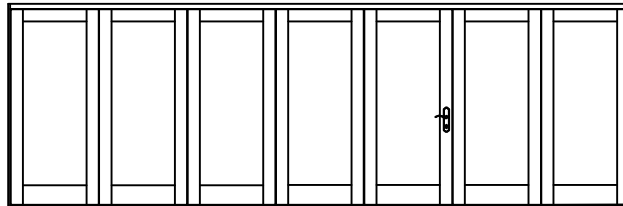

3L4R**^ Frame Width: 255 3/8" [6487] With Raised Moulding
255 1/8" [6480] No Raised Moulding

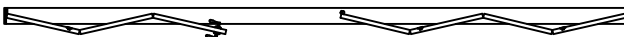
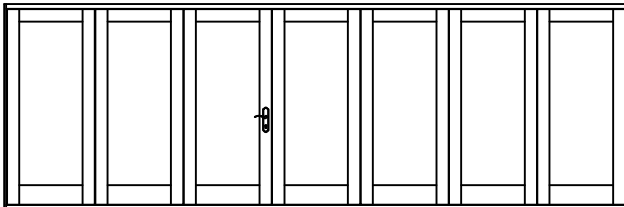

4L3R**^ Frame Width: 255 3/8" [6487] With Raised Moulding
255 1/8" [6480] No Raised Moulding

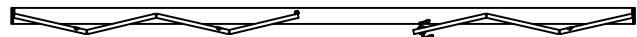
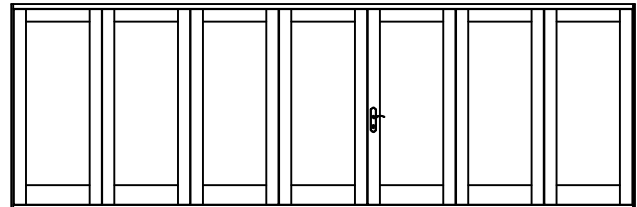

7L^ Frame Width: 255 1/8" [6480] With Raised Moulding
254 7/8" [6474] No Raised Moulding

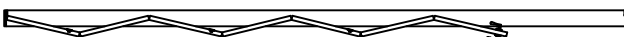
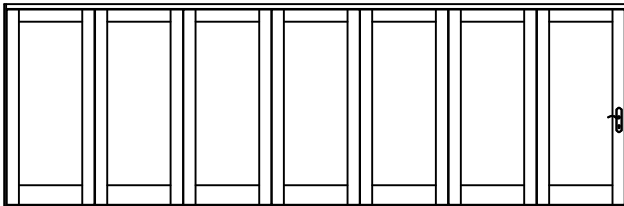

7R^ Frame Width: 255 1/8" [6480] With Raised Moulding
254 7/8" [6474] No Raised Moulding

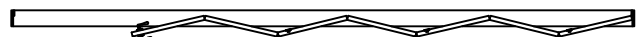
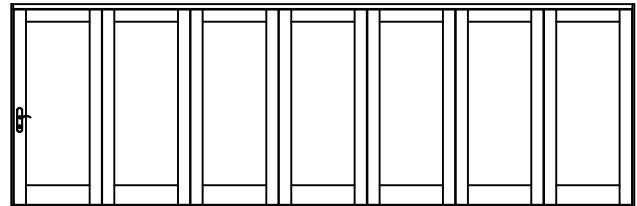

EXTERIOR FOLDING SYSTEM NOTES

All elevations viewed from exterior.

Hinges, flushbolts & carrier hardware included. Lockets not included, but available at an additional charge.

Frame Height = Door Height + 3 9/16"
 Standard Frame Heights:
 80" Door - 83 9/16" Frame
 84" Door - 87 9/16" Frame
 96" Door - 99 9/16" Frame
 108" Door - 111 9/16" Frame
 120" Door - 123 9/16" Frame

* Indicates a system configuration that does not require a lock. These systems will not be accessible from the exterior when the flushbolts are engaged, therefore are not recommended unless an additional exit door is nearby. Dummy trim set options are available.

^ Indicates a system configuration that will require an active lock only. The end panel will be active (manned door).

**^ Indicates a system configuration that will require an active lock and an optional dummy trim set. In odd-odd configurations, the customer may choose which door will be active (manned door). In odd-even configurations, the leading odd panel will be active (manned door).

8 DOOR CONFIGURATIONS

2L6R*

Frame Width:
 291 11/16" [7409]
 With Raised Moulding

291 7/16" [7403]
 No Raised Moulding

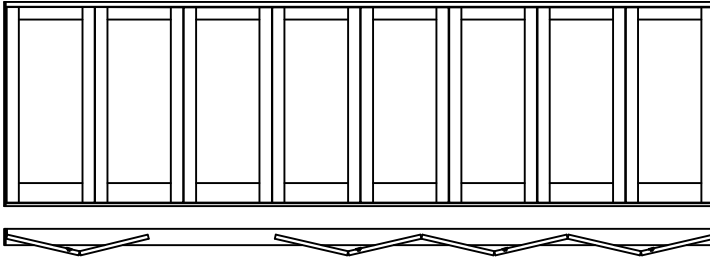

6L2R*

Frame Width:
 291 11/16" [7409]
 With Raised Moulding

291 7/16" [7403]
 No Raised Moulding

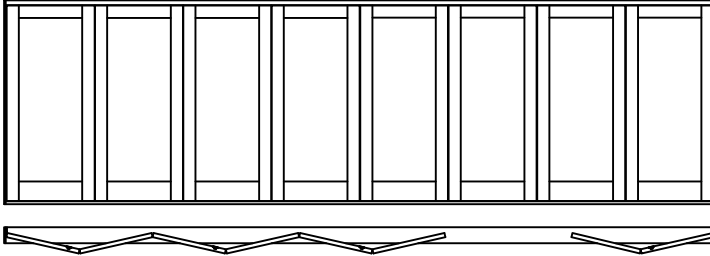

4L4R*

Frame Width:
 291 11/16" [7409]
 With Raised Moulding

291 7/16" [7403]
 No Raised Moulding

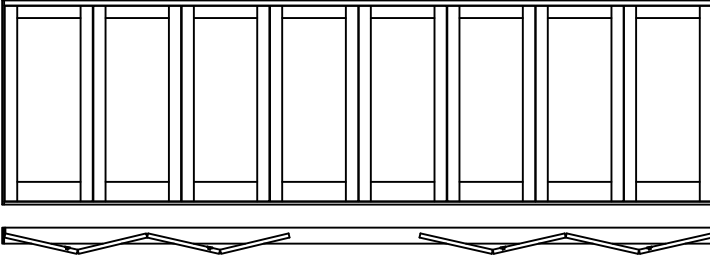

1L7R^** Frame Width: 291 7/16" [7403] With Raised Moulding
 291 3/16" [7396] No Raised Moulding

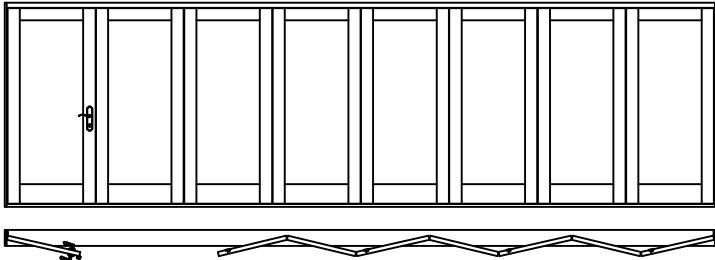

7L1R^** Frame Width: 291 7/16" [7403] With Raised Moulding
 291 3/16" [7396] No Raised Moulding

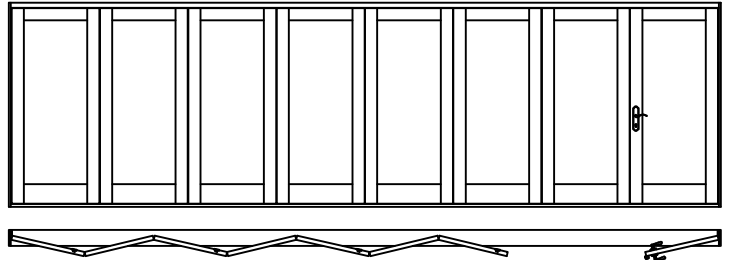

3L5R^** Frame Width: 291 7/16" [7403] With Raised Moulding
 291 3/16" [7396] No Raised Moulding

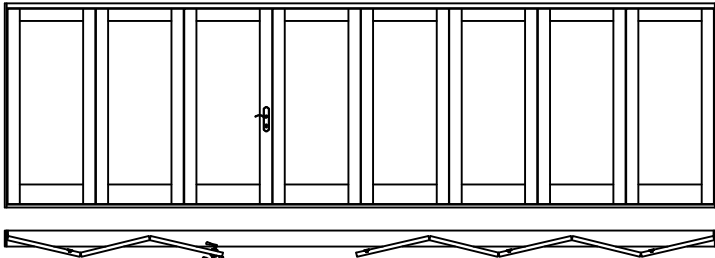

5L3R^** Frame Width: 291 7/16" [7403] With Raised Moulding
 291 3/16" [7396] No Raised Moulding

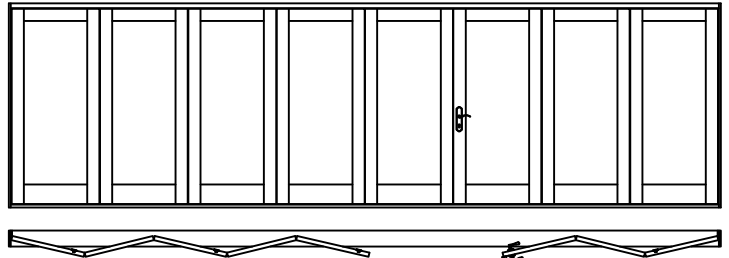

8L* Frame Width: 291 7/16" [7403] With Raised Moulding
 291 3/16" [7396] No Raised Moulding

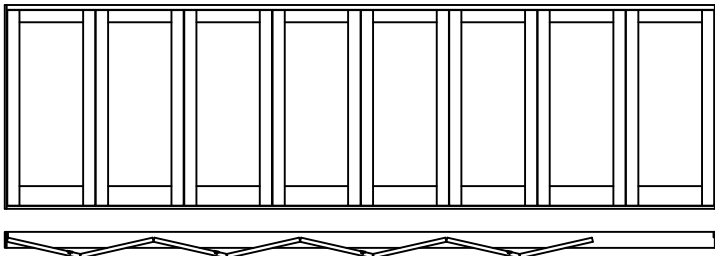

8R* Frame Width: 291 7/16" [7403] With Raised Moulding
 291 3/16" [7396] No Raised Moulding

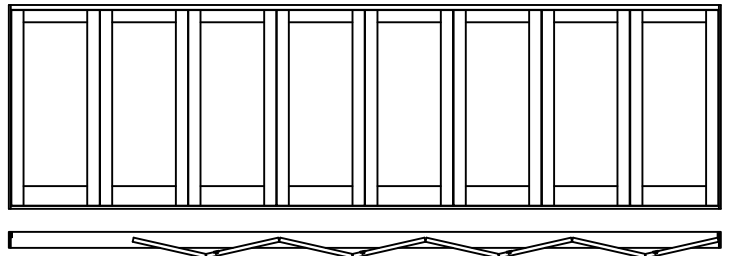

EXTERIOR FOLDING SYSTEM NOTES

All elevations viewed from exterior.

Hinges, flushbolts & carrier hardware included. Lockets not included, but available at an additional charge.

Frame Height = Door Height + 3 9/16"
 Standard Frame Heights:
 80" Door - 83 9/16" Frame
 84" Door - 87 9/16" Frame
 96" Door - 99 9/16" Frame
 108" Door - 111 9/16" Frame
 120" Door - 123 9/16" Frame

* Indicates a system configuration that does not require a lock. These systems will not be accessible from the exterior when the flushbolts are engaged, therefore are not recommended unless an additional exit door is nearby. Dummy trim set options are available.

^ Indicates a system configuration that will require an active lock only. The end panel will be active (manned door).

**^ Indicates a system configuration that will require an active lock and an optional dummy trim set. In odd-odd configurations, the customer may choose which door will be active (manned door). In odd-even configurations, the leading odd panel will be active (manned door).

2 DOOR CONFIGURATIONS

2L*

Frame Width:
86 5/16" [2192]
With Raised Moulding

86 1/4" [2191]
No Raised Moulding

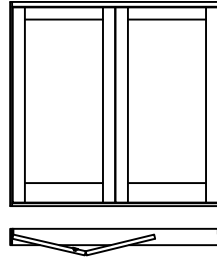

2R*

Frame Width:
86 5/16" [2192]
With Raised Moulding

86 1/4" [2191]
No Raised Moulding

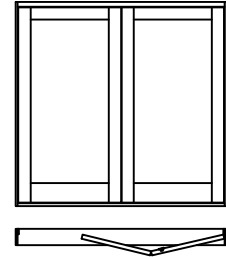

3 DOOR CONFIGURATIONS

2L1R**^

Frame Width:
128 5/8" [3267]
With Raised Moulding

128 1/2" [3264]
No Raised Moulding

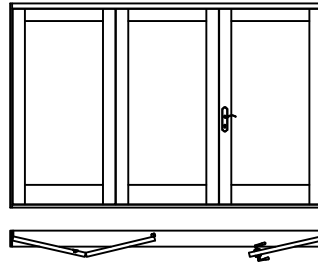

1L2R**^

Frame Width:
128 5/8" [3267]
With Raised Moulding

128 1/2" [3264]
No Raised Moulding

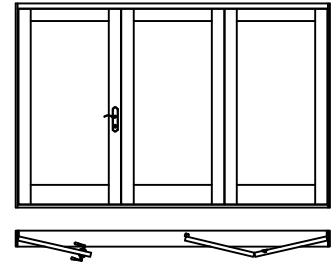

3L^

Frame Width:
128 3/8" [3261]
With Raised Moulding

128 1/4" [3258]
No Raised Moulding

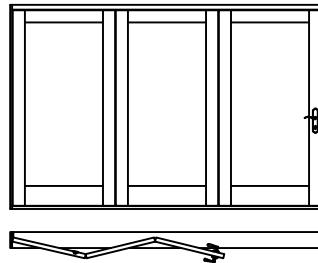

3R^

Frame Width:
128 3/8" [3261]
With Raised Moulding

128 1/4" [3258]
No Raised Moulding

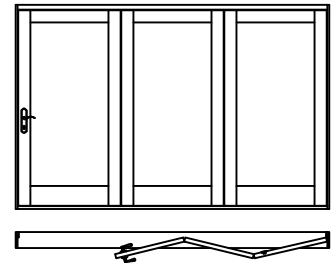

4 DOOR CONFIGURATIONS

2L2R*

Frame Width:
170 15/16" [4342]
With Raised Moulding

170 13/16" [4339]
No Raised Moulding

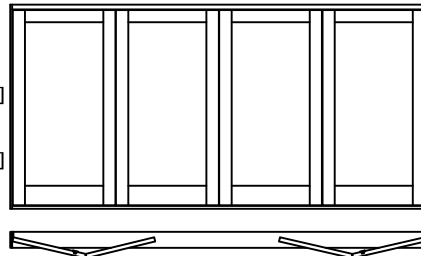

3L1R**^

Frame Width:
170 11/16" [4335]
With Raised Moulding

170 9/16" [4332]
No Raised Moulding

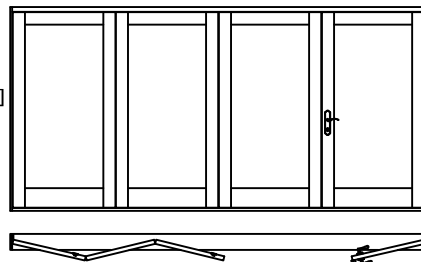

1L3R**^

Frame Width:
170 11/16" [4335]
With Raised Moulding

170 9/16" [4332]
No Raised Moulding

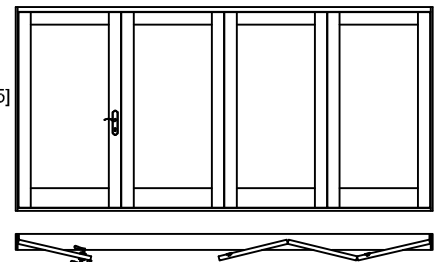

4L*

Frame Width:
170 11/16" [4335]
With Raised Moulding

170 9/16" [4332]
No Raised Moulding

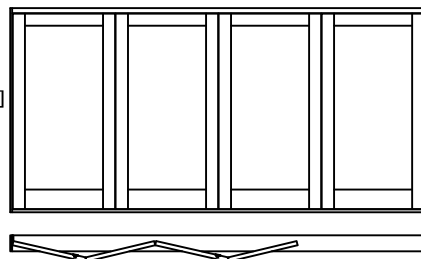

4R*

Frame Width:
170 11/16" [4335]
With Raised Moulding

170 9/16" [4332]
No Raised Moulding

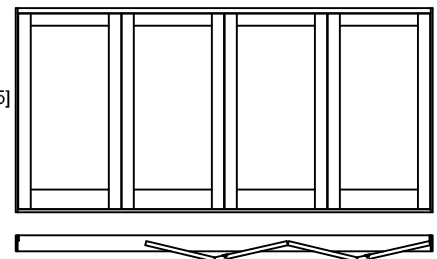

EXTERIOR FOLDING SYSTEM NOTES

All elevations viewed from exterior.

Hinges, flushbolts & carrier hardware included. Lockets not included, but available at an additional charge.

Frame Height = Door Height + 3 9/16"
 Standard Frame Heights:
 80" Door - 83 9/16" Frame
 84" Door - 87 9/16" Frame
 96" Door - 99 9/16" Frame
 108" Door - 111 9/16" Frame
 120" Door - 123 9/16" Frame

* Indicates a system configuration that does not require a lock. These systems will not be accessible from the exterior when the flushbolts are engaged, therefore are not recommended unless an additional exit door is nearby. Dummy trim set options are available.

^ Indicates a system configuration that will require an active lock only. The end panel will be active (manned door).

**^ Indicates a system configuration that will require an active lock and an optional dummy trim set. In odd-odd configurations, the customer may choose which door will be active (manned door). In odd-even configurations, the leading odd panel will be active (manned door).

5 DOOR CONFIGURATIONS

1L4R**^

Frame Width:
213" [5410]
With Raised Moulding

212 13/16" [5405]
No Raised Moulding

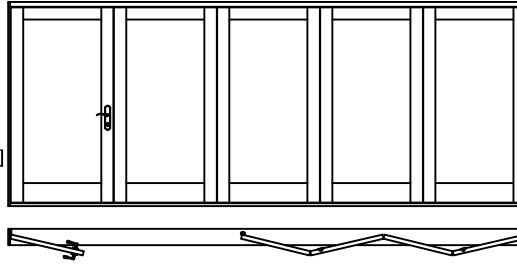

4L1R**^

Frame Width:
213" [5410]
With Raised Moulding

212 13/16" [5405]
No Raised Moulding

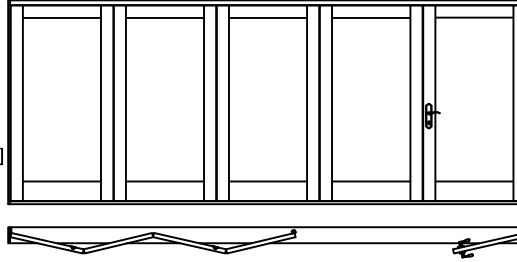

2L3R**^

Frame Width:
213" [5410]
With Raised Moulding

212 13/16" [5405]
No Raised Moulding

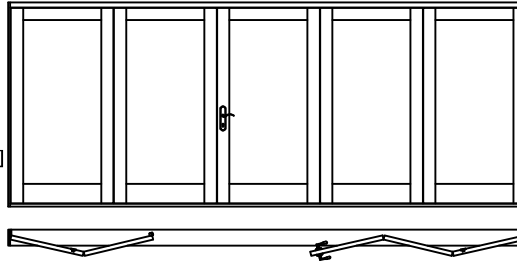

3L2R**^

Frame Width:
213" [5410]
With Raised Moulding

212 13/16" [5405]
No Raised Moulding

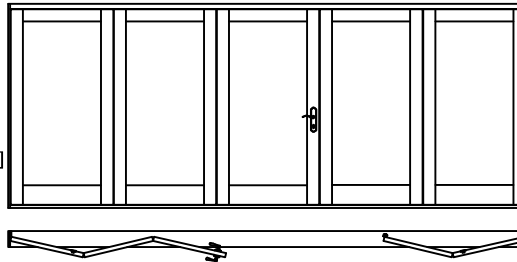

5L^

Frame Width:
212 3/4" [5404]
With Raised Moulding

212 9/16" [5399]
No Raised Moulding

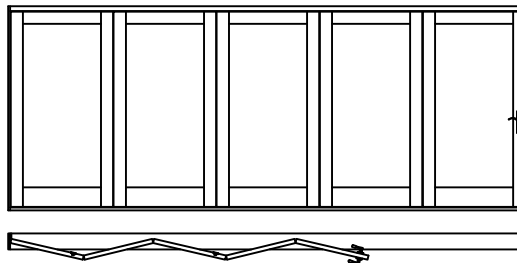

5R^

Frame Width:
212 3/4" [5404]
With Raised Moulding

212 9/16" [5399]
No Raised Moulding

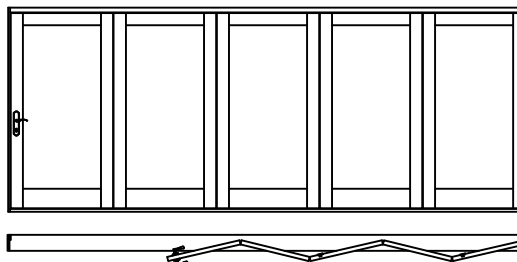

EXTERIOR FOLDING SYSTEM NOTES

All elevations viewed from exterior.

Hinges, flushbolts & carrier hardware included. Lockets not included, but available at an additional charge.

Frame Height = Door Height + 3 9/16"
 Standard Frame Heights:
 80" Door - 83 9/16" Frame
 84" Door - 87 9/16" Frame
 96" Door - 99 9/16" Frame
 108" Door - 111 9/16" Frame
 120" Door - 123 9/16" Frame

* Indicates a system configuration that does not require a lock. These systems will not be accessible from the exterior when the flushbolts are engaged, therefore are not recommended unless an additional exit door is nearby. Dummy trim set options are available.

^ Indicates a system configuration that will require an active lock only. The end panel will be active (manned door).

**^ Indicates a system configuration that will require an active lock and an optional dummy trim set. In odd-odd configurations, the customer may choose which door will be active (manned door). In odd-even configurations, the leading odd panel will be active (manned door).

6 DOOR CONFIGURATIONS

1L5R**^

Frame Width:
255 1/16" [6479]
With Raised Moulding

254 7/8" [6474]
No Raised Moulding

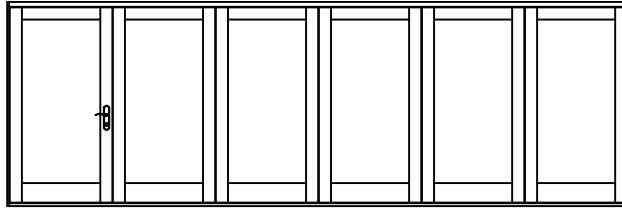

5L1R**^

Frame Width:
255 1/16" [6479]
With Raised Moulding

254 7/8" [6474]
No Raised Moulding

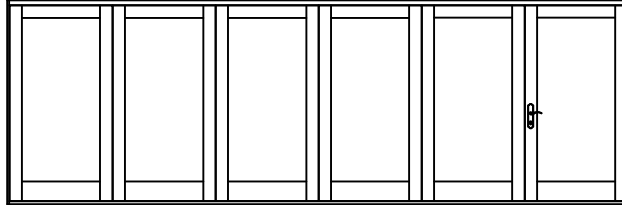

2L4R*

Frame Width:
255 5/16 [6485]
With Raised Moulding

255 1/8" [6480]
No Raised Moulding

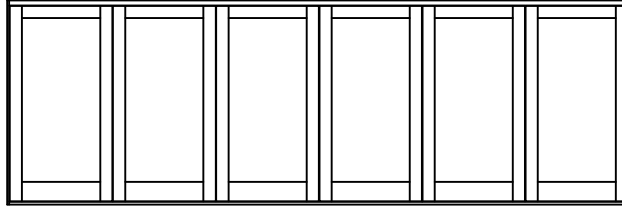

4L2R*

Frame Width:
255 5/16 [6485]
With Raised Moulding

255 1/8" [6480]
No Raised Moulding

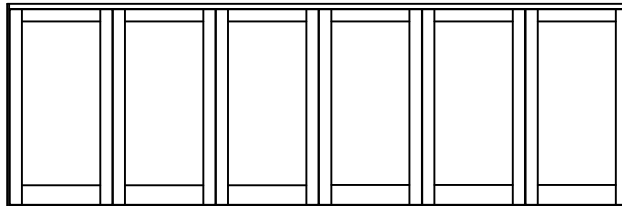

3L3R**^

Frame Width:
255 1/16" [6479]
With Raised Moulding

254 7/8" [6474]
No Raised Moulding

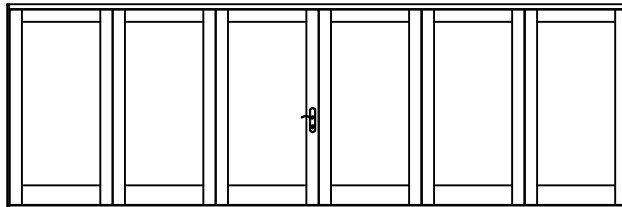

6L*

Frame Width:
255 1/16" [6479]
With Raised Moulding

254 7/8" [6474]
No Raised Moulding

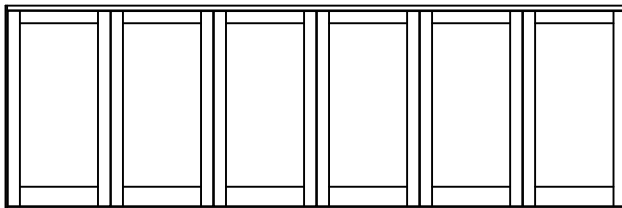

6R*

Frame Width:
255 1/16" [6479]
With Raised Moulding

254 7/8" [6474]
No Raised Moulding

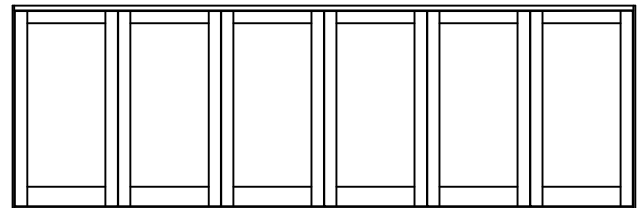

EXTERIOR FOLDING SYSTEM NOTES

All elevations viewed from exterior.

Hinges, flushbolts & carrier hardware included. Lockets not included, but available at an additional charge.

Frame Height = Door Height + 3 9/16"
 Standard Frame Heights:
 80" Door - 83 9/16" Frame
 84" Door - 87 9/16" Frame
 96" Door - 99 9/16" Frame
 108" Door - 111 9/16" Frame
 120" Door - 123 9/16" Frame

* Indicates a system configuration that does not require a lock. These systems will not be accessible from the exterior when the flushbolts are engaged, therefore are not recommended unless an additional exit door is nearby. Dummy trim set options are available.

^ Indicates a system configuration that will require an active lock only. The end panel will be active (manned door).

**^ Indicates a system configuration that will require an active lock and an optional dummy trim set. In odd-odd configurations, the customer may choose which door will be active (manned door). In odd-even configurations, the leading odd panel will be active (manned door).

7 DOOR CONFIGURATIONS

1L6R**^

Frame Width:
297 3/8" [7553]
With Raised Moulding

297 1/8" [7547]
No Raised Moulding

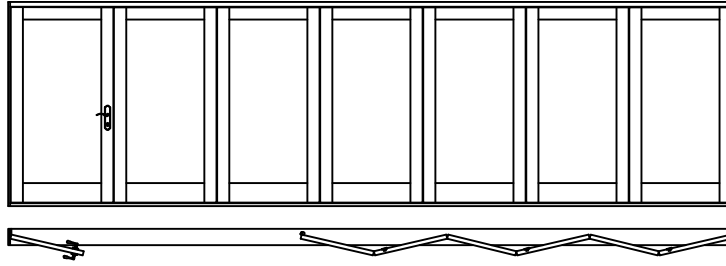

6L1R**^

Frame Width:
297 3/8" [7553]
With Raised Moulding

297 1/8" [7547]
No Raised Moulding

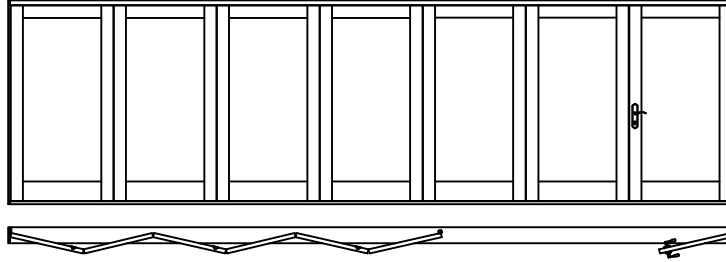

2L5R**^

Frame Width:
297 3/8" [7553]
With Raised Moulding

297 1/8" [7547]
No Raised Moulding

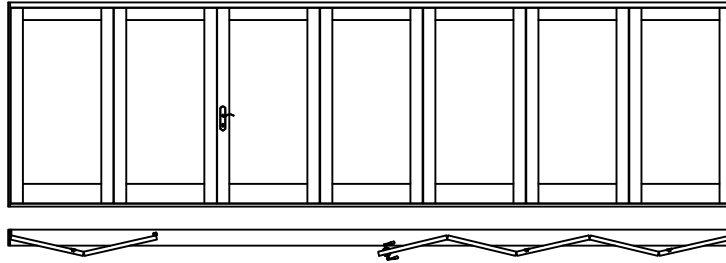

5L2R**^

Frame Width:
297 3/8" [7553]
With Raised Moulding

297 1/8" [7547]
No Raised Moulding

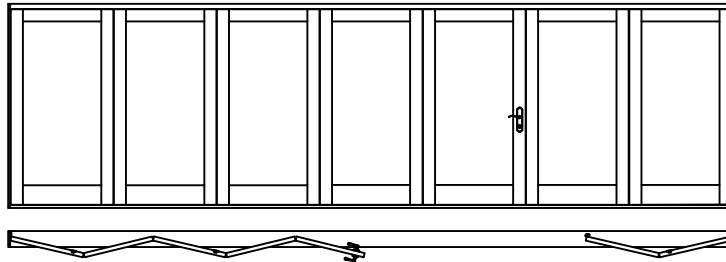

3L4R**^ Frame Width: 297 3/8" [7553] With Raised Moulding
297 1/8" [7547] No Raised Moulding

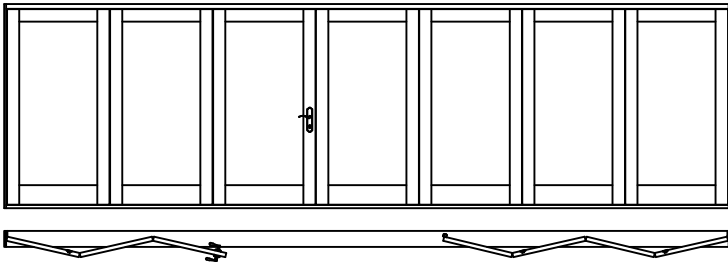

4L3R**^ Frame Width: 297 3/8" [7553] With Raised Moulding
297 1/8" [7547] No Raised Moulding

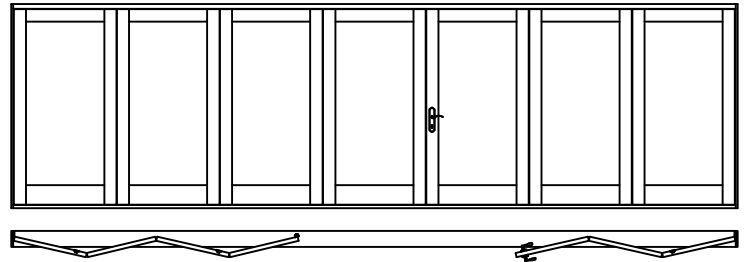

7L^ Frame Width: 297 1/8" [7547] With Raised Moulding
296 7/8" [7541] No Raised Moulding

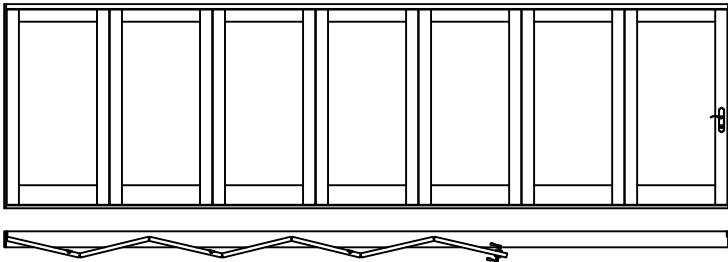

7R^ Frame Width: 297 1/8" [7547] With Raised Moulding
296 7/8" [7541] No Raised Moulding

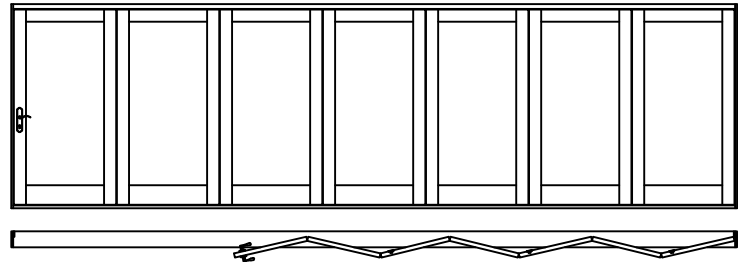

EXTERIOR FOLDING SYSTEM NOTES

All elevations viewed from exterior.

Hinges, flushbolts & carrier hardware included. Lockets not included, but available at an additional charge.

Frame Height = Door Height + 3 9/16"
 Standard Frame Heights:
 80" Door - 83 9/16" Frame
 84" Door - 87 9/16" Frame
 96" Door - 99 9/16" Frame
 108" Door - 111 9/16" Frame
 120" Door - 123 9/16" Frame

* Indicates a system configuration that does not require a lock. These systems will not be accessible from the exterior when the flushbolts are engaged, therefore are not recommended unless an additional exit door is nearby. Dummy trim set options are available.

^ Indicates a system configuration that will require an active lock only. The end panel will be active (manned door).

**^ Indicates a system configuration that will require an active lock and an optional dummy trim set. In odd-odd configurations, the customer may choose which door will be active (manned door). In odd-even configurations, the leading odd panel will be active (manned door).

8 DOOR CONFIGURATIONS

2L6R*

Frame Width:
339 11/16" [8628]
With Raised Moulding

339 7/16" [8622]
No Raised Moulding

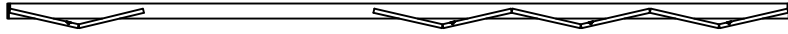
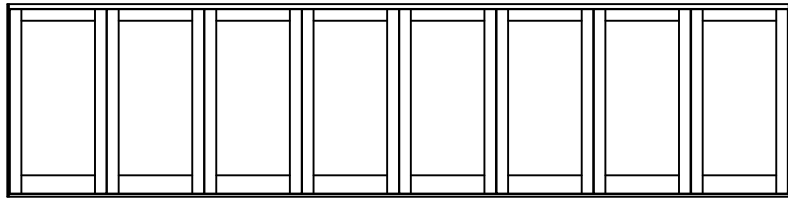

6L2R*

Frame Width:
339 11/16" [8628]
With Raised Moulding

339 7/16" [8622]
No Raised Moulding

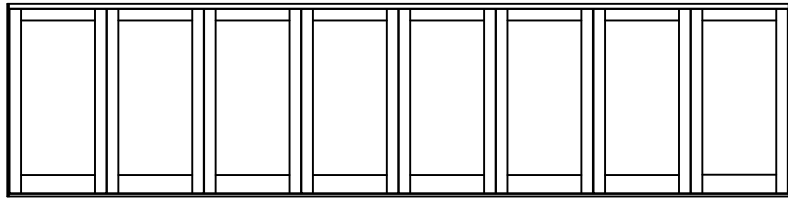

4L4R*

Frame Width:
339 11/16" [8628]
With Raised Moulding

339 7/16" [8622]
No Raised Moulding

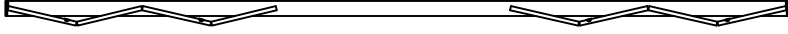
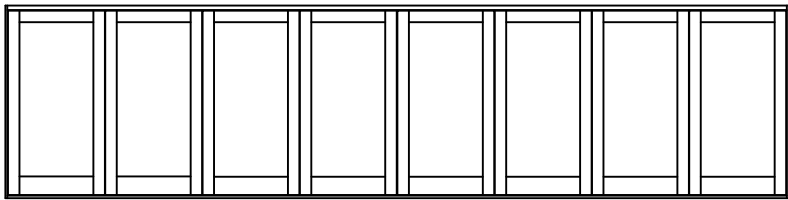

1L7R**^ Frame Width: 339 7/16" [8622] With Raised Moulding
339 3/16" [8615] No Raised Moulding

7L1R**^ Frame Width: 339 7/16" [8622] With Raised Moulding
339 3/16" [8615] No Raised Moulding

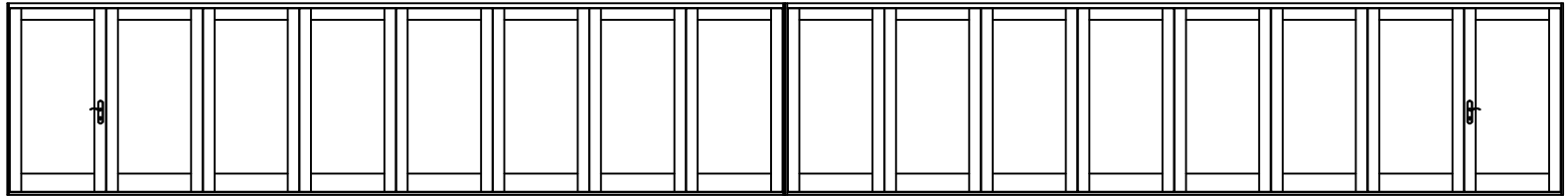

3L5R**^ Frame Width: 339 7/16" [8622] With Raised Moulding
339 3/16" [8615] No Raised Moulding

5L3R**^ Frame Width: 339 7/16" [8622] With Raised Moulding
339 3/16" [8615] No Raised Moulding

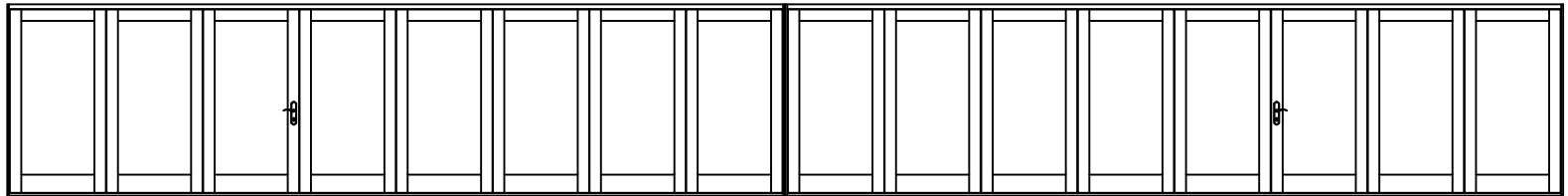

8L* Frame Width: 339 7/16" [8622] With Raised Moulding
339 3/16" [8615] No Raised Moulding

8R* Frame Width: 339 7/16" [8622] With Raised Moulding
339 3/16" [8615] No Raised Moulding

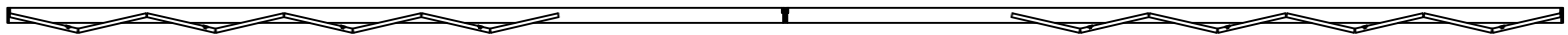
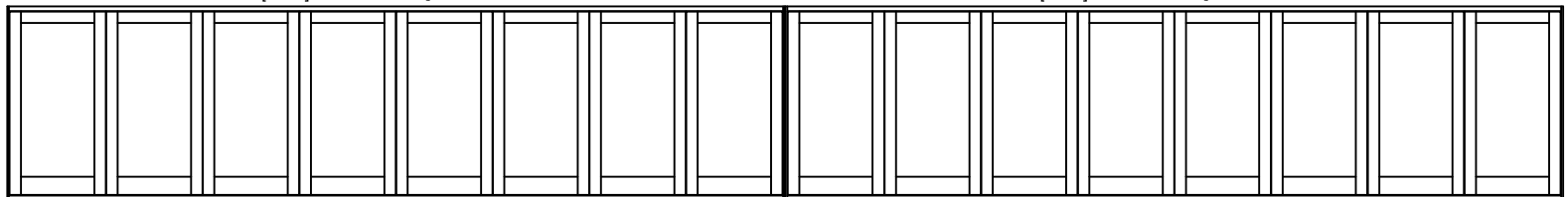

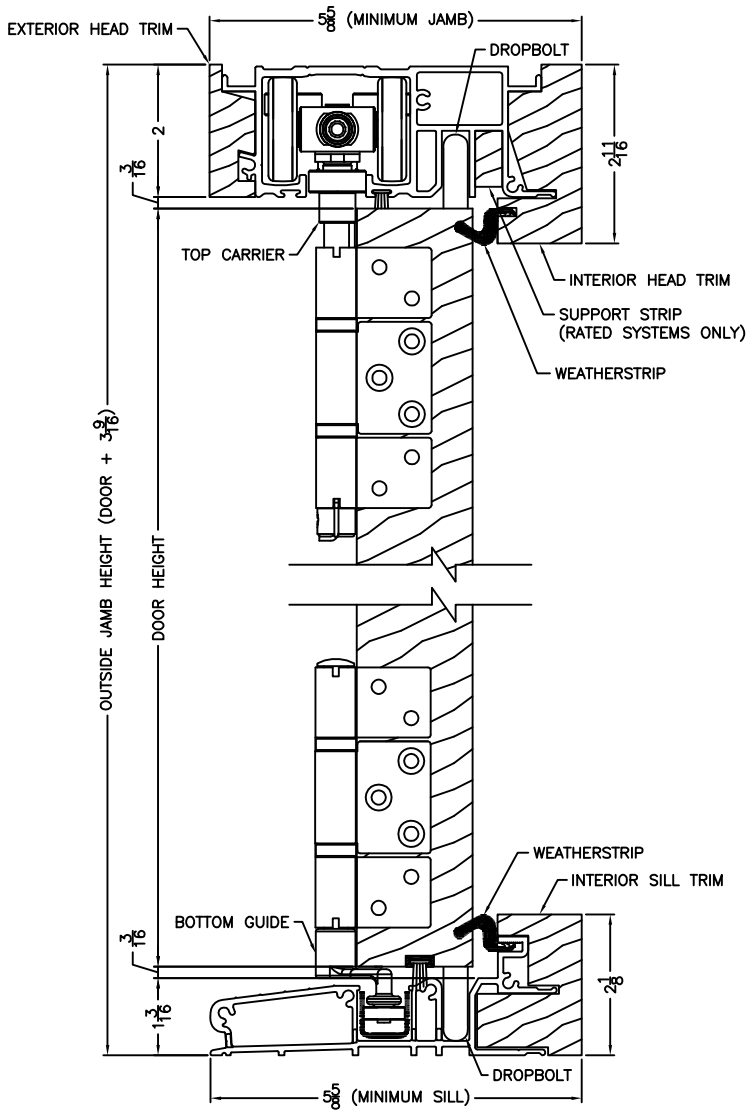

STANDARD SILL & HEAD

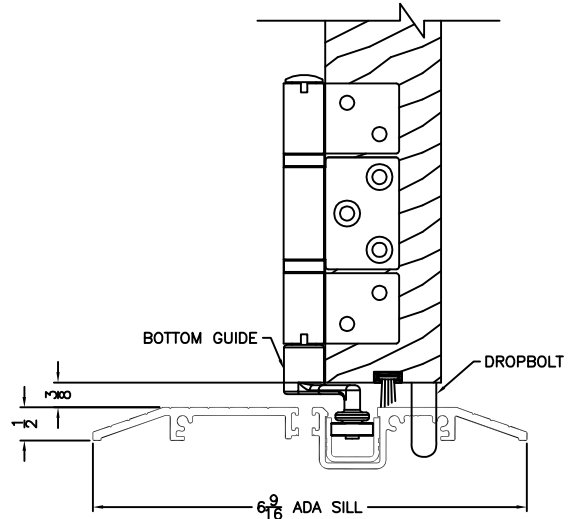

ADA SILL
(Available Upon Request)

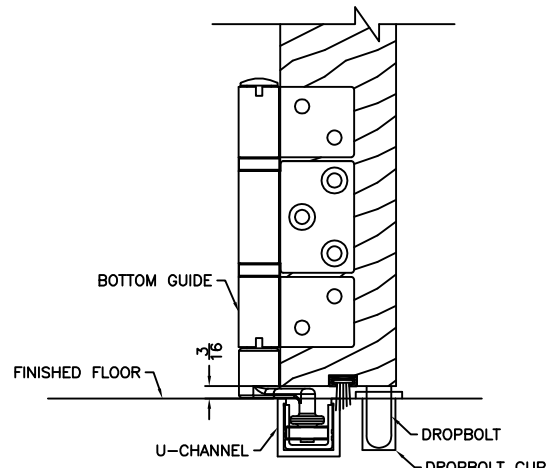

U-CHANNEL
(Available Upon Request)

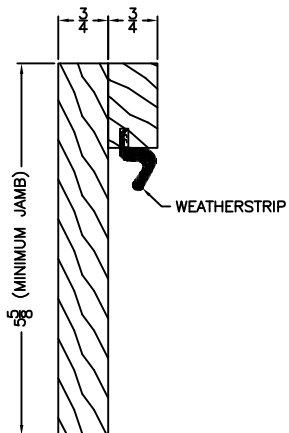

SIDE JAMB PROFILE

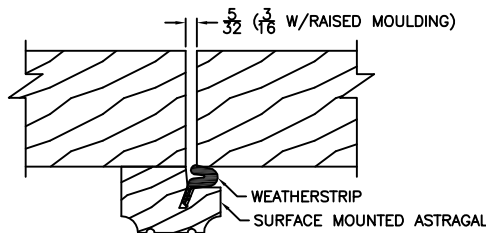

PANEL-TO-PANEL GAP AT ASTRAGAL

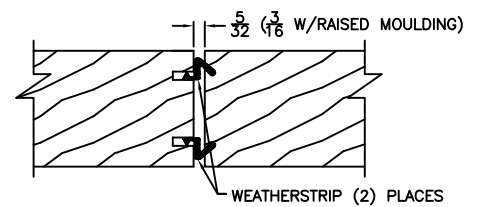

PANEL-TO-PANEL GAP

Notes:

No warranty for air or water infiltration with ADA sill or U-Channel.