

TABLE OF CONTENTS

1/2 VIEW

Elevations: 1/8" Scale

A110

A112

A115

A412

A890

A1202

A1322

A5144

A5944

Additional Sidelight Options

A1200

A1300

A5702

A5703

Decorative Hardware

Glass Design Options

Section Details

A110

A112

A115

A412

A890

A1202

A1322

A5144

A5944

A5702

A5703

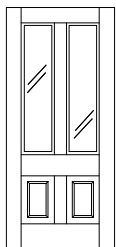

A110

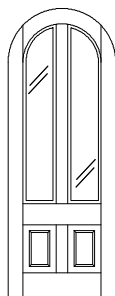

**A110
RADIUS**

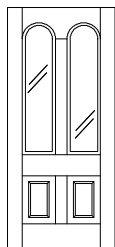

A112

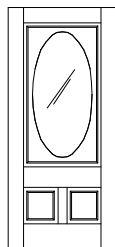

A115

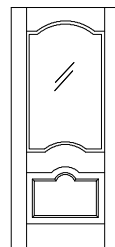

A412

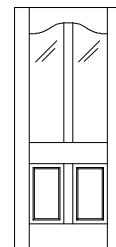

A890

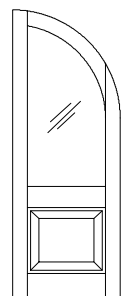

**A1202
HALF RADIUS**

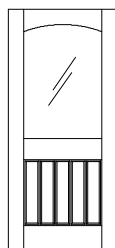

A1322

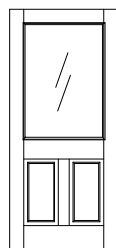

A5144

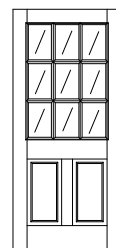

A5944

ELEVATION NOTES

Door Size = Book Size Before Prefit
Daylight Opening (DLO) = Visible Glass

Values in brackets [] are millimeter conversions.
See A110 Glass Detail Sheet for glass options.

DOOR CROSS-SECTION

Moulding Profile = 112
Panel Profile = Double Hip
See A110 Cross Section sheet for more detail.

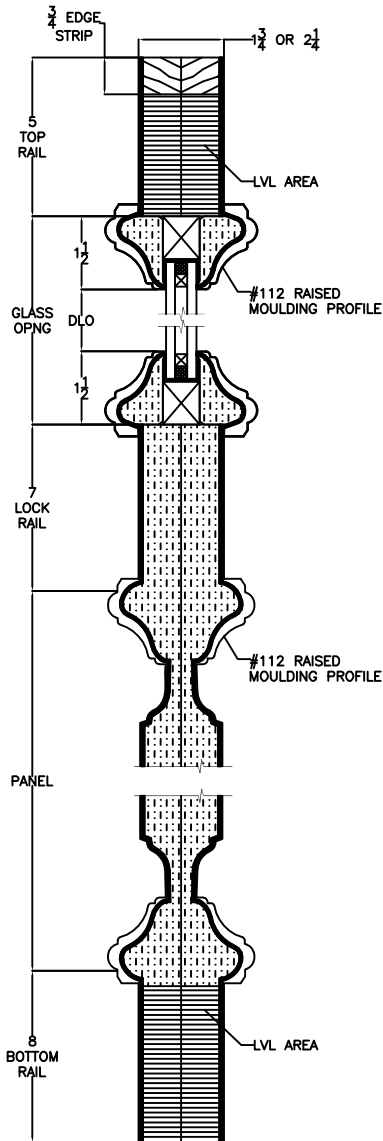

VERTICAL CROSS SECTION

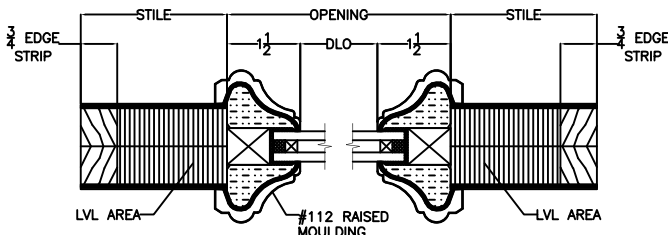
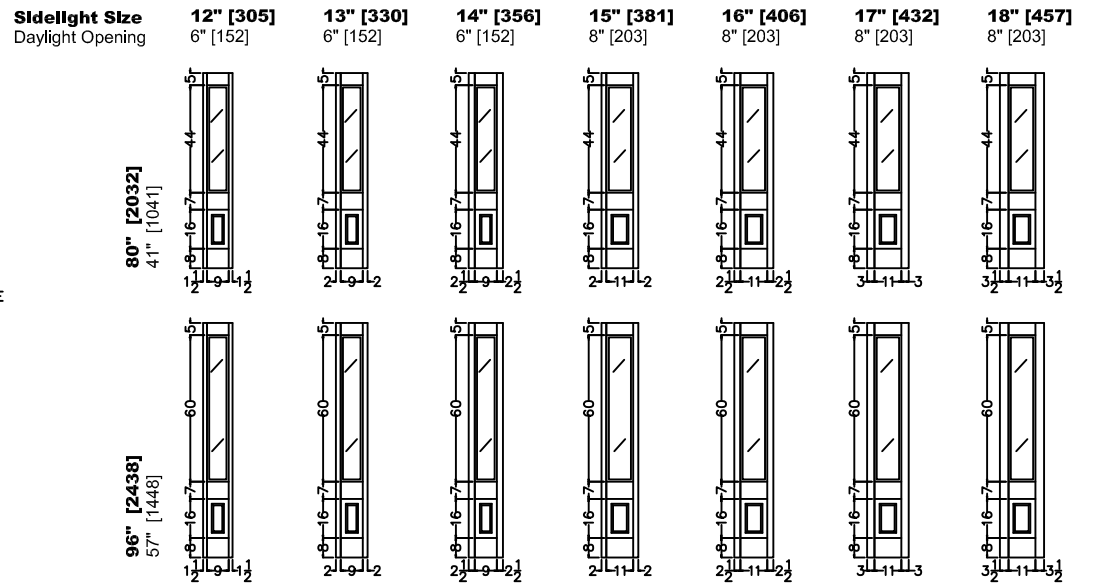
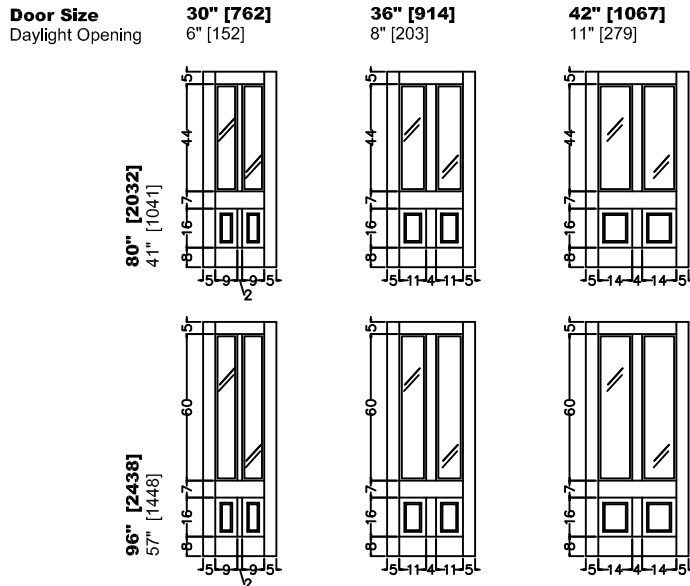

HORIZONTAL CROSS SECTION

ELEVATION NOTES

Door Size = Book Size Before Prefit
Daylight Opening (DLO) = Visible Glass

Values in brackets [] are millimeter conversions.
See A110 Glass Detail Sheet for glass options.

DOOR CROSS-SECTION

Moulding Profile = 112
Panel Profile = Double Hip
See A110 Cross Section sheet for more detail.

Door Size
Daylight Opening

36" [914]
8" [203]

42" [1067]
11" [279]

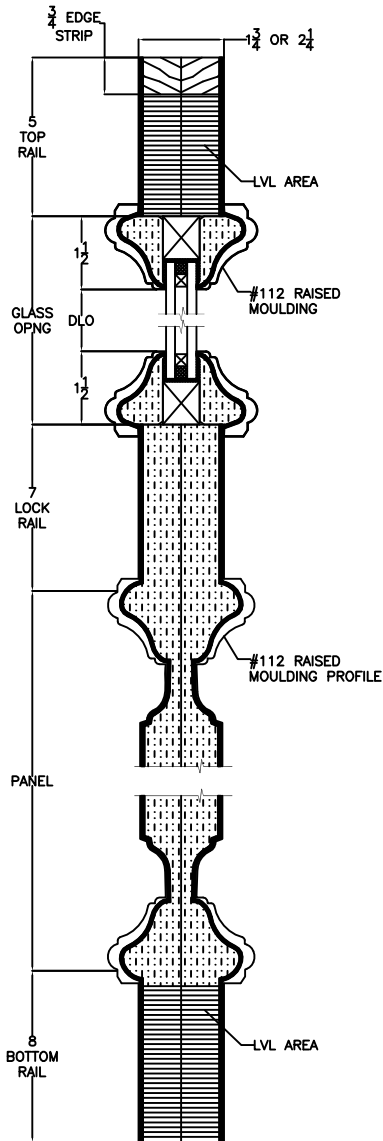
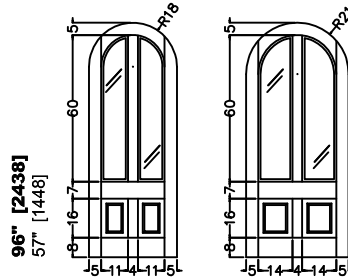

VERTICAL CROSS SECTION

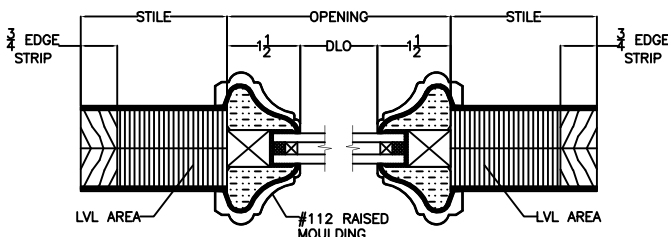

HORIZONTAL CROSS SECTION

ELEVATION NOTES

Door Size = Book Size Before Prefit
Daylight Opening (DLO) = Visible Glass

Values in brackets [] are millimeter conversions.
See A112 Glass Detail Sheet for glass options.

DOOR CROSS-SECTION

Moulding Profile = 112
Panel Profile = Double Hip
See A112 Cross Section sheet for more detail.

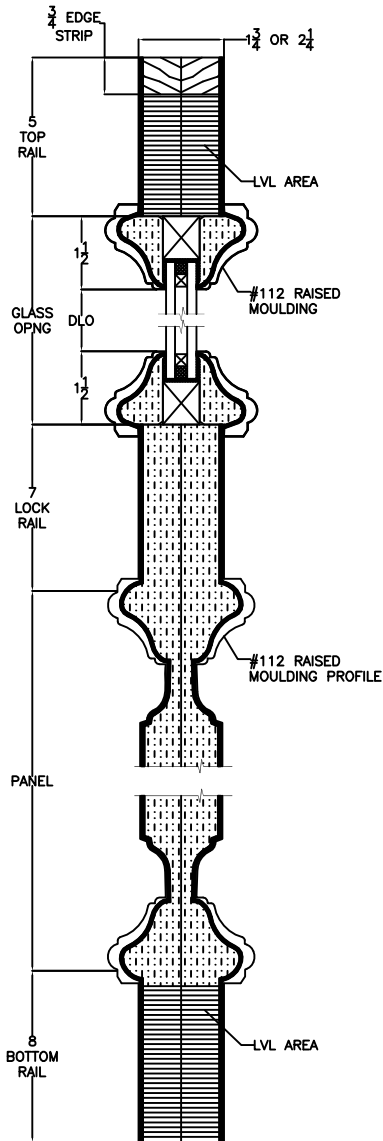

VERTICAL CROSS SECTION

Door Size
Daylight Opening

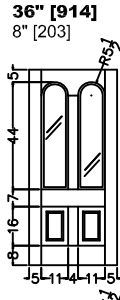
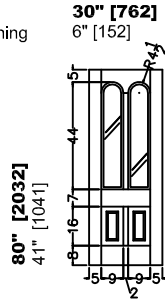

42" [1067]
11" [279]

96" [2438]
57" [1448]

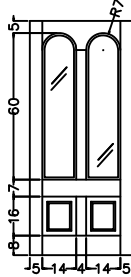
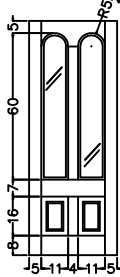

Sidelight Size
Daylight Opening

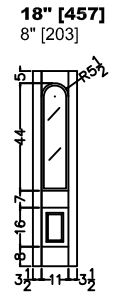
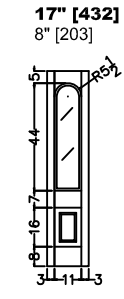
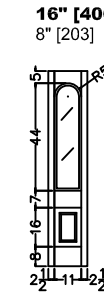
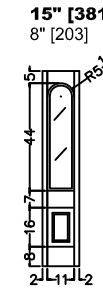
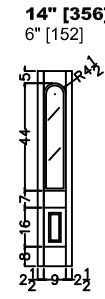
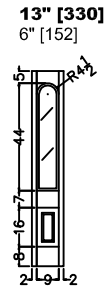
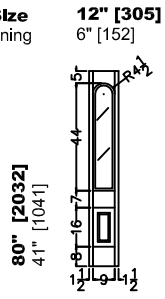

96" [2438]
57" [1448]

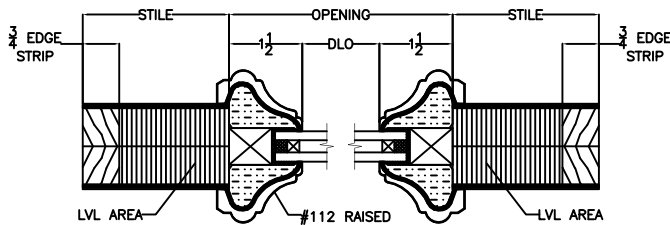
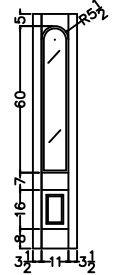
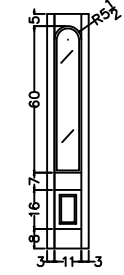
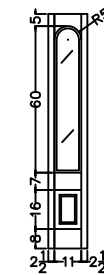
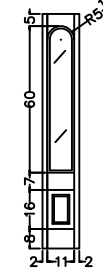
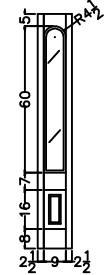
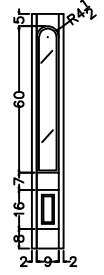

HORIZONTAL CROSS SECTION

ELEVATION NOTES

Door Size = Book Size Before Prefit
Daylight Opening (DLO) = Visible Glass

Values in brackets [] are millimeter conversions.
See A115 Glass Detail Sheet for glass options.

DOOR CROSS-SECTION

Moulding Profile = 141
Panel Profile = 45 Degree
See A115 Cross Section sheet for more detail.

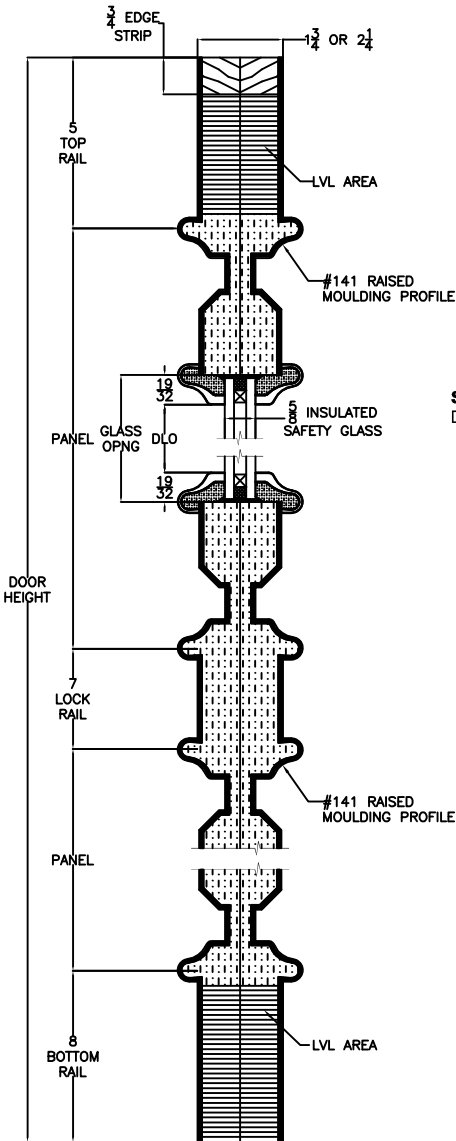

VERTICAL CROSS SECTION

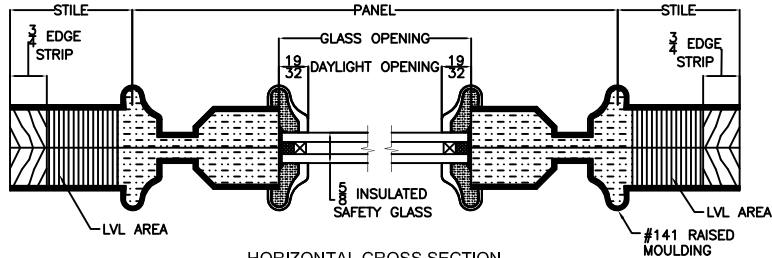

HORIZONTAL CROSS SECTION

WITHOUT CARVING

Door Size 36" [914] 42" [1067]
Daylight Opening 18 13/16" [478] 18 13/16" [478]

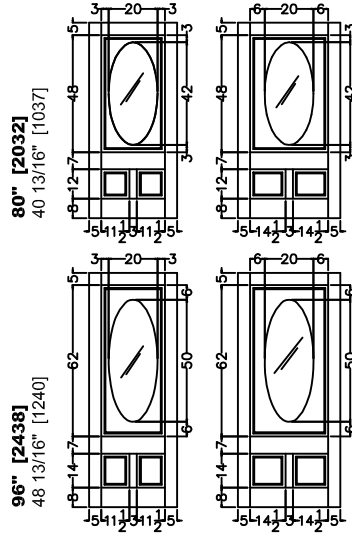

WITH CARVING

Door Size 36" [914] 42" [1067]
Daylight Opening 18 13/16" [478] 18 13/16" [478]

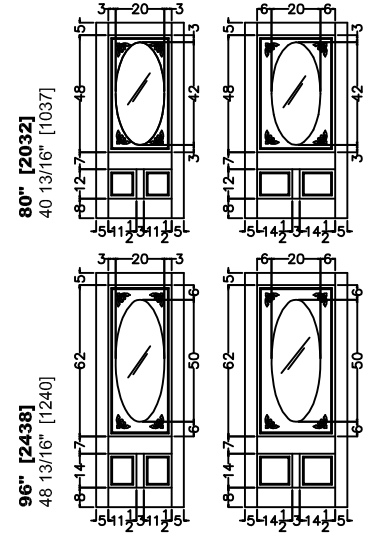

Sidelight Size
Daylight Opening

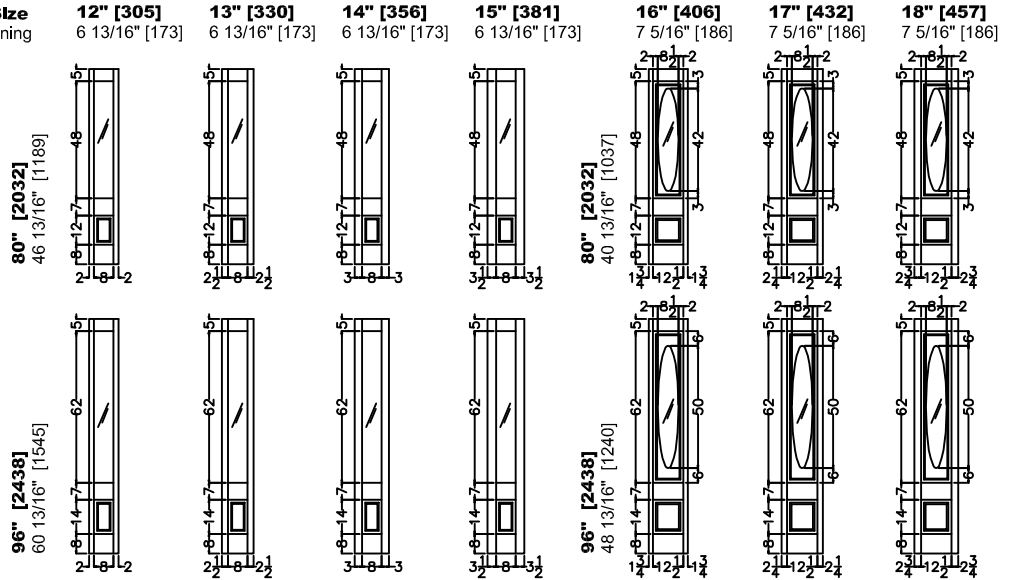

ELEVATION NOTES

Door Size = Book Size Before Prefit
Daylight Opening (DLO) = Visible Glass

Values in brackets [] are millimeter conversions.
See A412 Glass Detail Sheet for glass options.

DOOR CROSS-SECTION

Moulding Profile = 112
Panel Profile = Double Hip
See A412 Cross Section sheet for more detail.

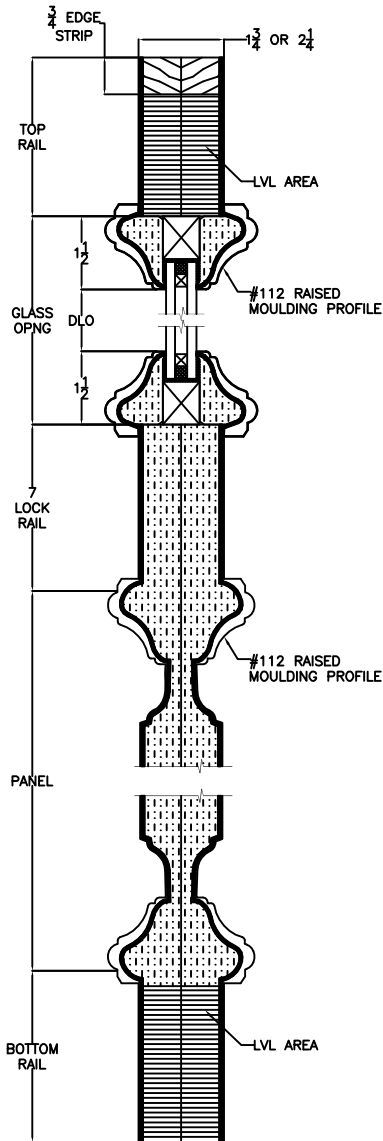

VERTICAL CROSS SECTION

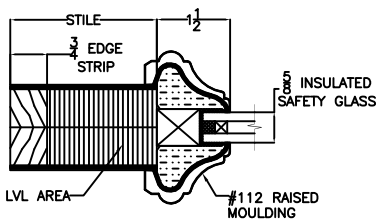

HORIZONTAL CROSS SECTION

Door Size
Daylight Opening

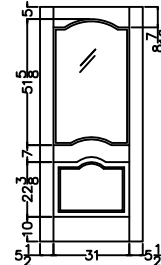
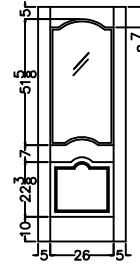
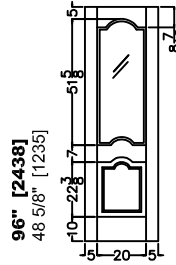
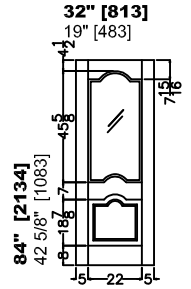
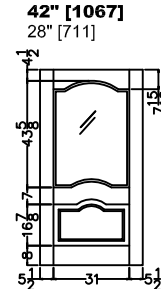
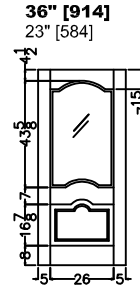
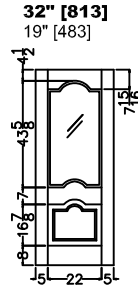
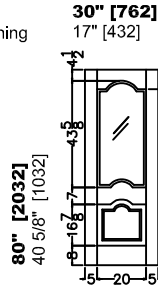

Sidelight Size
Daylight Opening

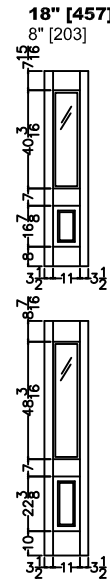
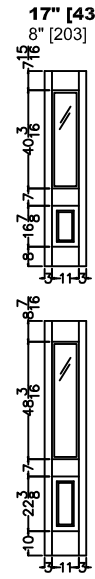
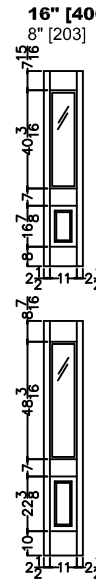
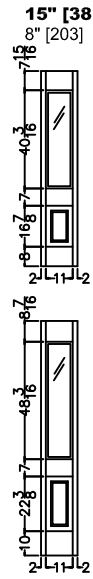
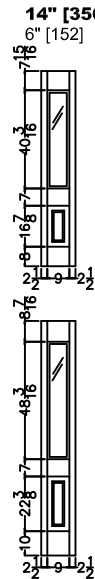
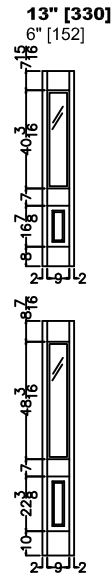
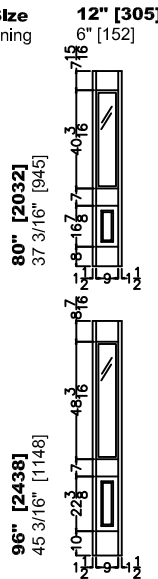

ELEVATION NOTES

Door Size = Book Size Before Prefit
Daylight Opening (DLO) = Visible Glass

Values in brackets [] are millimeter conversions.
See A890 Glass Detail Sheet for glass options.

DOOR CROSS-SECTION

Moulding Profile = 141
Panel Profile = 45 Degree
See A890 Cross Section sheet for more detail.

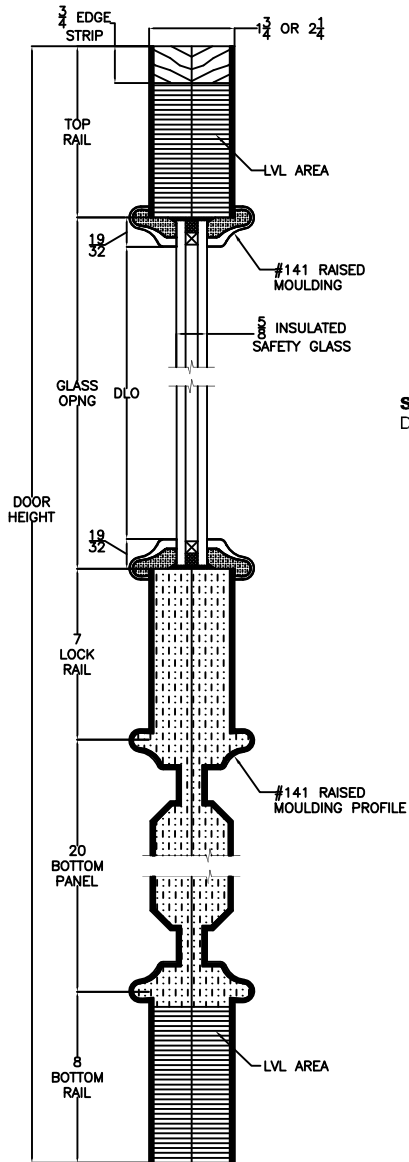

VERTICAL CROSS SECTION

WITHOUT CARVING

Door Size 36" [914] 42" [1067]
Daylight Opening 10 5/16" [262] 12 5/16" [313]

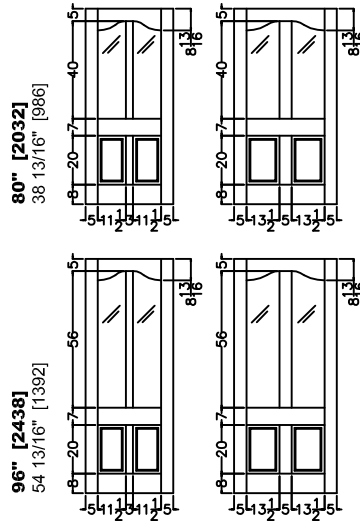

WITH CARVING

Door Size 36" [914] 42" [1067]
Daylight Opening 10 5/16" [262] 12 5/16" [313]

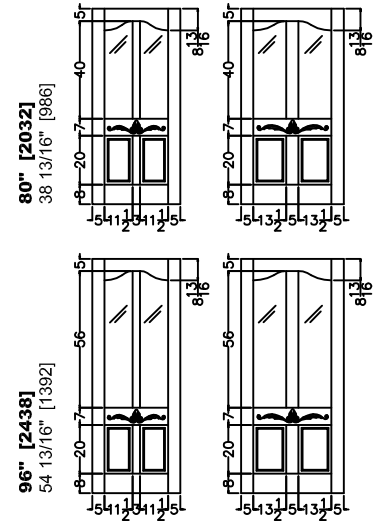

Sidelight Size 12" [305] 13" [330] 14" [356] 15" [381] 16" [406] 17" [432] 18" [457]
Daylight Opening 8 1/16" [205] 8 1/16" [205] 8 1/16" [205] 10 5/16" [262] 10 5/16" [262] 10 5/16" [262] 10 5/16" [262]

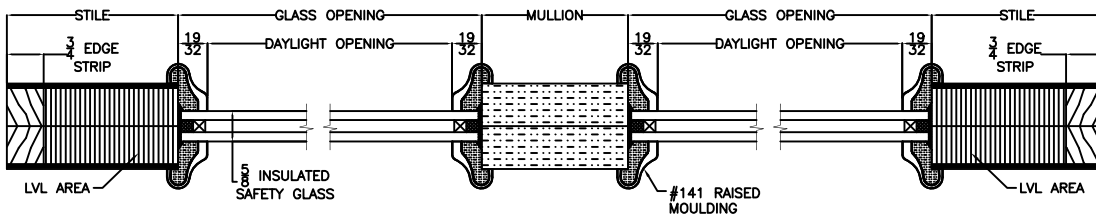
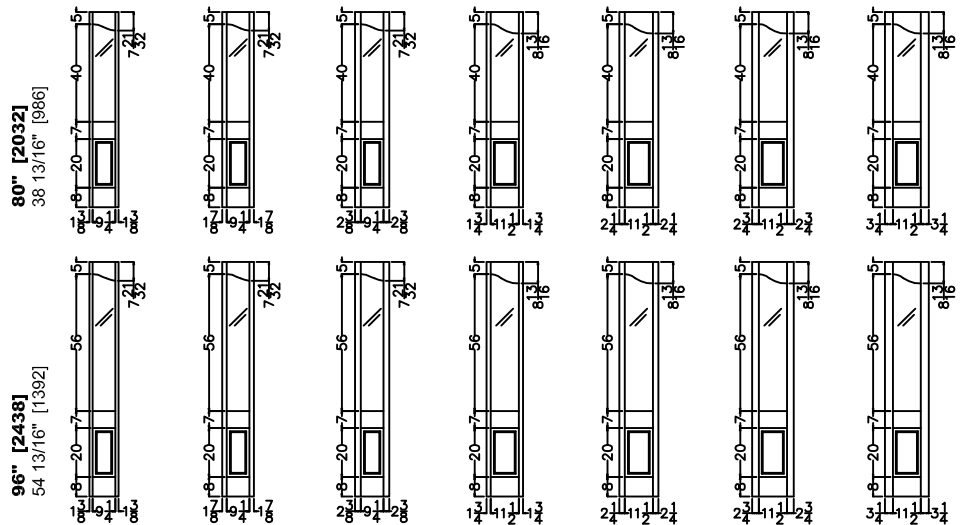

HORIZONTAL CROSS SECTION

ELEVATION NOTES

Door Size = Book Size Before Prefit
Daylight Opening (DLO) = Visible Glass

Values in brackets [] are millimeter conversions.

DOOR CROSS-SECTION

Moulding Profile = 1200 / 141
Panel Profile = Convex Long (Estate)
See A1202 Cross Section sheet for more detail.

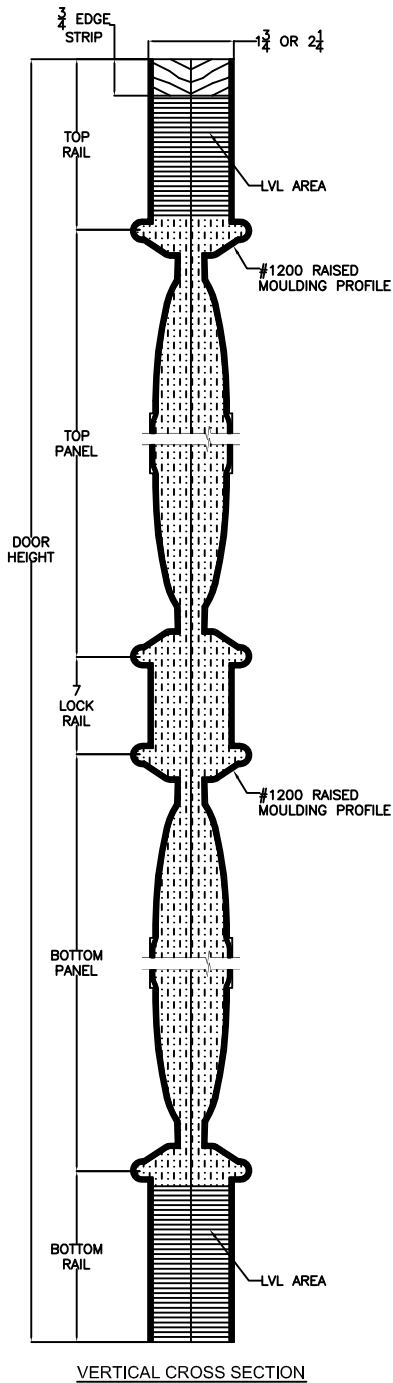

ALL PANEL-WITHOUT HARDWARE

Door Size
Daylight Opening

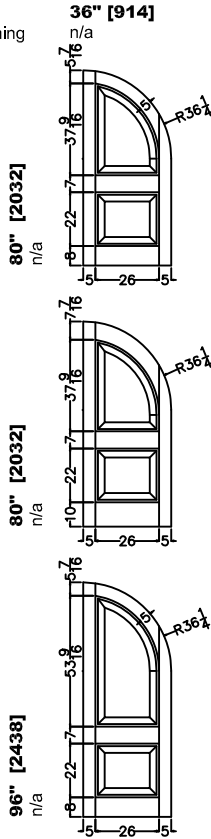

GLAZED-WITHOUT HARDWARE

Door Size
Daylight Opening

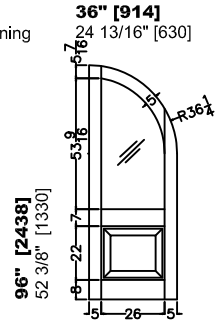

WITH 1.75" CLAVOS & STRAPS (Hardware Optional/ Custom Placement Available)

Door Size
Daylight Opening

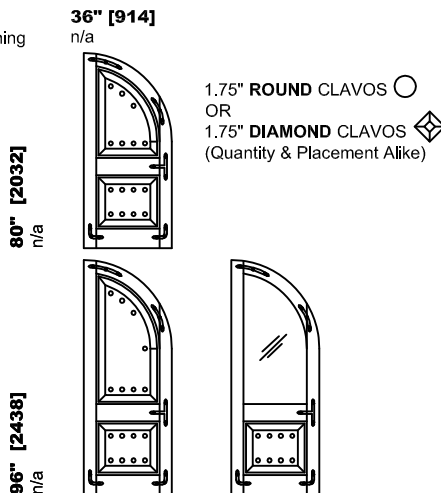

WITH 1" CLAVOS & STRAPS (Hardware Optional/ Custom Placement Available)

Door Size
Daylight Opening

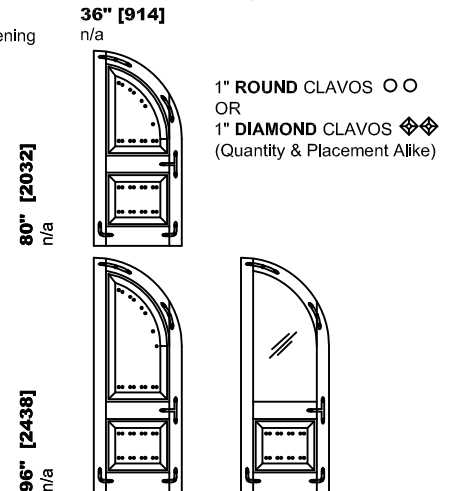

ELEVATION NOTES

Door Size = Book Size Before Prefit
Daylight Opening (DLO) = Visible Glass

Values in brackets [] are millimeter conversions.

DOOR CROSS-SECTION

Moulding Profile = n/a
Panel Profile = V-Groove (Estate Plank)
See A1322 Cross Section sheet for more detail.

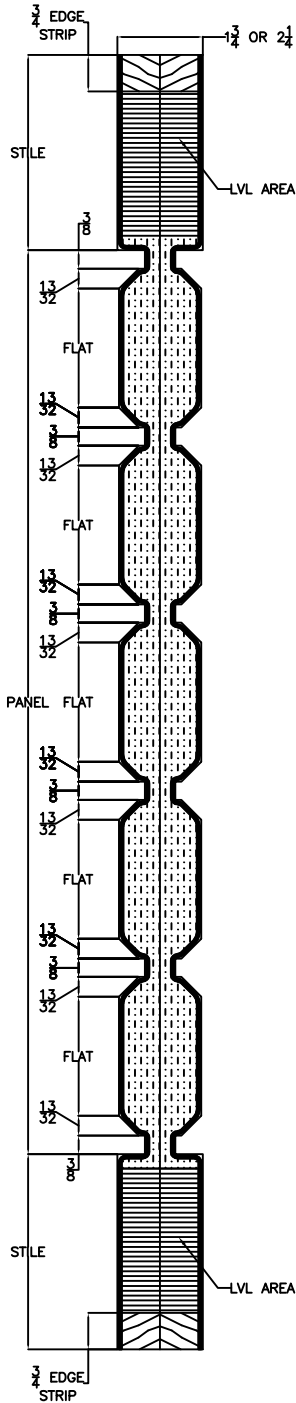

HORIZONTAL CROSS SECTION

Rotated for Clarity

Qty & Size of Planks Vary by Door Size

WITHOUT HARDWARE

Door Size 36" [914]
Daylight Opening n/a

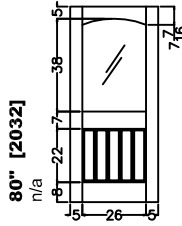

WITH 1" CLAVOS & STRAPS (Hardware Optional/ Custom Placement Available)

Door Size 36" [914]
Daylight Opening n/a

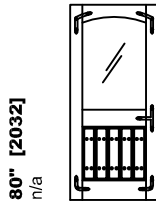

1" **ROUND** CLAVOS ○ ○
OR
1" **DIAMOND** CLAVOS ◆ ◆
(Quantity & Placement Alike)

WITH 1.75" CLAVOS & STRAPS (Hardware Optional/ Custom Placement Available)

Door Size 36" [914]
Daylight Opening n/a

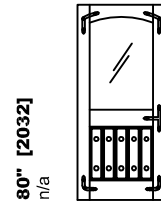

1.75" **ROUND** CLAVOS ○
OR
1.75" **DIAMOND** CLAVOS ◆
(Quantity & Placement Alike)

ELEVATION NOTES

Door Size = Book Size Before Prefit
Daylight Opening (DLO) = Visible Glass

Values in brackets [] are millimeter conversions.
Sidelight Match = A5702

DOOR CROSS-SECTION

Moulding Profile = 141
Panel Profile = 45 Degree
See A5144 Cross Section sheet for more detail.

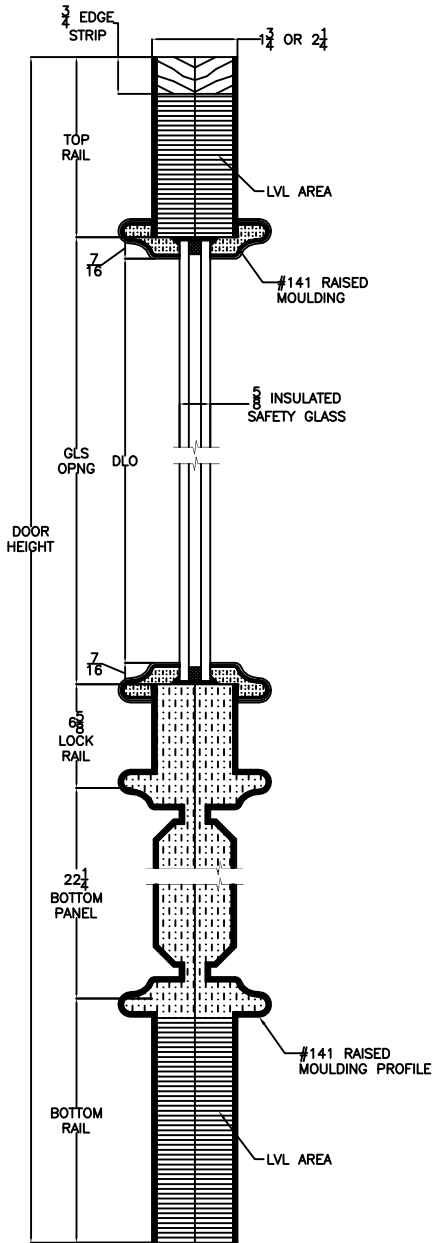

VERTICAL CROSS SECTION

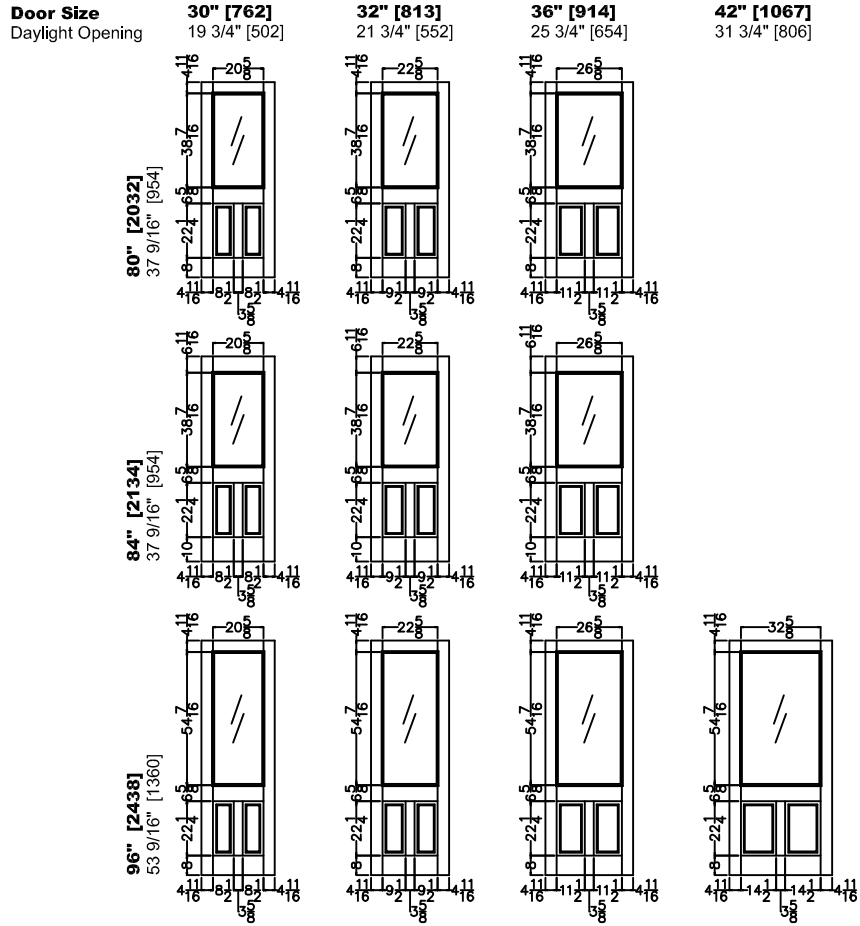

ELEVATION NOTES

Door Size = Book Size Before Prefit
Daylight Opening (DLO) = Visible Glass

Values in brackets [] are millimeter conversions.
Sidelight Match = A5703

DOOR CROSS-SECTION

Moulding Profile = 141
Panel Profile = 45 Degree
See A5944 Cross Section sheet for more detail.

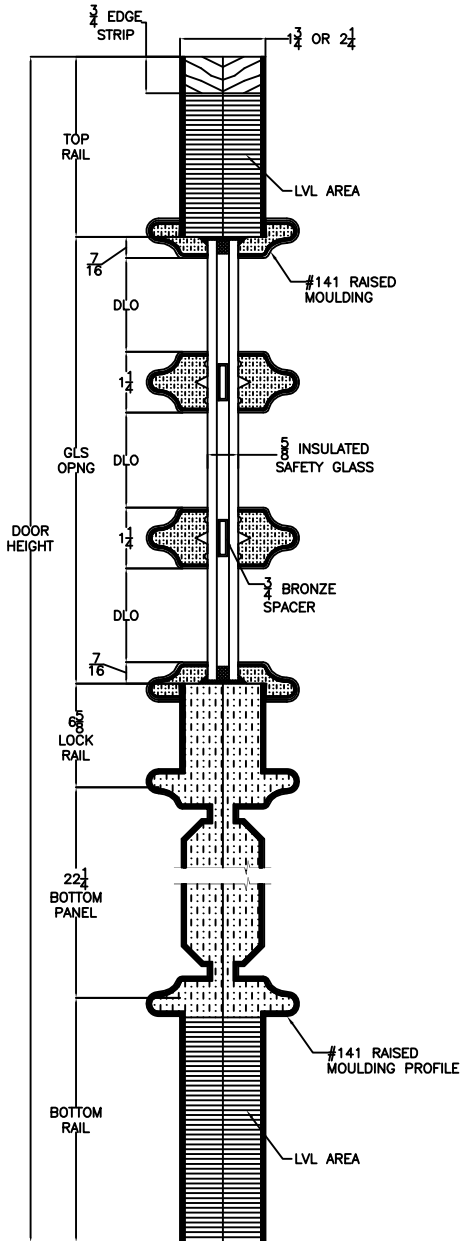

Door Size
Daylight Opening

30" [762]
5 3/4" [146]

32" [813]
6 13/32" [163]

36" [914]
7 3/4" [197]

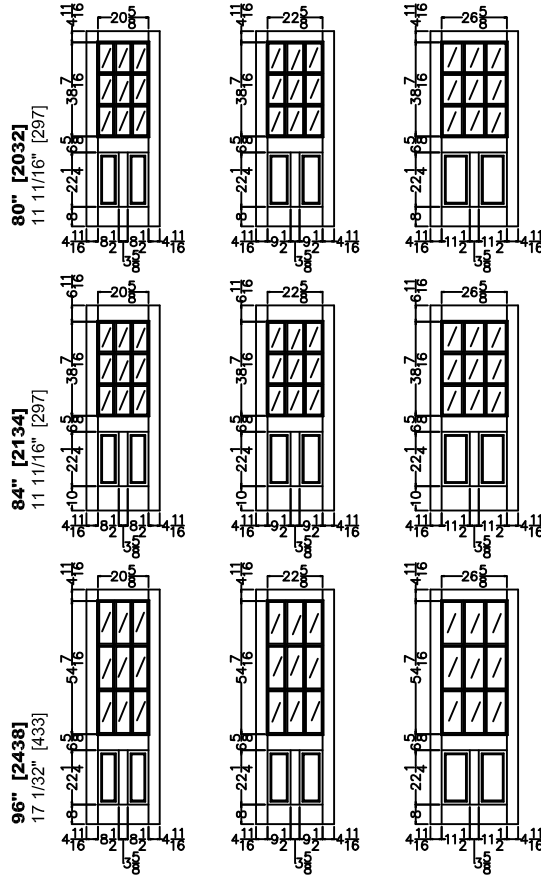

VERTICAL CROSS SECTION

ELEVATION NOTES

Door Size = Book Size Before Prefit
Daylight Opening (DLO) = Visible Glass

Values in brackets [] are millimeter conversions.

DOOR CROSS-SECTION

Moulding Profile = 141
Panel Profile = Convex Long (Estate)
*1-0 thru 1-3 Sidelight Convex Short
See A1200 Cross Section sheet for more detail.

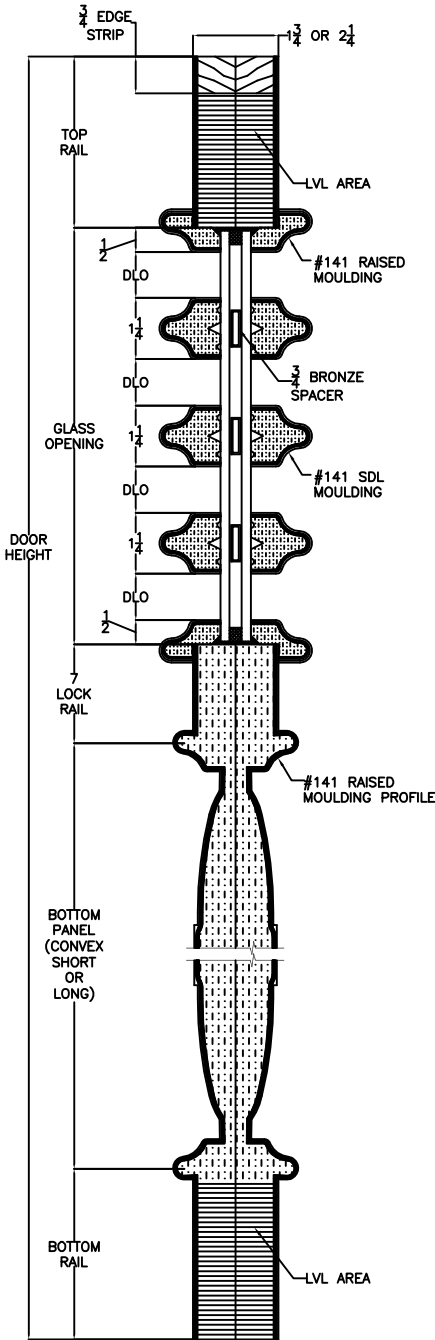

VERTICAL CROSS SECTION
4-LITE SDL SIDELIGHT ONLY

1-LITE SIDELIGHT

Sidelight Size	12" [305]	13" [330]	14" [356]	15" [381]	16" [406]	17" [432]	18" [457]
Daylight Opening	5 13/16" [148]	5 13/16" [148]	5 13/16" [148]	5 13/16" [148]	5 13/16" [148]	9 13/16" [249]	9 13/16" [249]

80" [2032]
36 13/16" [935]

84" [2134]
36 13/16" [935]

96" [2438]
52 13/16" [1341]

4-LITE SIDELIGHT

Sidelight Size	12" [305]	13" [330]	14" [356]	15" [381]	16" [406]	17" [432]	18" [457]
Daylight Opening	6 1/8" [156]	6 1/8" [156]	6 1/8" [156]	6 1/8" [156]	10 1/8" [257]	10 1/8" [257]	10 1/8" [257]

80" [2032]
8 11/32" [212]

84" [2134]
8 11/32" [212]

96" [2438]
12 11/32" [314]

3-LITE SIDELIGHT

Sidelight Size	12" [305]	13" [330]	14" [356]	15" [381]	16" [406]	17" [432]	18" [457]
Daylight Opening	6 1/8" [156]	6 1/8" [156]	6 1/8" [156]	6 1/8" [156]	10 1/8" [257]	10 1/8" [257]	10 1/8" [257]

80" [2032]
11 9/32" [287]

Not Available

Not Available

Not Available

Not Available

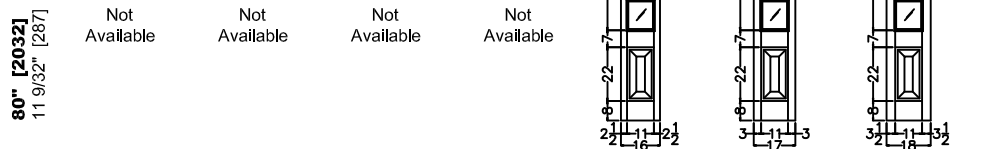

ELEVATION NOTES

Door Size = Book Size Before Prefit
Daylight Opening (DLO) = Visible Glass

Values in brackets [] are millimeter conversions.

DOOR CROSS-SECTION

Moulding Profile = 141 or Square
Panel Profile = V-Groove
See A1300 Cross Section sheet for more detail.

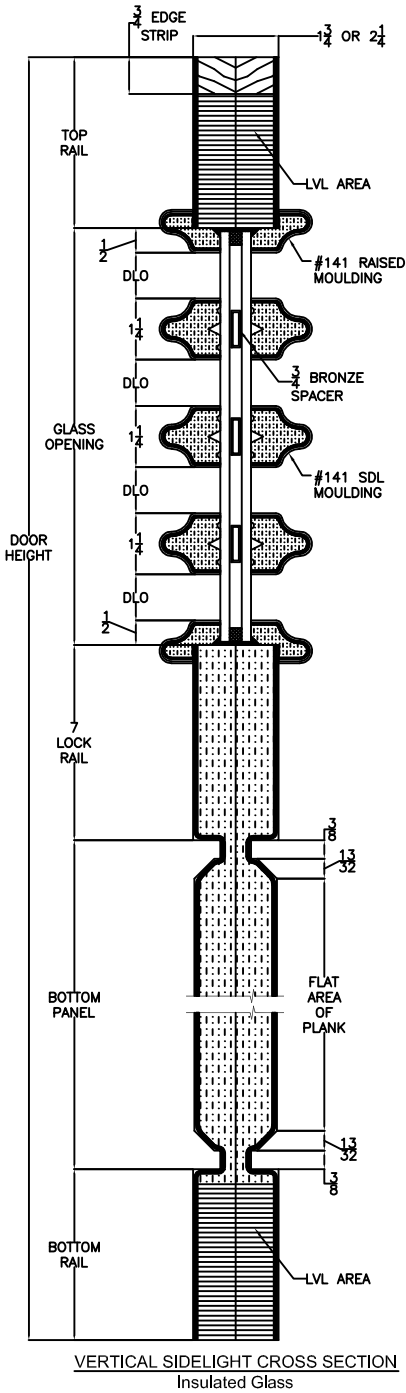

1-LITE SIDELIGHT

Sidelight Size	12" [305]	13" [330]	14" [356]	15" [381]	16" [406]	17" [432]	18" [457]
Daylight Opening	5 13/16" [148]	5 13/16" [148]	5 13/16" [148]	5 13/16" [148]	9 13/16" [249]	9 13/16" [249]	9 13/16" [249]

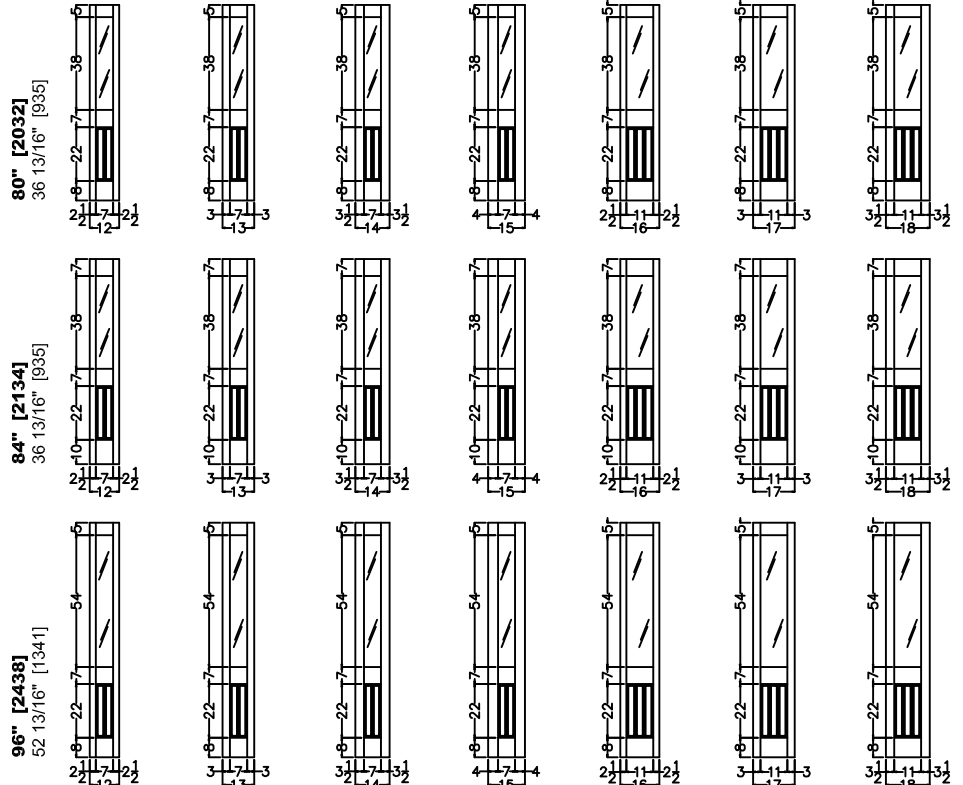

4-LITE SIDELIGHT

Sidelight Size	12" [305]	13" [330]	14" [356]	15" [381]	16" [406]	17" [432]	18" [457]
Daylight Opening	6 1/8" [156]	6 1/8" [156]	6 1/8" [156]	6 1/8" [156]	10 1/8" [257]	10 1/8" [257]	10 1/8" [257]

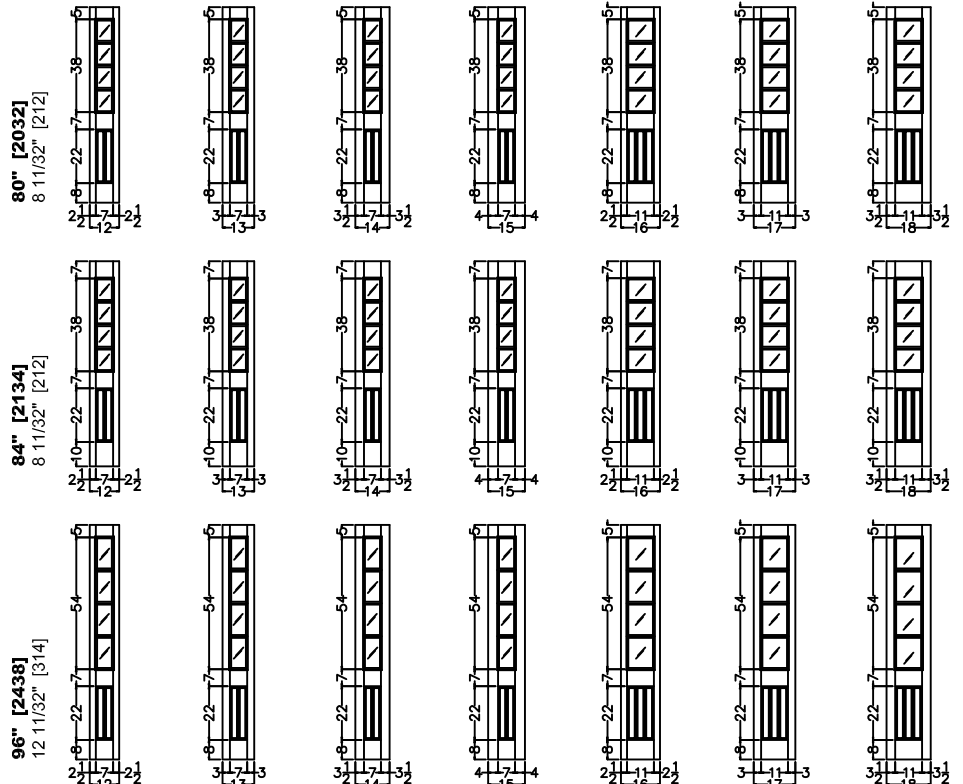

ELEVATION NOTES

Door Size = Book Size Before Prefit
Daylight Opening (DLO) = Visible Glass

Values in brackets [] are millimeter conversions.

DOOR CROSS-SECTION

Moulding Profile = 141
Panel Profile = 45 Degree
See A5702 Cross Section sheet for more detail.

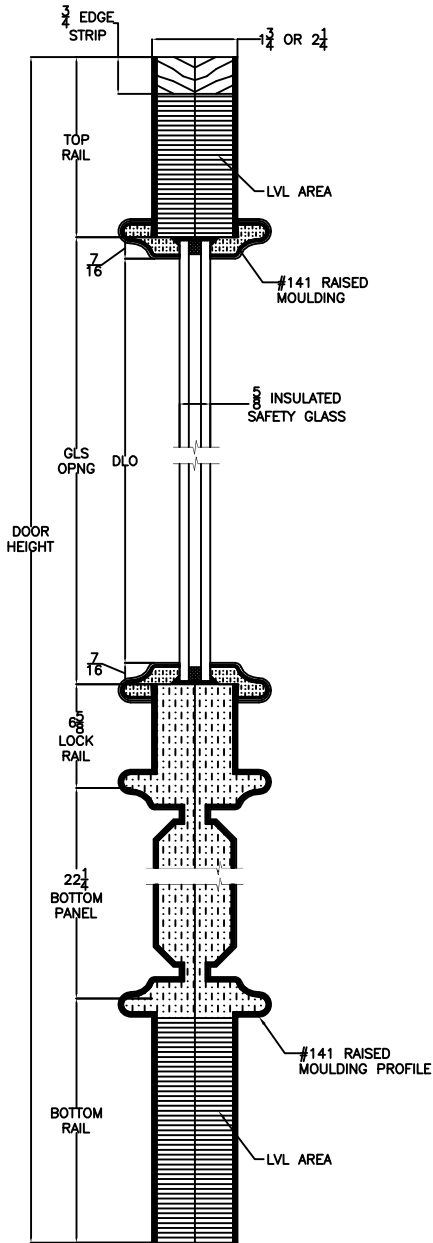

VERTICAL CROSS SECTION

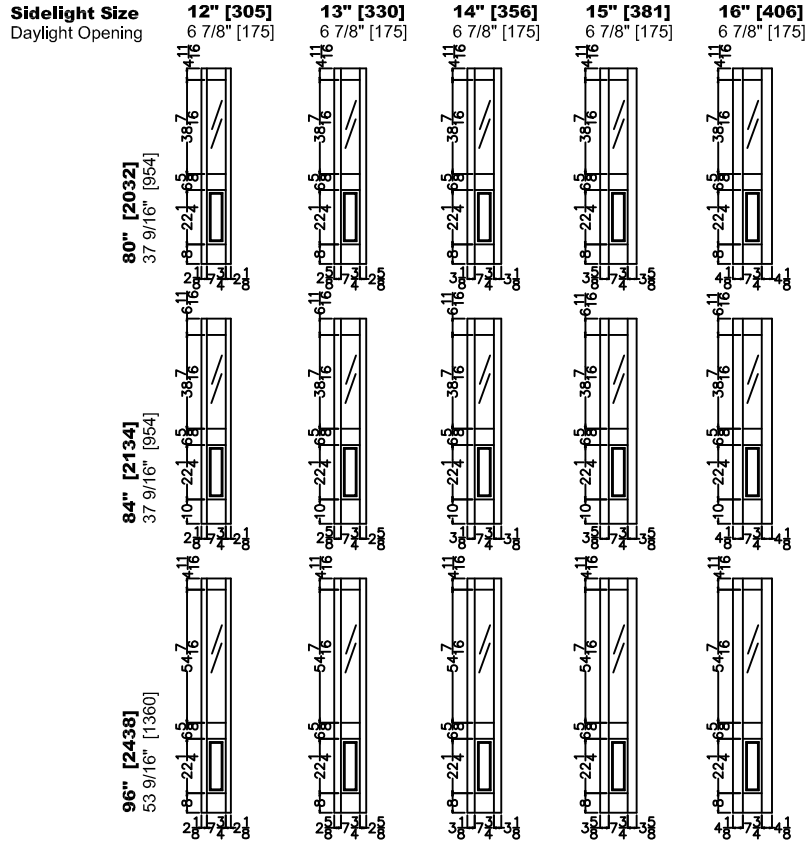

ELEVATION NOTES

Door Size = Book Size Before Prefit
Daylight Opening (DLO) = Visible Glass

Values in brackets [] are millimeter conversions.

DOOR CROSS-SECTION

Moulding Profile = 141
Panel Profile = 45 Degree
See A5703 Cross Section sheet for more detail.

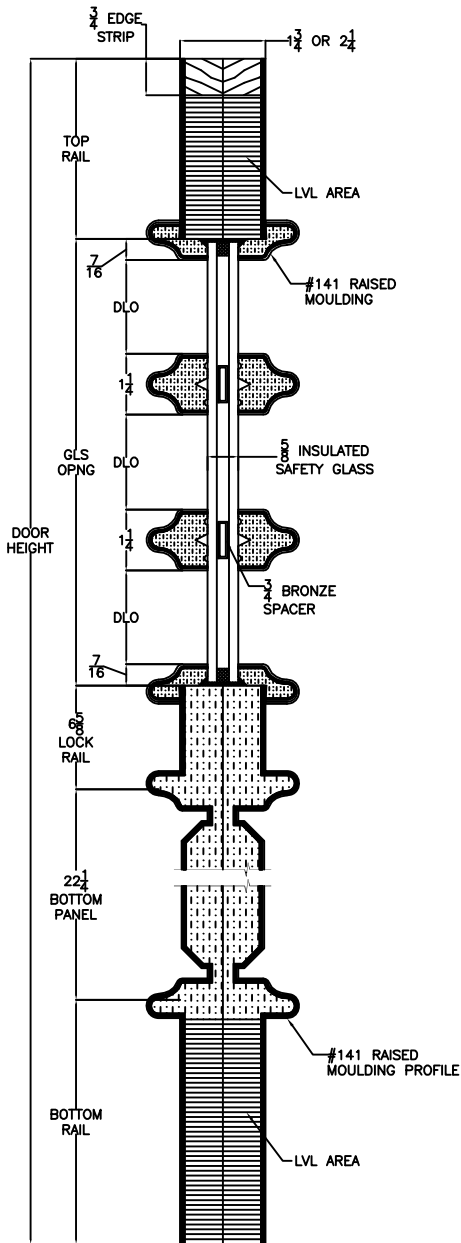

VERTICAL CROSS SECTION

Sidelight Size
Daylight Opening

12" [305]
6 7/8" [175]

13" [330]
6 7/8" [175]

14" [356]
6 7/8" [175]

15" [381]
6 7/8" [175]

16" [406]
6 7/8" [175]

80" [2032]
11 11/16" [297]

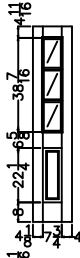
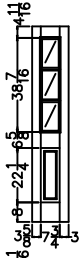
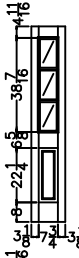
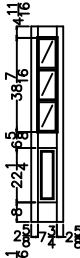
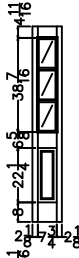

84" [2134]
11 11/16" [297]

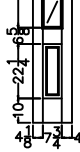
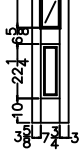
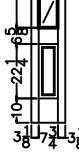
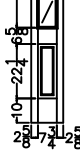
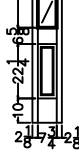

96" [2438]
17 1/32" [433]

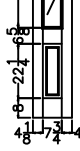
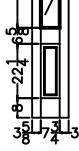
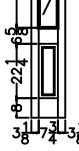
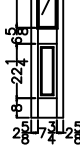
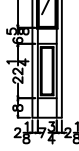



ROUND CLAVOS

Size Options: 1" diameter, 1.75" diameter
Finish Options: Dark Patina, Rust Patina
Material: Composite



DIAMOND CLAVOS

Size Options: 1", 1.75"
Finish Options: Dark Patina, Rust Patina
Material: Composite

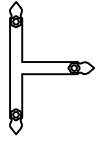

RAIL STRAP

Finish Options: Dark Patina, Rust Patina
Material: Composite



CORNER STRAP

Finish Options: Dark Patina, Rust Patina
Material: Composite

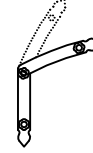

RADIUS STRAP

Finish Options: Dark Patina, Rust Patina
Material: Composite
Adjustable for Segment/Radius Shapes

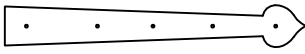

EXTENDED STRAP

Size: 25" x 3 1/4"
Finish Options: Dark Patina, Rust Patina
Material: Composite

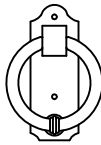

COLONIAL DOOR KNOCKER

Base: 2" Wide x 5 5/8" Tall, Handle: 4" Wide
Finish Options: Dark Patina, Rust Patina
Material: Composite



FLEUR de LIS DOOR KNOCKER

Base + Handle: 3 3/4" Wide x 4 7/8" Tall
Finish Options: Dark Patina, Rust Patina
Material: Composite

SPEAKEASY/DOOR LIGHT

Glass Options: Clear IG, Clear SG, Bevel IG, Bevel SG, Glue Chip IG,
Low E IG, Rain IG, Reed IG, Frosted IG, Open for Glass
Handing: Will be Handed to Match the Door unless Otherwise Specified
Frame Size: 12" x 15", Daylight Opening: 8" x 11", Actual Glass Size: 8 7/8" x 11 7/8"

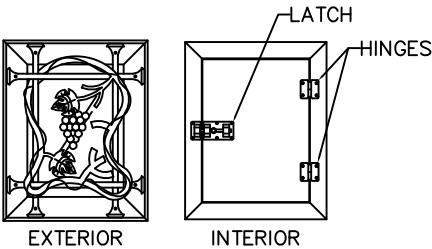

BORDEAUX SPEAKEASY

Hardware Finish Options: Dark Patina, Rust Patina
Material: Composite (Aluminum Hardware)

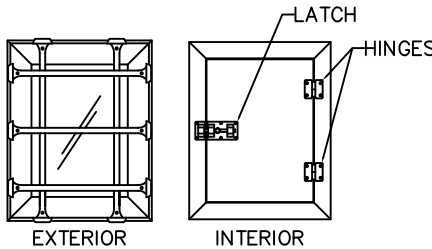

RUSTIC SPEAKEASY

Hardware Finish Options: Dark Patina, Rust Patina
Material: Composite (Aluminum Hardware)

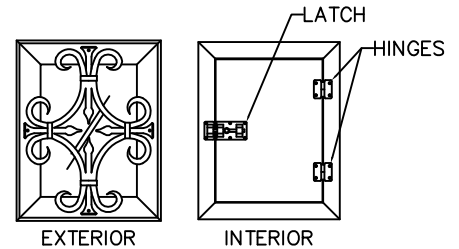

SEVILLE SPEAKEASY

Hardware Finish Options: Dark Patina, Rust Patina
Material: Composite (Aluminum Hardware)

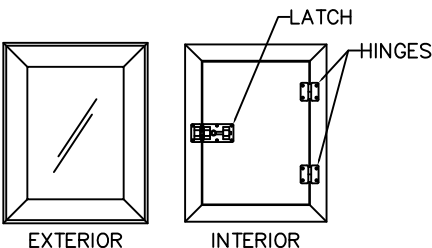

SPEAKEASY (NO GRILLE)

Hardware Finish Options: Dark Patina, Rust Patina
Material: Composite (Aluminum Hardware)

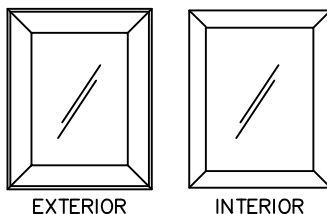

RECTANGLE DOOR LIGHT

Hardware Finish Options: n/a
Material: Composite
Available with All Speakeasy Grilles

INSULATED GLASS

Clear Safety
Clear Beveled
Glue Chip
Low-E
Rain
Reed
Frosted

TRIPLE GLAZED

D - J - Q - R - T

"D" GLASS

Door Size	30"	36"	42"
Glass Size	7 1/8"	9 1/8"	12 1/8"
80" Door 42 1/8" Glass			
96" Door 58 1/8" Glass			

LEGEND
CB-Clear Bevel
GC-Glue Chip
GV-Glue Chip Bevel
RI-Ripple

"J" GLASS

Door Size	30"	36"	42"
Glass Size	7 1/8"	9 1/8"	12 1/8"
80" Door 42 1/8" Glass			
96" Door 58 1/8" Glass			

LEGEND
CB-Clear Bevel
GC-Glue Chip
J-Jewel

"Q" GLASS

Door Size	30"	36"	42"
Glass Size	7 1/8"	9 1/8"	12 1/8"
80" Door 42 1/8" Glass			
96" Door 58 1/8" Glass			

LEGEND
CB-Clear Bevel
CO-Cotswald
RD-Reed

"R" GLASS

Door Size	30"	36"	42"
Glass Size	7 1/8"	9 1/8"	12 1/8"
80" Door 42 1/8" Glass			
96" Door 58 1/8" Glass			

LEGEND
CB-Clear Bevel
GC-Glue Chip
BQ-Clear Baroque

"T" GLASS

Door Size	30"	36"	42"
Glass Size	7 1/8"	9 1/8"	12 1/8"
80" Door 42 1/8" Glass			
96" Door 58 1/8" Glass			

LEGEND
CB-Clear Bevel
GC-Glue Chip
GA-Clear Gotta

INSULATED GLASS

Clear Safety
Clear Beveled
Glue Chip
Low-E
Rain
Reed
Frosted

TRIPLE GLAZED

D - J - Q - R - T

"D" GLASS

Door Size
Glass Size

36" 42"
9 1/8" 12 1/8"

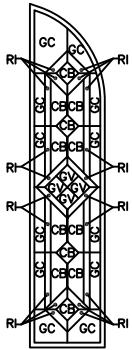

LEGEND
CB-Clear Bevel
GC-Glue Chip
GV-Glue Chip Bevel
RI-Ripple

80" Door
41 3/4" Glass

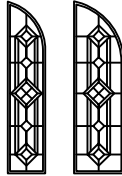

96" Door
57 3/4" Glass

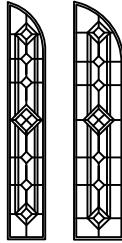

"J" GLASS

Door Size
Glass Size

36" 42"
9 1/8" 12 1/8"

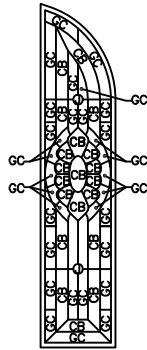

LEGEND
CB-Clear Bevel
GC-Glue Chip
J-Jewel

80" Door
41 3/4" Glass

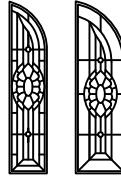

96" Door
57 3/4" Glass

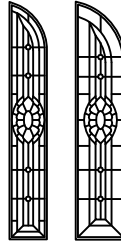

"Q" GLASS

Door Size
Glass Size

36" 42"
9 1/8" 12 1/8"

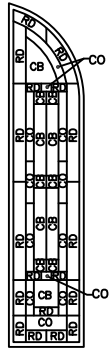

LEGEND
CB-Clear Bevel
CO-Cotswald
RD-Reed

80" Door
41 3/4" Glass

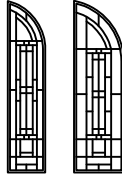

96" Door
57 3/4" Glass

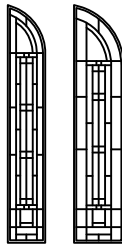

"R" GLASS

Door Size
Glass Size

36" 42"
9 1/8" 12 1/8"

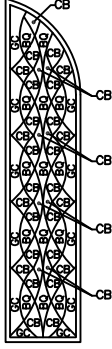

LEGEND
CB-Clear Bevel
GC-Glue Chip
BQ-Clear Baroque

80" Door
41 3/4" Glass

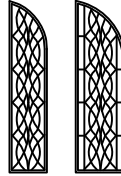

96" Door
57 3/4" Glass

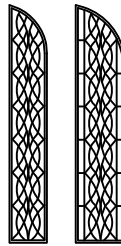

"T" GLASS

Door Size
Glass Size

36" 42"
9 1/8" 12 1/8"

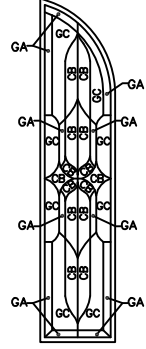

LEGEND
CB-Clear Bevel
GC-Glue Chip
GA-Clear Gotta

80" Door
41 3/4" Glass

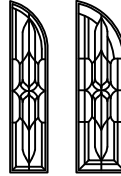

96" Door
57 3/4" Glass

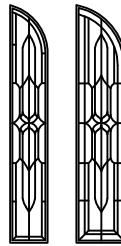

INSULATED GLASS

Clear Safety
Clear Beveled
Glue Chip
Low-E
Rain
Reed
Frosted

TRIPLE GLAZED

D - J - Q - R - T

"D" GLASS

Door Size
Glass Size

30" 36" 42"
7 1/8" 9 1/8" 12 1/8"

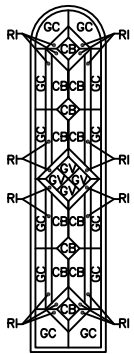

LEGEND
CB-Clear Bevel
GC-Glue Chip
GV-Glue Chip Bevel
RI-Ripple

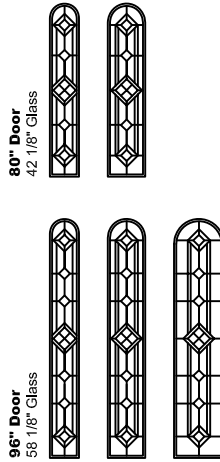

"J" GLASS

Door Size
Glass Size

30" 36" 42"
7 1/8" 9 1/8" 12 1/8"

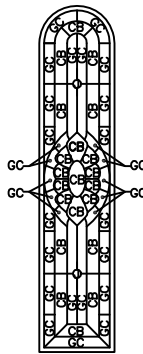

LEGEND
CB-Clear Bevel
GC-Glue Chip
J-Jewel

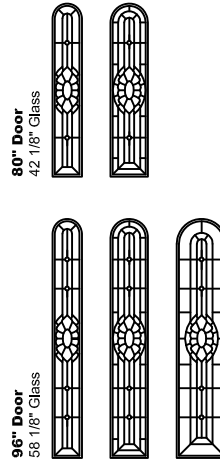

"Q" GLASS

Door Size
Glass Size

30" 36" 42"
7 1/8" 9 1/8" 12 1/8"

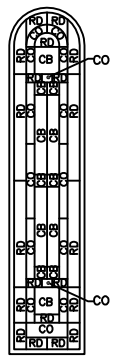

LEGEND
CB-Clear Bevel
CO-Cotswald
RD-Reed

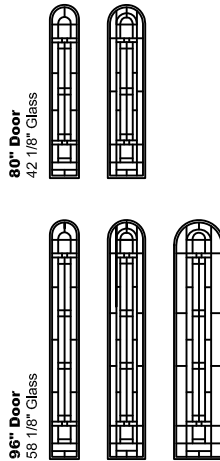

"R" GLASS

Door Size
Glass Size

30" 36" 42"
7 1/8" 9 1/8" 12 1/8"

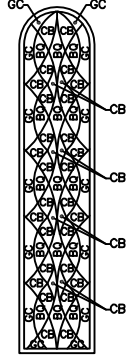

LEGEND
CB-Clear Bevel
GC-Glue Chip
BQ-Clear Baroque

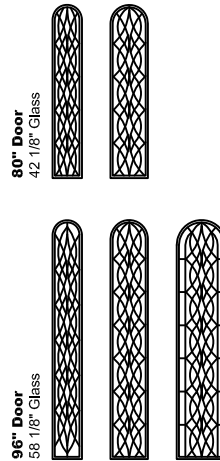

"T" GLASS

Door Size
Glass Size

30" 36" 42"
7 1/8" 9 1/8" 12 1/8"

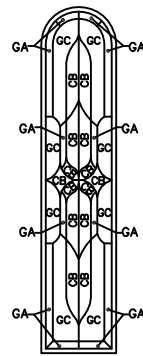

LEGEND
CB-Clear Bevel
GC-Glue Chip
GA-Clear Gotta

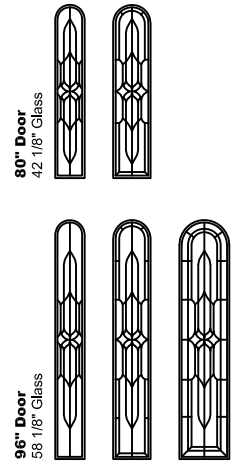

INSULATED GLASS

- Clear Safety
- Clear Beveled
- Glue Chip
- Low-E
- Rain
- Reed
- Frosted

TRIPLE GLAZED

G - K - LG - T - V

"G" GLASS

Door Size
Glass Size

12"-15"
7 7/8"

16"-18"
8 3/8"

36"-42"
19 7/8"

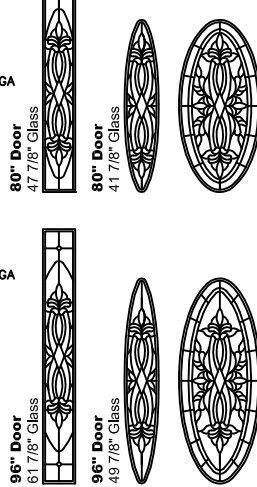
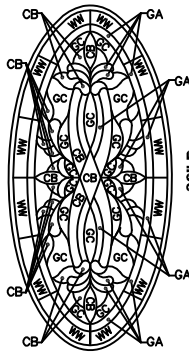

- LEGEND**
 CB-Clear Bevel
 GC-Glue Chip
 WW-Clear Water
 GA-Clear Gotta

"K" GLASS

Door Size
Glass Size

12"-15"
7 7/8"

16"-18"
8 3/8"

36"-42"
19 7/8"

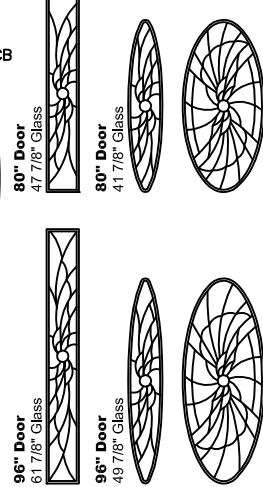
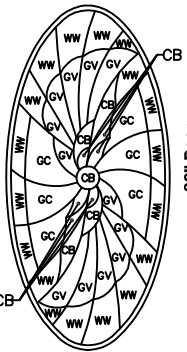

- LEGEND**
 CB-Clear Bevel
 GC-Glue Chip
 GV-Glue Chip Bevel
 WW-Clear Water

"LG" GLASS

Door Size
Glass Size

12"-15"
7 7/8"

16"-18"
8 3/8"

36"-42"
19 7/8"

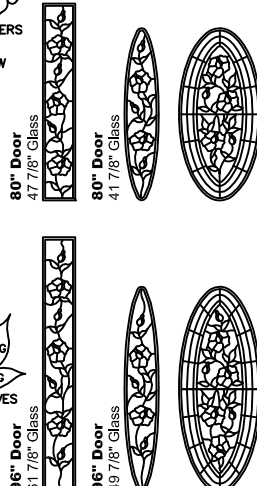
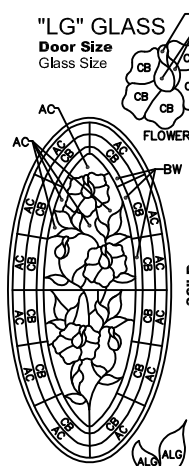

- LEGEND**
 CB-Clear Bevel / LEAVES
 AC-Clear Antique
 BW-Antique Brown
 ALR-Ant. Light Rose
 ALG-Ant. Light Green

"T" GLASS

Door Size
Glass Size

12"-15"
7 7/8"

16"-18"
8 3/8"

36"-42"
19 7/8"

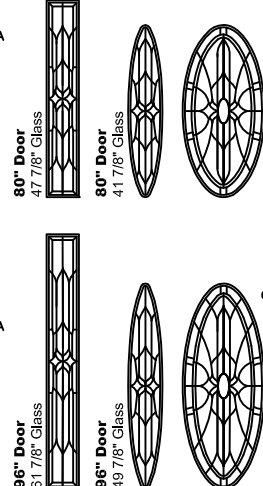
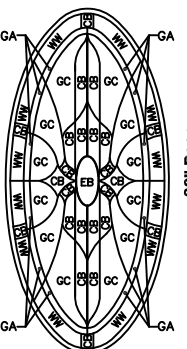

- LEGEND**
 CB-Clear Bevel
 EB-Etched Bevel
 GC-Glue Chip
 WW-Clear Water
 GA-Clear Gotta

"V" GLASS

Door Size
Glass Size

12"-15"
7 7/8"

16"-18"
8 3/8"

36"-42"
19 7/8"

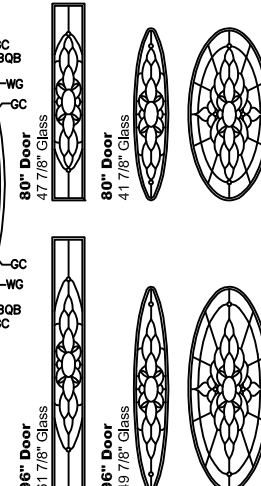
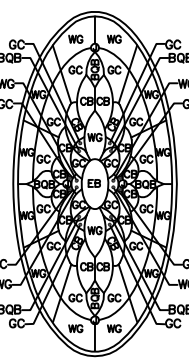

- LEGEND**
 CB-Clear Bevel
 EB-Etched Bevel
 GC-Glue Chip
 WG-Grey Water
 BQB-Black Baroque
 J-Jewel

INSULATED GLASS

- Clear Safety
- Clear Beveled
- Glue Chip
- Low-E
- Rain
- Reed
- Frosted

TRIPLE GLAZED

AB - H - L

"AB" GLASS

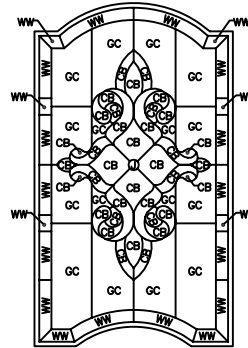

LEGEND

- CB-Clear Bevel
- GC-Glue Chip
- WW-Clear Water
- J-Jewel

"H" GLASS

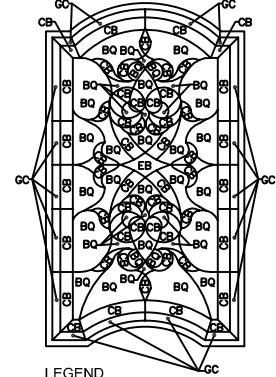

LEGEND

- CB-Clear Bevel
- EB-Etched Bevel
- GC-Glue Chip
- BQ-Clear Baroque

"AB" GLASS

Door Size
Glass Size

12"-14" 15"-18" 30" 32" 36" 42"
7 1/8" 9 1/8" 18 1/8" 20 1/8" 24 1/8" 29 1/8"

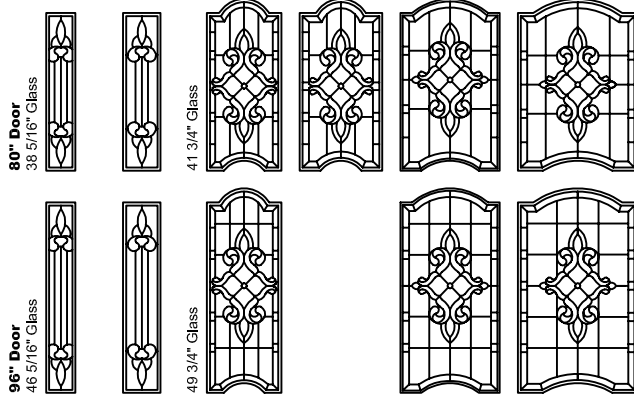

"L" GLASS

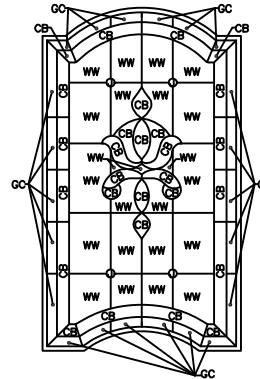

LEGEND

- CB-Clear Bevel
- GC-Glue Chip
- WW-Clear Water
- J-Jewel

"H" GLASS

Door Size
Glass Size

12"-14" 15"-18" 30" 32" 36" 42"
7 1/8" 9 1/8" 18 1/8" 20 1/8" 24 1/8" 29 1/8"

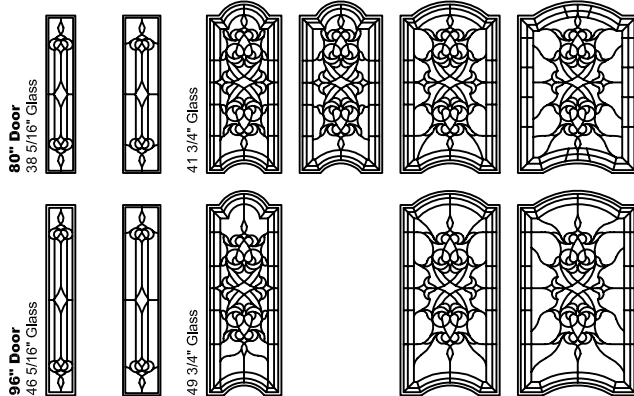

"L" GLASS

Door Size
Glass Size

12"-14" 15"-18" 30" 32" 36" 42"
7 1/8" 9 1/8" 18 1/8" 20 1/8" 24 1/8" 29 1/8"

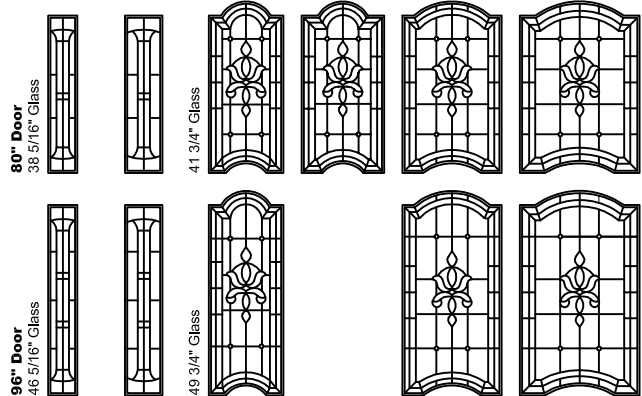

INSULATED GLASS

Clear Safety
Clear Beveled
Glue Chip
Low-E
Rain
Reed
Frosted

TRIPLE GLAZED

A - B - C

"A" GLASS

Door Size
Glass Size

12"-14" 9 1/8"
36" 11 3/8"
42" 13 3/8"

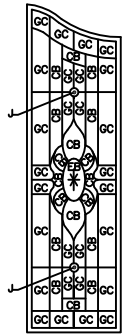

80" Door
39 7/8" Glass

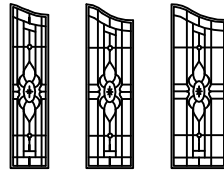

96" Door
55 7/8" Glass

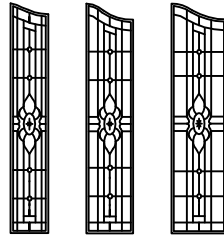

LEGEND

CB-Clear Bevel
EB-Etched Bevel
GC-Glue Chip
J-Jewel

"B" GLASS

Door Size
Glass Size

12"-14" 9 1/8"
36" 11 3/8"
42" 13 3/8"

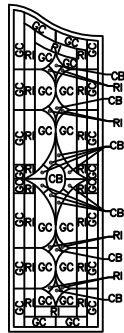

80" Door
39 7/8" Glass

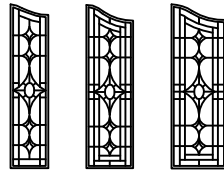

96" Door
55 7/8" Glass

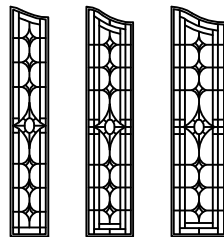

LEGEND

CB-Clear Bevel
GC-Glue Chip
R-Ripple

"C" GLASS

Door Size
Glass Size

12"-14" 9 1/8"
36" 11 3/8"
42" 13 3/8"

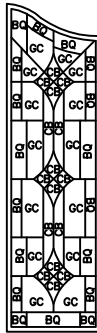

80" Door
39 7/8" Glass

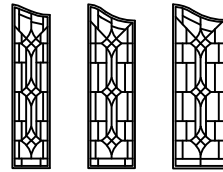

96" Door
55 7/8" Glass

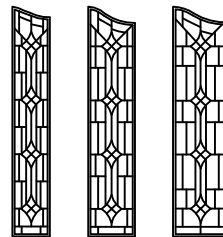

LEGEND

CB-Clear Bevel
GC-Glue Chip
BQ-Clear Baroque

A110 CROSS SECTIONS

Scale: 3" = 1'-0"

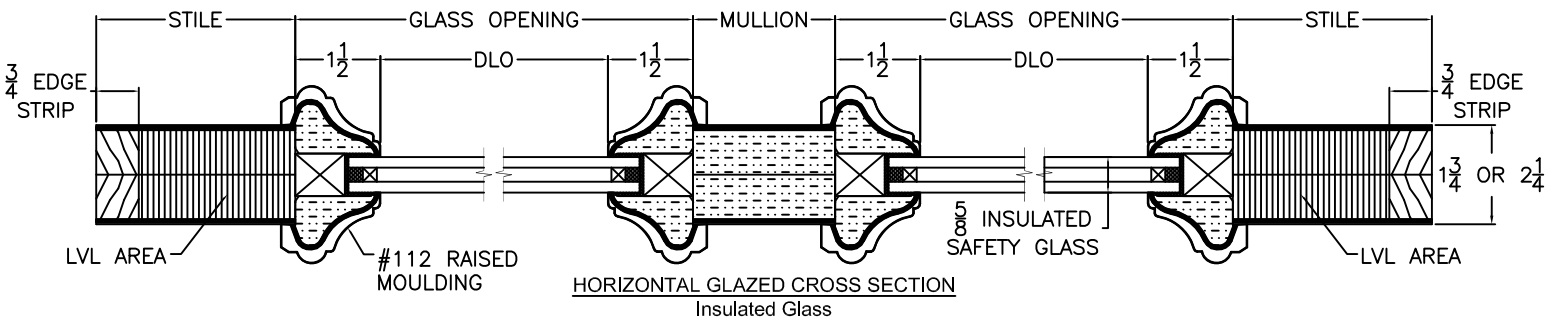
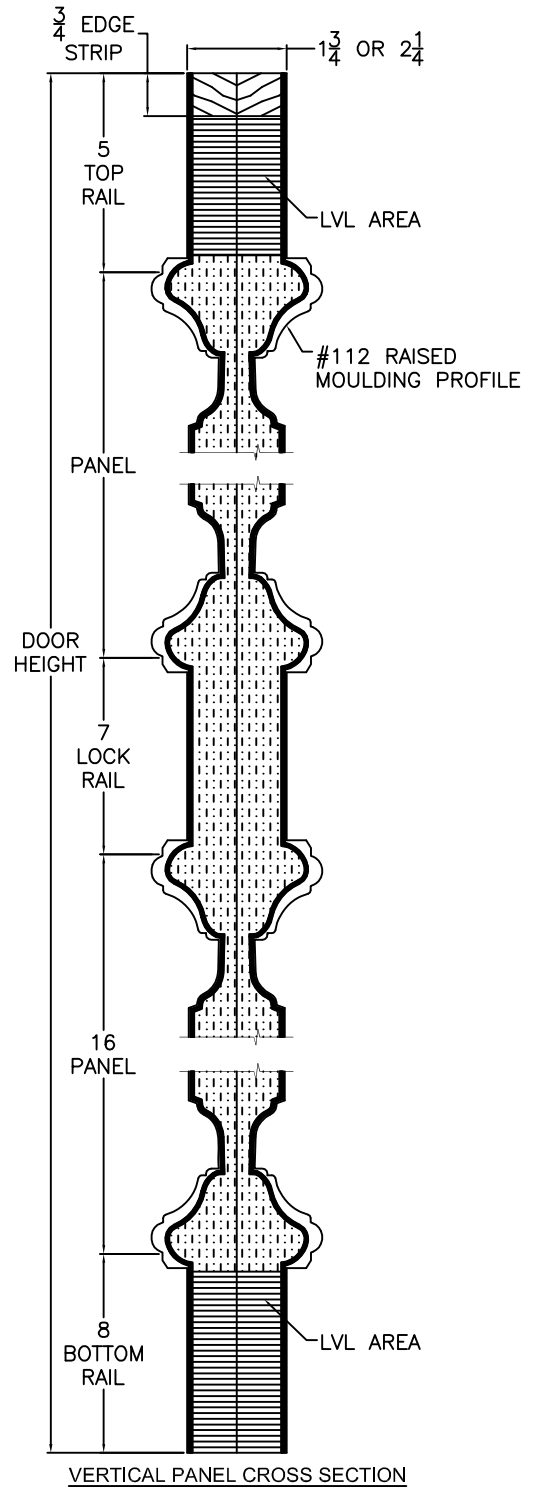
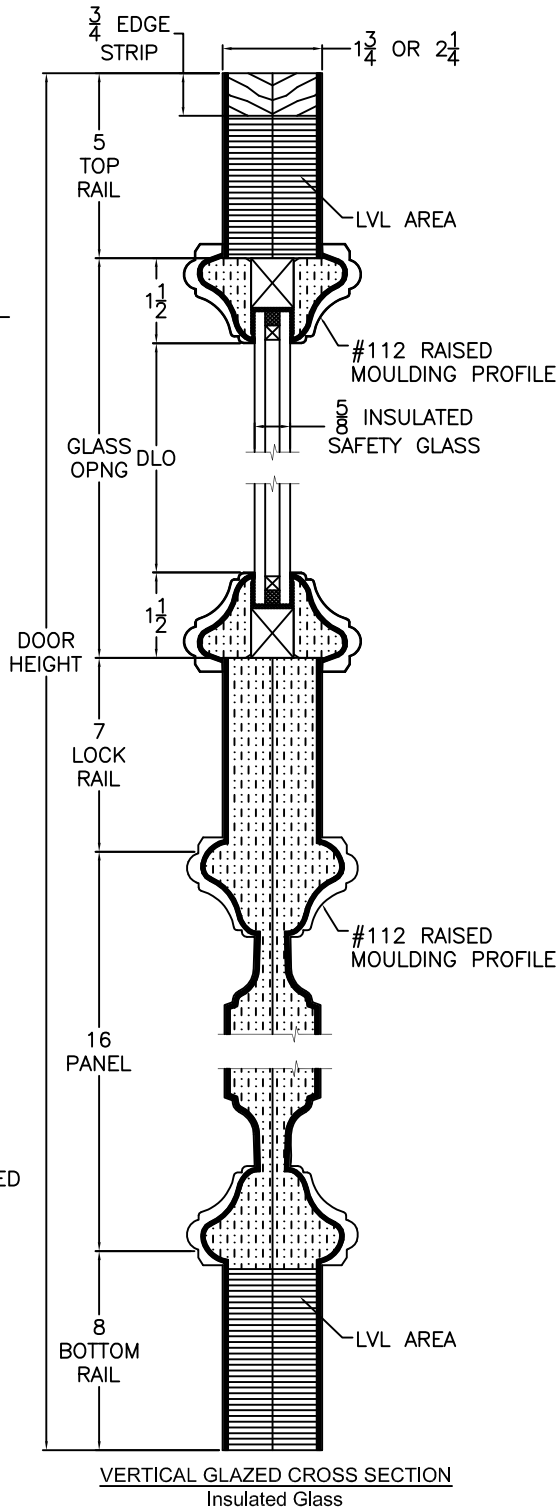
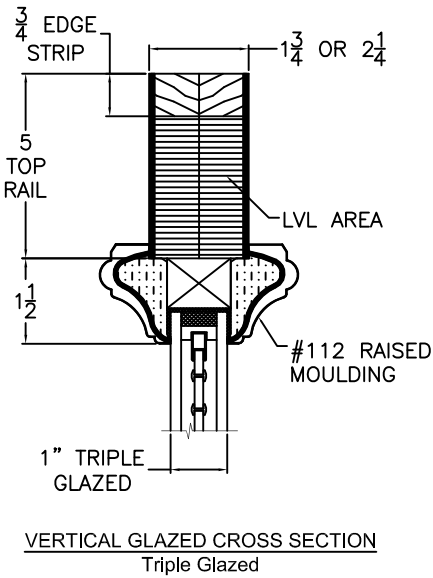
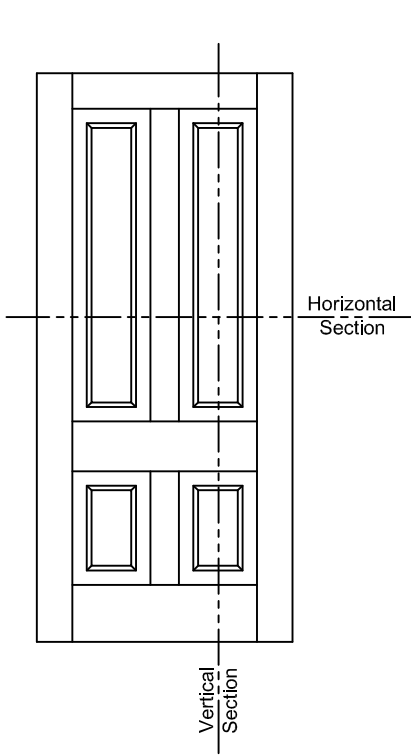

A112 CROSS SECTIONS

Scale: 3" = 1'-0"

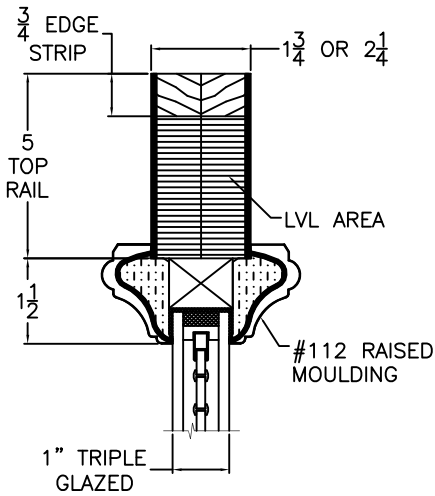
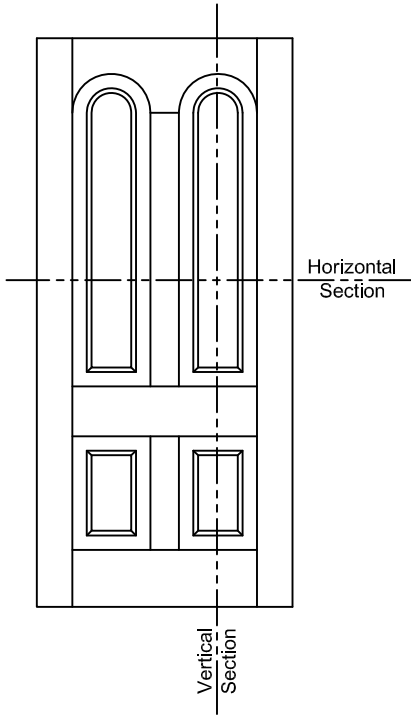

VERTICAL GLAZED CROSS SECTION
Triple Glazed

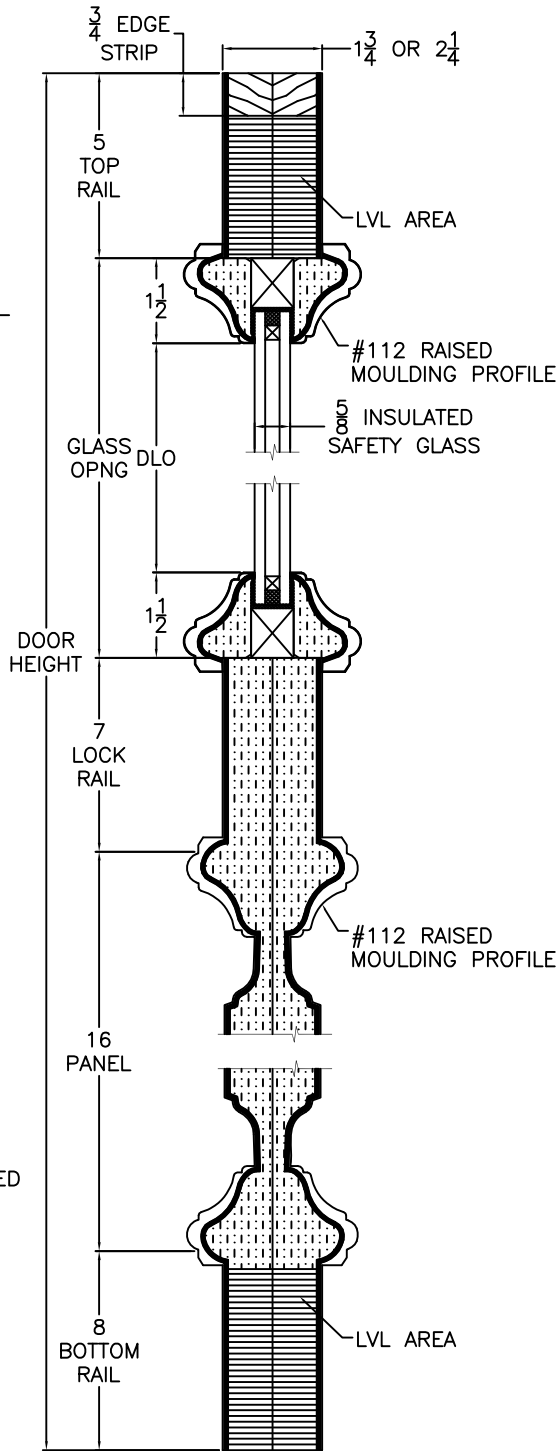

VERTICAL GLAZED CROSS SECTION
Insulated Glass

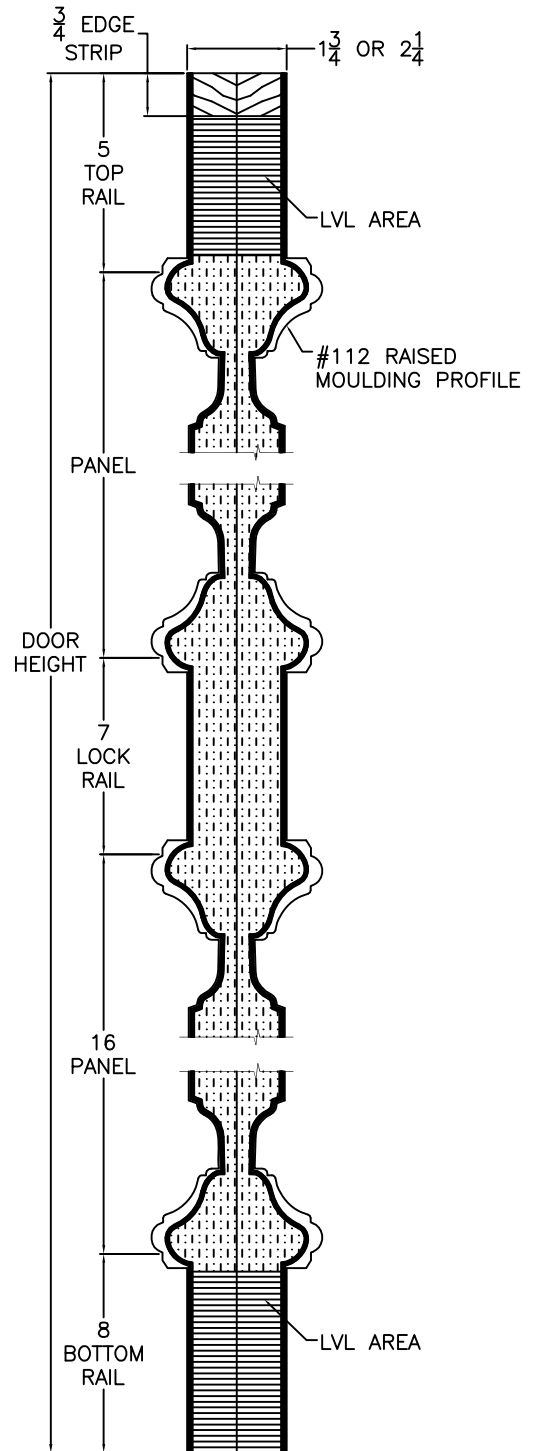

VERTICAL PANEL CROSS SECTION

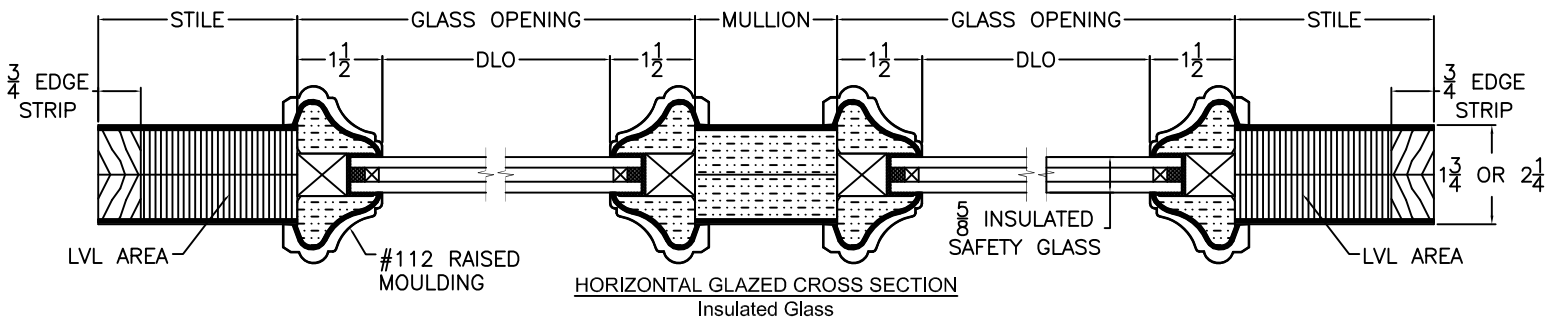

HORIZONTAL GLAZED CROSS SECTION
Insulated Glass

A115 CROSS SECTIONS

Scale: 3" = 1'-0"

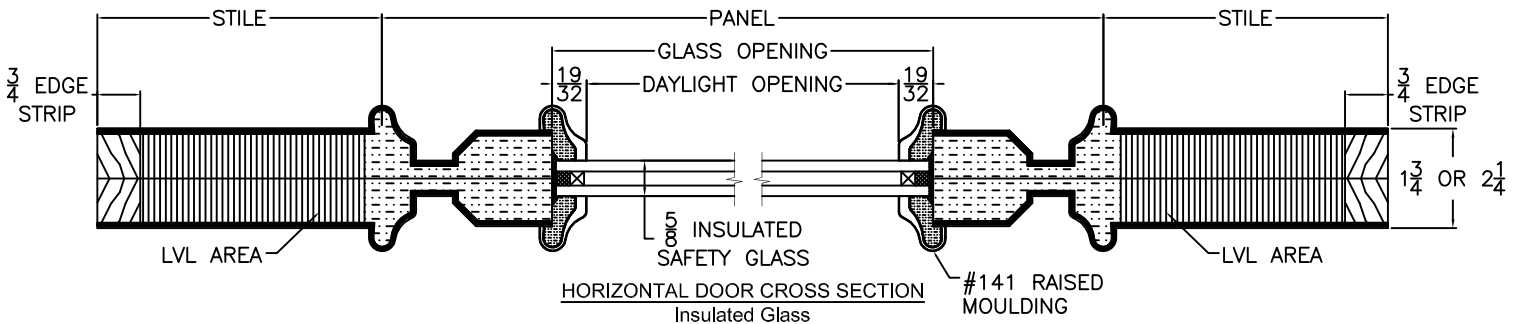
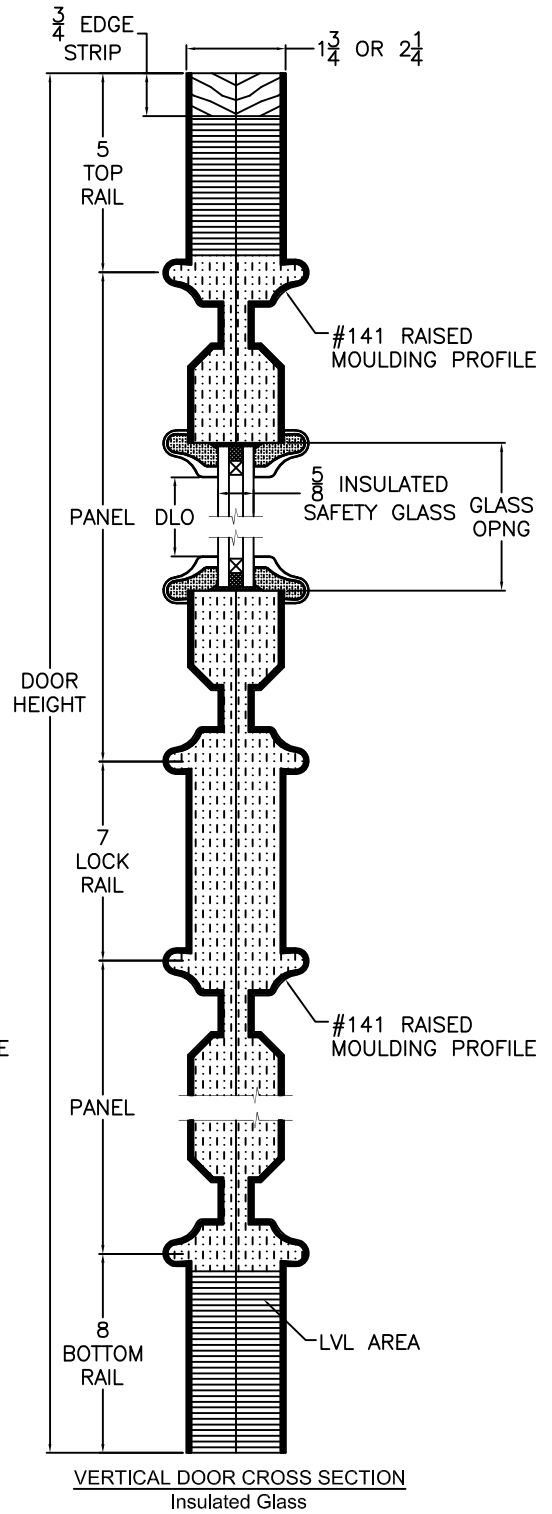
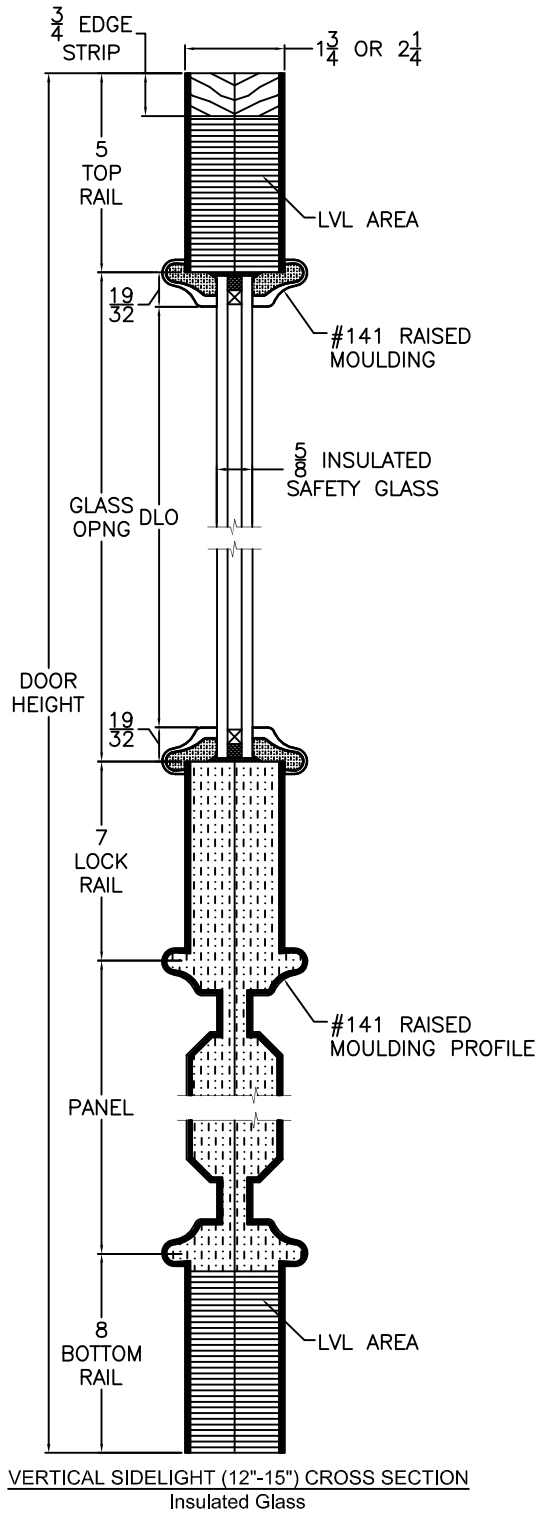
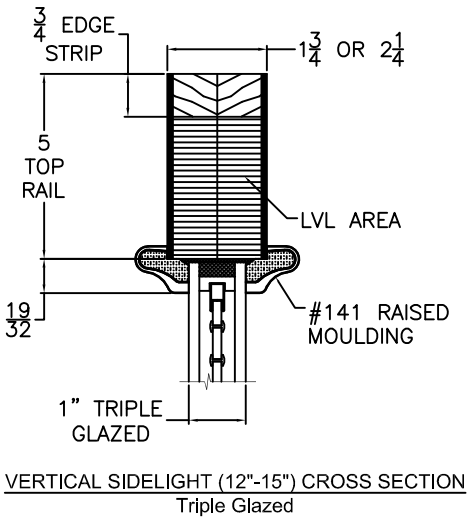
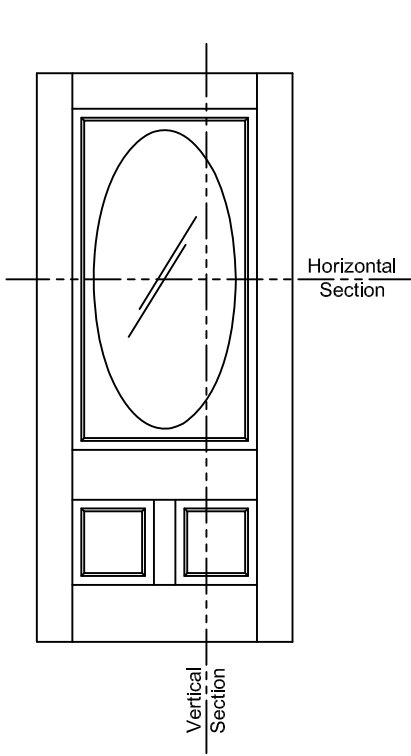

A412 CROSS SECTIONS

Scale: 3" = 1'-0"

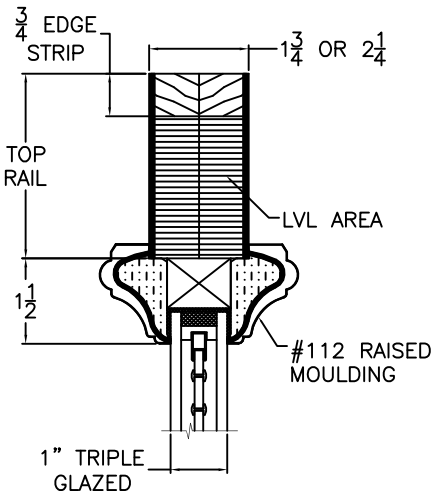
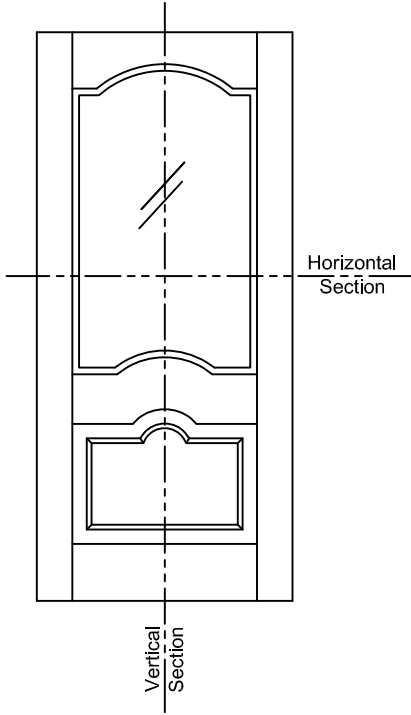

VERTICAL GLAZED CROSS SECTION
Triple Glazed

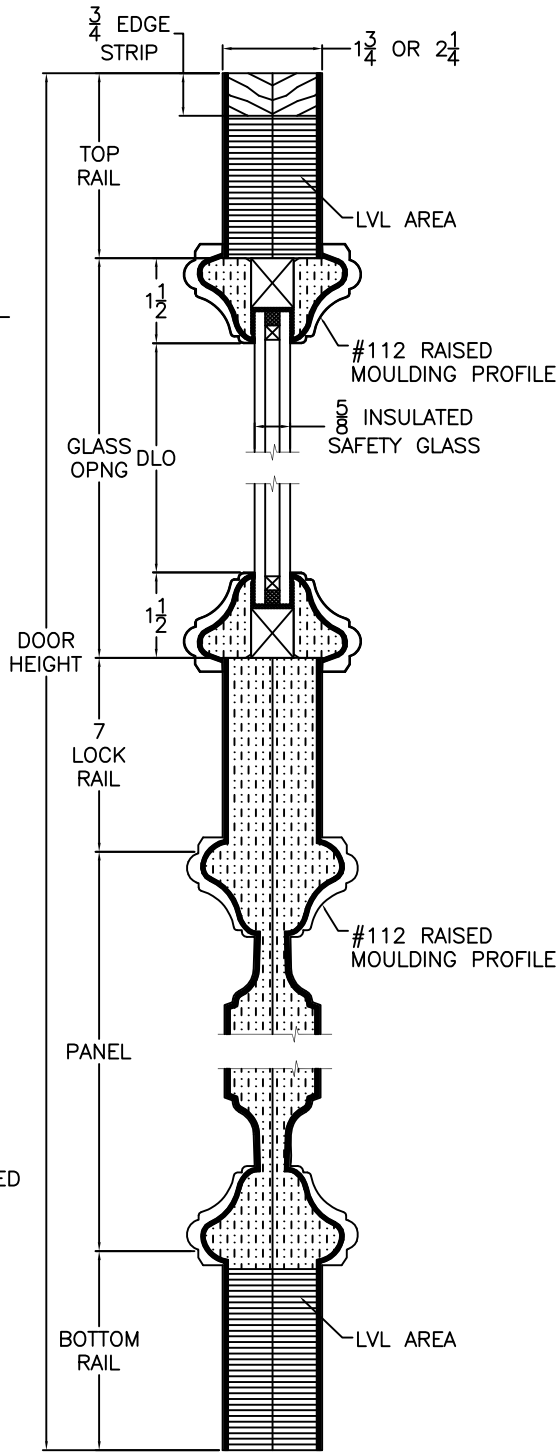

VERTICAL GLAZED CROSS SECTION
Insulated Glass

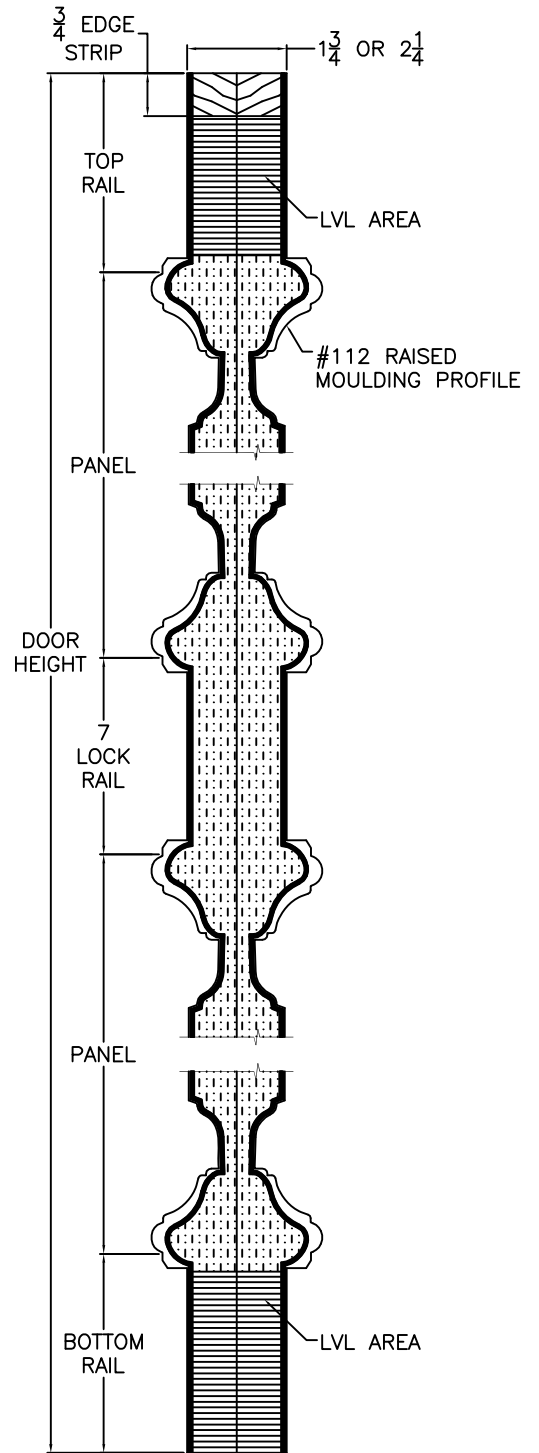

VERTICAL PANEL CROSS SECTION

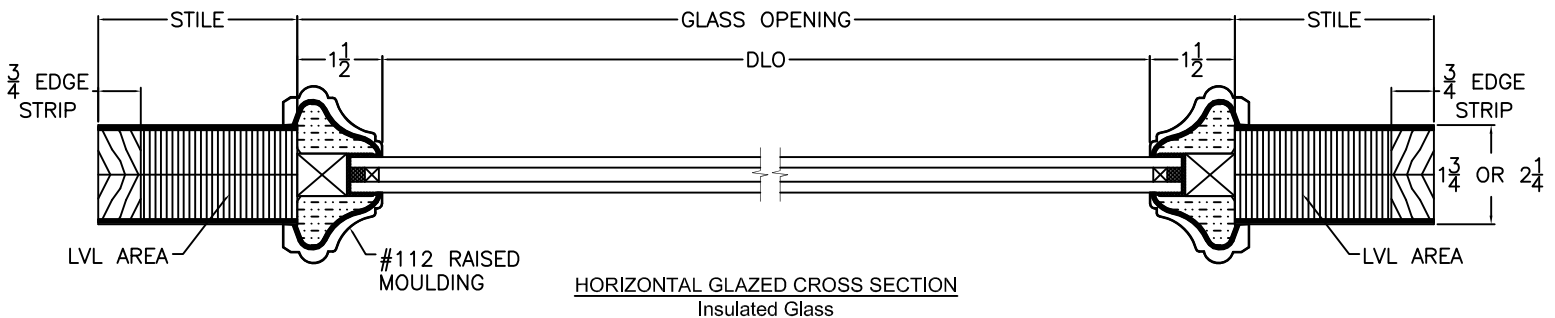

HORIZONTAL GLAZED CROSS SECTION
Insulated Glass

A890 CROSS SECTIONS

Scale: 3" = 1'-0"

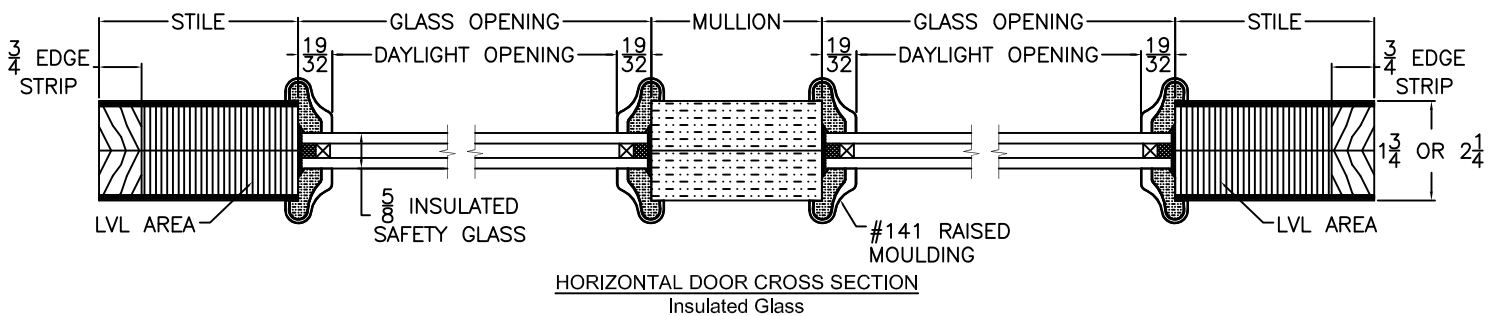
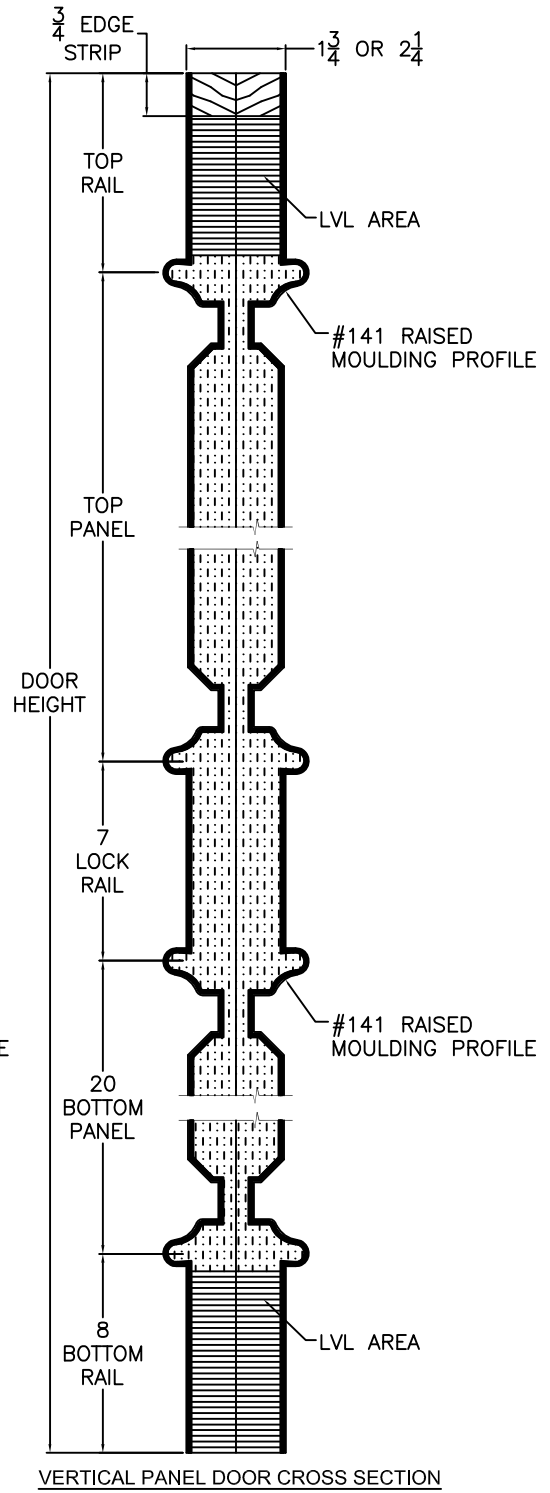
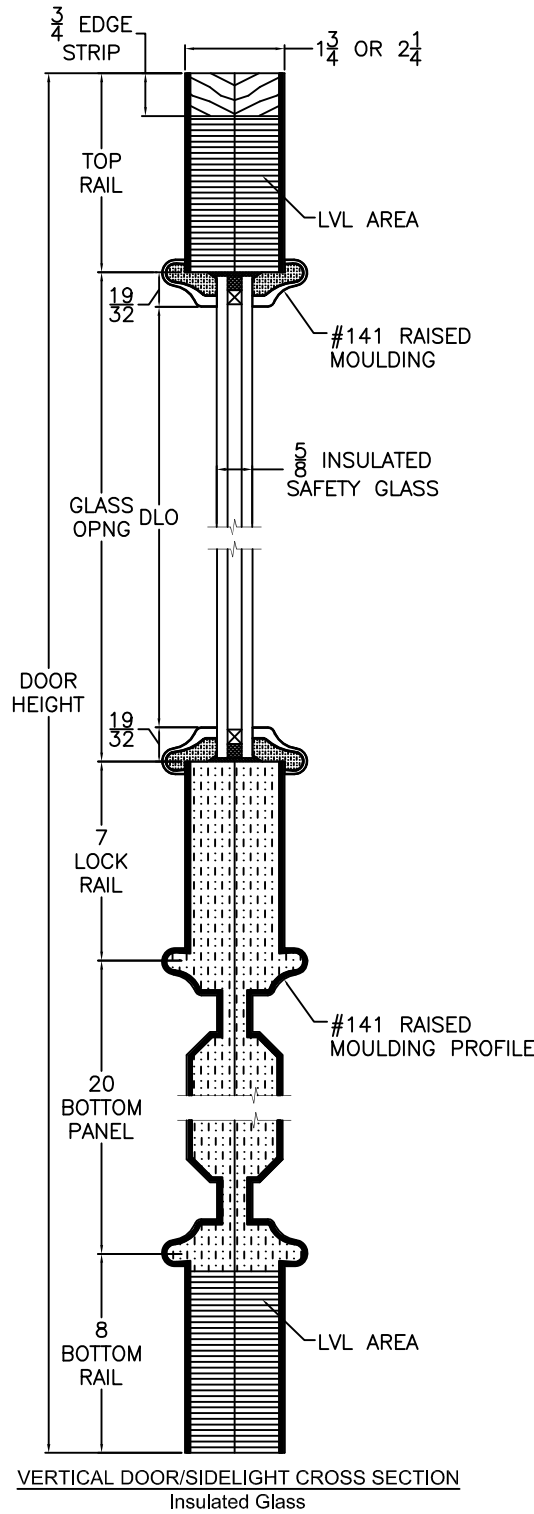
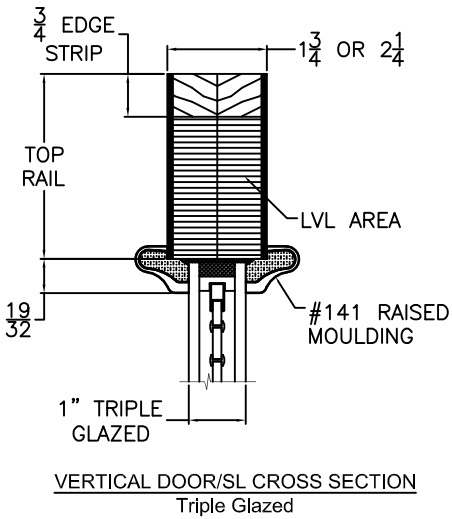
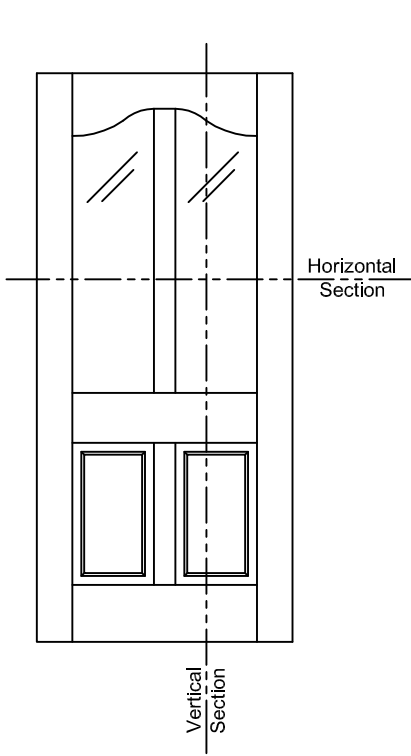

A1202 CROSS SECTIONS

Scale: 3" = 1'-0"

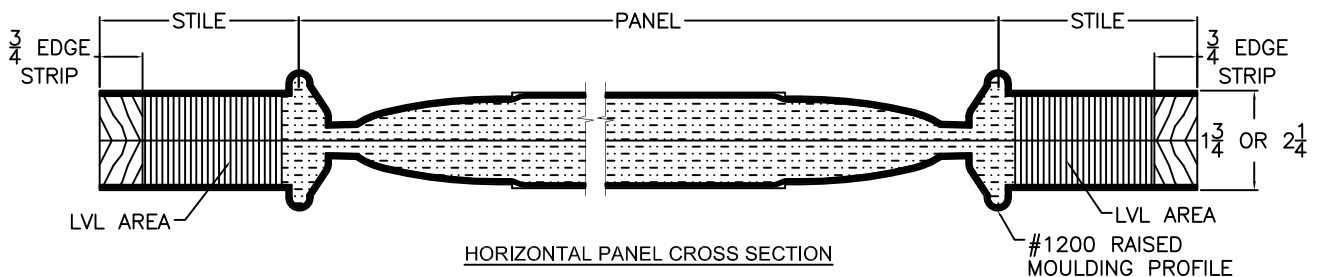
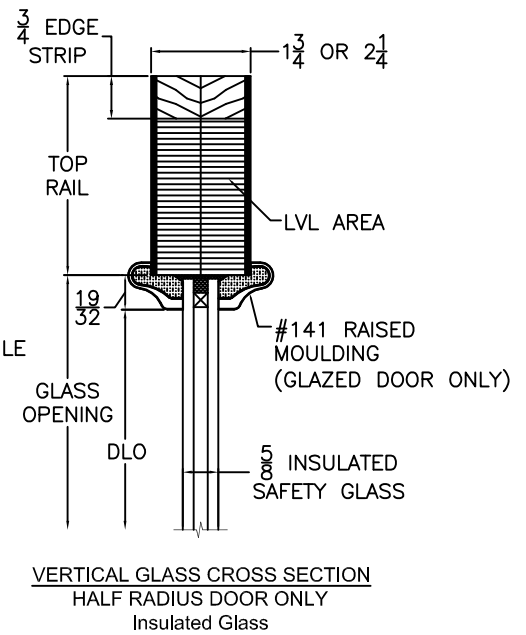
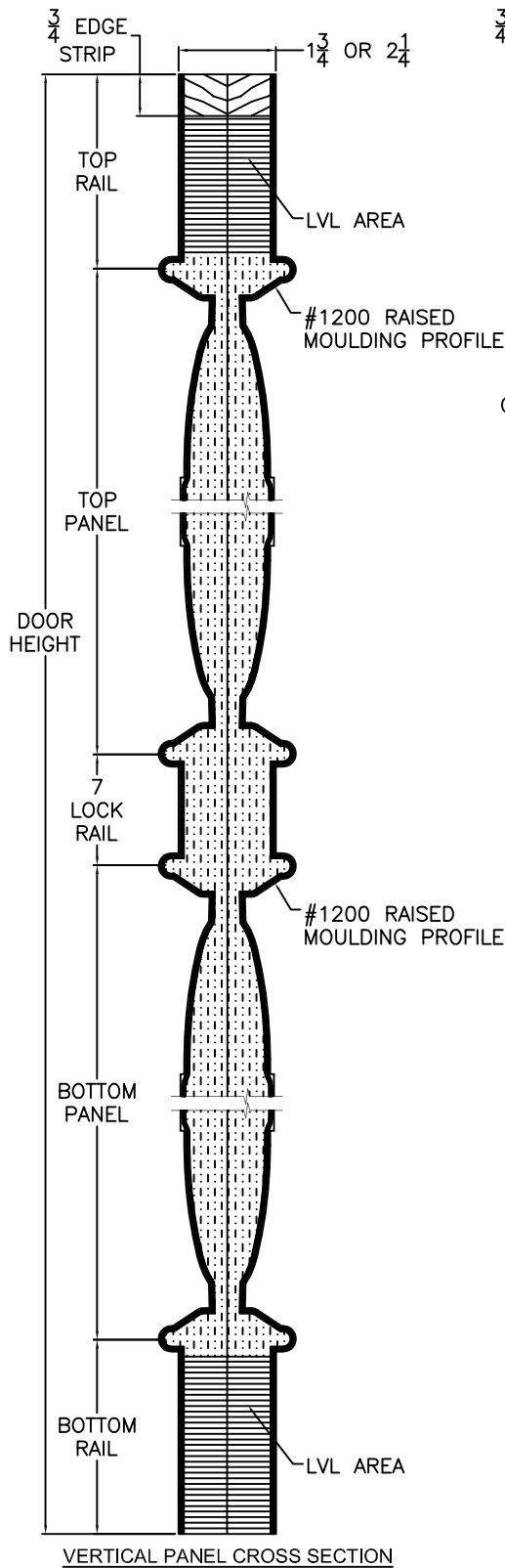
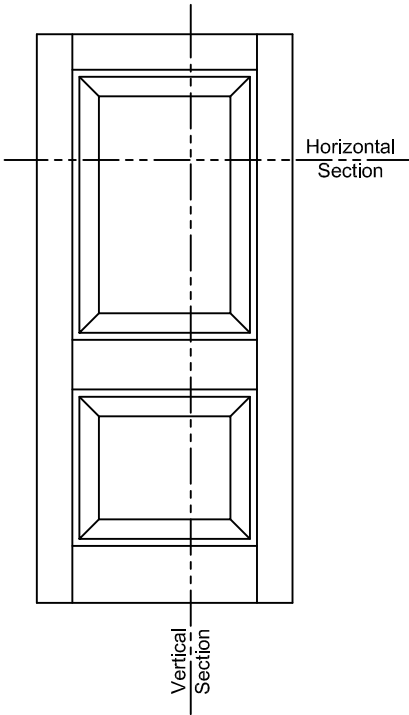

A1322 CROSS SECTIONS

Scale: 3" = 1'-0"
Rev. 1 07/13/09

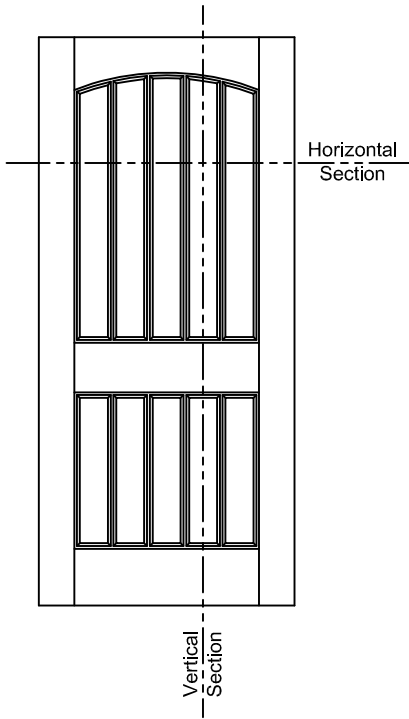

V-GROOVE/PLANK DETAILS

2-6 Door = 4 Planks, 3 23/32" Flat Area Width

3-0 Door = 5 Planks, 3 15/16" Flat Area Width

3-6 Door = 6 Planks, 4 3/32" Flat Area Width

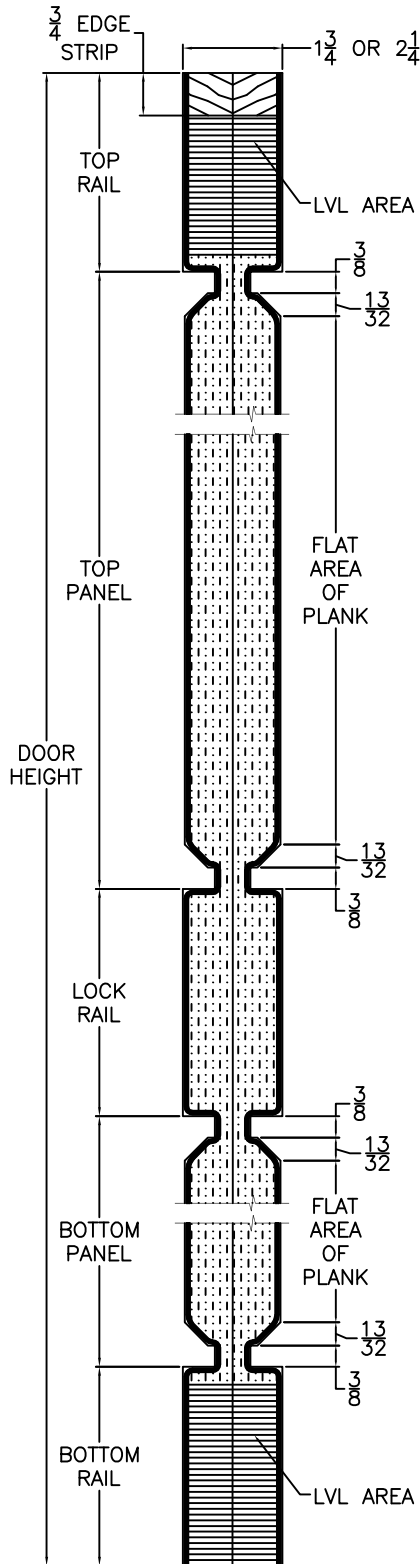

VERTICAL PANEL CROSS SECTION

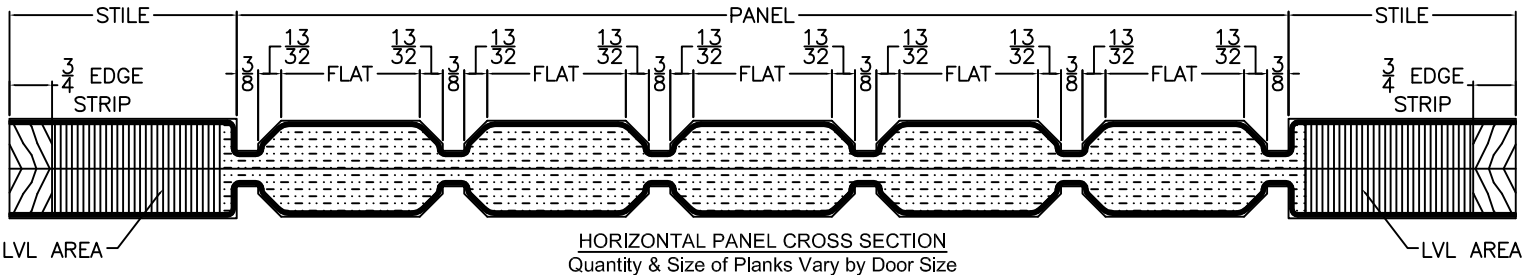
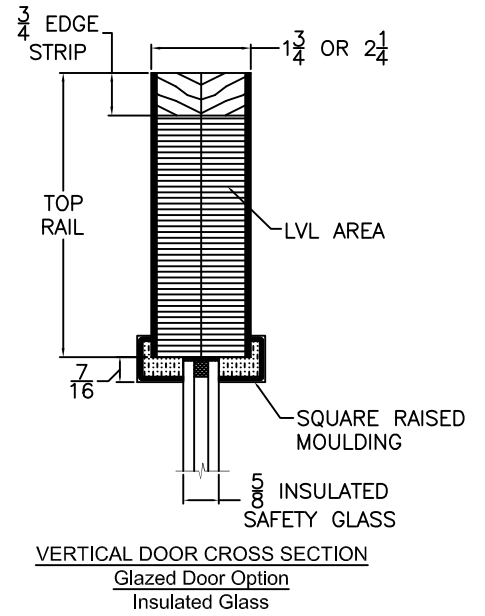

A5144 CROSS SECTIONS

Scale: 3" = 1'-0"

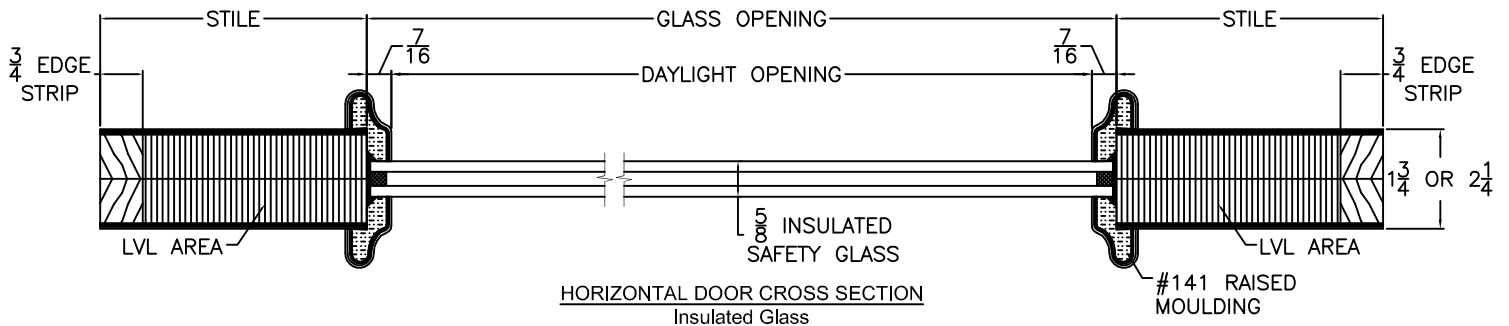
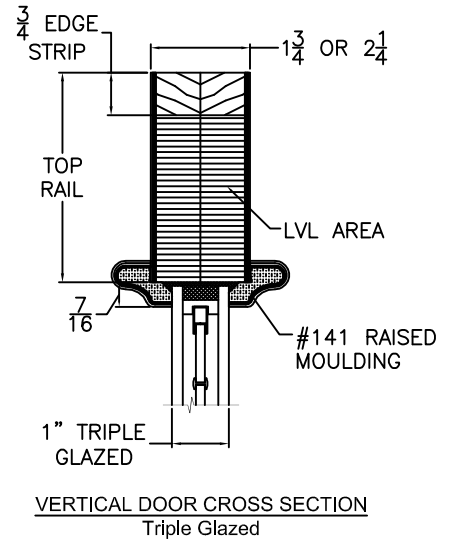
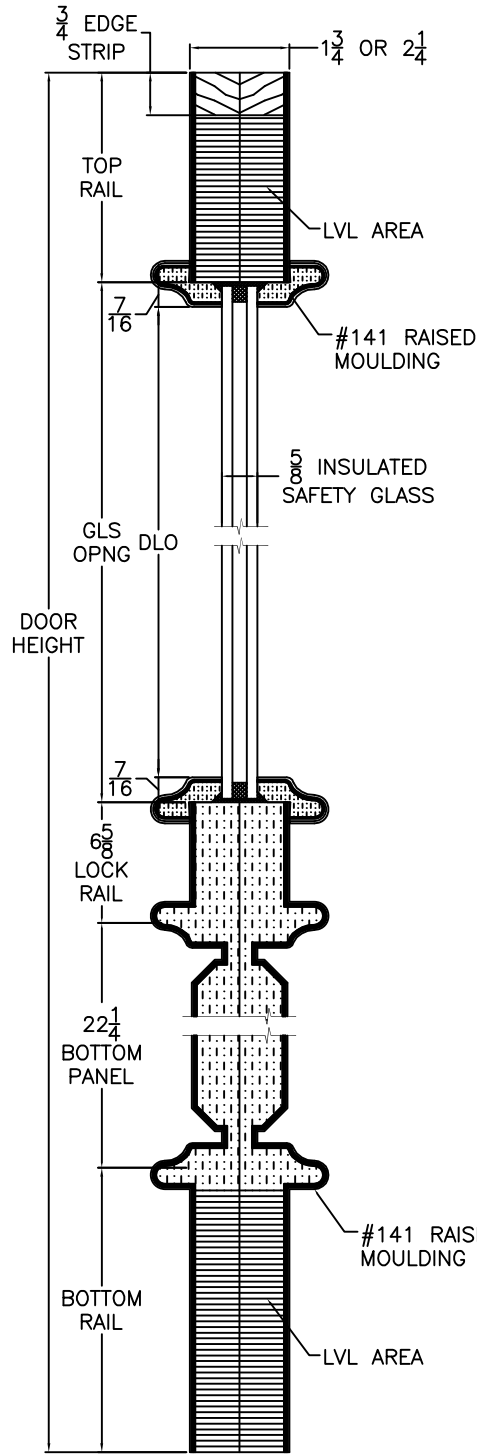
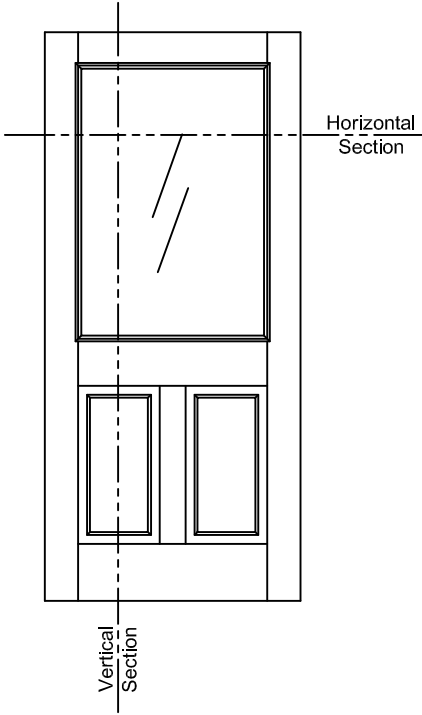

A5944 CROSS SECTIONS

Scale: 3" = 1'-0"

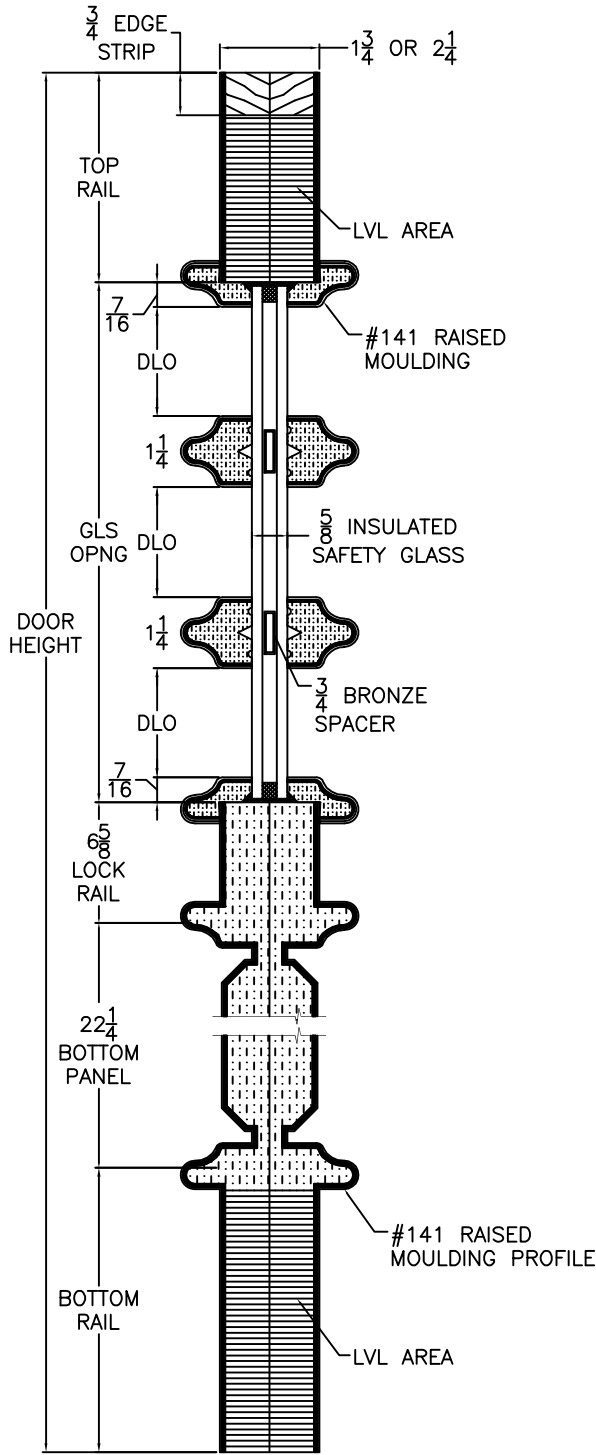
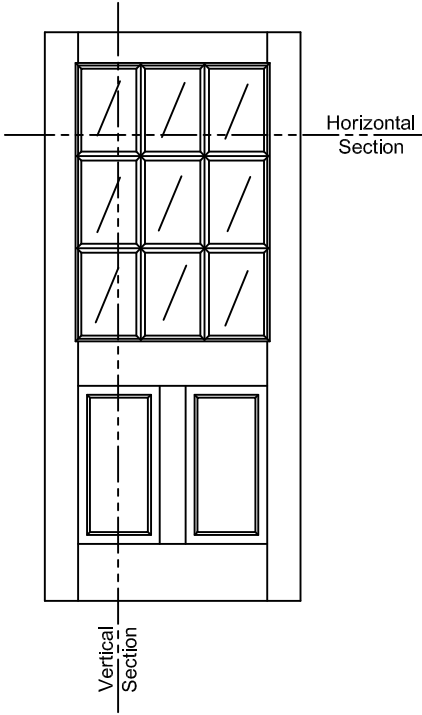

VERTICAL DOOR CROSS SECTION
Insulated Glass

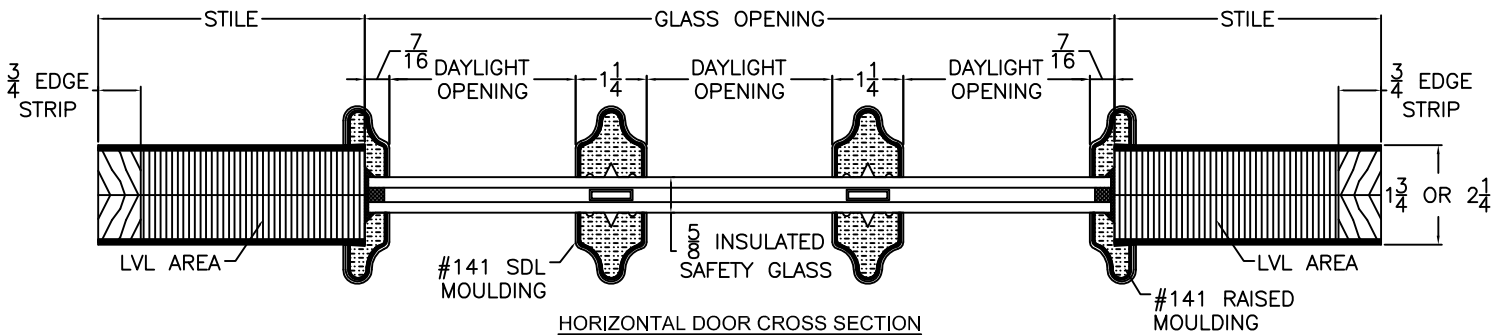

HORIZONTAL DOOR CROSS SECTION
Insulated Glass

A5702 CROSS SECTIONS

Scale: 3" = 1'-0"

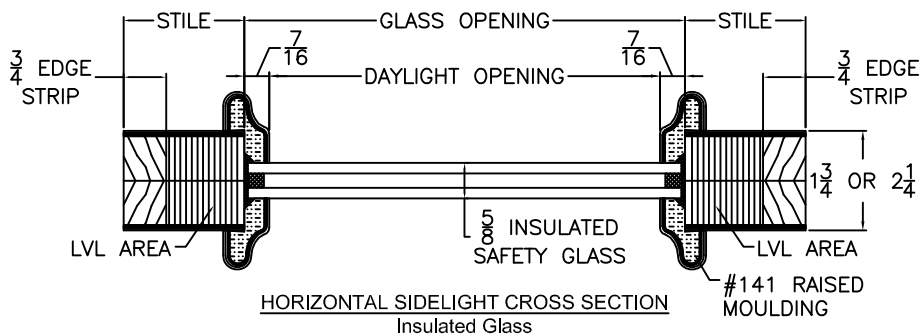
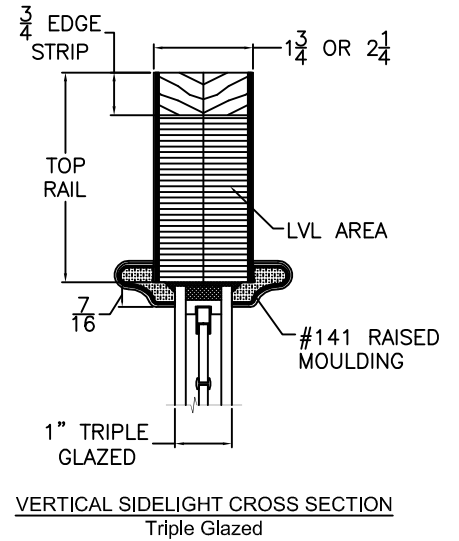
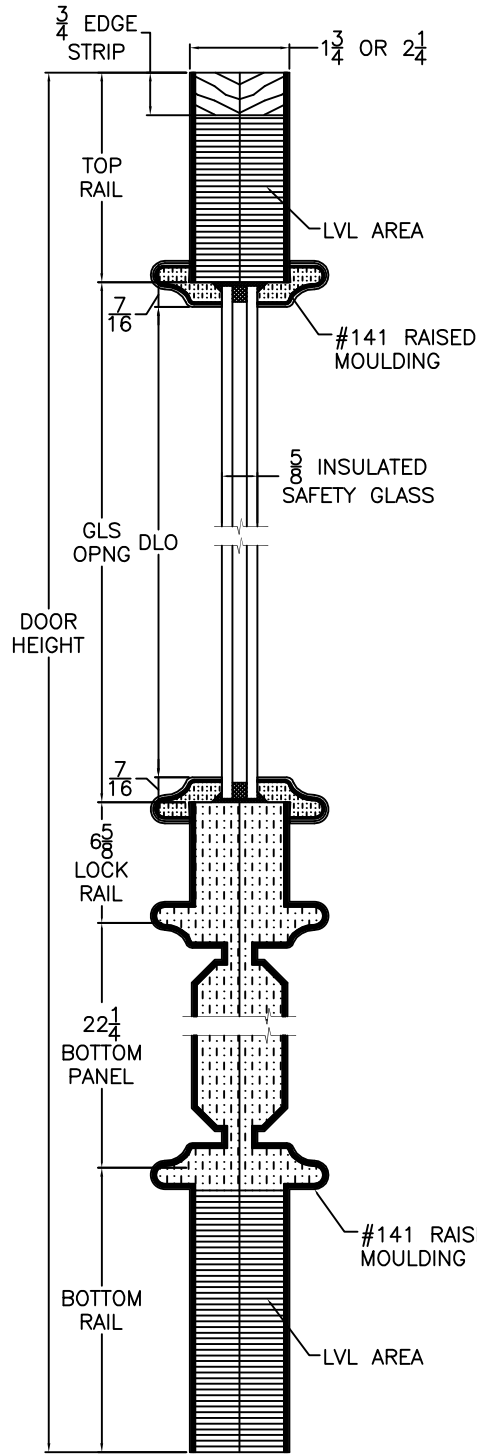
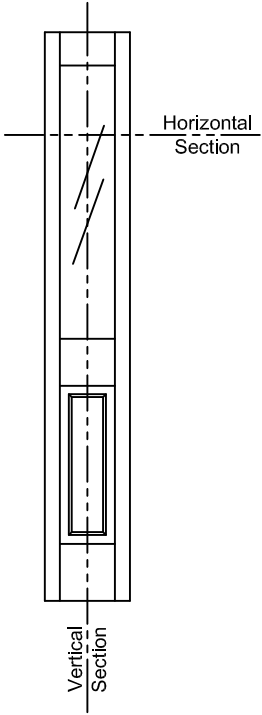

A5703 CROSS SECTIONS

Scale: 3" = 1'-0"

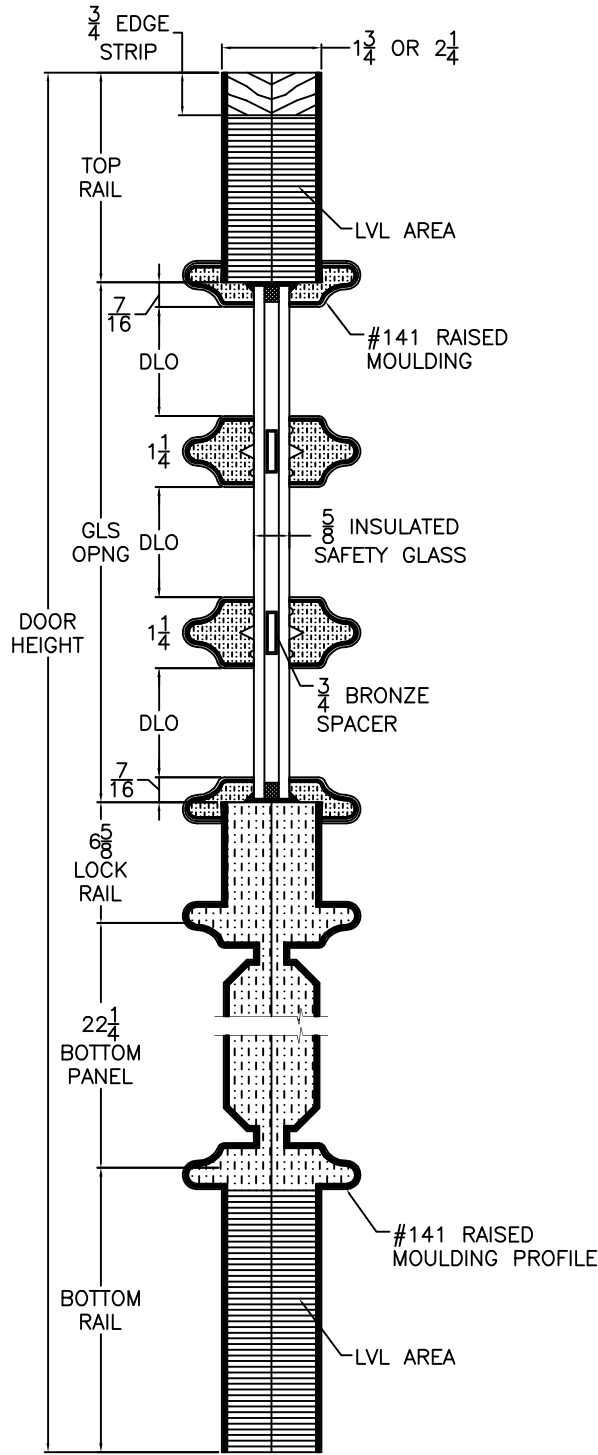
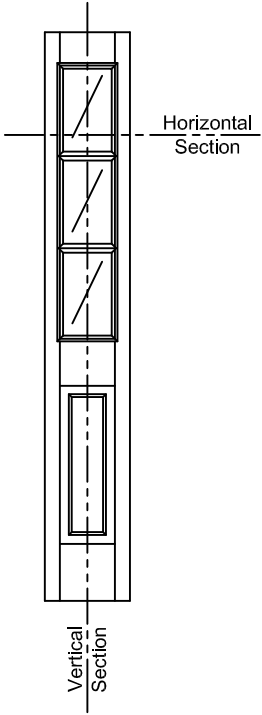

VERTICAL SIDELIGHT CROSS SECTION
Insulated Glass

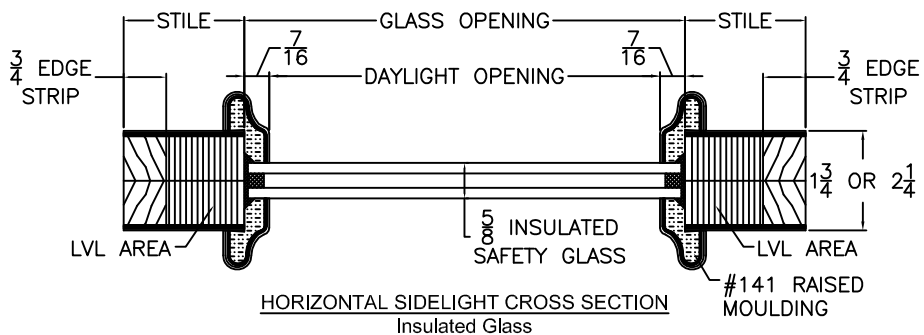

HORIZONTAL SIDELIGHT CROSS SECTION
Insulated Glass