



Premium Aluminum  
Rolling Window

---

**Table of Contents**

---

Premium Aluminum Sections .....	2-6
Vertical Section .....	2
Horizontal Section.....	3
¼” Single Pane Vertical Section .....	4
¼” Single Pane Horizontal Section.....	5
3 Wide Horizontal Section .....	6
Elevations .....	7-12
Single Unit.....	7
3 Wide Unit .....	11

1" IG VERTICAL SECTION

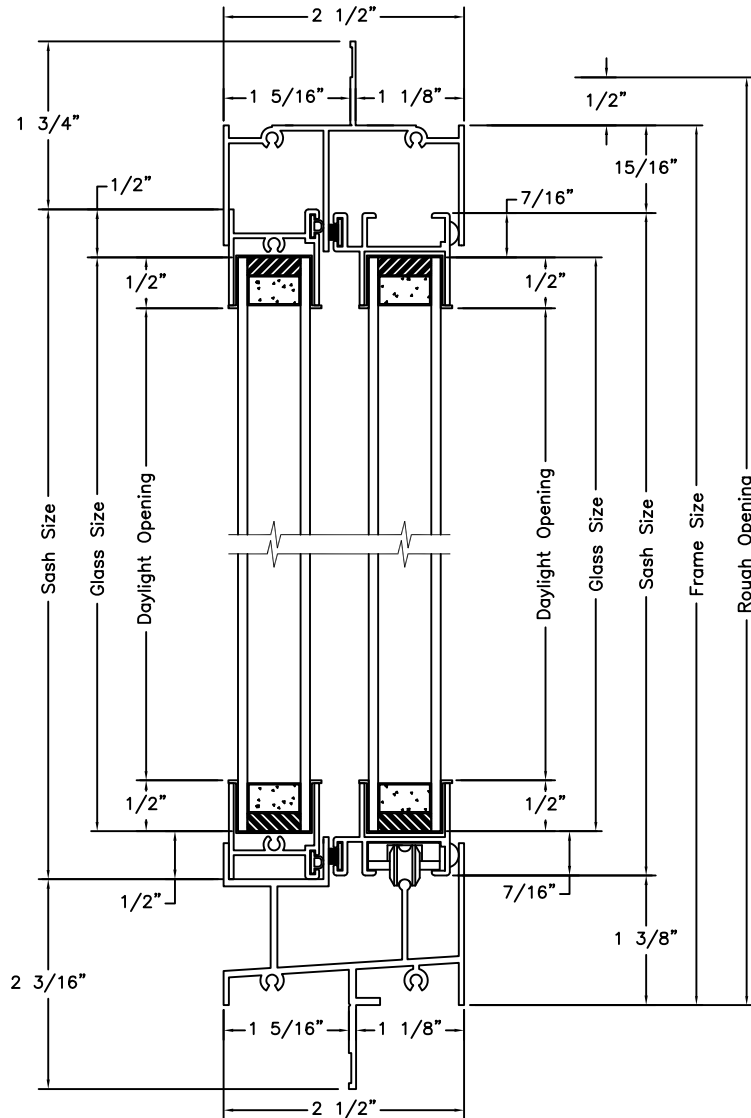

Vertical Section

1" IG HORIZONTAL SECTION

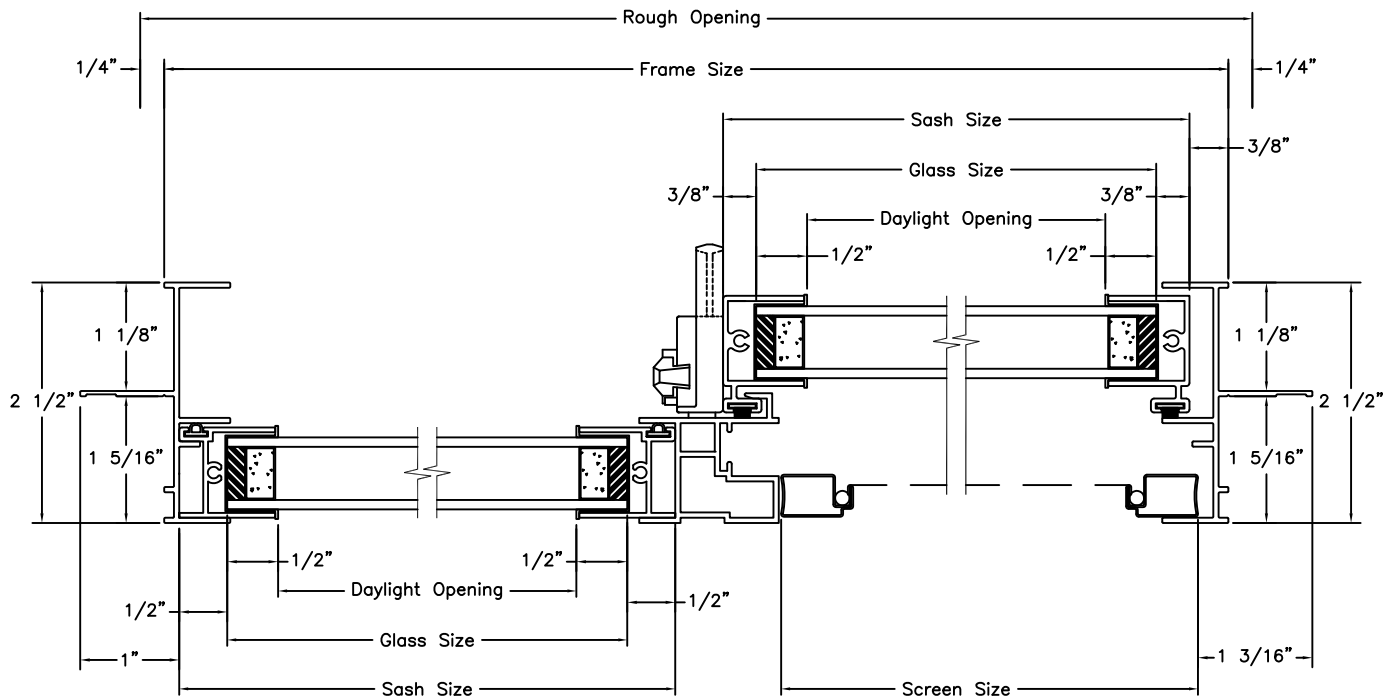

**Horizontal Section**

1/4" SINGLE PANE VERTICAL SECTION

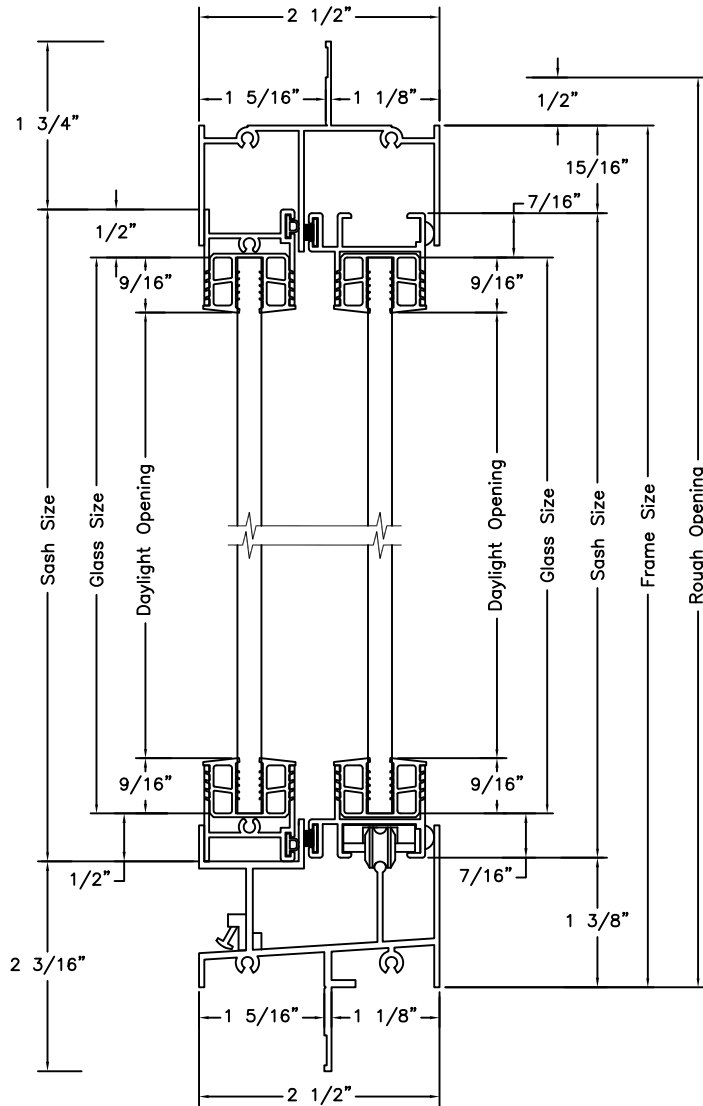

Vertical Section

1/4" SINGLE PANE HORIZONTAL SECTION

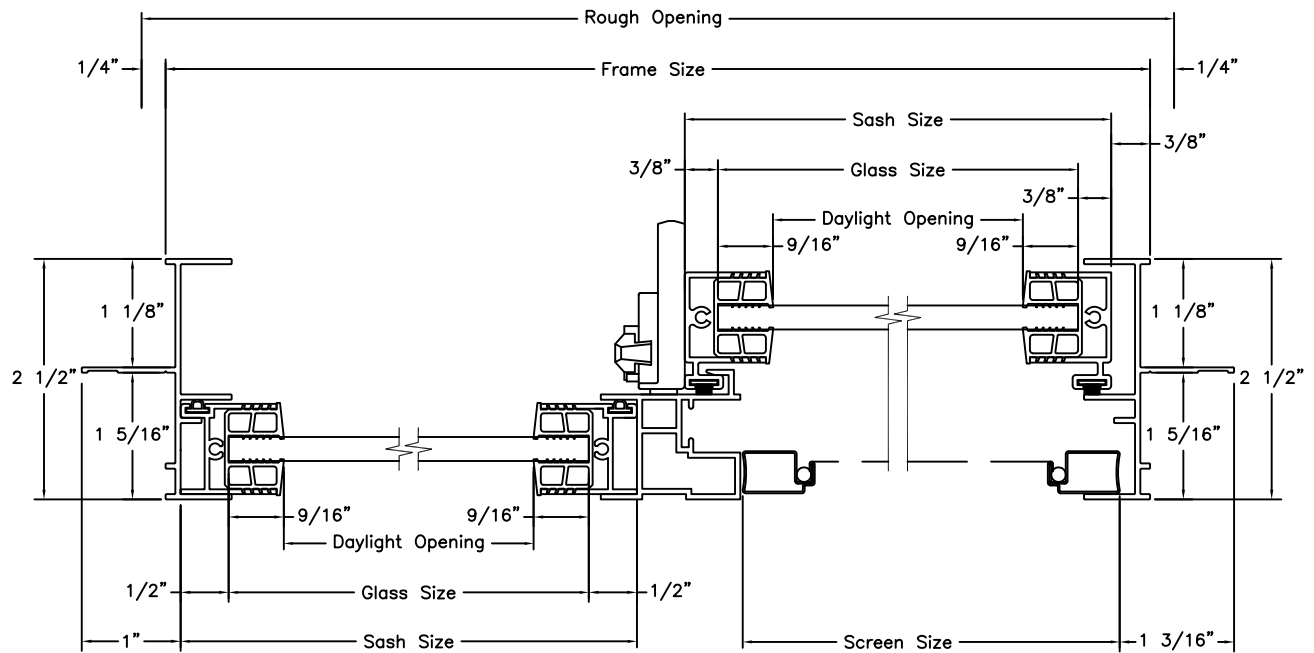

**Horizontal Section**

3 WIDE 1" IG HORIZONTAL SECTION

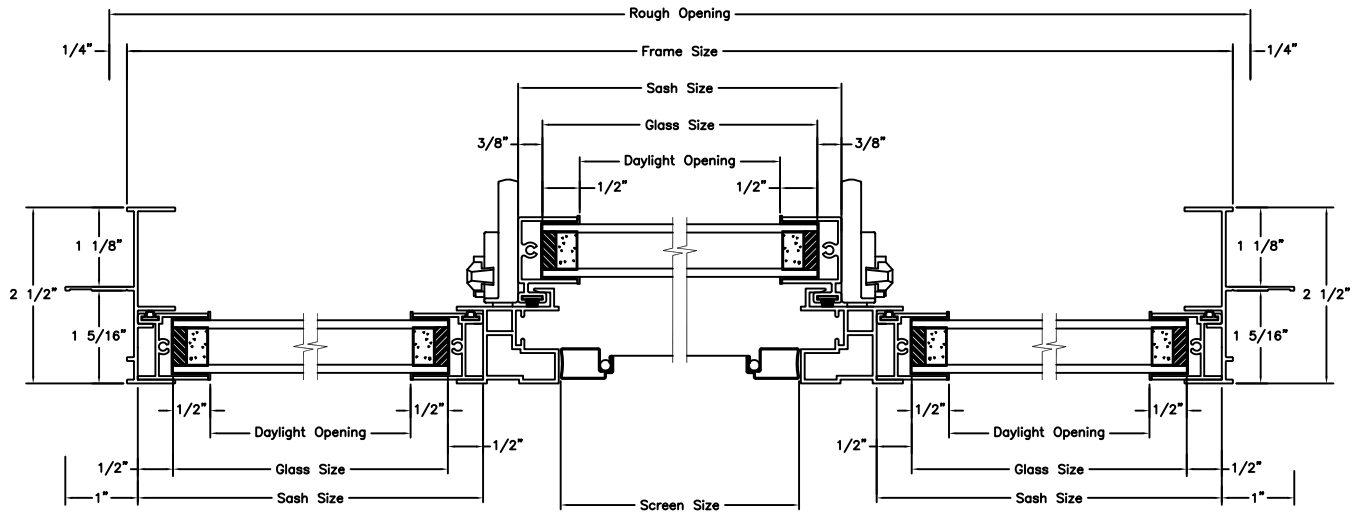

**Horizontal Section**

### SINGLE UNIT ELEVATIONS

UNIT SIZE	25 1/4"(641)	31 1/4"(794)	37 1/4"(946)	49 1/4"(1251)	61 1/4"(1556)
ROUGH OPENING	24"(610)	30"(762)	36"(914)	48"(1219)	60"(1524)
FRAME SIZE	23 1/2"(597)	29 1/2"(749)	35 1/2"(902)	47 1/2"(1207)	59 1/2"(1511)
DAYLIGHT OPENING	9 5/16"(237)	12 5/16"(313)	15 5/16"(389)	21 5/16"(541)	27 5/16"(694)
	9"(229)	12"(305)	15"(381)	21"(533)	27"(686)
13 1/4"(337)					
127(305)	2010	2610	3010	4010	5010
11 1/2"(292)					
7 1/4"(184)	2016	2616	3016	4016	5016
19 1/4"(489)					
187(457)	2020	2620	3020	4020	5020
17 1/2"(445)					
13 1/4"(337)	2026	2626	3026	4026	5026
25 1/4"(641)					
247(610)	2030	2630	3030	4030	5030
23 1/2"(597)					
19 1/4"(489)	2036	2636	3036	4036	5036
31 1/4"(794)					
307(762)	2040	2640	3040	4040	5040
29 1/2"(749)					
25 1/4"(641)	2646	3046	4046	5046	
37 1/4"(946)					
367(914)					
35 1/2"(902)					
31 1/4"(794)					
43 1/4"(1099)					
427(1067)					
41 1/2"(1054)					
37 1/4"(946)					
49 1/4"(1251)					
487(1219)					
47 1/2"(1207)					
43 1/4"(1099)					
55 1/4"(1403)					
547(1372)					
53 1/2"(1359)					
49 1/4"(1251)					

**ELEVATION SYMBOL LEGEND:**

VALUES IN ( ) ARE IN MILLIMETER CONVERSIONS.

**E** BASIC UNIT CLEAR OPENING EXCEEDS 20" IN WIDTH, 24" IN HEIGHT & A MINIMUM OF 5.7 SQ. FT.

SINGLE UNIT ELEVATIONS

UNIT SIZE  
ROUGH OPENING  
FRAME SIZE  
DAYLIGHT OPENING

31 1/4"(794)  
30"(762)  
29 1/2"(749)  
12 5/16"(313)  
12"(305)

37 1/4"(946)  
36"(914)  
35 1/2"(902)  
15 5/16"(389)  
15"(381)

49 1/4"(1251)  
48"(1219)  
47 1/2"(1207)  
21 5/16"(541)  
21"(533)

61 1/4"(1556)  
60"(1524)  
59 1/2"(1511)  
27 5/16"(694)  
27"(686)

61 1/4"(1566)  
60"(1534)  
59 1/2"(1511)  
55 1/4"(1403)

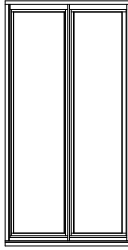

2650

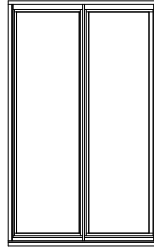

3050

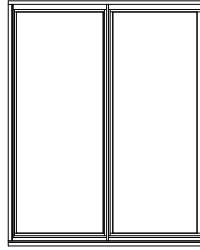

4050

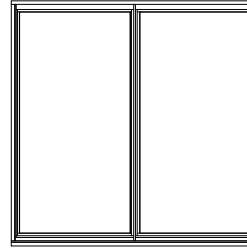

5050

73 1/4"(1861)  
72"(1829)  
71 1/2"(1816)  
67 1/4"(1708)

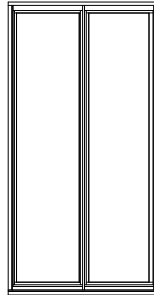

3060

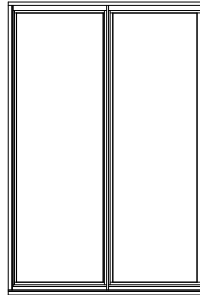

4060

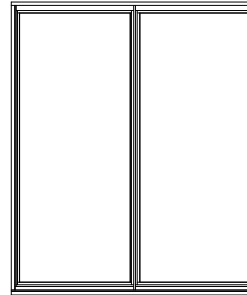

5060



**SINGLE UNIT ELEVATIONS**

UNIT SIZE  
ROUGH OPENING  
FRAME SIZE  
DAYLIGHT OPENING

73 1/4"(1861)  
72"(1829)  
71 1/2"(1861)  
33 5/16"(846)  
33"(838)

85 1/4"(2165)  
84"(2134)  
83 1/2"(2121)  
39 5/16"(999)  
39"(991)

97 1/4"(2470)  
96"(2438)  
95 1/2"(2426)  
45 5/16"(1151)  
45"(1143)

13 1/4"(337)  
12"(305)  
11 1/2"(292)  
7 1/4"(184)



6010



7010

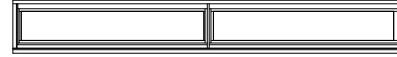

8010

19 1/4"(489)  
18"(457)  
17 1/2"(445)  
13 1/4"(337)

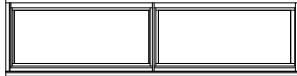

6016

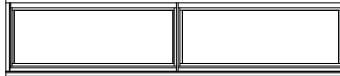

7016

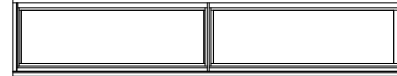

8016

25 1/4"(641)  
24"(610)  
23 1/2"(597)  
19 1/4"(489)



6020



7020



8020

31 1/4"(794)  
30"(762)  
29 1/2"(749)  
25 1/4"(641)

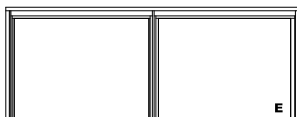

6026

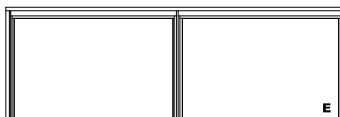

7026

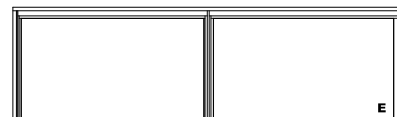

8026

37 1/4"(946)  
36"(914)  
35 1/2"(902)  
31 1/4"(794)

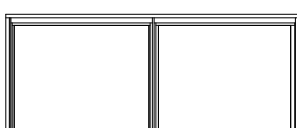

6030

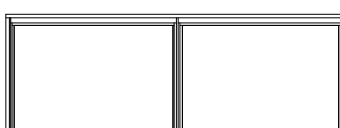

7030

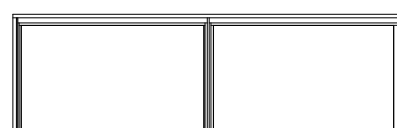

8030

43 1/4"(1099)  
42"(1067)  
41 1/2"(1054)  
37 1/4"(946)

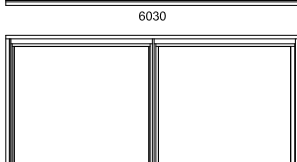

6036

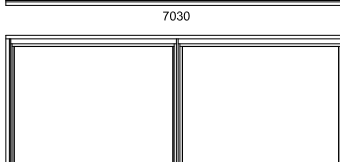

7036

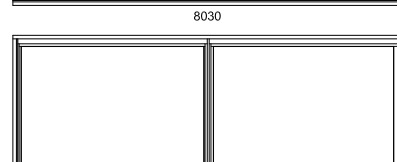

8036

49 1/4"(1251)  
48"(1219)  
47 1/2"(1207)  
43 1/4"(1099)

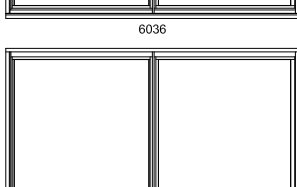

6040

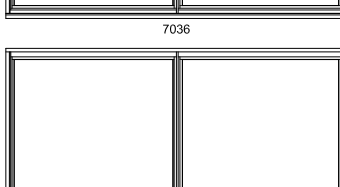

7040

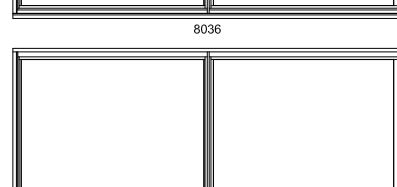

8040

55 1/4"(1403)  
54"(1372)  
53 1/2"(1359)  
49 1/4"(1251)

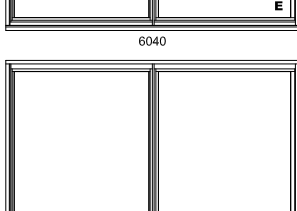

6046

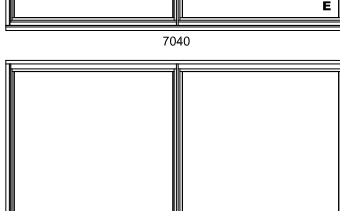

7046

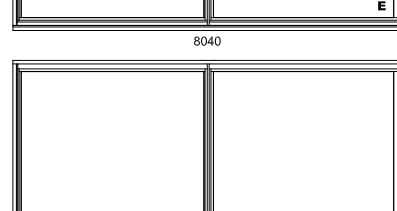

8046

**SINGLE UNIT ELEVATIONS**

UNIT SIZE  
ROUGH OPENING  
FRAME SIZE  
DAYLIGHT OPENING

73 1/4"(1861)  
72"(1829)  
71 1/2"(1861)  
33 5/16"(846)  
33"(838)

85 1/4"(2165)  
84"(2134)  
83 1/2"(2121)  
39 5/16"(999)  
39"(991)

97 1/4"(2470)  
96"(2438)  
95 1/2"(2426)  
45 5/16"(1151)  
45"(1143)

61 1/4"(1556)  
60"(1524)  
59 1/2"(1511)  
55 1/4"(1403)

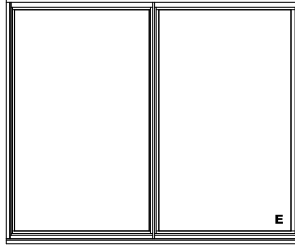

6050

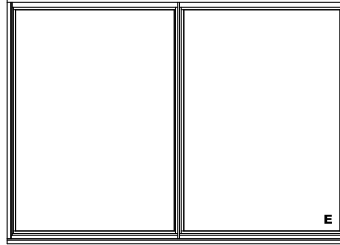

7050

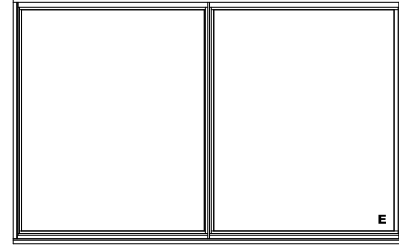

8050

73 1/4"(1861)  
72"(1829)  
71 1/2"(1861)  
67 1/4"(1708)

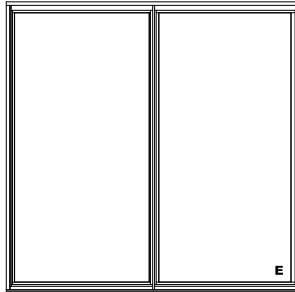

6060

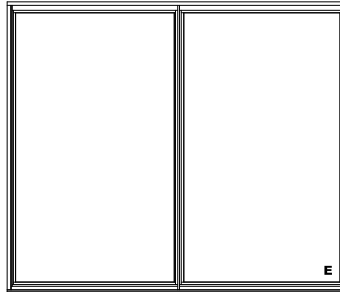

7060

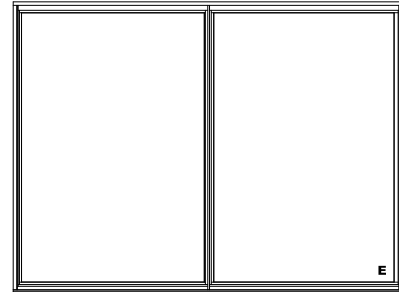

8060











### 3 WIDE UNIT ELEVATIONS

	73 1/4"(1861)	85 1/4"(2165)	97 1/4"(2470)	109 1/4"(2775)	121 1/4"(3080)
UNIT SIZE	73 1/4"(1861)	85 1/4"(2165)	97 1/4"(2470)	109 1/4"(2775)	121 1/4"(3080)
ROUGH OPENING	72"(1829)	84"(2134)	96"(2438)	108"(2743)	120"(3048)
FRAME SIZE	71 1/2"(1861)	83 1/2"(2121)	95 1/2"(2426)	107 1/2"(2731)	119 1/2"(3035)
DAYLIGHT OPENING	9 5/8"(244)[2] 45 15/16"(1169)	12 5/8"(321)[2] 51 15/16"(1319)	15 5/8"(397)[2] 57 15/16"(1471)	21 5/8"(649)[2] 57 15/16"(1471)	27 5/8"(702)[2] 57 15/16"(1471)
13 1/4"(337) 12"(305) 18"(457) 11 1/2"(292) 7 1/4"(184)					
19 1/4"(489) 18"(457) 17 1/2"(445) 13 1/4"(337)					
25 1/4"(641) 24"(610) 23 1/2"(597) 19 1/4"(489)					
31 1/4"(794) 30"(762) 29 1/2"(749) 25 1/4"(641)					
37 1/4"(946) 36"(914) 35 1/2"(902) 31 1/4"(794)					
43 1/4"(1099) 42"(1067) 41 1/2"(1054) 37 1/4"(946)					
49 1/4"(1251) 48"(1219) 47 1/2"(1207) 43 1/4"(1099)					
55 1/4"(1403) 54"(1372) 53 1/2"(1359) 49 1/4"(1251)					
61 1/4"(1556) 60"(1524) 59 1/2"(1511) 55 1/4"(1403)					
73 1/4"(1861) 72"(1829) 71 1/2"(1861) 67 1/4"(1708)					

**ELEVATION SYMBOL LEGEND:**

VALUES IN ( ) ARE IN MILLIMETER CONVERSIONS.  
**E** BASIC UNIT CLEAR OPENING EXCEEDS 20" IN WIDTH, 24" IN HEIGHT & A MINIMUM OF 5.7 SQ. FT.

3 WIDE UNIT ELEVATIONS

UNIT SIZE	145 1/4"(3689)
ROUGH OPENING	144"(3658)
FRAME SIZE	143 1/2"(3645)
DAYLIGHT OPENING	33 5/8"(854)[2] 69 15/16"(1776)
13 1/4"(337) 12"(305) 11 1/2"(292) 7 1/4"(184)	 12010
19 1/4"(489) 18"(457) 17 1/2"(445) 13 1/4"(337)	 12016
25 1/4"(641) 24"(610) 23 1/2"(597) 19 1/4"(489)	 12020
31 1/4"(794) 30"(762) 29 1/2"(749) 25 1/4"(641)	 12026
37 1/4"(946) 36"(914) 35 1/2"(902) 31 1/4"(794)	 12030
43 1/4"(1099) 42"(1067) 41 1/2"(1054) 37 1/4"(946)	 12036
49 1/4"(1251) 48"(1219) 47 1/2"(1207) 43 1/4"(1099)	 12040
55 1/4"(1403) 54"(1372) 53 1/2"(1359) 49 1/4"(1251)	 12046
61 1/4"(1556) 60"(1524) 59 1/2"(1511) 55 1/4"(1403)	 12050
73 1/4"(1861) 72"(1829) 71 1/2"(1861) 67 1/4"(1708)	 12060