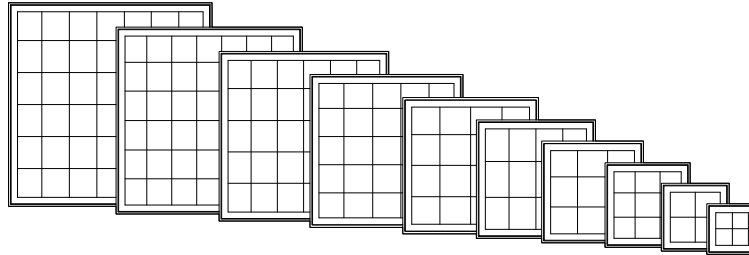

TABLE OF CONTENTS

Elevations/Sizes: 1/4" & 1/8" Scale	3-2
Casement	3-5
Casement Picture	3-20
Casement Sector Top	3-41
Extended Half Round	3-44
Extended Quarter Round	3-47
Glazing Options	3-49
Trim Options	3-58
Standard Mullion Options	3-61
Lite Cut Information	3-62
Unit Sizing, Rough Openings & Masonry Openings	3-63
Section Details: 6" Scale	3-65

GENERAL INFORMATION
CASEMENT



DIMENSIONAL WINDOWS

Clad Epic casement windows may be specified as “dimensional” by adjusting the desired rough opening width or height in 1/4” increments from standard.

Clad Epic casement windows are available with left or right hand operation, or stationary (non-venting). Operating mechanism includes corrosion resistant steel hinges and dual arm roto-type operator with hardened steel gears and operating arms. Sash locks are concealed unison type with an exposed locking lever and escutcheon plate. There are several interior hardware finish options. Refer to the Specifications for finish options.

MULTIPLE ASSEMBLIES

Clad Epic casement windows may be mullied above, below, or beside other clad casement windows, or other clad window products. Factory assembled mulls are limited in height (100”), width (150”), and a total area (75 square feet).

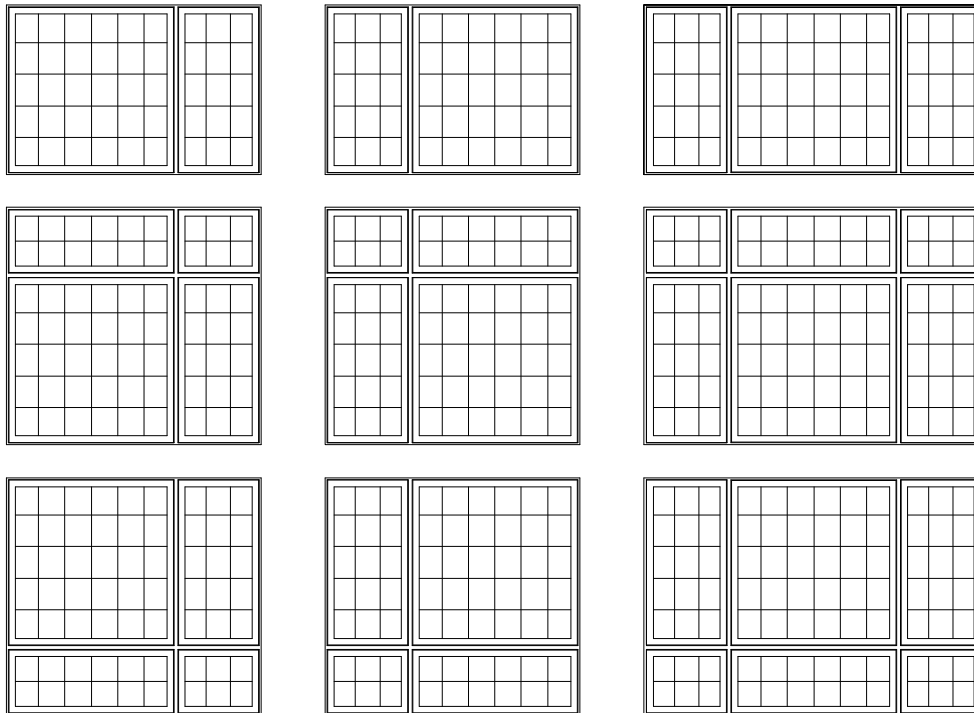

**HANDING & OPERATION
CASEMENT**

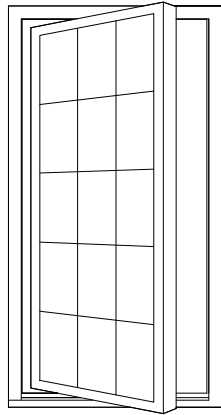

**LEFT
HAND**

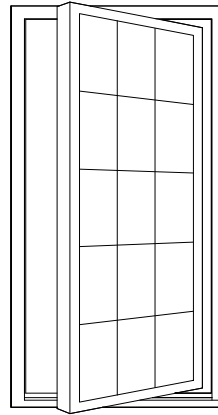

**RIGHT
HAND**

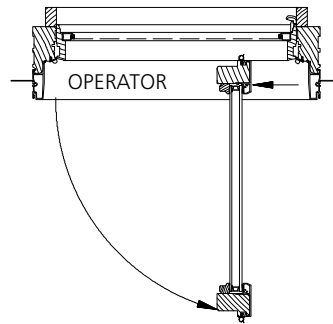
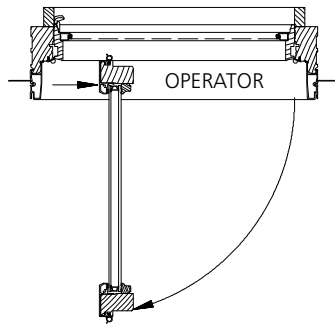

CASEMENT UNIT HANDING:
UNIT HANDING IS DEFINED (FROM
THE EXTERIOR) AS THE
DIRECTION THE SASH OPENS.

ELEVATION NOTES
CASEMENT

ELEVATION DRAWINGS UTILIZE A LIMITED NUMBER OF PROJECTED LINES TO PRODUCE A RUDIMENTARY DRAWING INTENDED TO BE USED IN A SMALL GRAPHICAL SCALE. ELEVATIONS ARE VIEWED PERPENDICULAR FROM THE EXTERIOR OF THE STRUCTURE. IF MORE DIMENSIONS ARE NEEDED, USE THE SECTION DRAWINGS FOR MORE COMPLETE DEPICTIONS.

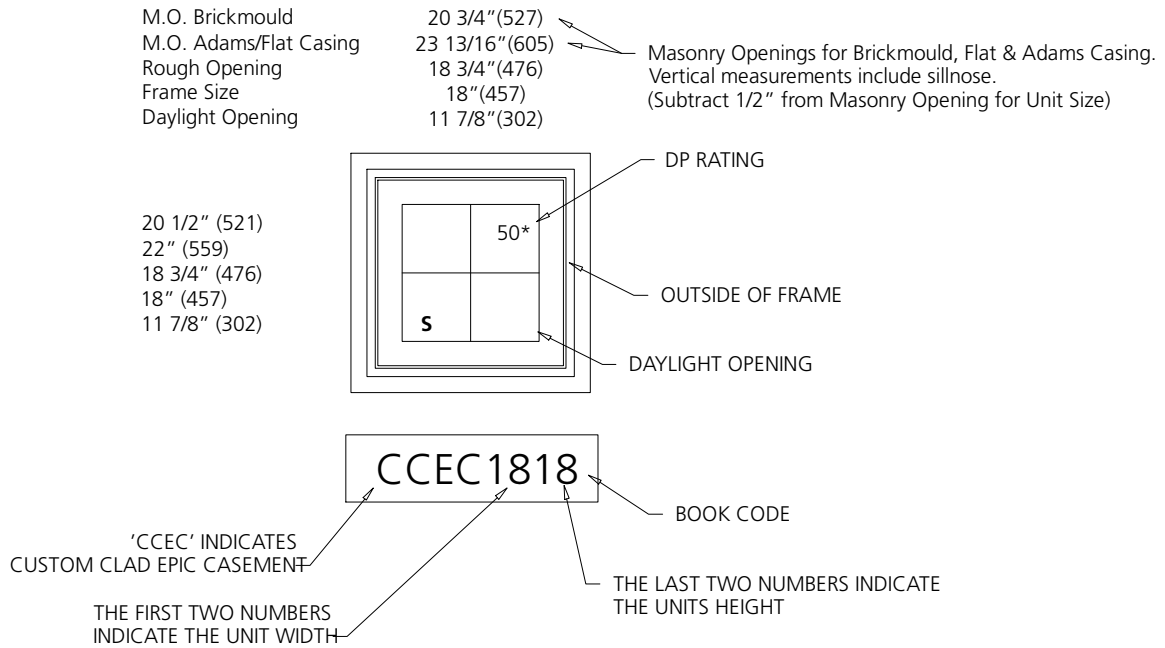

GENERAL CLAD EPIC CASEMENT NOTES:

1. CLAD EPIC CASEMENT (CCEC) UNITS ARE AVAILABLE AS OPERATING OR FIXED UNITS.
2. 'CCEP' IN A BOOD CODE DENOTES THE UNIT IS A CLAD EPIC CASEMENT PICTURE (FIXED) UNIT.
3. UNIT ELEVATIONS ARE SHOWN WITHOUT EXTERIOR TRIM. UNIT SIZES & MASONRY OPENING DIMENSIONS WILL CHANGE WITH THE ADDITION OF EXTERIOR TRIM. SEE THE 'UNIT SIZING, ROUGH OPENINGS & MASONRY OPENINGS' PAGE FOR EXTERIOR TRIM EFFECTS.
4. OPERATING UNITS ARE AVAILABLE AS LEFT OR RIGHT HAND OPERATION.
5. DIMENSIONAL VALUES IN () ARE MILLIMETER CONVERSIONS.

ELEVATION SYMBOL LEGEND:

- ##*** NUMBER INDICATES DESIGN PRESSURE (DP) RATING WITH STANDARD GLAZING. OPERATING UNITS UTILIZE A CONCEALED LOCKING SYSTEM FOR DP RATINGS.
- E** UNIT MEETS EGRESS REQUIREMENTS FOR IRC CODE. STATE AND LOCAL EGRESS CODES MAY DIFFER. ALWAYS REFER TO LOCAL BUILDING CODES FOR COMPLETE REQUIREMENTS. CHECK WITH LOCAL OFFICIALS TO ENSURE COMPLIANCE BEFORE INSTALLING THE UNIT.
- S** STATIONARY UNIT.
- LO** LIMITED OPERATION.

1-WIDE UNITS

M.O. BRICKMOULD	20 3/4" (527)	22 3/4" (578)	26 3/4" (679)	30 3/4" (781)	32 3/4" (832)	34 3/4" (883)	38 3/4" (984)
M.O. ADAMS/FLAT CASING	23 13/16" (605)	25 13/16" (656)	29 13/16" (757)	33 13/16" (859)	35 13/16" (910)	37 13/16" (960)	41 13/16" (1062)
ROUGH OPENING	18 3/4" (476)	20 3/4" (527)	24 3/4" (629)	28 3/4" (730)	30 3/4" (781)	32 3/4" (832)	36 3/4" (933)
FRAME SIZE	18" (457)	20" (508)	24" (610)	28" (711)	30" (762)	32" (813)	36" (914)
DAYLIGHT OPENING	11 7/8" (302)	13 7/8" (352)	17 7/8" (454)	21 7/8" (556)	23 7/8" (607)	25 7/8" (657)	29 7/8" (759)
16 1/2" (419) 18" (457) 14 3/4" (375) 14" (356) 7 7/8" (200)							
CCEC1814	CCEC2014	CCEC2414	CCEC2814	CCEC3014	CCEC3214	CCEC3614	
20 1/2" (521) 22" (559) 18 3/4" (476) 18" (457) 11 7/8" (302)							
CCEC1818	CCEC2018	CCEC2418	CCEC2818	CCEC3018	CCEC3218	CCEC3618	
22 1/2" (572) 24" (610) 20 3/4" (527) 20" (508) 13 7/8" (352)							
CCEC1820	CCEC2020	CCEC2420	CCEC2820	CCEC3020	CCEC3220	CCEC3620	
26 1/2" (673) 28" (711) 24 3/4" (629) 24" (610) 17 7/8" (454)							
CCEC1824	CCEC2024	CCEC2424	CCEC2824	CCEC3024	CCEC3224	CCEC3624	
30 1/2" (775) 32" (813) 28 3/4" (730) 28" (711) 21 7/8" (556)							
CCEC1828	CCEC2028	CCEC2428	CCEC2828	CCEC3028	CCEC3228	CCEC3628	
32 1/2" (826) 34" (864) 30 3/4" (781) 30" (762) 23 7/8" (607)							
CCEC1830	CCEC2030	CCEC2430	CCEC2830	CCEC3030	CCEC3230	CCEC3630	
34 1/2" (876) 36" (914) 32 3/4" (832) 32" (813) 25 7/8" (657)							
CCEC1832	CCEC2032	CCEC2432	CCEC2832	CCEC3032	CCEC3232	CCEC3632	
38 1/2" (978) 40" (1016) 36 3/4" (933) 36" (914) 29 7/8" (759)							
CCEC1836	CCEC2036	CCEC2436	CCEC2836	CCEC3036	CCEC3236	CCEC3636	
42 1/2" (1080) 44" (1118) 40 3/4" (1035) 40" (1016) 33 7/8" (860)							
CCEC1840	CCEC2040	CCEC2440	CCEC2840	CCEC3040	CCEC3240	CCEC3640	

ELEVATION SYMBOL LEGEND:

M.O. = MASONRY OPENING
VALUES IN () ARE IN MILLIMETER CONVERSIONS.

##* NUMBER INDICATES DESIGN PRESSURE (DP) RATING WITH STANDARD GLAZING. OPERATING UNITS UTILIZE A CONCEALED LOCKING SYSTEM FOR DP RATINGS.

E UNIT MEETS EGRESS REQUIREMENTS FOR IRC CODE. STATE AND LOCAL EGRESS CODES MAY DIFFER. ALWAYS REFER TO LOCAL BUILDING CODES FOR COMPLETE REQUIREMENTS.

CHECK WITH LOCAL OFFICIALS TO ENSURE COMPLIANCE BEFORE INSTALLING THE UNIT.

S STATIONARY UNIT.

Note: Elevations shown DO NOT have exterior trim. Subtract 3/4" (19) from M.O. (Masonry Opening) for Unit Sizes. Masonry Openings above include Sill Nose, see Trim Options page for Sill Nose specifications. For other Trim Options refer to the Unit Sizing, Rough Opening & Masonry Openings page.

SCALE: 1/4" = 1'

1-WIDE UNITS

M.O. BRICKMOULD	20 3/4"(527)	22 3/4"(578)	26 3/4"(679)	30 3/4"(781)	32 3/4"(832)	34 3/4"(883)	38 3/4"(984)
M.O. ADAMS/FLAT CASING	23 13/16"(605)	25 13/16"(656)	29 13/16"(757)	33 13/16"(859)	35 13/16"(910)	37 13/16"(960)	41 13/16"(1062)
ROUGH OPENING	18 3/4"(476)	20 3/4"(527)	24 3/4"(629)	28 3/4"(730)	30 3/4"(781)	32 3/4"(832)	36 3/4"(933)
FRAME SIZE	18"(457)	20"(508)	24"(610)	28"(711)	30"(762)	32"(813)	36"(914)
DAYLIGHT OPENING	11 7/8"(302)	13 7/8"(352)	17 7/8"(454)	21 7/8"(556)	23 7/8"(607)	25 7/8"(657)	29 7/8"(759)
44 1/2"(1130) 46"(1168) 42 3/4"(1086) 42"(1067) 35 7/8"(911)							
CCEC1842	CCEC2042	CCEC2442	CCEC2842	CCEC3042	CCEC3242	CCEC3642	
50 1/2"(1283) 52"(1321) 48 3/4"(1238) 48"(1219) 41 7/8"(1064)							
CCEC1848	CCEC2048	CCEC2448	CCEC2848	CCEC3048	CCEC3248	CCEC3648	
56 1/2"(1435) 58"(1473) 54 3/4"(1391) 54"(1372) 47 7/8"(1216)							
CCEC1854	CCEC2054	CCEC2454	CCEC2854	CCEC3054	CCEC3254	CCEC3654	
58 1/2"(1486) 60"(1524) 56 3/4"(1441) 56"(1422) 49 7/8"(1267)							
CCEC1856	CCEC2056	CCEC2456	CCEC2856	CCEC3056	CCEC3256	CCEC3656	
62 1/2"(1588) 64"(1626) 60 3/4"(1543) 60"(1524) 53 7/8"(1368)							
CCEC1860	CCEC2060	CCEC2460	CCEC2860	CCEC3060	CCEC3260	CCEC3660	
66 1/2"(1689) 68"(1727) 64 3/4"(1645) 64"(1626) 57 7/8"(1470)							
CCEC1864	CCEC2064	CCEC2464	CCEC2864	CCEC3064	CCEC3264	CCEC3664	

ELEVATION SYMBOL LEGEND:

M.O. = MASONRY OPENING
VALUES IN () ARE IN MILLIMETER CONVERSIONS.

NUMBER INDICATES DESIGN PRESSURE (DP) RATING WITH STANDARD GLAZING. OPERATING UNITS UTILIZE A CONCEALED LOCKING SYSTEM FOR DP RATINGS.

E UNIT MEETS EGRESS REQUIREMENTS FOR IRC CODE. STATE AND LOCAL EGRESS CODES MAY DIFFER. ALWAYS REFER TO LOCAL BUILDING CODES FOR COMPLETE REQUIREMENTS. CHECK WITH LOCAL OFFICIALS TO ENSURE COMPLIANCE BEFORE INSTALLING THE UNIT.

Note: Elevations shown DO NOT have exterior trim. Subtract 3/4" (19) from M.O. (Masonry Opening) for Unit Sizes. Masonry Openings above include Sill Nose, see Trim Options page for Sill Nose specifications. For other Trim Options refer to the Unit Sizing, Rough Opening & Masonry Openings page.

SCALE: 1/4" = 1'

1-WIDE UNITS

	20 3/4" (527)	22 3/4" (578)	26 3/4" (679)	30 3/4" (781)	32 3/4" (832)	34 3/4" (883)	38 3/4" (984)
M.O. BRICKMOULD	23 13/16" (605)	25 13/16" (656)	29 13/16" (757)	33 13/16" (859)	35 13/16" (910)	37 13/16" (960)	41 13/16" (1062)
M.O. ADAMS/FLAT CASING	18 3/4" (476)	20 3/4" (527)	24 3/4" (629)	28 3/4" (730)	30 3/4" (781)	32 3/4" (832)	36 3/4" (933)
ROUGH OPENING	18" (457)	20" (508)	24" (610)	28" (711)	30" (762)	32" (813)	36" (914)
FRAME SIZE	11 7/8" (302)	13 7/8" (352)	17 7/8" (454)	21 7/8" (556)	23 7/8" (607)	25 7/8" (657)	29 7/8" (759)
DAYLIGHT OPENING							
	CCEC1866	CCEC2066	CCEC2466	CCEC2866	CCEC3066	CCEC3266	CCEC3666
	CCEC1872	CCEC2072	CCEC2472	CCEC2872	CCEC3072	CCEC3272	CCEC3672
	CCEC1878	CCEC2078	CCEC2478	CCEC2878	CCEC3078	CCEC3278	CCEC3678
	CCEC1884	CCEC2084	CCEC2484	CCEC2884	CCEC3084	CCEC3284	CCEC3684

ELEVATION SYMBOL LEGEND:

M.O. = MASONRY OPENING
VALUES IN () ARE IN MILLIMETER CONVERSIONS.







NUMBER INDICATES DESIGN PRESSURE (DP) RATING WITH STANDARD GLAZING.

E UNIT MEETS EGRESS REQUIREMENTS FOR IRC CODE. STATE AND LOCAL EGRESS CODES MAY DIFFER. ALWAYS REFER TO LOCAL BUILDING CODES FOR COMPLETE REQUIREMENTS. CHECK WITH LOCAL OFFICIALS TO ENSURE COMPLIANCE BEFORE INSTALLING THE UNIT.

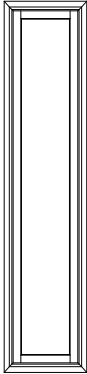
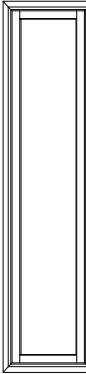
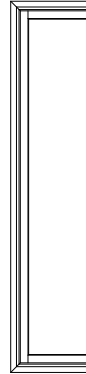
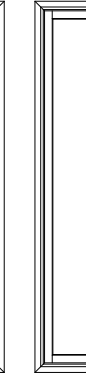
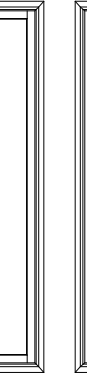
Note: Elevations shown DO NOT have exterior trim. Subtract 3/4" (19) from M.O. (Masonry Opening) for Unit Sizes. Masonry Openings above include Sill Nose, see Trim Options page for Sill Nose specifications. For other Trim Options refer to the Unit Sizing, Rough Opening & Masonry Openings page.

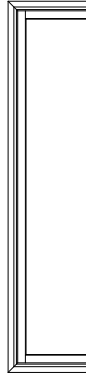
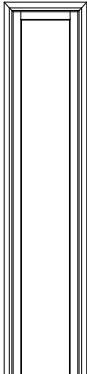
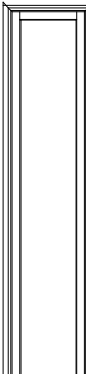
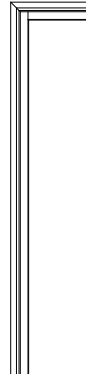
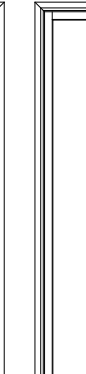
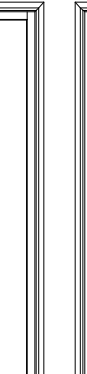
SCALE: 1/4" = 1'

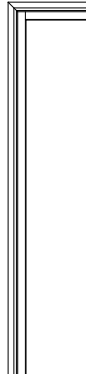
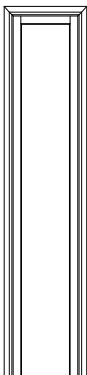
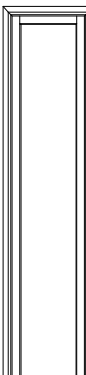
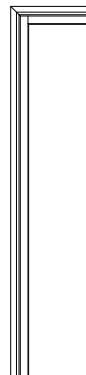
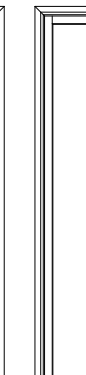
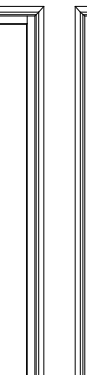
1-WIDE UNITS

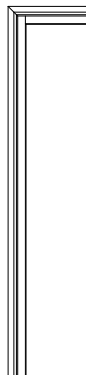
M.O. BRICKMOULD	20 3/4" (527)	22 3/4" (578)	26 3/4" (679)	30 3/4" (781)	32 3/4" (832)	34 3/4" (883)	38 3/4" (984)		
M.O. ADAMS/FLAT CASING	23 13/16" (605)	25 13/16" (656)	29 13/16" (757)	33 13/16" (859)	35 13/16" (910)	37 13/16" (960)	41 13/16" (1062)		
ROUGH OPENING	18 3/4" (476)	20 3/4" (527)	24 3/4" (629)	28 3/4" (730)	30 3/4" (781)	32 3/4" (832)	36 3/4" (933)		
FRAME SIZE	18" (457)	20" (508)	24" (610)	28" (711)	30" (762)	32" (813)	36" (914)		
DAYLIGHT OPENING	11 7/8" (302)	13 7/8" (352)	17 7/8" (454)	21 7/8" (556)	23 7/8" (607)	25 7/8" (657)	29 7/8" (759)		
92 1/2" (2350) 94 7/8" (2388) 90 3/4" (2305) 90" (2286) 83 7/8" (2130)									
	CCEC1890	CCEC2090	CCEC2490	CCEC2890	CCEC3090	CCEC3290	CCEC3690		
	98 1/2" (2502) 100" (2540) 96 3/4" (2457) 96" (2438) 89 7/8" (2283)								
		CCEC1896	CCEC2096	CCEC2496	CCEC2896	CCEC3096	CCEC3296	CCEC3696	
		104 1/2" (2654) 106" (2692) 102 3/4" (2610) 102" (2591) 95 7/8" (2435)							
			CCEC18102	CCEC20102	CCEC24102	CCEC28102	CCEC30102	CCEC32102	CCEC36102

ELEVATION SYMBOL LEGEND:

M.O. = MASONRY OPENING
VALUES IN () ARE IN MILLIMETER CONVERSIONS.

NUMBER INDICATES DESIGN PRESSURE (DP) RATING WITH STANDARD GLAZING.

E UNIT MEETS EGRESS REQUIREMENTS FOR IRC CODE. STATE AND LOCAL EGRESS CODES MAY DIFFER. ALWAYS REFER TO LOCAL BUILDING CODES FOR COMPLETE REQUIREMENTS.
CHECK WITH LOCAL OFFICIALS TO ENSURE COMPLIANCE BEFORE INSTALLING THE UNIT.

Note: Elevations shown DO NOT have exterior trim. Subtract 3/4" (19) from M.O. (Masonry Opening) for Unit Sizes. Masonry Openings above include Sill Nose, see Trim Options page for Sill Nose specifications. For other Trim Options refer to the Unit Sizing, Rough Opening & Masonry Openings page.

SCALE: 1/4" = 1'

1-WIDE UNITS

M.O. BRICKMOULD	20 3/4"(527)	22 3/4"(578)	26 3/4"(679)	30 3/4"(781)	32 3/4"(832)	34 3/4"(883)	38 3/4"(984)
M.O. ADAMS/FLAT CASING	23 13/16"(605)	25 13/16"(656)	29 13/16"(757)	33 13/16"(859)	35 13/16"(910)	37 13/16"(960)	41 13/16"(1062)
ROUGH OPENING	18 3/4"(476)	20 3/4"(527)	24 3/4"(629)	28 3/4"(730)	30 3/4"(781)	32 3/4"(832)	36 3/4"(933)
FRAME SIZE	18"(457)	20"(508)	24"(610)	28"(711)	30"(762)	32"(813)	36"(914)
DAYLIGHT OPENING	11 7/8"(302)	13 7/8"(352)	17 7/8"(454)	21 7/8"(556)	23 7/8"(607)	25 7/8"(657)	29 7/8"(759)

110 1/2"(2807)
112"(2849)
108 3/4"(2762)
108"(2743)
101 7/8"(2588)

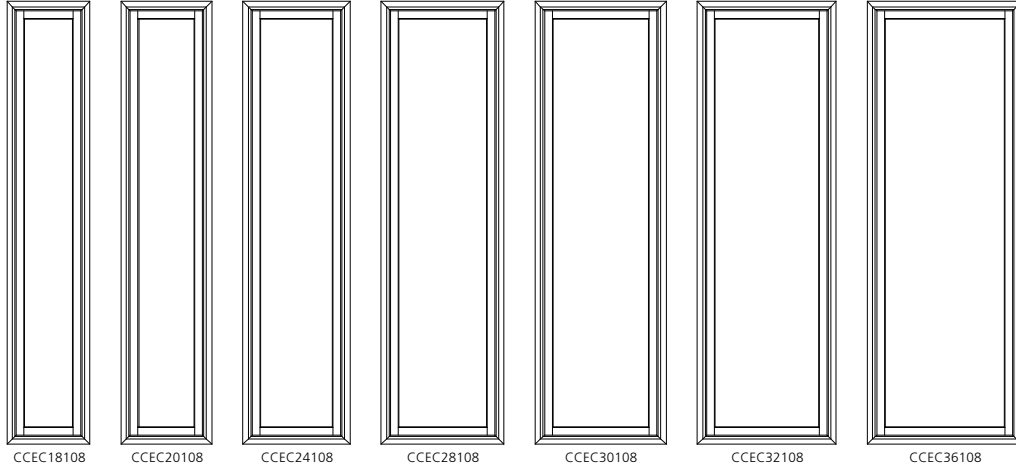

ELEVATION SYMBOL LEGEND:

M.O. = MASONRY OPENING
VALUES IN () ARE IN MILLIMETER CONVERSIONS.

##* NUMBER INDICATES DESIGN PRESSURE (DP) RATING WITH STANDARD GLAZING.

E UNIT MEETS EGRESS REQUIREMENTS FOR IRC CODE. STATE AND LOCAL EGRESS CODES MAY DIFFER. ALWAYS REFER TO LOCAL BUILDING CODES FOR COMPLETE REQUIREMENTS. CHECK WITH LOCAL OFFICIALS TO ENSURE COMPLIANCE BEFORE INSTALLING THE UNIT.

Note: Elevations shown DO NOT have exterior trim. Subtract 3/4" (19) from M.O. (Masonry Opening) for Unit Sizes. Masonry Openings above include Sill Nose, see Trim Options page for Sill Nose specifications. For other Trim Options refer to the Unit Sizing, Rough Opening & Masonry Openings page.

SCALE: 1/4" = 1'

1-WIDE UNITS

M.O. BRICKMOULD M.O. ADAMS/FLAT CASING ROUGH OPENING FRAME SIZE DAYLIGHT OPENING	42 3/4" (1086) 45 13/16" (1164) 40 3/4" (1035) 40" (1016) 33 7/8" (860)	44 3/4" (1137) 47 13/16" (1214) 42 3/4" (1086) 42" (1067) 35 7/8" (911)	46 3/4" (1187) 49 13/16" (1265) 44 3/4" (1137) 44" (1118) 37 7/8" (962)	50 3/4" (1289) 53 13/16" (1367) 48 3/4" (1238) 48" (1219) 41 7/8" (1064)	56 3/4" (1441) 59 13/16" (1519) 54 3/4" (1391) 54" (1372) 47 7/8" (1216)
16 1/2" (419) 18" (457) 14 3/4" (375) 14" (356) 7 7/8" (200)					
20 1/2" (521) 22" (559) 18 3/4" (476) 18" (457) 11 7/8" (302)					
22 1/2" (572) 24" (610) 20 3/4" (527) 20" (508) 13 7/8" (352)					
26 1/2" (673) 28" (711) 24 3/4" (629) 24" (610) 17 7/8" (454)					
30 1/2" (775) 32" (813) 28 3/4" (730) 28" (711) 21 7/8" (556)					
32 1/2" (826) 34" (864) 30 3/4" (781) 30" (762) 23 7/8" (607)					
34 1/2" (876) 36" (914) 32 3/4" (832) 32" (813) 25 7/8" (657)					
38 1/2" (978) 40" (1016) 36 3/4" (933) 36" (914) 29 7/8" (759)					
42 1/2" (1080) 44" (1118) 40 3/4" (1035) 40" (1016) 33 7/8" (860)					

ELEVATION SYMBOL LEGEND:

M.O. = MASONRY OPENING
 VALUES IN () ARE IN MILLIMETER CONVERSIONS.
 ### NUMBER INDICATES DESIGN PRESSURE (DP) RATING WITH STANDARD GLAZING.
 E UNIT MEETS EGRESS REQUIREMENTS FOR IRC CODE. STATE AND LOCAL EGRESS CODES MAY DIFFER. ALWAYS REFER TO LOCAL BUILDING CODES FOR COMPLETE REQUIREMENTS.
 CHECK WITH LOCAL OFFICIALS TO ENSURE COMPLIANCE BEFORE INSTALLING THE UNIT.

Note: Elevations shown DO NOT have exterior trim. Subtract 3/4" (19) from M.O. (Masonry Opening) for Unit Sizes. Masonry Openings above include Sill Nose, see Trim Options page for Sill Nose specifications. For other Trim Options refer to the Unit Sizing, Rough Opening & Masonry Openings page.

SCALE: 1/4" = 1'

1-WIDE UNITS

M.O. BRICKMOULD M.O. ADAMS/FLAT CASING ROUGH OPENING FRAME SIZE DAYLIGHT OPENING	42 3/4" (1086) 45 13/16" (1164) 40 3/4" (1035) 40" (1016) 33 7/8" (860)	44 3/4" (1137) 47 13/16" (1214) 42 3/4" (1086) 42" (1067) 35 7/8" (911)	46 3/4" (1187) 49 13/16" (1265) 44 3/4" (1137) 44" (1118) 37 7/8" (962)	50 3/4" (1289) 53 13/16" (1367) 48 3/4" (1238) 48" (1219) 41 7/8" (1064)	56 3/4" (1441) 59 13/16" (1519) 54 3/4" (1391) 54" (1372) 47 7/8" (1216)
44 1/2" (1130) 46" (1168) 42 3/4" (1086) 42" (1067) 35 7/8" (911)					
	CCEC4042	CCEC4242	CCEC4442	CCEC4842	CCEC5442
50 1/2" (1283) 52" (1321) 48 3/4" (1238) 48" (1219) 41 7/8" (1064)					
	CCEC4048	CCEC4248	CCEC4448	CCEC4848	CCEC5448
56 1/2" (1435) 58" (1473) 54 3/4" (1391) 54" (1372) 47 7/8" (1216)					
	CCEC4054	CCEC4254	CCEC4454	CCEC4854	CCEC5454
58 1/2" (1486) 60" (1524) 56 3/4" (1441) 56" (1422) 49 7/8" (1267)					
	CCEC4056	CCEC4256	CCEC4456	CCEC4856	CCEC5456
62 1/2" (1588) 64" (1626) 60 3/4" (1543) 60" (1524) 53 7/8" (1368)					
	CCEC4060	CCEC4260	CCEC4460	CCEC4860	CCEC5460
66 1/2" (1689) 68" (1727) 64 3/4" (1645) 64" (1626) 57 7/8" (1470)					
	CCEC4064	CCEC4264	CCEC4464	CCEC4864	CCEC5464

ELEVATION SYMBOL LEGEND:
M.O. = MASONRY OPENING
 VALUES IN () ARE IN MILLIMETER CONVERSIONS.
= NUMBER INDICATES DESIGN PRESSURE (DP) RATING WITH STANDARD GLAZING.
E UNIT MEETS EGRESS REQUIREMENTS FOR IRC CODE. STATE AND LOCAL EGRESS CODES MAY DIFFER. ALWAYS REFER TO LOCAL BUILDING CODES FOR COMPLETE REQUIREMENTS.
 CHECK WITH LOCAL OFFICIALS TO ENSURE COMPLIANCE BEFORE INSTALLING THE UNIT.

Note: Elevations shown DO NOT have exterior trim. Subtract 3/4" (19) from M.O. (Masonry Opening) for Unit Sizes. Masonry Openings above include Sill Nose, see Trim Options page for Sill Nose specifications. For other Trim Options refer to the Unit Sizing, Rough Opening & Masonry Openings page.

SCALE: 1/4" = 1'

1-WIDE UNITS

M.O. BRICKMOLD
M.O. ADAMS/FLAT CASING
ROUGH OPENING
FRAME SIZE
DAYLIGHT OPENING

42 3/4"(1086)
45 13/16"(1164)
40 3/4"(1035)
40"(1016)
33 7/8"(860)

44 3/4"(1137)
47 13/16"(1214)
42 3/4"(1086)
42"(1067)
35 7/8"(911)

46 3/4"(1187)
49 13/16"(1265)
44 3/4"(1137)
44"(1118)
37 7/8"(962)

50 3/4"(1289)
53 13/16"(1367)
48 3/4"(1238)
48"(1219)
41 7/8"(1064)

56 3/4"(1441)
59 13/16"(1519)
54 3/4"(1391)
54"(1372)
47 7/8"(1216)

68 1/2"(1740)
70"(1778)
66 3/4"(1695)
66"(1676)
59 7/8"(1581)

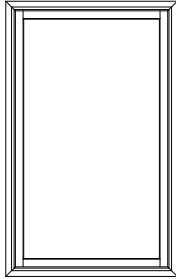

CCEC4066

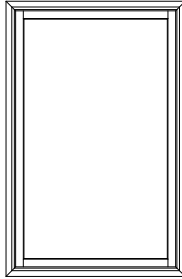

CCEC4266

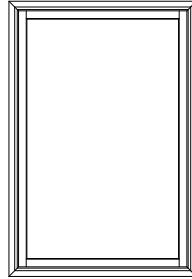

CCEC4466

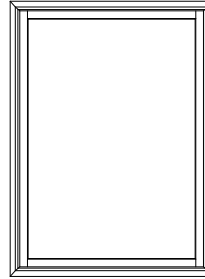

CCEC4866

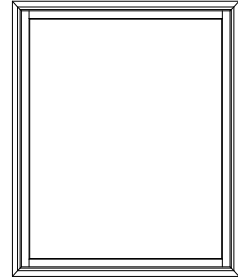

CCEC5466

74 1/2"(1892)
76"(1930)
72 3/4"(1848)
72"(1829)
65 7/8"(1673)

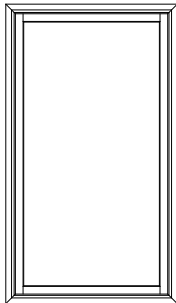

CCEC4072

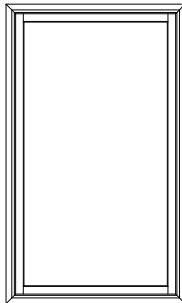

CCEC4272

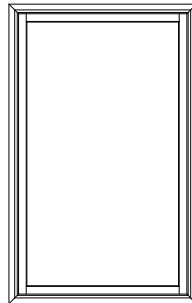

CCEC4472

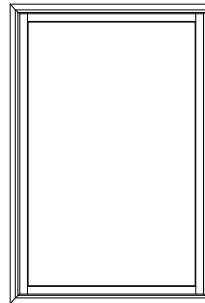

CCEC4872

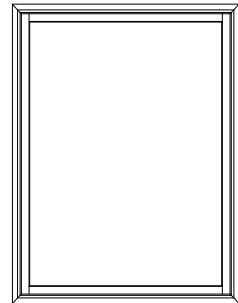

CCEC5472

80 1/2"(2045)
82"(2083)
78 3/4"(2000)
78"(1981)
71 7/8"(1826)

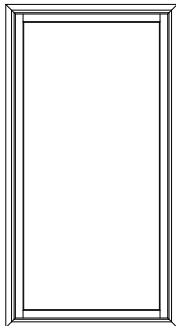

CCEC4078

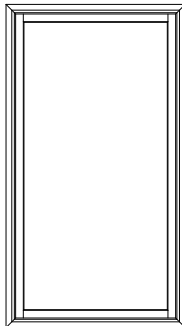

CCEC4278

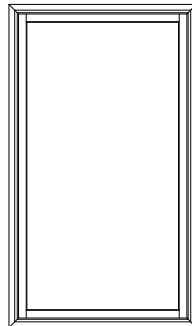

CCEC4478

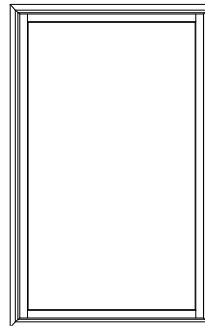

CCEC4878

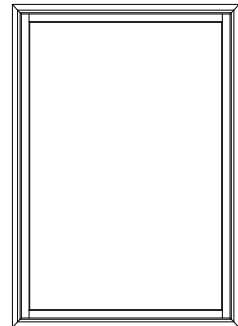

CCEC5478

86 1/2"(2197)
88"(2235)
84 3/4"(2153)
84"(2134)
77 7/8"(1978)

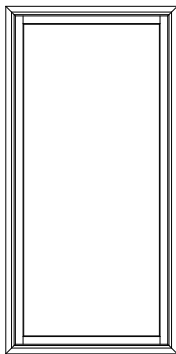

CCEC4084

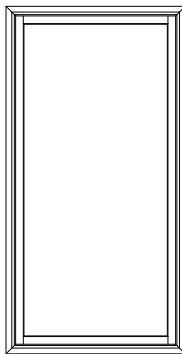

CCEC4284

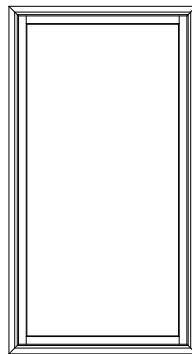

CCEC4484

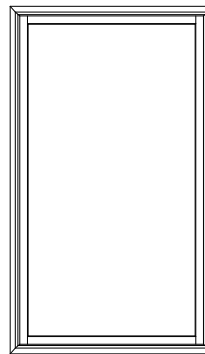

CCEC4884

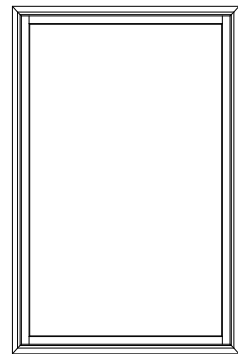

CCEC5484

ELEVATION SYMBOL LEGEND:

M.O. = MASONRY OPENING
VALUES IN () ARE IN MILLIMETER CONVERSIONS.

NUMBER INDICATES DESIGN PRESSURE (DP) RATING WITH STANDARD GLAZING.

E UNIT MEETS EGRESS REQUIREMENTS FOR IRC CODE. STATE AND LOCAL EGRESS CODES MAY DIFFER. ALWAYS REFER TO LOCAL BUILDING CODES FOR COMPLETE REQUIREMENTS.
CHECK WITH LOCAL OFFICIALS TO ENSURE COMPLIANCE BEFORE INSTALLING THE UNIT.

Note: Elevations shown DO NOT have exterior trim. Subtract 3/4" (19) from M.O. (Masonry Opening) for Unit Sizes. Masonry Openings above include Sill Nose, see Trim Options page for Sill Nose specifications. For other Trim Options refer to the Unit Sizing, Rough Opening & Masonry Openings page.

SCALE: 1/4" = 1'

1-WIDE UNITS

M.O. BRICKMOULD
M.O. ADAMS/FLAT CASING
ROUGH OPENING
FRAME SIZE
DAYLIGHT OPENING

42 3/4" (1086)
 45 13/16" (1164)
 40 3/4" (1035)
 40" (1016)
 33 7/8" (860)

44 3/4" (1137)
 47 13/16" (1214)
 42 3/4" (1086)
 42" (1067)
 35 7/8" (911)

46 3/4" (1187)
 49 13/16" (1265)
 44 3/4" (1137)
 44" (1118)
 37 7/8" (962)

50 3/4" (1289)
 53 13/16" (1367)
 48 3/4" (1238)
 48" (1219)
 41 7/8" (1064)

56 3/4" (1441)
 59 13/16" (1519)
 54 3/4" (1391)
 54" (1372)
 47 7/8" (1216)

92 1/2" (2350)
 94" (2388)
 90 3/4" (2305)
 90" (2286)
 83 7/8" (2130)

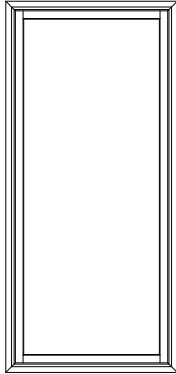

CCEC4090

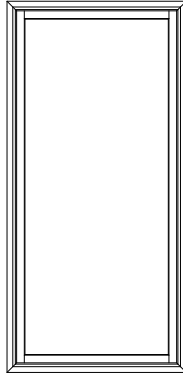

CCEC4290

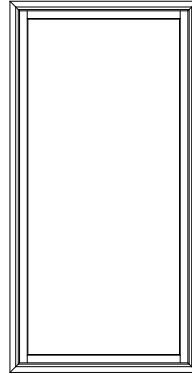

CCEC4490

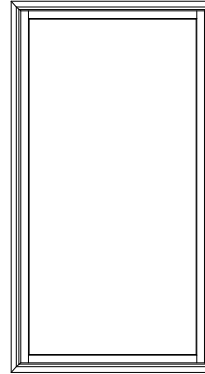

CCEC4890

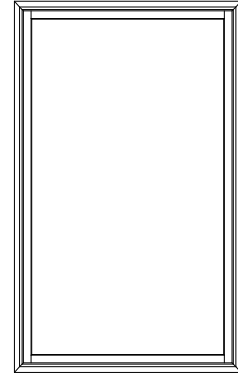

CCEC5490

98 1/2" (2502)
 100" (2540)
 96 3/4" (2457)
 96" (2438)
 89 7/8" (2283)

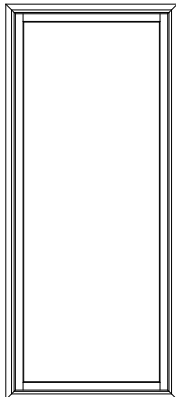

CCEC4096

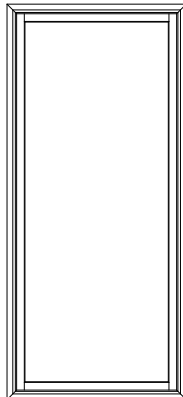

CCEC4296

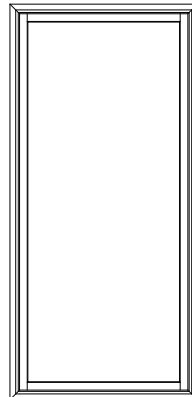

CCEC4496

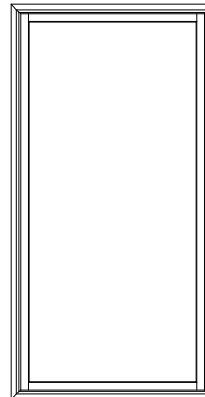

CCEC4896

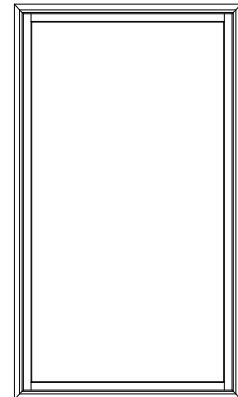

CCEC5496

104 1/2" (2654)
 106" (2692)
 102 3/4" (2610)
 102" (2591)
 95 7/8" (2435)

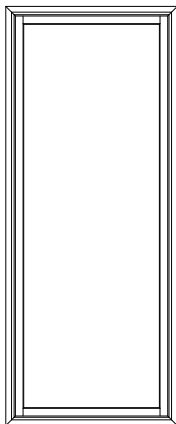

CCEC40102

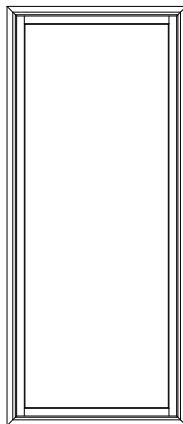

CCEC42102

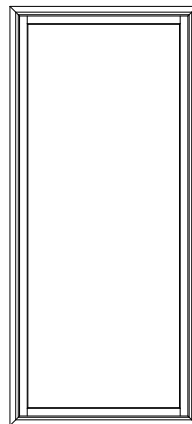

CCEC44102

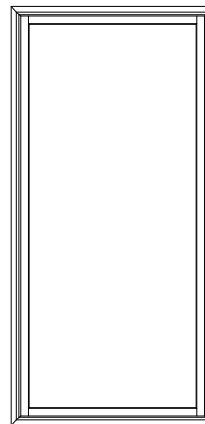

CCEC48102

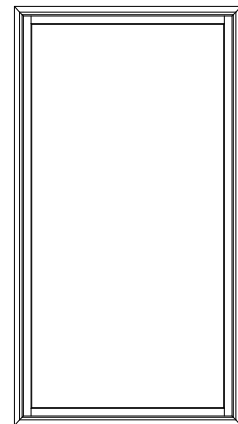

CCEC54102

ELEVATION SYMBOL LEGEND:

M.O. = MASONRY OPENING
 VALUES IN () ARE IN MILLIMETER CONVERSIONS.

NUMBER INDICATES DESIGN PRESSURE (DP) RATING WITH STANDARD GLAZING.

E UNIT MEETS EGRESS REQUIREMENTS FOR IRC CODE. STATE AND LOCAL EGRESS CODES MAY DIFFER. ALWAYS REFER TO LOCAL BUILDING CODES FOR COMPLETE REQUIREMENTS. CHECK WITH LOCAL OFFICIALS TO ENSURE COMPLIANCE BEFORE INSTALLING THE UNIT.

Note: Elevations shown DO NOT have exterior trim. Subtract 3/4" (19) from M.O. (Masonry Opening) for Unit Sizes. Masonry Openings above include Sill Nose, see Trim Options page for Sill Nose specifications. For other Trim Options refer to the Unit Sizing, Rough Opening & Masonry Openings page.

SCALE: 1/4" = 1'

1-WIDE UNITS

M.O. BRICKMOLD	42 3/4"(1086)	44 3/4"(1137)	46 3/4"(1187)	50 3/4"(1289)	56 3/4"(1441)
M.O. ADAMS/FLAT CASING	45 13/16"(1164)	47 13/16"(1214)	49 13/16"(1265)	53 13/16"(1367)	59 13/16"(1519)
ROUGH OPENING	40 3/4"(1035)	42 3/4"(1086)	44 3/4"(1137)	48 3/4"(1238)	54 3/4"(1391)
FRAME SIZE	40"(1016)	42"(1067)	44"(1118)	48"(1219)	54"(1372)
DAYLIGHT OPENING	33 7/8"(860)	35 7/8"(911)	37 7/8"(962)	41 7/8"(1064)	47 7/8"(1216)

110 1/2"(2807)
112"(2849)
108 3/4"(2762)
108"(2743)
101 7/8"(2588)

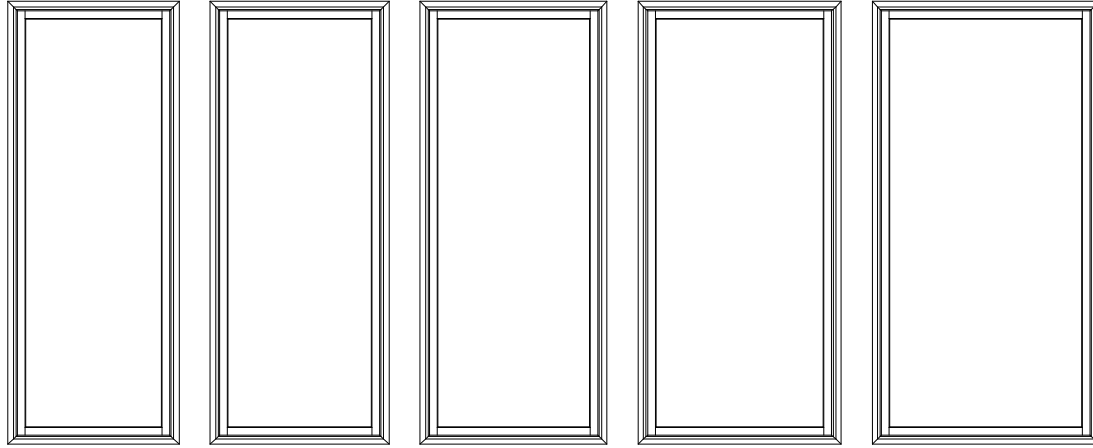

CCEC40108

CCEC42108

CCEC44108

CCEC48108

CCEC54108

ELEVATION SYMBOL LEGEND:

M.O. = MASONRY OPENING

VALUES IN () ARE IN MILLIMETER CONVERSIONS.

NUMBER INDICATES DESIGN PRESSURE (DP) RATING WITH STANDARD GLAZING.

E UNIT MEETS EGRESS REQUIREMENTS FOR IRC CODE. STATE AND LOCAL EGRESS CODES MAY DIFFER. ALWAYS REFER TO LOCAL BUILDING CODES FOR COMPLETE REQUIREMENTS. CHECK WITH LOCAL OFFICIALS TO ENSURE COMPLIANCE BEFORE INSTALLING THE UNIT.

Note: Elevations shown DO NOT have exterior trim. Subtract 3/4" (19) from M.O. (Masonry Opening) for Unit Sizes. Masonry Openings above include Sill Nose, see Trim Options page for Sill Nose specifications. For other Trim Options refer to the Unit Sizing, Rough Opening & Masonry Openings page.

SCALE: 1/4" = 1'

1-WIDE UNITS

**M.O. BRICKMOULD
M.O. ADAMS/FLAT CASING
ROUGH OPENING
FRAME SIZE
DAYLIGHT OPENING**

58 3/4"(1492)
61 13/16"(1570)
56 3/4"(1441)
56"(1422)
49 7/8"(1267)

62 3/4"(1594)
65 13/16"(1672)
60 3/4"(1543)
60"(1524)
53 7/8"(1368)

16 1/2"(419)
18"(457)
14 3/4"(375)
14"(356)
7 7/8"(200)



CCEC5614



CCEC6014

20 1/2"(521)
22"(559)
18 3/4"(476)
18"(457)
11 7/8"(302)

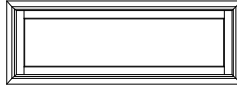

CCEC5618

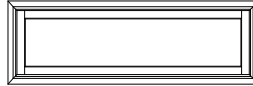

CCEC6018

22 1/2"(572)
24"(610)
20 3/4"(527)
20"(488)
13 7/8"(352)

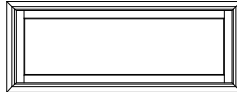

CCEC5620

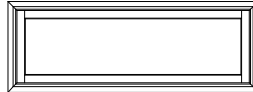

CCEC6020

26 1/2"(673)
28"(711)
24 3/4"(629)
24"(610)
17 7/8"(454)

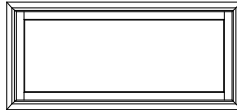

CCEC5624

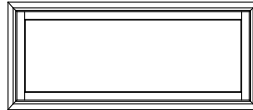

CCEC6024

30 1/2"(775)
32"(813)
28 3/4"(730)
28"(711)
21 7/8"(556)

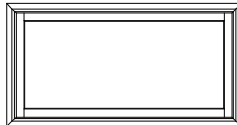

CCEC5628

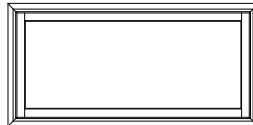

CCEC6028

32 1/2"(826)
34"(854)
30 3/4"(781)
30"(762)
23 7/8"(607)

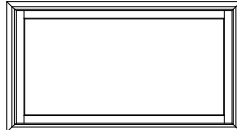

CCEC5630

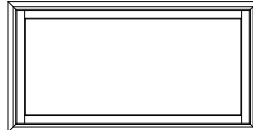

CCEC6030

34 1/2"(876)
35"(914)
32 3/4"(832)
32"(813)
25 7/8"(657)

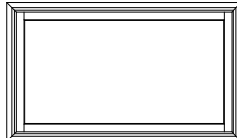

CCEC5632

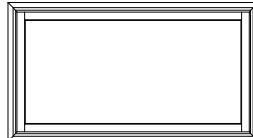

CCEC6032

38 1/2"(978)
40"(1016)
35 3/4"(933)
35"(914)
29 7/8"(759)

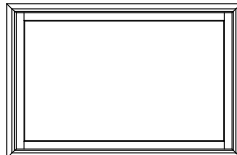

CCEC5636

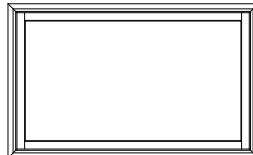

CCEC6036

42 1/2"(1080)
44"(1118)
40 3/4"(1035)
40"(1016)
33 7/8"(860)

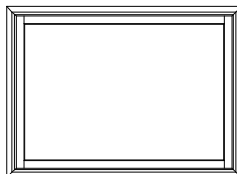

CCEC5640

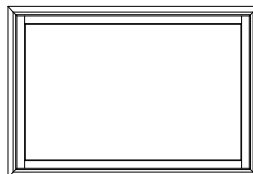

CCEC6040

ELEVATION SYMBOL LEGEND:

M.O. = MASONRY OPENING
VALUES IN () ARE IN MILLIMETER CONVERSIONS.

NUMBER INDICATES DESIGN PRESSURE (DP) RATING WITH STANDARD GLAZING.

E UNIT MEETS EGRESS REQUIREMENTS FOR IRC CODE. STATE AND LOCAL EGRESS CODES MAY DIFFER. ALWAYS REFER TO LOCAL BUILDING CODES FOR COMPLETE REQUIREMENTS. CHECK WITH LOCAL OFFICIALS TO ENSURE COMPLIANCE BEFORE INSTALLING THE UNIT.

Note: Elevations shown DO NOT have exterior trim. Subtract 3/4" (19) from M.O. (Masonry Opening) for Unit Sizes. Masonry Openings above include Sill Nose, see Trim Options page for Sill Nose specifications. For other Trim Options refer to the Unit Sizing, Rough Opening & Masonry Openings page.

SCALE: 1/4" = 1'

1-WIDE UNITS

M.O. BRICKMOULD
M.O. ADAMS/FLAT CASING
ROUGH OPENING
FRAME SIZE
DAYLIGHT OPENING

58 3/4" (1492)
61 13/16" (1570)
56 3/4" (1441)
56" (1422)
49 7/8" (1267)

62 3/4" (1594)
65 13/16" (1672)
60 3/4" (1543)
60" (1524)
53 7/8" (1368)

44 1/2" (1130)
46" (1168)
42 3/4" (1086)
42" (1067)
35 7/8" (911)

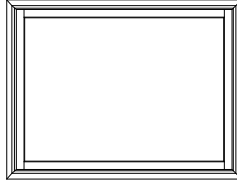

CCEC5642

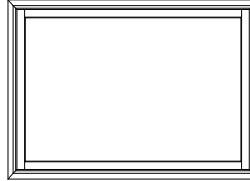

CCEC6042

50 1/2" (1283)
52" (1321)
48 3/4" (1238)
48" (1219)
41 7/8" (1064)

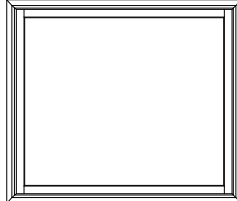

CCEC5648

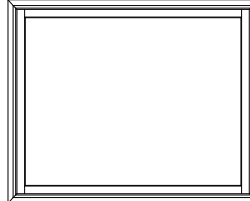

CCEC6048

56 1/2" (1435)
58" (1473)
54 3/4" (1391)
54" (1372)
47 7/8" (1216)

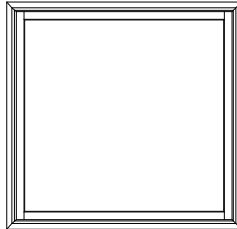

CCEC5654

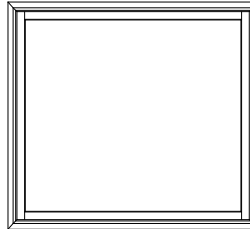

CCEC6054

58 1/2" (1486)
60" (1524)
56 3/4" (1441)
56" (1422)
49 7/8" (1267)

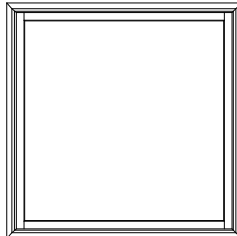

CCEC5656

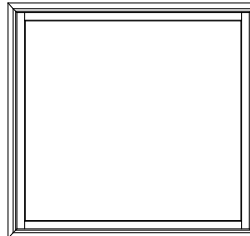

CCEC6056

62 1/2" (1588)
64" (1626)
60 3/4" (1543)
60" (1524)
53 7/8" (1368)

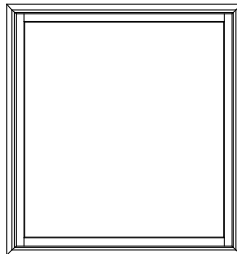

CCEC5660

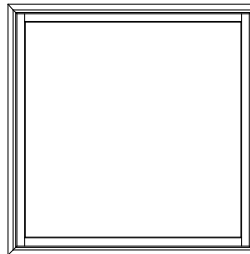

CCEC6060

66 1/2" (1689)
68" (1727)
64 3/4" (1645)
64" (1626)
57 7/8" (1470)

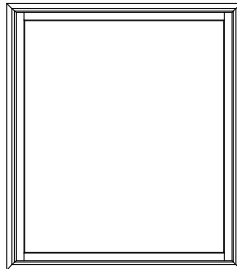

CCEC5664

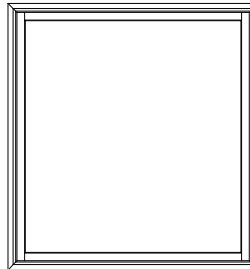

CCEC6064

ELEVATION SYMBOL LEGEND:

M.O. = MASONRY OPENING
VALUES IN () ARE IN MILLIMETER CONVERSIONS.

NUMBER INDICATES DESIGN PRESSURE (DP) RATING WITH STANDARD GLAZING.

E UNIT MEETS EGRESS REQUIREMENTS FOR IRC CODE. STATE AND LOCAL EGRESS CODES MAY DIFFER. ALWAYS REFER TO LOCAL BUILDING CODES FOR COMPLETE REQUIREMENTS.
CHECK WITH LOCAL OFFICIALS TO ENSURE COMPLIANCE BEFORE INSTALLING THE UNIT.

Note: Elevations shown DO NOT have exterior trim. Subtract 3/4" (19) from M.O. (Masonry Opening) for Unit Sizes. Masonry Openings above include Sill Nose, see Trim Options page for Sill Nose specifications. For other Trim Options refer to the Unit Sizing, Rough Opening & Masonry Openings page.

SCALE: 1/4" = 1'

1-WIDE UNITS

M.O. BRICKMOULD
M.O. ADAMS/FLAT CASING
ROUGH OPENING
FRAME SIZE
DAYLIGHT OPENING

58 3/4"(1492)
61 13/16"(1570)
56 3/4"(1441)
56"(1422)
49 7/8"(1267)

62 3/4"(1594)
65 13/16"(1672)
60 3/4"(1543)
60"(1524)
53 7/8"(1368)

68 1/2"(1740)
70"(1778)
66 3/4"(1695)
66"(1676)
59 7/8"(1581)

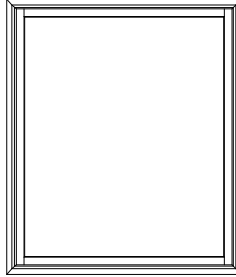

CCEC5666

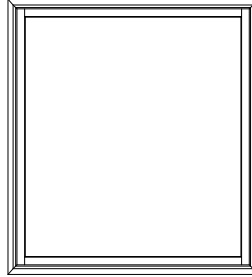

CCEC6066

74 1/2"(1892)
76"(1920)
72 3/4"(1848)
72"(1829)
65 7/8"(1673)

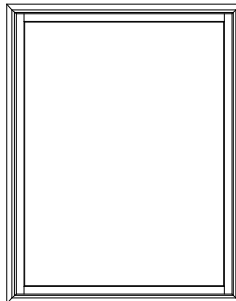

CCEC5672

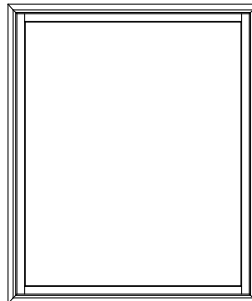

CCEC6072

80 1/2"(2045)
82"(2083)
78 3/4"(2000)
78"(1981)
71 7/8"(1826)

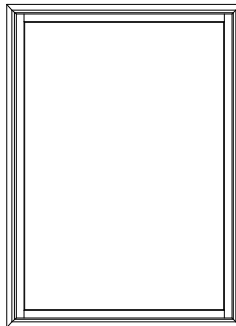

CCEC5678

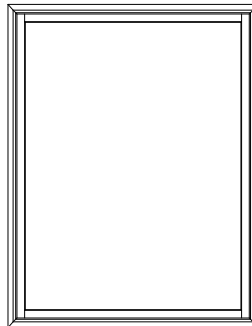

CCEC6078

86 1/2"(2197)
88"(2235)
84 3/4"(2153)
84"(2134)
77 7/8"(1978)

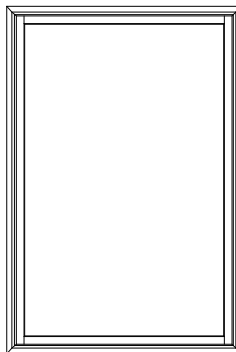

CCEC5684

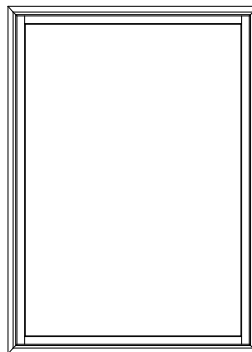

CCEC6084

ELEVATION SYMBOL LEGEND:

M.O. = MASONRY OPENING
VALUES IN () ARE IN MILLIMETER CONVERSIONS.

NUMBER INDICATES DESIGN PRESSURE (DP) RATING WITH STANDARD GLAZING.

E UNIT MEETS EGRESS REQUIREMENTS FOR IRC CODE. STATE AND LOCAL EGRESS CODES MAY DIFFER. ALWAYS REFER TO LOCAL BUILDING CODES FOR COMPLETE REQUIREMENTS.
CHECK WITH LOCAL OFFICIALS TO ENSURE COMPLIANCE BEFORE INSTALLING THE UNIT.

Note: Elevations shown DO NOT have exterior trim. Subtract 3/4" (19) from M.O. (Masonry Opening) for Unit Sizes. Masonry Openings above include Sill Nose, see Trim Options page for Sill Nose specifications. For other Trim Options refer to the Unit Sizing, Rough Opening & Masonry Openings page.

SCALE: 1/4" = 1'

1-WIDE UNITS

M.O. BRICKMOULD
M.O. ADAMS/FLAT CASING
ROUGH OPENING
FRAME SIZE
DAYLIGHT OPENING

58 3/4"(1492)
61 13/16"(1570)
56 3/4"(1441)
56"(1422)
49 7/8"(1267)

62 3/4"(1594)
65 13/16"(1672)
60 3/4"(1543)
60"(1524)
53 7/8"(1368)

92 1/2"(2350)
94"(2388)
90 3/4"(2305)
90"(2286)
83 7/8"(2130)

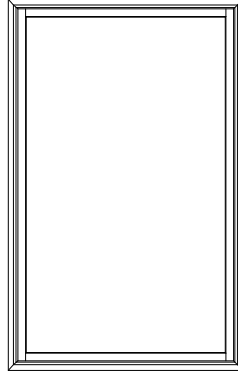

CCEC5690

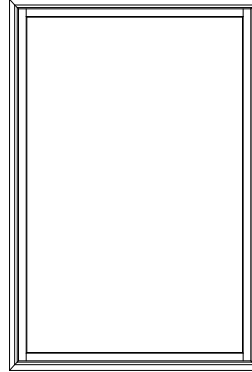

CCEC6090

98 1/2"(2502)
100"(2540)
96 3/4"(2457)
96"(2438)
89 7/8"(2283)

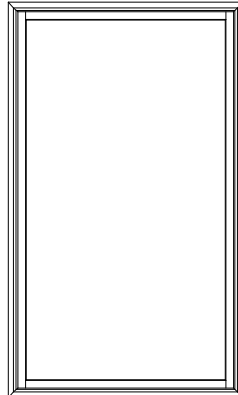

CCEC5696

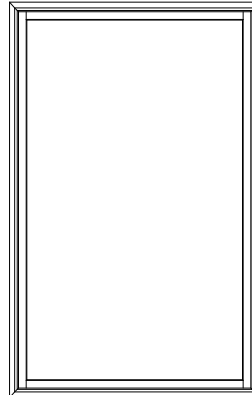

CCEC6096

104 1/2"(2654)
106"(2692)
102 3/4"(2610)
102"(2591)
95 7/8"(2435)

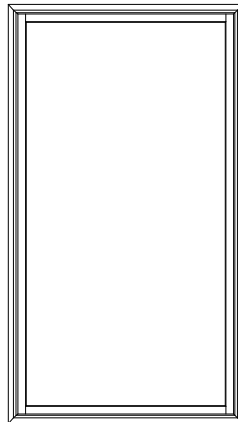

CCEC56102

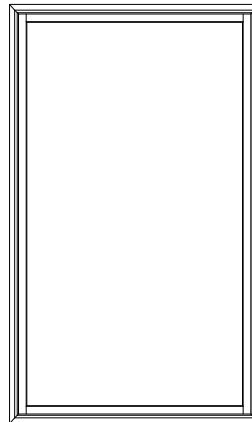

CCEC60102

ELEVATION SYMBOL LEGEND:

M.O. = MASONRY OPENING
VALUES IN () ARE IN MILLIMETER CONVERSIONS.

NUMBER INDICATES DESIGN PRESSURE (DP) RATING WITH STANDARD GLAZING.

E UNIT MEETS EGRESS REQUIREMENTS FOR IRC CODE. STATE AND LOCAL EGRESS CODES MAY DIFFER. ALWAYS REFER TO LOCAL BUILDING CODES FOR COMPLETE REQUIREMENTS.
CHECK WITH LOCAL OFFICIALS TO ENSURE COMPLIANCE BEFORE INSTALLING THE UNIT.

Note: Elevations shown DO NOT have exterior trim. Subtract 3/4" (19) from M.O. (Masonry Opening) for Unit Sizes. Masonry Openings above include Sill Nose, see Trim Options page for Sill Nose specifications. For other Trim Options refer to the Unit Sizing, Rough Opening & Masonry Openings page.

SCALE: 1/4" = 1'

1-WIDE UNITS

M.O. BRICKMOULD
M.O. ADAMS/FLAT CASING
ROUGH OPENING
FRAME SIZE
DAYLIGHT OPENING

58 3/4"(1492)
61 13/16"(1570)
56 3/4"(1441)
56"(1422)
49 7/8"(1267)

62 3/4"(1594)
65 13/16"(1672)
60 3/4"(1543)
60"(1524)
53 7/8"(1368)

110 1/2"(2807)
112"(2849)
108 3/4"(2762)
108"(2743)
101 7/8"(2588)

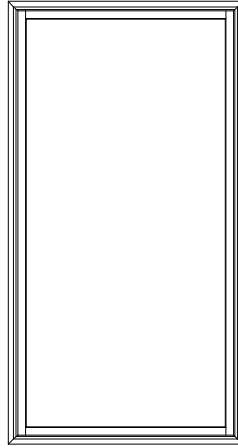

CCEC56108

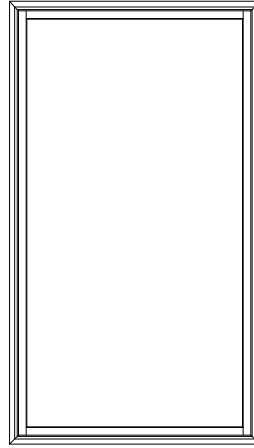

CCEC60108

ELEVATION SYMBOL LEGEND:

M.O. = MASONRY OPENING
VALUES IN () ARE IN MILLIMETER CONVERSIONS.

##* NUMBER INDICATES DESIGN PRESSURE (DP) RATING WITH STANDARD GLAZING.

E UNIT MEETS EGRESS REQUIREMENTS FOR IRC CODE. STATE AND LOCAL EGRESS CODES MAY DIFFER. ALWAYS REFER TO LOCAL BUILDING CODES FOR COMPLETE REQUIREMENTS.
CHECK WITH LOCAL OFFICIALS TO ENSURE COMPLIANCE BEFORE INSTALLING THE UNIT.

Note: Elevations shown DO NOT have exterior trim. Subtract 3/4" (19) from M.O. (Masonry Opening) for Unit Sizes. Masonry Openings above include Sill Nose, see Trim Options page for Sill Nose specifications. For other Trim Options refer to the Unit Sizing, Rough Opening & Masonry Openings page.

SCALE: 1/4" = 1'

GENERAL INFORMATION
STATIONARY

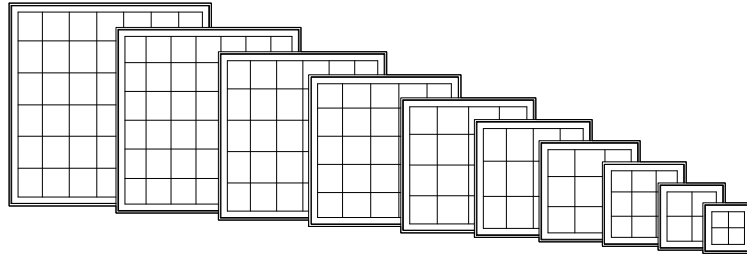

DIMENSIONAL WINDOWS

Clad Epic stationary casement windows may be specified as "dimensional", by adjusting the desired rough opening width or height in 1/4" increments from standard.

MULTIPLE ASSEMBLIES

Clad Epic stationary casement windows may be mullied above, below, or beside other clad casement windows, or other clad window products. Factory assembled mulls are limited in height (100"), width (150"), and a total area (75 square feet).

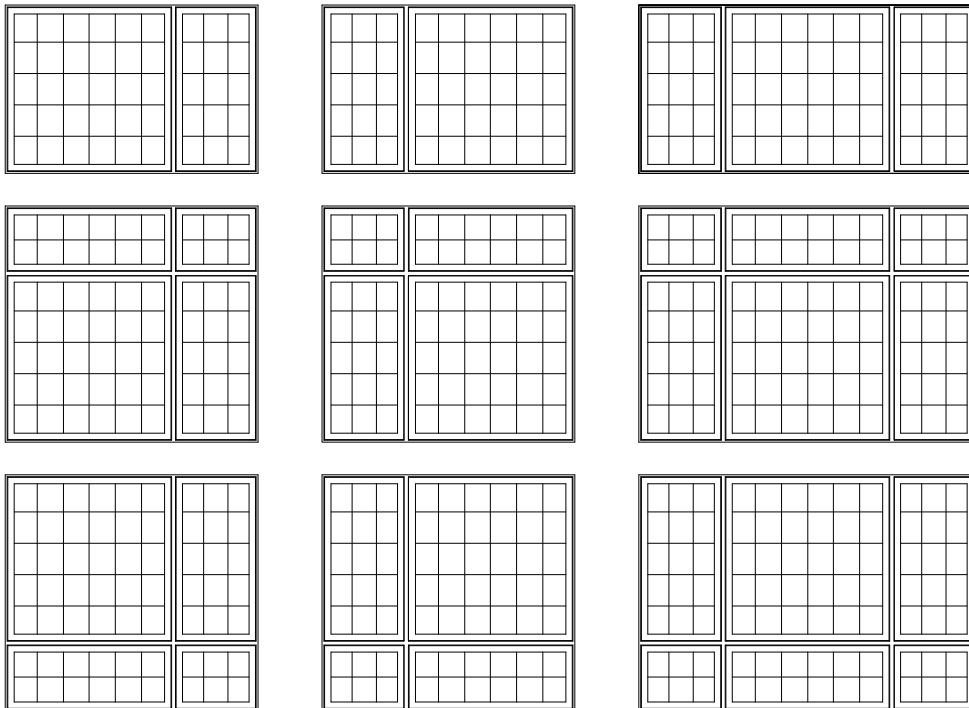

ELEVATION NOTES
STATIONARY

ELEVATION DRAWINGS UTILIZE A LIMITED NUMBER OF PROJECTED LINES TO PRODUCE A RUDIMENTARY DRAWING INTENDED TO BE USED IN A SMALL GRAPHICAL SCALE. ELEVATIONS ARE VIEWED PERPENDICULAR FROM THE EXTERIOR OF THE STRUCTURE. IF MORE DIMENSIONS ARE NEEDED, USE THE SECTION DRAWINGS FOR MORE COMPLETE DEPICTIONS.

M.O. Brickmould	56 3/4"(1441)	Masonry Openings for Brickmould, Flat & Adams Casing. Vertical measurements include sillnose. (Subtract 1/2" from Masonry Opening for Unit Size)
M.O. Adams/Flat Casing	59 13/16"(1519)	
Rough Opening	54 3/4"(1391)	
Frame Size	54"(1372)	
Daylight Opening	47 7/8"(1216)	

20 1/2"(521)
22"(559)
18 3/4"(476)
18"(457)
11 7/8"(302)

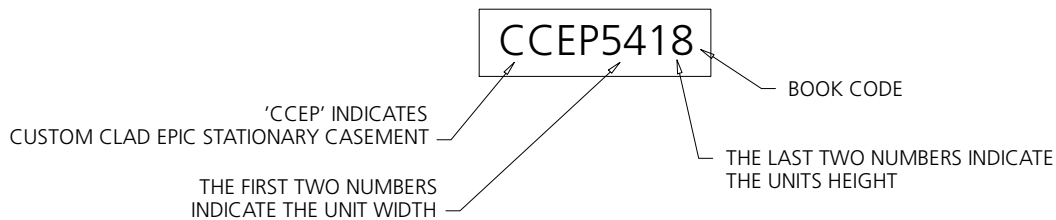
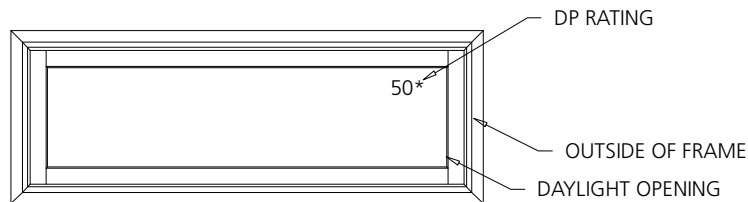

GENERAL CLAD EPIC CASEMENT NOTES:

1. CLAD EPIC CASEMENT (CCEC) UNITS ARE AVAILABLE AS OPERATING OR FIXED UNITS.
2. 'CCEP' IN A BOOD CODE DENOTES THE UNIT IS A CLAD EPIC CASEMENT PICTURE (FIXED) UNIT.
3. UNIT ELEVATIONS ARE SHOWN WITHOUT EXTERIOR TRIM. UNIT SIZES & MASONRY OPENING DIMENSIONS WILL CHANGE WITH THE ADDITION OF EXTERIOR TRIM. SEE THE 'UNIT SIZING, ROUGH OPENINGS & MASONRY OPENINGS' PAGE FOR EXTERIOR TRIM EFFECTS.
4. OPERATING UNITS ARE AVAILABLE AS LEFT OR RIGHT HAND OPERATION.
5. DIMENSIONAL VALUES IN () ARE MILLIMETER CONVERSIONS.

ELEVATION SYMBOL LEGEND:

##* NUMBER INDICATES DESIGN PRESSURE (DP) RATING WITH STANDARD GLAZING. OPERATING UNITS UTILIZE A CONCEALED LOCKING SYSTEM FOR DP RATINGS.

PICTURE UNITS

M.O. BRICKMOULD
M.O. ADAMS/FLAT CASING
ROUGH OPENING
FRAME SIZE
DAYLIGHT OPENING

56 3/4" (1441)
59 13/16" (1519)
54 3/4" (1391)
54" (1372)
47 7/8" (1216)

58 3/4" (1492)
61 13/16" (1570)
56 3/4" (1441)
56" (1422)
49 7/8" (1267)

62 3/4" (1594)
65 13/16" (1672)
60 3/4" (1543)
60" (1524)
53 7/8" (1368)

66 3/4" (1695)
69 13/16" (1773)
64 3/4" (1645)
64" (1626)
57 7/8" (1470)

16 1/2" (419)
16 7/8" (427)
17 1/4" (441)
14 3/4" (375)
14" (356)
7 7/8" (200)

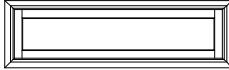

CCEP5414

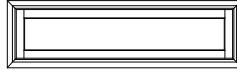

CCEP5614

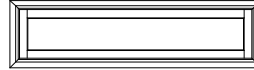

CCEP6014

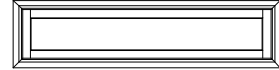

CCEP6414

20 1/2" (521)
20 7/8" (530)
21 1/4" (544)
18 3/4" (476)
18" (457)
11 7/8" (302)

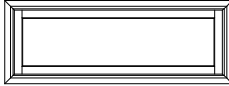

CCEP5418

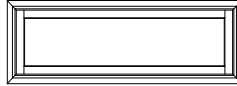

CCEP5618

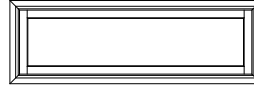

CCEP6018

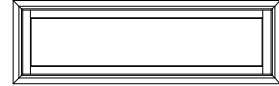

CCEP6418

22 1/2" (572)
22 7/8" (581)
23 1/4" (595)
20 3/4" (527)
20" (508)
13 7/8" (352)

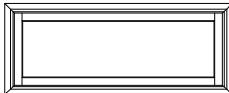

CCEP5420

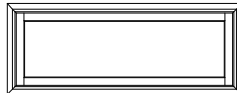

CCEP5620

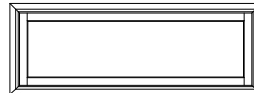

CCEP6020

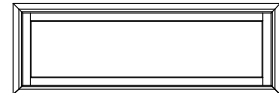

CCEP6420

26 1/2" (673)
26 7/8" (682)
27 1/4" (696)
24 3/4" (629)
24" (610)
17 7/8" (454)

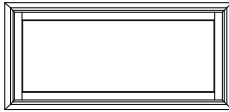

CCEP5424

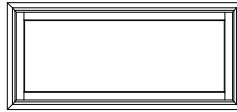

CCEP5624

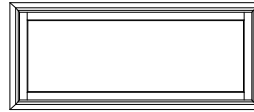

CCEP6024

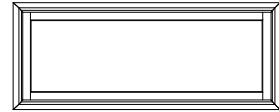

CCEP6424

30 1/2" (775)
30 7/8" (784)
31 1/4" (798)
28 3/4" (730)
28" (711)
21 7/8" (556)



CCEP5428



CCEP5628



CCEP6028



CCEP6428

32 1/2" (826)
32 7/8" (835)
33 1/4" (849)
30 3/4" (781)
30" (762)
23 7/8" (607)

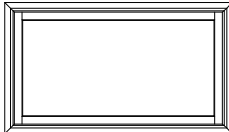

CCEP5430

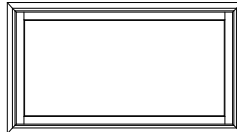

CCEP5630

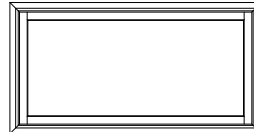

CCEP6030

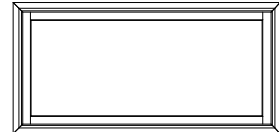

CCEP6430

34 1/2" (876)
34 7/8" (885)
35 1/4" (899)
32 3/4" (832)
32" (813)
25 7/8" (657)

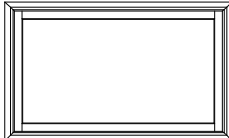

CCEP5432

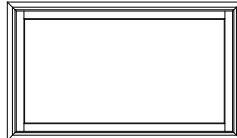

CCEP5632

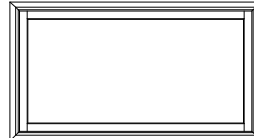

CCEP6032

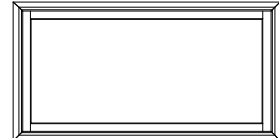

CCEP6432

38 1/2" (978)
38 7/8" (987)
39 1/4" (1001)
36 3/4" (933)
36" (914)
29 7/8" (759)

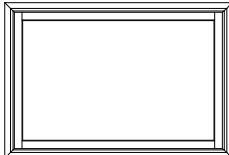

CCEP5436

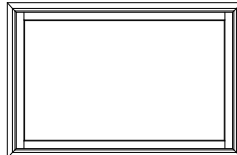

CCEP5636

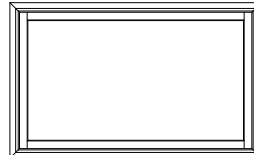

CCEP6036

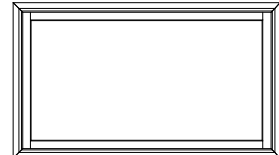

CCEP6436

42 1/2" (1080)
42 7/8" (1089)
43 1/4" (1103)
40 3/4" (1035)
40" (1016)
33 7/8" (860)

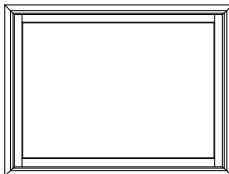

CCEP5440

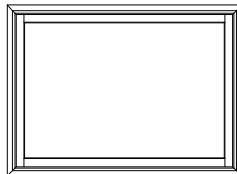

CCEP5640

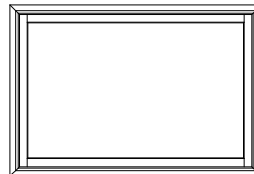

CCEP6040

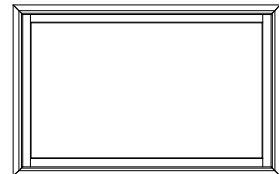

CCEP6440

ELEVATION SYMBOL LEGEND:
M.O. = MASONRY OPENING
VALUES IN () ARE IN MILLIMETER CONVERSIONS.
NUMBER INDICATES DESIGN PRESSURE (DP) RATING WITH STANDARD GLAZING.

Note: Elevations shown DO NOT have exterior trim. Subtract 3/4" (19) from M.O. (Masonry Opening) for Unit Sizes. Masonry Openings above include Sill Nose, see Trim Options page for Sill Nose specifications. For other Trim Options refer to the Unit Sizing, Rough Opening & Masonry Openings page.

SCALE: 1/4" = 1'

PICTURE UNITS

M.O. BRICKMOULD
M.O. ADAMS/FLAT CASING
ROUGH OPENING
FRAME SIZE
DAYLIGHT OPENING

56 3/4" (1441)
59 13/16" (1519)
54 3/4" (1391)
54" (1372)
47 7/8" (1216)

58 3/4" (1492)
61 13/16" (1570)
56 3/4" (1441)
56" (1422)
49 7/8" (1267)

62 3/4" (1594)
65 13/16" (1672)
60 3/4" (1543)
60" (1524)
53 7/8" (1368)

66 3/4" (1695)
69 13/16" (1773)
64 3/4" (1645)
64" (1626)
57 7/8" (1470)

44 1/2" (1130)
45" (1143)
43 3/4" (1096)
42" (1063)
35 7/8" (911)

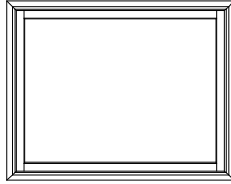

CCEP5442



CCEP5642



CCEP6042



CCEP6442

50 1/2" (1283)
52" (1328)
48 3/4" (1238)
48" (1219)
41 7/8" (1064)

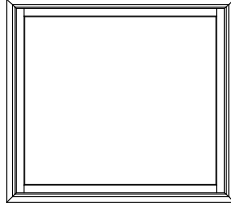

CCEP5448

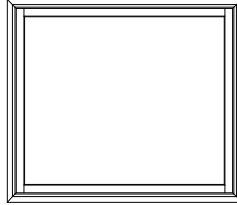

CCEP5648

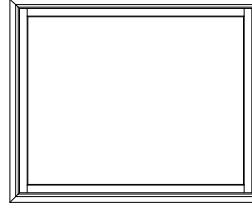

CCEP6048

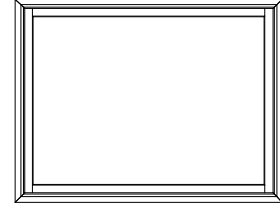

CCEP6448

56 1/2" (1435)
58" (1473)
54 3/4" (1391)
54" (1372)
47 7/8" (1216)

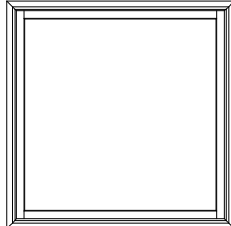

CCEP5454

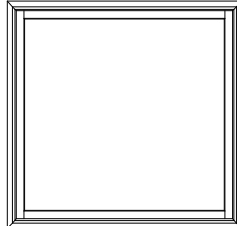

CCEP5654

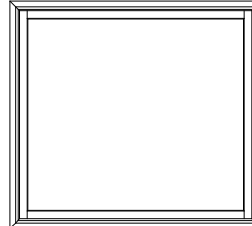

CCEP6054

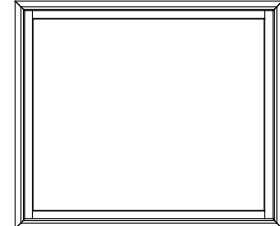

CCEP6454

58 1/2" (1486)
60" (1524)
56 3/4" (1441)
56" (1422)
49 7/8" (1267)

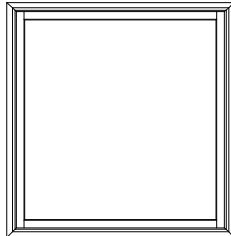

CCEP5456

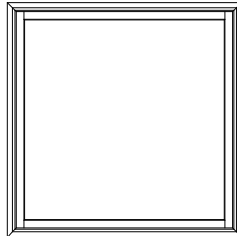

CCEP5656

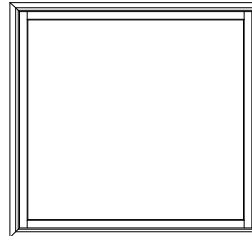

CCEP6056

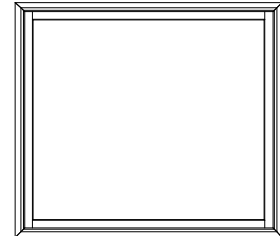

CCEP6456

62 1/2" (1588)
64" (1626)
60 3/4" (1543)
60" (1524)
53 7/8" (1368)

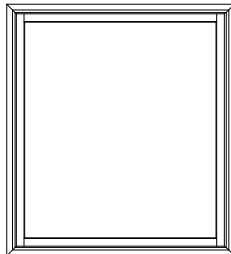

CCEP5460

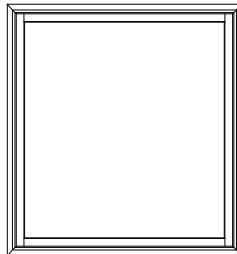

CCEP5660

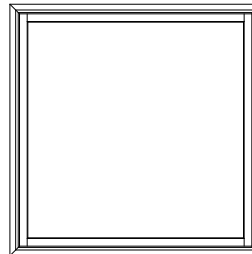

CCEP6060

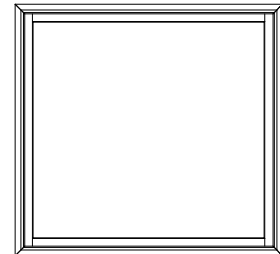

CCEP6460

66 1/2" (1689)
68" (1727)
64 3/4" (1645)
64" (1626)
57 7/8" (1470)

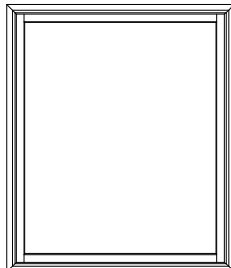

CCEP5464

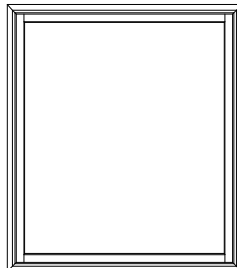

CCEP5664

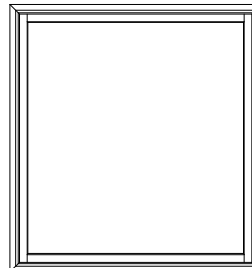

CCEP6064

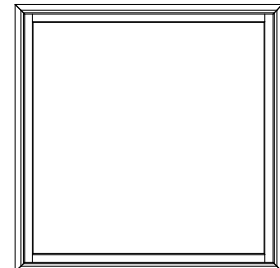

CCEP6464

ELEVATION SYMBOL LEGEND:

M.O. = MASONRY OPENING
VALUES IN () ARE IN MILLIMETER CONVERSIONS.

##* NUMBER INDICATES DESIGN PRESSURE (DP) RATING WITH STANDARD GLAZING.

Note: Elevations shown DO NOT have exterior trim. Subtract 3/4" (19) from M.O. (Masonry Opening) for Unit Sizes. Masonry Openings above include Sill Nose, see Trim Options page for Sill Nose specifications. For other Trim Options refer to the Unit Sizing, Rough Opening & Masonry Openings page.

SCALE: 1/4" = 1'

PICTURE UNITS

M.O. BRICKMOULD
M.O. ADAMS/FLAT CASING
ROUGH OPENING
FRAME SIZE
DAYLIGHT OPENING

56 3/4" (1441)
59 13/16" (1519)
54 3/4" (1391)
54" (1372)
47 7/8" (1216)

58 3/4" (1492)
61 13/16" (1570)
56 3/4" (1441)
56" (1422)
49 7/8" (1267)

62 3/4" (1594)
65 13/16" (1672)
60 3/4" (1543)
60" (1524)
53 7/8" (1368)

66 3/4" (1695)
69 13/16" (1773)
64 3/4" (1645)
64" (1626)
57 7/8" (1470)

68 1/2" (1740)
67 1/2" (1728)
66 3/4" (1695)
66" (1676)
59 7/8" (1581)

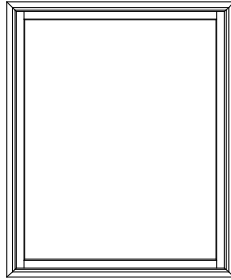

CCEP5466

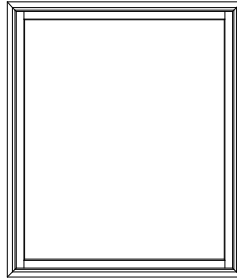

CCEP5666

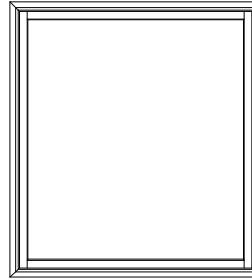

CCEP6066

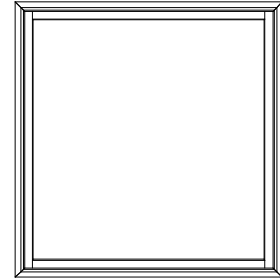

CCEP6466

74 1/2" (1892)
74" (1880)
72 3/4" (1868)
72" (1828)
65 7/8" (1673)

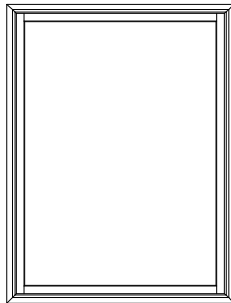

CCEP5472

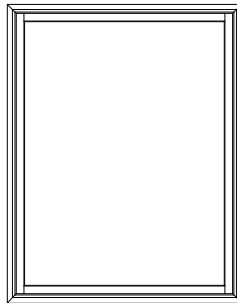

CCEP5672

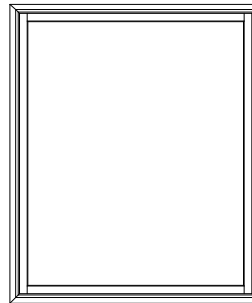

CCEP6072

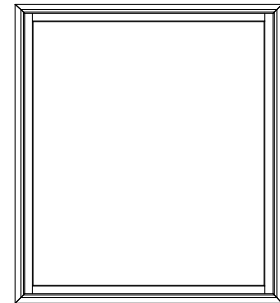

CCEP6472

80 1/2" (2045)
80" (2033)
78 3/4" (2000)
78" (1981)
71 7/8" (1826)

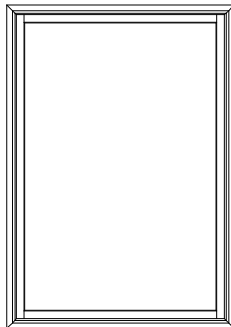

CCEP5478

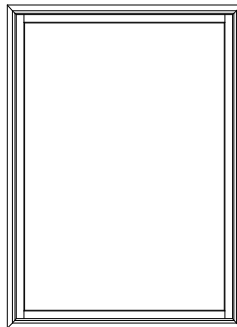

CCEP5678

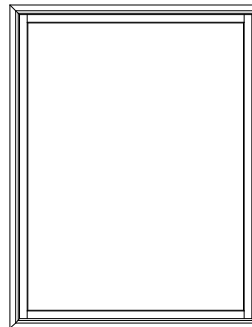

CCEP6078

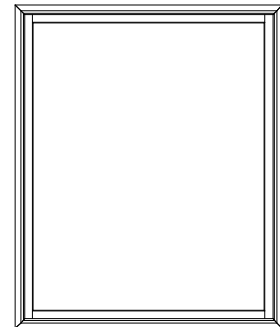

CCEP6478

86 1/2" (2197)
86" (2185)
84 3/4" (2153)
84" (2134)
77 7/8" (1978)

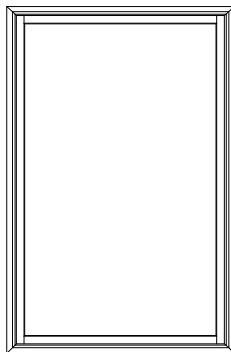

CCEP5484

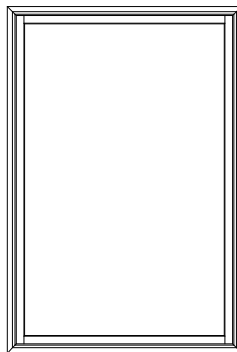

CCEP5684

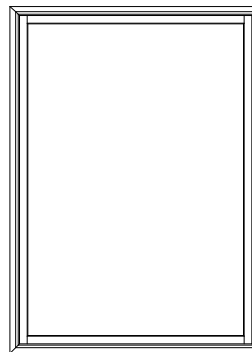

CCEP6084

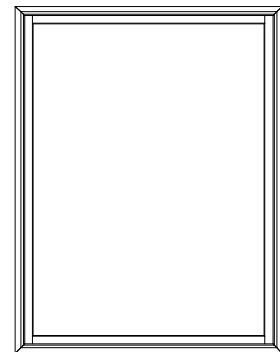

CCEP6484

ELEVATION SYMBOL LEGEND:

M.O. = MASONRY OPENING
VALUES IN () ARE IN MILLIMETER CONVERSIONS.
##* NUMBER INDICATES DESIGN PRESSURE (DP) RATING WITH STANDARD GLAZING.

Note: Elevations shown DO NOT have exterior trim. Subtract 3/4" (19) from M.O. (Masonry Opening) for Unit Sizes. Masonry Openings above include Sill Nose, see Trim Options page for Sill Nose specifications. For other Trim Options refer to the Unit Sizing, Rough Opening & Masonry Openings page.

SCALE: 1/4" = 1'

PICTURE UNITS

**M.O. BRICKMOUND
M.O. ADAMS/FLAT CASING
ROUGH OPENING
FRAME SIZE
DAYLIGHT OPENING**

56 3/4" (1441)
59 13/16" (1519)
54 3/4" (1391)
54" (1372)
47 7/8" (1216)

58 3/4" (1492)
61 13/16" (1570)
56 3/4" (1441)
56" (1422)
49 7/8" (1267)

62 3/4" (1594)
65 13/16" (1672)
60 3/4" (1543)
60" (1524)
53 7/8" (1368)

66 3/4" (1695)
69 13/16" (1773)
64 3/4" (1645)
64" (1626)
57 7/8" (1470)

92 1/2" (2350)
94" (2383)
90 3/4" (2305)
90" (2286)
83 7/8" (2130)

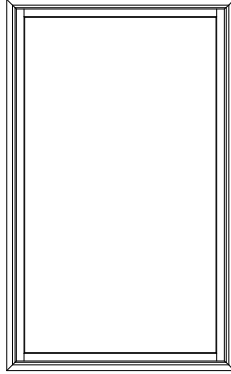

CCEP5490

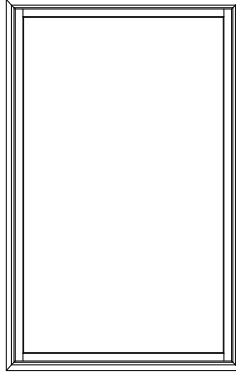

CCEP5690

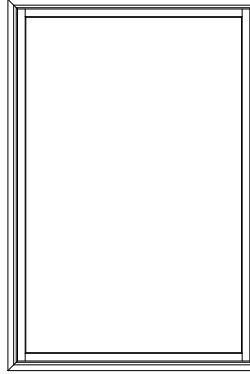

CCEP6090

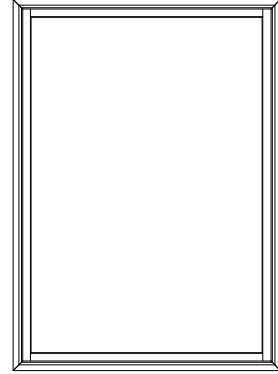

CCEP6490

98 1/2" (2502)
100" (2540)
95 3/4" (2437)
95" (2428)
89 7/8" (2283)

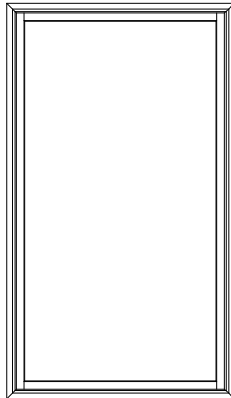

CCEP5496

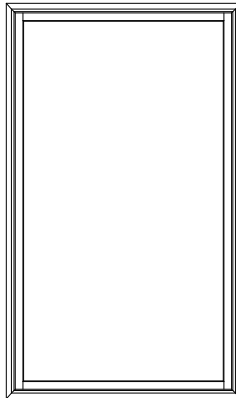

CCEP5696

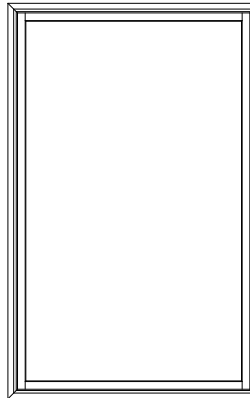

CCEP6096

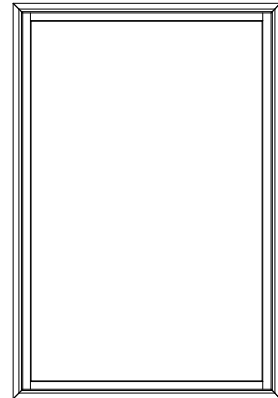

CCEP6496

104 1/2" (2654)
106" (2691)
102 3/4" (2610)
102" (2591)
95 7/8" (2435)

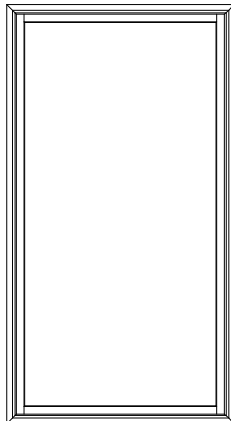

CCEP54102

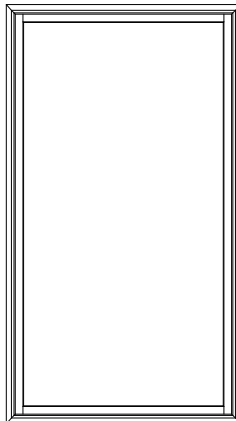

CCEP56102

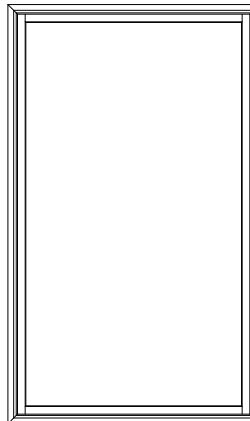

CCEP60102

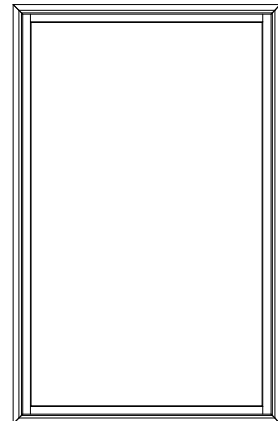

CCEP64102

ELEVATION SYMBOL LEGEND:

M.O. = MASONRY OPENING
VALUES IN () ARE IN MILLIMETER CONVERSIONS.

NUMBER INDICATES DESIGN PRESSURE (DP) RATING WITH STANDARD GLAZING.

Note: Elevations shown DO NOT have exterior trim. Subtract 3/4" (19) from M.O. (Masonry Opening) for Unit Sizes. Masonry Openings above include Sill Nose, see Trim Options page for Sill Nose specifications. For other Trim Options refer to the Unit Sizing, Rough Opening & Masonry Openings page.

SCALE: 1/4" = 1'

PICTURE UNITS

M.O. BRICKMOULD
M.O. ADAMS/FLAT CASING
ROUGH OPENING
FRAME SIZE
DAYLIGHT OPENING

56 3/4" (1441)
59 13/16" (1519)
54 3/4" (1391)
54" (1372)
47 7/8" (1216)

58 3/4" (1492)
61 13/16" (1570)
56 3/4" (1441)
56" (1422)
49 7/8" (1267)

62 3/4" (1594)
65 13/16" (1672)
60 3/4" (1543)
60" (1524)
53 7/8" (1368)

66 3/4" (1695)
69 13/16" (1773)
64 3/4" (1645)
64" (1626)
57 7/8" (1470)

110 1/2" (2807)
111 1/8" (2816)
108 3/4" (2762)
108" (2743)
101 7/8" (2588)

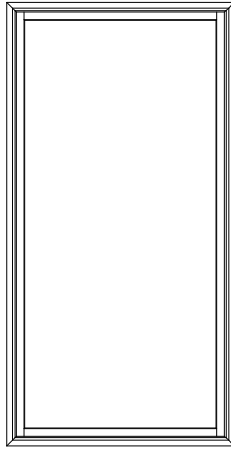

CCEP54108

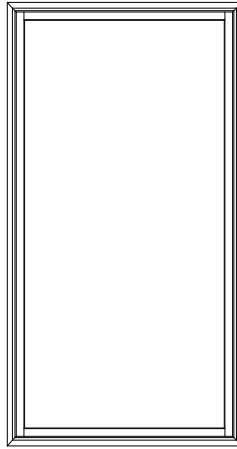

CCEP56108

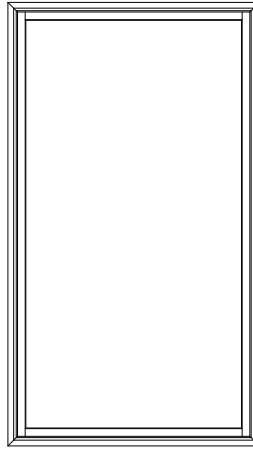

CCEP60108

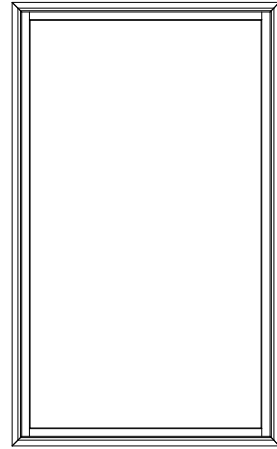

CCEP64108

ELEVATION SYMBOL LEGEND:

M.O. = MASONRY OPENING
VALUES IN () ARE IN MILLIMETER CONVERSIONS.

NUMBER INDICATES DESIGN PRESSURE (DP) RATING WITH STANDARD GLAZING.

Note: Elevations shown DO NOT have exterior trim. Subtract 3/4" (19) from M.O. (Masonry Opening) for Unit Sizes. Masonry Openings above include Sill Nose, see Trim Options page for Sill Nose specifications. For other Trim Options refer to the Unit Sizing, Rough Opening & Masonry Openings page.

SCALE: 1/4" = 1'

PICTURE UNITS

M.O. BRICKMOULD
M.O. ADAMS/FLAT CASING
ROUGH OPENING
FRAME SIZE
DAYLIGHT OPENING

68 3/4" (1746)
71 13/16" (1824)
66 3/4" (1695)
66" (1676)
59 7/8" (1581)

74 3/4" (1899)
77 13/16" (1976)
72 3/4" (1848)
72" (1829)
65 7/8" (1673)

80 3/4" (2051)
83 13/16" (2129)
78 3/4" (2000)
78" (1981)
71 7/8" (1826)

16 1/2" (419)
18" (457)
14 3/4" (375)
14" (356)
7 7/8" (200)



CCEP6614



CCEP7214



CCEP7814

20 1/2" (521)
22" (559)
18 3/4" (476)
18" (457)
11 7/8" (302)

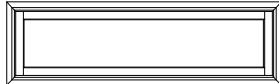

CCEP6618

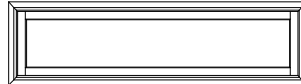

CCEP7218



CCEP7818

22 1/2" (572)
24" (610)
20 3/4" (527)
20" (508)
13 7/8" (352)

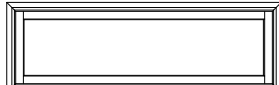

CCEP6620

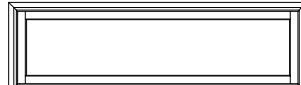

CCEP7220

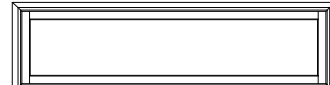

CCEP7820

26 1/2" (673)
28" (711)
24 3/4" (629)
24" (610)
17 7/8" (454)



CCEP6624



CCEP7224



CCEP7824

30 1/2" (775)
32" (813)
28 3/4" (730)
28" (711)
21 7/8" (556)



CCEP6628



CCEP7228



CCEP7828

32 1/2" (826)
34" (864)
30 3/4" (781)
30" (762)
23 7/8" (607)



CCEP6630



CCEP7230



CCEP7830

34 1/2" (876)
36" (914)
32 3/4" (832)
32" (813)
25 7/8" (657)



CCEP6632



CCEP7232



CCEP7832

38 1/2" (978)
40" (1016)
36 3/4" (933)
36" (914)
29 7/8" (759)



CCEP6636



CCEP7236



CCEP7836

42 1/2" (1080)
44" (1118)
40 3/4" (1035)
40" (1016)
33 7/8" (860)

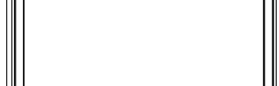

CCEP6640



CCEP7240



CCEP7840

ELEVATION SYMBOL LEGEND:

M.O. = MASONRY OPENING

VALUES IN () ARE IN MILLIMETER CONVERSIONS.

NUMBER INDICATES DESIGN PRESSURE (DP) RATING WITH STANDARD GLAZING.

Note: Elevations shown DO NOT have exterior trim. Subtract 3/4" (19) from M.O. (Masonry Opening) for Unit Sizes. Masonry Openings above include Sill Nose, see Trim Options page for Sill Nose specifications. For other Trim Options refer to the Unit Sizing, Rough Opening & Masonry Openings page.

SCALE: 1/4" = 1'

PICTURE UNITS

M.O. BRICKMOUND
M.O. ADAMS/FLAT CASING
ROUGH OPENING
FRAME SIZE
DAYLIGHT OPENING

68 3/4" (1746)
71 13/16" (1824)
66 3/4" (1695)
66" (1676)
59 7/8" (1581)

74 3/4" (1899)
77 13/16" (1976)
72 3/4" (1848)
72" (1829)
65 7/8" (1673)

80 3/4" (2051)
83 13/16" (2129)
78 3/4" (2000)
78" (1981)
71 7/8" (1826)

44 1/2" (1130)
46" (1168)
42 3/4" (1086)
42" (1067)
35 7/8" (911)

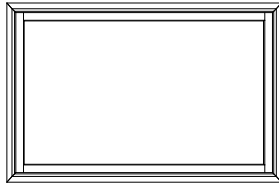

CCEP6642

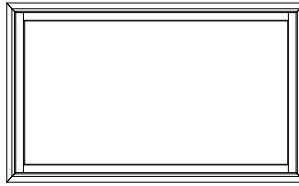

CCEP7242

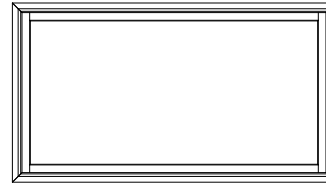

CCEP7842

50 1/2" (1283)
52" (1321)
48 3/4" (1238)
48" (1219)
41 7/8" (1064)

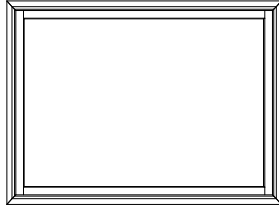

CCEP6648

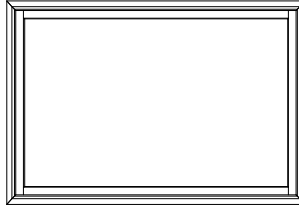

CCEP7248

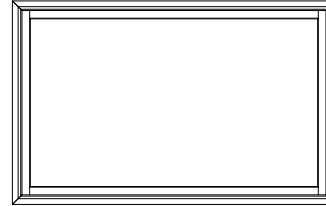

CCEP7848

56 1/2" (1435)
58" (1473)
54 3/4" (1391)
54" (1372)
47 7/8" (1216)

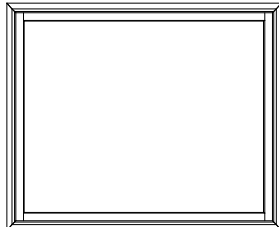

CCEP6654

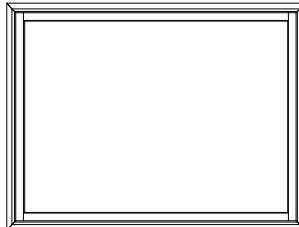

CCEP7254

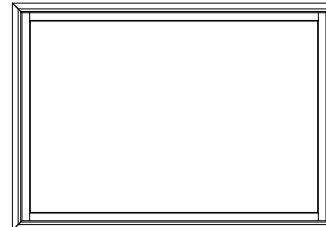

CCEP7854

58 1/2" (1486)
60" (1524)
56 3/4" (1441)
56" (1422)
49 7/8" (1267)

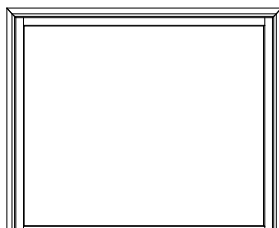

CCEP6656

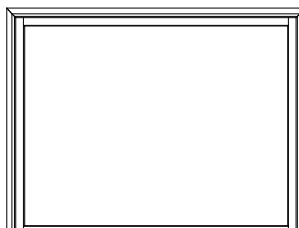

CCEP7256

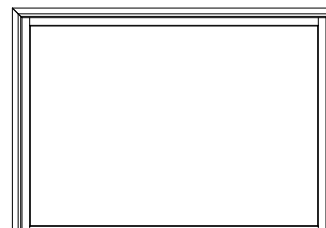

CCEP7856

62 1/2" (1588)
64" (1626)
60 3/4" (1543)
60" (1524)
53 7/8" (1368)



CCEP6660



CCEP7260



CCEP7860

66 1/2" (1689)
68" (1727)
64 3/4" (1645)
64" (1626)
57 7/8" (1470)



CCEP6664



CCEP7264



CCEP7864

ELEVATION SYMBOL LEGEND:

M.O. = MASONRY OPENING
VALUES IN () ARE IN MILLIMETER CONVERSIONS.

NUMBER INDICATES DESIGN PRESSURE (DP) RATING WITH STANDARD GLAZING.

Note: Elevations shown DO NOT have exterior trim. Subtract 3/4" (19) from M.O. (Masonry Opening) for Unit Sizes. Masonry Openings above include Sill Nose, see Trim Options page for Sill Nose specifications. For other Trim Options refer to the Unit Sizing, Rough Opening & Masonry Openings page.

SCALE: 1/4" = 1'

PICTURE UNITS

M.O. BRICKMOUND
M.O. ADAMS/FLAT CASING
ROUGH OPENING
FRAME SIZE
DAYLIGHT OPENING

68 3/4" (1746)
71 13/16" (1824)
66 3/4" (1695)
66" (1676)
59 7/8" (1581)

74 3/4" (1899)
77 13/16" (1976)
72 3/4" (1848)
72" (1829)
65 7/8" (1673)

80 3/4" (2051)
83 13/16" (2129)
78 3/4" (2000)
78" (1981)
71 7/8" (1826)

68 1/2" (1740)
70" (1778)
66 3/4" (1695)
66" (1676)
59 7/8" (1581)

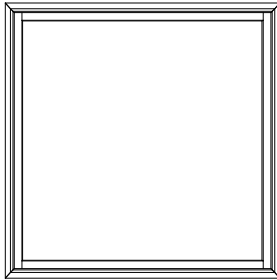

CCEP6666

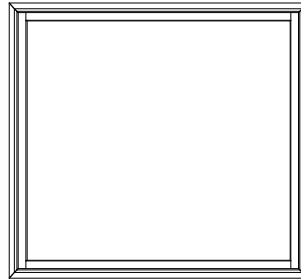

CCEP7266

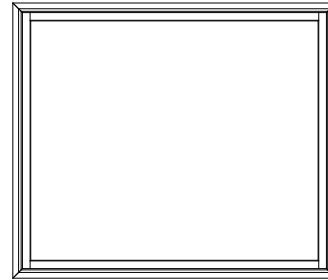

CCEP7866

74 1/2" (1892)
76" (1930)
72 3/4" (1848)
72" (1829)
65 7/8" (1673)

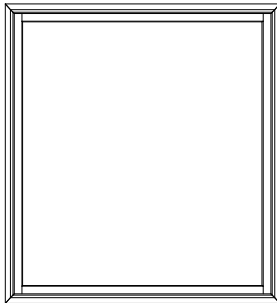

CCEP6672

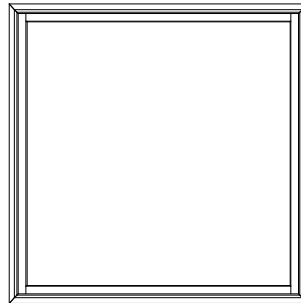

CCEP7272

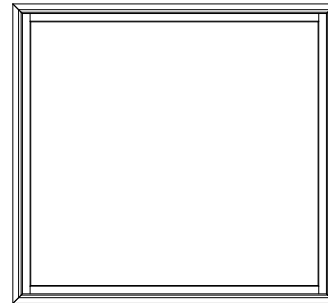

CCEP7872

80 1/2" (2045)
82" (2083)
78 3/4" (2000)
78" (1981)
71 7/8" (1826)

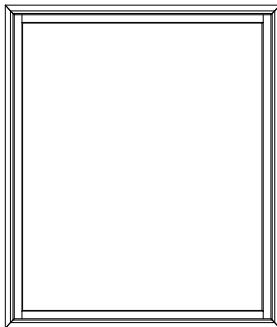

CCEP6678

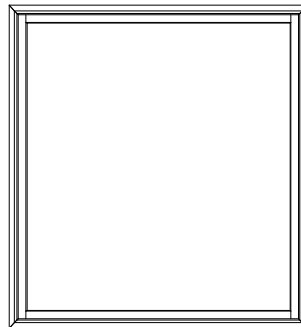

CCEP7278

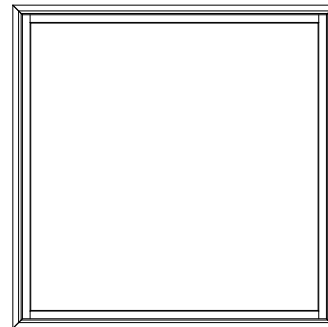

CCEP7878

86 1/2" (2197)
88" (2235)
84 3/4" (2153)
84" (2134)
77 7/8" (1978)

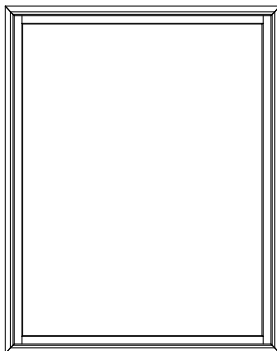

CCEP6684

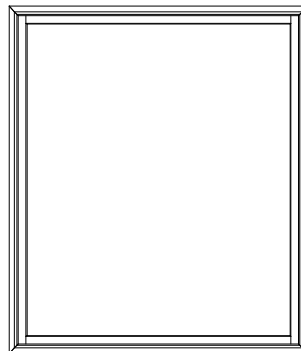

CCEP7284

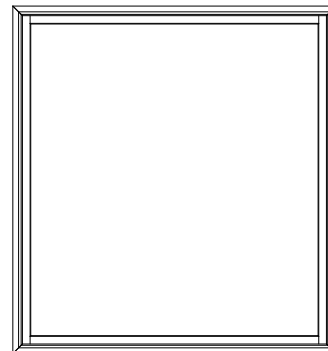

CCEP7884

ELEVATION SYMBOL LEGEND:

M.O. = MASONRY OPENING

VALUES IN () ARE IN MILLIMETER CONVERSIONS.

NUMBER INDICATES DESIGN PRESSURE (DP) RATING WITH STANDARD GLAZING.

Note: Elevations shown DO NOT have exterior trim. Subtract 3/4" (19) from M.O. (Masonry Opening) for Unit Sizes. Masonry Openings above include Sill Nose, see Trim Options page for Sill Nose specifications. For other Trim Options refer to the Unit Sizing, Rough Opening & Masonry Openings page.

SCALE: 1/4" = 1'

PICTURE UNITS

M.O. BRICKMOUND
M.O. ADAMS/FLAT CASING
ROUGH OPENING
FRAME SIZE
DAYLIGHT OPENING

68 3/4" (1746)
71 13/16" (1824)
66 3/4" (1695)
66" (1676)
59 7/8" (1581)

74 3/4" (1899)
77 13/16" (1976)
72 3/4" (1848)
72" (1829)
65 7/8" (1673)

80 3/4" (2051)
83 13/16" (2129)
78 3/4" (2000)
78" (1981)
71 7/8" (1826)

82 1/2" (2150)
84" (2133)
90 3/4" (2305)
90" (2286)
83 7/8" (2130)

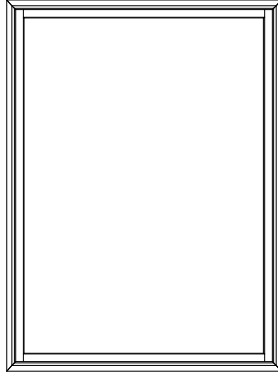

CCEP6690

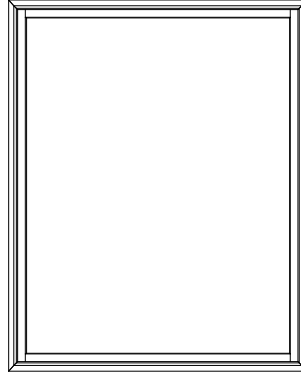

CCEP7290

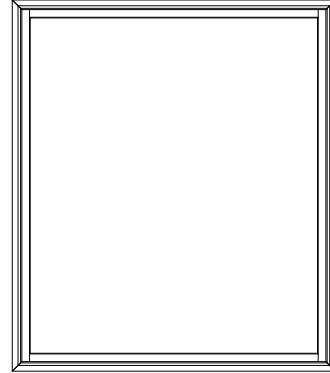

CCEP7890

98 1/2" (2502)
100" (2540)
96 3/4" (2457)
96" (2438)
89 7/8" (2283)

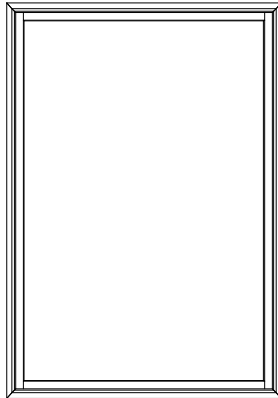

CCEP6696

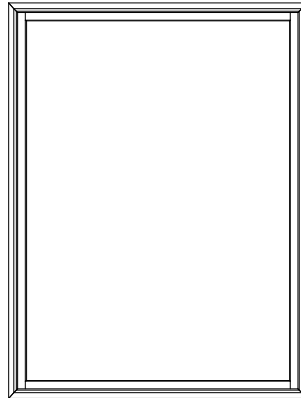

CCEP7296

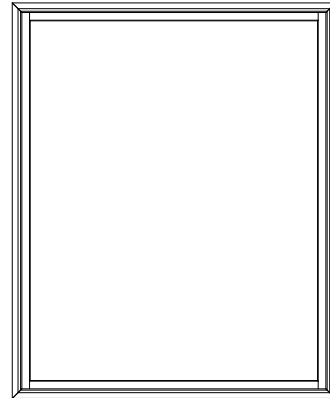

CCEP7896

104 1/2" (2654)
106" (2692)
102 3/4" (2610)
102" (2591)
95 7/8" (2435)

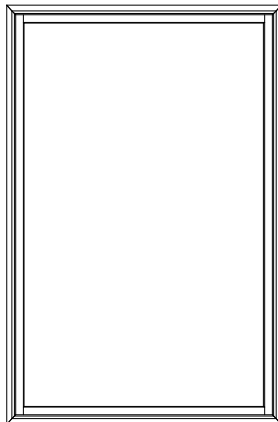

CCEP66102

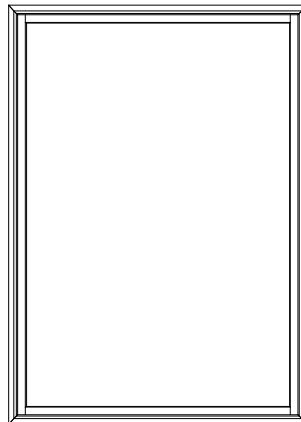

CCEP72102

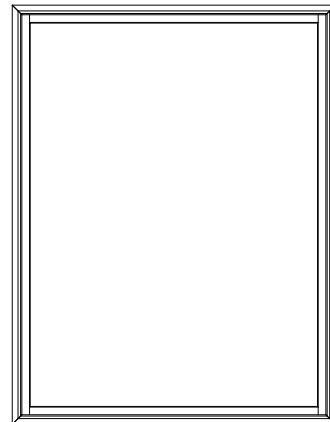

CCEP78102

ELEVATION SYMBOL LEGEND:

M.O. = MASONRY OPENING

VALUES IN () ARE IN MILLIMETER CONVERSIONS.

*** NUMBER INDICATES DESIGN PRESSURE (DP) RATING WITH STANDARD GLAZING.

Note: Elevations shown DO NOT have exterior trim. Subtract 3/4" (19) from M.O. (Masonry Opening) for Unit Sizes. Masonry Openings above include Sill Nose, see Trim Options page for Sill Nose specifications. For other Trim Options refer to the Unit Sizing, Rough Opening & Masonry Openings page.

SCALE: 1/4" = 1'

PICTURE UNITS

M.O. BRICKMOULD
M.O. ADAMS/FLAT CASING
ROUGH OPENING
FRAME SIZE
DAYLIGHT OPENING

68 3/4" (1746)
71 13/16" (1824)
66 3/4" (1695)
66" (1676)
59 7/8" (1581)

74 3/4" (1899)
77 13/16" (1976)
72 3/4" (1848)
72" (1829)
65 7/8" (1673)

110 1/2" (2807)
112" (2849)
108 3/4" (2762)
108" (2743)
101 7/8" (2588)

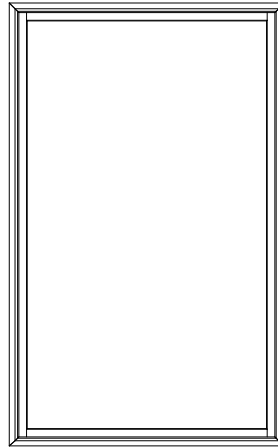

CCEP66108

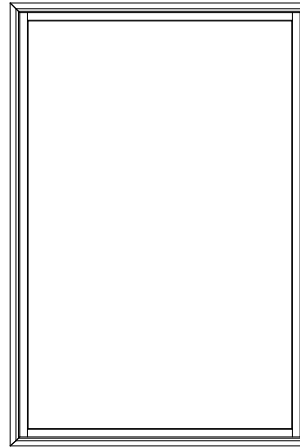

CCEP72108

ELEVATION SYMBOL LEGEND:

M.O. = MASONRY OPENING
VALUES IN () ARE IN MILLIMETER CONVERSIONS.

NUMBER INDICATES DESIGN PRESSURE (DP) RATING WITH STANDARD GLAZING.

Note: Elevations shown DO NOT have exterior trim. Subtract 3/4" (19) from M.O. (Masonry Opening) for Unit Sizes. Masonry Openings above include Sill Nose, see Trim Options page for Sill Nose specifications. For other Trim Options refer to the Unit Sizing, Rough Opening & Masonry Openings page.

SCALE: 1/4" = 1'

PICTURE UNITS

M.O. BRICKMOULD M.O. ADAMS/FLAT CASING ROUGH OPENING FRAME SIZE DAYLIGHT OPENING	86 3/4" (2203) 89 13/16" (2281) 84 3/4" (2153) 84" (2134) 77 7/8" (1978)	92 3/4" (2356) 95 13/16" (2434) 90 3/4" (2305) 90" (2286) 83 7/8" (2130)	98 3/4" (2508) 101 13/16" (2586) 96 3/4" (2457) 96" (2438) 89 7/8" (2283)
16 1/2" (419) 18" (457) 14 3/4" (375) 14" (356) 7 7/8" (200)			
20 1/2" (521) 22" (559) 18 3/4" (476) 18" (457) 11 7/8" (302)			
22 1/2" (572) 24" (610) 20 3/4" (527) 20" (508) 13 7/8" (352)			
26 1/2" (673) 28" (711) 24 3/4" (629) 24" (610) 17 7/8" (454)			
30 1/2" (775) 32" (813) 28 3/4" (730) 28" (711) 21 7/8" (556)			
32 1/2" (826) 34" (864) 30 3/4" (781) 30" (762) 23 7/8" (607)			
34 1/2" (876) 36" (914) 32 3/4" (832) 32" (813) 25 7/8" (657)			
38 1/2" (978) 40" (1016) 36 3/4" (933) 36" (914) 29 7/8" (759)			
42 1/2" (1080) 44" (1118) 40 3/4" (1035) 40" (1016) 33 7/8" (860)			

ELEVATION SYMBOL LEGEND:
M.O. = MASONRY OPENING
VALUES IN () ARE IN MILLIMETER CONVERSIONS.
*** NUMBER INDICATES DESIGN PRESSURE (DP) RATING WITH STANDARD GLAZING.

Note: Elevations shown DO NOT have exterior trim. Subtract 3/4" (19) from M.O. (Masonry Opening) for Unit Sizes. Masonry Openings above include Sill Nose, see Trim Options page for Sill Nose specifications. For other Trim Options refer to the Unit Sizing, Rough Opening & Masonry Openings page.

SCALE: 1/4" = 1'

PICTURE UNITS

M.O. BRICKMOULD
M.O. ADAMS/FLAT CASING
ROUGH OPENING
FRAME SIZE
DAYLIGHT OPENING

86 3/4" (2203)
89 13/16" (2281)
84 3/4" (2153)
84" (2134)
77 7/8" (1978)

92 3/4" (2356)
95 13/16" (2434)
90 3/4" (2305)
90" (2286)
83 7/8" (2130)

98 3/4" (2508)
101 13/16" (2586)
96 3/4" (2457)
96" (2438)
89 7/8" (2283)

44 1/2" (1130)
46" (1168)
42 3/4" (1086)
42" (1067)
35 7/8" (911)

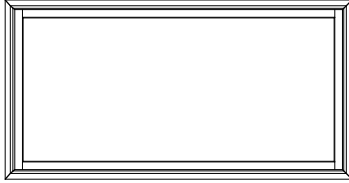

CCEP8442

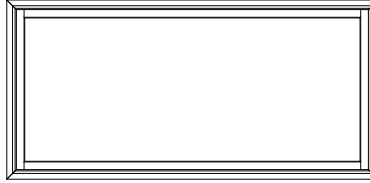

CCEP9042

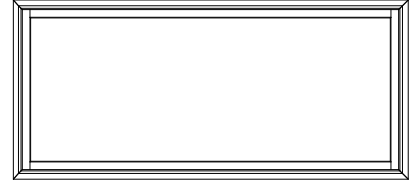

CCEP9642

50 1/2" (1283)
52" (1321)
48 3/4" (1238)
48" (1219)
41 7/8" (1064)

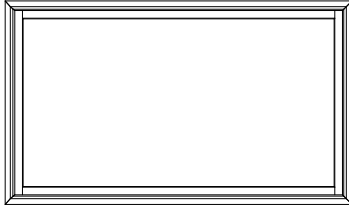

CCEP8448

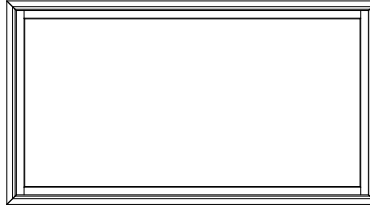

CCEP9048

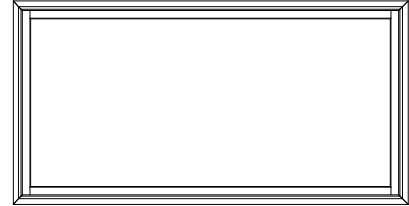

CCEP9648

56 1/2" (1435)
58" (1473)
54 3/4" (1391)
54" (1372)
47 7/8" (1216)

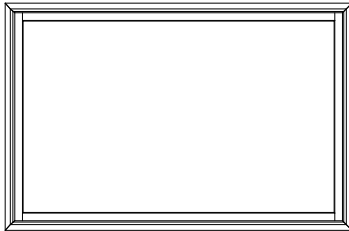

CCEP8454

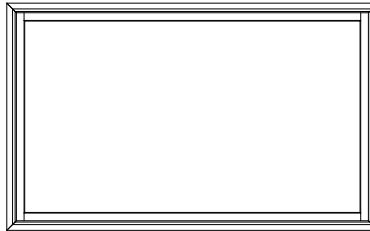

CCEP9054

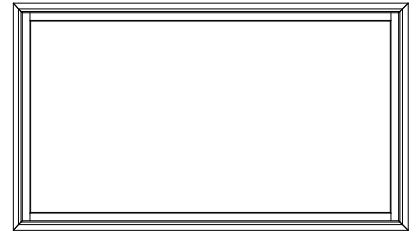

CCEP9654

58 1/2" (1486)
60" (1524)
56 3/4" (1441)
56" (1422)
49 7/8" (1267)

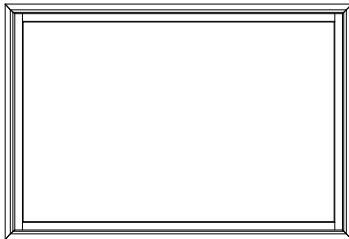

CCEP8456

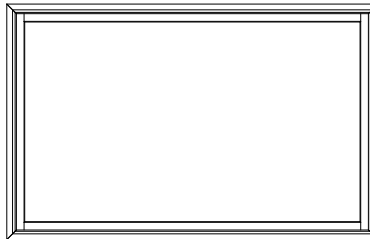

CCEP9056

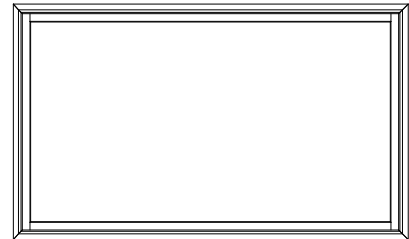

CCEP9656

62 1/2" (1588)
64" (1626)
60 3/4" (1543)
60" (1524)
53 7/8" (1368)

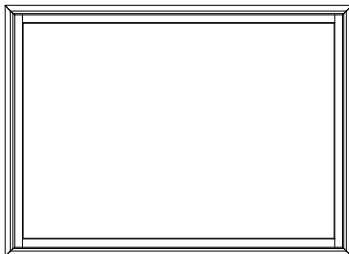

CCEP8460

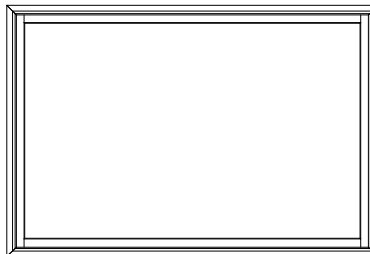

CCEP9060

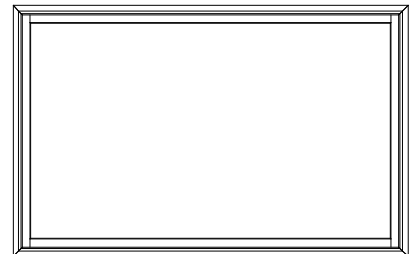

CCEP9660

66 1/2" (1689)
68" (1727)
64 3/4" (1645)
64" (1626)
57 7/8" (1470)

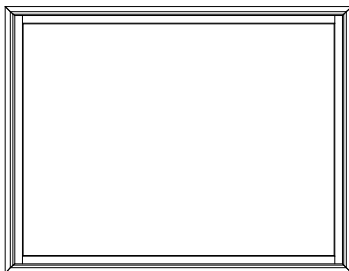

CCEP8464

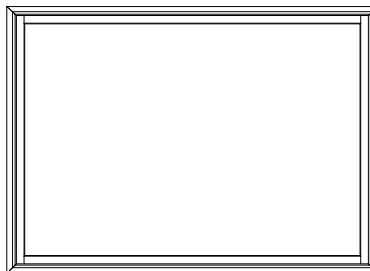

CCEP9064

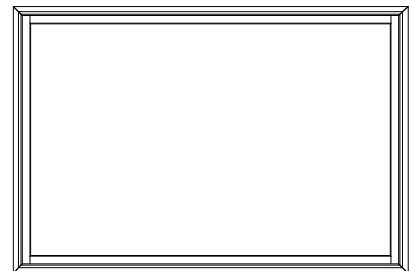

CCEP9664

ELEVATION SYMBOL LEGEND:

M.O. = MASONRY OPENING
VALUES IN () ARE IN MILLIMETER CONVERSIONS.
NUMBER INDICATES DESIGN PRESSURE (DP) RATING WITH STANDARD GLAZING.

Note: Elevations shown DO NOT have exterior trim. Subtract 3/4" (19) from M.O. (Masonry Opening) for Unit Sizes. Masonry Openings above include Sill Nose, see Trim Options page for Sill Nose specifications. For other Trim Options refer to the Unit Sizing, Rough Opening & Masonry Openings page.

SCALE: 1/4" = 1'

PICTURE UNITS

M.O. BRICKMOUND 86 3/4" (2203)
M.O. ADAMS/FLAT CASING 89 13/16" (2281)
ROUGH OPENING 84 3/4" (2153)
FRAME SIZE 84" (2134)
DAYLIGHT OPENING 77 7/8" (1978)

92 3/4" (2356)
95 13/16" (2434)
90 3/4" (2305)
90" (2286)
83 7/8" (2130)

98 3/4" (2508)
101 13/16" (2586)
96 3/4" (2457)
96" (2438)
89 7/8" (2283)

68 1/2" (1740)
70" (1778)
66 3/4" (1695)
66" (1676)
59 7/8" (1581)

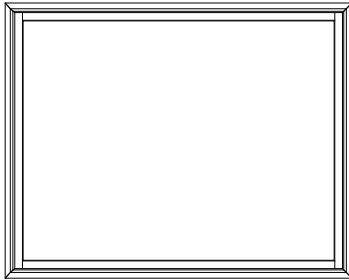

CCEP8466

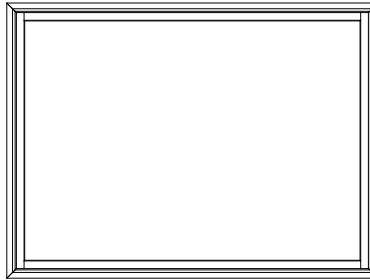

CCEP9066

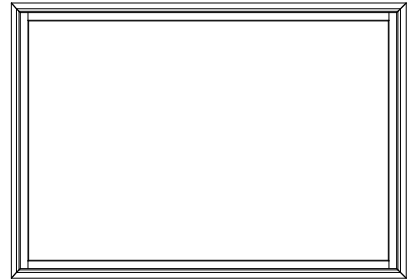

CCEP9666

74 1/2" (1892)
76" (1930)
72 3/4" (1848)
72" (1829)
65 7/8" (1673)

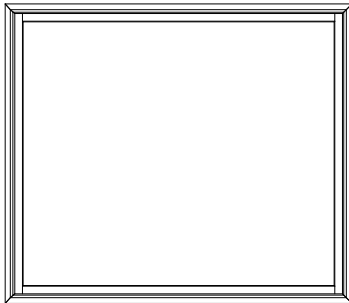

CCEP8472

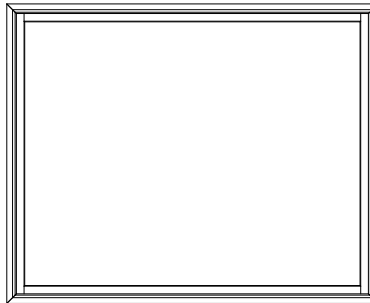

CCEP9072

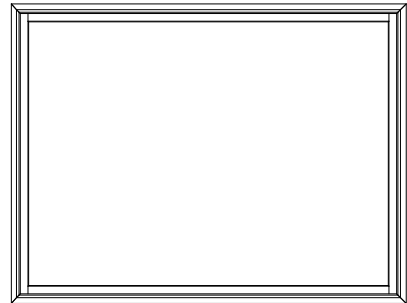

CCEP9672

80 1/2" (2045)
82" (2083)
78 3/4" (2000)
78" (1981)
71 7/8" (1826)

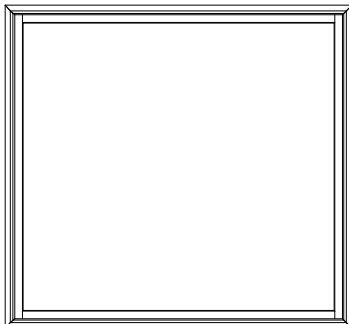

CCEP8478

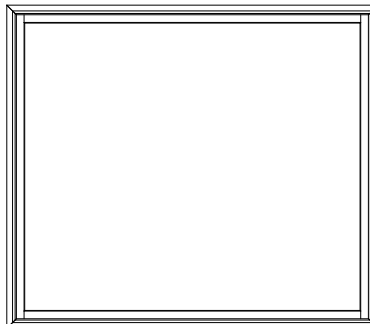

CCEP9078

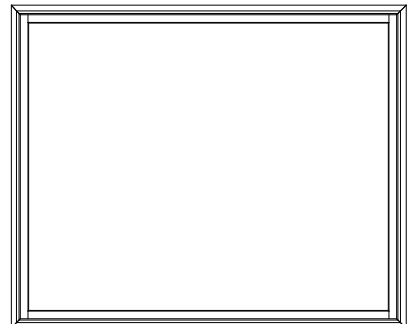

CCEP9678

86 1/2" (2197)
88" (2235)
84 3/4" (2153)
84" (2134)
77 7/8" (1978)

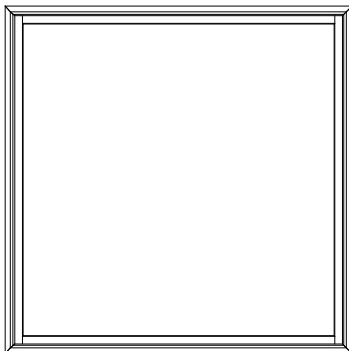

CCEP8484

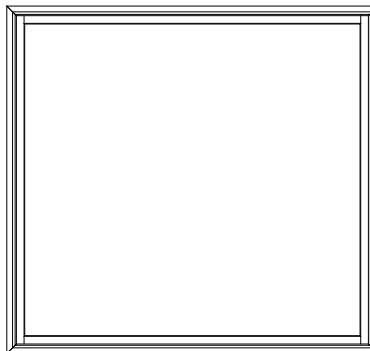

CCEP9084

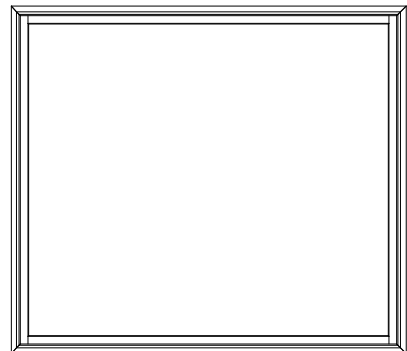

CCEP9684

ELEVATION SYMBOL LEGEND:
M.O. = MASONRY OPENING
VALUES IN () ARE IN MILLIMETER CONVERSIONS.
*** NUMBER INDICATES DESIGN PRESSURE (DP) RATING WITH STANDARD GLAZING.

Note: Elevations shown DO NOT have exterior trim. Subtract 3/4" (19) from M.O. (Masonry Opening) for Unit Sizes. Masonry Openings above include Sill Nose, see Trim Options page for Sill Nose specifications. For other Trim Options refer to the Unit Sizing, Rough Opening & Masonry Openings page.

SCALE: 1/4" = 1'

PICTURE UNITS

M.O. BRICKMOULD	86 3/4" (2203)
M.O. ADAMS/FLAT CASING	89 13/16" (2281)
ROUGH OPENING	84 3/4" (2153)
FRAME SIZE	84" (2134)
DAYLIGHT OPENING	77 7/8" (1978)

92 1/2" (2350)
94" (2388)
90 3/4" (2305)
90" (2286)
83 7/8" (2130)

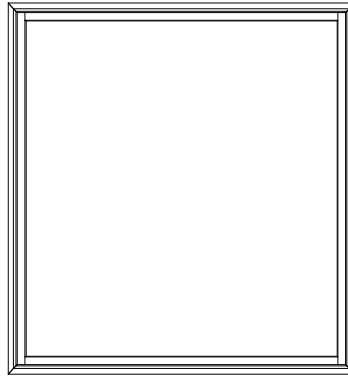

CCEP8490

98 1/2" (2502)
100" (2540)
96 3/4" (2457)
96" (2438)
89 7/8" (2283)

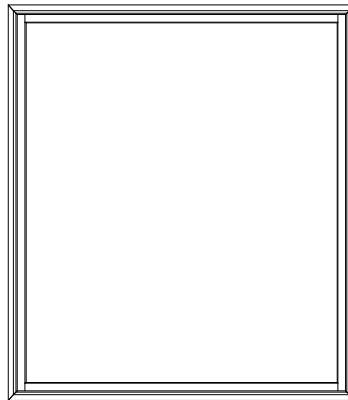

CCEP8496

ELEVATION SYMBOL LEGEND:

M.O. = MASONRY OPENING
VALUES IN () ARE IN MILLIMETER CONVERSIONS.

NUMBER INDICATES DESIGN PRESSURE (DP) RATING WITH STANDARD GLAZING.

Note: Elevations shown DO NOT have exterior trim. Subtract 3/4" (19) from M.O. (Masonry Opening) for Unit Sizes. Masonry Openings above include Sill Nose, see Trim Options page for Sill Nose specifications. For other Trim Options refer to the Unit Sizing, Rough Opening & Masonry Openings page.

SCALE: 1/4" = 1'

PICTURE UNITS

M.O. BRICKMOUND
M.O. ADAMS/FLAT CASING
ROUGH OPENING
FRAME SIZE
DAYLIGHT OPENING

104 3/4" (2661)
107 13/16" (2738)
102 3/4" (2610)
102" (2591)
95 7/8" (2435)

110 3/4" (2813)
113 13/16" (2891)
108 3/4" (2762)
108" (2743)
101 7/8" (2588)

16 1/2" (419)
18" (457)
14 3/4" (375)
14" (356)
7 7/8" (200)

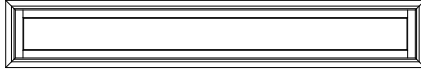

CCEP10214

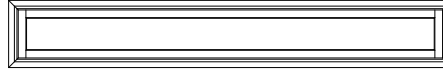

CCEP10814

20 1/2" (521)
22" (559)
18 3/4" (476)
18" (457)
11 7/8" (302)

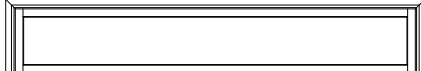

CCEP10218

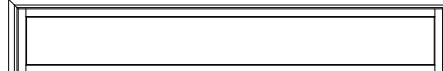

CCEP10818

22 1/2" (572)
24" (610)
20 3/4" (527)
20" (508)
13 7/8" (352)



CCEP10220



CCEP10820

26 1/2" (673)
28" (711)
24 3/4" (629)
24" (610)
17 7/8" (454)



CCEP10224



CCEP10824

30 1/2" (775)
32" (813)
28 3/4" (730)
28" (711)
21 7/8" (556)



CCEP10228



CCEP10828

32 1/2" (826)
34" (864)
30 3/4" (781)
30" (762)
23 7/8" (607)



CCEP10230



CCEP10830

34 1/2" (876)
36" (914)
32 3/4" (832)
32" (813)
25 7/8" (657)



CCEP10232



CCEP10832

38 1/2" (978)
40" (1016)
36 3/4" (933)
36" (914)
29 7/8" (759)



CCEP10236



CCEP10836

42 1/2" (1080)
44" (1118)
40 3/4" (1035)
40" (1016)
33 7/8" (860)



CCEP10240



CCEP10840

ELEVATION SYMBOL LEGEND:

M.O. = MASONRY OPENING

VALUES IN () ARE IN MILLIMETER CONVERSIONS.

*** NUMBER INDICATES DESIGN PRESSURE (DP) RATING WITH STANDARD GLAZING.

Note: Elevations shown DO NOT have exterior trim. Subtract 3/4" (19) from M.O. (Masonry Opening) for Unit Sizes. Masonry Openings above include Sill Nose, see Trim Options page for Sill Nose specifications. For other Trim Options refer to the Unit Sizing, Rough Opening & Masonry Openings page.

SCALE: 1/4" = 1'

PICTURE UNITS

M.O. BRICKMOUND
M.O. ADAMS/FLAT CASING
ROUGH OPENING
FRAME SIZE
DAYLIGHT OPENING

104 3/4" (2661)
107 13/16" (2738)
102 3/4" (2610)
102" (2591)
95 7/8" (2435)

110 3/4" (2813)
113 13/16" (2891)
108 3/4" (2762)
108" (2743)
101 7/8" (2588)

44 1/2" (1130)
46" (1168)
42 3/4" (1086)
42" (1067)
35 7/8" (911)

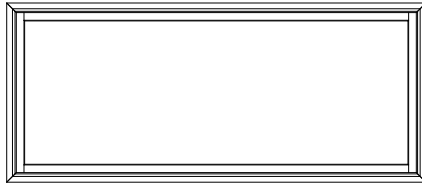

CCEP10242

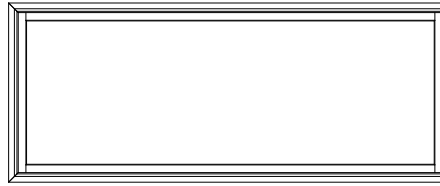

CCEP10842

50 1/2" (1283)
52" (1321)
48 3/4" (1238)
48" (1219)
41 7/8" (1064)

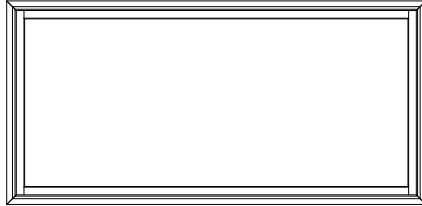

CCEP10248

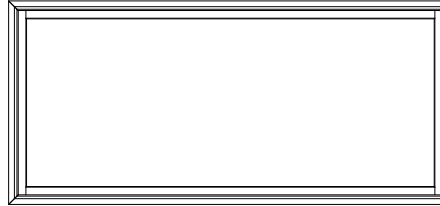

CCEP10848

56 1/2" (1435)
58" (1473)
54 3/4" (1391)
54" (1372)
47 7/8" (1216)

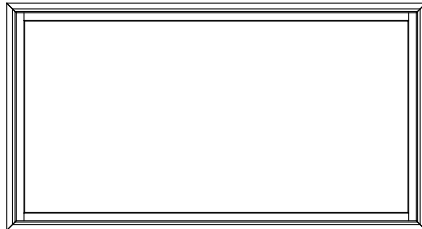

CCEP10254

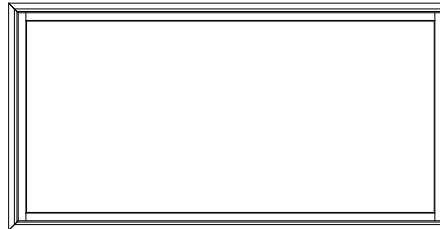

CCEP10854

58 1/2" (1486)
60" (1524)
56 3/4" (1441)
56" (1422)
49 7/8" (1267)

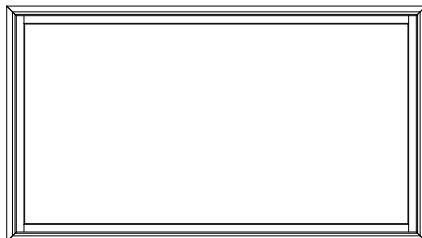

CCEP10256



CCEP10856

62 1/2" (1588)
64" (1626)
60 3/4" (1543)
60" (1524)
53 7/8" (1368)

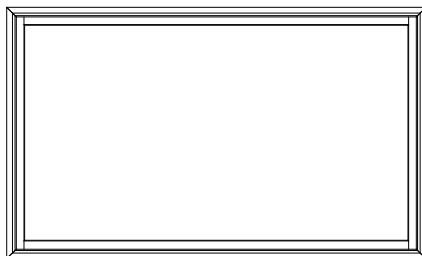

CCEP10260

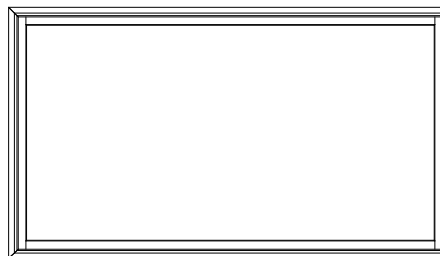

CCEP10860

66 1/2" (1689)
68" (1727)
64 3/4" (1645)
64" (1626)
57 7/8" (1470)

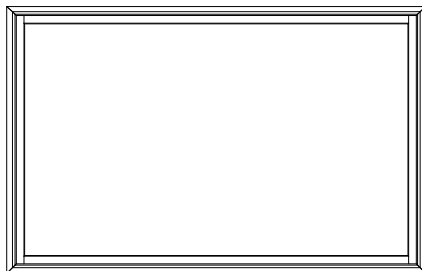

CCEP10264

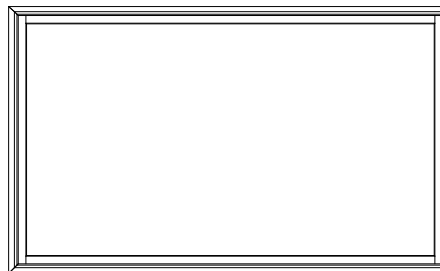

CCEP10864

ELEVATION SYMBOL LEGEND:

M.O. = MASONRY OPENING

VALUES IN () ARE IN MILLIMETER CONVERSIONS.

NUMBER INDICATES DESIGN PRESSURE (DP) RATING WITH STANDARD GLAZING.

Note: Elevations shown DO NOT have exterior trim. Subtract 3/4" (19) from M.O. (Masonry Opening) for Unit Sizes. Masonry Openings above include Sill Nose, see Trim Options page for Sill Nose specifications. For other Trim Options refer to the Unit Sizing, Rough Opening & Masonry Openings page.

SCALE: 1/4" = 1'

PICTURE UNITS

M.O. BRICKMOULD
M.O. ADAMS/FLAT CASING
ROUGH OPENING
FRAME SIZE
DAYLIGHT OPENING

104 3/4" (2661)
107 13/16" (2738)
102 3/4" (2610)
102" (2591)
95 7/8" (2435)

110 3/4" (2813)
113 13/16" (2891)
108 3/4" (2762)
108" (2743)
101 7/8" (2588)

68 1/2" (1740)
70" (1778)
66 3/4" (1695)
66" (1676)
59 7/8" (1581)

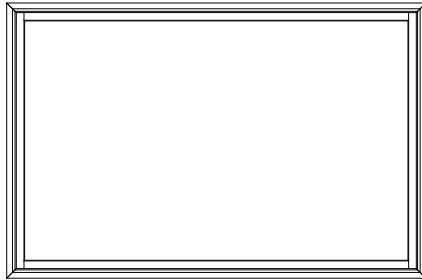

CCEP10266

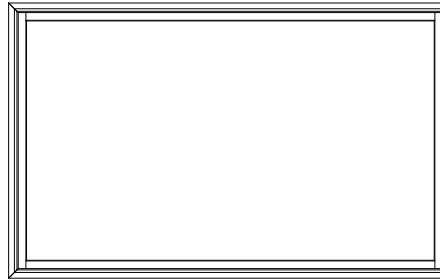

CCEP10866

74 1/2" (1892)
76" (1930)
72 3/4" (1848)
72" (1829)
65 7/8" (1673)

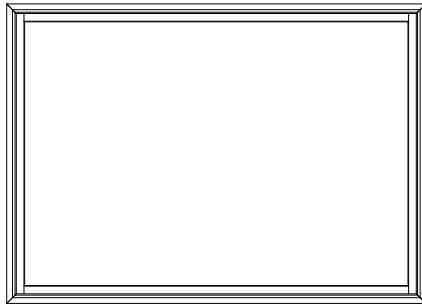

CCEP10272



CCEP10872

80 1/2" (2045)
82" (2083)
78 3/4" (2000)
78" (1981)
71 7/8" (1826)

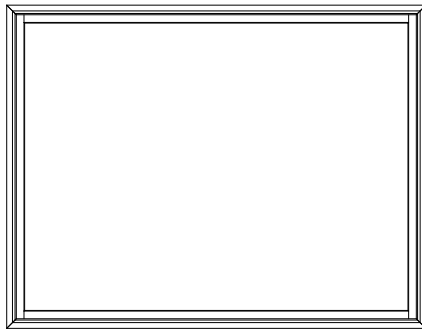

CCEP10278

ELEVATION SYMBOL LEGEND:

M.O. = MASONRY OPENING

VALUES IN () ARE IN MILLIMETER CONVERSIONS.

*** NUMBER INDICATES DESIGN PRESSURE (DP) RATING WITH STANDARD GLAZING.

Note: Elevations shown DO NOT have exterior trim. Subtract 3/4" (19) from M.O. (Masonry Opening) for Unit Sizes. Masonry Openings above include Sill Nose, see Trim Options page for Sill Nose specifications. For other Trim Options refer to the Unit Sizing, Rough Opening & Masonry Openings page.

SCALE: 1/4" = 1'

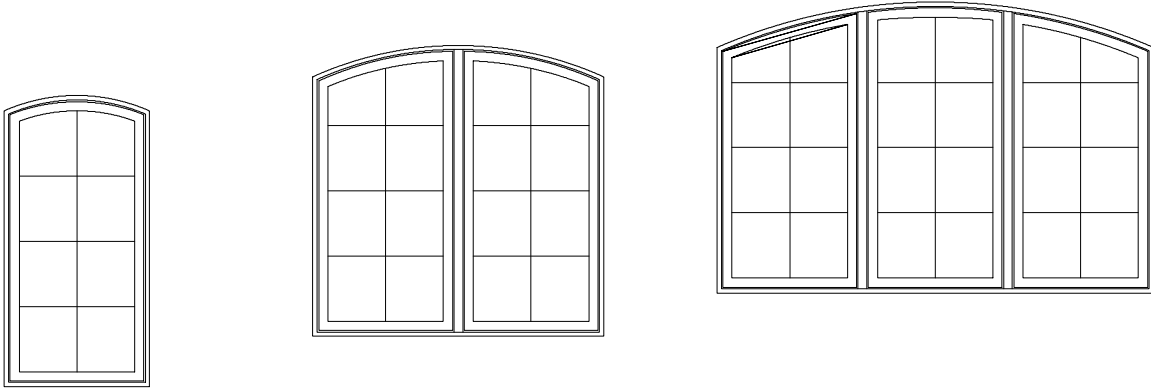
GENERAL INFORMATION
SECTOR TOP

Clad Epic casement sector top windows are constructed the same as EPIC clad casements with roll formed cladding on wood sash.

Clad Epic casement sector top windows are available with left or right hand operation (hinged on the springline), or stationary (non-venting). Operating mechanism includes stainless steel, corrosion resistant, butt hinges and single arm roto-type operator with hardened steel gears and operating arm. Sash locks are concealed unison type with an exposed locking lever and escutcheon plate. There are several interior hardware finish options. Refer to the Specifications for finish options.

EPIC CLAD CASEMENT SECTOR TOPS utilize some of the same options as EPIC CLAD CASEMENTS. Those options have not been repeated in the following sub-section.

See the EPIC CLAD CASEMENT section for:

- Unit Sizing
- Trim Options

HANDING & OPERATION
SECTOR TOP

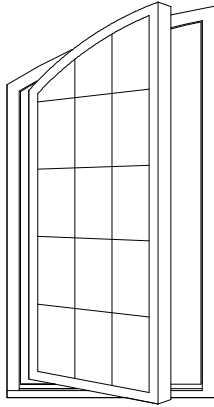

**LEFT
HAND**

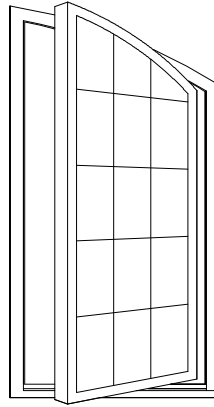

**RIGHT
HAND**

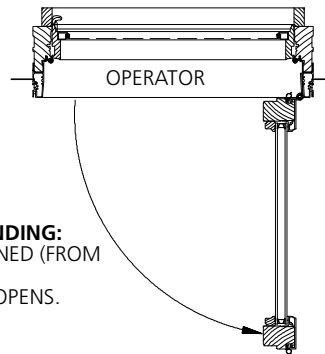
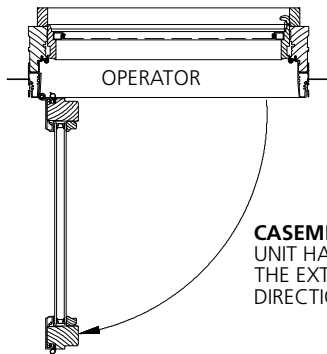

CASEMENT UNIT HANDING:
UNIT HANDING IS DEFINED (FROM
THE EXTERIOR) AS THE
DIRECTION THE SASH OPENS.

UNIT HANDING INFORMATION:

OPERATING SINGLE SECTOR UNITS - MAY BE HANDED 'LEFT' OR 'RIGHT'.

OPERATING TWIN SECTOR UNITS - THESE UNITS ARE HINGED ON THE SPRINGLINE SIDE. THE 'LEFT' SASH HAS 'LEFT' HAND OPERATION AND THE 'RIGHT' SASH HAS 'RIGHT' HAND OPERATION ONLY.

OPERATING TRIPLE SECTOR UNITS - ONLY THE FLANKING UNITS MAY BE OPERATORS WHICH ARE HINGED ON THE SPRINGLINE SIDE. THE TWO OPERATING SASH ARE HANDED THE SAME AS THE TWIN SECTOR.

ELEVATION NOTES
SECTOR TOP

ELEVATION DRAWINGS UTILIZE A LIMITED NUMBER OF PROJECTED LINES TO PRODUCE A RUDIMENTARY DRAWING INTENDED TO BE USED IN A SMALL GRAPHICAL SCALE. ELEVATIONS ARE VIEWED PERPENDICULAR FROM THE EXTERIOR OF THE STRUCTURE. IF MORE DIMENSIONS ARE NEEDED, USE THE SECTION DRAWINGS FOR MORE COMPLETE DEPICTIONS.

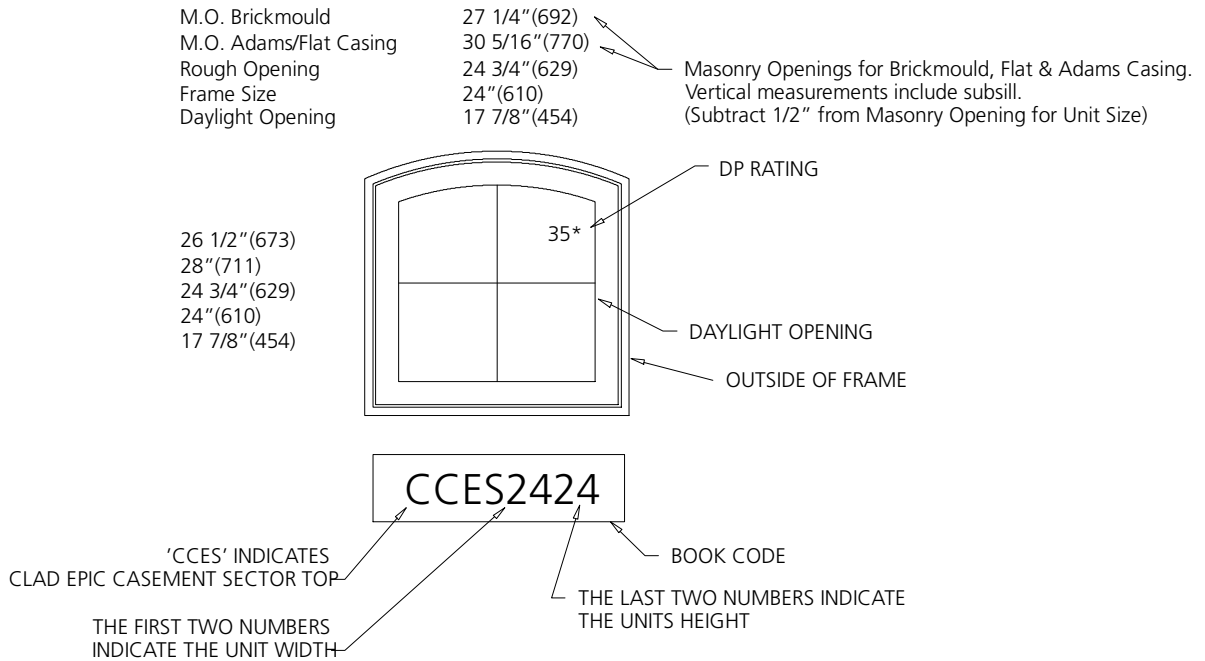

GENERAL RADIUS CASEMENT NOTES

1. UNIT ELEVATIONS ARE SHOWN WITHOUT EXTERIOR TRIM.
2. DIMENSIONAL VALUES IN () ARE MILLIMETER CONVERSIONS.
3. ALL SECTOR UNITS ARE AVAILABLE AS OPERATING UNITS.

ELEVATION SYMBOL LEGEND:

- ##*** NUMBER INDICATES DESIGN PRESSURE (DP) RATING WITH STANDARD GLAZING. OPERATING UNITS UTILIZE A CONCEALED LOCKING SYSTEM FOR DP RATINGS.
- E** UNIT MEETS EGRESS REQUIREMENTS FOR IRC CODE. STATE AND LOCAL EGRESS CODES MAY DIFFER. ALWAYS REFER TO LOCAL BUILDING CODES FOR COMPLETE REQUIREMENTS. CHECK WITH LOCAL OFFICIALS TO ENSURE COMPLIANCE BEFORE INSTALLING THE UNIT.
- S** STATIONARY UNIT.
- LO** LIMITED OPERATION.

SECTOR TOP UNITS

M.O. BRICKMOULD 27 1/4" (692)
M.O. ADAMS/FLAT CASING 30 5/16" (770)
ROUGH OPENING 24 3/4" (629)
FRAME SIZE 24" (610)
DAYLIGHT OPENING 17 7/8" (454)

26 1/2" (673)
28" (711)
24 3/4" (629)
24" (610)
17 7/8" (454)



CCECS2424

33 1/4" (845)
36 5/16" (922)
30 3/4" (781)
30" (762)
23 7/8" (607)

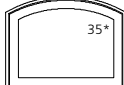

CCECS3024

32 1/2" (826)
34" (864)
30 3/4" (781)
30" (762)
23 7/8" (607)

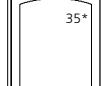

CCECS2430



CCECS3030

34 1/2" (876)
36" (914)
32 3/4" (832)
32" (813)
25 7/8" (657)

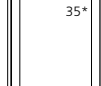

CCECS2432



CCECS3032

38 1/2" (978)
40" (1016)
36 3/4" (933)
36" (914)
29 7/8" (759)

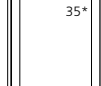

CCECS2436



CCECS3036

42 1/2" (1080)
44" (1118)
40 3/4" (1035)
40" (1016)
33 7/8" (860)



CCECS2440

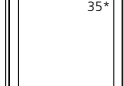

CCECS3040

44 1/2" (1130)
46" (1168)
42 3/4" (1086)
42" (1067)
35 7/8" (911)

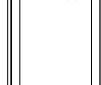

CCECS2442



CCECS3042

50 1/2" (1283)
52" (1321)
48 3/4" (1238)
48" (1219)
41 7/8" (1064)

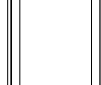

CCECS2448



CCECS3048

M.O. BRICKMOULD 27 1/4" (692)
M.O. ADAMS/FLAT CASING 30 5/16" (770)
ROUGH OPENING 24 3/4" (629)
FRAME SIZE 24" (610)
DAYLIGHT OPENING 17 7/8" (454)

56 1/2" (1435)
58" (1473)
54 3/4" (1391)
54" (1372)
47 7/8" (1216)



CCECS2454



CCECS3054

58 1/2" (1486)
60" (1524)
56 3/4" (1441)
56" (1422)
49 7/8" (1267)



CCECS2456



CCECS3056

62 1/2" (1588)
64" (1626)
60 3/4" (1543)
60" (1524)
53 7/8" (1368)



CCECS2460



CCECS3060

66 1/2" (1689)
68" (1727)
64 3/4" (1645)
64" (1626)
57 7/8" (1470)



CCECS2464



CCECS3064

68 1/2" (1740)
70" (1778)
66 3/4" (1695)
66" (1676)
59 7/8" (1521)



CCECS2466



CCECS3066

ELEVATION SYMBOL LEGEND:

M.O. = MASONRY OPENING

VALUES IN () ARE IN MILLIMETER CONVERSIONS.

= NUMBER INDICATES DESIGN PRESSURE (DP) RATING WITH STANDARD GLAZING.

E = UNIT MEETS EGRESS REQUIREMENTS FOR IRC CODE. STATE AND LOCAL EGRESS CODES MAY DIFFER. ALWAYS REFER TO LOCAL BUILDING CODES FOR COMPLETE REQUIREMENTS. CHECK WITH LOCAL OFFICIALS TO ENSURE COMPLIANCE BEFORE INSTALLING THE UNIT.

Note: Elevations shown DO NOT have exterior trim. Subtract 1/2" (12.7) from M.O. (Masonry Opening) for Unit Sizes. Masonry Openings above include Sill Nose, see Trim Options page for Sill Nose specifications. For other Trim Options refer to the Unit Sizing, Rough Opening & Masonry Openings page.

SCALE: 1/4" = 1'

SECTOR TOP UNITS

M.O. BRICKMOUND	27 1/4" (692)	33 1/4" (845)
M.O. ADAMS/FLAT CASING	30 5/16" (770)	36 5/16" (922)
ROUGH OPENING	24 3/4" (629)	30 3/4" (781)
FRAME SIZE	24" (610)	30" (762)
DAYLIGHT OPENING	17 7/8" (454)	23 7/8" (607)

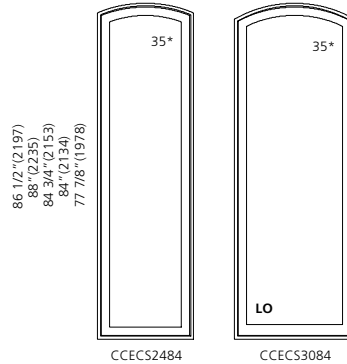
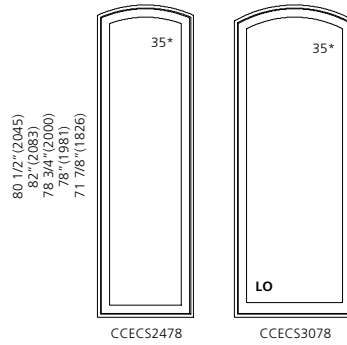
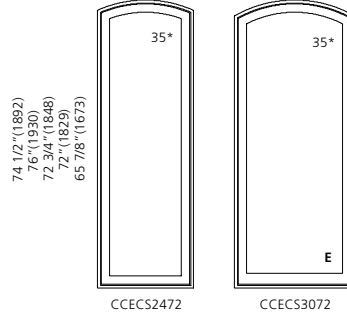

ELEVATION SYMBOL LEGEND:

M.O. = MASONRY OPENING

VALUES IN () ARE IN MILLIMETER CONVERSIONS.

##* NUMBER INDICATES DESIGN PRESSURE (DP) RATING WITH STANDARD GLAZING.

E UNIT MEETS EGRESS REQUIREMENTS FOR IRC CODE. STATE AND LOCAL EGRESS CODES MAY DIFFER. ALWAYS REFER TO LOCAL BUILDING CODES FOR COMPLETE REQUIREMENTS. CHECK WITH LOCAL OFFICIALS TO ENSURE COMPLIANCE BEFORE INSTALLING THE UNIT.

LO LIMITED OPERATION.

Note: Elevations shown DO NOT have exterior trim. Subtract 1/2" (12.7) from M.O. (Masonry Opening) for Unit Sizes. Masonry Openings above include Sill Nose, see Trim Options page for Sill Nose specifications. For other Trim Options refer to the Unit Sizing, Rough Opening & Masonry Openings page.

SCALE: 1/4" = 1'

EXTENDED HALF ROUND UNITS

M.O. BRICKMOULD M.O. ADAMS/FLAT CASING ROUGH OPENING FRAME SIZE DAYLIGHT OPENING	21 1/4" (540) 24 5/16" (618) 18 3/4" (476) 18" (457) 11 7/8" (302)	23 1/4" (591) 26 5/16" (668) 20 3/4" (527) 20" (508) 13 7/8" (352)	27 1/4" (692) 30 5/16" (770) 24 3/4" (629) 24" (610) 17 7/8" (454)	31 1/4" (794) 34 5/16" (872) 28 3/4" (730) 28" (711) 21 7/8" (556)	33 1/4" (845) 36 5/16" (922) 30 3/4" (781) 30" (762) 23 7/8" (607)
26 1/2" (673) 28" (711) 24 3/4" (629) 24" (610) 17 7/8" (454)					
32 1/2" (826) 34" (864) 30 3/4" (781) 30" (762) 23 7/8" (607)					
34 1/2" (876) 36" (914) 32 3/4" (832) 32" (813) 25 7/8" (657)					
38 1/2" (978) 40" (1016) 36 3/4" (933) 36" (914) 29 7/8" (759)					
42 1/2" (1080) 44" (1118) 40 3/4" (1035) 40" (1016) 33 7/8" (860)					
44 1/2" (1130) 46" (1168) 42 3/4" (1086) 42" (1067) 35 7/8" (911)					
50 1/2" (1283) 52" (1321) 48 3/4" (1238) 48" (1219) 41 7/8" (1064)					

ELEVATION SYMBOL LEGEND:
M.O. = MASONRY OPENING
VALUES IN () ARE IN MILLIMETER CONVERSIONS.
S STATIONARY UNIT.

Note: Elevations shown DO NOT have exterior trim. Subtract 1/2" (12.7) from M.O. (Masonry Opening) for Unit Sizes. Masonry Openings above include Sill Nose, see Trim Options page for Sill Nose specifications. For other Trim Options refer to the Unit Sizing, Rough Opening & Masonry Openings page.

SCALE: 1/4" = 1'

EXTENDED HALF ROUND UNITS

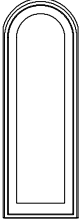
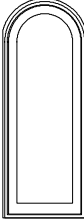
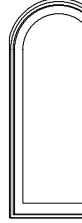
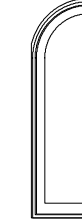
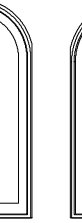
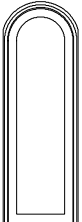
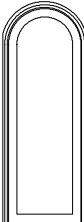
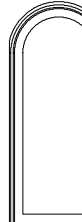
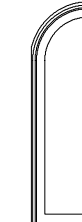
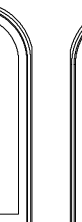
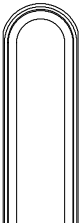
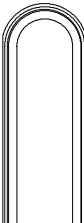
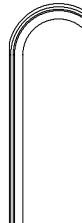
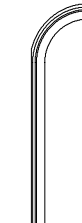
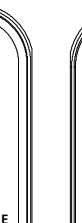
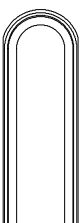
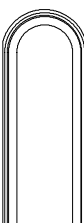
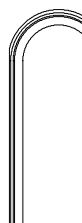
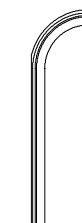
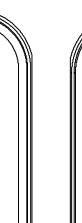
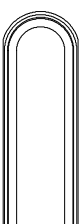
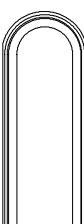
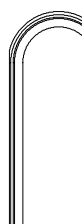
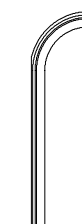
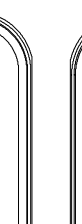
M.O. BRICKMOULD	21 1/4"(540)	23 1/4"(591)	27 1/4"(692)	31 1/4"(794)	33 1/4"(845)
M.O. ADAMS/FLAT CASING	24 5/16"(618)	26 5/16"(668)	30 5/16"(770)	34 5/16"(872)	36 5/16"(922)
ROUGH OPENING	18 3/4"(476)	20 3/4"(527)	24 3/4"(629)	28 3/4"(730)	30 3/4"(781)
FRAME SIZE	18"(457)	20"(508)	24"(610)	28"(711)	30"(762)
DAYLIGHT OPENING	11 7/8"(302)	13 7/8"(352)	17 7/8"(454)	21 7/8"(556)	23 7/8"(607)
56 1/2"(1435) 58"(1473) 54 3/4"(1391) 54"(1372) 47 7/8"(1216)					
	CCECH1854	CCECH2054	CCECH2454	CCECH2854	CCECH3054
58 1/2"(1486) 60"(1524) 56 3/4"(1441) 56"(1422) 49 7/8"(1267)					
	CCECH1856	CCECH2056	CCECH2456	CCECH2856	CCECH3056
62 1/2"(1588) 64"(1626) 60 3/4"(1543) 60"(1524) 53 7/8"(1368)					
	CCECH1860	CCECH2060	CCECH2460	CCECH2860	CCECH3060
66 1/2"(1689) 68"(1727) 64 3/4"(1645) 64"(1626) 57 7/8"(1470)					
	CCECH1864	CCECH2064	CCECH2464	CCECH2864	CCECH3064
68 1/2"(1740) 70"(1778) 66 3/4"(1695) 66"(1676) 59 7/8"(1521)					
	CCECH1866	CCECH2066	CCECH2466	CCECH2866	CCECH3066

ELEVATION SYMBOL LEGEND:

M.O. = MASONRY OPENING
VALUES IN () ARE IN MILLIMETER CONVERSIONS.
E UNIT MEETS EGRESS REQUIREMENTS FOR IRC CODE. STATE AND LOCAL EGRESS CODES MAY DIFFER. ALWAYS REFER TO LOCAL BUILDING CODES FOR COMPLETE REQUIREMENTS. CHECK WITH LOCAL OFFICIALS TO ENSURE COMPLIANCE BEFORE INSTALLING THE UNIT.

Note: Elevations shown DO NOT have exterior trim. Subtract 1/2" (12.7) from M.O. (Masonry Opening) for Unit Sizes. Masonry Openings above include Sill Nose, see Trim Options page for Sill Nose specifications. For other Trim Options refer to the Unit Sizing, Rough Opening & Masonry Openings page.

SCALE: 1/4" = 1'

EXTENDED HALF ROUND UNITS

M.O. BRICKMOULD	21 1/4"(540)	23 1/4"(591)	27 1/4"(692)	31 1/4"(794)	33 1/4"(845)
M.O. ADAMS/FLAT CASING	24 5/16"(618)	26 5/16"(668)	30 5/16"(770)	34 5/16"(872)	36 5/16"(922)
ROUGH OPENING	18 3/4"(476)	20 3/4"(527)	24 3/4"(629)	28 3/4"(730)	30 3/4"(781)
FRAME SIZE	18"(457)	20"(508)	24"(610)	28"(711)	30"(762)
DAYLIGHT OPENING	11 7/8"(302)	13 7/8"(352)	17 7/8"(454)	21 7/8"(556)	23 7/8"(607)
74 1/2"(1892) 76"(1930) 72 3/4"(1848) 72"(1829) 65 7/8"(1673)					
80 1/2"(2045) 82"(2083) 78 3/4"(2000) 78"(1981) 71 7/8"(1826)					
86 1/2"(2197) 88"(2235) 84 3/4"(2153) 84"(2134) 77 7/8"(1978)					

ELEVATION SYMBOL LEGEND:

- M.O.** = MASONRY OPENING
- VALUES IN () ARE IN MILLIMETER CONVERSIONS.
- E** UNIT MEETS EGRESS REQUIREMENTS FOR IRC CODE. STATE AND LOCAL EGRESS CODES MAY DIFFER. ALWAYS REFER TO LOCAL BUILDING CODES FOR COMPLETE REQUIREMENTS. CHECK WITH LOCAL OFFICIALS TO ENSURE COMPLIANCE BEFORE INSTALLING THE UNIT.
- LO** LIMITED OPERATION.

Note: Elevations shown DO NOT have exterior trim. Subtract 1/2" (12.7) from M.O. (Masonry Opening) for Unit Sizes. Masonry Openings above include Sill Nose, see Trim Options page for Sill Nose specifications. For other Trim Options refer to the Unit Sizing, Rough Opening & Masonry Openings page.

SCALE: 1/4" = 1'

EXTENDED QUARTER ROUND UNITS

M.O. BRICKMOULD M.O. ADAMS/FLAT CASING ROUGH OPENING FRAME SIZE DAYLIGHT OPENING	21 1/4" (540) 24 5/16" (618) 18 3/4" (476) 18" (457) 11 7/8" (302)	23 1/4" (591) 26 5/16" (668) 20 3/4" (527) 20" (508) 13 7/8" (352)	27 1/4" (692) 30 5/16" (770) 24 3/4" (629) 24" (610) 17 7/8" (454)	31 1/4" (794) 34 5/16" (872) 28 3/4" (730) 28" (711) 21 7/8" (556)	33 1/4" (845) 36 5/16" (922) 30 3/4" (781) 30" (762) 23 7/8" (607)
32 1/2" (826) 34" (864) 30 3/4" (781) 30" (762) 23 7/8" (607)					
34 1/2" (876) 36" (914) 32 3/4" (832) 32" (813) 25 7/8" (657)					
38 1/2" (978) 40" (1016) 36 3/4" (933) 36" (914) 29 7/8" (759)					
42 1/2" (1080) 44" (1118) 40 3/4" (1035) 40" (1016) 33 7/8" (860)					
44 1/2" (1130) 46" (1168) 42 3/4" (1086) 42" (1067) 35 7/8" (911)					
50 1/2" (1283) 52" (1321) 48 3/4" (1238) 48" (1219) 41 7/8" (1064)					
56 1/2" (1435) 58" (1473) 54 3/4" (1391) 54" (1372) 47 7/8" (1216)					
58 1/2" (1486) 60" (1524) 56 3/4" (1441) 56" (1422) 49 7/8" (1267)					
62 1/2" (1588) 64" (1626) 60 3/4" (1543) 60" (1524) 53 7/8" (1368)					
66 1/2" (1689) 68" (1727) 64 3/4" (1645) 64" (1626) 57 7/8" (1470)					

ELEVATION SYMBOL LEGEND:

M.O. = MASONRY OPENING
VALUES IN () ARE IN MILLIMETER CONVERSIONS.
##* NUMBER INDICATES DESIGN PRESSURE (DP) RATING WITH STANDARD GLAZING.
S STATIONARY UNIT.

Note: Elevations shown DO NOT have exterior trim. Subtract 1/2" (12.7) from M.O. (Masonry Opening) for Unit Sizes. Masonry Openings above include Sill Nose, see Trim Options page for Sill Nose specifications. For other Trim Options refer to the Unit Sizing, Rough Opening & Masonry Openings page.

SCALE: 1/8" = 1'

EXTENDED QUARTER ROUND UNITS

	M.O. BRICKMOULD M.O. ADAMS/FLAT CASING	21 1/4" (540)	23 1/4" (591)	27 1/4" (692)	31 1/4" (794)	33 1/4" (845)
	ROUGH OPENING	24 5/16" (618)	26 5/16" (668)	30 5/16" (770)	34 5/16" (872)	36 5/16" (922)
	FRAME SIZE	18 3/4" (476)	20 3/4" (527)	24 3/4" (629)	28 3/4" (730)	30 3/4" (781)
	DAYLIGHT OPENING	18" (457)	20" (508)	24" (610)	28" (711)	30" (762)
		11 7/8" (302)	13 7/8" (352)	17 7/8" (454)	21 7/8" (556)	23 7/8" (607)
68 1/2" (1740)						
70" (1778)						
66 3/4" (1695)						
59 7/8" (1520)						
		CCECQ1866	CCECQ2066	CCECQ2466	CCECQ2866	CCECQ3066
74 1/2" (1892)						
76" (1930)						
72 3/4" (1848)						
72" (1829)						
65 7/8" (1673)						
		CCECQ1872	CCECQ2072	CCECQ2472	CCECQ2872	CCECQ3072
80 1/2" (2045)						
82" (2083)						
78 3/4" (2000)						
78" (1981)						
71 7/8" (1826)						
		CCECQ1878	CCECQ2078	CCECQ2478	CCECQ2878	CCECQ3078
86 1/2" (2197)						
88" (2235)						
84 3/4" (2153)						
84" (2134)						
77 7/8" (1978)						
		CCECQ1884	CCECQ2084	CCECQ2484	CCECQ2884	CCECQ3084

ELEVATION SYMBOL LEGEND:
M.O. = MASONRY OPENING
 VALUES IN () ARE IN MILLIMETER CONVERSIONS.
= NUMBER INDICATES DESIGN PRESSURE (DP) RATING WITH STANDARD GLAZING.
S = STATIONARY UNIT.
LO = LIMITED OPERATION.

Note: Elevations shown DO NOT have exterior trim. Subtract 1/2" (12.7) from M.O. (Masonry Opening) for Unit Sizes. Masonry Openings above include Sill Nose, see Trim Options page for Sill Nose specifications. For other Trim Options refer to the Unit Sizing, Rough Opening & Masonry Openings page.

**GLAZING OPTIONS
CASEMENT**

INTERIOR GLAZED
INSULATED 3/4" [19] GLASS

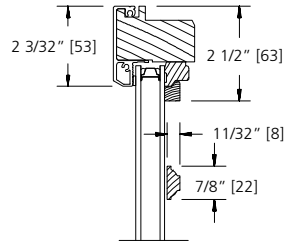

7/8" GRILLE BAR

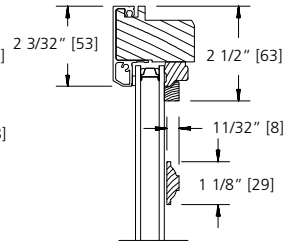

1 1/8" GRILLE BAR

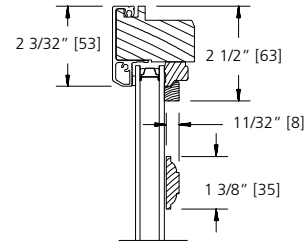

1 3/8" GRILLE BAR

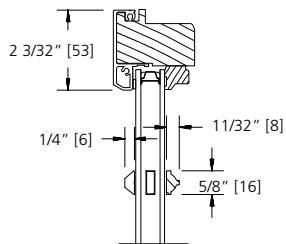

**5/8" SDL BAR
(PUTTY/BEAD)**

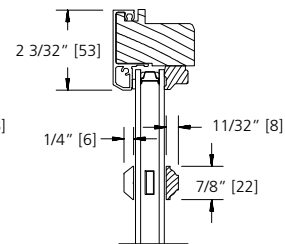

**7/8" SDL BAR
(PUTTY/BEAD)**

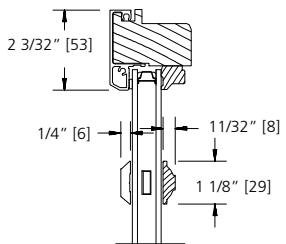

**1 1/8" SDL BAR
(PUTTY/BEAD)**

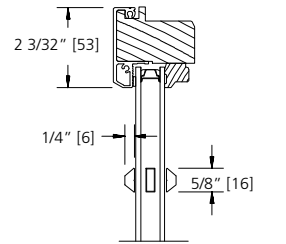

**5/8" SDL BAR
(PUTTY/PUTTY)**

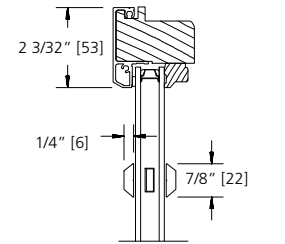

**7/8" SDL BAR
(PUTTY/PUTTY)**

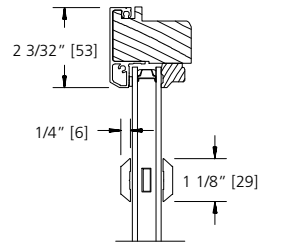

**1 1/8" SDL BAR
(PUTTY/PUTTY)**

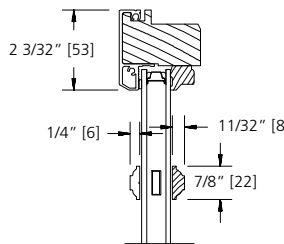

**7/8" SDL BAR
(BEAD STOP)**

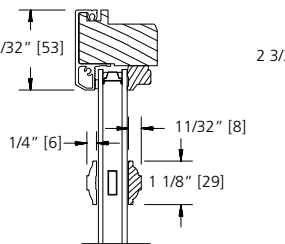

**1 1/8" SDL BAR
(BEAD STOP)**

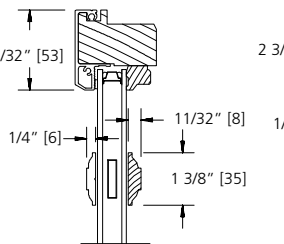

**1 3/8" SDL BAR
(BEAD STOP)**

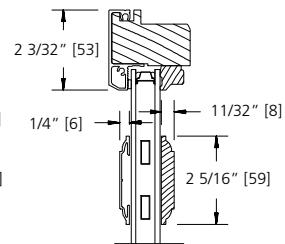

**2 5/16" SDL BAR
(BEAD STOP)**

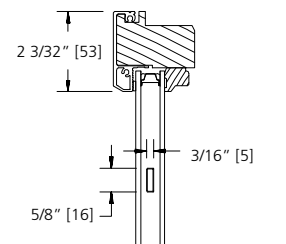

**5/8" FLAT
GBG**

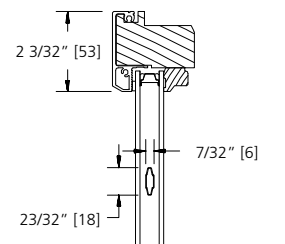

**23/32" CONTOUR
GBG**

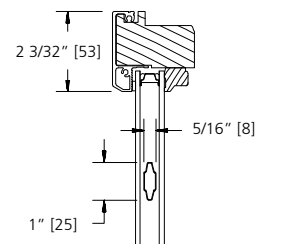

**1" CONTOUR
GBG**

SCALE: NTS

**GLAZING OPTIONS
CASEMENT**

INTERIOR GLAZED
SINGLE GLAZED 1/8" [3] GLASS

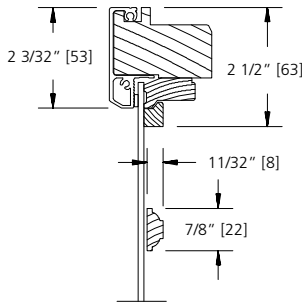

7/8" GRILLE BAR

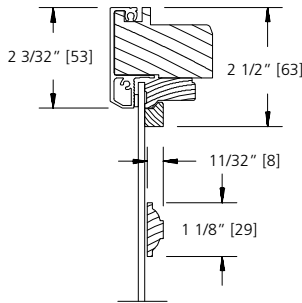

1 1/8" GRILLE BAR

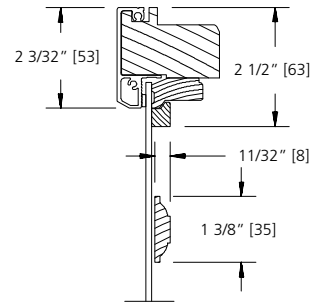

1 3/8" GRILLE BAR

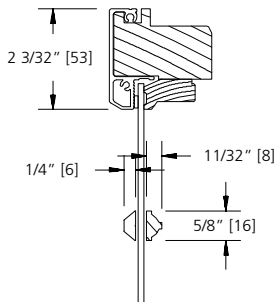

**5/8" SDL
(PUTTY/BEAD)**

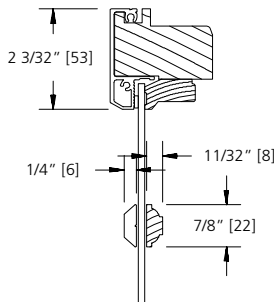

**7/8" SDL
(PUTTY/BEAD)**

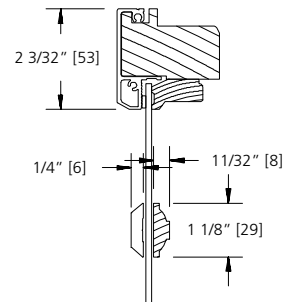

**1 1/8" SDL
(PUTTY/BEAD)**

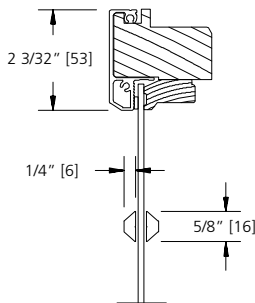

**5/8" SDL
(PUTTY/PUTTY)**

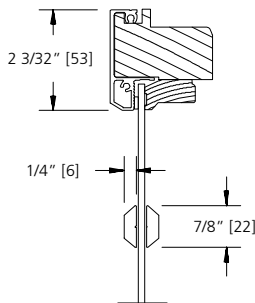

**7/8" SDL
(PUTTY/PUTTY)**

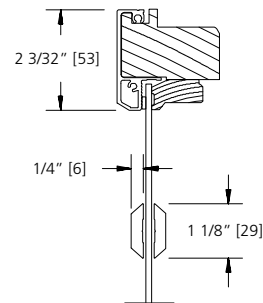

**1 1/8" SDL
(PUTTY/PUTTY)**

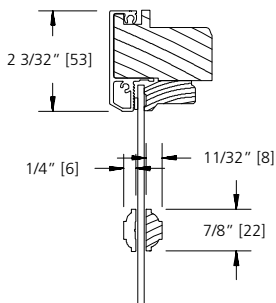

**7/8" SDL
(BEAD STOP)**

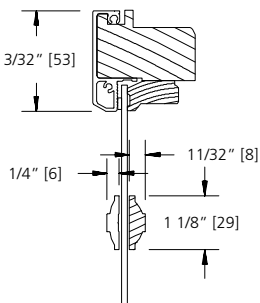

**1 1/8" SDL
(BEAD STOP)**

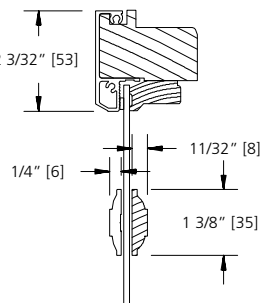

**1 3/8" SDL
(BEAD STOP)**

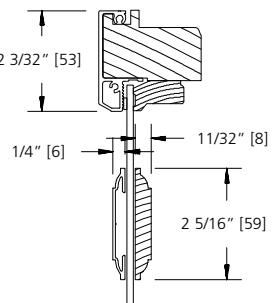

**2 5/16" SDL BAR
(BEAD STOP)**

SCALE: 3" = 1'

**GLAZING OPTIONS
CASEMENT**

INTERIOR GLAZED
IMPACT RESISTANT GLASS

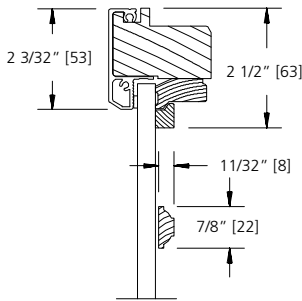

7/8" GRILLE BAR

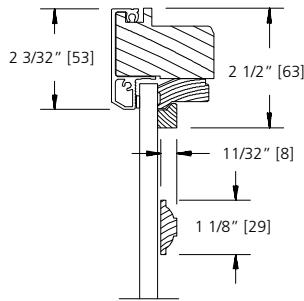

1 1/8" GRILLE BAR

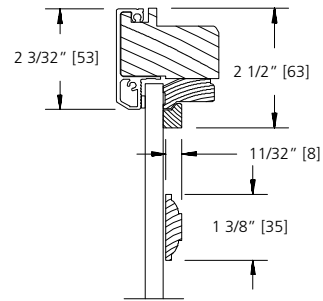

1 3/8" GRILLE BAR

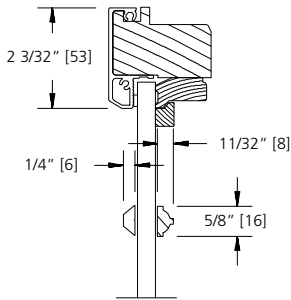

**5/8" SDL
(PUTTY/BEAD)**

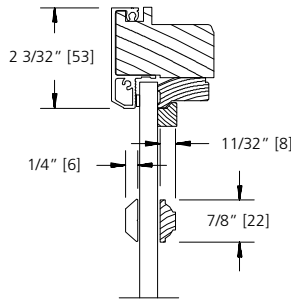

**7/8" SDL
(PUTTY/BEAD)**

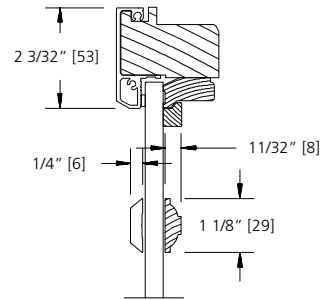

**1 1/8" SDL
(PUTTY/BEAD)**

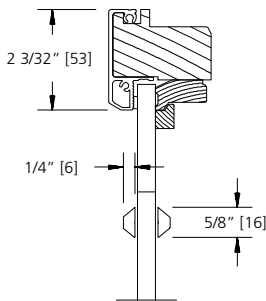

**5/8" SDL
(PUTTY/PUTTY)**

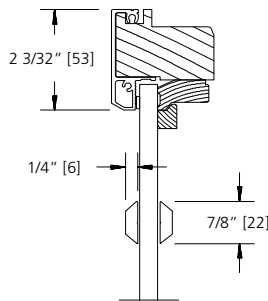

**7/8" SDL
(PUTTY/PUTTY)**

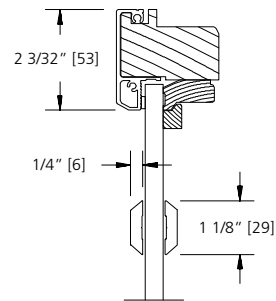

**1 1/8" SDL
(PUTTY/PUTTY)**

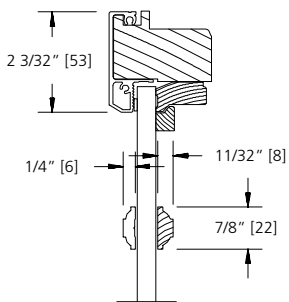

**7/8" SDL
(BEAD STOP)**

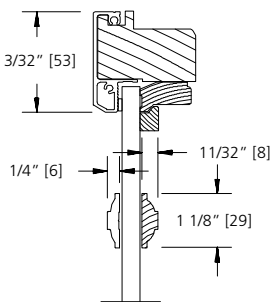

**1 1/8" SDL
(BEAD STOP)**

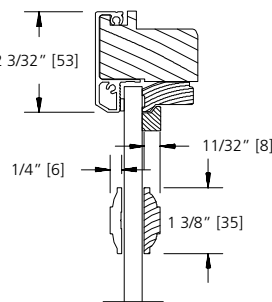

**1 3/8" SDL
(BEAD STOP)**

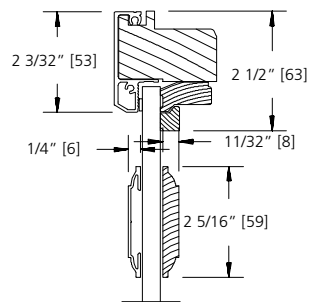

**2 5/16" SDL BAR
(BEAD STOP)**

SCALE: 3" = 1'

GLAZING OPTIONS
STATIONARY CASEMENT

INTERIOR GLAZED
INSULATED 3/4" [19] GLASS

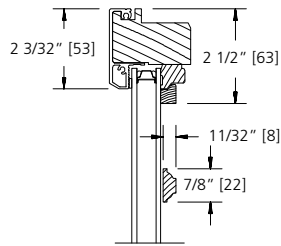

7/8" GRILLE BAR

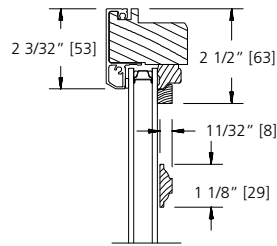

1 1/8" GRILLE BAR

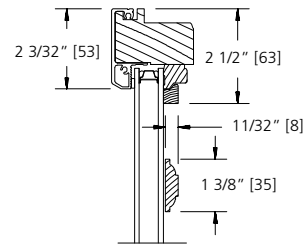

1 3/8" GRILLE BAR

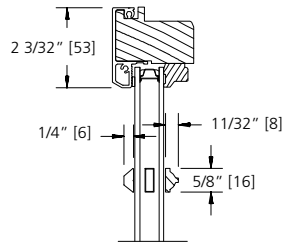

**5/8" SDL BAR
(PUTTY/BEAD)**

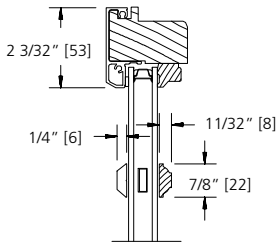

**7/8" SDL BAR
(PUTTY/BEAD)**

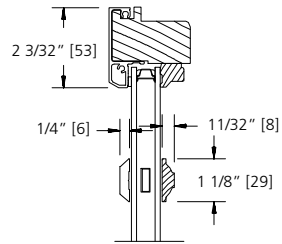

**1 1/8" SDL BAR
(PUTTY/BEAD)**

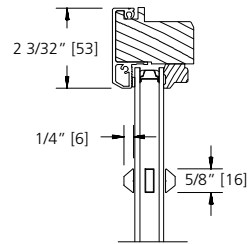

**5/8" SDL BAR
(PUTTY/PUTTY)**

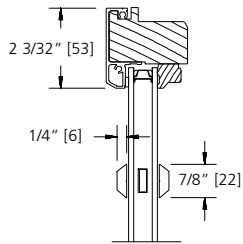

**7/8" SDL BAR
(PUTTY/PUTTY)**

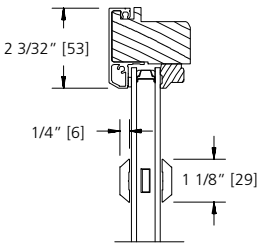

**1 1/8" SDL BAR
(PUTTY/PUTTY)**

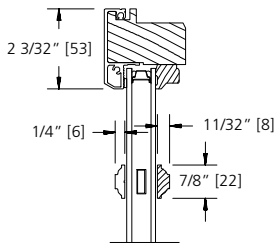

**7/8" SDL BAR
(BEAD STOP)**

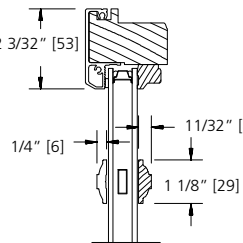

**1 1/8" SDL BAR
(BEAD STOP)**

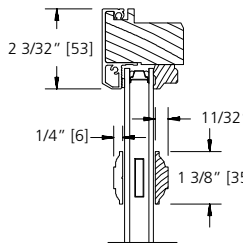

**1 3/8" SDL BAR
(BEAD STOP)**

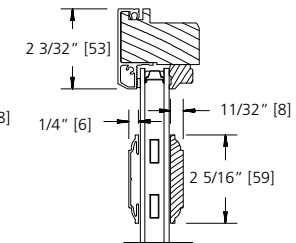

**2 5/16" SDL BAR
(BEAD STOP)**

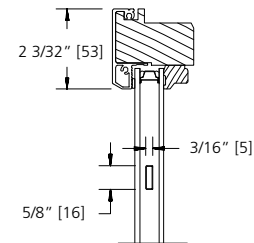

**5/8" FLAT
GBG**

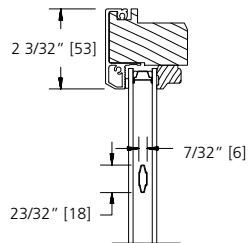

**23/32" CONTOUR
GBG**

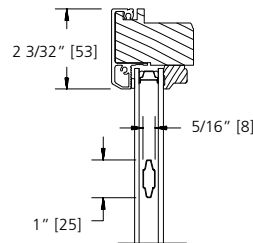

**1" CONTOUR
GBG**

SCALE: NTS

**GLAZING OPTIONS
STATIONARY CASEMENT**

INTERIOR GLAZED
SINGLE GLAZED 1/8" [3] GLASS

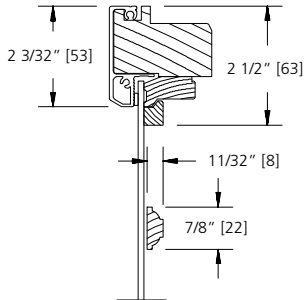

7/8" GRILLE BAR

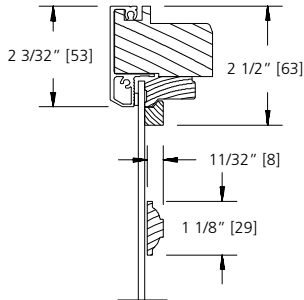

1 1/8" GRILLE BAR

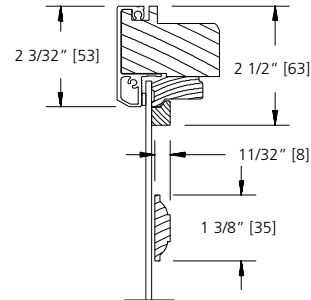

1 3/8" GRILLE BAR

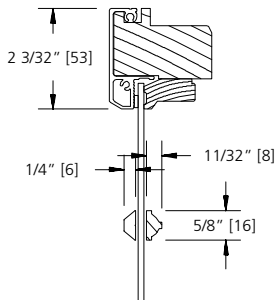

**5/8" SDL
(PUTTY/BEAD)**

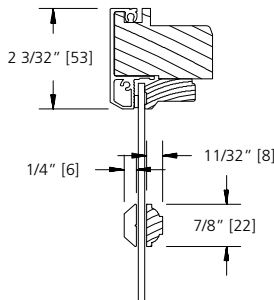

**7/8" SDL
(PUTTY/BEAD)**

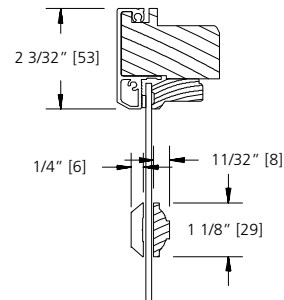

**1 1/8" SDL
(PUTTY/BEAD)**

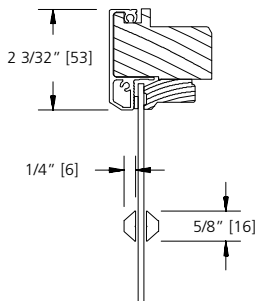

**5/8" SDL
(PUTTY/PUTTY)**

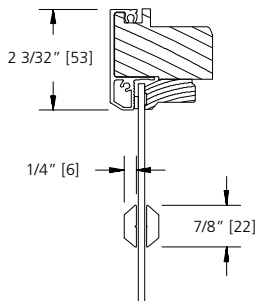

**7/8" SDL
(PUTTY/PUTTY)**

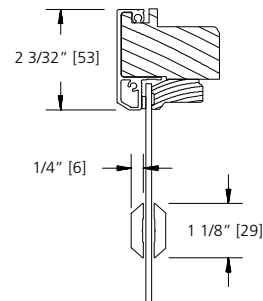

**1 1/8" SDL
(PUTTY/PUTTY)**

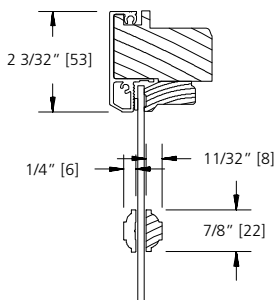

**7/8" SDL
(BEAD STOP)**

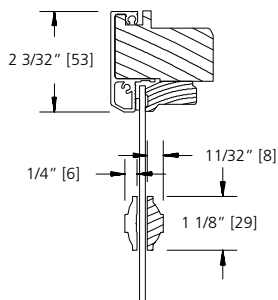

**1 1/8" SDL
(BEAD STOP)**

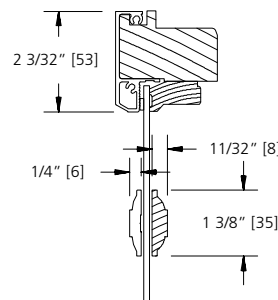

**1 3/8" SDL
(BEAD STOP)**

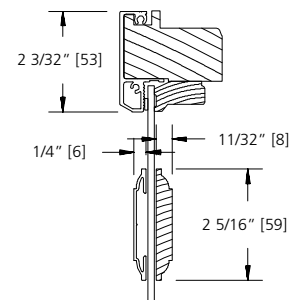

**2 5/16" SDL BAR
(BEAD STOP)**

SCALE: 3" = 1'

**GLAZING OPTIONS
STATIONARY CASEMENT**

**INTERIOR GLAZED
IMPACT RESISTANT GLASS**

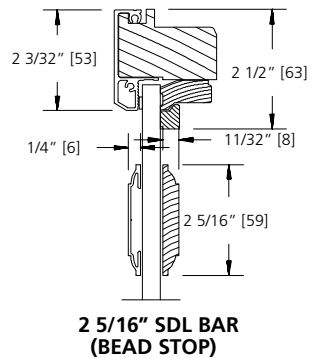
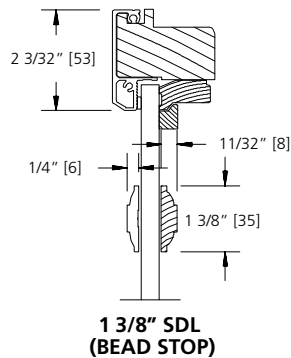
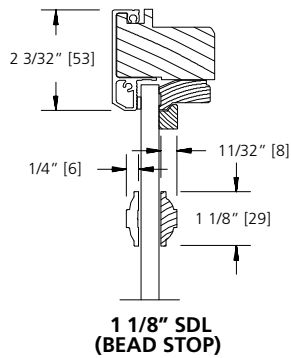
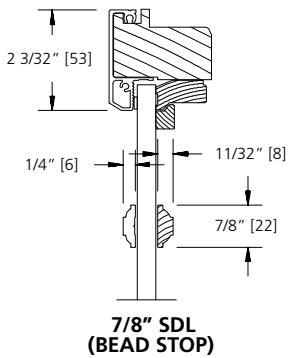
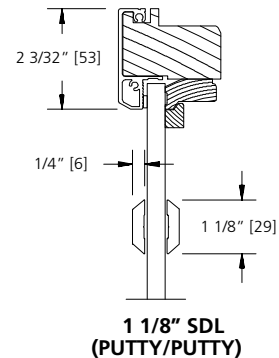
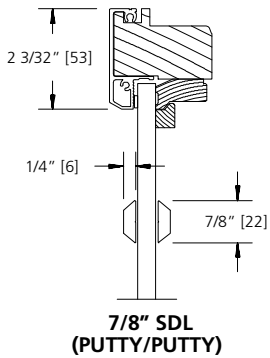
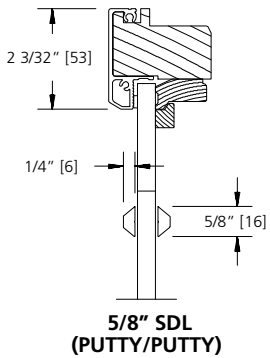
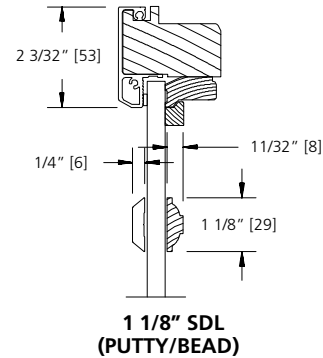
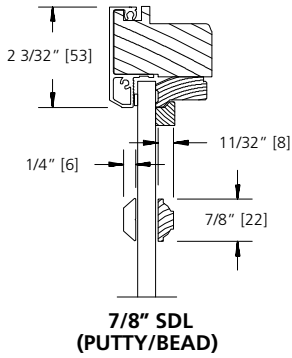
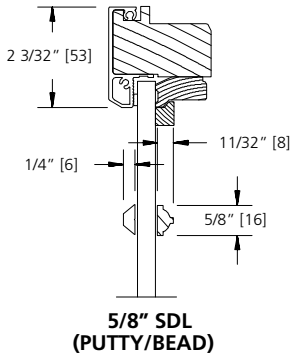
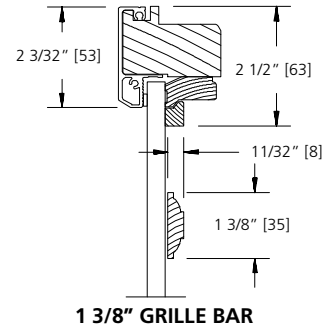
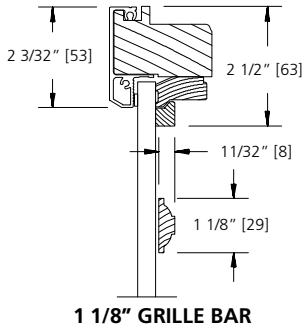
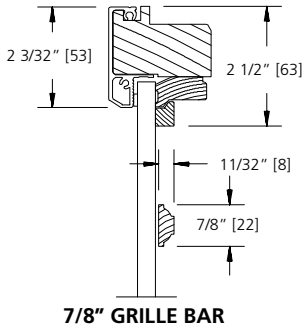

SCALE: 3" = 1'

GLAZING OPTIONS
SECTOR TOP CASEMENT

INTERIOR GLAZED
INSULATED 15/16" [24] GLASS

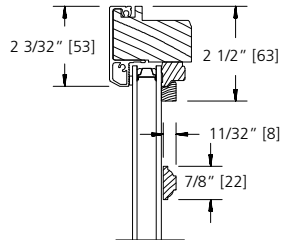

7/8" GRILLE BAR

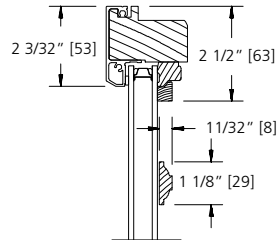

1 1/8" GRILLE BAR

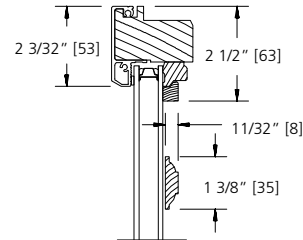

1 3/8" GRILLE BAR

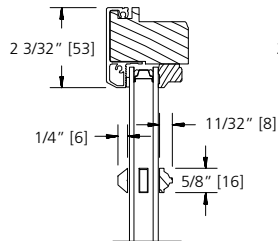

**5/8" SDL BAR
(PUTTY/BEAD)**

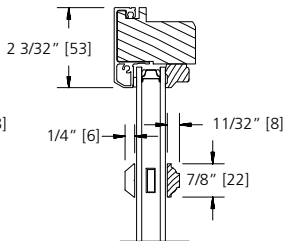

**7/8" SDL BAR
(PUTTY/BEAD)**

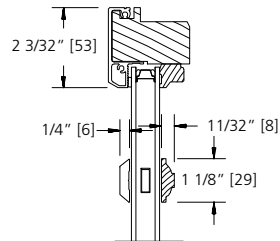

**1 1/8" SDL BAR
(PUTTY/BEAD)**

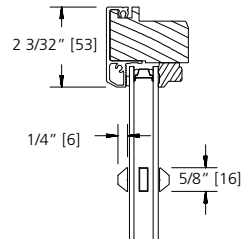

**5/8" SDL BAR
(PUTTY/PUTTY)**

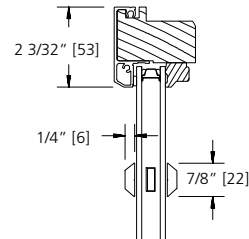

**7/8" SDL BAR
(PUTTY/PUTTY)**

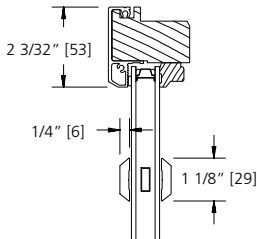

**1 1/8" SDL BAR
(PUTTY/PUTTY)**

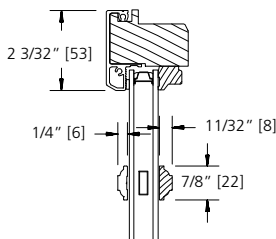

**7/8" SDL BAR
(BEAD STOP)**

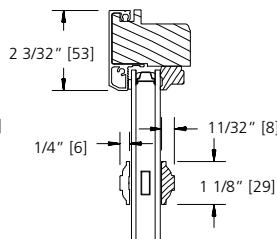

**1 1/8" SDL BAR
(BEAD STOP)**

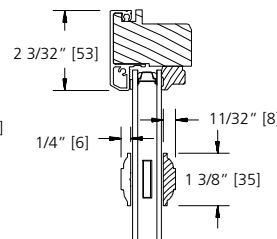

**1 3/8" SDL BAR
(BEAD STOP)**

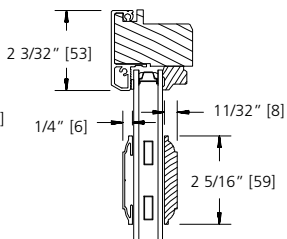

**2 5/16" SDL BAR
(BEAD STOP)**

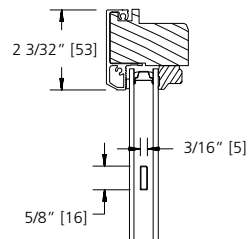

**5/8" FLAT
GBG**

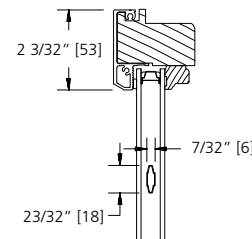

**23/32" CONTOUR
GBG**

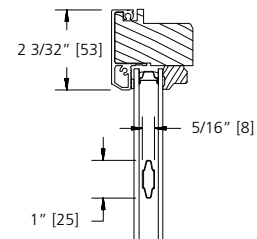

**1" CONTOUR
GBG**

SCALE: NTS

GLAZING OPTIONS
SECTOR TOP CASEMENT

INTERIOR GLAZED
SINGLE GLAZED 1/8" [3] GLASS

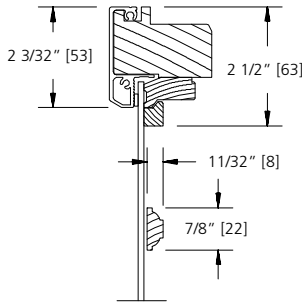

7/8" GRILLE BAR

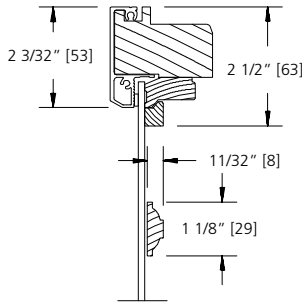

1 1/8" GRILLE BAR

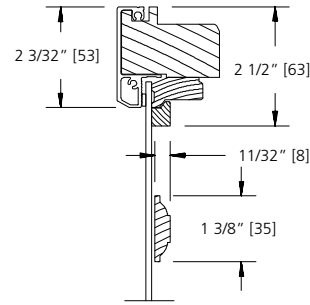

1 3/8" GRILLE BAR

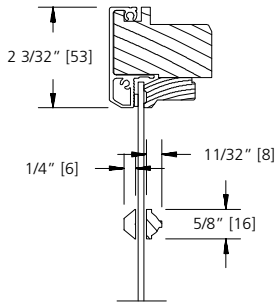

**5/8" SDL
(PUTTY/BEAD)**

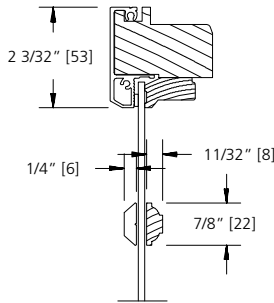

**7/8" SDL
(PUTTY/BEAD)**

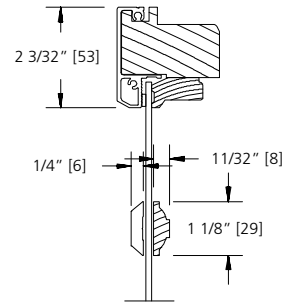

**1 1/8" SDL
(PUTTY/BEAD)**

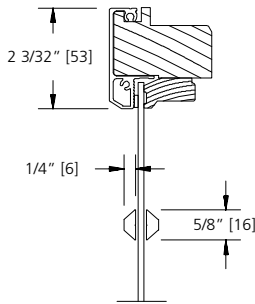

**5/8" SDL
(PUTTY/PUTTY)**

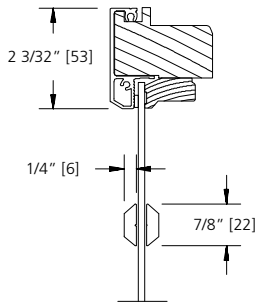

**7/8" SDL
(PUTTY/PUTTY)**

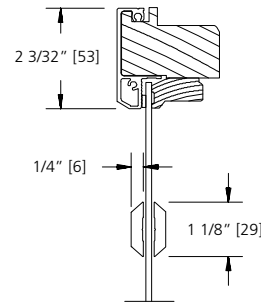

**1 1/8" SDL
(PUTTY/PUTTY)**

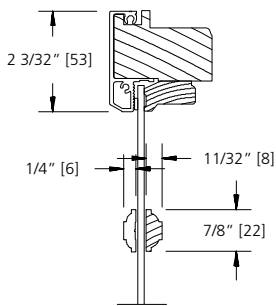

**7/8" SDL
(BEAD STOP)**

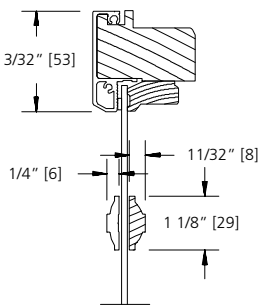

**1 1/8" SDL
(BEAD STOP)**

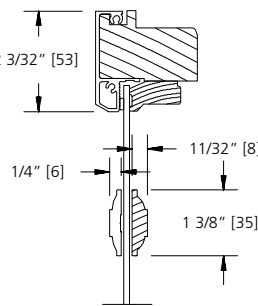

**1 3/8" SDL
(BEAD STOP)**

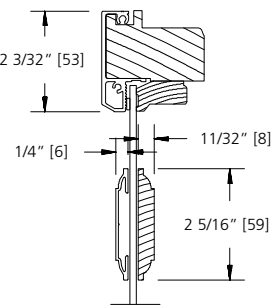

**2 5/16" SDL BAR
(BEAD STOP)**

SCALE: 3" = 1'

**GLAZING OPTIONS
SECTOR TOP CASEMENT**

INTERIOR GLAZED
IMPACT RESISTANT GLASS

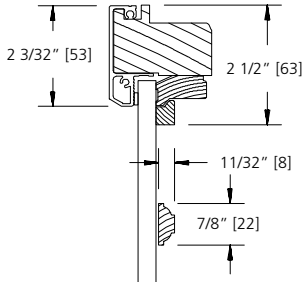

7/8" GRILLE BAR

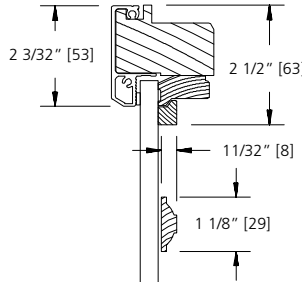

1 1/8" GRILLE BAR

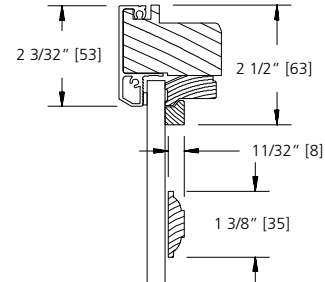

1 3/8" GRILLE BAR

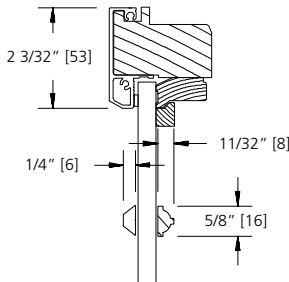

**5/8" SDL
(PUTTY/BEAD)**

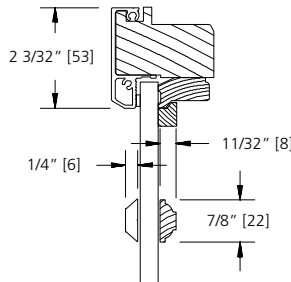

**7/8" SDL
(PUTTY/BEAD)**

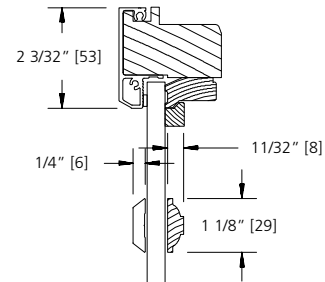

**1 1/8" SDL
(PUTTY/BEAD)**

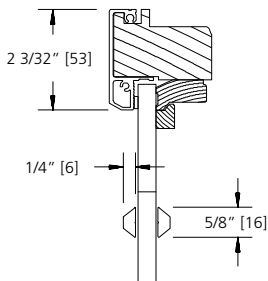

**5/8" SDL
(PUTTY/PUTTY)**

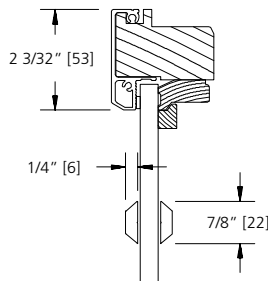

**7/8" SDL
(PUTTY/PUTTY)**

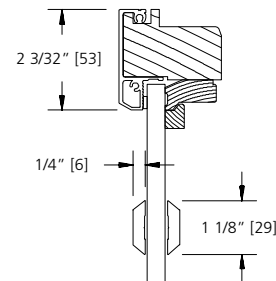

**1 1/8" SDL
(PUTTY/PUTTY)**

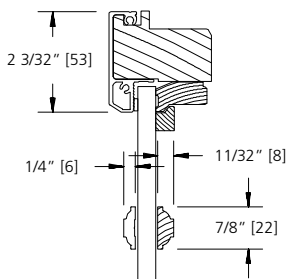

**7/8" SDL
(BEAD STOP)**

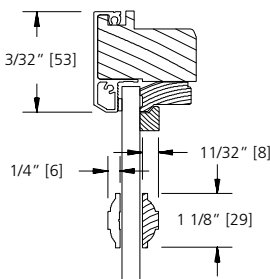

**1 1/8" SDL
(BEAD STOP)**

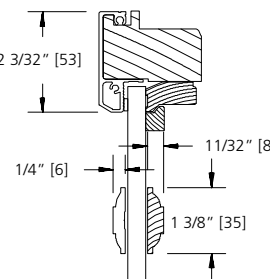

**1 3/8" SDL
(BEAD STOP)**

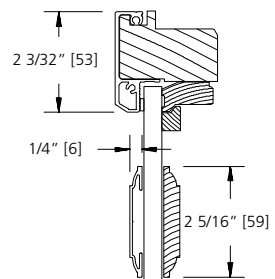

**2 5/16" SDL BAR
(BEAD STOP)**

SCALE: 3" = 1'

**TRIM OPTIONS
CASEMENT**

EXTERIOR TRIM

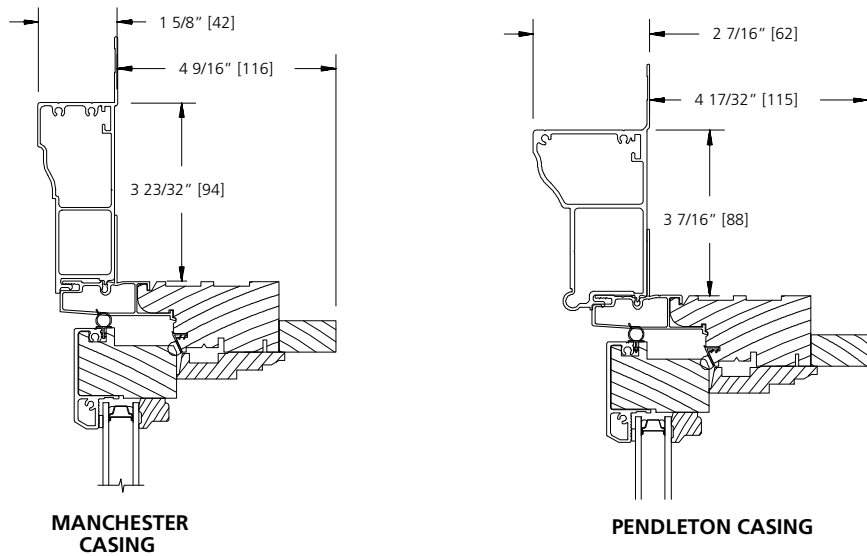
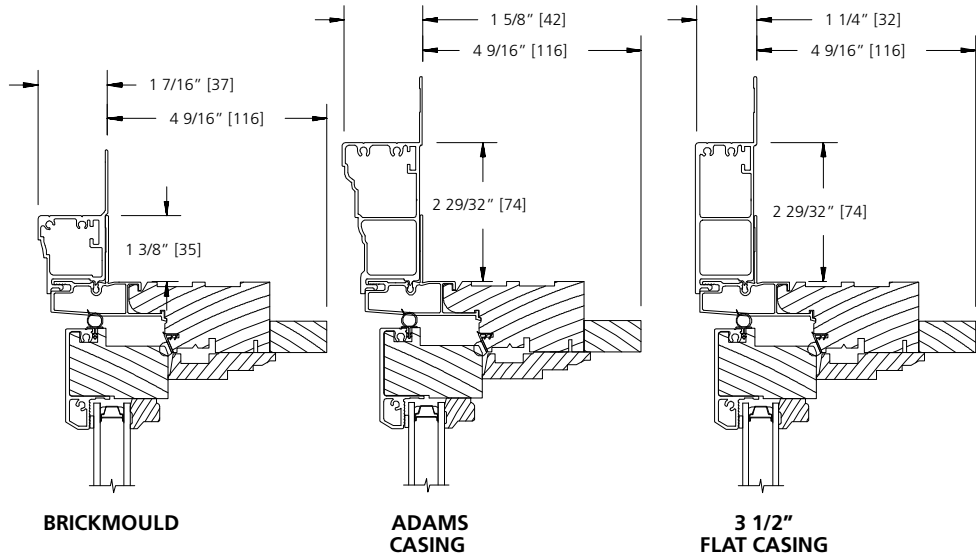

SILL NOSE OPTIONS

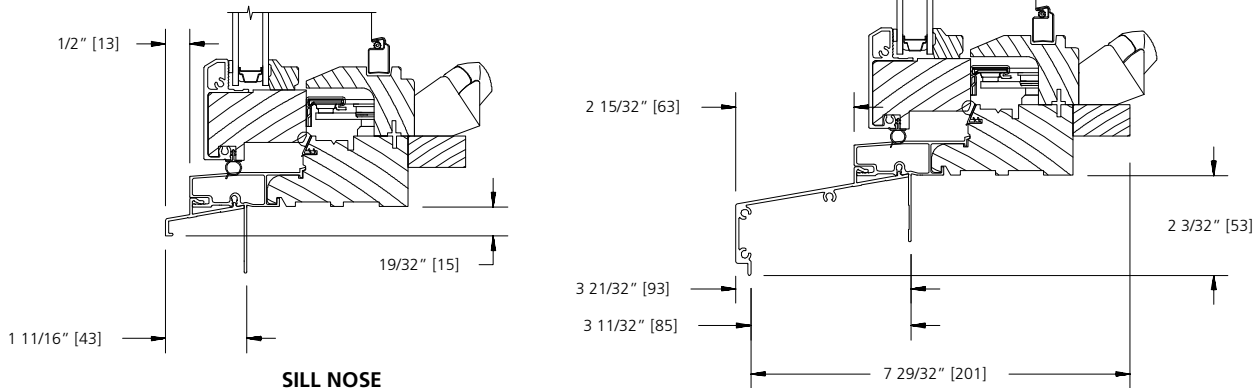

SILL NOSE CAN BE USED WITH
ADAMS CASING, 3 1/2" FLAT
CASING, AND BRICKMOULD.

SCALE: 3" = 1'

**TRIM OPTIONS
STATIONARY CASEMENT**

EXTERIOR TRIM

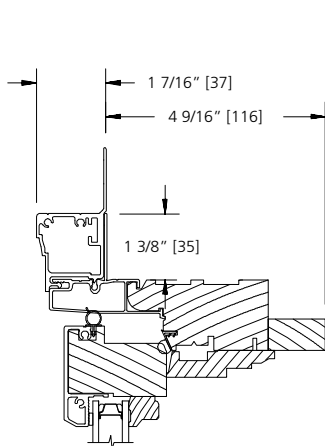

BRICKMOULD

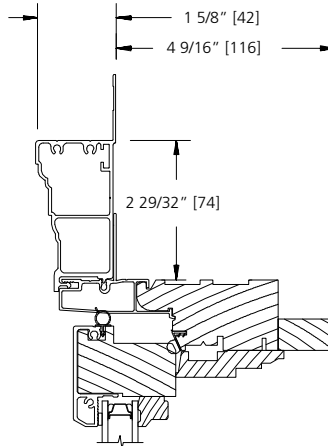

ADAMS CASING

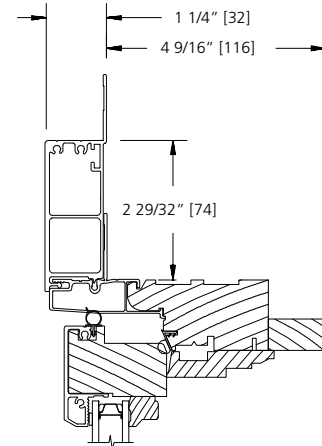

3 1/2" FLAT CASING

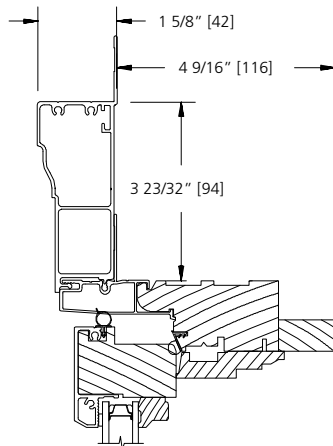

MANCHESTER CASING

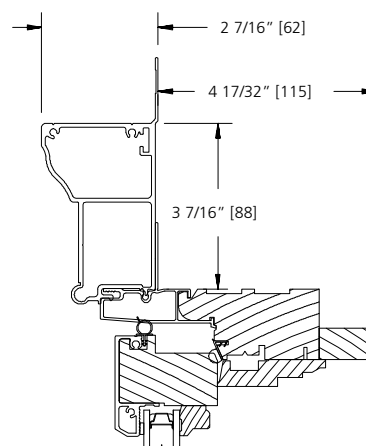

PENDLETON CASING

SILL NOSE OPTIONS

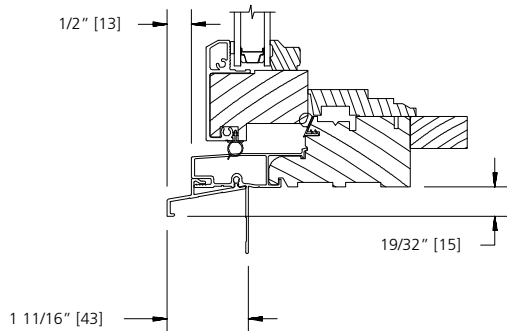

SILL NOSE

SILL NOSE CAN BE USED WITH
ADAMS CASING, 3 1/2" FLAT
CASING, AND BRICKMOULD.

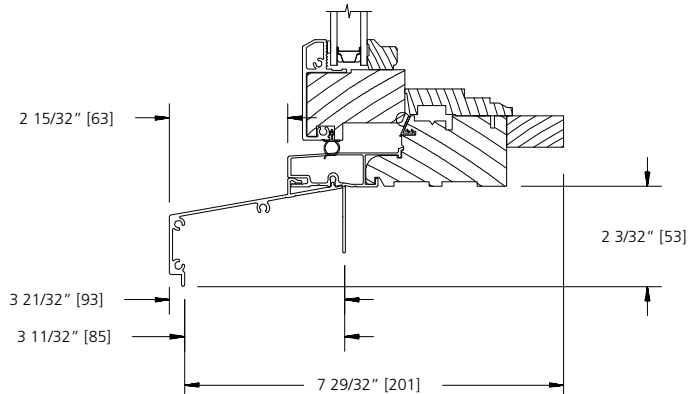

EXTENDED SILL NOSE

SCALE: 3" = 1'

**TRIM OPTIONS
SECTOR TOP CASEMENT**

TRIM OPTIONS NOTE:
JAMB EXTENDERS & SILL OPTIONS ARE
CONSISTENT WITH CUSTOM CLAD CASEMENT
(STRAIGHTLINE).

EXTERIOR TRIM

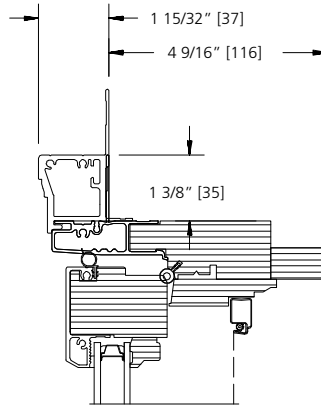

BRICKMOULD

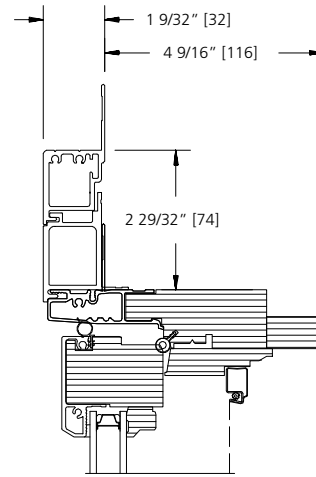

3 1/2\"/>

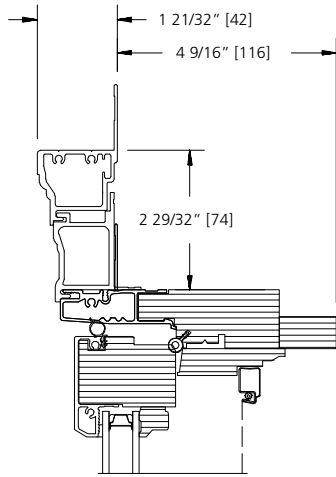

**ADAMS
CASING**

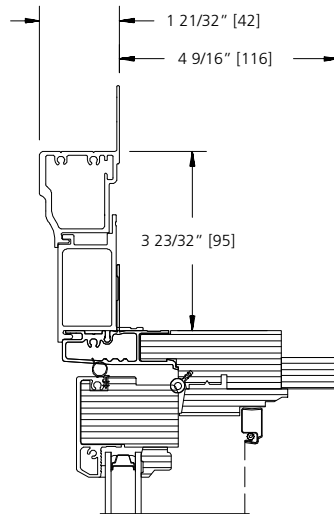

**MANCHESTER
CASING**

SCALE: 3" = 1'

STANDARD MULLION DETAILS

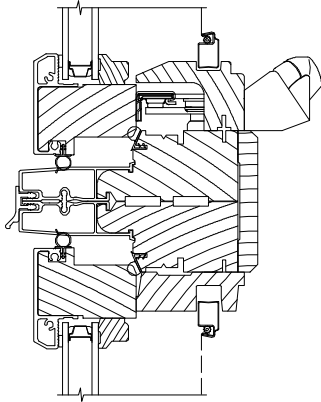

OPERATOR TO OPERATOR

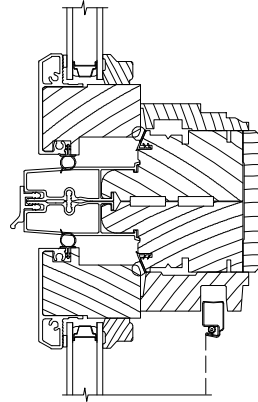

OPERATOR TO FIXED

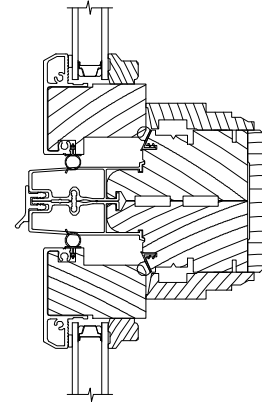

FIXED TO FIXED

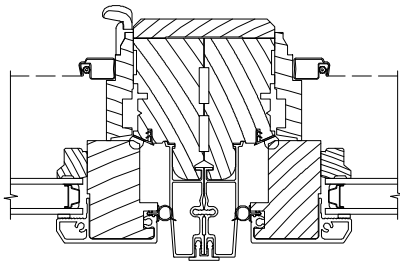

OPERATOR TO OPERATOR

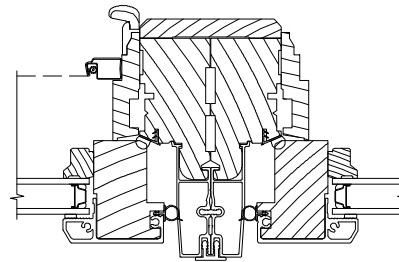

OPERATOR TO FIXED

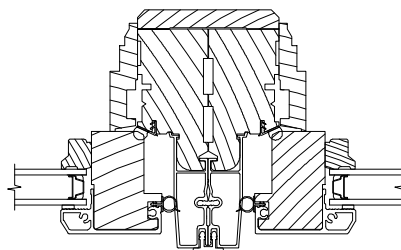

FIXED TO FIXED

SCALE: 3" = 1'

LITE CUT INFORMATION
CASEMENT & STATIONARY

Clad Epic casement windows are available with removable grilles in 7/8", 1-1/8", and 1-3/8" widths, grids between the glass and Simulated Divided Lites. Standard lite cuts are rectangular.

LITE CUT OPTIONS

Special lite cut patterns can include a wide variety of straight line and radius patterns. The illustrations shown here represent just a few of the possibilities. Rectangular, horizontal, vertical and Prairie lite patterns are available in all standard size clad casement windows. Uneven, diamond, radius and Gothic lite cuts are available, subject to approval. Approvals are based on the ability to fulfill the design requirement while maintaining the construction integrity of the finished product.

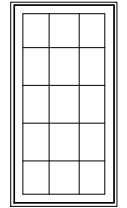

RECTANGULAR

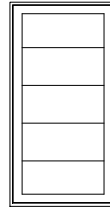

HORIZONTAL

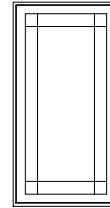

PRAIRIE

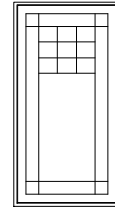

UNEVEN

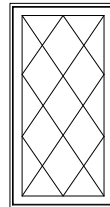

DIAMOND

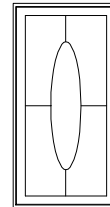

RADIUS

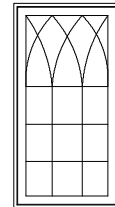

GOTHIC

BAR ALIGNMENT

Alignment of divided lite muntin bars from one window to the next is often required by fine architectural design. Wood grilles, Grids Between the Glass and Simulated Divided Lites may be specified with muntin bars aligned.

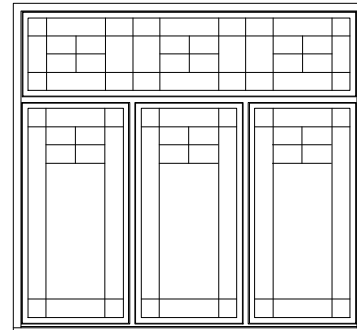

**UNIT SIZING, ROUGH OPENINGS
& MASONRY OPENINGS
CASEMENT**

STANDARD OFFERING

DRIP CAP & FOLDING NAILING FLANGE

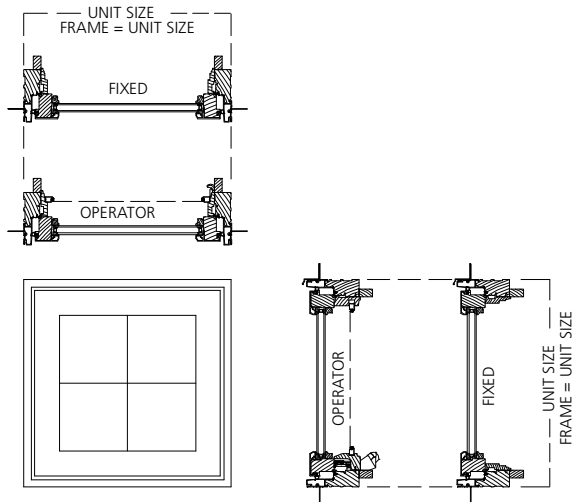

GENERAL NOTES:

UNITS WITH NO TRIM AND SILL NOSE:
UNIT SIZE = FRAME SIZE

UNIT SIZE IS ALWAYS THE
EXTREME SIZE OF THE WINDOW
WITH OR WITHOUT TRIM
(DRIP CAP & NAILING FLANGE ARE
NOT ADDED TO ANY UNIT SIZING)

MASONRY OPENING:

MASONRY OPENING IS ALWAYS 3/4" OVER
THE UNIT SIZE OF THE WINDOW

ROUGH OPENING:

ROUGH OPENING IS ALWAYS 3/4" OVER
FRAME SIZE OF THE WINDOW

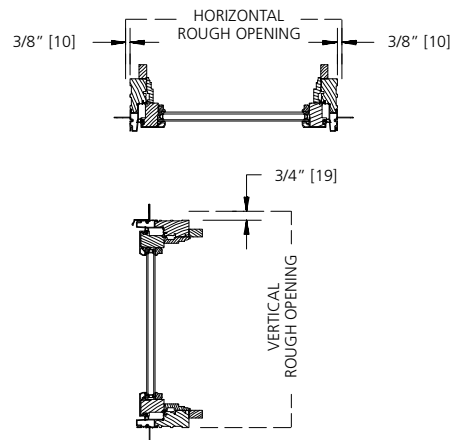

NON-STANDARD UNIT SIZING

EXTERIOR TRIM OFFERINGS WITH SILL NOSE

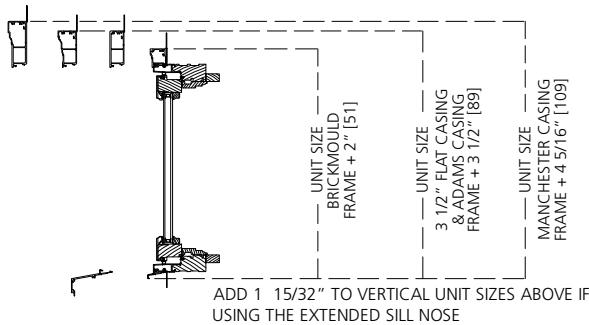

EXTERIOR TRIM OFFERINGS WITHOUT SILL NOSE
EXTERIOR TRIM ON ALL 4 SIDES

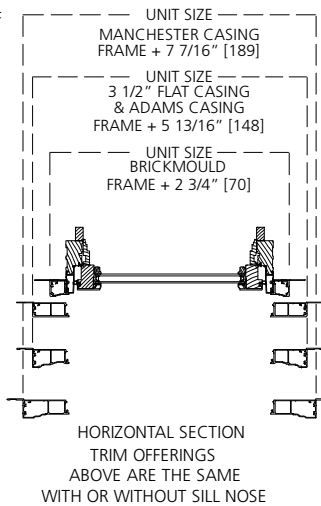
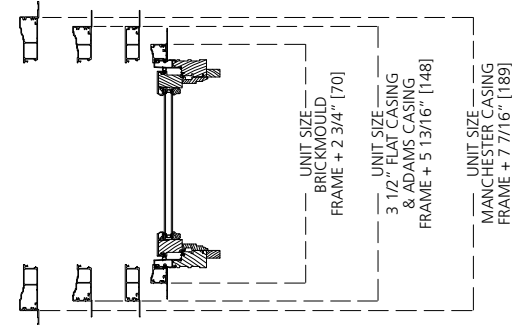

**FRAME TO TRIM
DIMENSIONS**

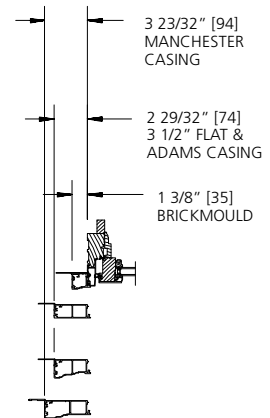

TYPICAL FOR HEAD, SILL & SIDE

**UNIT SIZING, ROUGH OPENINGS
& MASONRY OPENINGS
STATIONARY CASEMENT**

STANDARD OFFERING

DRIP CAP & FOLDING NAILING FLANGE

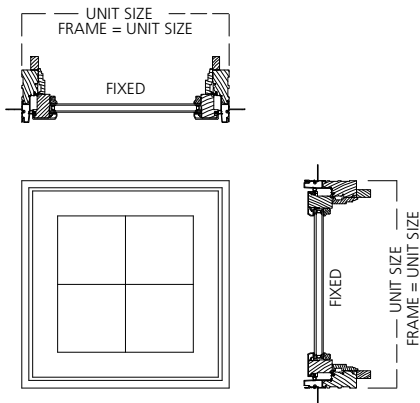

GENERAL NOTES:

UNITS WITH NO TRIM AND SILL NOSE:
UNIT SIZE = FRAME SIZE

UNIT SIZE IS ALWAYS THE
EXTREME SIZE OF THE WINDOW
WITH OR WITHOUT TRIM
(DRIP CAP & NAILING FLANGE ARE
NOT ADDED TO ANY UNIT SIZING)

MASONRY OPENING:

MASONRY OPENING IS ALWAYS 3/4" OVER
THE UNIT SIZE OF THE WINDOW

ROUGH OPENING:

ROUGH OPENING IS ALWAYS 3/4" OVER
FRAME SIZE OF THE WINDOW

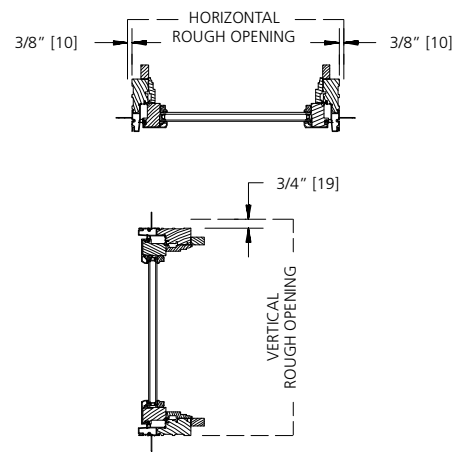

NON-STANDARD UNIT SIZING

EXTERIOR TRIM OFFERINGS WITH SILL NOSE

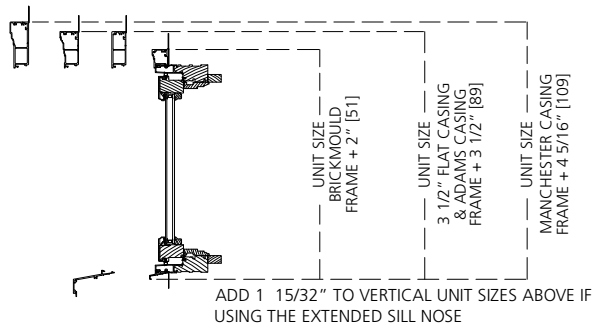

EXTERIOR TRIM OFFERINGS WITHOUT SILL NOSE
EXTERIOR TRIM ON ALL 4 SIDES

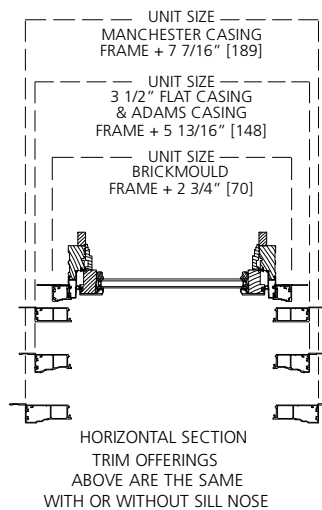
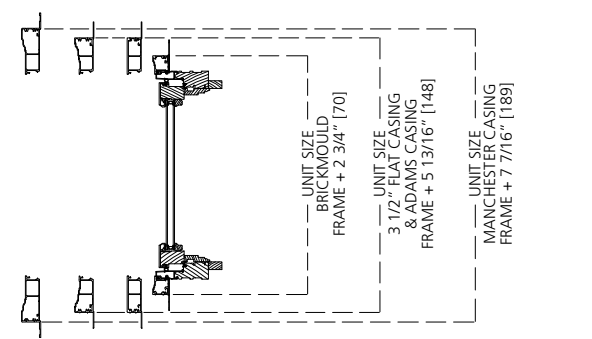

FRAME TO TRIM DIMENSIONS

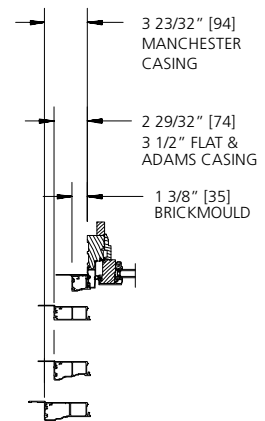

TYPICAL FOR HEAD, SILL & SIDE

1-WIDE UNIT

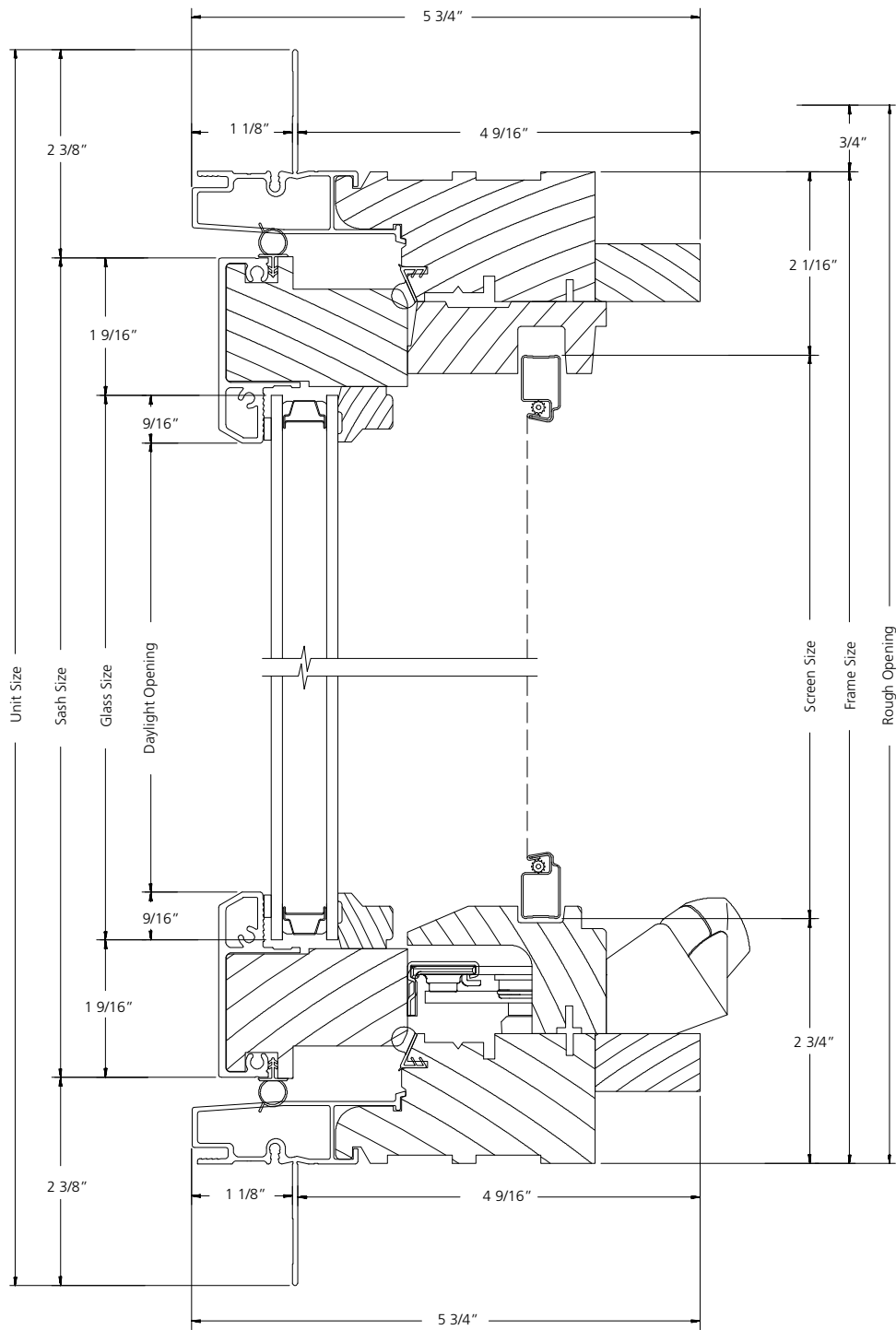

VERTICAL SECTION

SCALE: 6" = 1'

1-WIDE UNIT

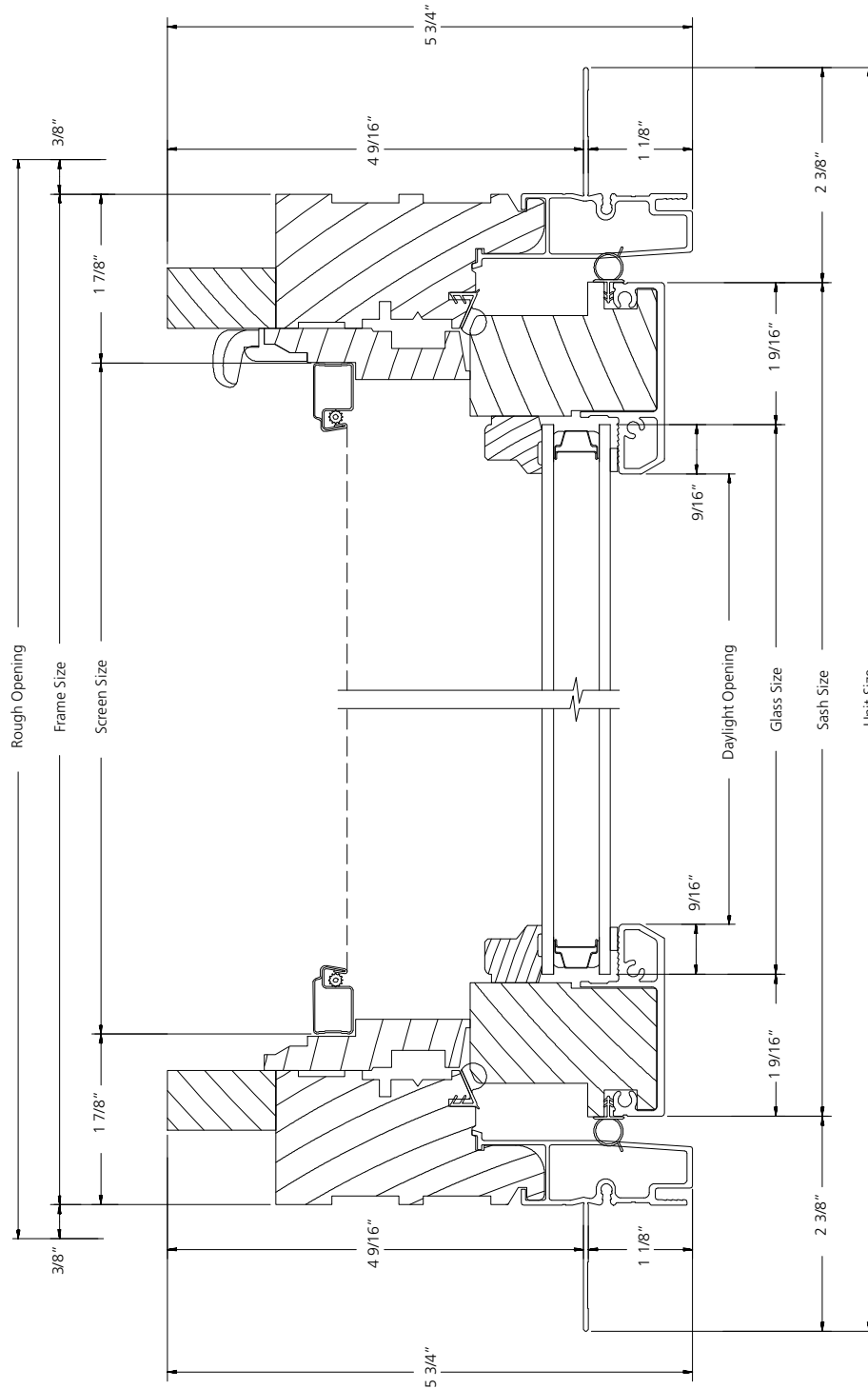

HORIZONTAL SECTION

PICTURE UNIT

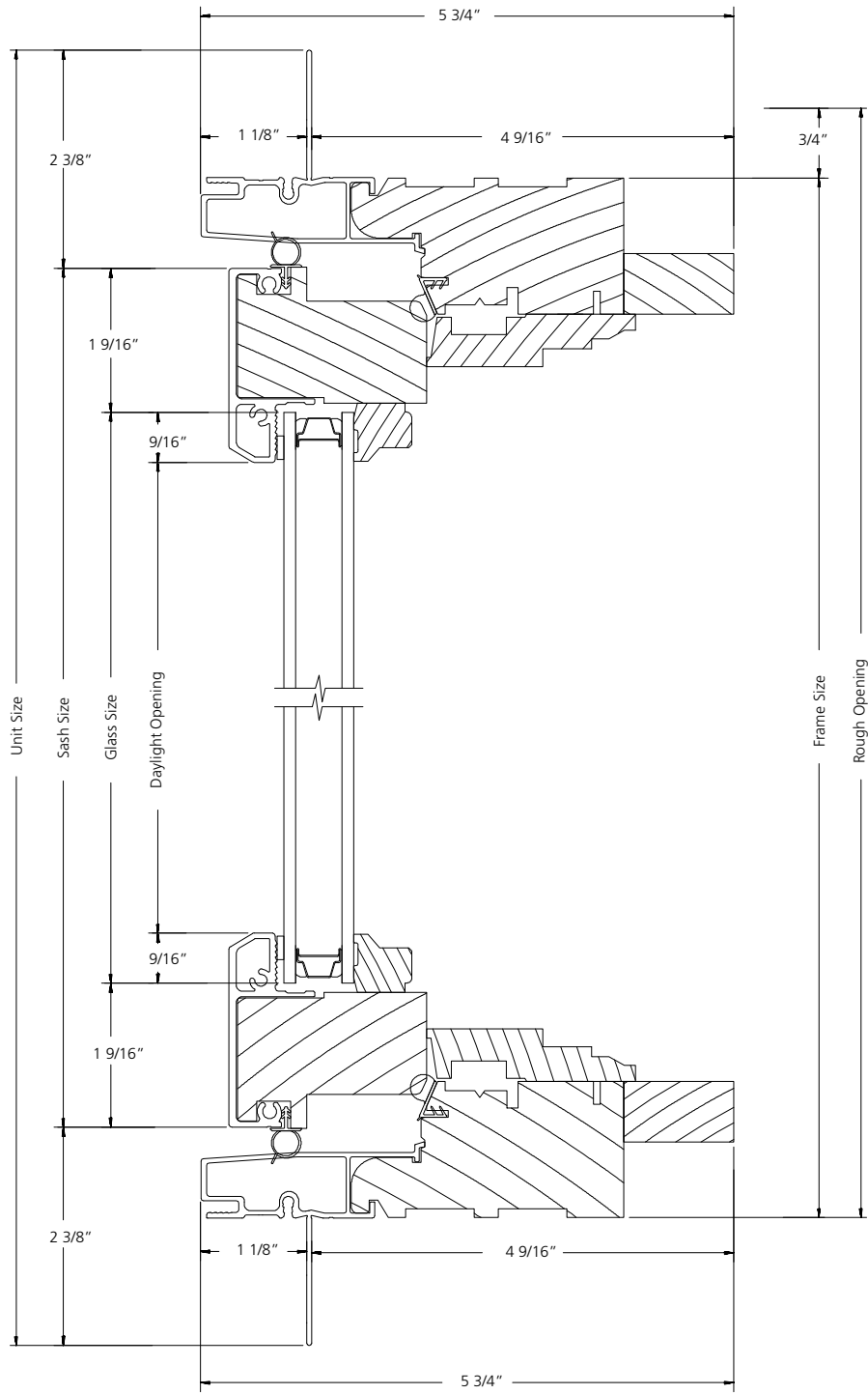

VERTICAL SECTION

SCALE: 6" = 1'

PICTURE UNIT

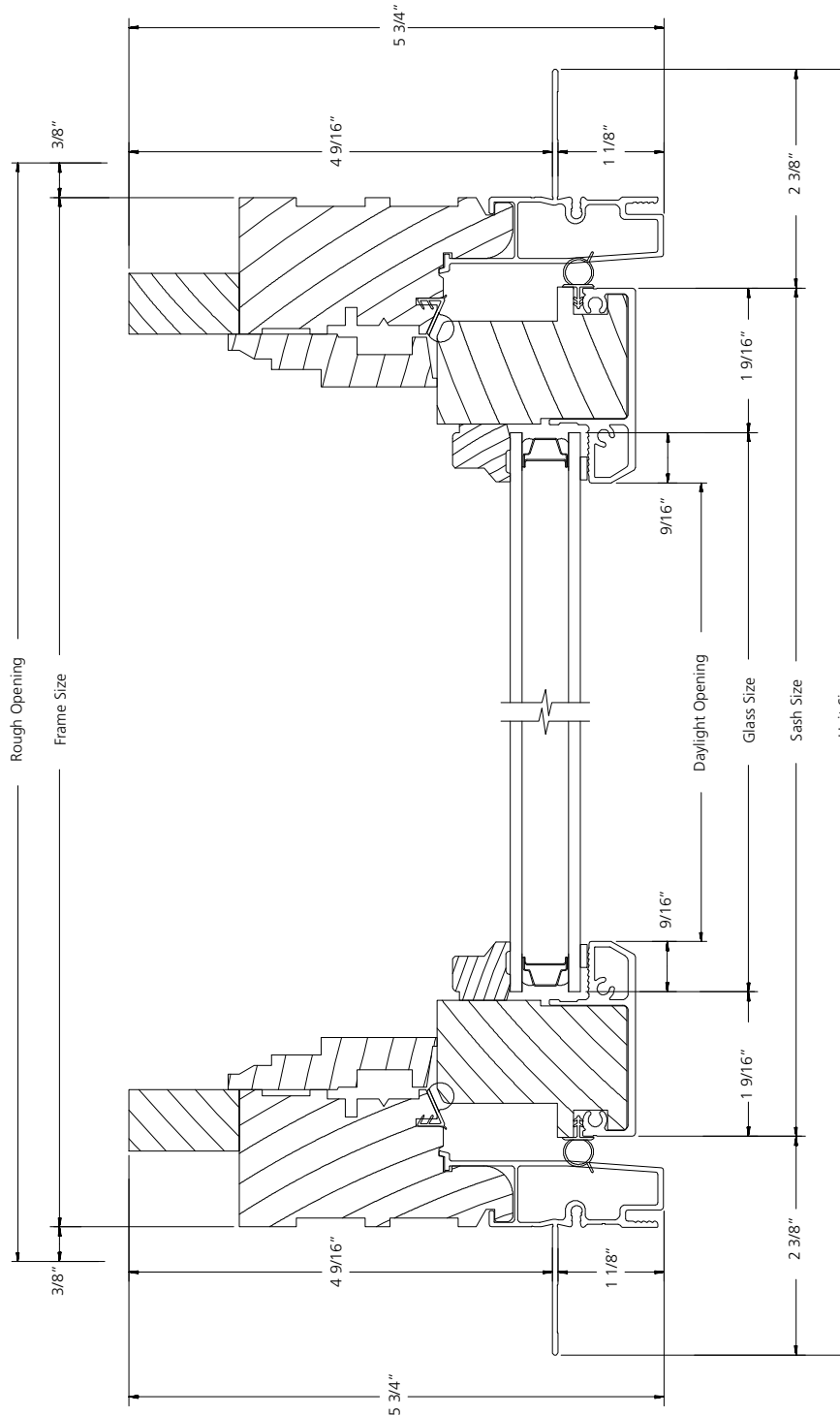

HORIZONTAL SECTION

SCALE: 6" = 1'

SECTOR TOP

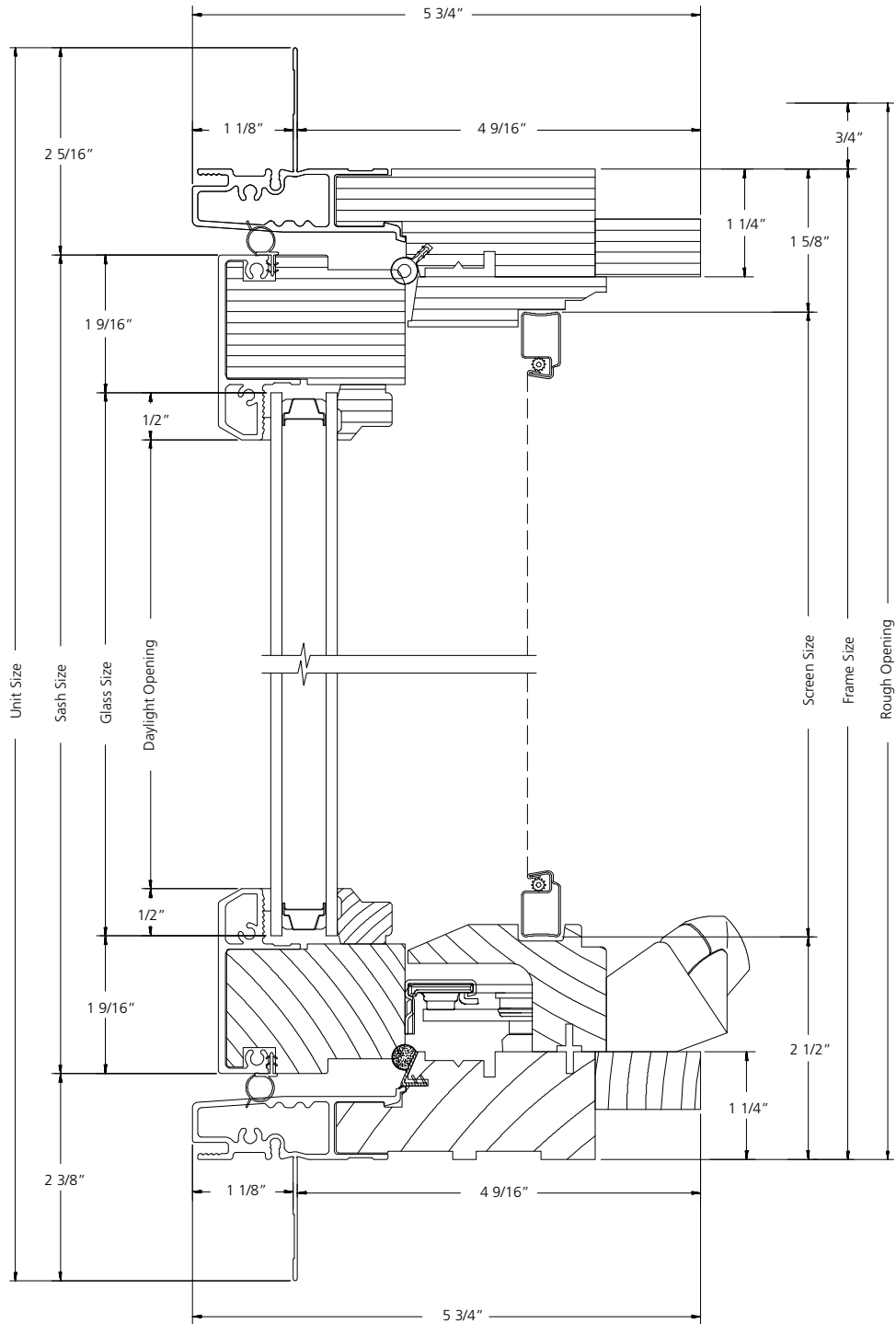

VERTICAL SECTION

SCALE: 6" = 1'

SECTOR TOP

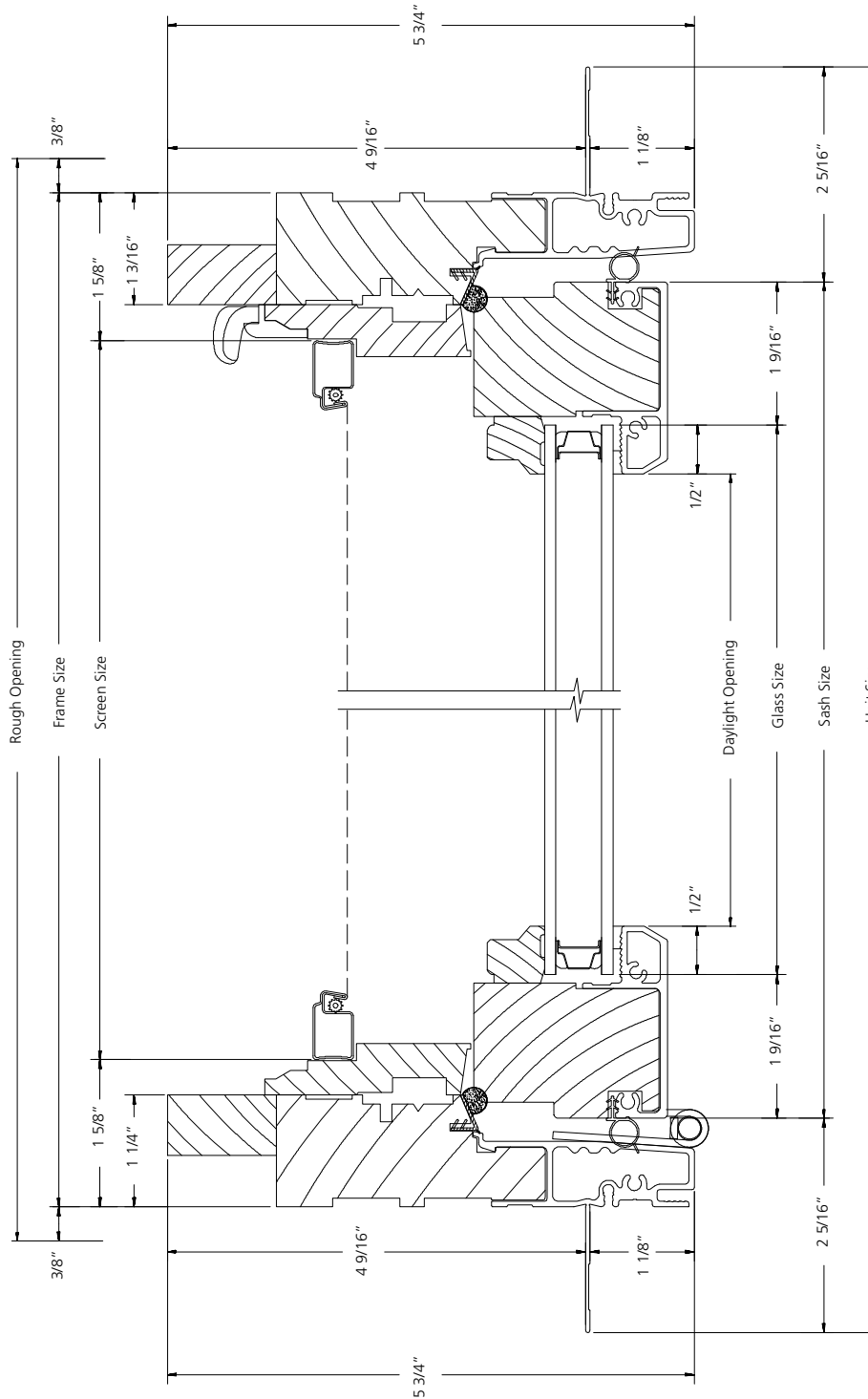

HORIZONTAL SECTION

SCALE: 6" = 1'

EXTENDED HALF ROUND

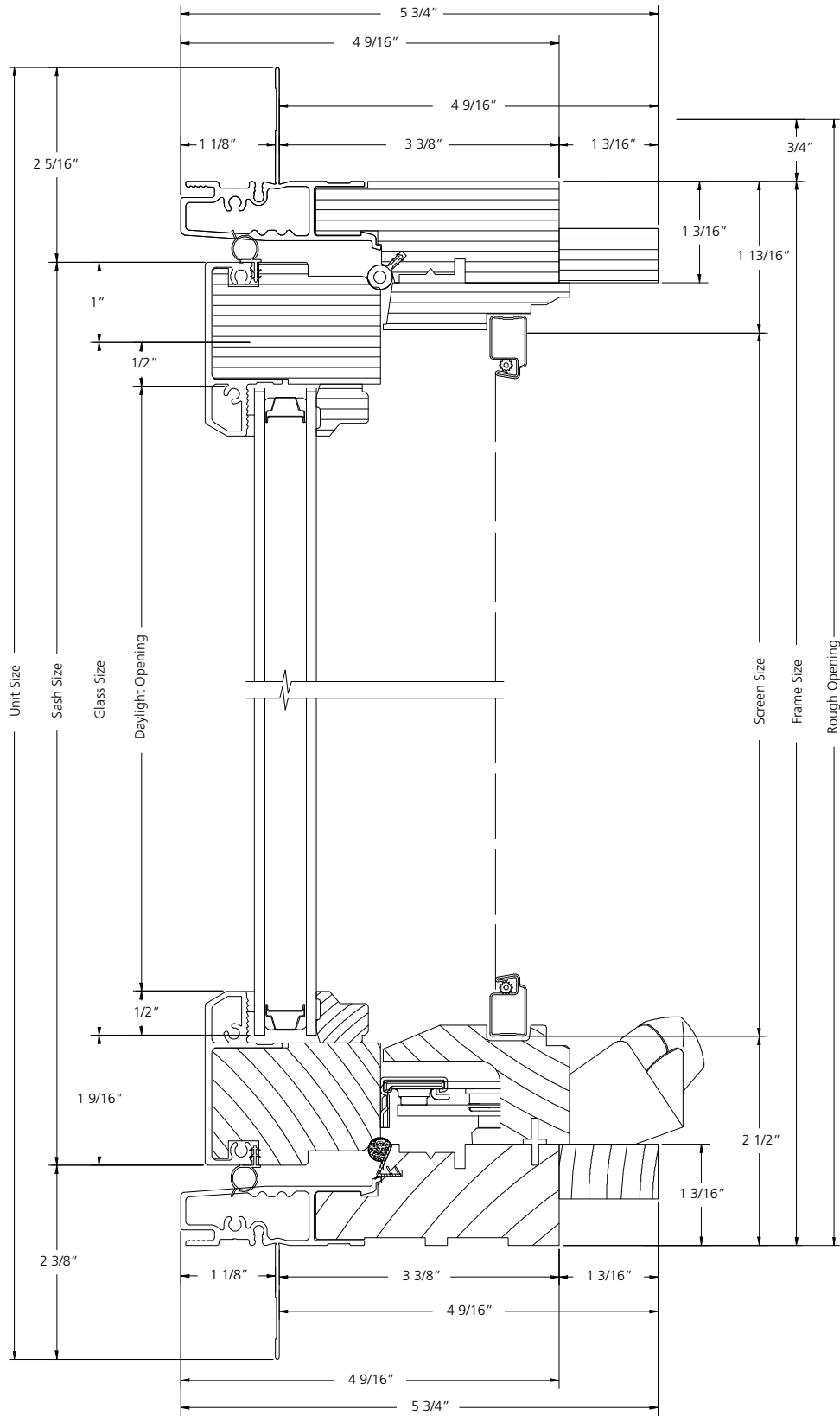

VERTICAL SECTION

SCALE: 6" = 1'

EXTENDED HALF ROUND

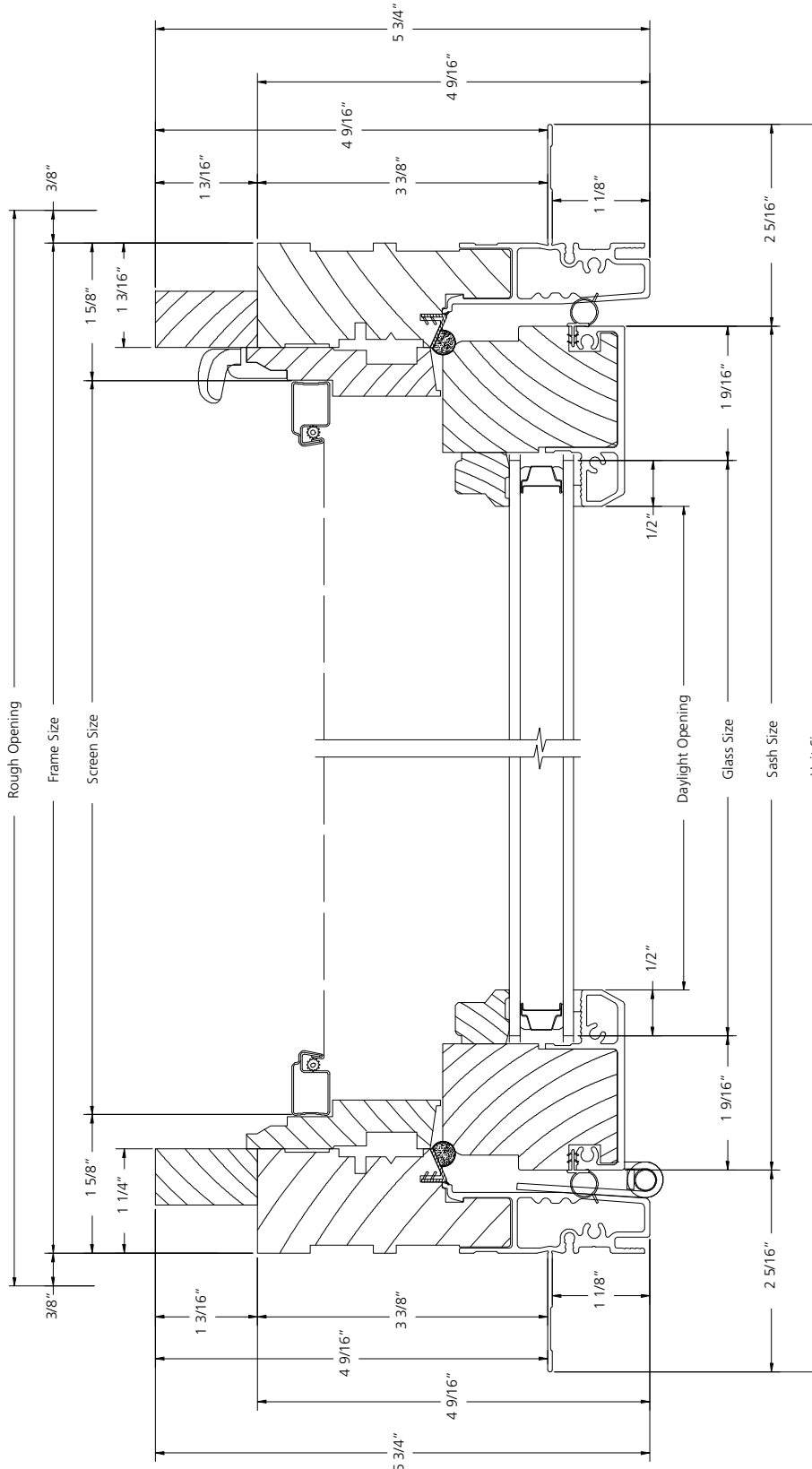

HORIZONTAL SECTION

SCALE: 6" = 1'

EXTENDED QUARTER ROUND

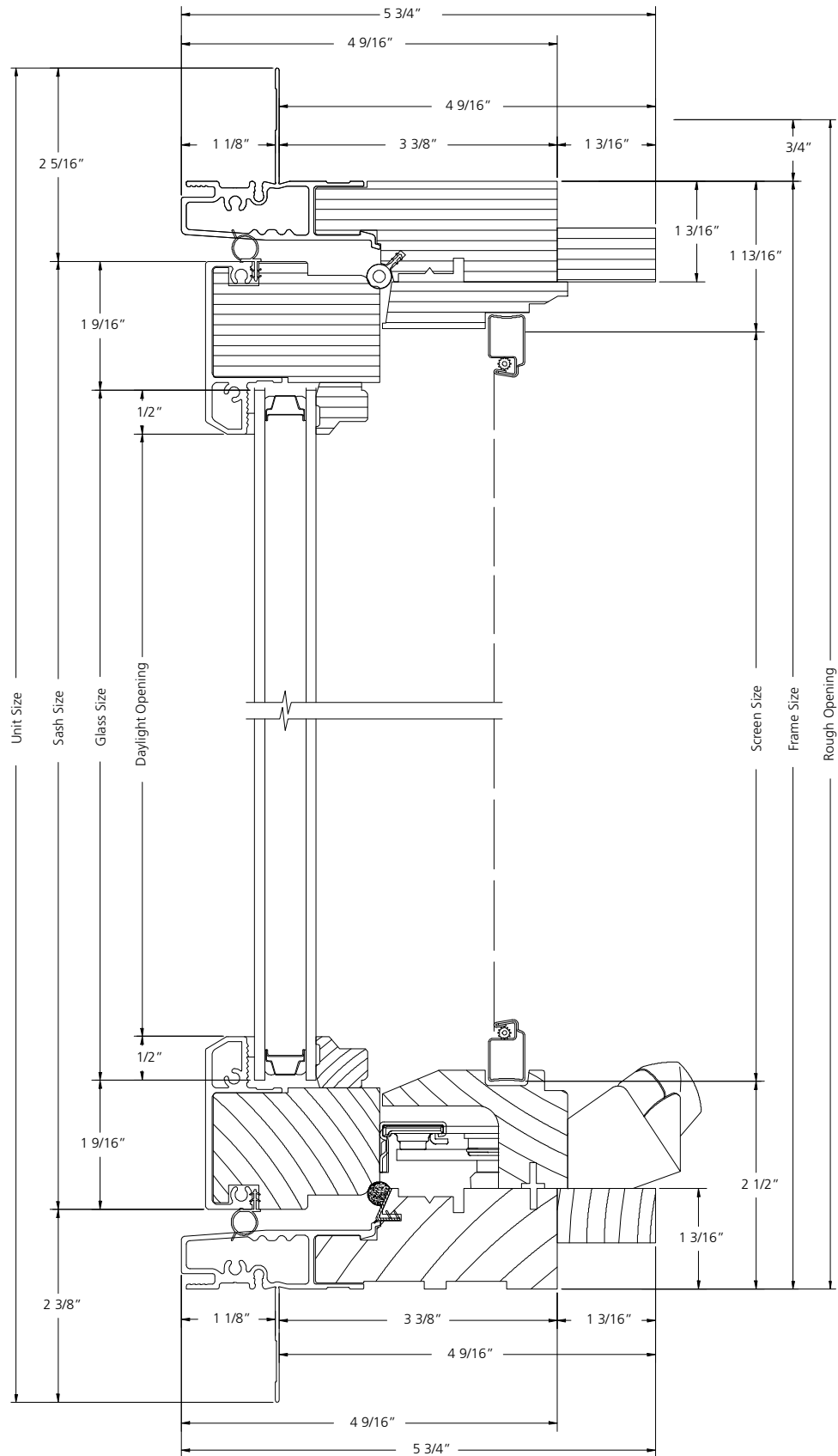

VERTICAL SECTION

SCALE: 6" = 1'

EXTENDED QUARTER ROUND

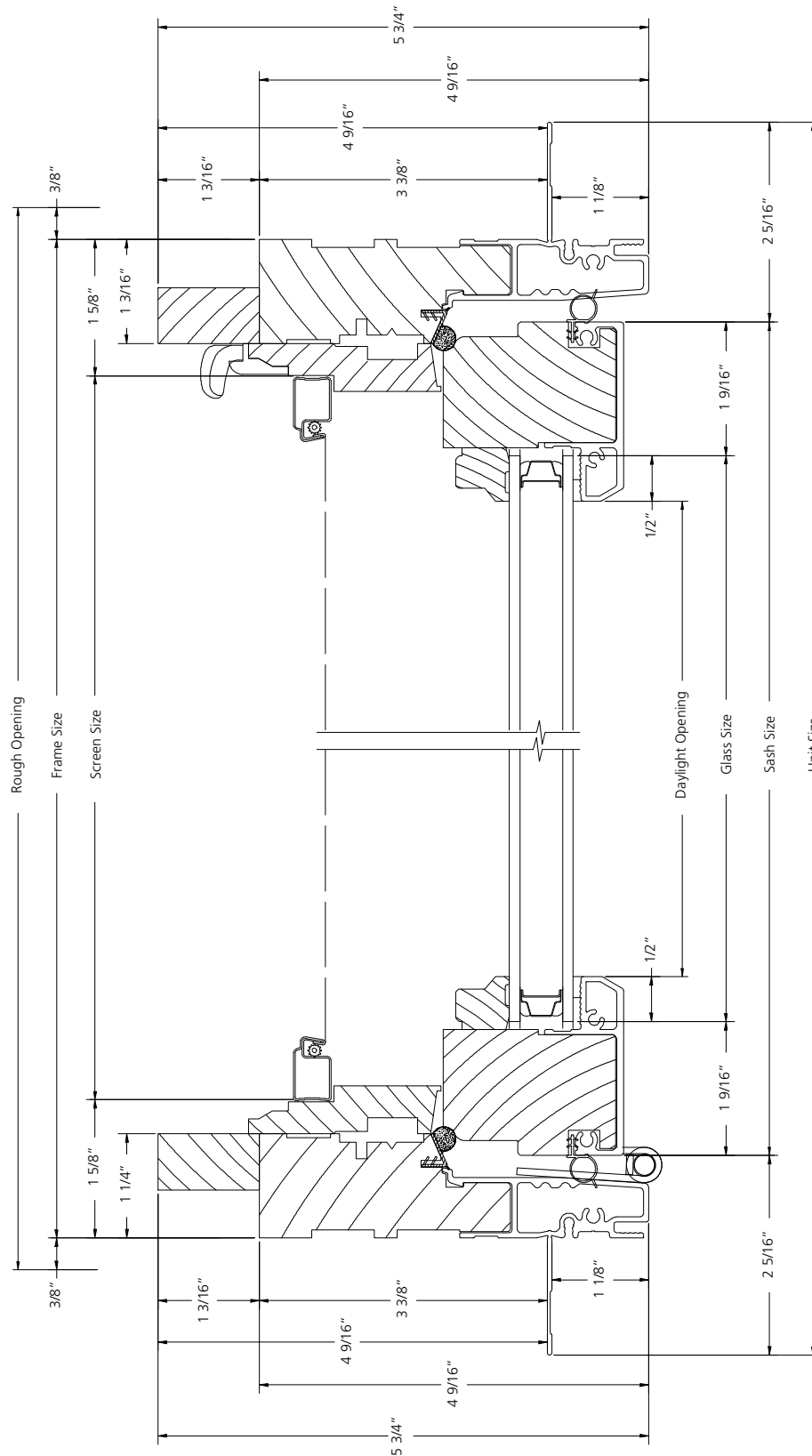

HORIZONTAL SECTION

SCALE: 6" = 1'