TABLE OF CONTENTS

Specifications	3-2
Quick Spec Guide	3-3
Elevations/Sizes: 1/4" Scale	
Single-Hung Side Load	3-4
2-Wide Single-Hung Side Load	3-14
3-Wide Single-Hung Side Load with Center Picture with 24" Flanker	3-19
3-Wide Single-Hung Side Load with Center Picture with 30" Flanker	3-21
3-Wide Single-Hung Side Load with Center Picture with 36" Flanker	3-22
Grille Patterns	3-23
Section Details: 6" Scale	3-24

PRODUCT SPECIFICATIONS

MATERIALS

The extruded vinyl profiles comply with the performance requirements of AAMA 303-97. The colors extend through the profile of the extrusion with White and Desert Sand colors available. An Almond color is available in select Western markets.

FRAME

All frames and sash are assembled using fusion-welding technology for added strength and durability. The frame jamb width is 2-29/32" (74mm), and the nominal extrusion exterior wall thickness is 0.060". The wall depth of the single hung product is 1-19/32". The frame incorporates an integral nailing fin which can be easily removed to allow the unit to be used in a replacement window application. The replacement product option includes a head expander and a sloped sill adapter which can be modified to accommodate various slope sills. Weep holes are included on the frame to ensure standing water is directed to the exterior plane of the unit. An interior and exterior accessory groove is standard to accommodate various frame accessory and assembly options on the product. An optional brickmould with integral j-channel and flat casing profiles are available for select Eastern markets. An optional integral stucco key integral dual-wall flush fin profiles are available for specific applications in select Western markets.

SASH

The side load sash is a 1-1/2" (38.1mm) nominal thickness, and is assembled using fusion-welding technology for added strength and durability. The sash in the brickmould option is a 1-3/8" (35.1mm) nominal thickness. The sash also uses a steel reinforcement bar in the horizontal meeting rails for additional strength. The fixed upper glass is direct set into the unit frame.

GLAZING

3/4" (19mm) insulated glass consist of two lites of glass sealed around a spacer. The glass is mounted into the sash using a silicone-glazing compound. The insulating glass units comply with the performance requirements of the IGCC in accordance with either ASTM E774 or E2190. All units except the brickmould product are exterior glazed.

GLAZING OPTIONS

3/4" (19mm) insulated glass is available in clear, Low-E or Low-E 366, tinted, obscure or other specialty insulating glass as specified. Many glass options are available in tempered glazings. A single use reglazing drywall unit option is available, allowing the user to remove the upper glass and meeting rail. A V-groove option is available in select markets.

WEATHERSTRIPPING

A fin-pile weatherstrip is applied along dual perimeter of the operating sash. The meeting rails utilize an integral extruded interlock to provide exceptional performance.

HARDWARE

The exclusive WEN-Lock™ with visible latch indicator or a single action cam style lock is available on all windows. Block and tackle balance systems are utilized to support the vertical operation of the sash. Balance retainer clips are attached to the side jambs of the windows to retain the balances during the sash removal process.

INSECT SCREENS

The optional fiberglass charcoal color insect screen is set in an aluminum frame to match the color of the unit. The screen is secured to the window using a pin and spring loaded plunger system. Insect screens are intended to allow air and light in and to keep insects out. They are not intended to keep anyone or anything from falling through an open door or window. For safety screens or other security devices contact your local building supply retailer.

GRILLES

GBG (Grilles between the Glass) - 5/8" (16mm) and 7/8" (22.2mm) flat or 1" (26mm) contour grilles mounted between the glass panes suspended within the air cavity and color matched to the extrusion color. A V-groove option is available in select markets.

EXTENSION JAMBS

Extension jambs are regionally available for JELD-WEN vinyl products. The 9/16" extension jambs are available in pine clear vinyl wrapped, primed wood, red oak and maple finishes and can be specified on three or four sides of the product.

ADDITIONAL ACCESSORIES

Additional accessories are available for JELD-WEN Vinyl products. Please contact your local building supply retailer for a complete listing of the additional accessories.

INSTALLATION

Installation per JELD-WEN Installation Method for Vinyl Windows JII001, JII010 or JII011. See www.jeld-wen.com/resources for instructions.

PERFORMANCE

NFRC Certified - (rated and labeled in accordance with NFRC)

AAMA/NWDMA I.S.2-97
R20-DP rated

QUICK SPEC GUIDE

SPECIFICATION	STANDARD FEATURES	OPTIONAL FEATURES <i>Some options may require additional lead times. Consult your JELD-WEN Sales Representative.</i>
COLOR	<ul style="list-style-type: none"> White 	<ul style="list-style-type: none"> Almond Desert Sand <p><i>not available in all regions</i></p>
SIZE	<ul style="list-style-type: none"> Width: 18" to 48" Height: 24" to 77" 	
FRAME	<ul style="list-style-type: none"> Integral Nail Fin 	<ul style="list-style-type: none"> Pocket/Block Frame Integral Dual Wall Flush Fin (West) Integral Stucco Fin w/stucco key (West)
GLAZING	<ul style="list-style-type: none"> Insulating Low-E 	<ul style="list-style-type: none"> Clear Low-E 366 Low-E Keep Clean Obscure Bronze Gray Gluechip Rain Azurlite Laminated All glass available tempered <p><i>regional glass availabilities may differ</i></p>
HARDWARE	<ul style="list-style-type: none"> Block and Tackle Balance System WEN-Lock™ Side Removable Take out Clips 	<ul style="list-style-type: none"> Cam Lock
HARDWARE COLOR	<ul style="list-style-type: none"> Color matched to extrusion 	
SCREENS	<ul style="list-style-type: none"> Fiberglass 	
SCREEN FRAME COLOR	<ul style="list-style-type: none"> Color matched to extrusion 	
GRILLES		<ul style="list-style-type: none"> 1" Contour GBG (grilles between the glass) 5/8" Flat GBG (grilles between the glass) 5/8" Contour GBG (grilles between the glass) (East) 7/8" Flat GBG (grilles between the glass) (East)
JAMB DEPTH	<ul style="list-style-type: none"> 2-29/32" 	<ul style="list-style-type: none"> Integral J-channel (East) - 2-29/32" Integral Dual Wall Flush Fin (West) - 2-29/32" Integral Stucco Fin w/stucco key (West) - 2-29/32" 4-9/16" Extension Jamb Applied (East only) 6-9/16" Extension Jamb Applied (East only)
ACCESSORIES		<ul style="list-style-type: none"> Extension Jamb Retainer Drip Cap Drywall Retainer 14 Degree Sloped Sill Adapter (factory applied available) Head and Sill Expander











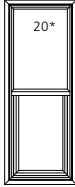







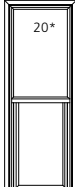
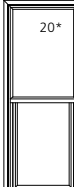





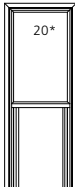







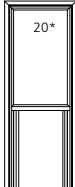
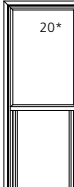



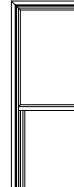

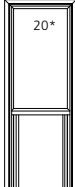



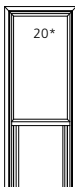

SINGLE-HUNG SIDE LOAD

UNIT SIZE ROUGH OPENING FRAME SIZE DAYLIGHT OPENING	19 3/4" 18" 17 1/2"	21 3/4" 20" 19 1/2"	23 3/4" 22" 21 1/2"	25 3/4" 24" 23 1/2"	27 3/4" 26" 25 1/2"	29 3/4" 28" 27 1/2"	31 3/4" 30" 29 1/2"	33 3/4" 32" 31 1/2"
	14 25/32" 12 3/16"	16 25/32" 14 3/16"	18 25/32" 16 3/16"	20 25/32" 18 3/16"	22 25/32" 20 3/16"	24 25/32" 22 3/16"	26 25/32" 24 3/16"	28 25/32" 26 3/16"
31 3/4" 30" 29 1/2" 11 1/4" 12 9/16"	20* 75H1830	20* 75H2030	20* 75H2230	20* 75H2430	20* 75H2630	20* 75H2830	20* 75H3030	20* 75H3230
37 3/4" 36" 35 1/2" 14 1/4" 15 9/16"	20* 75H1836	20* 75H2036	20* 75H2236	20* 75H2436	20* 75H2636	20* 75H2836	20* 75H3036	20* 75H3236
38 3/4" 37" 36 1/2" 14 3/4" 16 1/16"	20* 75H1837	20* 75H2037	20* 75H2237	20* 75H2437	20* 75H2637	20* 75H2837	20* 75H3037	20* 75H3237
39 3/4" 38" 37 1/2" 15 1/4" 16 9/16"	20* 75H1838	20* 75H2038	20* 75H2238	20* 75H2438	20* 75H2638	20* 75H2838	20* 75H3038	20* 75H3238
42 3/4" 41" 40 1/2" 16 3/4" 18 1/16"	20* 75H1841	20* 75H2041	20* 75H2241	20* 75H2441	20* 75H2641	20* 75H2841	20* 75H3041	20* 75H3241
43 3/4" 42" 41 1/2" 17 1/4" 18 9/16"	20* 75H1842	20* 75H2042	20* 75H2242	20* 75H2442	20* 75H2642	20* 75H2842	20* 75H3042	20* 75H3242
49 3/4" 48" 47 1/2" 20 1/4" 21 9/16"	20* 75H1848	20* 75H2048	20* 75H2248	20* 75H2448	20* 75H2648	20* 75H2848	20* 75H3048	20* 75H3248

ELEVATION SYMBOL LEGEND:
 ###* NUMBER INDICATES DESIGN PRESSURE (DP) RATING WITH STANDARD GLAZING.

SCALE: 1/4" = 1'











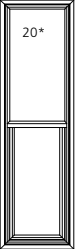



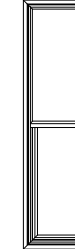

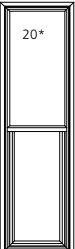

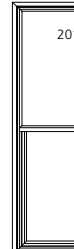
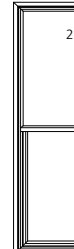
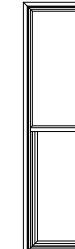

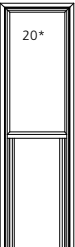

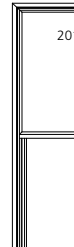

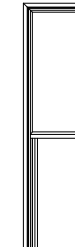

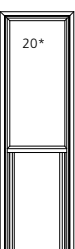

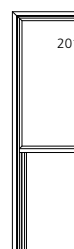
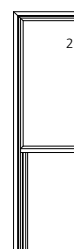

SINGLE-HUNG SIDE LOAD

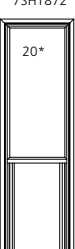
UNIT SIZE	19 3/4"	21 3/4"	23 3/4"	25 3/4"	27 3/4"	29 3/4"	31 3/4"	33 3/4"
ROUGH OPENING	18"	20"	22"	24"	26"	28"	30"	32"
FRAME SIZE	17 1/2"	19 1/2"	21 1/2"	23 1/2"	25 1/2"	27 1/2"	29 1/2"	31 1/2"
DAYLIGHT OPENING	14 25/32" 12 3/16"	16 25/32" 14 3/16"	18 25/32" 16 3/16"	20 25/32" 18 3/16"	22 25/32" 20 3/16"	24 25/32" 22 3/16"	26 25/32" 24 3/16"	28 25/32" 26 3/16"
50 3/4" 49" 48 1/2" 20 3/4" 22 1/16"	 75H1849	 75H2049	 75H2249	 75H2449	 75H2649	 75H2849	 75H3049	 75H3249
54 3/4" 53" 52 1/2" 22 3/4" 24 1/16"	 75H1853	 75H2053	 75H2253	 75H2453	 75H2653	 75H2853	 75H3053	 75H3253
55 3/4" 54" 53 1/2" 23 1/4" 24 9/16"	 75H1854	 75H2054	 75H2254	 75H2454	 75H2654	 75H2854	 75H3054	 75H3254
58 3/4" 57" 56 1/2" 24 3/4" 26 1/16"	 75H1857	 75H2057	 75H2257	 75H2457	 75H2657	 75H2857	 75H3057	 75H3257
61 3/4" 60" 59 1/2" 26 1/4" 27 9/16"	 75H1860	 75H2060	 75H2260	 75H2460	 75H2660	 75H2860	 75H3060	 75H3260
63 3/4" 62" 61 1/2" 27 1/4" 28 9/16"	 75H1862	 75H2062	 75H2262	 75H2462	 75H2662	 75H2862	 75H3062	 75H3262

ELEVATION SYMBOL LEGEND:
 *** NUMBER INDICATES DESIGN PRESSURE (DP) RATING WITH STANDARD GLAZING.

SCALE: 1/4" = 1'

SINGLE-HUNG SIDE LOAD

UNIT SIZE	19 3/4"	21 3/4"	23 3/4"	25 3/4"	27 3/4"	29 3/4"	31 3/4"	33 3/4"
ROUGH OPENING	18"	20"	22"	24"	26"	28"	30"	32"
FRAME SIZE	17 1/2"	19 1/2"	21 1/2"	23 1/2"	25 1/2"	27 1/2"	29 1/2"	31 1/2"
DAYLIGHT OPENING	14 25/32" 12 3/16"	16 25/32" 14 3/16"	18 25/32" 16 3/16"	20 25/32" 18 3/16"	22 25/32" 20 3/16"	24 25/32" 22 3/16"	26 25/32" 24 3/16"	28 25/32" 26 3/16"
66 3/4" 66" 65 1/2" 28 3/4" 30 1/16"	 20* 7SH1865	 20* 7SH2065	 20* 7SH2265	 20* 7SH2465	 20* 7SH2665	 20* 7SH2865	 20* 7SH3065	 20* 7SH3265
67 3/4" 66" 65" 29 1/4" 30 9/16"	 20* 7SH1866	 20* 7SH2066	 20* 7SH2266	 20* 7SH2466	 20* 7SH2666	 20* 7SH2866	 20* 7SH3066	 20* 7SH3266
70 3/4" 69" 68" 30 3/4" 32 1/16"	 20* 7SH1869	 20* 7SH2069	 20* 7SH2269	 20* 7SH2469	 20* 7SH2669	 20* 7SH2869	 20* 7SH3069	 20* 7SH3269
73 3/4" 71" 71 1/2" 32 1/4" 33 9/16"	 20* 7SH1872	 20* 7SH2072	 20* 7SH2272	 20* 7SH2472	 20* 7SH2672	 20* 7SH2872	 20* 7SH3072	 20* 7SH3272
75 3/4" 74" 71 1/2" 33 1/4" 34 9/16"	 20* 7SH1874	 20* 7SH2074	 20* 7SH2274	 20* 7SH2474	 20* 7SH2674	 20* 7SH2874	 20* 7SH3074	 20* 7SH3274

ELEVATION SYMBOL LEGEND:
 ### NUMBER INDICATES DESIGN PRESSURE (DP) RATING WITH STANDARD GLAZING.
 E UNIT MEETS EGRESS REQUIREMENTS FOR IRC CODE. STATE AND LOCAL EGRESS CODES MAY DIFFER. ALWAYS REFER TO LOCAL BUILDING CODES FOR COMPLETE REQUIREMENTS. CHECK WITH LOCAL OFFICIALS TO ENSURE COMPLIANCE BEFORE INSTALLING THE UNIT.

SCALE: 1/4" = 1'

SINGLE-HUNG SIDE LOAD







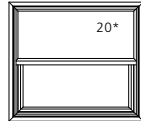
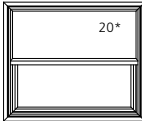
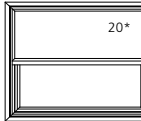

UNIT SIZE	19 3/4"	21 3/4"	23 3/4"	25 3/4"	27 3/4"	29 3/4"	31 3/4"	33 3/4"
ROUGH OPENING	18"	20"	22"	24"	26"	28"	30"	32"
FRAME SIZE	17 1/2"	19 1/2"	21 1/2"	23 1/2"	25 1/2"	27 1/2"	29 1/2"	31 1/2"
DAYLIGHT OPENING	14 25/32" 12 3/16"	16 25/32" 14 3/16"	18 25/32" 16 3/16"	20 25/32" 18 3/16"	22 25/32" 20 3/16"	24 25/32" 22 3/16"	26 25/32" 24 3/16"	28 25/32" 26 3/16"
78 3/4" 77 1/8" 34 3/4" 36 1/16"	20* 75H1877	20* 75H2077	20* 75H2277	20* 75H2477	20* 75H2677	20* 75H2877	20* 75H3077	20* 75H3277
79 3/4" 78 1/2" 35 1/4" 36 9/16"	20* 75H1878	20* 75H2078	20* 75H2278	20* 75H2478	20* 75H2678	20* 75H2878	20* 75H3078	20* 75H3278
85 3/4" 84 1/8" 38 1/4" 39 9/16"	20* 75H1884	20* 75H2084	20* 75H2284	20* 75H2484	20* 75H2684	20* 75H2884	20* 75H3084	20* 75H3284

ELEVATION SYMBOL LEGEND:

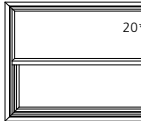
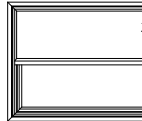
- ##* NUMBER INDICATES DESIGN PRESSURE (DP) RATING WITH STANDARD GLAZING.
- E UNIT MEETS EGRESS REQUIREMENTS FOR IRC CODE. STATE AND LOCAL EGRESS CODES MAY DIFFER. ALWAYS REFER TO LOCAL BUILDING CODES FOR COMPLETE REQUIREMENTS. CHECK WITH LOCAL OFFICIALS TO ENSURE COMPLIANCE BEFORE INSTALLING THE UNIT.

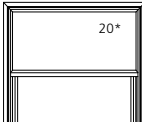
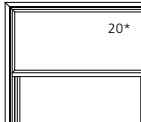
SCALE: 1/4" = 1'

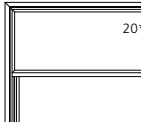
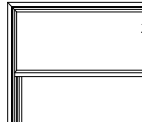
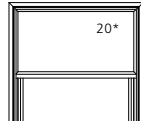
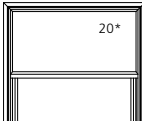
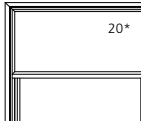
SINGLE-HUNG SIDE LOAD

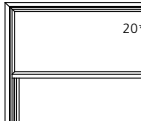
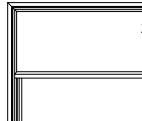
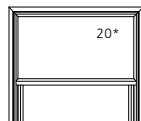
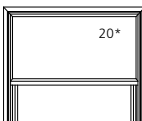
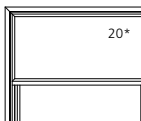
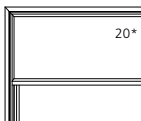
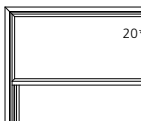
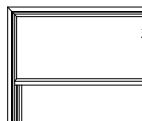
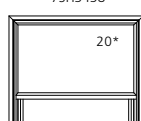
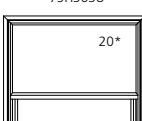
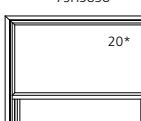
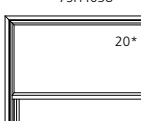
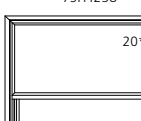
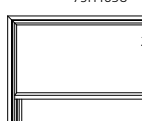
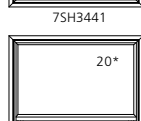
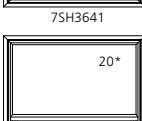
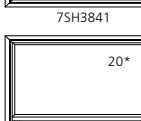
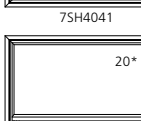
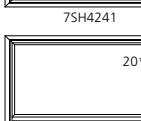
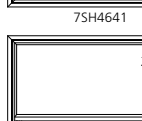
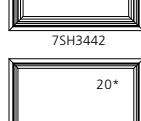
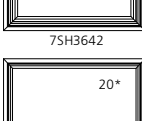
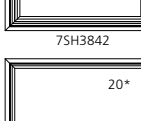
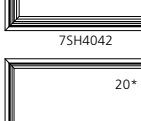
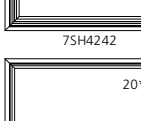
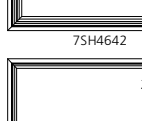
UNIT SIZE ROUGH OPENING FRAME SIZE DAYLIGHT OPENING	35 3/4" 34" 33 1/2" 30 25/32" 28 3/16"	37 3/4" 36" 35 1/2" 32 25/32" 30 3/16"	39 3/4" 38" 37 1/2" 34 25/32" 32 3/16"	41 3/4" 40" 39 1/2" 36 25/32" 34 3/16"	43 3/4" 42" 41 1/2" 38 25/32" 36 3/16"	47 3/4" 46" 45 1/2" 42 25/32" 40 3/16"
31 3/4" 30" 29 1/2" 11 1/4" 12 9/16"	 20* 75H3430	 20* 75H3630	 20* 75H3830	 20* 75H4030	 20* 75H4230	 20* 75H4630
37 3/4" 36" 35 1/2" 14 1/4" 15 9/16"	 20* 75H3436	 20* 75H3636	 20* 75H3836	 20* 75H4036	 20* 75H4236	 20* 75H4636
38 3/4" 37" 36 1/2" 14 3/4" 16 1/16"	 20* 75H3437	 20* 75H3637	 20* 75H3837	 20* 75H4037	 20* 75H4237	 20* 75H4637
39 3/4" 38" 37 1/2" 15 1/4" 16 9/16"	 20* 75H3438	 20* 75H3638	 20* 75H3838	 20* 75H4038	 20* 75H4238	 20* 75H4638
42 3/4" 41" 40 1/2" 16 3/4" 18 1/16"	 20* 75H3441	 20* 75H3641	 20* 75H3841	 20* 75H4041	 20* 75H4241	 20* 75H4641
43 3/4" 42" 41 1/2" 17 1/4" 18 9/16"	 20* 75H3442	 20* 75H3642	 20* 75H3842	 20* 75H4042	 20* 75H4242	 20* 75H4642
49 3/4" 48" 47 1/2" 20 1/4" 21 9/16"	 20* 75H3448	 20* 75H3648	 20* 75H3848	 20* 75H4048	 20* 75H4248	 20* 75H4648

ELEVATION SYMBOL LEGEND:
 ### NUMBER INDICATES DESIGN PRESSURE (DP) RATING WITH STANDARD GLAZING.

SCALE: 1/4" = 1'

SINGLE-HUNG SIDE LOAD









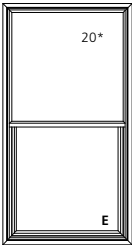
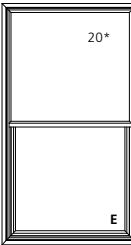
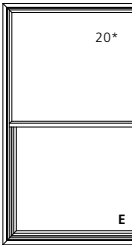
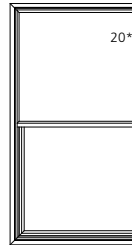
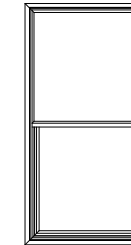

UNIT SIZE	35 3/4"	37 3/4"	39 3/4"	41 3/4"	43 3/4"	47 3/4"
ROUGH OPENING	34"	36"	38"	40"	42"	46"
FRAME SIZE	33 1/2"	35 1/2"	37 1/2"	39 1/2"	41 1/2"	45 1/2"
DAYLIGHT OPENING	30 25/32" 28 3/16"	32 25/32" 30 3/16"	34 25/32" 32 3/16"	36 25/32" 34 3/16"	38 25/32" 36 3/16"	42 25/32" 40 3/16"
50 3/4" 49" 20 3/4" 22 1/16"	20*	20*	20*	20*	20*	20*
54 3/4" 53" 22 3/4" 24 1/16"	20*	20*	20*	20*	20*	20*
55 3/4" 54" 23 1/4" 24 9/16"	20*	20*	20*	20*	20*	20*
58 3/4" 57" 24 3/4" 26 1/16"	20*	20*	20*	20*	20*	20*
61 3/4" 60" 26 1/4" 27 9/16"	20*	20* E	20* E	20* E	20* E	20* E
63 3/4" 62" 27 1/4" 28 9/16"	20*	20* E	20* E	20* E	20* E	20* E

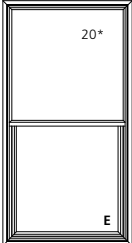
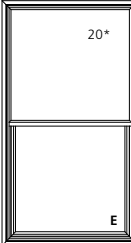
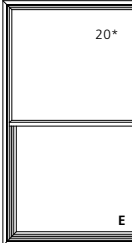
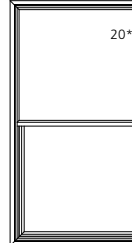
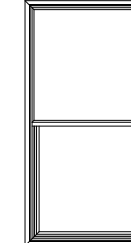
ELEVATION SYMBOL LEGEND:

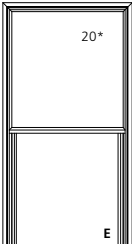
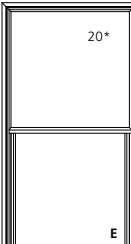
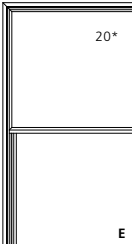
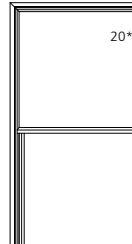
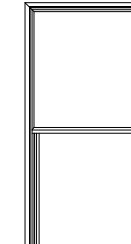
- ### NUMBER INDICATES DESIGN PRESSURE (DP) RATING WITH STANDARD GLAZING.
- E UNIT MEETS EGRESS REQUIREMENTS FOR IRC CODE. STATE AND LOCAL EGRESS CODES MAY DIFFER. ALWAYS REFER TO LOCAL BUILDING CODES FOR COMPLETE REQUIREMENTS. CHECK WITH LOCAL OFFICIALS TO ENSURE COMPLIANCE BEFORE INSTALLING THE UNIT.

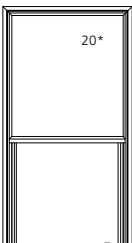
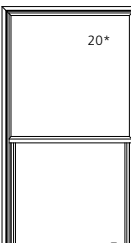
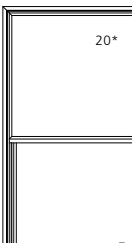
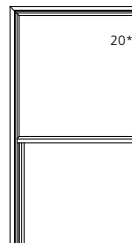
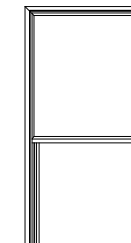
SCALE: 1/4" = 1'

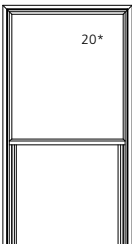
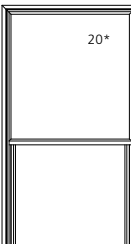
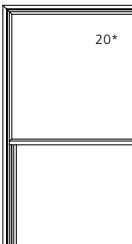
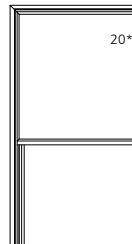
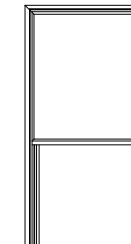
SINGLE-HUNG SIDE LOAD

UNIT SIZE	35 3/4"	37 3/4"	39 3/4"	41 3/4"	43 3/4"	47 3/4"
ROUGH OPENING	34"	36"	38"	40"	42"	46"
FRAME SIZE	33 1/2"	35 1/2"	37 1/2"	39 1/2"	41 1/2"	45 1/2"
DAYLIGHT OPENING	30 25/32" 28 3/16"	32 25/32" 30 3/16"	34 25/32" 32 3/16"	36 25/32" 34 3/16"	38 25/32" 36 3/16"	42 25/32" 40 3/16"
66 3/4" 65" 64 1/2" 28 3/4" 30 1/16"	 20* 75H3465	 20* 75H3665	 20* 75H3865	 20* 75H4065	 20* 75H4265	 20* 75H4665
67 3/4" 66" 65 1/2" 29 1/4" 30 9/16"	 20* 75H3466	 20* 75H3666	 20* 75H3866	 20* 75H4066	 20* 75H4266	 20* 75H4666
70 3/4" 69" 68 1/2" 30 3/4" 32 1/16"	 20* 75H3469	 20* 75H3669	 20* 75H3869	 20* 75H4069	 20* 75H4269	 20* 75H4669
73 3/4" 72" 71 1/2" 32 1/4" 33 9/16"	 20* 75H3472	 20* 75H3672	 20* 75H3872	 20* 75H4072	 20* 75H4272	 20* 75H4672
75 3/4" 74" 73 1/2" 33 1/4" 34 9/16"	 20* 75H3474	 20* 75H3674	 20* 75H3874	 20* 75H4074	 20* 75H4274	 20* 75H4674

ELEVATION SYMBOL LEGEND:

##* NUMBER INDICATES DESIGN PRESSURE (DP) RATING WITH STANDARD GLAZING.

E UNIT MEETS EGRESS REQUIREMENTS FOR IRC CODE. STATE AND LOCAL EGRESS CODES MAY DIFFER. ALWAYS REFER TO LOCAL BUILDING CODES FOR COMPLETE REQUIREMENTS. CHECK WITH LOCAL OFFICIALS TO ENSURE COMPLIANCE BEFORE INSTALLING THE UNIT.

SCALE: 1/4" = 1'

SINGLE-HUNG SIDE LOAD

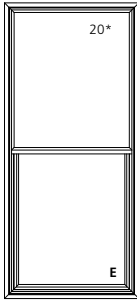
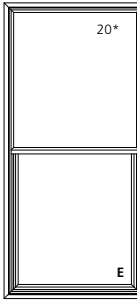
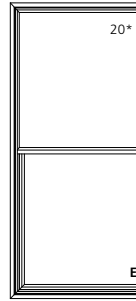
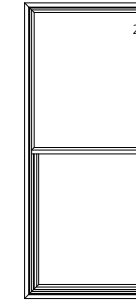
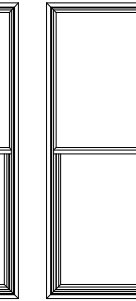
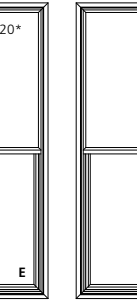
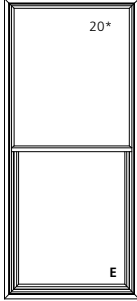
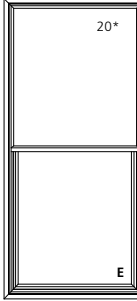
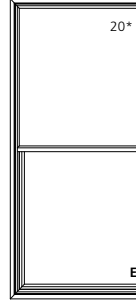
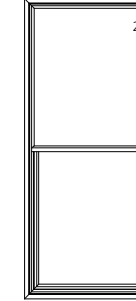
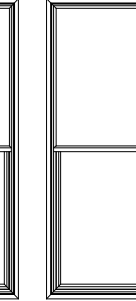
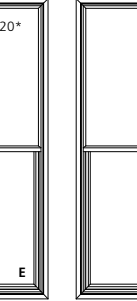
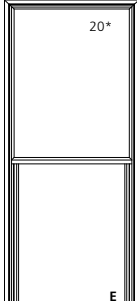
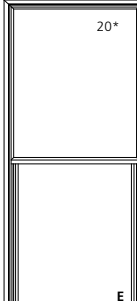
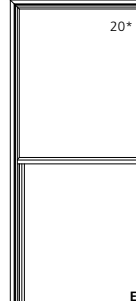
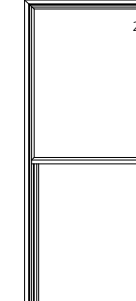
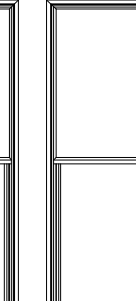
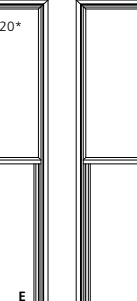
UNIT SIZE	35 3/4"	37 3/4"	39 3/4"	41 3/4"	43 3/4"	47 3/4"
ROUGH OPENING	34"	36"	38"	40"	42"	46"
FRAME SIZE	33 1/2"	35 1/2"	37 1/2"	39 1/2"	41 1/2"	45 1/2"
DAYLIGHT OPENING	30 25/32" 28 3/16"	32 25/32" 30 3/16"	34 25/32" 32 3/16"	36 25/32" 34 3/16"	38 25/32" 36 3/16"	42 25/32" 40 3/16"
78 3/4" 77" 76 1/2" 34 3/4" 36 1/16"						
79 3/4" 78" 77 1/2" 35 1/4" 36 9/16"						
85 3/4" 84" 83 1/2" 38 1/4" 39 9/16"						

ELEVATION SYMBOL LEGEND:

NUMBER INDICATES DESIGN PRESSURE (DP) RATING WITH STANDARD GLAZING.
 E UNIT MEETS EGRESS REQUIREMENTS FOR IRC CODE. STATE AND LOCAL EGRESS CODES MAY DIFFER. ALWAYS REFER TO LOCAL BUILDING CODES FOR COMPLETE REQUIREMENTS. CHECK WITH LOCAL OFFICIALS TO ENSURE COMPLIANCE BEFORE INSTALLING THE UNIT.

SCALE: 1/4" = 1'

SINGLE-HUNG SIDE LOAD

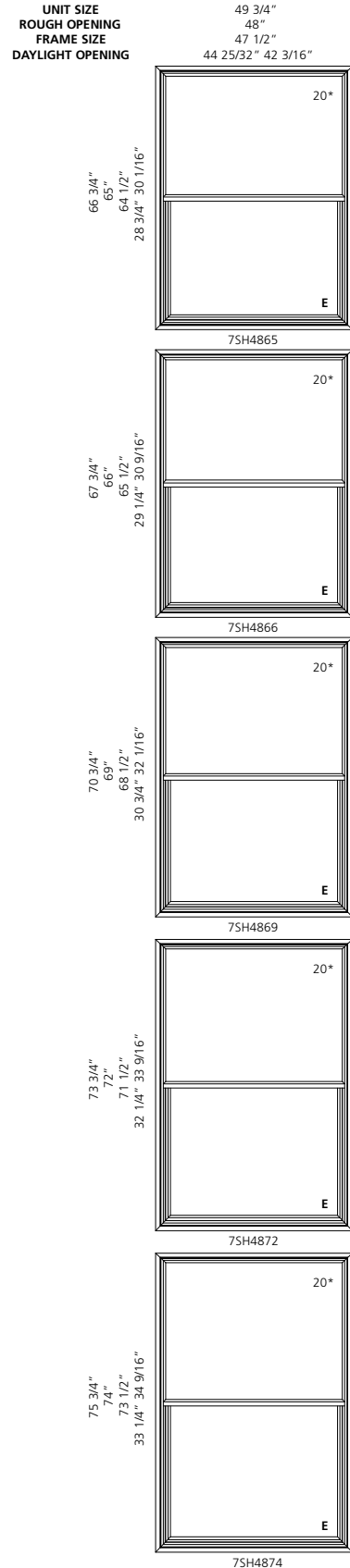
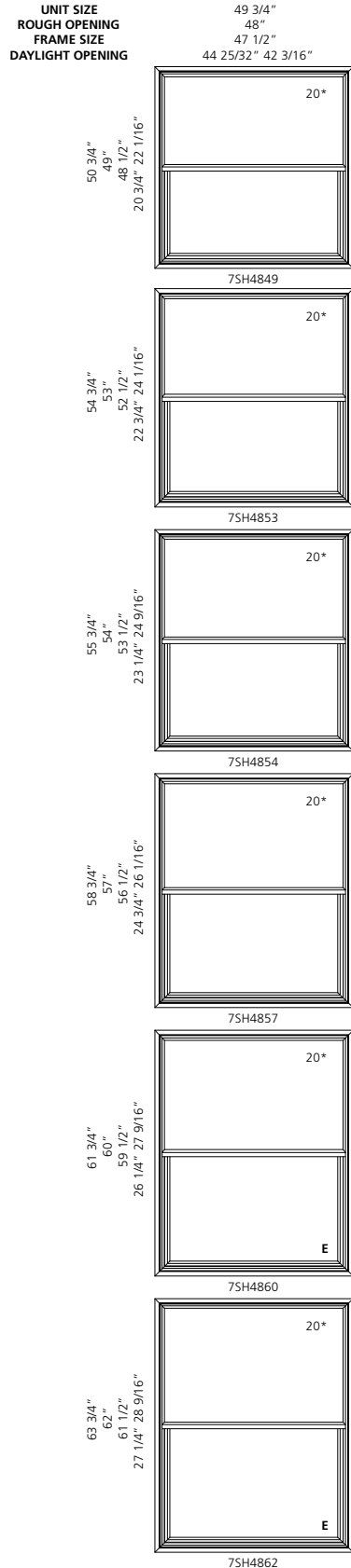
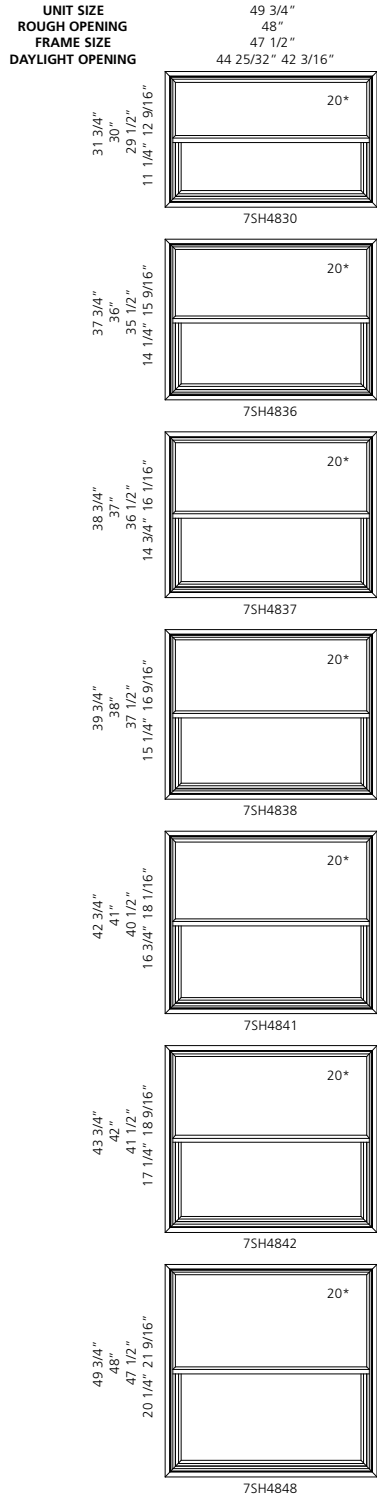

ELEVATION SYMBOL LEGEND:

NUMBER INDICATES DESIGN PRESSURE (DP) RATING WITH STANDARD GLAZING.

E UNIT MEETS EGRESS REQUIREMENTS FOR IRC CODE. STATE AND LOCAL EGRESS CODES MAY DIFFER. ALWAYS REFER TO LOCAL BUILDING CODES FOR COMPLETE REQUIREMENTS. CHECK WITH LOCAL OFFICIALS TO ENSURE COMPLIANCE BEFORE INSTALLING THE UNIT.

SCALE: 1/4" = 1'

SINGLE-HUNG SIDE LOAD

UNIT SIZE 49 3/4"
ROUGH OPENING 48"
FRAME SIZE 47 1/2"
DAYLIGHT OPENING 44 25/32" 42 3/16"

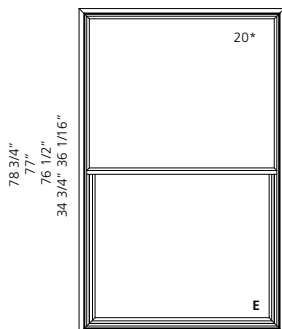

75H4877

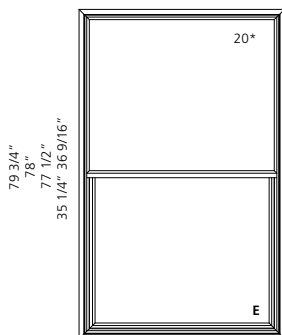

75H4878

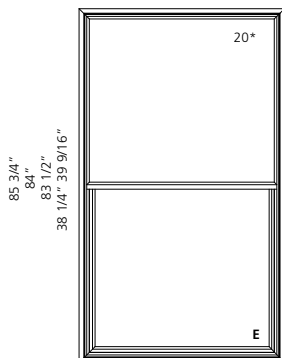

75H4884

ELEVATION SYMBOL LEGEND:

NUMBER INDICATES DESIGN PRESSURE (DP) RATING WITH STANDARD GLAZING.
E UNIT MEETS EGRESS REQUIREMENTS FOR IRC CODE. STATE AND LOCAL EGRESS CODES MAY DIFFER. ALWAYS REFER TO LOCAL BUILDING CODES FOR COMPLETE REQUIREMENTS. CHECK WITH LOCAL OFFICIALS TO ENSURE COMPLIANCE BEFORE INSTALLING THE UNIT.

SCALE: 1/4" = 1'

































































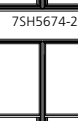





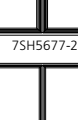

2-WIDE SINGLE-HUNG SIDE LOAD

UNIT SIZE	ROUGH OPENING	FRAME SIZE	DAYLIGHT OPENING	31 3/4"	37 3/4"	38 3/4"	39 3/4"	42 3/4"	43 3/4"	49 3/4"	50 3/4"	54 3/4"	55 3/4"	58 3/4"	61 3/4"		
	37 3/4" 36" 35 1/2"	41 3/4" 40" 39 1/2"	45 3/4" 44" 43 1/2"	49 3/4" 48" 47 1/2"	53 3/4" 52" 51 1/2"	57 3/4" 56" 55 1/2"	61 3/4" 60" 59 1/2"	65 3/4" 64" 63 1/2"									
	14 25/32"[2] 12 3/16"[2]	16 25/32"[2] 14 3/16"[2]	18 25/32"[2] 16 3/16"[2]	20 25/32"[2] 18 3/16"[2]	22 25/32"[2] 20 3/16"[2]	24 25/32"[2] 22 3/16"[2]	26 25/32"[2] 24 3/16"[2]	28 25/32"[2] 26 3/16"[2]									
	31 3/4" 30" 29 1/2" 28 1/2" 27 1/2" 26 1/2" 25 1/2" 24 1/2" 23 1/2" 22 1/2" 21 1/2" 20 1/2" 19 1/2" 18 1/2" 17 1/2" 16 1/2" 15 1/2" 14 1/2" 13 1/2" 12 1/2" 11 1/2"	37 3/4" 36" 35 1/2" 34 1/2" 33 1/2" 32 1/2" 31 1/2" 30 1/2" 29 1/2" 28 1/2" 27 1/2" 26 1/2" 25 1/2" 24 1/2" 23 1/2" 22 1/2" 21 1/2" 20 1/2" 19 1/2" 18 1/2" 17 1/2" 16 1/2" 15 1/2" 14 1/2" 13 1/2" 12 1/2" 11 1/2"	41 3/4" 40" 39 1/2" 38 1/2" 37 1/2" 36 1/2" 35 1/2" 34 1/2" 33 1/2" 32 1/2" 31 1/2" 30 1/2" 29 1/2" 28 1/2" 27 1/2" 26 1/2" 25 1/2" 24 1/2" 23 1/2" 22 1/2" 21 1/2" 20 1/2" 19 1/2" 18 1/2" 17 1/2" 16 1/2" 15 1/2" 14 1/2" 13 1/2" 12 1/2" 11 1/2"	49 3/4" 48" 47 1/2" 46 1/2" 45 1/2" 44 1/2" 43 1/2" 42 1/2" 41 1/2" 40 1/2" 39 1/2" 38 1/2" 37 1/2" 36 1/2" 35 1/2" 34 1/2" 33 1/2" 32 1/2" 31 1/2" 30 1/2" 29 1/2" 28 1/2" 27 1/2" 26 1/2" 25 1/2" 24 1/2" 23 1/2" 22 1/2" 21 1/2" 20 1/2" 19 1/2" 18 1/2" 17 1/2" 16 1/2" 15 1/2" 14 1/2" 13 1/2" 12 1/2" 11 1/2"	53 3/4" 52" 51 1/2" 50 1/2" 49 1/2" 48 1/2" 47 1/2" 46 1/2" 45 1/2" 44 1/2" 43 1/2" 42 1/2" 41 1/2" 40 1/2" 39 1/2" 38 1/2" 37 1/2" 36 1/2" 35 1/2" 34 1/2" 33 1/2" 32 1/2" 31 1/2" 30 1/2" 29 1/2" 28 1/2" 27 1/2" 26 1/2" 25 1/2" 24 1/2" 23 1/2" 22 1/2" 21 1/2" 20 1/2" 19 1/2" 18 1/2" 17 1/2" 16 1/2" 15 1/2" 14 1/2" 13 1/2" 12 1/2" 11 1/2"	57 3/4" 56" 55 1/2" 54 1/2" 53 1/2" 52 1/2" 51 1/2" 50 1/2" 49 1/2" 48 1/2" 47 1/2" 46 1/2" 45 1/2" 44 1/2" 43 1/2" 42 1/2" 41 1/2" 40 1/2" 39 1/2" 38 1/2" 37 1/2" 36 1/2" 35 1/2" 34 1/2" 33 1/2" 32 1/2" 31 1/2" 30 1/2" 29 1/2" 28 1/2" 27 1/2" 26 1/2" 25 1/2" 24 1/2" 23 1/2" 22 1/2" 21 1/2" 20 1/2" 19 1/2" 18 1/2" 17 1/2" 16 1/2" 15 1/2" 14 1/2" 13 1/2" 12 1/2" 11 1/2"	61 3/4" 60" 59 1/2" 58 1/2" 57 1/2" 56 1/2" 55 1/2" 54 1/2" 53 1/2" 52 1/2" 51 1/2" 50 1/2" 49 1/2" 48 1/2" 47 1/2" 46 1/2" 45 1/2" 44 1/2" 43 1/2" 42 1/2" 41 1/2" 40 1/2" 39 1/2" 38 1/2" 37 1/2" 36 1/2" 35 1/2" 34 1/2" 33 1/2" 32 1/2" 31 1/2" 30 1/2" 29 1/2" 28 1/2" 27 1/2" 26 1/2" 25 1/2" 24 1/2" 23 1/2" 22 1/2" 21 1/2" 20 1/2" 19 1/2" 18 1/2" 17 1/2" 16 1/2" 15 1/2" 14 1/2" 13 1/2" 12 1/2" 11 1/2"	65 3/4" 64" 63 1/2" 62 1/2" 61 1/2" 60 1/2" 59 1/2" 58 1/2" 57 1/2" 56 1/2" 55 1/2" 54 1/2" 53 1/2" 52 1/2" 51 1/2" 50 1/2" 49 1/2" 48 1/2" 47 1/2" 46 1/2" 45 1/2" 44 1/2" 43 1/2" 42 1/2" 41 1/2" 40 1/2" 39 1/2" 38 1/2" 37 1/2" 36 1/2" 35 1/2" 34 1/2" 33 1/2" 32 1/2" 31 1/2" 30 1/2" 29 1/2" 28 1/2" 27 1/2" 26 1/2" 25 1/2" 24 1/2" 23 1/2" 22 1/2" 21 1/2" 20 1/2" 19 1/2" 18 1/2" 17 1/2" 16 1/2" 15 1/2" 14 1/2" 13 1/2" 12 1/2" 11 1/2"									
	75H3630-2	75H4030-2	75H4430-2	75H4830-2	75H5230-2	75H5630-2	75H6030-2	75H6430-2									
	75H3636-2	75H4036-2	75H4436-2	75H4836-2	75H5236-2	75H5636-2	75H6036-2	75H6436-2									
	75H3637-2	75H4037-2	75H4437-2	75H4837-2	75H5237-2	75H5637-2	75H6037-2	75H6437-2									
	75H3638-2	75H4038-2	75H4438-2	75H4838-2	75H5238-2	75H5638-2	75H6038-2	75H6438-2									
	75H3641-2	75H4041-2	75H4441-2	75H4841-2	75H5241-2	75H5641-2	75H6041-2	75H6441-2									
	75H3642-2	75H4042-2	75H4442-2	75H4842-2	75H5242-2	75H5642-2	75H6042-2	75H6442-2									
	75H3648-2	75H4048-2	75H4448-2	75H4848-2	75H5248-2	75H5648-2	75H6048-2	75H6448-2									
	75H3649-2	75H4049-2	75H4449-2	75H4849-2	75H5249-2	75H5649-2	75H6049-2	75H6449-2									
	75H3653-2	75H4053-2	75H4453-2	75H4853-2	75H5253-2	75H5653-2	75H6053-2	75H6453-2									
	75H3654-2	75H4054-2	75H4454-2	75H4854-2	75H5254-2	75H5654-2	75H6054-2	75H6454-2									
	75H3657-2	75H4057-2	75H4457-2	75H4857-2	75H5257-2	75H5657-2	75H6057-2	75H6457-2									
	75H3660-2	75H4060-2	75H4460-2	75H4860-2	75H5260-2	75H5660-2	75H6060-2	75H6460-2									

ELEVATION SYMBOL LEGEND:
VALUES IN [] ARE NUMBER OF DAYLIGHT OPENINGS PER UNIT

SCALE: 1/8" = 1'

2-WIDE SINGLE-HUNG SIDE LOAD

UNIT SIZE ROUGH OPENING FRAME SIZE DAYLIGHT OPENING	37 3/4" 36" 35 1/2" 14 25/32"[2] 12 3/16"[2]	41 3/4" 40" 39 1/2" 16 25/32"[2] 14 3/16"[2]	45 3/4" 44" 43 1/2" 18 25/32"[2] 16 3/16"[2]	49 3/4" 48" 47 1/2" 20 25/32"[2] 18 3/16"[2]	53 3/4" 52" 51 1/2" 22 25/32"[2] 20 3/16"[2]	57 3/4" 56" 55 1/2" 24 25/32"[2] 22 3/16"[2]	61 3/4" 60" 59 1/2" 26 25/32"[2] 24 3/16"[2]	65 3/4" 64" 63 1/2" 28 25/32"[2] 26 3/16"[2]
63 3/4" 62" 61 1/2" 28 9/16"[2] 27 1/4"[2]	 75H3662-2	 75H4062-2	 75H4462-2	 75H4862-2	 75H5262-2	 75H5662-2	 75H6062-2	 75H6462-2
66 3/4" 65" 64 1/2" 30 1/16"[2] 28 3/4"[2]	 75H3665-2	 75H4065-2	 75H4465-2	 75H4865-2	 75H5265-2	 75H5665-2	 75H6065-2	 75H6465-2
67 3/4" 66" 65 1/2" 30 9/16"[2] 29 1/4"[2]	 75H3666-2	 75H4066-2	 75H4466-2	 75H4866-2	 75H5266-2	 75H5666-2	 75H6066-2	 75H6466-2
70 3/4" 69" 68 1/2" 32 1/16"[2] 30 3/4"[2]	 75H3669-2	 75H4069-2	 75H4469-2	 75H4869-2	 75H5269-2	 75H5669-2	 75H6069-2	 75H6469-2
73 3/4" 72" 71 1/2" 33 9/16"[2] 32 1/4"[2]	 75H3672-2	 75H4072-2	 75H4472-2	 75H4872-2	 75H5272-2	 75H5672-2	 75H6072-2	 75H6472-2
75 3/4" 74" 73 1/2" 34 9/16"[2] 33 1/4"[2]	 75H3674-2	 75H4074-2	 75H4474-2	 75H4874-2	 75H5274-2	 75H5674-2	 75H6074-2 E	 75H6474-2 E
78 3/4" 77" 76 1/2" 36 1/16"[2] 34 3/4"[2]	 75H3677-2	 75H4077-2	 75H4477-2	 75H4877-2	 75H5277-2	 75H5677-2 E	 75H6077-2 E	 75H6477-2 E
79 3/4" 78" 77 1/2" 36 9/16"[2] 35 1/4"[2]	 75H3678-2	 75H4078-2	 75H4478-2	 75H4878-2	 75H5278-2	 75H5678-2 E	 75H6078-2 E	 75H6478-2 E
85 3/4" 84" 83 1/2" 39 9/16"[2] 38 1/4"[2]	 75H3684-2	 75H4084-2	 75H4484-2	 75H4884-2	 75H5284-2 E	 75H5684-2 E	 75H6084-2 E	 75H6484-2 E





















































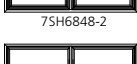
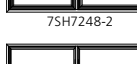
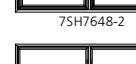
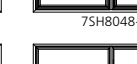





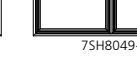









ELEVATION SYMBOL LEGEND:

VALUES IN [] ARE NUMBER OF DAYLIGHT OPENINGS PER UNIT

E UNIT MEETS EGRESS REQUIREMENTS FOR IRC CODE. STATE AND LOCAL EGRESS CODES MAY DIFFER. ALWAYS REFER TO LOCAL BUILDING CODES FOR COMPLETE REQUIREMENTS. CHECK WITH LOCAL OFFICIALS TO ENSURE COMPLIANCE BEFORE INSTALLING THE UNIT.

SCALE: 1/8" = 1'

2-WIDE SINGLE-HUNG SIDE LOAD

UNIT SIZE ROUGH OPENING FRAME SIZE DAYLIGHT OPENING	69 3/4" 68" 67 1/2" 30 25/32"[2] 28 3/16"[2]	73 3/4" 72" 71 1/2" 32 25/32"[2] 30 3/16"[2]	77 3/4" 76" 75 1/2" 34 25/32"[2] 32 3/16"[2]	81 3/4" 80" 79 1/2" 36 25/32"[2] 34 3/16"[2]	85 3/4" 84" 83 1/2" 38 25/32"[2] 36 3/16"[2]	93 3/4" 92" 91 1/2" 42 25/32"[2] 40 3/16"[2]
31 3/4" 31 3/4" 29 1/2" 12 9/16"[2] 11 1/4"[2]	 75H6830-2	 75H7230-2	 75H7630-2	 75H8030-2	 75H8430-2	 75H9230-2
37 3/4" 36" 35 1/2" 15 9/16"[2] 14 1/4"[2]	 75H6836-2	 75H7236-2	 75H7636-2	 75H8036-2	 75H8436-2	 75H9236-2
38 3/4" 36 1/2" 36 1/2" 16 1/16"[2] 14 3/4"[2]	 75H6837-2	 75H7237-2	 75H7637-2	 75H8037-2	 75H8437-2	 75H9237-2
39 3/4" 38" 37 1/2" 16 9/16"[2] 15 1/4"[2]	 75H6838-2	 75H7238-2	 75H7638-2	 75H8038-2	 75H8438-2	 75H9238-2
42 3/4" 40 1/2" 40 1/2" 18 1/16"[2] 16 3/4"[2]	 75H6841-2	 75H7241-2	 75H7641-2	 75H8041-2	 75H8441-2	 75H9241-2
43 3/4" 41 1/2" 41 1/2" 18 9/16"[2] 17 1/4"[2]	 75H6842-2	 75H7242-2	 75H7642-2	 75H8042-2	 75H8442-2	 75H9242-2
49 3/4" 47 1/2" 47 1/2" 21 9/16"[2] 20 1/4"[2]	 75H6848-2	 75H7248-2	 75H7648-2	 75H8048-2	 75H8448-2	 75H9248-2
50 3/4" 48 1/2" 48 1/2" 22 1/16"[2] 20 3/4"[2]	 75H6849-2	 75H7249-2	 75H7649-2	 75H8049-2	 75H8449-2	 75H9249-2
54 3/4" 52 1/2" 52 1/2" 24 1/16"[2] 22 3/4"[2]	 75H6853-2	 75H7253-2	 75H7653-2	 75H8053-2	 75H8453-2	 75H9253-2
55 3/4" 53 1/2" 53 1/2" 24 9/16"[2] 23 1/4"[2]	 75H6854-2	 75H7254-2	 75H7654-2	 75H8054-2	 75H8454-2	 75H9254-2
58 3/4" 56 1/2" 56 1/2" 26 1/16"[2] 24 3/4"[2]	 75H6857-2	 75H7257-2	 75H7657-2	 75H8057-2	 75H8457-2	 75H9257-2
61 3/4" 59 1/2" 59 1/2" 27 9/16"[2] 26 1/4"[2]	 75H6860-2	 75H7260-2 E	 75H7660-2 E	 75H8060-2 E	 75H8460-2 E	 75H9260-2 E

ELEVATION SYMBOL LEGEND:
VALUES IN [] ARE NUMBER OF DAYLIGHT OPENINGS PER UNIT
E UNIT MEETS EGRESS REQUIREMENTS FOR IRC CODE. STATE AND LOCAL EGRESS CODES MAY DIFFER. ALWAYS REFER TO LOCAL BUILDING CODES FOR COMPLETE REQUIREMENTS. CHECK WITH LOCAL OFFICIALS TO ENSURE COMPLIANCE BEFORE INSTALLING THE UNIT.

SCALE: 1/8" = 1'

2-WIDE SINGLE-HUNG SIDE LOAD

UNIT SIZE ROUGH OPENING FRAME SIZE DAYLIGHT OPENING	69 3/4" 68" 67 1/2" 30 25/32"[2] 28 3/16"[2]	73 3/4" 72" 71 1/2" 32 25/32"[2] 30 3/16"[2]	77 3/4" 76" 75 1/2" 34 25/32"[2] 32 3/16"[2]	81 3/4" 80" 79 1/2" 36 25/32"[2] 34 3/16"[2]	85 3/4" 84" 83 1/2" 38 25/32"[2] 36 3/16"[2]	93 3/4" 92" 91 1/2" 42 25/32"[2] 40 3/16"[2]
63 3/4" 62" 61 1/2" 28 9/16"[2] 27 1/4"[2]						
66 3/4" 65" 64 1/2" 30 17/16"[2] 28 3/4"[2]						
67 3/4" 66" 65 1/2" 30 9/16"[2] 29 1/4"[2]						
70 3/4" 69" 68 1/2" 32 17/16"[2] 30 3/4"[2]						
73 3/4" 72" 71 1/2" 33 9/16"[2] 32 1/4"[2]						
75 3/4" 74" 73 1/2" 34 9/16"[2] 33 1/4"[2]						
78 3/4" 77" 76 1/2" 36 17/16"[2] 34 3/4"[2]						
79 3/4" 78" 77 1/2" 36 9/16"[2] 35 1/4"[2]						
85 3/4" 84" 83 1/2" 39 9/16"[2] 38 1/4"[2]						

ELEVATION SYMBOL LEGEND:

VALUES IN [] ARE NUMBER OF DAYLIGHT OPENINGS PER UNIT

E UNIT MEETS EGRESS REQUIREMENTS FOR IRC CODE. STATE AND LOCAL EGRESS CODES MAY DIFFER. ALWAYS REFER TO LOCAL BUILDING CODES FOR COMPLETE REQUIREMENTS. CHECK WITH LOCAL OFFICIALS TO ENSURE COMPLIANCE BEFORE INSTALLING THE UNIT.

SCALE: 1/8" = 1'

2-WIDE SINGLE-HUNG SIDE LOAD

UNIT SIZE
ROUGH OPENING
FRAME SIZE
DAYLIGHT OPENING

97 3/4"
96"
95 1/2"
44 25/32"[2]
42 3/16"[2]

UNIT SIZE
ROUGH OPENING
FRAME SIZE
DAYLIGHT OPENING

97 3/4"
96"
95 1/2"
44 25/32"[2]
42 3/16"[2]

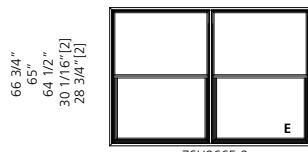
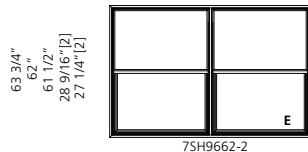
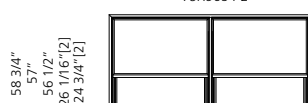
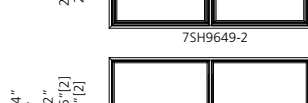
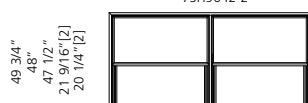
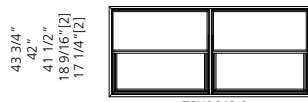
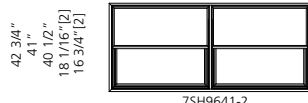
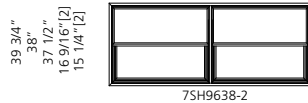
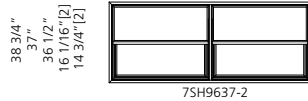
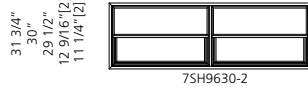

ELEVATION SYMBOL LEGEND:

VALUES IN [] ARE NUMBER OF DAYLIGHT OPENINGS PER UNIT

E UNIT MEETS EGRESS REQUIREMENTS FOR IRC CODE. STATE AND LOCAL EGRESS CODES MAY DIFFER. ALWAYS REFER TO LOCAL BUILDING CODES FOR COMPLETE REQUIREMENTS. CHECK WITH LOCAL OFFICIALS TO ENSURE COMPLIANCE BEFORE INSTALLING THE UNIT.

SCALE: 1/8" = 1'

**3-WIDE SINGLE-HUNG SIDE LOAD WITH CENTER PICTURE
WITH 24" FLANKER**





UNIT SIZE
ROUGH OPENING
FRAME SIZE
DAYLIGHT OPENING

UNIT SIZE ROUGH OPENING FRAME SIZE DAYLIGHT OPENING	85 3/4" 84" 83 1/2" 20 25/32"[2] 18 3/16"[2] 32 1/4"	97 3/4" 96" 95 1/2" 20 25/32"[2] 18 3/16"[2] 44 1/4"	109 3/4" 108" 107 1/2" 20 25/32"[2] 18 3/16"[2] 56 1/4"	121 3/4" 120" 119 1/2" 20 25/32"[2] 18 3/16"[2] 68 1/4"
31 3/4" 30" 29 1/2" 15 9/16" 11 1/4" 25 29/32"				
37 3/4" 36" 35 1/2" 15 9/16" 14 1/4" 31 29/32"				
43 3/4" 42" 41 1/2" 18 9/16" 17 1/4" 37 29/32"				
49 3/4" 48" 47 1/2" 21 9/16" 20 1/4" 43 29/32"				
55 3/4" 54" 53 1/2" 24 9/16" 23 1/4" 49 29/32"				
61 3/4" 60" 59 1/2" 27 9/16" 26 1/4" 55 29/32"				
67 3/4" 66" 65 1/2" 30 9/16" 29 1/4" 61 29/32"				
73 3/4" 72" 71 1/2" 33 9/16" 32 1/4" 67 29/32"				
79 3/4" 78" 77 1/2" 36 9/16" 35 1/4" 73 29/32"				
85 3/4" 84" 83 1/2" 39 9/16" 38 1/4" 79 29/32"				

ELEVATION SYMBOL LEGEND:
VALUES IN [] ARE NUMBER OF DAYLIGHT OPENINGS PER UNIT

SCALE: 1/8" = 1'

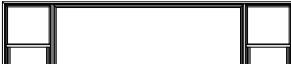
**3-WIDE SINGLE-HUNG SIDE LOAD WITH CENTER PICTURE
WITH 24" FLANKER**

UNIT SIZE	145 3/4"
ROUGH OPENING	144"
FRAME SIZE	143 1/2"
DAYLIGHT OPENING	20 25/32"[2] 18 3/16"[2] 92 1/4"
31 3/4" 30" 29 1/2" 25 29/32"	 7SH249630-3P
37 3/4" 36" 35 1/2" 31 29/32"	 7SH249636-3P
43 3/4" 42" 41 1/2" 37 29/32"	 7SH249642-3P
49 3/4" 48" 47 1/2" 43 29/32"	 7SH249648-3P
55 3/4" 54" 53 1/2" 49 29/32"	 7SH249654-3P

ELEVATION SYMBOL LEGEND:
VALUES IN [] ARE NUMBER OF DAYLIGHT OPENINGS PER UNIT

3-WIDE SINGLE-HUNG SIDE LOAD WITH CENTER PICTURE WITH 30" FLANKER

UNIT SIZE ROUGH OPENING FRAME SIZE DAYLIGHT OPENING	97 3/4" 96" 95 1/2" 26 25/32"[2] 24 3/16"[2] 32 1/4"	109 3/4" 108" 107 1/2" 26 25/32"[2] 24 3/16"[2] 44 1/4"	121 3/4" 120" 119 1/2" 26 25/32"[2] 24 3/16"[2] 56 1/4"	133 3/4" 132" 131 1/2" 26 25/32"[2] 24 3/16"[2] 68 1/4"
31 3/4" 30" 29 1/2" 35 1/2" 1 1/4" 12 9/16" 1 1/4" 23 29/32"				
37 3/4" 36" 35 1/2" 1 1/4" 15 9/16" 1 1/4" 31 29/32"				
43 3/4" 42" 41 1/2" 1 1/4" 18 9/16" 1 1/4" 37 29/32"				
49 3/4" 48" 47 1/2" 1 1/4" 21 9/16" 20 1/4" 43 29/32"				
55 3/4" 54" 53 1/2" 1 1/4" 24 9/16" 23 1/4" 49 29/32"				
61 3/4" 60" 59 1/2" 1 1/4" 27 9/16" 26 1/4" 55 29/32"				
67 3/4" 66" 65 1/2" 1 1/4" 30 9/16" 29 1/4" 61 29/32"				
73 3/4" 72" 71 1/2" 1 1/4" 33 9/16" 32 1/4" 67 29/32"				
79 3/4" 78" 77 1/2" 1 1/4" 36 9/16" 35 1/4" 73 29/32"				

ELEVATION SYMBOL LEGEND:
 VALUES IN [] ARE NUMBER OF DAYLIGHT OPENINGS PER UNIT
 E UNIT MEETS EGRESS REQUIREMENTS FOR IRC CODE. STATE AND LOCAL EGRESS CODES MAY DIFFER. ALWAYS REFER TO LOCAL BUILDING CODES FOR COMPLETE REQUIREMENTS.
 CHECK WITH LOCAL OFFICIALS TO ENSURE COMPLIANCE BEFORE INSTALLING THE UNIT.

SCALE: 1/8" = 1'

3-WIDE SINGLE-HUNG SIDE LOAD WITH CENTER PICTURE WITH 36" FLANKER

UNIT SIZE
ROUGH OPENING
FRAME SIZE
DAYLIGHT OPENING

UNIT SIZE	109 3/4"	121 3/4"	133 3/4"
ROUGH OPENING	108"	120"	132"
FRAME SIZE	107 1/2"	119 1/2"	131 1/2"
DAYLIGHT OPENING	32 25/32" [2] 30 3/16" [2] 32 1/4"	32 25/32" [2] 30 3/16" [2] 44 1/4"	32 25/32" [2] 30 3/16" [2] 56 1/4"
31 3/4" 30" 29 1/2" 29 1/2" 29 1/2" 25 29/32"			
37 3/4" 36" 35 1/2" 31 29/32"			
43 3/4" 42" 41 1/2" 37 29/32"			
49 3/4" 48" 47 1/2" 43 29/32"			
55 3/4" 54" 53 1/2" 49 29/32"			
61 3/4" 60" 59 1/2" 55 29/32"			
67 3/4" 66" 65 1/2" 61 29/32"			
73 3/4" 72" 71 1/2" 67 29/32"			

ELEVATION SYMBOL LEGEND:

VALUES IN [] ARE NUMBER OF DAYLIGHT OPENINGS PER UNIT

E UNIT MEETS EGRESS REQUIREMENTS FOR IRC CODE. STATE AND LOCAL EGRESS CODES MAY DIFFER. ALWAYS REFER TO LOCAL BUILDING CODES FOR COMPLETE REQUIREMENTS. CHECK WITH LOCAL OFFICIALS TO ENSURE COMPLIANCE BEFORE INSTALLING THE UNIT.

SCALE: 1/8" = 1'

GRILLE PATTERNS

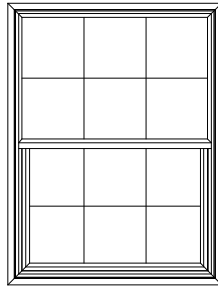

STANDARD

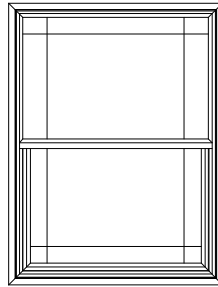

PRAIRIE

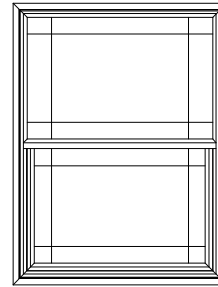

PRAIRIE SASH

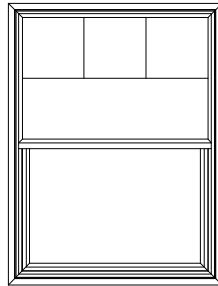

COLONIAL TOP SASH
1/2 LITE

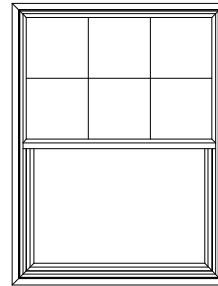

COLONIAL TOP SASH

SINGLE-HUNG SIDE LOAD

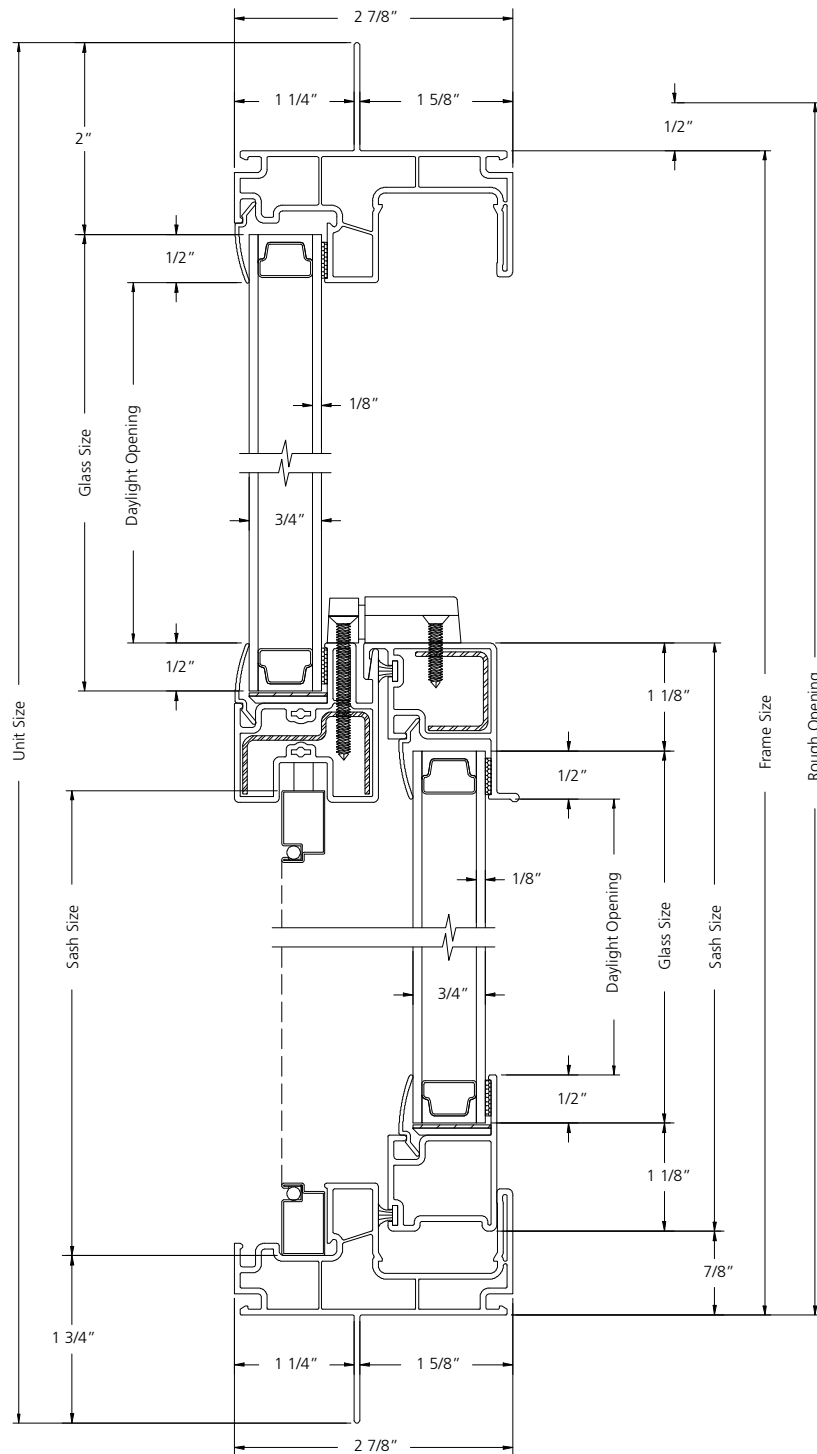

VERTICAL SECTION

SCALE: 6" = 1'

SINGLE-HUNG SIDE LOAD

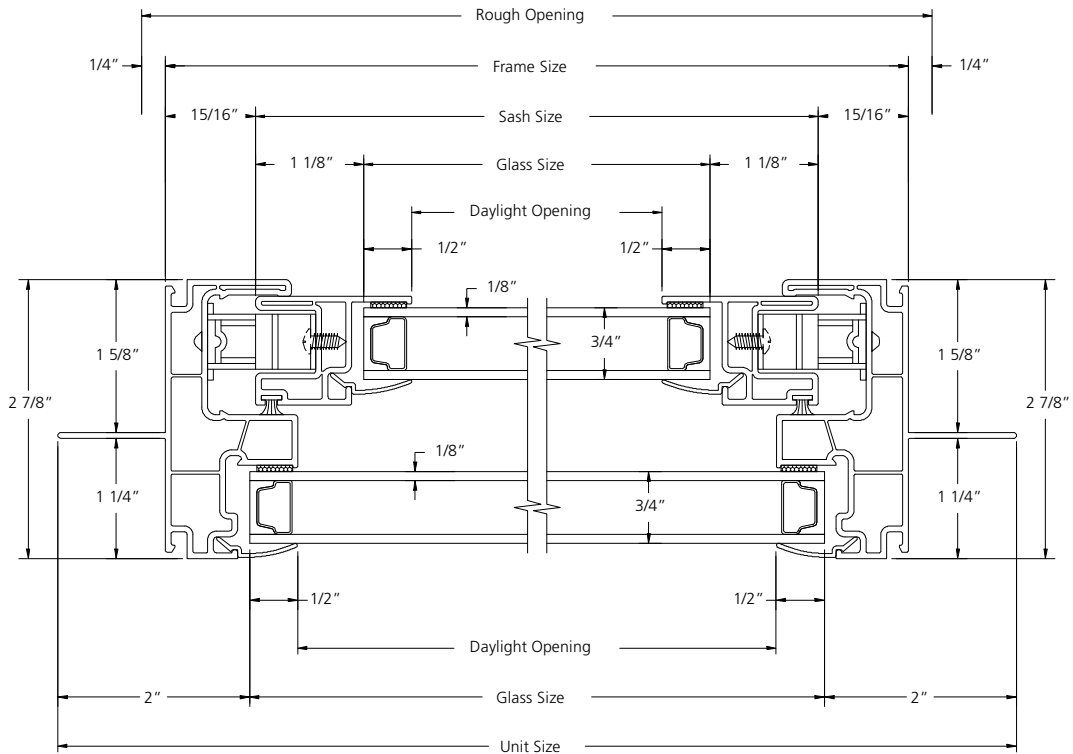

HORIZONTAL SECTION

SCALE: 6" = 1'

2-WIDE SINGLE-HUNG SIDE LOAD

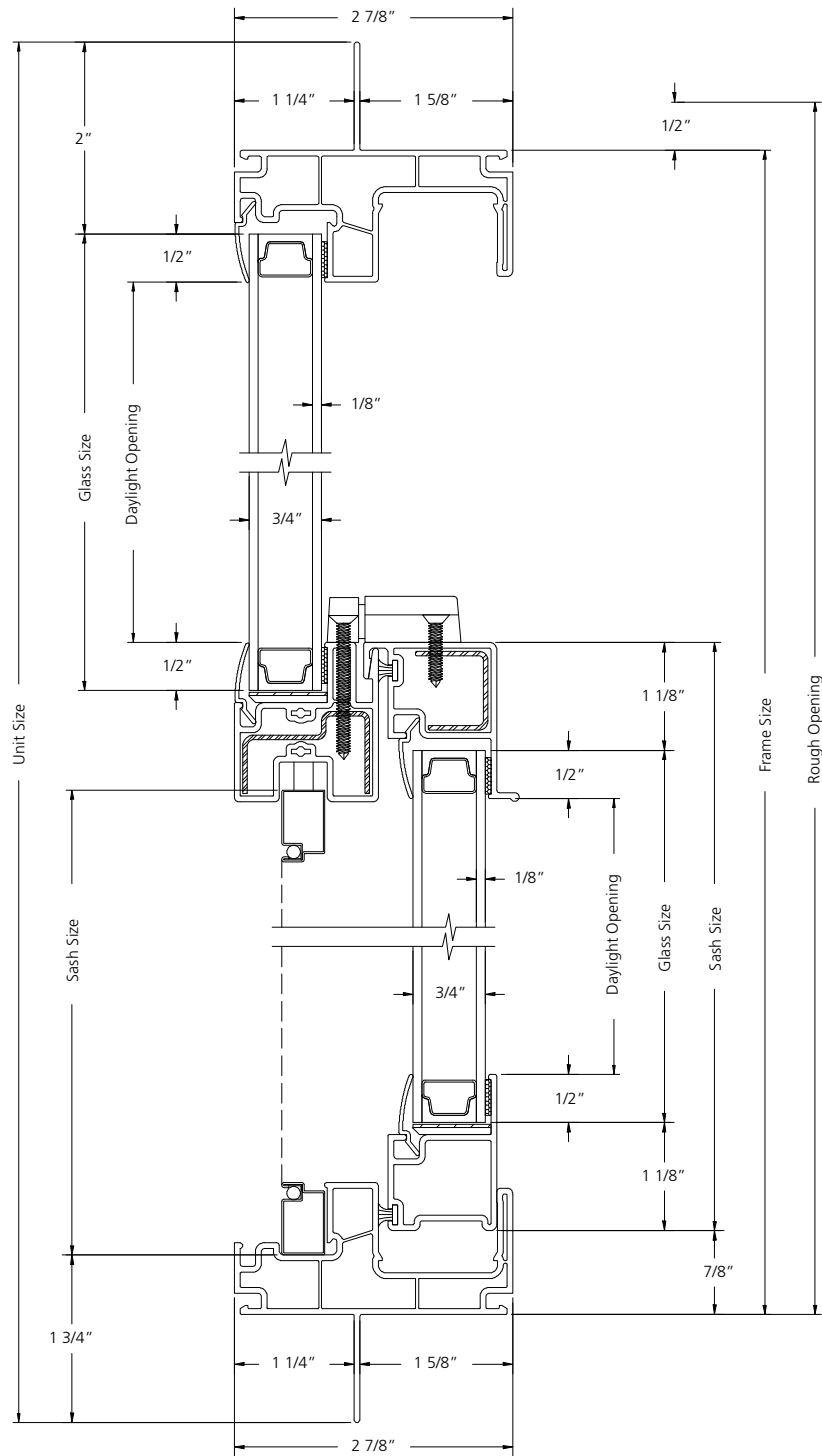

VERTICAL SECTION

SCALE: 6" = 1'

2-WIDE SINGLE-HUNG SIDE LOAD

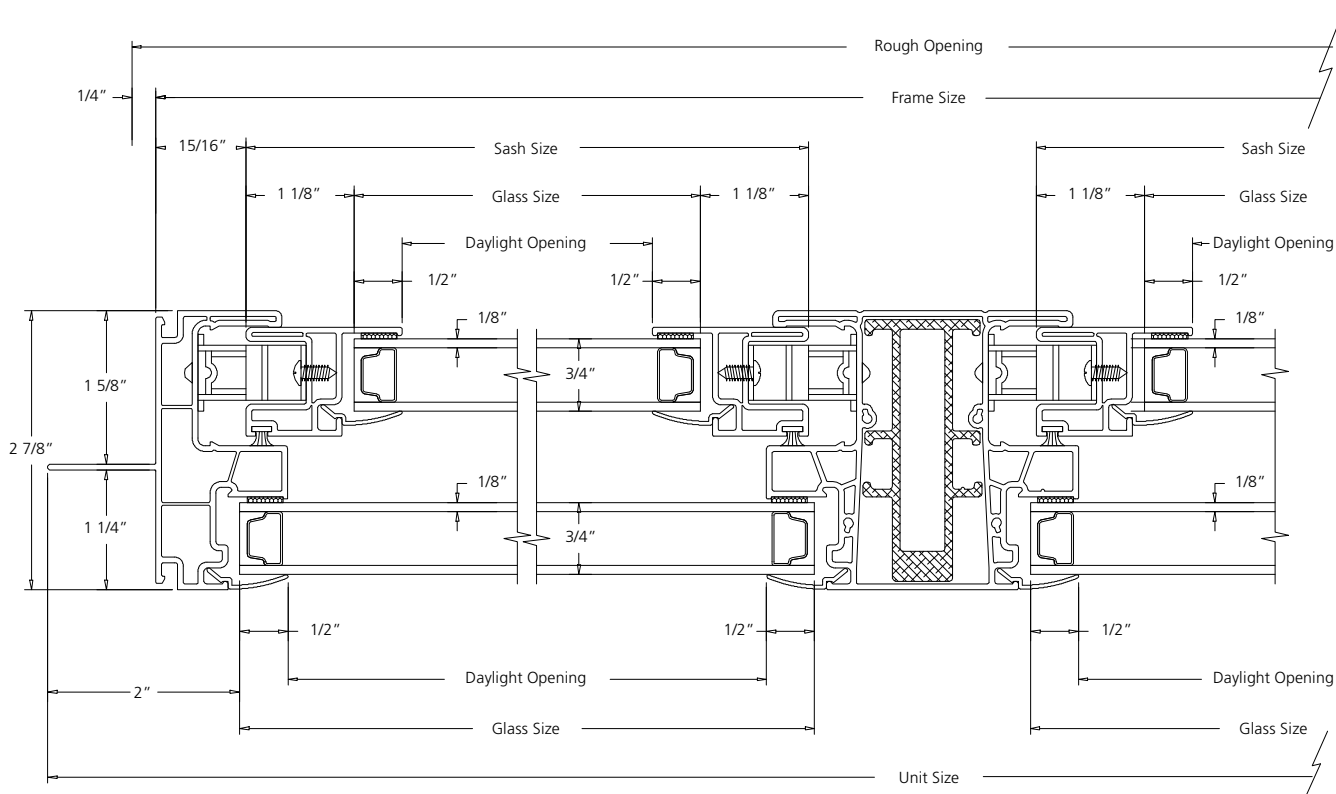

HORIZONTAL SECTION

SCALE: 6" = 1'

3-WIDE SINGLE-HUNG SIDE LOAD

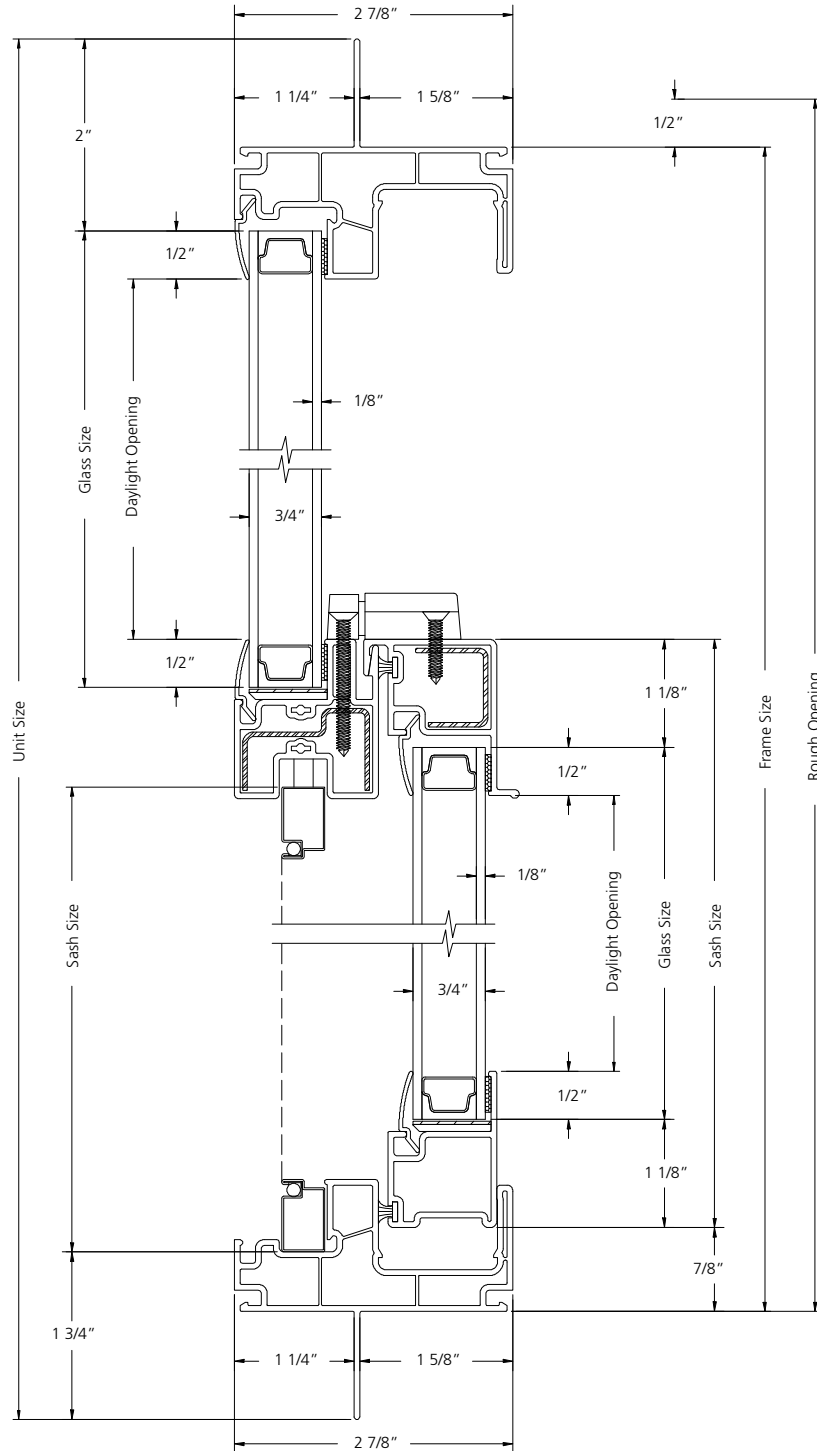

VERTICAL SECTION

SCALE: 6" = 1'

3-WIDE SINGLE-HUNG SIDE LOAD

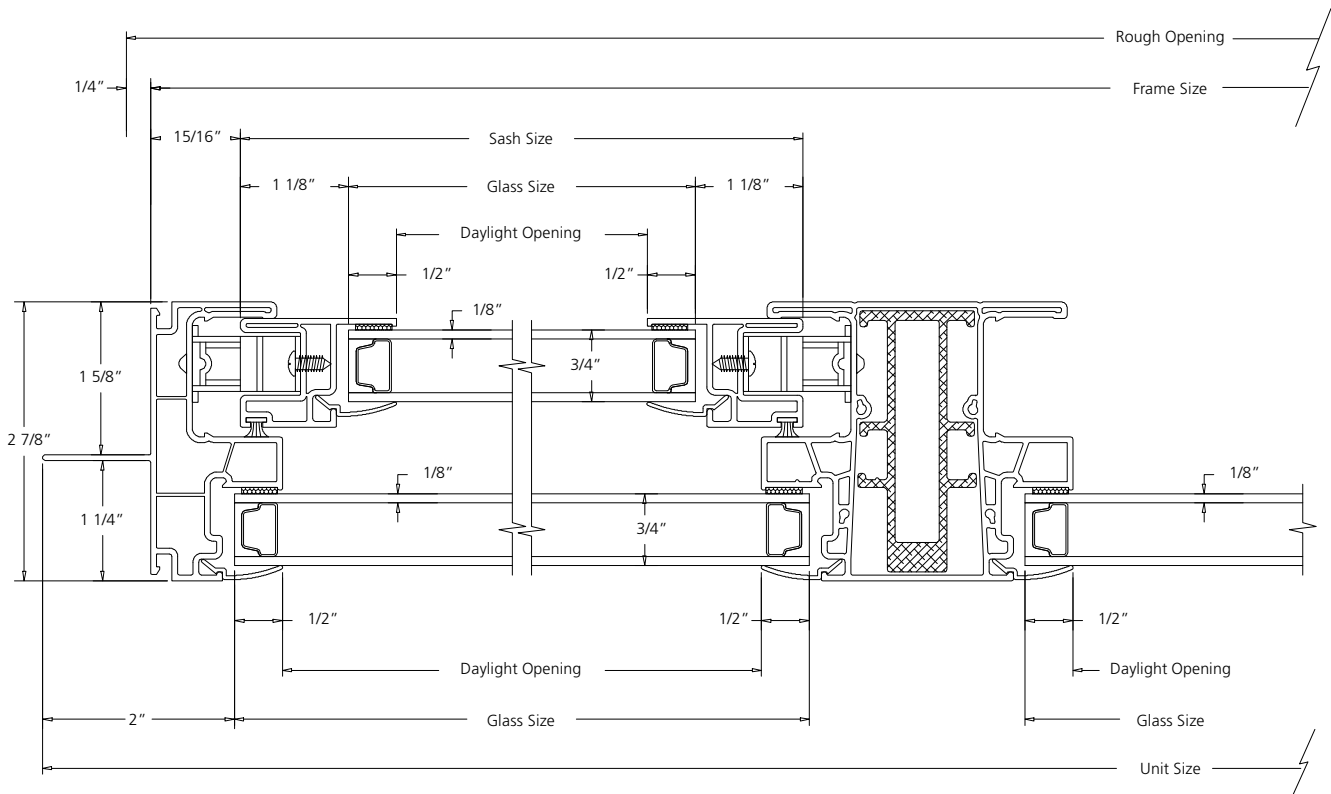

HORIZONTAL SECTION

SCALE: 6" = 1'