TABLE OF CONTENTS

| | |
|--|------|
| Specifications | 4-2 |
| Quick Spec Guide | 4-3 |
| Elevations:/Sizes 1/4" Scale | |
| Single-Hung Tilt | 4-4 |
| 2-Wide Single-Hung Tilt | 4-14 |
| 3-Wide Single-Hung Tilt with Center Picture with 24" Flanker | 4-19 |
| 3-Wide Single-Hung Tilt with Center Picture with 30" Flanker | 4-21 |
| 3-Wide Single-Hung Tilt with Center Picture with 36" Flanker | 4-22 |
| Grille Patterns | 4-23 |
| Section Details: 6" Scale | 4-24 |

PRODUCT SPECIFICATIONS

MATERIALS

The extruded vinyl profiles comply with the performance requirements of AAMA 303-97. The colors extend through the profile of the extrusion with White, Almond and Desert Sand colors available. The product is not available in the Western United States markets.

FRAME

All frames and sash are assembled using fusion-welding technology for added strength and durability. The frame jamb width is 2-29/32" (74 mm), and the nominal extrusion exterior wall thickness is 0.060". The wall depth of the single-hung product is 1-19/32". The frame incorporates an integral nailing fin which can be easily removed to allow the unit to be used in a replacement window application. The replacement product option includes a head expander and a sloped sill adapter which can be modified to accommodate various slope sills. Weep holes are included on the frame to ensure standing water is directed to the exterior plane of the unit. An interior and exterior accessory groove is standard to accommodate various frame accessory and assembly options on the product.

SASH

The tilt sash is a 1-3/8" (35mm) nominal thickness, and is assembled using fusion-welding technology for added strength and durability. The sash also uses a steel reinforcement bar in the horizontal meeting rails for additional strength. The fixed upper glass is direct-set into the unit frame.

GLAZING

3/4" (19mm) insulated glass consist of two lites of glass sealed around a spacer. The glass is mounted into the sash using a silicone-glazing compound. The insulating glass units comply with the performance requirements of the IGCC in accordance with either ASTM E774 or E2190. All units except the brickmould product are exterior glazed.

GLAZING OPTIONS

3/4" (19mm) insulated glass is available in clear, Low-E or Low-E 366, tinted, obscure or other specialty insulating glass as specified. Many glass options are available in tempered glazing. A single use reglazeable drywall unit option is available, allowing the user to remove the upper glass and meeting rail.

WEATHER-STRIPPING

A fin-pile weather-strip is applied along dual perimeter of the operating sash. The meeting rails utilize an integral extruded interlock to provide exceptional performance.

HARDWARE

The exclusive WEN-Lock™ with visible latch indicator or a single action cam style lock is available on all windows. Block and tackle balance systems are utilized to support the vertical operation of the sash. Low profile thumb latches (sash retainers) and pivot pins are equipped for utilization of the "tilt" function.

INSECT SCREENS

The optional fiberglass charcoal color insect screen is set in an aluminum frame to match the color of the unit. The screen is secured to the window using a pin and spring-loaded plunger system. Insect screens are intended to allow air and light in and to keep insects out. They are not intended to keep anyone or anything from falling through an open door or window. For safety screens or other security devices contact your local building supply retailer.

GRILLES

GBG (Grilles between the Glass) - 5/8" (16mm) and 7/8" (22.2mm) flat or 1" (26mm) contour grilles mounted between the glass panes suspended within the air cavity and color matched to the extrusion color.

EXTENSION JAMBS

Extension jambs are regionally available for JELD-WEN vinyl products. The 9/16" extension jambs are available in pine clear vinyl wrapped, primed wood, red oak and maple finishes and can be specified on three or four sides of the product.

ADDITIONAL ACCESSORIES

Additional accessories are available for JELD-WEN Vinyl products. Please contact your local building supply retailer for a complete listing of the additional accessories.

INSTALLATION

Installation per JELD-WEN Installation Method for Vinyl Windows JII001, JII010 or JII011. See www.jeld-wen.com/resources for instructions.

PERFORMANCE

NFRC Certified - (rated and labeled in accordance with NFRC)

AAMA/NWDMA I.S.2-97











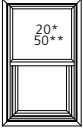
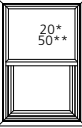
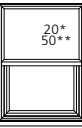



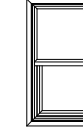

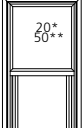
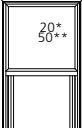
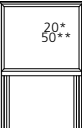

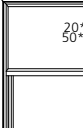

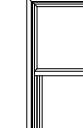

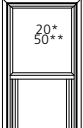
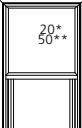
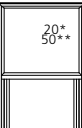



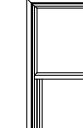

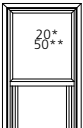
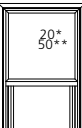
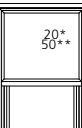



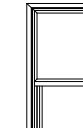

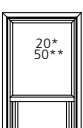
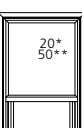

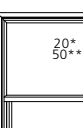
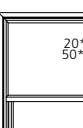
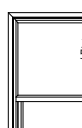
R20-DP rated

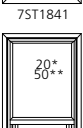
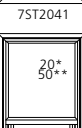
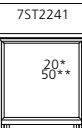
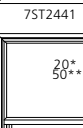
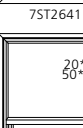
Optional DP-50 Ratings are available.

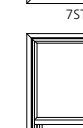
QUICK SPEC GUIDE

| SPECIFICATION | STANDARD FEATURES | OPTIONAL FEATURES <i>Some options may require additional lead times. Consult your JELD-WEN Sales Representative.</i> |
|---------------------------|--|---|
| COLOR | <ul style="list-style-type: none"> White | <ul style="list-style-type: none"> Almond Desert Sand <p><i>not available in all regions</i></p> |
| SIZE | <ul style="list-style-type: none"> Width: 18" to 48" Height: 24" to 77" | |
| FRAME | <ul style="list-style-type: none"> Integral Nail Fin | <ul style="list-style-type: none"> Pocket/Block Frame |
| GLAZING | <ul style="list-style-type: none"> Insulating Low-E | <ul style="list-style-type: none"> Clear Low-E 366 Low-E Keep Clean Obscure Bronze Gray Gluechip Rain Azurlite Laminated All glass available tempered <p><i>regional glass availabilities may differ</i></p> |
| HARDWARE | <ul style="list-style-type: none"> Block and Tackle Balance System WEN-Lock™ Tilt Latches | <ul style="list-style-type: none"> Cam Lock |
| HARDWARE COLOR | <ul style="list-style-type: none"> Color matched to extrusion | |
| SCREENS | <ul style="list-style-type: none"> Fiberglass | |
| SCREEN FRAME COLOR | <ul style="list-style-type: none"> Color matched to extrusion | |
| GRILLES | | <ul style="list-style-type: none"> 1" Contour GBG (grilles between the glass) 5/8", 7/8" Flat GBG (grilles between the glass) |
| JAMB DEPTH | <ul style="list-style-type: none"> 2-29/32" | <ul style="list-style-type: none"> Integral J-channel - 2-29/32" 4-9/16" Extension Jambs Applied 6-9/16" Extension Jambs Applied |
| ACCESSORIES | | <ul style="list-style-type: none"> Extension Jamb Retainer Drip Cap Drywall Retainer 14 Degree Sloped Sill Adapter (factory applied available) Head and Sill Expander |

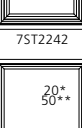
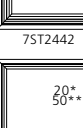
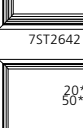
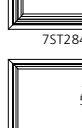
SINGLE-HUNG TILT











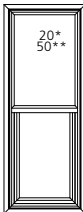
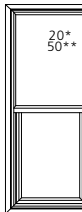

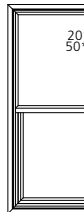
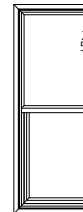
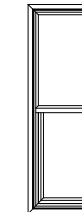

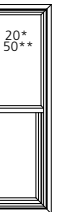
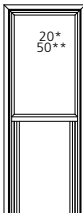



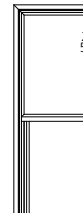
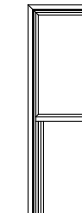

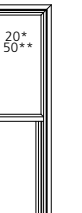
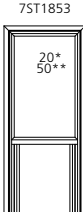
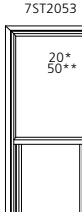
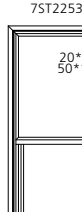
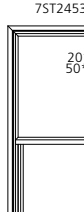

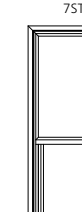

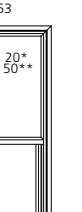
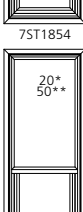
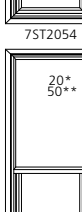
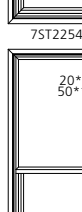
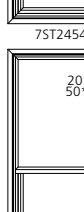
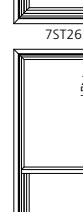
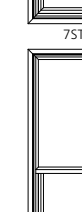
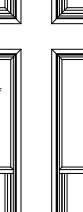
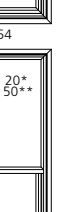
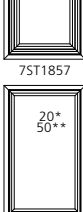
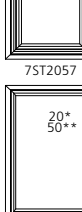
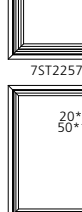
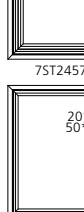

| UNIT SIZE | 19 3/4" | 21 3/4" | 23 3/4" | 25 3/4" | 27 3/4" | 29 3/4" | 31 3/4" | 33 3/4" |
|--|---|---|---|---|---|--|---|---|
| ROUGH OPENING | 18" | 20" | 22" | 24" | 26" | 28" | 30" | 32" |
| FRAME SIZE | 17 1/2" | 19 1/2" | 21 1/2" | 23 1/2" | 25 1/2" | 27 1/2" | 29 1/2" | 31 1/2" |
| DAYLIGHT OPENING | 14 25/32" 12 13/64" | 16 25/32" 14 13/64" | 18 25/32" 16 13/64" | 21 25/32" 19 13/64" | 22 25/32" 20 13/64" | 24 25/32" 22 13/64" | 26 25/32" 24 13/64" | 28 25/32" 26 13/64" |
| 31 3/4" 29 1/2" 11 1/4" 12 9/16" |  20* 50** 7ST1830 |  20* 50** 7ST2030 |  20* 50** 7ST2230 |  20* 50** 7ST2430 |  20* 50** 7ST2630 |  20* 50** 7ST2830 |  20* 50** 7ST3030 |  20* 50** 7ST3230 |
| 37 3/4" 36" 14 1/4" 15 9/16" |  20* 50** 7ST1836 |  20* 50** 7ST2036 |  20* 50** 7ST2236 |  20* 50** 7ST2436 |  20* 50** 7ST2636 |  20* 50** 7ST2836 |  20* 50** 7ST3036 |  20* 50** 7ST3236 |
| 38 3/4" 37" 14 3/4" 16 1/16" |  20* 50** 7ST1837 |  20* 50** 7ST2037 |  20* 50** 7ST2237 |  20* 50** 7ST2437 |  20* 50** 7ST2637 |  20* 50** 7ST2837 |  20* 50** 7ST3037 |  20* 50** 7ST3237 |
| 39 3/4" 38" 15 1/4" 16 9/16" |  20* 50** 7ST1838 |  20* 50** 7ST2038 |  20* 50** 7ST2238 |  20* 50** 7ST2438 |  20* 50** 7ST2638 |  20* 50** 7ST2838 |  20* 50** 7ST3038 |  20* 50** 7ST3238 |
| 42 3/4" 41" 16 3/4" 18 1/16" |  20* 50** 7ST1841 |  20* 50** 7ST2041 |  20* 50** 7ST2241 |  20* 50** 7ST2441 |  20* 50** 7ST2641 |  20* 50** 7ST2841 |  20* 50** 7ST3041 |  20* 50** 7ST3241 |
| 43 3/4" 42" 17 1/4" 18 9/16" |  20* 50** 7ST1842 |  20* 50** 7ST2042 |  20* 50** 7ST2242 |  20* 50** 7ST2442 |  20* 50** 7ST2642 |  20* 50** 7ST2842 |  20* 50** 7ST3042 |  20* 50** 7ST3242 |
| 49 3/4" 48" 20 1/4" 21 9/16" |  20* 50** 7ST1848 |  20* 50** 7ST2048 |  20* 50** 7ST2248 |  20* 50** 7ST2448 |  20* 50** 7ST2648 |  20* 50** 7ST2848 |  20* 50** 7ST3048 |  20* 50** 7ST3248 |

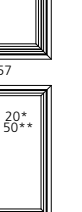
ELEVATION SYMBOL LEGEND:

NUMBER INDICATES DESIGN PRESSURE (DP) RATING WITH STANDARD GLAZING.
 ###* NUMBER INDICATES OPTIONAL DESIGN PRESSURE (DP) RATING.

SCALE: 1/4" = 1'

SINGLE-HUNG TILT

| UNIT SIZE | 19 3/4" | 21 3/4" | 23 3/4" | 25 3/4" | 27 3/4" | 29 3/4" | 31 3/4" | 33 3/4" |
|---|--|--|--|--|--|---|--|--|
| ROUGH OPENING | 18" | 20" | 22" | 24" | 26" | 28" | 30" | 32" |
| FRAME SIZE | 17 1/2" | 19 1/2" | 21 1/2" | 23 1/2" | 25 1/2" | 27 1/2" | 29 1/2" | 31 1/2" |
| DAYLIGHT OPENING | 14 25/32" 12 13/64" | 16 25/32" 14 13/64" | 18 25/32" 16 13/64" | 21 25/32" 19 13/64" | 22 25/32" 20 13/64" | 24 25/32" 22 13/64" | 26 25/32" 24 13/64" | 28 25/32" 26 13/64" |
| 50 3/4" 49" 48 1/2" 20 3/4" 22 1/16" |  7ST1849 |  7ST2049 |  7ST2249 |  7ST2449 |  7ST2649 |  7ST2849 |  7ST3049 |  7ST3249 |
| 54 3/4" 53" 52 1/2" 22 3/4" 24 1/16" |  7ST1853 |  7ST2053 |  7ST2253 |  7ST2453 |  7ST2653 |  7ST2853 |  7ST3053 |  7ST3253 |
| 55 3/4" 54" 53 1/2" 23 1/4" 24 9/16" |  7ST1854 |  7ST2054 |  7ST2254 |  7ST2454 |  7ST2654 |  7ST2854 |  7ST3054 |  7ST3254 |
| 58 3/4" 57" 56 1/2" 24 3/4" 26 1/16" |  7ST1857 |  7ST2057 |  7ST2257 |  7ST2457 |  7ST2657 |  7ST2857 |  7ST3057 |  7ST3257 |
| 61 3/4" 60" 59 1/2" 26 1/4" 27 9/16" |  7ST1860 |  7ST2060 |  7ST2260 |  7ST2460 |  7ST2660 |  7ST2860 |  7ST3060 |  7ST3260 |
| 63 3/4" 62" 61 1/2" 27 1/4" 28 9/16" |  7ST1862 |  7ST2062 |  7ST2262 |  7ST2462 |  7ST2662 |  7ST2862 |  7ST3062 |  7ST3262 |

ELEVATION SYMBOL LEGEND:
 ### NUMBER INDICATES DESIGN PRESSURE (DP) RATING WITH STANDARD GLAZING.
 ###* NUMBER INDICATES OPTIONAL DESIGN PRESSURE (DP) RATING.

SCALE: 1/4" = 1'







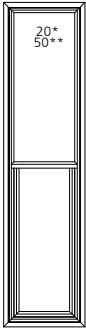
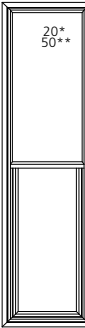
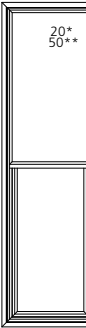

SINGLE-HUNG TILT

| UNIT SIZE | 19 3/4" | 21 3/4" | 23 3/4" | 25 3/4" | 27 3/4" | 29 3/4" | 31 3/4" | 33 3/4" |
|---|---------------------|---------------------|---------------------|---------------------|---------------------|---------------------|---------------------|---------------------|
| ROUGH OPENING | 18" | 20" | 22" | 24" | 26" | 28" | 30" | 32" |
| FRAME SIZE | 17 1/2" | 19 1/2" | 21 1/2" | 23 1/2" | 25 1/2" | 27 1/2" | 29 1/2" | 31 1/2" |
| DAYLIGHT OPENING | 14 25/32" 12 13/64" | 16 25/32" 14 13/64" | 18 25/32" 16 13/64" | 21 25/32" 19 13/64" | 22 25/32" 20 13/64" | 24 25/32" 22 13/64" | 26 25/32" 24 13/64" | 28 25/32" 26 13/64" |
| 66 3/4" 65" 64 1/2" 28 3/4" 30 1/16" | | | | | | | | |
| 67 3/4" 66" 65 1/2" 29 1/4" 30 9/16" | | | | | | | | |
| 70 3/4" 69" 68 1/2" 30 3/4" 32 1/16" | | | | | | | | |
| 73 3/4" 72" 71 1/2" 32 1/4" 33 9/16" | | | | | | | | |
| 75 3/4" 74" 73 1/2" 33 1/4" 34 9/16" | | | | | | | | |

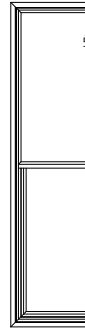
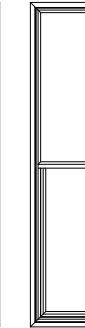
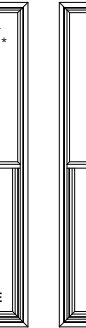
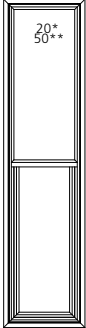
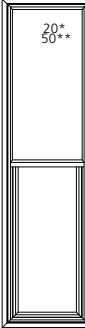
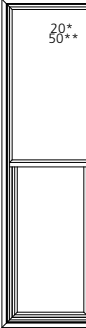
ELEVATION SYMBOL LEGEND:
 ### NUMBER INDICATES DESIGN PRESSURE (DP) RATING WITH STANDARD GLAZING.
 #### NUMBER INDICATES OPTIONAL DESIGN PRESSURE (DP) RATING.
 E UNIT MEETS EGRESS REQUIREMENTS FOR IRC CODE. STATE AND LOCAL EGRESS CODES MAY DIFFER. ALWAYS REFER TO LOCAL BUILDING CODES FOR COMPLETE REQUIREMENTS. CHECK WITH LOCAL OFFICIALS TO ENSURE COMPLIANCE BEFORE INSTALLING THE UNIT.

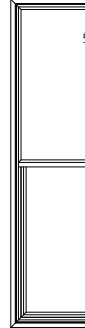
SCALE: 1/4" = 1'

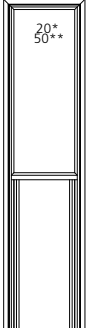
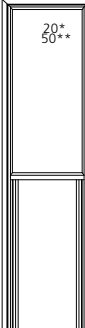
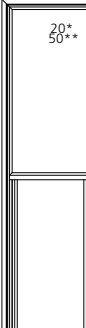
SINGLE-HUNG TILT

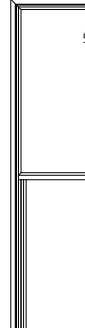
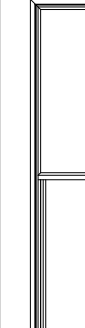
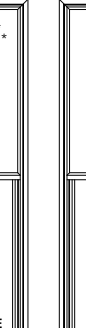
| UNIT SIZE | 19 3/4" | 21 3/4" | 23 3/4" | 25 3/4" | 27 3/4" | 29 3/4" | 31 3/4" | 33 3/4" |
|---|---|---|---|---|---|--|---|---|
| ROUGH OPENING | 18" | 20" | 22" | 24" | 26" | 28" | 30" | 32" |
| FRAME SIZE | 17 1/2" | 19 1/2" | 21 1/2" | 23 1/2" | 25 1/2" | 27 1/2" | 29 1/2" | 31 1/2" |
| DAYLIGHT OPENING | 14 25/32" 12 13/64" | 16 25/32" 14 13/64" | 18 25/32" 16 13/64" | 21 25/32" 19 13/64" | 22 25/32" 20 13/64" | 24 25/32" 22 13/64" | 26 25/32" 24 13/64" | 28 25/32" 26 13/64" |
| 78 3/4" 77 1/2" 76 1/2" 34 3/4" 36 1/16" |  |  |  |  |  |  |  |  |
| 75T1877 | 75T2077 | 75T2277 | 75T2477 | 75T2677 | 75T2877 | 75T3077 | 75T3277 | |
| 79 3/4" 78" 77 1/2" 35 1/4" 36 9/16" |  |  |  |  |  |  |  |  |
| 75T1878 | 75T2078 | 75T2278 | 75T2478 | 75T2678 | 75T2878 | 75T3078 | 75T3278 | |
| 85 3/4" 84" 83 1/2" 38 1/4" 39 9/16" |  |  |  |  |  |  |  |  |
| 75T1884 | 75T2084 | 75T2284 | 75T2484 | 75T2684 | 75T2884 | 75T3084 | 75T3284 | |

ELEVATION SYMBOL LEGEND:

*** NUMBER INDICATES DESIGN PRESSURE (DP) RATING WITH STANDARD GLAZING.











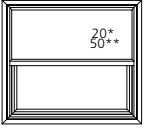
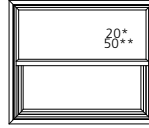
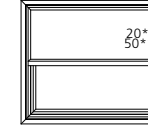
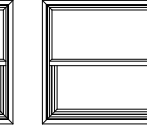
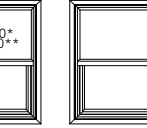
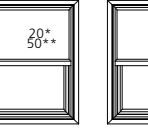
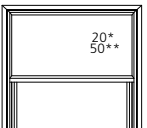
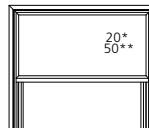
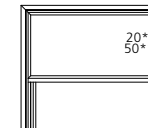
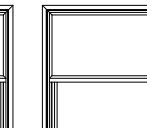
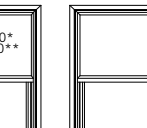
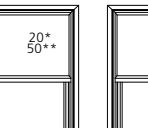
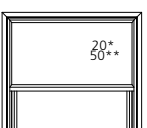
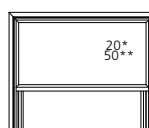
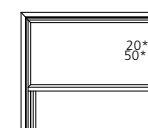
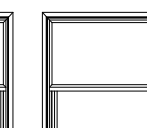
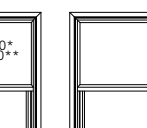
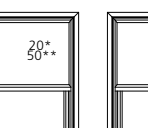
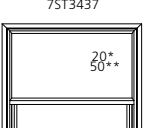
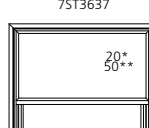
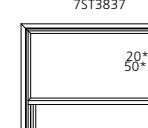
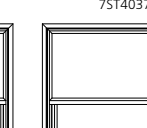

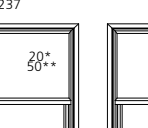
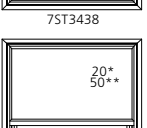
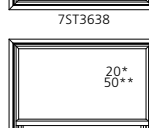
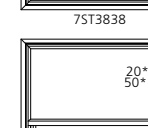
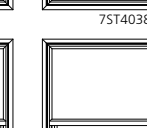
**** NUMBER INDICATES OPTIONAL DESIGN PRESSURE (DP) RATING.

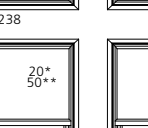
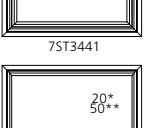
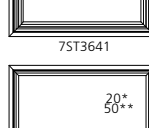
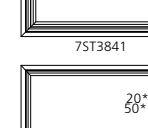
E UNIT MEETS EGRESS REQUIREMENTS FOR IRC CODE. STATE AND LOCAL EGRESS CODES MAY DIFFER. ALWAYS REFER TO LOCAL BUILDING CODES FOR COMPLETE REQUIREMENTS. CHECK WITH LOCAL OFFICIALS TO ENSURE COMPLIANCE BEFORE INSTALLING THE UNIT.

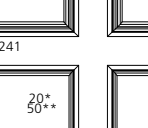
SCALE: 1/4" = 1'

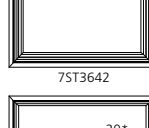
SINGLE-HUNG TILT

UNIT SIZE
ROUGH OPENING
FRAME SIZE
DAYLIGHT OPENING

| | 35 3/4" 34" 33 1/2" | 37 3/4" 36" 35 1/2" | 39 3/4" 38" 37 1/2" | 41 3/4" 40" 39 1/2" | 43 3/4" 42" 41 1/2" | 47 3/4" 46" 45 1/2" |
|---|---|---|---|---|--|---|
| | 30 25/32" 28 13/64" | 32 25/32" 30 13/64" | 34 25/32" 32 13/64" | 36 25/32" 34 13/64" | 38 25/32" 36 13/64" | 42 25/32" 40 13/64" |
| 31 3/4" 30" 29 1/2" 11 1/4" 12 9/16" |  20* 50** 7ST3430 |  20* 50** 7ST3630 |  20* 50** 7ST3830 |  20* 50** 7ST4030 |  20* 50** 7ST4230 |  20* 50** 7ST4630 |
| 37 3/4" 36" 35" 14 1/4" 15 9/16" |  20* 50** 7ST3436 |  20* 50** 7ST3636 |  20* 50** 7ST3836 |  20* 50** 7ST4036 |  20* 50** 7ST4236 |  20* 50** 7ST4636 |
| 38 3/4" 37 1/2" 36 1/2" 14 3/4" 16 1/16" |  20* 50** 7ST3437 |  20* 50** 7ST3637 |  20* 50** 7ST3837 |  20* 50** 7ST4037 |  20* 50** 7ST4237 |  20* 50** 7ST4637 |
| 39 3/4" 38" 37 1/2" 15 1/4" 16 9/16" |  20* 50** 7ST3438 |  20* 50** 7ST3638 |  20* 50** 7ST3838 |  20* 50** 7ST4038 |  20* 50** 7ST4238 |  20* 50** 7ST4638 |
| 42 3/4" 41" 40 1/2" 16 3/4" 18 1/16" |  20* 50** 7ST3441 |  20* 50** 7ST3641 |  20* 50** 7ST3841 |  20* 50** 7ST4041 |  20* 50** 7ST4241 |  20* 50** 7ST4641 |
| 43 3/4" 42" 41 1/2" 17 1/4" 18 9/16" |  20* 50** 7ST3442 |  20* 50** 7ST3642 |  20* 50** 7ST3842 |  20* 50** 7ST4042 |  20* 50** 7ST4242 |  20* 50** 7ST4642 |
| 49 3/4" 48" 47 1/2" 20 1/4" 21 9/16" |  20* 50** 7ST3448 |  20* 50** 7ST3648 |  20* 50** 7ST3848 |  20* 50** 7ST4048 |  20* 50** 7ST4248 |  20* 50** 7ST4648 |

ELEVATION SYMBOL LEGEND:
 ##* NUMBER INDICATES DESIGN PRESSURE (DP) RATING WITH STANDARD GLAZING.
 ###* NUMBER INDICATES OPTIONAL DESIGN PRESSURE (DP) RATING.

SCALE: 1/4" = 1'

SINGLE-HUNG TILT

UNIT SIZE
ROUGH OPENING
FRAME SIZE
DAYLIGHT OPENING

| | 35 3/4" 34" 33 1/2" | 37 3/4" 36" 35 1/2" | 39 3/4" 38" 37 1/2" | 41 3/4" 40" 39 1/2" | 43 3/4" 42" 41 1/2" | 47 3/4" 46" 45 1/2" |
|---|---------------------------|---------------------------|---------------------------|---------------------------|---------------------------|---------------------------|
| 30 25/32" 28 13/64" | 32 25/32" 30 13/64" | 34 25/32" 32 13/64" | 36 25/32" 34 13/64" | 38 25/32" 36 13/64" | 42 25/32" 40 13/64" | |
| 50 3/4" 49" 48 1/2" 20 3/4" 22 1/16" | 20* 50** | 20* 50** | 20* 50** | 20* 50** | 20* 50** | 20* 50** |
| 75T3449 | 75T3649 | 75T3849 | 75T4049 | 75T4249 | 75T4649 | |
| 54 3/4" 53" 52 1/2" 22 3/4" 24 1/16" | 20* 50** | 20* 50** | 20* 50** | 20* 50** | 20* 50** | 20* 50** |
| 75T3453 | 75T3653 | 75T3853 | 75T4053 | 75T4253 | 75T4653 | |
| 55 3/4" 54" 53 1/2" 23 1/4" 24 9/16" | 20* 50** | 20* 50** | 20* 50** | 20* 50** | 20* 50** | 20* 50** |
| 75T3454 | 75T3654 | 75T3854 | 75T4054 | 75T4254 | 75T4654 | |
| 58 3/4" 57" 56 1/2" 24 3/4" 26 1/16" | 20* 50** | 20* 50** | 20* 50** | 20* 50** | 20* 50** | 20* 50** |
| 75T3457 | 75T3657 | 75T3857 | 75T4057 | 75T4257 | 75T4657 | |
| 61 3/4" 60" 59 1/2" 26 1/4" 27 9/16" | 20* 50** | 20* 50** | 20* 50** | 20* 50** | 20* 50** | 20* 50** |
| 75T3460 | 75T3660 | 75T3860 | 75T4060 | 75T4260 | 75T4660 | |
| 63 3/4" 62" 61 1/2" 27 1/4" 28 9/16" | 20* 50** | 20* 50** | 20* 50** | 20* 50** | 20* 50** | 20* 50** |
| 75T3462 | 75T3662 | 75T3862 | 75T4062 | 75T4262 | 75T4662 | |

ELEVATION SYMBOL LEGEND:

###* NUMBER INDICATES DESIGN PRESSURE (DP) RATING WITH STANDARD GLAZING.







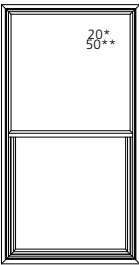
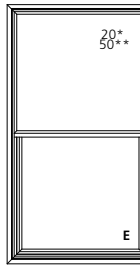
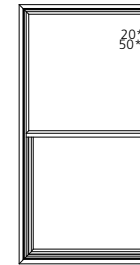

###** NUMBER INDICATES OPTIONAL DESIGN PRESSURE (DP) RATING.

E UNIT MEETS EGRESS REQUIREMENTS FOR IRC CODE. STATE AND LOCAL EGRESS CODES MAY DIFFER. ALWAYS REFER TO LOCAL BUILDING CODES FOR COMPLETE REQUIREMENTS. CHECK WITH LOCAL OFFICIALS TO ENSURE COMPLIANCE BEFORE INSTALLING THE UNIT.

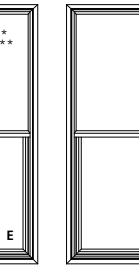
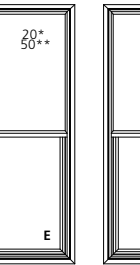
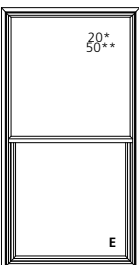
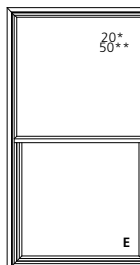
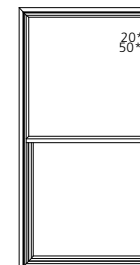
SCALE: 1/4" = 1'

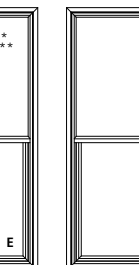
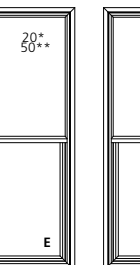
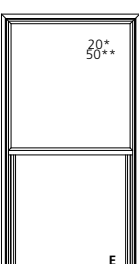
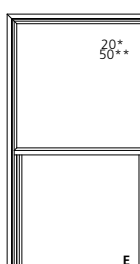
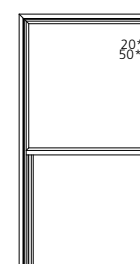
SINGLE-HUNG TILT

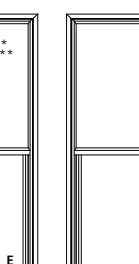
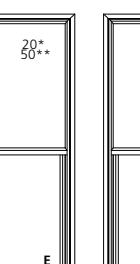
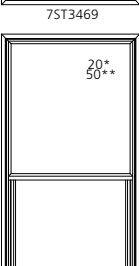
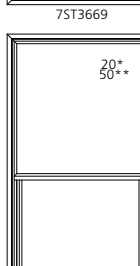
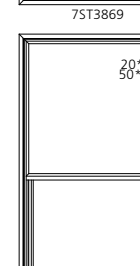
UNIT SIZE
ROUGH OPENING
FRAME SIZE
DAYLIGHT OPENING

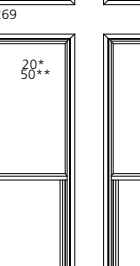
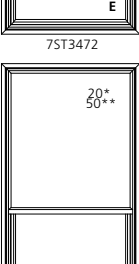
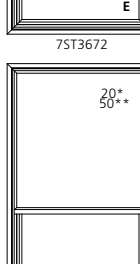
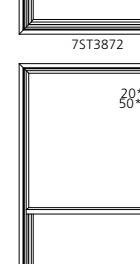
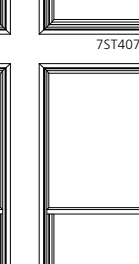
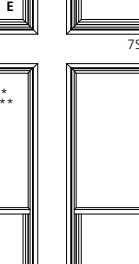
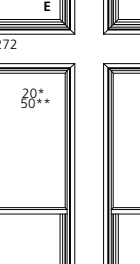



| | 35 3/4" 34" 33 1/2" 30 25/32" 28 13/64" | 37 3/4" 36" 35 1/2" 32 25/32" 30 13/64" | 39 3/4" 38" 37 1/2" 34 25/32" 32 13/64" | 41 3/4" 40" 39 1/2" 36 25/32" 34 13/64" | 43 3/4" 42" 41 1/2" 38 25/32" 36 13/64" | 47 3/4" 46" 45 1/2" 42 25/32" 40 13/64" |
|---|--|--|--|--|---|--|
| 66 3/4" 65 1/2" 64" 28 3/4" 30 1/16" |  7ST3465 |  7ST3665 |  7ST3865 |  7ST4065 |  7ST4265 |  7ST4665 |
| 67 3/4" 66 1/2" 65" 29 1/4" 30 9/16" |  7ST3466 |  7ST3666 |  7ST3866 |  7ST4066 |  7ST4266 |  7ST4666 |
| 70 3/4" 69 1/2" 68" 30 3/4" 32 1/16" |  7ST3469 |  7ST3669 |  7ST3869 |  7ST4069 |  7ST4269 |  7ST4669 |
| 73 3/4" 72 1/2" 71" 32 1/4" 33 9/16" |  7ST3472 |  7ST3672 |  7ST3872 |  7ST4072 |  7ST4272 |  7ST4672 |
| 75 3/4" 74 1/2" 73 1/2" 33 1/4" 34 9/16" |  7ST3474 |  7ST3674 |  7ST3874 |  7ST4074 |  7ST4274 |  7ST4674 |

ELEVATION SYMBOL LEGEND:
 ### NUMBER INDICATES DESIGN PRESSURE (DP) RATING WITH STANDARD GLAZING.
 ### NUMBER INDICATES OPTIONAL DESIGN PRESSURE (DP) RATING.
 E UNIT MEETS EGRESS REQUIREMENTS FOR IRC CODE. STATE AND LOCAL EGRESS CODES MAY DIFFER. ALWAYS REFER TO LOCAL BUILDING CODES FOR COMPLETE REQUIREMENTS. CHECK WITH LOCAL OFFICIALS TO ENSURE COMPLIANCE BEFORE INSTALLING THE UNIT.

SCALE: 1/4" = 1'

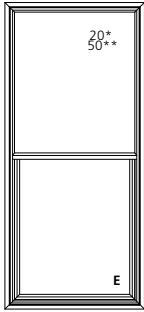
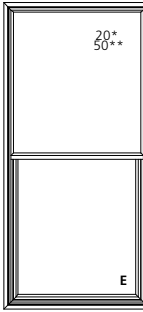
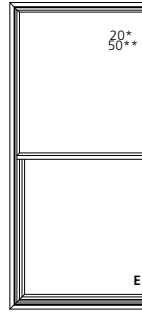
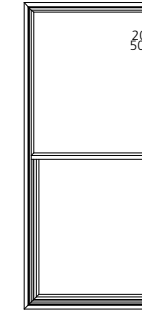
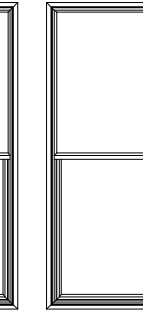
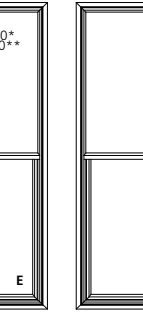
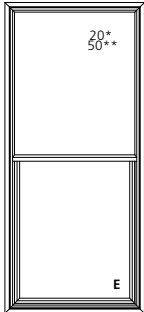
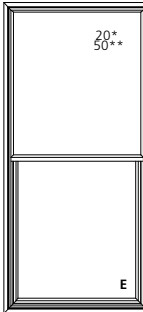
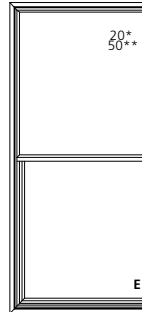
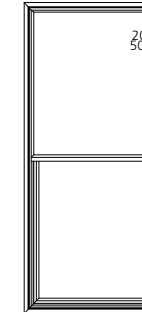
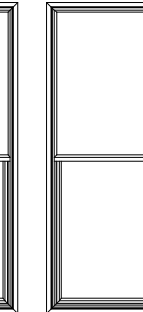
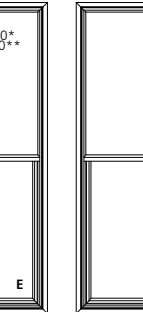
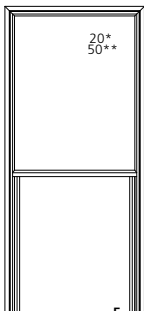
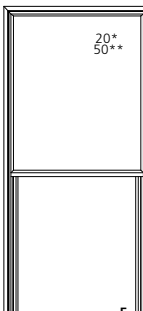
SINGLE-HUNG TILT

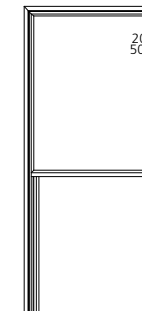
UNIT SIZE
ROUGH OPENING
FRAME SIZE
DAYLIGHT OPENING

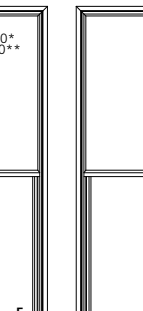
| | 35 3/4" 34" 33 1/2" | 37 3/4" 36" 35 1/2" | 39 3/4" 38" 37 1/2" | 41 3/4" 40" 39 1/2" | 43 3/4" 42" 41 1/2" | 47 3/4" 46" 45 1/2" |
|---|---|---|---|---|--|---|
| | 30 25/32" 28 13/64" | 32 25/32" 30 13/64" | 34 25/32" 32 13/64" | 36 25/32" 34 13/64" | 38 25/32" 36 13/64" | 42 25/32" 40 13/64" |
| 78 3/4" 76 1/2" 77" 34 3/4" 36 1/16" |  |  |  |  |  |  |
| | 75T3477 | 75T3677 | 75T3877 | 75T4077 | 75T4277 | 75T4677 |
| 79 3/4" 78" 77 1/2" 35 1/4" 36 9/16" |  |  |  |  |  |  |
| | 75T3478 | 75T3678 | 75T3878 | 75T4078 | 75T4278 | 75T4678 |
| 85 3/4" 84" 83 1/2" 38 1/4" 39 9/16" |  |  |  |  |  |  |
| | 75T3484 | 75T3684 | 75T3884 | 75T4084 | 75T4284 | 75T4684 |

ELEVATION SYMBOL LEGEND:

##* NUMBER INDICATES DESIGN PRESSURE (DP) RATING WITH STANDARD GLAZING.

###* NUMBER INDICATES OPTIONAL DESIGN PRESSURE (DP) RATING.

E UNIT MEETS EGRESS REQUIREMENTS FOR IRC CODE. STATE AND LOCAL EGRESS CODES MAY DIFFER. ALWAYS REFER TO LOCAL BUILDING CODES FOR COMPLETE REQUIREMENTS. CHECK WITH LOCAL OFFICIALS TO ENSURE COMPLIANCE BEFORE INSTALLING THE UNIT.

SCALE: 1/4" = 1'

SINGLE-HUNG TILT

| UNIT SIZE | ROUGH OPENING | FRAME SIZE | DAYLIGHT OPENING |
|-----------|---------------|------------|---------------------|
| 49 3/4" | 48" | 47 1/2" | 44 25/32" 42 13/64" |
| 31 3/4" | 36" | 29 1/2" | 11 1/4" 12 9/16" |
| | | | 20* 50** |
| | | | 7ST4830 |
| 37 3/4" | 36" | 35 1/2" | 14 1/4" 15 9/16" |
| | | | 20* 50** |
| | | | 7ST4836 |
| 38 3/4" | 37" | 36 1/2" | 14 3/4" 16 1/16" |
| | | | 20* 50** |
| | | | 7ST4837 |
| 39 3/4" | 38" | 37 1/2" | 15 1/4" 16 9/16" |
| | | | 20* 50** |
| | | | 7ST4838 |
| 42 3/4" | 41" | 40 1/2" | 16 3/4" 18 1/16" |
| | | | 20* 50** |
| | | | 7ST4841 |
| 43 3/4" | 42" | 41 1/2" | 17 1/4" 18 9/16" |
| | | | 20* 50** |
| | | | 7ST4842 |
| 49 3/4" | 48" | 47 1/2" | 20 1/4" 21 9/16" |
| | | | 20* 50** |
| | | | 7ST4848 |

| UNIT SIZE | ROUGH OPENING | FRAME SIZE | DAYLIGHT OPENING |
|-----------|---------------|------------|---------------------|
| 49 3/4" | 48" | 47 1/2" | 44 25/32" 42 13/64" |
| 50 3/4" | 49" | 48 1/2" | 20 3/4" 22 1/16" |
| | | | 20* 50** |
| | | | 7ST4849 |
| 54 3/4" | 53" | 52 1/2" | 22 3/4" 24 1/16" |
| | | | 20* 50** |
| | | | 7ST4853 |
| 55 3/4" | 54" | 53 1/2" | 23 1/4" 24 9/16" |
| | | | 20* 50** |
| | | | 7ST4854 |
| 58 3/4" | 57" | 56 1/2" | 24 3/4" 26 1/16" |
| | | | 20* 50** |
| | | | 7ST4857 |
| 61 3/4" | 60" | 59 1/2" | 26 1/4" 27 9/16" |
| | | | 20* 50** |
| | | | 7ST4860 |
| 63 3/4" | 62" | 61 1/2" | 27 1/4" 28 9/16" |
| | | | 20* 50** |
| | | | 7ST4862 |

| UNIT SIZE | ROUGH OPENING | FRAME SIZE | DAYLIGHT OPENING |
|-----------|---------------|------------|---------------------|
| 49 3/4" | 48" | 47 1/2" | 44 25/32" 42 13/64" |
| 66 3/4" | 65" | 64 1/2" | 28 3/4" 30 1/16" |
| | | | 20* 50** |
| | | | 7ST4865 |
| 67 3/4" | 66" | 65 1/2" | 29 1/4" 30 9/16" |
| | | | 20* 50** |
| | | | 7ST4866 |
| 70 3/4" | 69" | 68 1/2" | 30 3/4" 32 1/16" |
| | | | 20* 50** |
| | | | 7ST4869 |
| 73 3/4" | 72" | 71 1/2" | 32 1/4" 33 9/16" |
| | | | 20* 50** |
| | | | 7ST4872 |
| 75 3/4" | 74" | 73 1/2" | 33 1/4" 34 9/16" |
| | | | 20* 50** |
| | | | 7ST4874 |

ELEVATION SYMBOL LEGEND:
 ##* NUMBER INDICATES DESIGN PRESSURE (DP) RATING WITH STANDARD GLAZING.
 ##** NUMBER INDICATES OPTIONAL DESIGN PRESSURE (DP) RATING.
 E UNIT MEETS EGRESS REQUIREMENTS FOR IRC CODE. STATE AND LOCAL EGRESS CODES MAY DIFFER. ALWAYS REFER TO LOCAL BUILDING CODES FOR COMPLETE REQUIREMENTS. CHECK WITH LOCAL OFFICIALS TO ENSURE COMPLIANCE BEFORE INSTALLING THE UNIT.

SCALE: 1/4" = 1'

SINGLE-HUNG TILT

| | |
|------------------|---------------------|
| UNIT SIZE | 49 3/4" |
| ROUGH OPENING | 48" |
| FRAME SIZE | 47 1/2" |
| DAYLIGHT OPENING | 44 25/32" 42 13/64" |

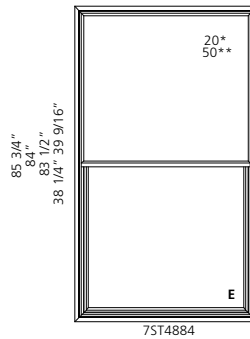
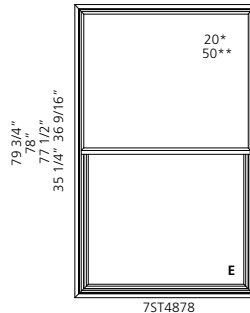
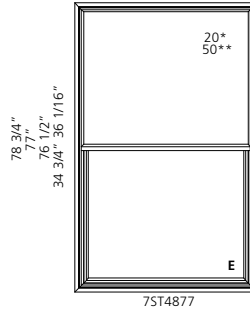

ELEVATION SYMBOL LEGEND:

*** NUMBER INDICATES DESIGN PRESSURE (DP) RATING WITH STANDARD GLAZING.

*** NUMBER INDICATES OPTIONAL DESIGN PRESSURE (DP) RATING.

E UNIT MEETS EGRESS REQUIREMENTS FOR IRC CODE. STATE AND LOCAL EGRESS CODES MAY DIFFER. ALWAYS REFER TO LOCAL BUILDING CODES FOR COMPLETE REQUIREMENTS. CHECK WITH LOCAL OFFICIALS TO ENSURE COMPLIANCE BEFORE INSTALLING THE UNIT.

SCALE: 1/4" = 1'

2-WIDE SINGLE-HUNG TILT

| UNIT SIZE | 38 3/4" | 41 3/4" | 45 3/4" | 49 3/4" | 53 3/4" | 57 3/4" | 61 3/4" | 65 3/4" |
|--|------------------------------|------------------------------|------------------------------|------------------------------|------------------------------|------------------------------|------------------------------|------------------------------|
| ROUGH OPENING | 36" | 40" | 44" | 48" | 52" | 56" | 60" | 64" |
| FRAME SIZE | 35 1/2" | 39 1/2" | 43 1/2" | 47 1/2" | 51 1/2" | 55 1/2" | 59 1/2" | 63 1/2" |
| DAYLIGHT OPENING | 14 25/32"[2] 12 13/64"[2] | 16 25/32"[2] 14 13/64"[2] | 18 25/32"[2] 16 13/64"[2] | 21 25/32"[2] 19 13/64"[2] | 22 25/32"[2] 20 13/64"[2] | 24 25/32"[2] 22 13/64"[2] | 26 25/32"[2] 24 13/64"[2] | 28 25/32"[2] 26 13/64"[2] |
| 32 3/4" 30" 29 1/2" 11 1/4"[2] 12 9/16"[2] | | | | | | | | |
| 37 3/4" 36" 35 1/2" 14 1/4"[2] 15 9/16"[2] | | | | | | | | |
| 38 3/4" 37" 36 1/2" 14 3/4"[2] 16 1/16"[2] | | | | | | | | |
| 39 3/4" 38" 37 1/2" 15 1/4"[2] 16 9/16"[2] | | | | | | | | |
| 42 3/4" 41" 40 1/2" 16 3/4"[2] 18 1/16"[2] | | | | | | | | |
| 43 3/4" 42" 41 1/2" 17 1/4"[2] 18 9/16"[2] | | | | | | | | |
| 49 3/4" 48" 47 1/2" 20 1/4"[2] 21 9/16"[2] | | | | | | | | |
| 50 3/4" 49" 48 1/2" 20 3/4"[2] 22 1/16"[2] | | | | | | | | |
| 54 3/4" 53" 52 1/2" 22 3/4"[2] 24 1/16"[2] | | | | | | | | |
| 55 3/4" 54" 53 1/2" 23 1/4"[2] 24 9/16"[2] | | | | | | | | |
| 58 3/4" 57" 56 1/2" 24 3/4"[2] 26 1/16"[2] | | | | | | | | |
| 61 3/4" 60" 59 1/2" 26 1/4"[2] 27 9/16"[2] | | | | | | | | |

ELEVATION SYMBOL LEGEND:
VALUES IN [] ARE NUMBER OF DAYLIGHT OPENINGS PER UNIT

SCALE: 1/8" = 1'

2-WIDE SINGLE-HUNG TILT

| UNIT SIZE | 38 3/4" | 41 3/4" | 45 3/4" | 49 3/4" | 53 3/4" | 57 3/4" | 61 3/4" | 65 3/4" |
|--|------------------------------|------------------------------|------------------------------|------------------------------|------------------------------|------------------------------|------------------------------|------------------------------|
| ROUGH OPENING | 36" | 40" | 44" | 48" | 52" | 56" | 60" | 64" |
| FRAME SIZE | 35 1/2" | 39 1/2" | 43 1/2" | 47 1/2" | 51 1/2" | 55 1/2" | 59 1/2" | 63 1/2" |
| DAYLIGHT OPENING | 14 25/32"[2] 12 13/64"[2] | 16 25/32"[2] 14 13/64"[2] | 18 25/32"[2] 16 13/64"[2] | 21 25/32"[2] 19 13/64"[2] | 22 25/32"[2] 20 13/64"[2] | 24 25/32"[2] 22 13/64"[2] | 26 25/32"[2] 24 13/64"[2] | 28 25/32"[2] 26 13/64"[2] |
| 63 3/4" 62" 61 1/2" 27 1/4"[2] 28 9/16"[2] | | | | | | | | |
| 66 3/4" 65" 64 1/2" 28 3/4"[2] 30 1/16"[2] | | | | | | | | |
| 67 3/4" 66" 65 1/2" 29 1/4"[2] 30 9/16"[2] | | | | | | | | |
| 70 3/4" 69" 68 1/2" 30 3/4"[2] 32 1/16"[2] | | | | | | | | |
| 73 3/4" 72" 71 1/2" 32 1/4"[2] 33 9/16"[2] | | | | | | | | |
| 75 3/4" 74" 73 1/2" 33 1/4"[2] 34 9/16"[2] | | | | | | | | |
| 78 3/4" 77" 76 1/2" 34 3/4"[2] 36 1/16"[2] | | | | | | | | |
| 79 3/4" 78" 77 1/2" 35 1/4"[2] 36 9/16"[2] | | | | | | | | |
| 85 3/4" 84" 83 1/2" 38 1/4"[2] 39 9/16"[2] | | | | | | | | |

ELEVATION SYMBOL LEGEND:
E UNIT MEETS EGRESS REQUIREMENTS FOR IRC CODE. STATE AND LOCAL EGRESS CODES MAY DIFFER. ALWAYS REFER TO LOCAL BUILDING CODES FOR COMPLETE REQUIREMENTS. CHECK WITH LOCAL OFFICIALS TO ENSURE COMPLIANCE BEFORE INSTALLING THE UNIT.

SCALE: 1/8" = 1'

2-WIDE SINGLE-HUNG TILT

| UNIT SIZE ROUGH OPENING FRAME SIZE DAYLIGHT OPENING | 69 3/4" 68" 57 1/2" 30 25/32"[2] 28 13/64"[2] | 73 3/4" 72" 71 1/2" 32 25/32"[2] 30 13/64"[2] | 77 3/4" 76" 75 1/2" 34 25/32"[2] 32 13/64"[2] | 81 3/4" 80" 79 1/2" 36 25/32"[2] 34 13/64"[2] | 85 3/4" 84" 83 1/2" 38 25/32"[2] 36 13/64"[2] | 93 3/4" 92" 91 1/2" 42 25/32"[2] 40 13/64"[2] |
|--|---|---|---|---|---|---|
| 32 3/4" 30" 29 1/2" 11 1/4"[2] 12 9/16"[2] | | | | | | |
| 37 3/4" 36" 35 1/2" 14 1/4"[2] 15 9/16"[2] | | | | | | |
| 38 3/4" 37" 36 1/2" 14 3/4"[2] 16 1/16"[2] | | | | | | |
| 39 3/4" 38" 37 1/2" 15 1/4"[2] 16 9/16"[2] | | | | | | |
| 42 3/4" 41" 40 1/2" 16 3/4"[2] 18 1/16"[2] | | | | | | |
| 43 3/4" 42" 41 1/2" 17 1/4"[2] 18 9/16"[2] | | | | | | |
| 49 3/4" 48" 47 1/2" 20 1/4"[2] 21 9/16"[2] | | | | | | |
| 50 3/4" 49" 48 1/2" 20 3/4"[2] 22 1/16"[2] | | | | | | |
| 54 3/4" 53" 52 1/2" 22 3/4"[2] 24 1/16"[2] | | | | | | |
| 55 3/4" 54" 53 1/2" 23 1/4"[2] 24 9/16"[2] | | | | | | |
| 58 3/4" 57" 56 1/2" 24 3/4"[2] 26 1/16"[2] | | | | | | |
| 61 3/4" 60" 59 1/2" 26 7/8"[2] 27 9/16"[2] | | | | | | |

ELEVATION SYMBOL LEGEND:
E UNIT MEETS EGRESS REQUIREMENTS FOR IRC CODE. STATE AND LOCAL EGRESS CODES MAY DIFFER. ALWAYS REFER TO LOCAL BUILDING CODES FOR COMPLETE REQUIREMENTS. CHECK WITH LOCAL OFFICIALS TO ENSURE COMPLIANCE BEFORE INSTALLING THE UNIT.

SCALE: 1/8" = 1'

2-WIDE SINGLE-HUNG TILT

UNIT SIZE
ROUGH OPENING
FRAME SIZE
DAYLIGHT OPENING

| | 69 3/4" 68" 67 1/2" 30 25/32"[2] 28 13/64"[2] | 73 3/4" 72" 71 1/2" 32 25/32"[2] 30 13/64"[2] | 77 3/4" 76" 75 1/2" 34 25/32"[2] 32 13/64"[2] | 81 3/4" 80" 79 1/2" 36 25/32"[2] 34 13/64"[2] | 85 3/4" 84" 83 1/2" 38 25/32"[2] 36 13/64"[2] | 93 3/4" 92" 91 1/2" 42 25/32"[2] 40 13/64"[2] |
|--|---|---|---|---|---|---|
| 63 3/4" 61 1/2" 61 1/2" 27 1/4"[2] 28 9/16"[2] | | | | | | |
| 66 3/4" 65" 64 1/2" 28 3/4"[2] 30 1/16"[2] | | | | | | |
| 67 3/4" 66 1/2" 66 1/2" 29 1/4"[2] 30 9/16"[2] | | | | | | |
| 70 3/4" 69 1/2" 68 1/2" 30 3/4"[2] 32 1/16"[2] | | | | | | |
| 73 3/4" 71 1/2" 71 1/2" 32 1/4"[2] 33 9/16"[2] | | | | | | |
| 75 3/4" 74 1/2" 73 1/2" 33 1/4"[2] 34 9/16"[2] | | | | | | |
| 78 3/4" 76 1/2" 76 1/2" 34 3/4"[2] 36 1/16"[2] | | | | | | |
| 79 3/4" 78 1/2" 77 1/2" 35 1/4"[2] 36 9/16"[2] | | | | | | |
| 85 3/4" 84 1/2" 83 1/4" 39 9/16"[2] | | | | | | |

ELEVATION SYMBOL LEGEND:

E UNIT MEETS EGRESS REQUIREMENTS FOR IRC CODE. STATE AND LOCAL EGRESS CODES MAY DIFFER. ALWAYS REFER TO LOCAL BUILDING CODES FOR COMPLETE REQUIREMENTS. CHECK WITH LOCAL OFFICIALS TO ENSURE COMPLIANCE BEFORE INSTALLING THE UNIT.

SCALE: 1/8" = 1'

2-WIDE SINGLE-HUNG TILT

UNIT SIZE
ROUGH OPENING
FRAME SIZE
DAYLIGHT OPENING

97 3/4"
96"
95 1/2"
44 25/32"[2]
42 13/64"[2]

32 3/4"
30"
29 1/2"
11 1/4"[2]
12 9/16"[2]



7ST9630-2

37 3/4"
36"
35 1/2"
14 1/4"[2]
15 9/16"[2]



7ST9636-2

38 3/4"
37"
36 1/2"
14 3/4"[2]
16 1/16"[2]



7ST9637-2

39 3/4"
38"
37 1/2"
15 1/4"[2]
16 9/16"[2]



7ST9638-2

42 3/4"
41"
40 1/2"
16 3/4"[2]
18 1/16"[2]



7ST9641-2

43 3/4"
42"
41 1/2"
17 1/4"[2]
18 9/16"[2]

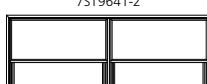

7ST9642-2

49 3/4"
48"
47 1/2"
20 1/4"[2]
21 9/16"[2]

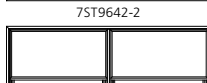

7ST9648-2

50 3/4"
49"
48 1/2"
20 3/4"[2]
22 1/16"[2]



7ST9649-2

54 3/4"
53"
52 1/2"
22 3/4"[2]
24 1/16"[2]

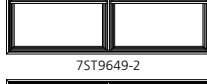

7ST9653-2

55 3/4"
54"
53 1/2"
23 1/4"[2]
24 9/16"[2]



7ST9654-2

58 3/4"
57"
56 1/2"
24 3/4"[2]
26 1/16"[2]



7ST9657-2

61 3/4"
60"
59 1/2"
25 1/4"[2]
27 9/16"[2]



7ST9660-2

UNIT SIZE
ROUGH OPENING
FRAME SIZE
DAYLIGHT OPENING

97 3/4"
96"
95 1/2"
44 25/32"[2]
42 13/64"[2]

63 3/4"
62"
61 1/2"
27 1/4"[2]
28 9/16"[2]



7ST9662-2

66 3/4"
65"
64 1/2"
28 3/4"[2]
30 1/16"[2]

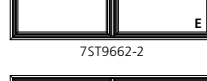

7ST9665-2

67 3/4"
66"
65 1/2"
29 1/4"[2]
30 9/16"[2]



7ST9666-2

70 3/4"
69"
68 1/2"
30 3/4"[2]
32 1/16"[2]

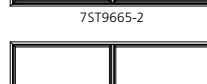

7ST9669-2

73 3/4"
72"
71 1/2"
32 1/4"[2]
33 9/16"[2]



7ST9672-2

ELEVATION SYMBOL LEGEND:

E UNIT MEETS EGRESS REQUIREMENTS FOR IRC CODE. STATE AND LOCAL EGRESS CODES MAY DIFFER. ALWAYS REFER TO LOCAL BUILDING CODES FOR COMPLETE REQUIREMENTS. CHECK WITH LOCAL OFFICIALS TO ENSURE COMPLIANCE BEFORE INSTALLING THE UNIT.

SCALE: 1/8" = 1'



3-WIDE SINGLE-HUNG TILT WITH CENTER PICTURE WITH 24" FLANKER

| UNIT SIZE | 85 3/4" | 97 3/4" | 109 3/4" | 121 3/4" |
|--|--|--|--|--|
| ROUGH OPENING | 84" | 96" | 108" | 120" |
| FRAME SIZE | 83 1/2" | 95 1/2" | 107 1/2" | 119 1/2" |
| DAYLIGHT OPENING | 21 25/32"[2] 19 13/64"[2] 31 29/32" | 21 25/32"[2] 19 13/64"[2] 43 29/32" | 21 25/32"[2] 19 13/64"[2] 55 29/32" | 21 25/32"[2] 19 13/64"[2] 67 29/32" |
| 31 3/4" 30" 29 1/2" 1 1/4" 12.9/16" 26 25/32" | | | | |
| 37 3/4" 36" 35 1/2" 1 1/4" 15.9/16" 32 25/32" | | | | |
| 43 3/4" 42" 41 1/2" 1 1/4" 18.9/16" 38 25/32" | | | | |
| 49 3/4" 48" 47 1/2" 20 1/4" 21.9/16" 44 25/32" | | | | |
| 55 3/4" 54" 53 1/2" 23 1/4" 24.9/16" 50 25/32" | | | | |
| 61 3/4" 60" 59 1/2" 26 1/4" 27.9/16" 56 25/32" | | | | |
| 67 3/4" 66" 65 1/2" 29 1/4" 30.9/16" 62 25/32" | | | | |
| 73 3/4" 72" 71 1/2" 32 1/4" 33.9/16" 68 25/32" | | | | |
| 79 3/4" 78" 77 1/2" 35 1/4" 36.9/16" 74 25/32" | | | | |
| 85 3/4" 84" 83 1/2" 38 1/4" 39.9/16" 80 25/32" | | | | |

ELEVATION SYMBOL LEGEND:
VALUES IN [] ARE NUMBER OF DAYLIGHT OPENINGS PER UNIT

SCALE: 1/8" = 1'

3-WIDE SINGLE-HUNG TILT WITH CENTER PICTURE WITH 24" FLANKER

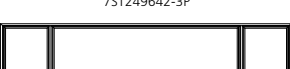
| UNIT SIZE | 145 3/4" |
|--|---|
| ROUGH OPENING | 144" |
| FRAME SIZE | 143 1/2" |
| DAYLIGHT OPENING | 21 25/32"[2] 19 13/64"[2] |
| | 91 29/32" |
| 31 3/4" 30" 29 1/2" 26 25/32" |  |
| | 75T249630-3P |
| 37 3/4" 36" 35 1/2" 32 25/32" |  |
| | 75T249636-3P |
| 43 3/4" 42" 41 1/2" 38 25/32" |  |
| | 75T249642-3P |
| 49 3/4" 48" 47 1/2" 44 25/32" |  |
| | 75T249648-3P |

ELEVATION SYMBOL LEGEND:
VALUES IN [] ARE NUMBER OF DAYLIGHT OPENINGS PER UNIT

3-WIDE SINGLE-HUNG TILT WITH CENTER PICTURE WITH 30" FLANKER

| UNIT SIZE ROUGH OPENING FRAME SIZE DAYLIGHT OPENING | 97 3/4" 96" 95 1/2" 26 25/32"[2] 24 13/64"[2] 31 29/32" | 109 3/4" 108" 107 1/2" 26 25/32"[2] 24 13/64"[2] 43 29/32" | 121 3/4" 120" 119 1/2" 26 25/32"[2] 24 13/64"[2] 55 29/32" | 133 3/4" 132" 131 1/2" 26 25/32"[2] 24 13/64"[2] 67 29/32" |
|--|---|--|--|--|
| 31 3/4" 30" 29 1/2" 11 1/4" 12 9/16" 26 25/32" | | | | |
| 37 3/4" 36" 35 1/2" 14 1/4" 15 9/16" 32 25/32" | | | | |
| 43 3/4" 42" 41 1/2" 17 1/4" 18 9/16" 38 25/32" | | | | |
| 49 3/4" 48" 47 1/2" 20 1/4" 21 9/16" 44 25/32" | | | | |
| 55 3/4" 54" 53 1/2" 23 1/4" 24 9/16" 50 25/32" | | | | |
| 61 3/4" 60" 59 1/2" 26 1/4" 27 9/16" 56 25/32" | | | | |
| 67 3/4" 66" 65 1/2" 29 1/4" 30 9/16" 62 25/32" | | | | |
| 73 3/4" 72" 71 1/2" 32 1/4" 33 9/16" 68 25/32" | | | | |

ELEVATION SYMBOL LEGEND:

E UNIT MEETS EGRESS REQUIREMENTS FOR IRC CODE. STATE AND LOCAL EGRESS CODES MAY DIFFER. ALWAYS REFER TO LOCAL BUILDING CODES FOR COMPLETE REQUIREMENTS. CHECK WITH LOCAL OFFICIALS TO ENSURE COMPLIANCE BEFORE INSTALLING THE UNIT.

SCALE: 1/8" = 1'

3-WIDE SINGLE-HUNG TILT WITH CENTER PICTURE WITH 36" FLANKER

UNIT SIZE
ROUGH OPENING
FRAME SIZE
DAYLIGHT OPENING

109 3/4"
108"
107 1/2"
32 25/32"[2] 30 13/64"[2]
31 29/32"

121 3/4"
120"
119 1/2"
32 25/32"[2] 30 13/64"[2]
43 29/32"

133 3/4"
132"
131 1/2"
32 25/32"[2] 30 13/64"[2]
55 29/32"

31 3/4"
30"
29 1/2"
11 1/4"-12 9/16"
26 25/32"



7ST363630-3P



7ST364830-3P



7ST366030-3P

37 3/4"
36"
35 1/2"
14 1/4"-15 9/16"
32 25/32"



7ST363636-3P



7ST364836-3P



7ST366036-3P

43 3/4"
42"
41 1/2"
17 1/4"-18 9/16"
38 25/32"



7ST363642-3P



7ST364842-3P



7ST366042-3P

49 3/4"
48"
47 1/2"
20 1/4"-21 9/16"
44 25/32"



7ST363648-3P



7ST364848-3P



7ST366048-3P

55 3/4"
54"
53 1/2"
23 1/4"-24 9/16"
50 25/32"



7ST363654-3P



7ST364854-3P

61 3/4"
60"
59 1/2"
26 1/4"-27 9/16"
56 25/32"



7ST363660-3P



7ST364860-3P

67 3/4"
66"
65 1/2"
29 1/4"-30 9/16"
62 25/32"



7ST363666-3P

ELEVATION SYMBOL LEGEND:

E UNIT MEETS EGRESS REQUIREMENTS FOR IRC CODE. STATE AND LOCAL EGRESS CODES MAY DIFFER. ALWAYS REFER TO LOCAL BUILDING CODES FOR COMPLETE REQUIREMENTS. CHECK WITH LOCAL OFFICIALS TO ENSURE COMPLIANCE BEFORE INSTALLING THE UNIT.

SCALE: 1/8" = 1'

GRILLES PATTERNS

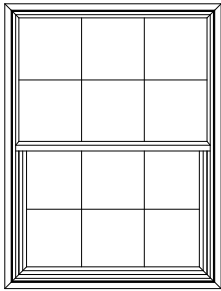

STANDARD

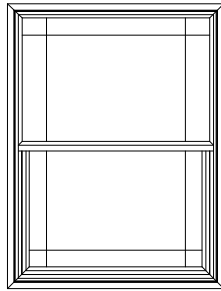

PRAIRIE

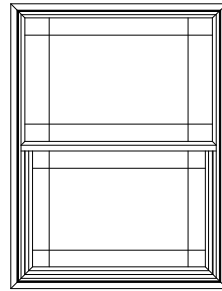

PRAIRIE SASH

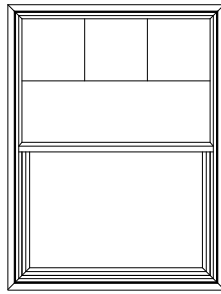

COLONIAL TOP SASH
1/2 LITE

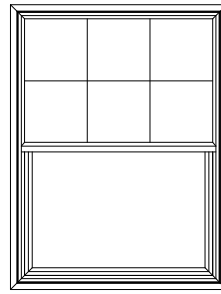

COLONIAL TOP SASH

SINGLE-HUNG TILT

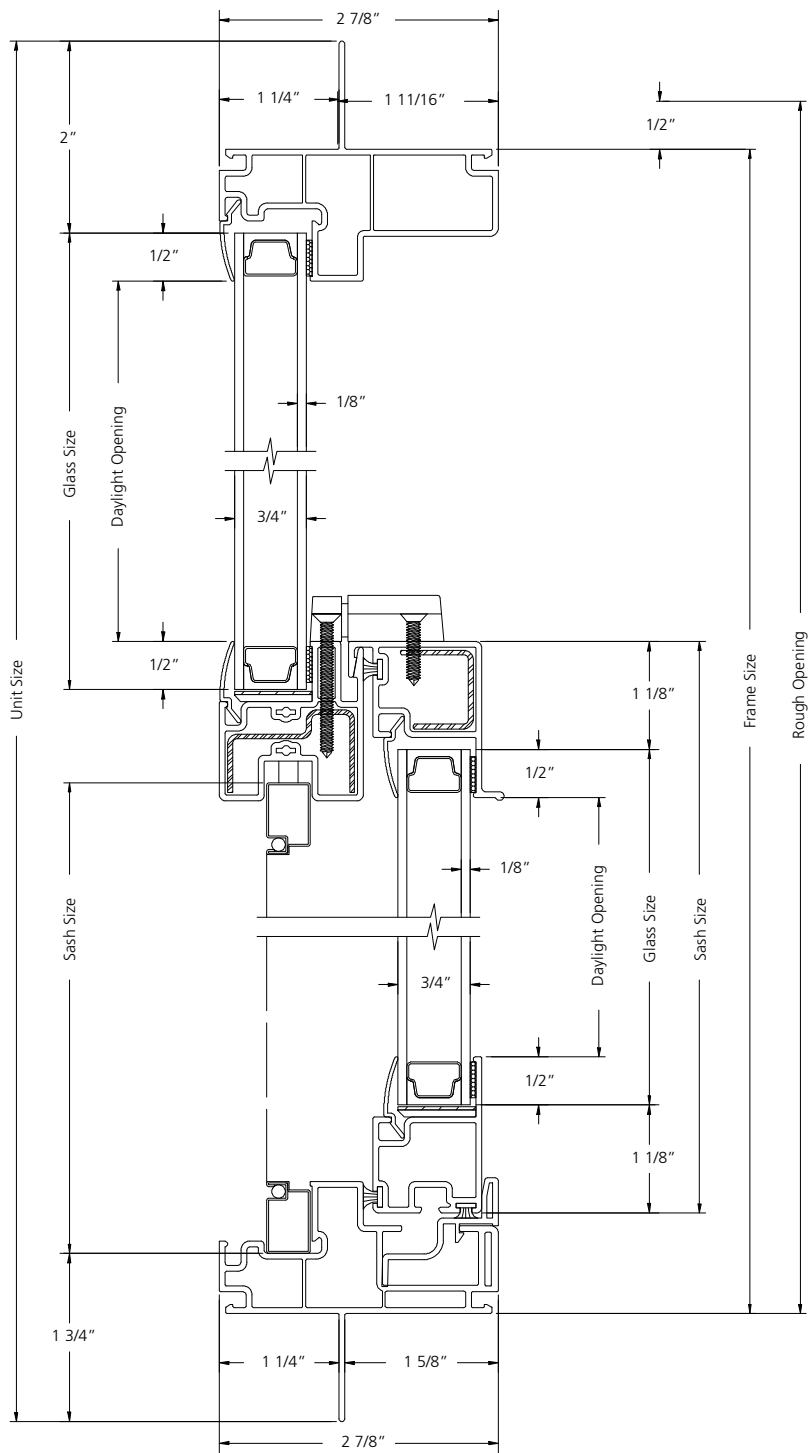

VERTICAL SECTION

SCALE: 6" = 1'

SINGLE-HUNG TILT

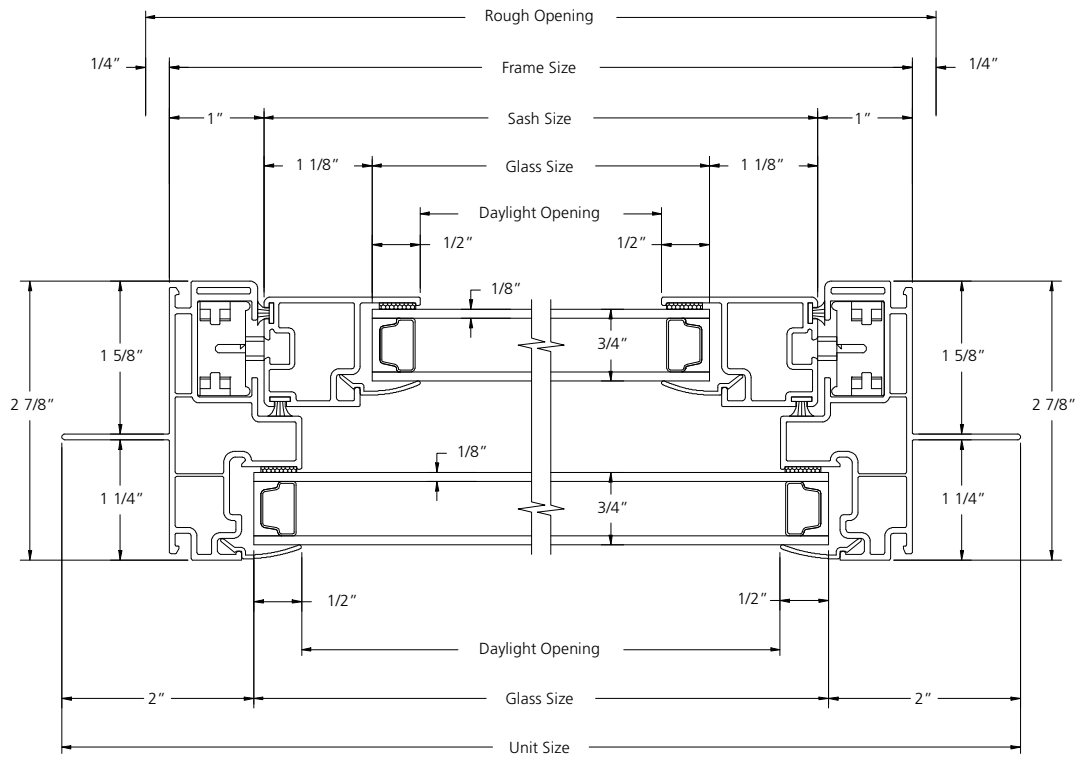

HORIZONTAL SECTION

SCALE: 6" = 1'

2-WIDE SINGLE-HUNG TILT

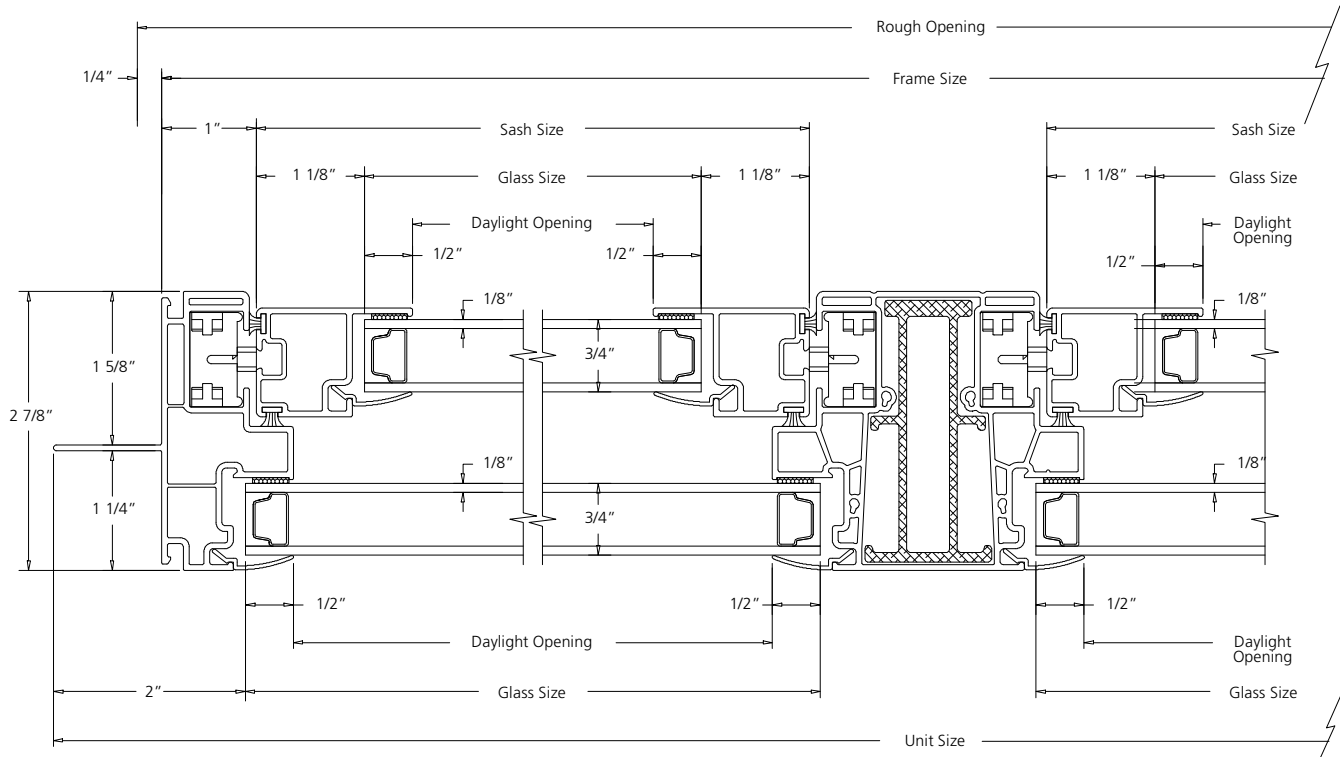

HORIZONTAL SECTION

SCALE: 6" = 1'

3-WIDE SINGLE-HUNG TILT

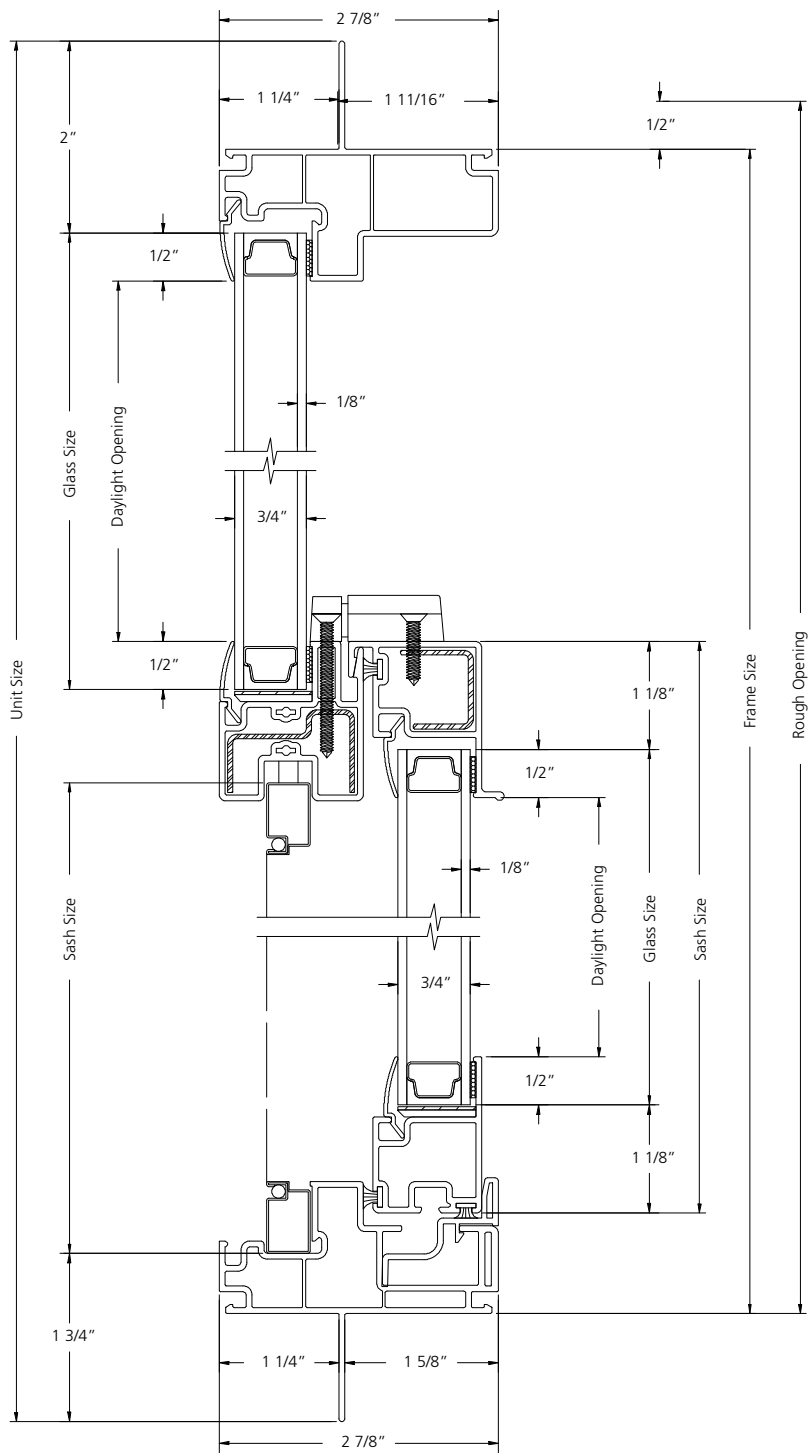

VERTICAL SECTION

SCALE: 6" = 1'

3-WIDE SINGLE-HUNG TILT

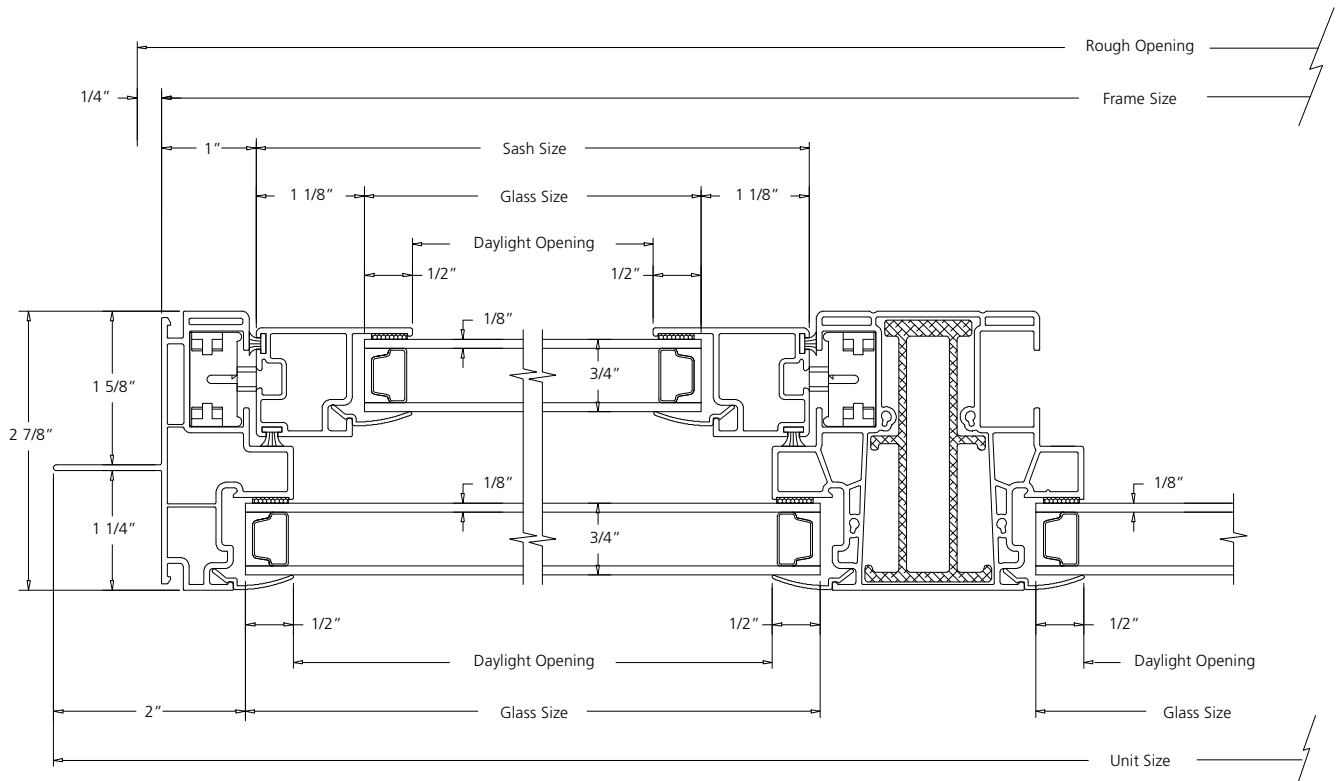

HORIZONTAL SECTION

SCALE: 6" = 1'