

---

**TABLE OF CONTENTS**

---

Specifications .....	5-2
Quick Spec Guide .....	5-3
Elevations/Sizes: 1/4" Scale	
Picture Units .....	5-4
Quarter Round .....	5-15
Half Round .....	5-16
Full Round .....	5-17
Octagon .....	5-18
Oval .....	5-19
Circle Segment .....	5-20
Extended Quarter Round .....	5-21
Extended Half Round .....	5-27
Extended Quarter Segment .....	5-35
Extended Circle Segment .....	5-44
Ellipse Top .....	5-53
Glazing Options: 3" Scale .....	5-62
Grille Patterns .....	5-63
Section Details: 6" Scale .....	5-66

---

**PRODUCT SPECIFICATIONS**

---

**MATERIALS**

The extruded vinyl profiles comply with the performance requirements of AAMA 303-97. Solid color extrusions are available in White and Desert Sand.

**FRAME**

All frames and sash are assembled using fusion-welding technology for added strength and durability. The frame jamb width is 3" (76.2mm), and the nominal extrusion exterior wall thickness is 0.070". The frame incorporates an integral nailing fin which can be easily removed to allow the unit to be used in a replacement window application. Weep holes are included on the frame to ensure standing water is directed to the exterior plane of the unit. An interior and exterior accessory groove is standard to accommodate various frame accessory and assembly options on the product. Optional frame types are: integral 5/8" flange, snap-in J-channel, snap-in Brickmould, and Box.

**GLAZING**

7/8" (22.2mm) insulated glass consist of two lites of glass sealed around a spacer; 3/4" (19mm) insulated glass for SDL units. The glass is mounted into the sash using a silicone-glazing compound. The insulating glass units comply with the performance requirements of the IGCC in accordance with either ASTM E774 or E2190. All units are exterior glazed.

**GLAZING OPTIONS**

7/8" (22.2mm) or 3/4" (19mm) insulated glass is available in clear, Low-E or Low-E 366, tinted, obscure or other specialty insulating glass as specified. Many glass options are available in tempered glazing, ImpactGard®, or monolithic glass.

**GRILLES**

**SDL** (Simulated Divided Lite) 1" (25.4mm) color-matched extruded aluminum contour muntins surface mounted on the exterior surfaces of the insulated glass unit to provide a true divided lite appearance.

**GBG** (Grilles between the Glass) - 5/8" (16mm) and 7/8" (22.2mm) flat or 5/8" (16mm) contour grilles mounted between the glass panes suspended within the air cavity and color matched to the extrusion color.

**EXTENSION JAMBS**

Extension jambs are regionally available for JELD-WEN vinyl products. The 4-9/16 and 6-9/16" extension jambs are available in primed finger-joint and clear pine.

**ADDITIONAL ACCESSORIES**

Additional accessories are available for JELD-WEN Vinyl products. Please contact your local building supply retailer for a complete listing of the additional accessories. See [www.jeld-wen.com/findsupplier](http://www.jeld-wen.com/findsupplier).

**INSTALLATION**

See [www.jeld-wen.com/resources](http://www.jeld-wen.com/resources) for instructions.

**PERFORMANCE**

**NFRC Certified** - (rated and labeled in accordance with NFRC)

































































**AAMA/NWDMA I.S.2-97**

Please reference [www.jeld-wen.com/performanceceratings](http://www.jeld-wen.com/performanceceratings) for up-to-date Design Pressure and approval information.

**QUICK SPEC GUIDE**

SPECIFICATION	STANDARD FEATURES	OPTIONAL FEATURES <i>Some options may require additional lead times. Consult your JELD-WEN Sales Representative.</i>
<b>COLOR</b>	<ul style="list-style-type: none"> <li>• White</li> </ul>	<ul style="list-style-type: none"> <li>• Desert Sand</li> </ul>
<b>FRAME</b>	<ul style="list-style-type: none"> <li>• Nail Fin</li> </ul>	<ul style="list-style-type: none"> <li>• J-Channel</li> <li>• Box Frame</li> <li>• Brickmould</li> <li>• 5/8" Flange</li> <li>• 2-3/8" Flange Extender</li> </ul>
<b>GLAZING</b>	<ul style="list-style-type: none"> <li>• 7/8" Insulated Clear</li> </ul>	<ul style="list-style-type: none"> <li>• 3/16" Single Glaze</li> <li>• Tempered</li> <li>• Low-E</li> <li>• Bronze</li> <li>• Gray</li> <li>• Green</li> <li>• Obscure</li> <li>• Azurlite</li> <li>• Graylite (Turtle)</li> <li>• Bronze Reflective</li> </ul>
<b>IMPACTGARD PROTECTION</b>		<ul style="list-style-type: none"> <li>• SGP Impact Single-Glaze</li> <li>• SGP Impact Standard Insulated</li> <li>• SGP Impact ImpactGard Insulated</li> </ul> <p style="text-align: center;"><i>Not available in tempered. All other tint and obscure glazing options apply.</i></p>
<b>GRILLES</b>		<ul style="list-style-type: none"> <li>• SDL - 1" Simulated Divided Lite</li> <li>• 5/8", 7/8" Flat GBG*</li> <li>• 5/8" Contour GBG</li> </ul> <p style="text-align: center;"><i>*Check for availability</i></p>
<b>JAMB</b>	<ul style="list-style-type: none"> <li>• 3"</li> </ul>	

#### PICTURE UNITS

UNIT SIZE	13 3/4" (349)	19 3/4" (502)	25 3/4" (654)	29 3/4" (756)	31 3/4" (806)	33 3/4" (857)	37 3/4" (959)	41 3/4" (1060)
ROUGH OPENING	12" (305)	18" (457)	24" (610)	28" (711)	30" (762)	32" (813)	36" (914)	40" (1016)
FRAME SIZE	11 1/2" (292)	17 1/2" (445)	23 1/2" (597)	27 1/2" (699)	29 1/2" (749)	31 1/2" (800)	35 1/2" (902)	39 1/2" (1003)
DAYLIGHT OPENING	7 5/8" (194)	13 5/8" (346)	19 5/8" (498)	23 5/8" (600)	25 5/8" (651)	27 5/8" (702)	31 5/8" (803)	35 5/8" (905)
19 3/4" (502) 18" (457) 17 1/2" (445) 13 5/8" (346)								
25 3/4" (654) 24" (610) 23 1/2" (597) 19 5/8" (498)								
31 3/4" (806) 30" (762) 29 1/2" (749) 25 5/8" (651)								
37 3/4" (959) 36" (914) 35 1/2" (902) 31 5/8" (803)								
39 3/4" (1010) 38" (965) 37 1/2" (953) 33 5/8" (854)								
43 3/4" (1111) 42" (1067) 41 1/2" (1054) 37 5/8" (956)								
45 3/4" (1162) 44" (1118) 43 1/2" (1105) 39 5/8" (1006)								
49 3/4" (1264) 48" (1219) 47 1/2" (1207) 43 5/8" (1108)								

**ELEVATION SYMBOL LEGEND:**  
 VALUES IN () ARE IN MILLIMETER CONVERSIONS.  
 ##\* NUMBER INDICATES DESIGN PRESSURE (DP) RATING WITH STANDARD GLAZING.  
 ###\* NUMBER INDICATES OPTIONAL DESIGN PRESSURE (DP) RATING.

SCALE: 1/4" = 1'

#### PICTURE UNITS

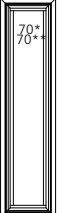
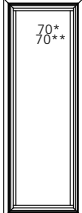
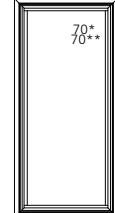
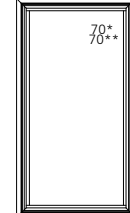
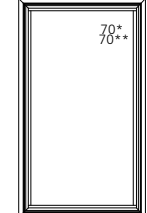
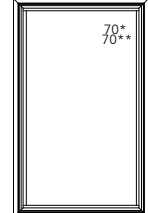
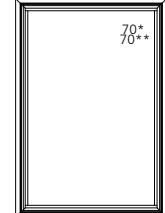
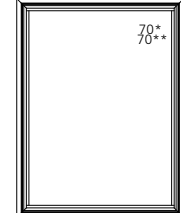
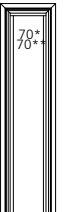
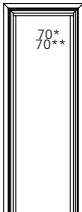
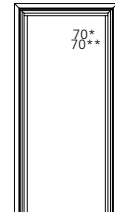
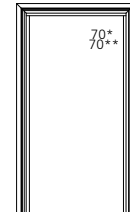
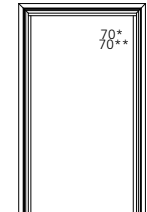
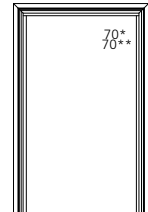
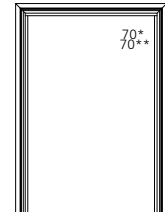
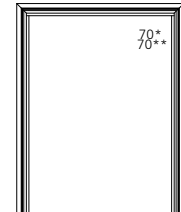
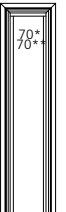
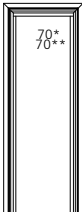
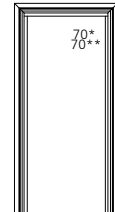
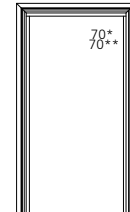
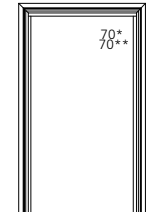
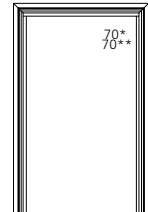
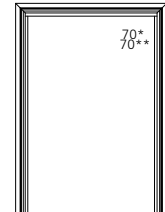
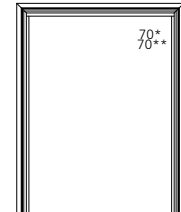
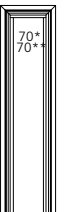
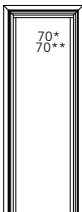
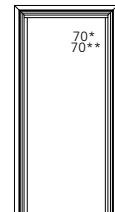
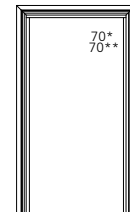
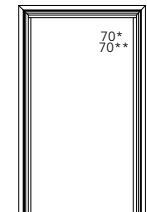
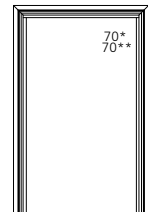
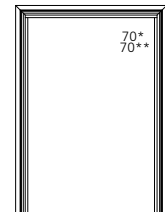
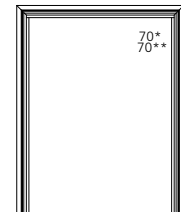
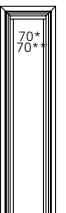
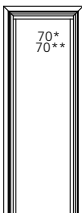
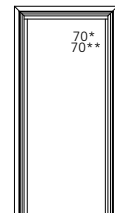
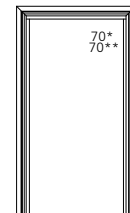
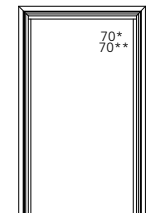
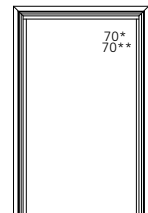
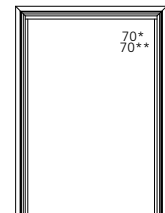
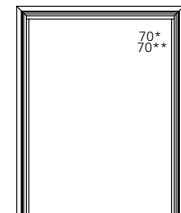
UNIT SIZE	13 3/4" (349)	19 3/4" (502)	25 3/4" (654)	29 3/4" (756)	31 3/4" (806)	33 3/4" (857)	37 3/4" (959)	41 3/4" (1060)
ROUGH OPENING	12" (305)	18" (457)	24" (610)	28" (711)	30" (762)	32" (813)	36" (914)	40" (1016)
FRAME SIZE	11 1/2" (292)	17 1/2" (445)	23 1/2" (597)	27 1/2" (699)	29 1/2" (749)	31 1/2" (800)	35 1/2" (902)	39 1/2" (1003)
DAYLIGHT OPENING	7 5/8" (194)	13 5/8" (346)	19 5/8" (498)	23 5/8" (600)	25 5/8" (651)	27 5/8" (702)	31 5/8" (803)	35 5/8" (905)
53 3/4" (1365) 52" (1321) 51 1/2" (1308) 47 5/8" (1210)								
55 3/4" (1416) 54" (1372) 53 1/2" (1359) 49 5/8" (1260)								
61 3/4" (1568) 60" (1524) 59 1/2" (1511) 55 5/8" (1413)								
63 3/4" (1619) 62" (1575) 61 1/2" (1562) 57 5/8" (1464)								
67 3/4" (1721) 66" (1676) 65 1/2" (1664) 61 5/8" (1566)								

**ELEVATION SYMBOL LEGEND:**  
 VALUES IN ( ) ARE IN MILLIMETER CONVERSIONS.  
 ##\* NUMBER INDICATES DESIGN PRESSURE (DP) RATING WITH STANDARD GLAZING.  
 ###\* NUMBER INDICATES OPTIONAL DESIGN PRESSURE (DP) RATING.

SCALE: 1/4" = 1'

### PICTURE UNITS

UNIT SIZE	13 3/4" (349)	19 3/4" (502)	25 3/4" (654)	29 3/4" (756)	31 3/4" (806)	33 3/4" (857)	37 3/4" (959)	41 3/4" (1060)	
ROUGH OPENING	12" (305)	18" (457)	24" (610)	28" (711)	30" (762)	32" (813)	36" (914)	40" (1016)	
FRAME SIZE	11 1/2" (292)	17 1/2" (445)	23 1/2" (597)	27 1/2" (699)	29 1/2" (749)	31 1/2" (800)	35 1/2" (902)	39 1/2" (1003)	
DAYLIGHT OPENING	7 5/8" (194)	13 5/8" (346)	19 5/8" (498)	23 5/8" (600)	25 5/8" (651)	27 5/8" (702)	31 5/8" (803)	35 5/8" (905)	
73 3/4" (1873) 72" (1829) 71 1/2" (1861) 67 5/8" (1718)									
	8FW1272	8FW1872	8FW2472	8FW2872	8FW3072	8FW3272	8FW3672	8FW4072	
	75 3/4" (1924) 74" (1880) 73 1/2" (1867) 69 5/8" (1768)								
		8FW1274	8FW1874	8FW2474	8FW2874	8FW3074	8FW3274	8FW3674	8FW4074

**ELEVATION SYMBOL LEGEND:**  
 VALUES IN ( ) ARE IN MILLIMETER CONVERSIONS.  
 ### NUMBER INDICATES DESIGN PRESSURE (DP) RATING WITH STANDARD GLAZING.  
 #### NUMBER INDICATES OPTIONAL DESIGN PRESSURE (DP) RATING.

SCALE: 1/4" = 1'

#### PICTURE UNITS

	UNIT SIZE ROUGH OPENING FRAME SIZE DAYLIGHT OPENING	43 3/4" (1111) 42" (1067) 41 1/2" (1054) 37 5/8" (956)	45 3/4" (1162) 44" (1118) 43 1/2" (1105) 39 5/8" (1006)	49 3/4" (1264) 48" (1219) 47 1/2" (1207) 43 5/8" (1108)	55 3/4" (1416) 54" (1372) 53 1/2" (1359) 49 5/8" (1260)	57 3/4" (1467) 56" (1422) 55 1/2" (1410) 51 5/8" (1311)
19 3/4" (502) 18" (457) 17 1/2" (445) 13 5/8" (346)		8FW4218	8FW4418	8FW4818	8FW5418	8FW5618
25 3/4" (654) 24" (610) 23 1/2" (597) 19 5/8" (498)		8FW4224	8FW4424	8FW4824	8FW5424	8FW5624
31 3/4" (806) 30" (762) 29 1/2" (749) 25 5/8" (651)		8FW4230	8FW4430	8FW4830	8FW5430	8FW5630
37 3/4" (959) 36" (914) 35 1/2" (902) 31 5/8" (803)		8FW4236	8FW4436	8FW4836	8FW5436	8FW5636
39 3/4" (1010) 38" (965) 37 1/2" (953) 33 5/8" (854)		8FW4238	8FW4438	8FW4838	8FW5438	8FW5638
43 3/4" (1111) 42" (1067) 41 1/2" (1054) 37 5/8" (956)		8FW4242	8FW4442	8FW4842	8FW5442	8FW5642
45 3/4" (1162) 44" (1118) 43 1/2" (1105) 39 5/8" (1006)		8FW4244	8FW4444	8FW4844	8FW5444	8FW5644
49 3/4" (1264) 48" (1219) 47 1/2" (1207) 43 5/8" (1108)		8FW4248	8FW4448	8FW4848	8FW5448	8FW5648

**ELEVATION SYMBOL LEGEND:**

VALUES IN ( ) ARE IN MILLIMETER CONVERSIONS.  
 ##\* NUMBER INDICATES DESIGN PRESSURE (DP) RATING WITH STANDARD GLAZING.  
 ### NUMBER INDICATES OPTIONAL DESIGN PRESSURE (DP) RATING.

SCALE: 1/4" = 1'

### PICTURE UNITS

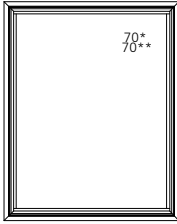
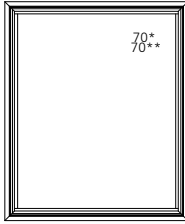
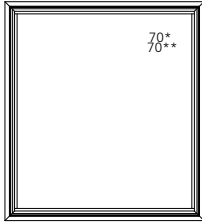
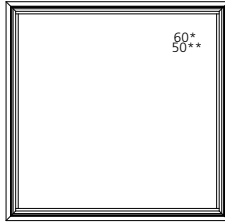
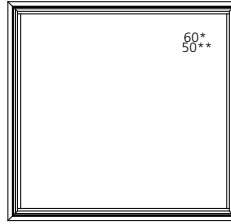
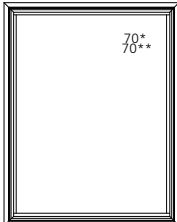
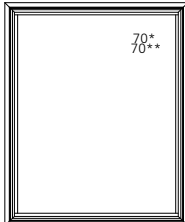
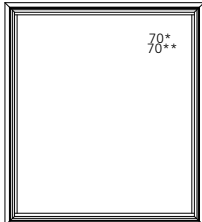
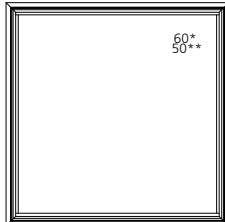
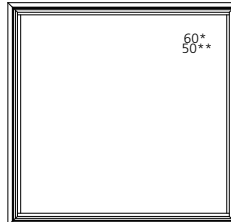
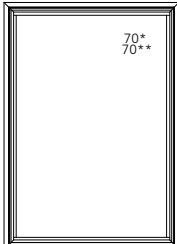
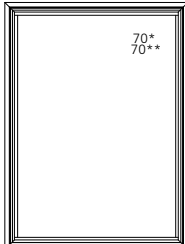
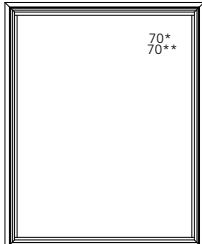
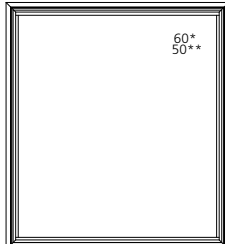
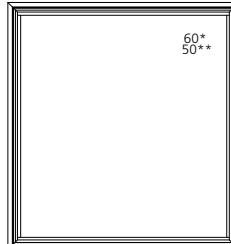
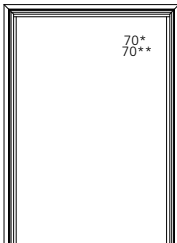
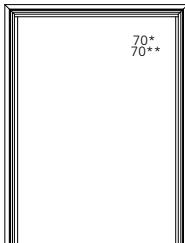
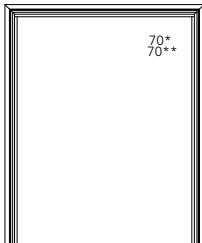
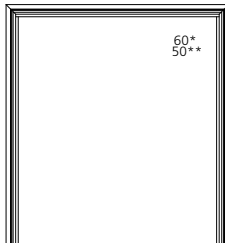
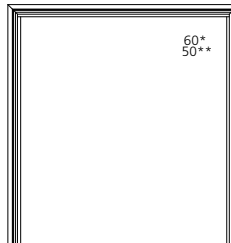
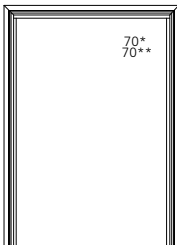
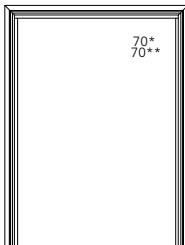
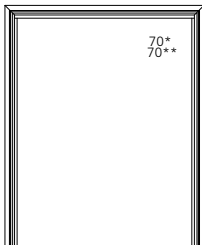
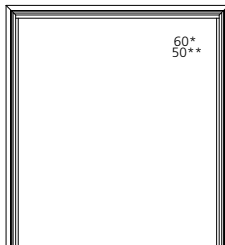
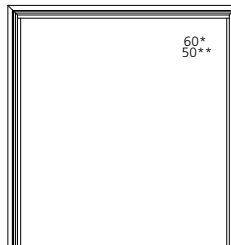
	UNIT SIZE ROUGH OPENING FRAME SIZE DAYLIGHT OPENING	43 3/4" (1111) 42" (1067) 41 1/2" (1054) 37 5/8" (956)	45 3/4" (1162) 44" (1118) 43 1/2" (1105) 39 5/8" (1006)	49 3/4" (1264) 48" (1219) 47 1/2" (1207) 43 5/8" (1108)	55 3/4" (1416) 54" (1372) 53 1/2" (1359) 49 5/8" (1260)	57 3/4" (1467) 56" (1422) 55 1/2" (1410) 51 5/8" (1311)
53 3/4" (1365) 52" (1321) 51 7/8" (1308) 47 5/8" (1210)						
55 3/4" (1416) 54" (1372) 53 1/2" (1359) 49 5/8" (1260)						
61 3/4" (1568) 60" (1524) 59 1/2" (1511) 55 5/8" (1413)						
63 3/4" (1619) 62" (1575) 61 7/8" (1562) 57 5/8" (1464)						
67 3/4" (1721) 66" (1676) 65 1/2" (1664) 61 5/8" (1565)						

**ELEVATION SYMBOL LEGEND:**  
 VALUES IN ( ) ARE IN MILLIMETER CONVERSIONS.  
 \*\*\* NUMBER INDICATES DESIGN PRESSURE (DP) RATING WITH STANDARD GLAZING.  
 \*\*\*\* NUMBER INDICATES OPTIONAL DESIGN PRESSURE (DP) RATING.

SCALE: 1/4" = 1'



**PICTURE UNITS**

**UNIT SIZE**  
**ROUGH OPENING**  
**FRAME SIZE**  
**DAYLIGHT OPENING**

43 3/4" (1111)  
42" (1067)  
41 1/2" (1054)  
37 5/8" (956)

45 3/4" (1162)  
44" (1118)  
43 1/2" (1105)  
39 5/8" (1006)

49 3/4" (1264)  
48" (1219)  
47 1/2" (1207)  
43 5/8" (1108)

55 3/4" (1416)  
54" (1372)  
53 1/2" (1359)  
49 5/8" (1260)

57 3/4" (1467)  
56" (1422)  
55 1/2" (1410)  
51 5/8" (1311)

73 3/4" (1873)  
72" (1829)  
71 1/2" (1861)  
67 5/8" (1718)

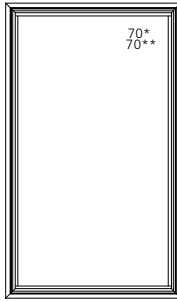

8FW4272

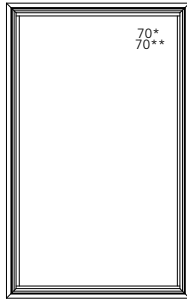

8FW4472

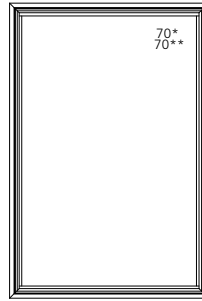

8FW4872

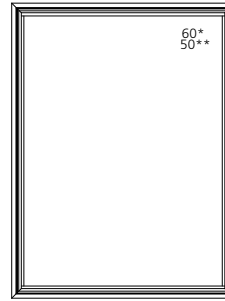

8FW5472

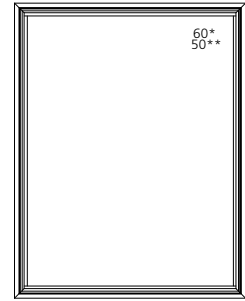

8FW5672

75 3/4" (1924)  
74" (1880)  
73 1/2" (1867)  
69 5/8" (1768)

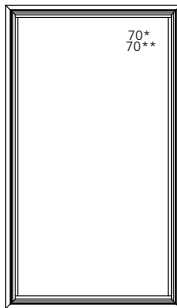

8FW4274

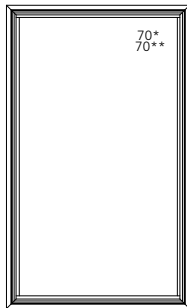

8FW4474

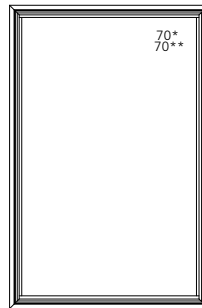

8FW4874

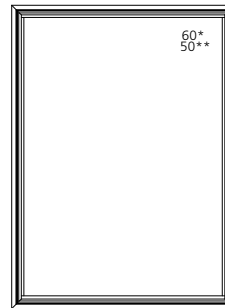

8FW5474

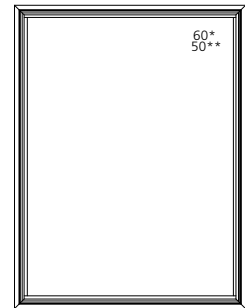

8FW5674

**ELEVATION SYMBOL LEGEND:**















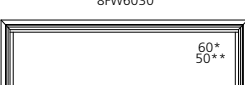
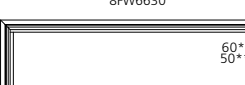
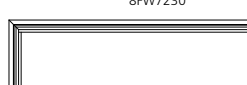

VALUES IN ( ) ARE IN MILLIMETER CONVERSIONS.

### NUMBER INDICATES DESIGN PRESSURE (DP) RATING WITH STANDARD GLAZING.

#### NUMBER INDICATES OPTIONAL DESIGN PRESSURE (DP) RATING.

SCALE: 1/4" = 1'

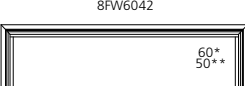
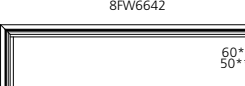
### PICTURE UNITS

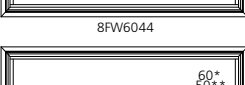
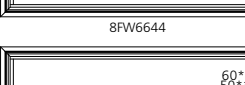
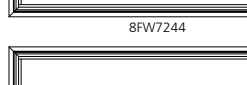



UNIT SIZE ROUGH OPENING FRAME SIZE DAYLIGHT OPENING	61 3/4" (1568) 60" (1524) 59 1/2" (1511) 55 5/8" (1413)	67 3/4" (1721) 66" (1676) 65 1/2" (1664) 61 5/8" (1565)	73 3/4" (1873) 72" (1829) 71 1/2" (1861) 67 5/8" (1718)
19 3/4" (502) 18" (457) 17 1/2" (445) 13 5/8" (346)	 60* 50** 8FW6018	 60* 50** 8FW6618	 60* 50** 8FW7218
25 3/4" (654) 24" (610) 23 1/2" (597) 19 5/8" (498)	 60* 50** 8FW6024	 60* 50** 8FW6624	 60* 50** 8FW7224
31 3/4" (806) 30" (762) 29 1/2" (749) 25 5/8" (651)	 60* 50** 8FW6030	 60* 50** 8FW6630	 60* 50** 8FW7230
37 3/4" (959) 36" (914) 35 1/2" (902) 31 5/8" (803)	 60* 50** 8FW6036	 60* 50** 8FW6636	 60* 50** 8FW7236
39 3/4" (1010) 38" (965) 37 1/2" (953) 33 5/8" (854)	 60* 50** 8FW6038	 60* 50** 8FW6638	 60* 50** 8FW7238
43 3/4" (1111) 42" (1067) 41 1/2" (1054) 37 5/8" (956)	 60* 50** 8FW6042	 60* 50** 8FW6642	 60* 50** 8FW7242
45 3/4" (1162) 44" (1118) 43 1/2" (1105) 39 5/8" (1006)	 60* 50** 8FW6044	 60* 50** 8FW6644	 60* 50** 8FW7244
49 3/4" (1264) 48" (1219) 47 1/2" (1207) 43 5/8" (1108)	 60* 50** 8FW6048	 60* 50** 8FW6648	 60* 50** 8FW7248

**ELEVATION SYMBOL LEGEND:**  
 VALUES IN () ARE IN MILLIMETER CONVERSIONS.  
 ##\* NUMBER INDICATES DESIGN PRESSURE (DP) RATING WITH STANDARD GLAZING.  
 ##\*\* NUMBER INDICATES OPTIONAL DESIGN PRESSURE (DP) RATING.

SCALE: 1/4" = 1'

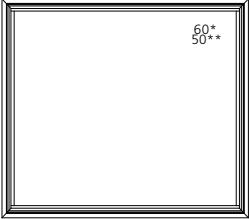
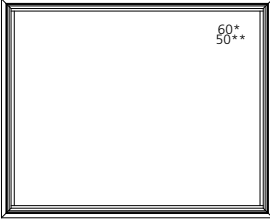
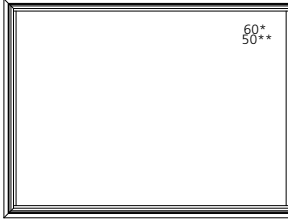
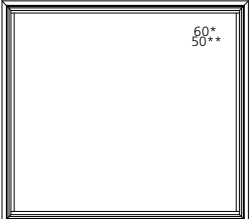
**PICTURE UNITS**

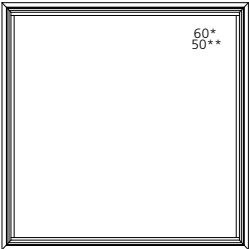
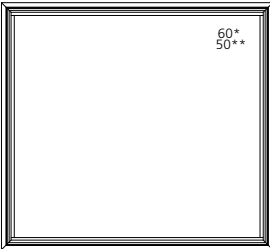
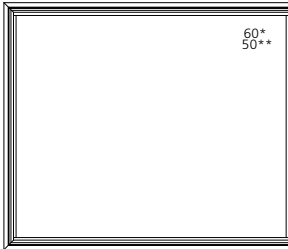
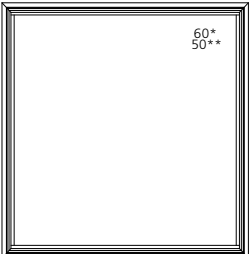
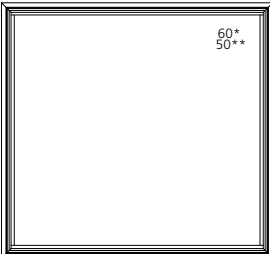
**UNIT SIZE**  
**ROUGH OPENING**  
**FRAME SIZE**  
**DAYLIGHT OPENING**

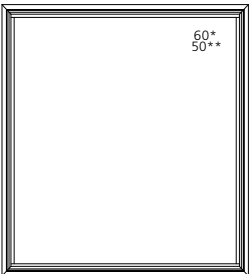
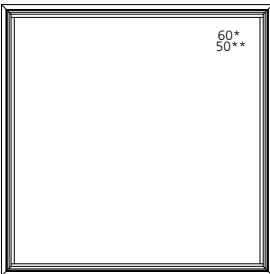
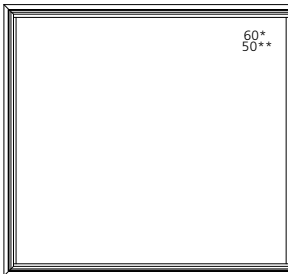
<p>53 3/4" (1365) 52" (1321) 51 1/2" (1308) 47 5/8" (1210)</p>	<p>61 3/4" (1568) 60" (1524) 59 1/2" (1511) 55 5/8" (1413)</p>	<p>67 3/4" (1721) 66" (1676) 65 1/2" (1664) 61 5/8" (1565)</p>	<p>73 3/4" (1873) 72" (1829) 71 1/2" (1861) 67 5/8" (1718)</p>
			
<p>55 3/4" (1416) 54" (1372) 53 1/2" (1359) 49 5/8" (1260)</p>	<p>60" (1524) 59 1/2" (1511) 55 5/8" (1413)</p>	<p>66" (1676) 65 1/2" (1664) 61 5/8" (1565)</p>	
			
<p>61 3/4" (1568) 60" (1524) 59 1/2" (1511) 55 5/8" (1413)</p>	<p>60" (1524) 59 1/2" (1511) 55 5/8" (1413)</p>	<p>66" (1676) 65 1/2" (1664) 61 5/8" (1565)</p>	
			
<p>63 3/4" (1619) 62" (1575) 61 1/2" (1562) 57 5/8" (1464)</p>	<p>60" (1524) 59 1/2" (1511) 55 5/8" (1413)</p>	<p>66" (1676) 65 1/2" (1664) 61 5/8" (1565)</p>	
			
<p>67 3/4" (1721) 66" (1676) 65 1/2" (1664) 61 5/8" (1565)</p>	<p>60" (1524) 59 1/2" (1511) 55 5/8" (1413)</p>	<p>66" (1676) 65 1/2" (1664) 61 5/8" (1565)</p>	
			

**ELEVATION SYMBOL LEGEND:**

VALUES IN ( ) ARE IN MILLIMETER CONVERSIONS.  
##\* NUMBER INDICATES DESIGN PRESSURE (DP) RATING WITH STANDARD GLAZING.  
##\*\* NUMBER INDICATES OPTIONAL DESIGN PRESSURE (DP) RATING.

SCALE: 1/4" = 1'

**PICTURE UNITS**

**UNIT SIZE**  
**ROUGH OPENING**  
**FRAME SIZE**  
**DAYLIGHT OPENING**

61 3/4"(1568)  
60"(1524)  
59 1/2"(1511)  
55 5/8"(1413)

67 3/4"(1721)  
66"(1676)  
65 1/2"(1664)  
61 5/8"(1565)

73 3/4"(1873)  
72"(1829)  
71 1/2"(1861)  
67 5/8"(1718)

73 3/4"(1873)  
72"(1829)  
71 1/2"(1861)  
67 5/8"(1718)

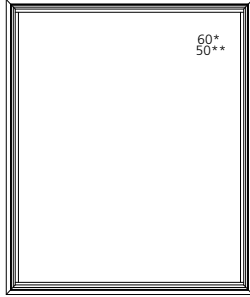

8FW6072

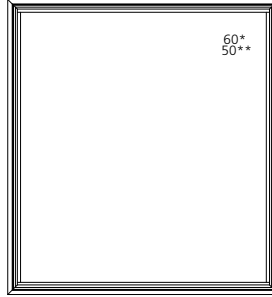

8FW6672

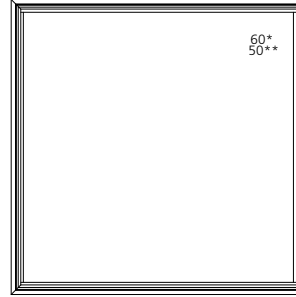

8FW7272

75 3/4"(1924)  
74"(1880)  
73 1/2"(1867)  
69 5/8"(1768)

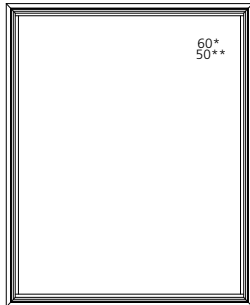

8FW6074

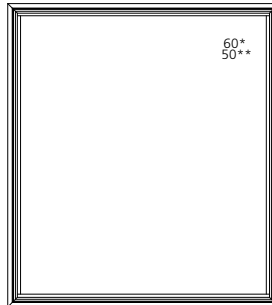

8FW6674

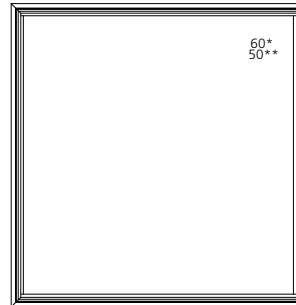

8FW7274

**ELEVATION SYMBOL LEGEND:**

VALUES IN ( ) ARE IN MILLIMETER CONVERSIONS.  
##\* NUMBER INDICATES DESIGN PRESSURE (DP) RATING WITH STANDARD GLAZING.  
##\*\* NUMBER INDICATES OPTIONAL DESIGN PRESSURE (DP) RATING.

SCALE: 1/4" = 1'

### PICTURE UNITS

UNIT SIZE  
ROUGH OPENING  
FRAME SIZE  
DAYLIGHT OPENING

75 3/4"(1924)  
74"(1880)  
73 1/2"(1867)  
69 5/8"(1768)



8FW7418



8FW7424



8FW7430



8FW7436



8FW7438

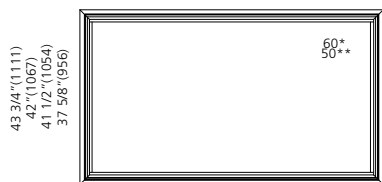

8FW7442



8FW7444

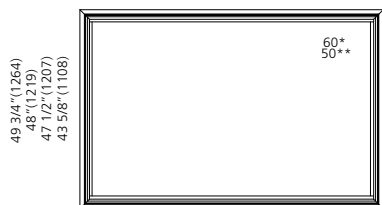

8FW7448

UNIT SIZE  
ROUGH OPENING  
FRAME SIZE  
DAYLIGHT OPENING

75 3/4"(1924)  
74"(1880)  
73 1/2"(1867)  
69 5/8"(1768)

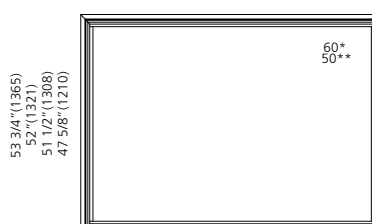

8FW7452

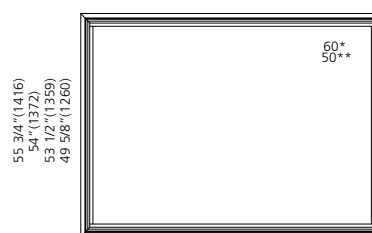

8FW7454

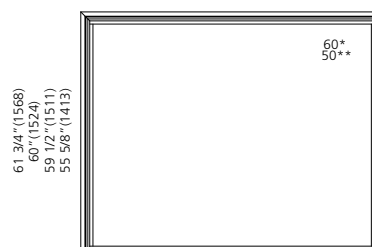

8FW7460

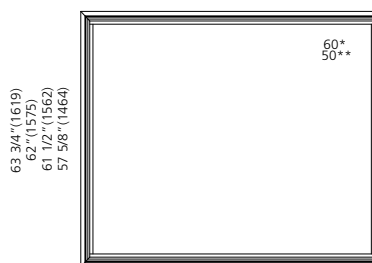

8FW7462

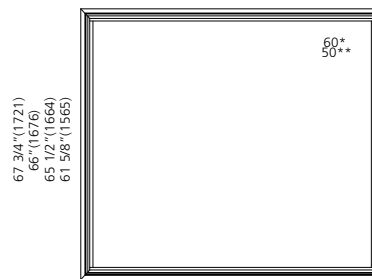

8FW7466

**ELEVATION SYMBOL LEGEND:**

VALUES IN ( ) ARE IN MILLIMETER CONVERSIONS.  
 \*\* NUMBER INDICATES DESIGN PRESSURE (DP) RATING WITH STANDARD GLAZING.  
 \*\*\* NUMBER INDICATES OPTIONAL DESIGN PRESSURE (DP) RATING.

SCALE: 1/4" = 1'

**PICTURE UNITS**

<b>UNIT SIZE</b>	75 3/4" (1924)
<b>ROUGH OPENING</b>	74" (1880)
<b>FRAME SIZE</b>	73 1/2" (1867)
<b>DAYLIGHT OPENING</b>	69 5/8" (1768)

73 3/4" (1873)  
72" (1829)  
71 1/2" (1861)  
67 5/8" (1718)

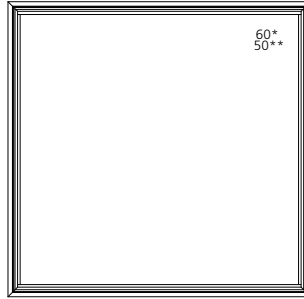

8FW7472

75 3/4" (1924)  
74" (1880)  
73 1/2" (1867)  
69 5/8" (1768)

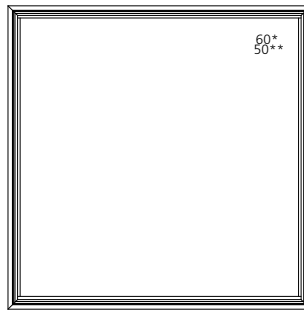

8FW7474

**ELEVATION SYMBOL LEGEND:**  
VALUES IN () ARE IN MILLIMETER CONVERSIONS.  
##\* NUMBER INDICATES DESIGN PRESSURE (DP) RATING WITH STANDARD GLAZING.  
###\* NUMBER INDICATES OPTIONAL DESIGN PRESSURE (DP) RATING.

SCALE: 1/4" = 1'

#### QUARTER ROUND

**UNIT SIZE** 25 3/4" (654)  
**ROUGH OPENING** 24" (610)  
**FRAME SIZE** 23 1/2" (597)  
**DAYLIGHT OPENING** 19 5/8" (498)

25 3/4" (654)  
 24" (610)  
 23 1/2" (597)  
 19 5/8" (498)

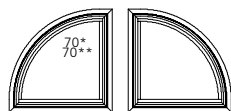

8QR24

**UNIT SIZE** 31 3/4" (806)  
**ROUGH OPENING** 30" (762)  
**FRAME SIZE** 29 1/2" (749)  
**DAYLIGHT OPENING** 25 5/8" (651)

31 3/4" (806)  
 30" (762)  
 29 1/2" (749)  
 25 5/8" (651)

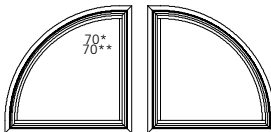

8QR30

**UNIT SIZE** 37 3/4" (959)  
**ROUGH OPENING** 36" (914)  
**FRAME SIZE** 35 1/2" (902)  
**DAYLIGHT OPENING** 31 5/8" (803)

37 3/4" (959)  
 36" (914)  
 35 1/2" (902)  
 31 5/8" (803)

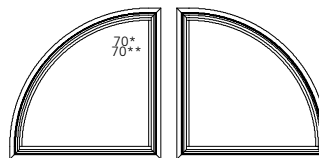

8QR36

**UNIT SIZE** 43 3/4" (1111)  
**ROUGH OPENING** 42" (1067)  
**FRAME SIZE** 41 1/2" (1054)  
**DAYLIGHT OPENING** 37 5/8" (956)

43 3/4" (1111)  
 42" (1067)  
 41 1/2" (1054)  
 37 5/8" (956)

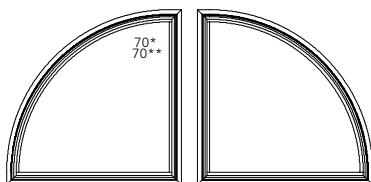

8QR42

**UNIT SIZE** 49 3/4" (1264)  
**ROUGH OPENING** 48" (1219)  
**FRAME SIZE** 47 1/2" (1207)  
**DAYLIGHT OPENING** 43 5/8" (1108)

49 3/4" (1264)  
 48" (1219)  
 47 1/2" (1207)  
 43 5/8" (1108)

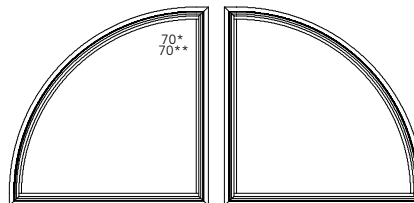

8QR48

**UNIT SIZE** 55 3/4" (1416)  
**ROUGH OPENING** 54" (1372)  
**FRAME SIZE** 53 1/2" (1359)  
**DAYLIGHT OPENING** 49 5/8" (1260)

55 3/4" (1416)  
 54" (1372)  
 53 1/2" (1359)  
 49 5/8" (1260)

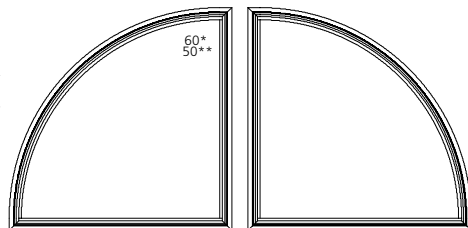

8QR54

**UNIT SIZE** 61 3/4" (1568)  
**ROUGH OPENING** 60" (1524)  
**FRAME SIZE** 59 1/2" (1511)  
**DAYLIGHT OPENING** 55 5/8" (1413)

61 3/4" (1568)  
 60" (1524)  
 59 1/2" (1511)  
 55 5/8" (1413)

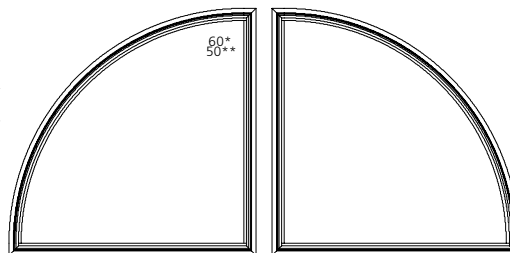

8QR60

**ELEVATION SYMBOL LEGEND:**  
 VALUES IN () ARE IN MILLIMETER CONVERSIONS.  
**##\*** NUMBER INDICATES DESIGN PRESSURE (DP) RATING WITH STANDARD GLAZING.  
**##\*\*** NUMBER INDICATES OPTIONAL DESIGN PRESSURE (DP) RATING.

SCALE: 1/4" = 1'

#### HALF ROUND

**UNIT SIZE** 25 3/4"(654)  
**ROUGH OPENING** 24"(610)  
**FRAME SIZE** 23 1/2"(597)  
**DAYLIGHT OPENING** 19 5/8"(498)

13 3/4"(349)  
 12"(305)  
 11 1/2"(292)  
 7 5/8"(194)



8HR24

16 3/4"(425)  
 15"(381)  
 14 1/2"(368)  
 10 5/8"(270)



8HR30

19 3/4"(502)  
 18"(457)  
 17 1/2"(445)  
 13 5/8"(346)



8HR36

**UNIT SIZE** 43 3/4"(1111)  
**ROUGH OPENING** 42"(1067)  
**FRAME SIZE** 41 1/2"(1054)  
**DAYLIGHT OPENING** 37 5/8"(956)

22 3/4"(578)  
 21"(533)  
 20 1/2"(521)  
 16 5/8"(422)

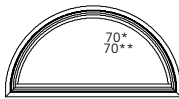

8HR42

25 3/4"(654)  
 24"(610)  
 23 1/2"(597)  
 19 5/8"(498)

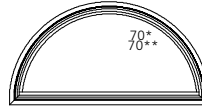

8HR48

28 3/4"(730)  
 27"(686)  
 26 1/2"(673)  
 22 5/8"(575)

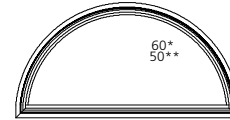

8HR54

**UNIT SIZE** 61 3/4"(1568)  
**ROUGH OPENING** 60"(1524)  
**FRAME SIZE** 59 1/2"(1511)  
**DAYLIGHT OPENING** 55 5/8"(1413)

31 3/4"(806)  
 30"(762)  
 29 1/2"(749)  
 25 5/8"(651)

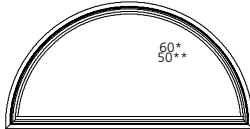

8HR60

34 3/4"(883)  
 33"(828)  
 32 1/2"(826)  
 29 5/8"(752)

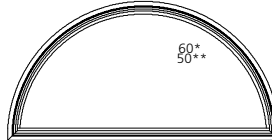

8HR66

37 3/4"(959)  
 36"(914)  
 35 1/2"(902)  
 31 5/8"(803)

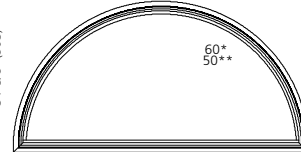

8HR72

**ELEVATION SYMBOL LEGEND:**

VALUES IN ( ) ARE IN MILLIMETER CONVERSIONS.  
 ##\* NUMBER INDICATES DESIGN PRESSURE (DP) RATING WITH STANDARD GLAZING.  
 ##\*\* NUMBER INDICATES OPTIONAL DESIGN PRESSURE (DP) RATING.



#### FULL ROUND

UNIT SIZE 25 3/4" (654)  
 ROUGH OPENING 24" (610)  
 FRAME SIZE 23 1/2" (597)  
 DAYLIGHT OPENING 19 5/8" (498)

UNIT SIZE 31 3/4" (806)  
 ROUGH OPENING 30" (762)  
 FRAME SIZE 29 1/2" (749)  
 DAYLIGHT OPENING 25 5/8" (651)

UNIT SIZE 37 3/4" (959)  
 ROUGH OPENING 36" (914)  
 FRAME SIZE 35 1/2" (902)  
 DAYLIGHT OPENING 31 5/8" (803)

UNIT SIZE 43 3/4" (1111)  
 ROUGH OPENING 42" (1067)  
 FRAME SIZE 41 1/2" (1054)  
 DAYLIGHT OPENING 37 5/8" (956)

25 3/4" (654)  
 24" (610)  
 23 1/2" (597)  
 19 5/8" (498)



8FR24

31 3/4" (806)  
 30" (762)  
 29 1/2" (749)  
 25 5/8" (651)

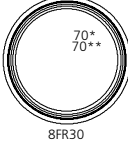

8FR30

37 3/4" (959)  
 36" (914)  
 35 1/2" (902)  
 31 5/8" (803)

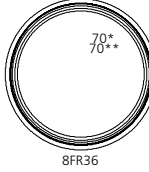

8FR36

43 3/4" (1111)  
 42" (1067)  
 41 1/2" (1054)  
 37 5/8" (956)

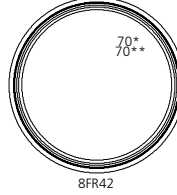

8FR42

UNIT SIZE 49 3/4" (1264)  
 ROUGH OPENING 48" (1219)  
 FRAME SIZE 47 1/2" (1207)  
 DAYLIGHT OPENING 43 5/8" (1108)

UNIT SIZE 55 3/4" (1416)  
 ROUGH OPENING 54" (1372)  
 FRAME SIZE 53 1/2" (1359)  
 DAYLIGHT OPENING 49 5/8" (1260)

UNIT SIZE 61 3/4" (1568)  
 ROUGH OPENING 60" (1524)  
 FRAME SIZE 59 1/2" (1511)  
 DAYLIGHT OPENING 55 5/8" (1413)

49 3/4" (1264)  
 48" (1219)  
 47 1/2" (1207)  
 43 5/8" (1108)

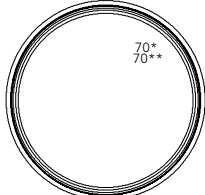

8FR48

55 3/4" (1416)  
 54" (1372)  
 53 1/2" (1359)  
 49 5/8" (1260)

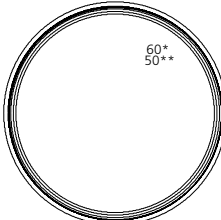

8FR54

61 3/4" (1568)  
 60" (1524)  
 59 1/2" (1511)  
 55 5/8" (1413)

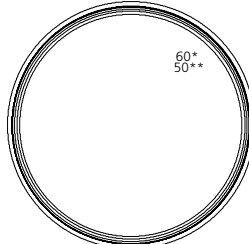

8FR60

**ELEVATION SYMBOL LEGEND:**

VALUES IN () ARE IN MILLIMETER CONVERSIONS.  
 \*\*\* NUMBER INDICATES DESIGN PRESSURE (DP) RATING WITH STANDARD GLAZING.  
 \*\*\* NUMBER INDICATES OPTIONAL DESIGN PRESSURE (DP) RATING.

SCALE: 1/4" = 1'

#### OCTAGON

**UNIT SIZE** 25 3/4" (654)  
**ROUGH OPENING** 24" (610)  
**FRAME SIZE** 23 1/2" (597)  
**DAYLIGHT OPENING** 19 5/8" (498)

25 3/4" (654)  
 24" (610)  
 23 1/2" (597)  
 19 5/8" (498)

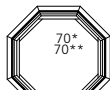

80T24

31 3/4" (806)  
 30" (762)  
 29 1/2" (749)  
 25 5/8" (651)

31 3/4" (806)  
 30" (762)  
 29 1/2" (749)  
 25 5/8" (651)

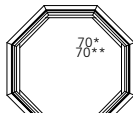

80T30

37 3/4" (959)  
 36" (914)  
 35 1/2" (902)  
 31 5/8" (803)

37 3/4" (959)  
 36" (914)  
 35 1/2" (902)  
 31 5/8" (803)

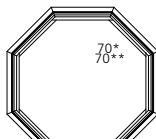

80T36

43 3/4" (1111)  
 42" (1067)  
 41 1/2" (1054)  
 37 5/8" (956)

43 3/4" (1111)  
 42" (1067)  
 41 1/2" (1054)  
 37 5/8" (956)

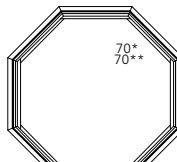

80T42

**UNIT SIZE** 49 3/4" (1264)  
**ROUGH OPENING** 48" (1219)  
**FRAME SIZE** 47 1/2" (1207)  
**DAYLIGHT OPENING** 43 5/8" (1108)

49 3/4" (1264)  
 48" (1219)  
 47 1/2" (1207)  
 43 5/8" (1108)

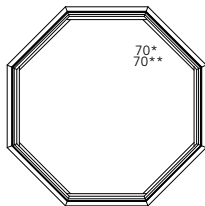

80T48

55 3/4" (1416)  
 54" (1372)  
 53 1/2" (1359)  
 49 5/8" (1260)

55 3/4" (1416)  
 54" (1372)  
 53 1/2" (1359)  
 49 5/8" (1260)

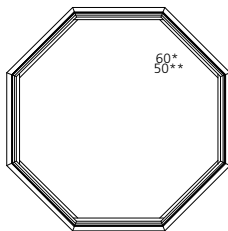

80T54

61 3/4" (1568)  
 60" (1524)  
 59 1/2" (1511)  
 55 5/8" (1413)

61 3/4" (1568)  
 60" (1524)  
 59 1/2" (1511)  
 55 5/8" (1413)

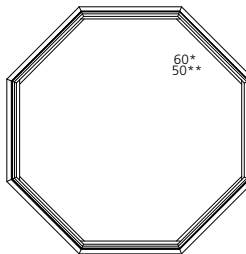

80T60

**ELEVATION SYMBOL LEGEND:**

VALUES IN () ARE IN MILLIMETER CONVERSIONS.

##\* NUMBER INDICATES DESIGN PRESSURE (DP) RATING WITH STANDARD GLAZING.

###\* NUMBER INDICATES OPTIONAL DESIGN PRESSURE (DP) RATING.

**OVAL**

**UNIT SIZE** 25 3/4"(654)  
**ROUGH OPENING** 24"(610)  
**FRAME SIZE** 23 1/2"(597)  
**DAYLIGHT OPENING** 19 5/8"(498)

37 3/4"(959)  
36"(914)  
35 1/2"(902)  
31 5/8"(803)

37 3/4"(959)  
36"(914)  
35 1/2"(902)  
31 5/8"(803)

49 3/4"(1264)  
48"(1219)  
47 1/2"(1207)  
43 5/8"(1108)

37 3/4"(959)  
36"(914)  
35 1/2"(902)  
31 5/8"(803)

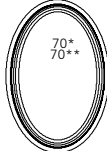

80V2436

25 3/4"(654)  
24"(610)  
23 1/2"(597)  
19 5/8"(498)

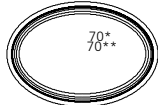

80V3624

49 3/4"(1264)  
48"(1219)  
47 1/2"(1207)  
43 5/8"(1108)

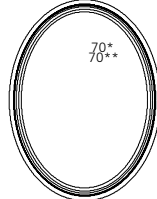

80V3648

37 3/4"(959)  
36"(914)  
35 1/2"(902)  
31 5/8"(803)

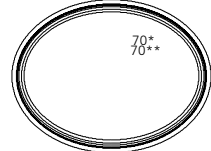

80V4836

**UNIT SIZE** 49 3/4"(1264)  
**ROUGH OPENING** 48"(1219)  
**FRAME SIZE** 47 1/2"(1207)  
**DAYLIGHT OPENING** 43 5/8"(1108)

61 3/4"(1568)  
60"(1524)  
59 1/2"(1511)  
55 5/8"(1413)

61 3/4"(1568)  
60"(1524)  
59 1/2"(1511)  
55 5/8"(1413)

73 3/4"(1873)  
72"(1829)  
71 1/2"(1861)  
67 5/8"(1718)

61 3/4"(1568)  
60"(1524)  
59 1/2"(1511)  
55 5/8"(1413)

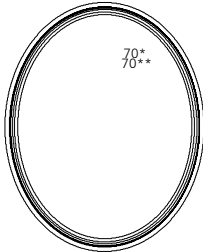

80V4860

49 3/4"(1264)  
48"(1219)  
47 1/2"(1207)  
43 5/8"(1108)

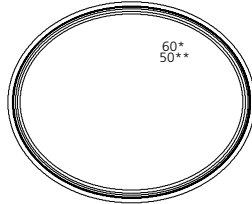

80V6048

73 3/4"(1873)  
72"(1829)  
71 1/2"(1861)  
67 5/8"(1718)

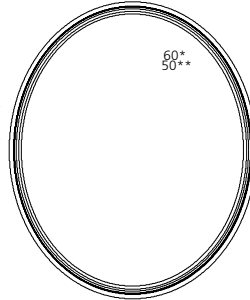

80V6072

61 3/4"(1568)  
60"(1524)  
59 1/2"(1511)  
55 5/8"(1413)

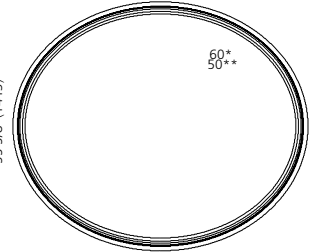

80V7260

**ELEVATION SYMBOL LEGEND:**

VALUES IN () ARE IN MILLIMETER CONVERSIONS.  
##\* NUMBER INDICATES DESIGN PRESSURE (DP) RATING WITH STANDARD GLAZING.  
###\* NUMBER INDICATES OPTIONAL DESIGN PRESSURE (DP) RATING.

SCALE: 1/4" = 1'

#### CIRCLE SEGMENT

**UNIT SIZE** 25 3/4" (654)  
**ROUGH OPENING** 24" (610)  
**FRAME SIZE** 23 1/2" (597)  
**DAYLIGHT OPENING** 19 5/8" (498)

13 3/4" (349)  
 14 5/8" (372)  
 11 7/8" (302)  
 7 5/8" (194)

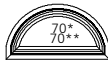

8EY2412

16 3/4" (425)  
 15" (381)  
 14 1/2" (368)  
 10 5/8" (270)



8EY3015

19 3/4" (502)  
 18" (457)  
 17 1/2" (445)  
 13 5/8" (346)

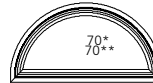

8EY3618

**UNIT SIZE** 43 3/4" (1111)  
**ROUGH OPENING** 42" (1067)  
**FRAME SIZE** 41 1/2" (1054)  
**DAYLIGHT OPENING** 37 5/8" (956)

22 3/4" (578)  
 21 1/2" (543)  
 20 1/2" (521)  
 16 5/8" (422)

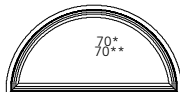

8EY4221

25 3/4" (654)  
 24" (610)  
 23 1/2" (597)  
 19 5/8" (498)

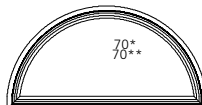

8EY4824

28 3/4" (730)  
 27" (686)  
 26 1/2" (673)  
 22 5/8" (575)

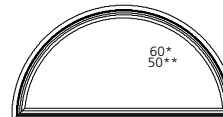

8EY5427

**UNIT SIZE** 61 3/4" (1568)  
**ROUGH OPENING** 60" (1524)  
**FRAME SIZE** 59 1/2" (1511)  
**DAYLIGHT OPENING** 55 5/8" (1413)

31 3/4" (806)  
 30" (762)  
 29 1/2" (749)  
 25 5/8" (651)

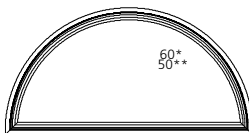

8EY6030

34 3/4" (883)  
 33" (838)  
 32 1/2" (826)  
 28 5/8" (727)

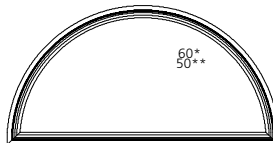

8EY6633

37 3/4" (959)  
 36" (914)  
 35 1/2" (902)  
 31 5/8" (803)

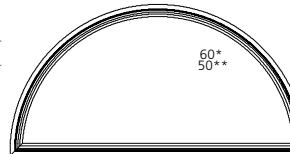

8EY7236

**ELEVATION SYMBOL LEGEND:**

VALUES IN () ARE IN MILLIMETER CONVERSIONS.  
 ### NUMBER INDICATES DESIGN PRESSURE (DP) RATING WITH STANDARD GLAZING.  
 ###\* NUMBER INDICATES OPTIONAL DESIGN PRESSURE (DP) RATING.

#### EXTENDED QUARTER ROUND

UNIT SIZE	19 3/4" (502)	25 3/4" (654)	29 3/4" (756)	31 3/4" (806)	33 3/4" (857)	37 3/4" (959)	41 3/4" (1060)
ROUGH OPENING	18" (457)	24" (610)	28" (711)	30" (762)	32" (813)	36" (914)	40" (1016)
FRAME SIZE	17 1/2" (445)	23 1/2" (597)	27 1/2" (699)	29 1/2" (749)	31 1/2" (800)	35 1/2" (902)	39 1/2" (1003)
DAYLIGHT OPENING	13 5/8" (346)	19 5/8" (498)	23 5/8" (600)	25 5/8" (651)	27 5/8" (702)	31 5/8" (803)	35 5/8" (905)

25 3/4" (654) 24" (610) 23 1/2" (597) 19 5/8" (498)							
31 3/4" (806) 30" (762) 29 1/2" (749) 25 5/8" (651)							
37 3/4" (959) 36" (914) 35 1/2" (902) 31 5/8" (803)							
39 3/4" (1010) 38" (965) 37 1/2" (953) 33 5/8" (854)							
43 3/4" (1111) 42" (1067) 41 1/2" (1054) 37 5/8" (956)							
45 3/4" (1162) 44" (1118) 43 1/2" (1105) 39 5/8" (1006)							
49 3/4" (1264) 48" (1219) 47 1/2" (1207) 43 5/8" (1108)							
53 3/4" (1365) 52" (1321) 51 1/2" (1308) 47 5/8" (1210)							

**ELEVATION SYMBOL LEGEND:**  
 VALUES IN ( ) ARE IN MILLIMETER CONVERSIONS.  
 ### NUMBER INDICATES DESIGN PRESSURE (DP) RATING WITH STANDARD GLAZING.  
 ###\* NUMBER INDICATES OPTIONAL DESIGN PRESSURE (DP) RATING.

SCALE: 1/4" = 1'

#### EXTENDED QUARTER ROUND

UNIT SIZE	19 3/4" (502)	25 3/4" (654)	29 3/4" (756)	31 3/4" (806)	33 3/4" (857)	37 3/4" (959)	41 3/4" (1060)
ROUGH OPENING	18" (457)	24" (610)	28" (711)	30" (762)	32" (813)	36" (914)	40" (1016)
FRAME SIZE	17 1/2" (445)	23 1/2" (597)	27 1/2" (699)	29 1/2" (749)	31 1/2" (800)	35 1/2" (902)	39 1/2" (1003)
DAYLIGHT OPENING	13 5/8" (346)	19 5/8" (498)	23 5/8" (600)	25 5/8" (651)	27 5/8" (702)	31 5/8" (803)	35 5/8" (905)
55 3/4" (1416) 54" (1372) 53 1/2" (1359) 49 5/8" (1260)							
61 3/4" (1568) 60" (1524) 59 1/2" (1511) 55 5/8" (1413)							
63 3/4" (1619) 62" (1575) 61 1/2" (1562) 57 5/8" (1464)							
67 3/4" (1721) 66" (1676) 65 1/2" (1664) 61 5/8" (1565)							
73 3/4" (1873) 72" (1829) 71 1/2" (1861) 67 5/8" (1718)							

**ELEVATION SYMBOL LEGEND:**  
 VALUES IN ( ) ARE IN MILLIMETER CONVERSIONS.  
 ##\* NUMBER INDICATES DESIGN PRESSURE (DP) RATING WITH STANDARD GLAZING.  
 ##\*\* NUMBER INDICATES OPTIONAL DESIGN PRESSURE (DP) RATING.

SCALE: 1/4" = 1'

#### EXTENDED QUARTER ROUND

UNIT SIZE	19 3/4" (502)	25 3/4" (654)	29 3/4" (756)	31 3/4" (806)	33 3/4" (857)	37 3/4" (959)	41 3/4" (1060)
ROUGH OPENING	18" (457)	24" (610)	28" (711)	30" (762)	32" (813)	36" (914)	40" (1016)
FRAME SIZE	17 1/2" (445)	23 1/2" (597)	27 1/2" (699)	29 1/2" (749)	31 1/2" (800)	35 1/2" (902)	39 1/2" (1003)
DAYLIGHT OPENING	13 5/8" (346)	19 5/8" (498)	23 5/8" (600)	25 5/8" (651)	27 5/8" (702)	31 5/8" (803)	35 5/8" (905)

75 3/4" (1924)		74" (1880)	70**
		73 1/2" (1867)	70**
		69 5/8" (1766)	70**
			70**
		70**	70**
		70**	70**
		70**	70**
		70**	70**
		70**	70**
		70**	70**

**ELEVATION SYMBOL LEGEND:**  
 VALUES IN Ø ARE IN MILLIMETER CONVERSIONS.  
 ##\* NUMBER INDICATES DESIGN PRESSURE (DP) RATING WITH STANDARD GLAZING.  
 ##\*\* NUMBER INDICATES OPTIONAL DESIGN PRESSURE (DP) RATING.

SCALE: 1/4" = 1'

#### EXTENDED QUARTER ROUND

UNIT SIZE  
ROUGH OPENING  
FRAME SIZE  
DAYLIGHT OPENING

43 3/4" (1111)  
42" (1067)  
41 1/2" (1054)  
37 5/8" (956)

45 3/4" (1162)  
44" (1118)  
43 1/2" (1105)  
39 5/8" (1006)

49 3/4" (1264)  
48" (1219)  
47 1/2" (1207)  
43 5/8" (1108)

55 3/4" (1416)  
54" (1372)  
53 1/2" (1359)  
49 5/8" (1260)

57 3/4" (1467)  
56" (1422)  
55 1/2" (1410)  
51 5/8" (1311)

49 3/4" (1264)  
48" (1219)  
47 1/2" (1207)  
43 5/8" (1108)

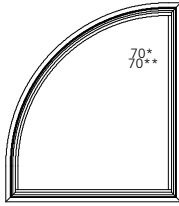

8QT4248

53 3/4" (1365)  
52" (1321)  
51 1/2" (1308)  
47 5/8" (1210)

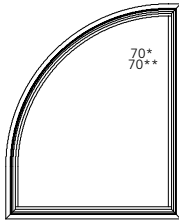

8QT4252

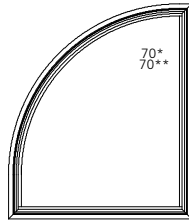

8QT4452

55 3/4" (1416)  
54" (1372)  
53 1/2" (1359)  
49 5/8" (1260)

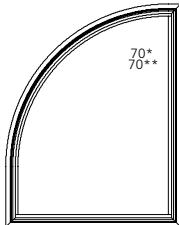

8QT4254

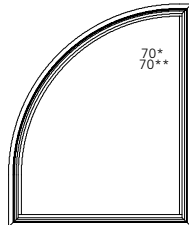

8QT4454

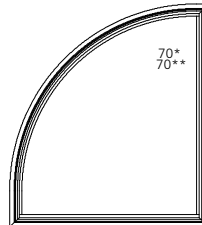

8QT4854

61 3/4" (1568)  
60" (1524)  
59 1/2" (1511)  
55 5/8" (1413)

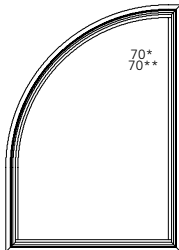

8QT4260

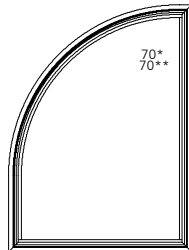

8QT4460

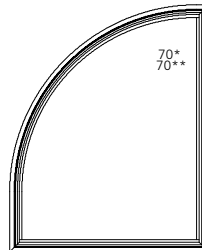

8QT4860

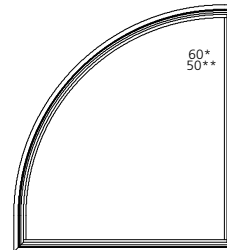

8QT5460

63 3/4" (1619)  
62" (1575)  
61 1/2" (1562)  
57 5/8" (1464)

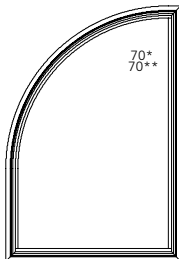

8QT4262

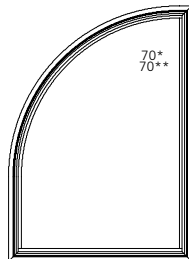

8QT4462

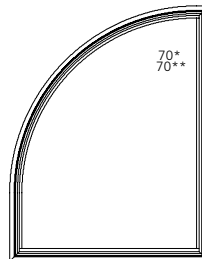

8QT4862

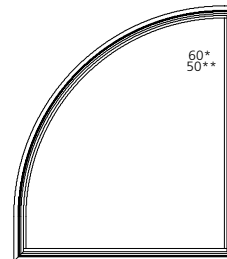

8QT15462

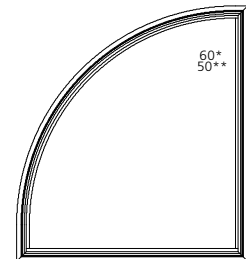

8QT5662

67 3/4" (1721)  
66" (1676)  
65 1/2" (1664)  
61 5/8" (1565)

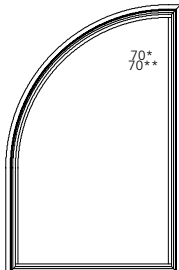

8QT4266

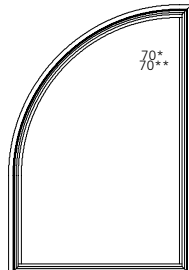

8QT4466

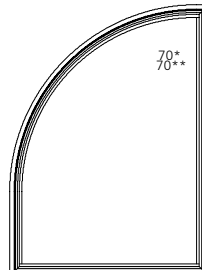

8QT4866

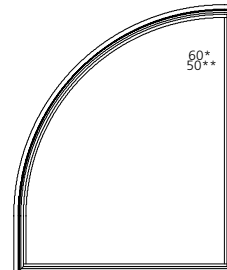

8QT5466

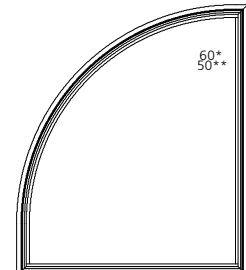

8QT5666

**ELEVATION SYMBOL LEGEND:**

VALUES IN ( ) ARE IN MILLIMETER CONVERSIONS.  
##\* NUMBER INDICATES DESIGN PRESSURE (DP) RATING WITH STANDARD GLAZING.  
###\* NUMBER INDICATES OPTIONAL DESIGN PRESSURE (DP) RATING.

SCALE: 1/4" = 1'



#### EXTENDED QUARTER ROUND

UNIT SIZE  
ROUGH OPENING  
FRAME SIZE  
DAYLIGHT OPENING

43 3/4" (1111)  
42" (1067)  
41 1/2" (1054)  
37 5/8" (956)

45 3/4" (1162)  
44" (1118)  
43 1/2" (1105)  
39 5/8" (1006)

49 3/4" (1264)  
48" (1219)  
47 1/2" (1207)  
43 5/8" (1108)

55 3/4" (1416)  
54" (1372)  
53 1/2" (1359)  
49 5/8" (1260)

57 3/4" (1467)  
56" (1422)  
55 1/2" (1410)  
51 5/8" (1311)

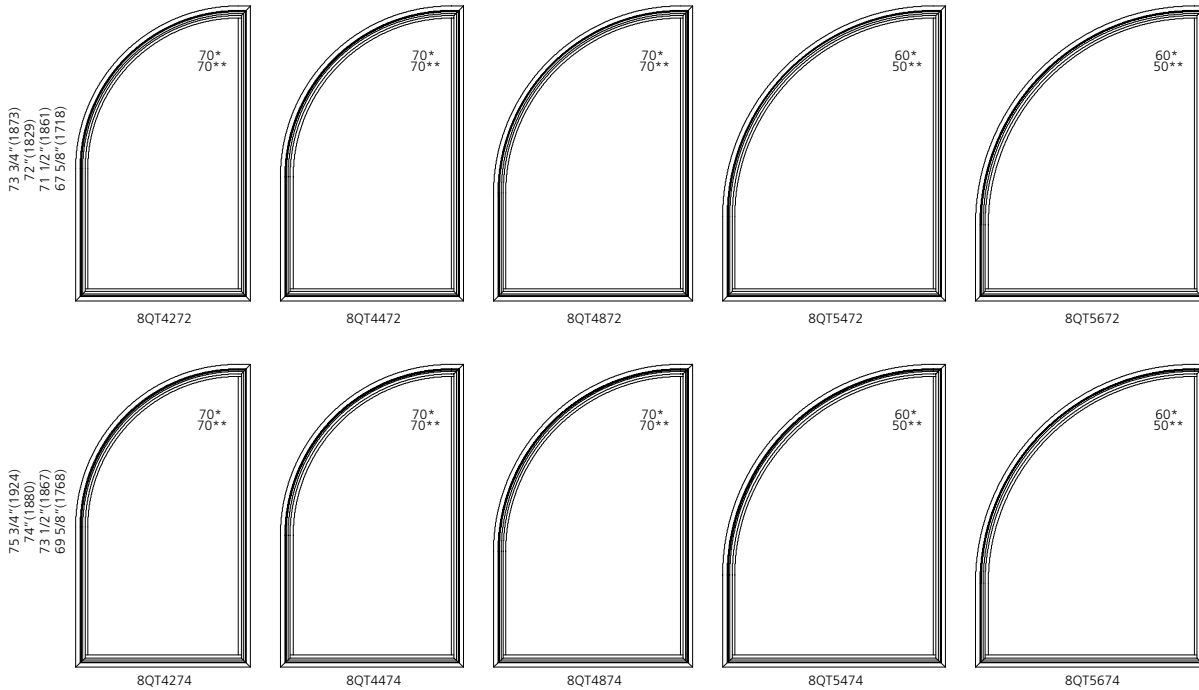

**ELEVATION SYMBOL LEGEND:**  
VALUES IN () ARE IN MILLIMETER CONVERSIONS.  
##\* NUMBER INDICATES DESIGN PRESSURE (DP) RATING WITH STANDARD GLAZING.  
##\*\* NUMBER INDICATES OPTIONAL DESIGN PRESSURE (DP) RATING.

SCALE: 1/4" = 1'

**EXTENDED QUARTER ROUND**

<b>UNIT SIZE</b>	61 3/4"(1568)	67 3/4"(1721)
<b>ROUGH OPENING</b>	60"(1524)	66"(1676)
<b>FRAME SIZE</b>	59 1/2"(1511)	65 1/2"(1664)
<b>DAYLIGHT OPENING</b>	55 5/8"(1413)	61 5/8"(1565)

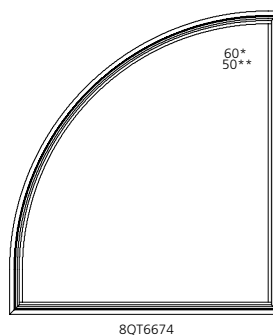
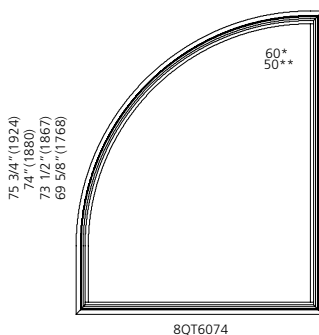
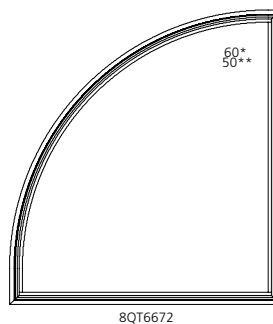
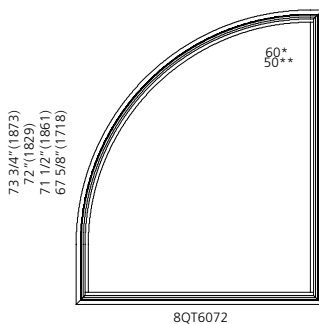
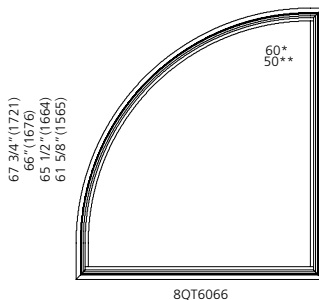

**ELEVATION SYMBOL LEGEND:**  
VALUES IN ( ) ARE IN MILLIMETER CONVERSIONS.  
##\* NUMBER INDICATES DESIGN PRESSURE (DP) RATING WITH STANDARD GLAZING.  
##\*\* NUMBER INDICATES OPTIONAL DESIGN PRESSURE (DP) RATING.

SCALE: 1/4" = 1'

#### EXTENDED HALF ROUND

UNIT SIZE	25 3/4" (654)	29 3/4" (756)	31 3/4" (806)	33 3/4" (857)	37 3/4" (959)	41 3/4" (1060)	43 3/4" (1111)
ROUGH OPENING	24" (610)	28" (711)	30" (762)	32" (813)	36" (914)	40" (1016)	42" (1067)
FRAME SIZE	23 1/2" (597)	27 1/2" (699)	29 1/2" (749)	31 1/2" (800)	35 1/2" (902)	39 1/2" (1003)	41 1/2" (1054)
DAYLIGHT OPENING	19 5/8" (498)	23 5/8" (600)	25 5/8" (651)	27 5/8" (702)	31 5/8" (803)	35 5/8" (905)	37 5/8" (956)
19 3/4" (502) 18" (457) 17 1/2" (445) 13 5/8" (346)							
25 3/4" (654) 24" (610) 23 1/2" (597) 19 5/8" (498)							
31 3/4" (806) 30" (762) 29 1/2" (749) 25 5/8" (651)							
37 3/4" (959) 36" (914) 35 1/2" (902) 31 5/8" (803)							
39 3/4" (1010) 38" (965) 37 1/2" (953) 33 5/8" (854)							
43 3/4" (1111) 42" (1067) 41 1/2" (1054) 37 5/8" (956)							
45 3/4" (1162) 44" (1118) 43 1/2" (1105) 39 5/8" (1006)							
49 3/4" (1264) 48" (1219) 47 1/2" (1207) 43 5/8" (1108)							

**ELEVATION SYMBOL LEGEND:**  
 VALUES IN ( ) ARE IN MILLIMETER CONVERSIONS.  
 ### NUMBER INDICATES DESIGN PRESSURE (DP) RATING WITH STANDARD GLAZING.  
 #### NUMBER INDICATES OPTIONAL DESIGN PRESSURE (DP) RATING.

SCALE: 1/4" = 1'

#### EXTENDED HALF ROUND

**UNIT SIZE**  
**ROUGH OPENING**  
**FRAME SIZE**  
**DAYLIGHT OPENING**

25 3/4" (654)  
24" (610)  
23 1/2" (597)  
19 5/8" (498)

29 3/4" (756)  
28" (711)  
27 1/2" (699)  
23 5/8" (600)

31 3/4" (806)  
30" (762)  
29 1/2" (749)  
25 5/8" (651)

33 3/4" (857)  
32" (813)  
31 1/2" (800)  
27 5/8" (702)

37 3/4" (959)  
36" (914)  
35 1/2" (902)  
31 5/8" (803)

41 3/4" (1060)  
40" (1016)  
39 1/2" (1003)  
35 5/8" (905)

43 3/4" (1111)  
42" (1067)  
41 1/2" (1054)  
37 5/8" (956)

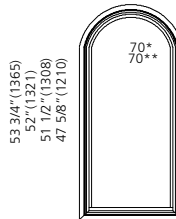

85L2452

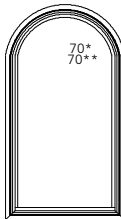

85L2852

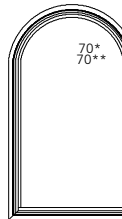

85L3052

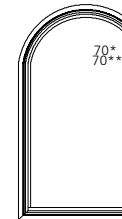

85L3252

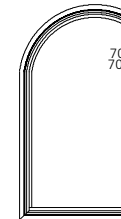

85L3652

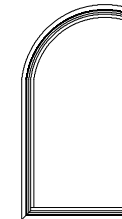

85L4052

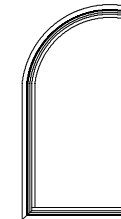

85L4252

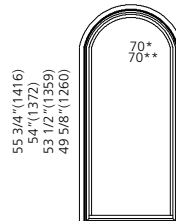

85L2454

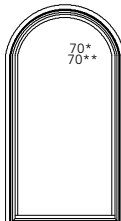

85L2854

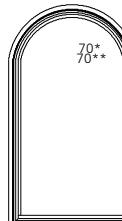

85L3054

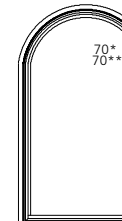

85L3254

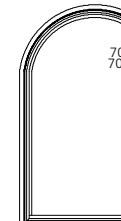

85L3654

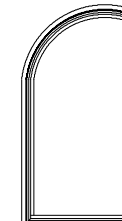

85L4054

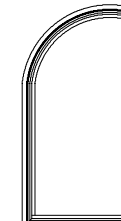

85L4254

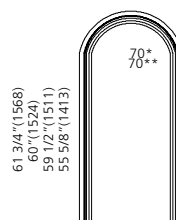

85L2460

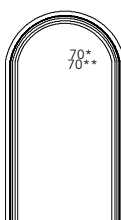

85L2860

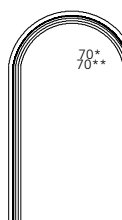

85L3060

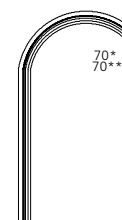

85L3260

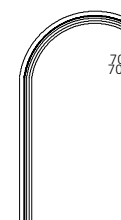

85L3660

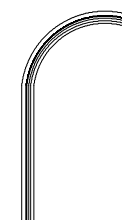

85L4060

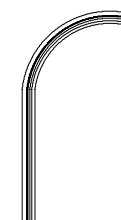

85L4260

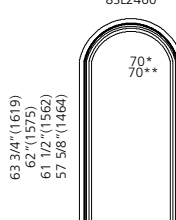

85L2462

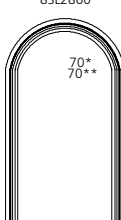

85L2862

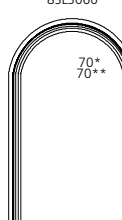

85L3062

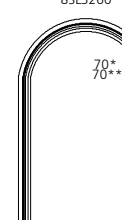

85L3262

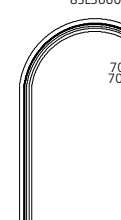

85L3662

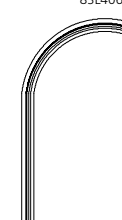

85L4062



85L4262

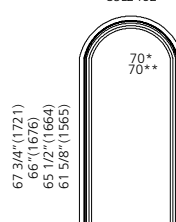

85L2466

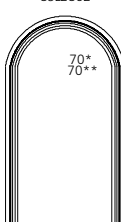

85L2866

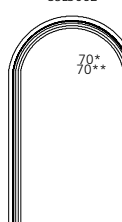

85L3066

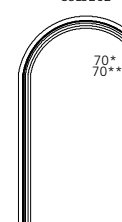

85L3266

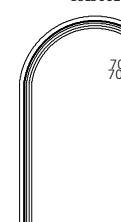

85L3666

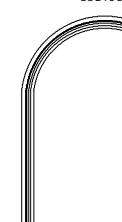

85L4066



85L4266

**ELEVATION SYMBOL LEGEND:**

VALUES IN () ARE IN MILLIMETER CONVERSIONS.  
**##\*** NUMBER INDICATES DESIGN PRESSURE (DP) RATING WITH STANDARD GLAZING.  
**##\*\*** NUMBER INDICATES OPTIONAL DESIGN PRESSURE (DP) RATING.

SCALE: 1/4" = 1'

#### EXTENDED HALF ROUND

UNIT SIZE  
ROUGH OPENING  
FRAME SIZE  
DAYLIGHT OPENING

25 3/4" (654)  
24" (610)  
23 1/2" (597)  
19 5/8" (498)

29 3/4" (756)  
28" (711)  
27 1/2" (699)  
23 5/8" (600)

31 3/4" (806)  
30" (762)  
29 1/2" (749)  
25 5/8" (651)

33 3/4" (857)  
32" (813)  
31 1/2" (800)  
27 5/8" (702)

37 3/4" (959)  
36" (914)  
35 1/2" (902)  
31 5/8" (803)

41 3/4" (1060)  
40" (1016)  
39 1/2" (1003)  
35 5/8" (905)

43 3/4" (1111)  
42" (1067)  
41 1/2" (1054)  
37 5/8" (956)

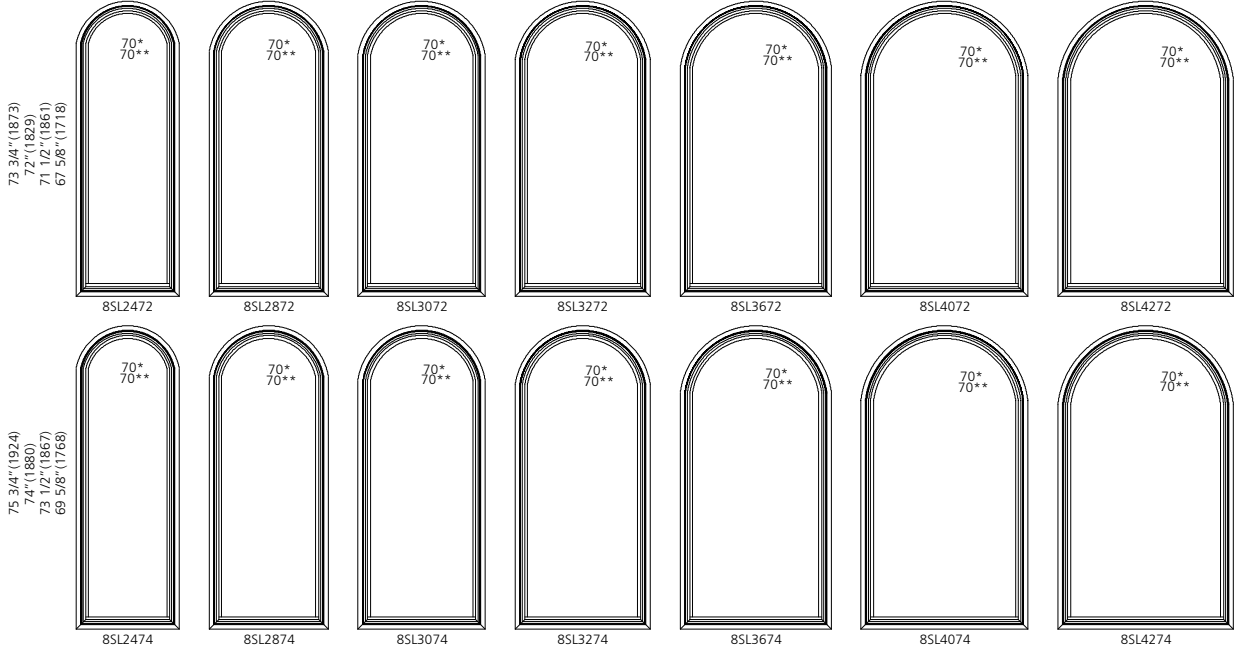

**ELEVATION SYMBOL LEGEND:**

VALUES IN () ARE IN MILLIMETER CONVERSIONS.  
**##\*** NUMBER INDICATES DESIGN PRESSURE (DP) RATING WITH STANDARD GLAZING.  
**###\*** NUMBER INDICATES OPTIONAL DESIGN PRESSURE (DP) RATING.

SCALE: 1/4" = 1'

**EXTENDED HALF ROUND**

UNIT SIZE ROUGH OPENING FRAME SIZE DAYLIGHT OPENING	45 3/4" (1162) 44" (1118) 43 1/2" (1105) 39 5/8" (1006)	49 3/4" (1264) 48" (1219) 47 1/2" (1207) 43 5/8" (1108)	55 3/4" (1416) 54" (1372) 53 1/2" (1359) 49 5/8" (1260)	57 3/4" (1467) 56" (1422) 55 1/2" (1410) 51 5/8" (1311)
31 3/4" (806) 30" (762) 29 1/2" (753) 25 5/8" (651)				
37 3/4" (959) 36" (914) 35 1/2" (902) 31 5/8" (803)				
39 3/4" (1010) 38" (965) 37 1/2" (953) 33 5/8" (854)				
43 3/4" (1111) 42" (1066) 41 1/2" (1054) 37 5/8" (956)				
45 3/4" (1162) 44" (1118) 43 1/2" (1105) 39 5/8" (1006)				
49 3/4" (1264) 48" (1219) 47 1/2" (1207) 43 5/8" (1108)				
53 3/4" (1365) 52" (1320) 51 1/2" (1308) 47 5/8" (1210)				
55 3/4" (1416) 54" (1372) 53 1/2" (1359) 49 5/8" (1260)				

**ELEVATION SYMBOL LEGEND:**  
VALUES IN ( ) ARE IN MILLIMETER CONVERSIONS.  
##\* NUMBER INDICATES DESIGN PRESSURE (DP) RATING WITH STANDARD GLAZING.  
###\* NUMBER INDICATES OPTIONAL DESIGN PRESSURE (DP) RATING.

SCALE: 1/4" = 1'

#### EXTENDED HALF ROUND

UNIT SIZE 45 3/4" (1162)  
 ROUGH OPENING 44" (1118)  
 FRAME SIZE 43 1/2" (1105)  
 DAYLIGHT OPENING 39 5/8" (1006)

49 3/4" (1264)  
 48" (1219)  
 47 1/2" (1207)  
 43 5/8" (1108)

55 3/4" (1416)  
 54" (1372)  
 53 1/2" (1359)  
 49 5/8" (1260)

57 3/4" (1467)  
 56" (1422)  
 55 1/2" (1410)  
 51 5/8" (1311)

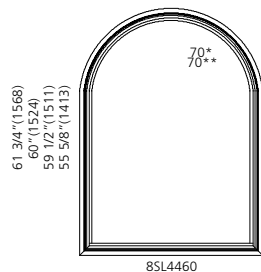

85L4460

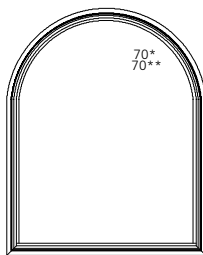

85L4860

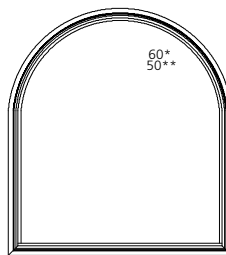

85L5460

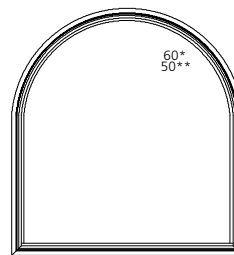

85L5660

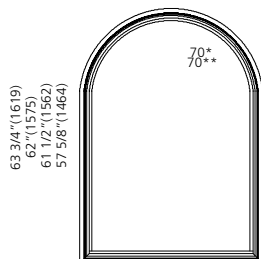

85L4462

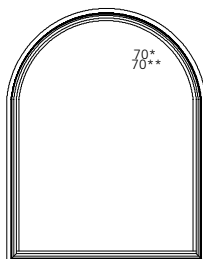

85L4862

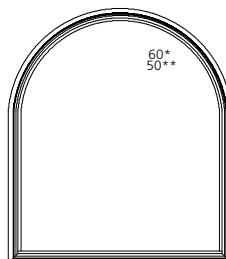

85L5462

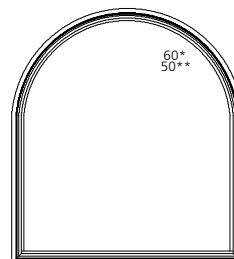

85L5662

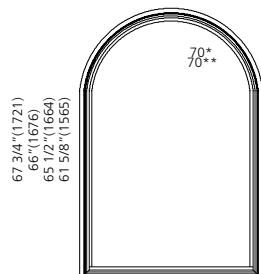

85L4466

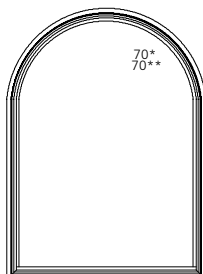

85L4866

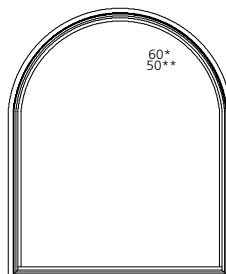

85L5466

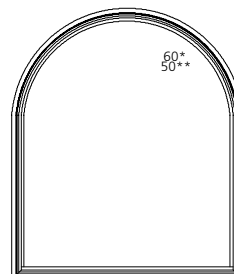

85L5666

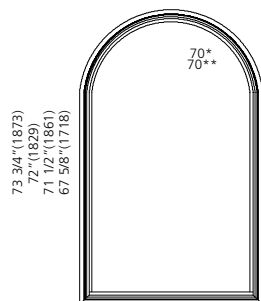

85L4472

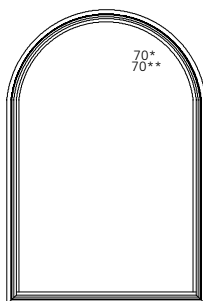

85L4872

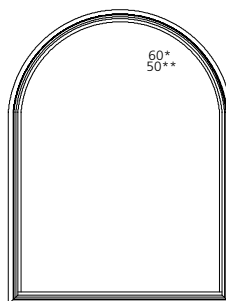

85L5472

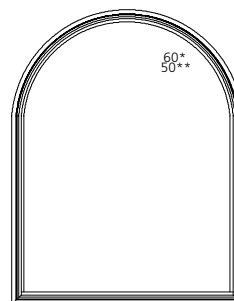

85L5672

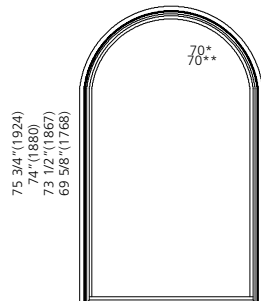

85L4474

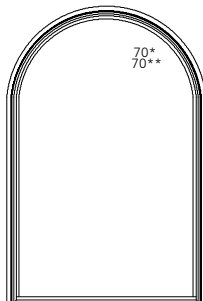

85L4874

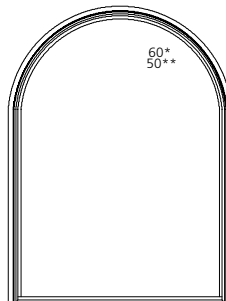

85L5474

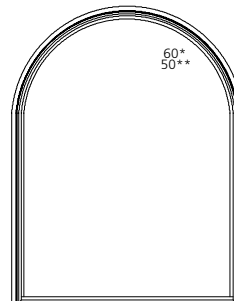

85L5674

**ELEVATION SYMBOL LEGEND:**  
 VALUES IN ( ) ARE IN MILLIMETER CONVERSIONS.  
 \*\*\* NUMBER INDICATES DESIGN PRESSURE (DP) RATING WITH STANDARD GLAZING.  
 \*\*\*\* NUMBER INDICATES OPTIONAL DESIGN PRESSURE (DP) RATING.

SCALE: 1/4" = 1'

#### EXTENDED HALF ROUND

UNIT SIZE  
ROUGH OPENING  
FRAME SIZE  
DAYLIGHT OPENING

61 3/4" (1568)  
60" (1524)  
59 1/2" (1511)  
55 5/8" (1413)

67 3/4" (1721)  
66" (1676)  
65 1/2" (1664)  
61 5/8" (1565)

73 3/4" (1873)  
72" (1829)  
71 1/2" (1861)  
67 5/8" (1718)

37 3/4" (959)  
36" (914)  
35 1/2" (902)  
31 5/8" (803)

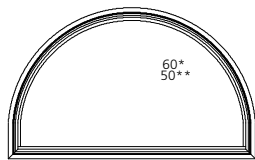

85L6036

39 3/4" (1010)  
38" (965)  
37 1/2" (953)  
33 5/8" (854)

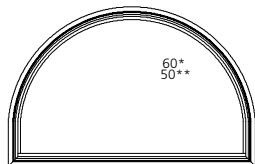

85L6038

43 3/4" (1111)  
42" (1067)  
41 1/2" (1054)  
37 5/8" (956)

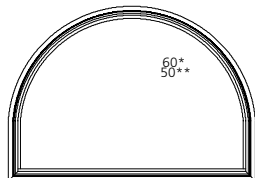

85L6042

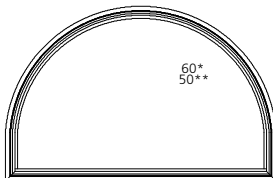

85L6642

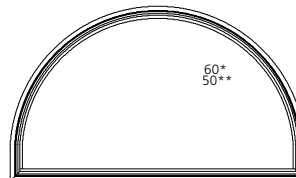

85L7242

45 3/4" (1162)  
44" (1118)  
43 1/2" (1105)  
39 5/8" (1006)

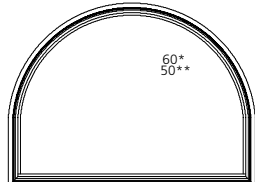

85L6044

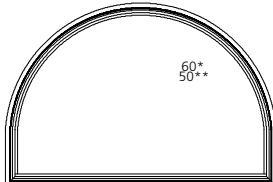

85L6644

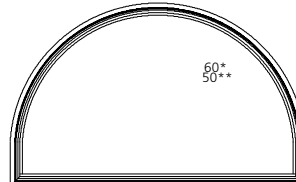

85L7244

49 3/4" (1264)  
48" (1219)  
47 1/2" (1207)  
43 5/8" (1108)

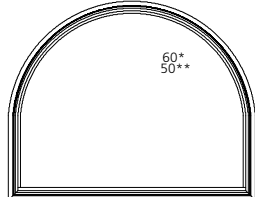

85L6048

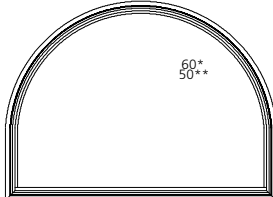

85L6648

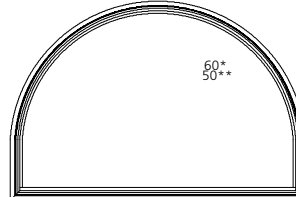

85L7248

53 3/4" (1365)  
52" (1321)  
51 1/2" (1308)  
47 5/8" (1210)

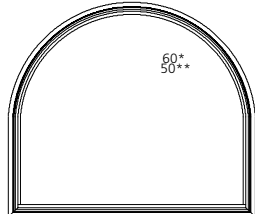

85L6052

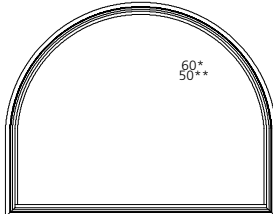

85L6652

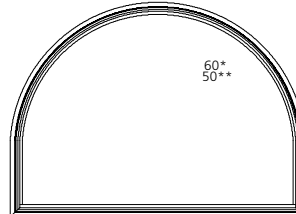

85L7252

55 3/4" (1416)  
54" (1372)  
53 1/2" (1359)  
49 5/8" (1260)

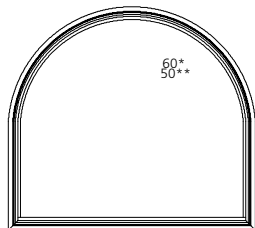

85L6054

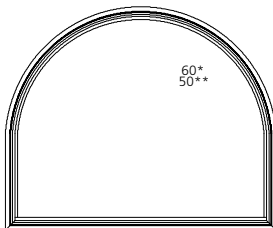

85L6654

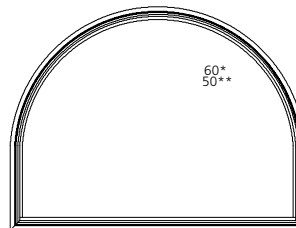

85L7254

**ELEVATION SYMBOL LEGEND:**

VALUES IN ( ) ARE IN MILLIMETER CONVERSIONS.  
##\* NUMBER INDICATES DESIGN PRESSURE (DP) RATING WITH STANDARD GLAZING.  
###\* NUMBER INDICATES OPTIONAL DESIGN PRESSURE (DP) RATING.

SCALE: 1/4" = 1'



#### EXTENDED HALF ROUND

UNIT SIZE  
ROUGH OPENING  
FRAME SIZE  
DAYLIGHT OPENING

61 3/4" (1568)  
60" (1524)  
59 1/2" (1511)  
55 5/8" (1413)

67 3/4" (1721)  
66" (1676)  
65 1/2" (1664)  
61 5/8" (1565)

73 3/4" (1873)  
72" (1829)  
71 1/2" (1861)  
67 5/8" (1718)

61 3/4" (1568)  
60" (1524)  
59 1/2" (1511)  
55 5/8" (1413)

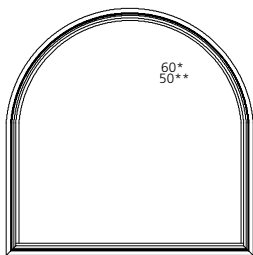

85L6060

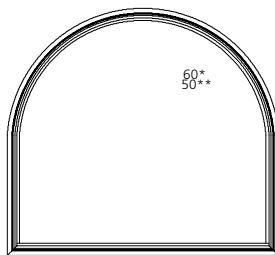

85L6660

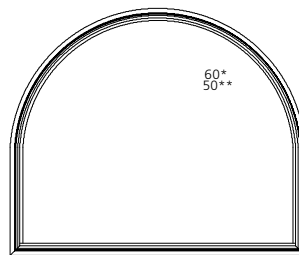

85L7260

63 3/4" (1619)  
62" (1575)  
61 1/2" (1562)  
57 5/8" (1464)

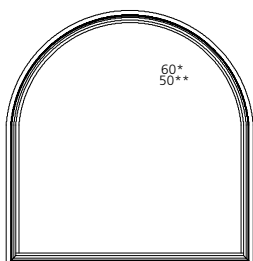

85L6062

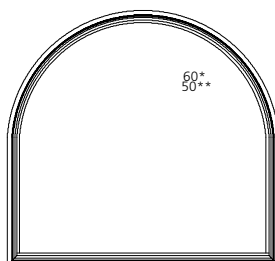

85L6662

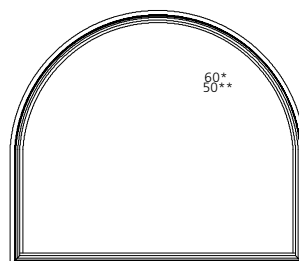

85L7262

67 3/4" (1721)  
66" (1676)  
65 1/2" (1664)  
61 5/8" (1565)

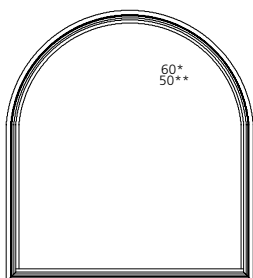

85L6066

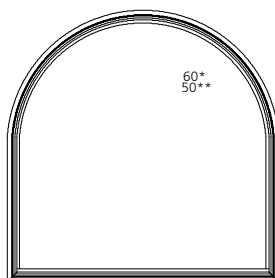

85L6666

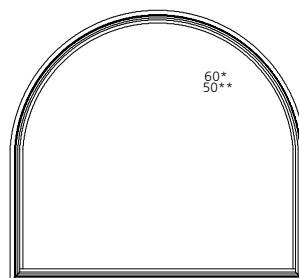

85L7266

73 3/4" (1873)  
72" (1829)  
71 1/2" (1861)  
67 5/8" (1718)

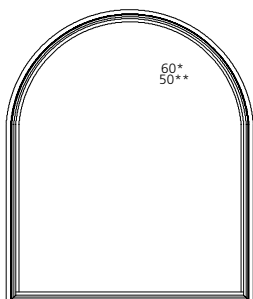

85L6072

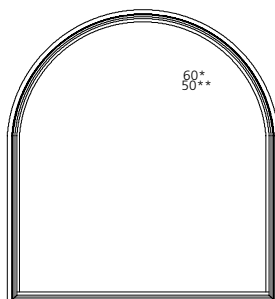

85L6672

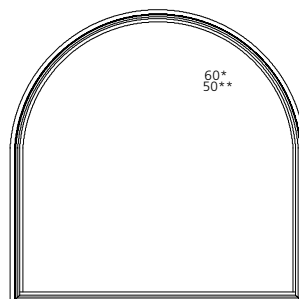

85L7272

75 3/4" (1924)  
74" (1880)  
73 1/2" (1867)  
69 5/8" (1768)

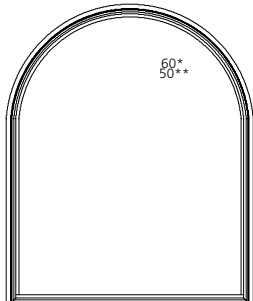

85L6074

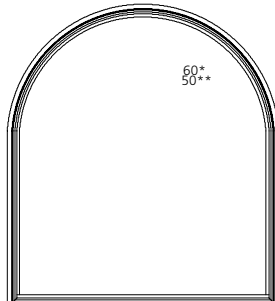

85L6674

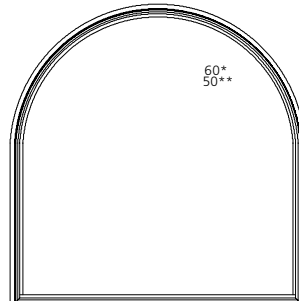

85L7274

**ELEVATION SYMBOL LEGEND:**

VALUES IN ( ) ARE IN MILLIMETER CONVERSIONS.  
##\* NUMBER INDICATES DESIGN PRESSURE (DP) RATING WITH STANDARD GLAZING.  
###\* NUMBER INDICATES OPTIONAL DESIGN PRESSURE (DP) RATING.

SCALE: 1/4" = 1'

**EXTENDED HALF ROUND**

UNIT SIZE 75 3/4" (1924)  
ROUGH OPENING 74" (1880)  
FRAME SIZE 73 1/2" (1867)  
DAYLIGHT OPENING 69 5/8" (1768)

43 3/4" (1111)  
42" (1067)  
41 1/2" (1054)  
37 5/8" (956)

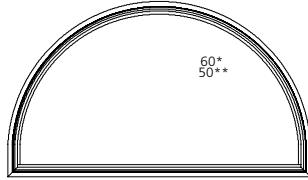

8SL7442

45 3/4" (1162)  
44" (1118)  
43 1/2" (1105)  
39 5/8" (1006)

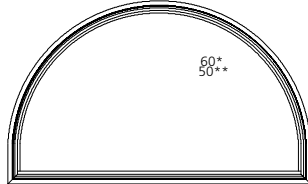

8SL7444

49 3/4" (1264)  
48" (1219)  
47 1/2" (1207)  
43 5/8" (1108)

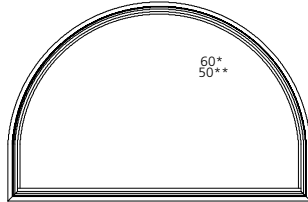

8SL7448

53 3/4" (1365)  
52" (1321)  
51 1/2" (1308)  
47 5/8" (1210)

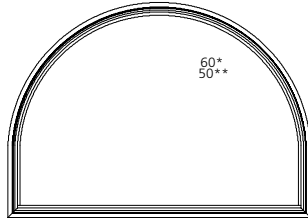

8SL7452

55 3/4" (1416)  
54" (1372)  
53 1/2" (1359)  
49 5/8" (1260)

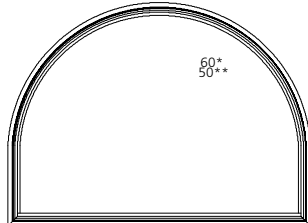

8SL7454

61 3/4" (1568)  
60" (1524)  
59 1/2" (1511)  
55 5/8" (1413)

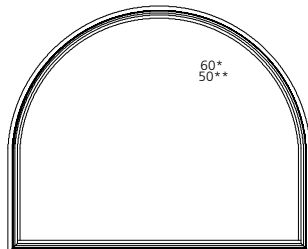

8SL7460

UNIT SIZE 75 3/4" (1924)  
ROUGH OPENING 74" (1880)  
FRAME SIZE 73 1/2" (1867)  
DAYLIGHT OPENING 69 5/8" (1768)

63 3/4" (1619)  
62" (1575)  
61 1/2" (1562)  
57 5/8" (1464)

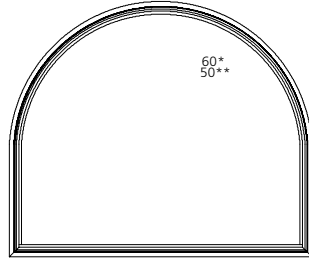

8SL7462

67 3/4" (1721)  
66" (1676)  
65 1/2" (1664)  
61 5/8" (1565)

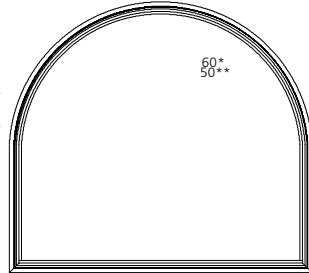

8SL7466

73 3/4" (1873)  
72" (1829)  
71 1/2" (1861)  
67 5/8" (1718)

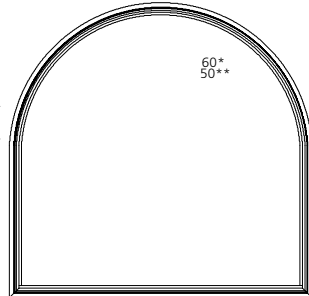

8SL7472

75 3/4" (1924)  
74" (1880)  
73 1/2" (1867)  
69 5/8" (1768)

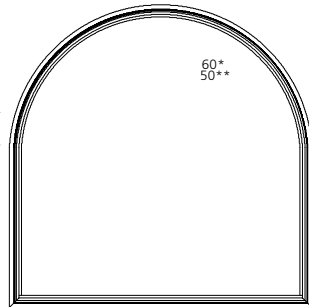

8SL7474

**ELEVATION SYMBOL LEGEND:**  
VALUES IN () ARE IN MILLIMETER CONVERSIONS.  
##\* NUMBER INDICATES DESIGN PRESSURE (DP) RATING WITH STANDARD GLAZING.  
###\* NUMBER INDICATES OPTIONAL DESIGN PRESSURE (DP) RATING.

SCALE: 1/4" = 1'

#### EXTENDED QUARTER SEGMENT

UNIT SIZE	19 3/4" (502)	25 3/4" (654)	29 3/4" (756)	31 3/4" (806)	33 3/4" (857)	37 3/4" (959)	41 3/4" (1060)
<b>ROUGH OPENING</b>	18" (457)	24" (610)	28" (711)	30" (762)	32" (813)	36" (914)	40" (1016)
<b>FRAME SIZE</b>	17 1/2" (445)	23 1/2" (597)	27 1/2" (699)	29 1/2" (749)	31 1/2" (800)	35 1/2" (902)	39 1/2" (1003)
<b>DAYLIGHT OPENING</b>	13 5/8" (346)	19 5/8" (498)	23 5/8" (600)	25 5/8" (651)	27 5/8" (702)	31 5/8" (803)	35 5/8" (905)
13 3/4" (849)							
12" (305)							
11 1/2" (292)							
7 5/8" (194)							
19 3/4" (502)							
18" (457)							
17 1/2" (445)							
13 5/8" (346)							
25 3/4" (654)							
24" (610)							
23 1/2" (597)							
19 5/8" (498)							
31 3/4" (806)							
30" (762)							
29 1/2" (749)							
25 5/8" (651)							
37 3/4" (959)							
36" (914)							
35 1/2" (902)							
31 5/8" (803)							
39 3/4" (1010)							
38" (965)							
37 1/2" (953)							
33 5/8" (854)							
43 3/4" (1111)							
42" (1067)							
41 1/2" (1054)							
37 5/8" (956)							
45 3/4" (1162)							
44" (1118)							
43 1/2" (1105)							
39 5/8" (1006)							
49 3/4" (1264)							
48" (1219)							
47 1/2" (1207)							
43 5/8" (1108)							

**ELEVATION SYMBOL LEGEND:**  
 VALUES IN ( ) ARE IN MILLIMETER CONVERSIONS.  
 ##\* NUMBER INDICATES DESIGN PRESSURE (DP) RATINGS WITH STANDARD GLAZING.  
 ###\* NUMBER INDICATES OPTIONAL DESIGN PRESSURE (DP) RATINGS.

SCALE: 1/4" = 1'

#### EXTENDED QUARTER SEGMENT

UNIT SIZE	19 3/4" (502)	25 3/4" (654)	29 3/4" (756)	31 3/4" (806)	33 3/4" (857)	37 3/4" (959)	41 3/4" (1060)
ROUGH OPENING	18" (457)	24" (610)	28" (711)	30" (762)	32" (813)	36" (914)	40" (1016)
FRAME SIZE	17 1/2" (445)	23 1/2" (597)	27 1/2" (699)	29 1/2" (749)	31 1/2" (800)	35 1/2" (902)	39 1/2" (1003)
DAYLIGHT OPENING	13 5/8" (346)	19 5/8" (498)	23 5/8" (600)	25 5/8" (651)	27 5/8" (702)	31 5/8" (803)	35 5/8" (905)
53 3/4" (1365) 52" (1321) 51 1/2" (1308) 47 5/8" (1210)							
55 3/4" (1416) 54" (1372) 53 1/2" (1359) 49 5/8" (1260)							
61 3/4" (1568) 60" (1524) 59 1/2" (1511) 55 5/8" (1413)							
63 3/4" (1619) 62" (1575) 61 1/2" (1562) 57 5/8" (1464)							
67 3/4" (1721) 66" (1676) 65 1/2" (1664) 61 5/8" (1565)							

**ELEVATION SYMBOL LEGEND:**  
 VALUES IN ( ) ARE IN MILLIMETER CONVERSIONS.  
 ##\* NUMBER INDICATES DESIGN PRESSURE (DP) RATING WITH STANDARD GLAZING.  
 ###\* NUMBER INDICATES OPTIONAL DESIGN PRESSURE (DP) RATING.

SCALE: 1/4" = 1'

#### EXTENDED QUARTER SEGMENT

	19 3/4" (502)	25 3/4" (654)	29 3/4" (756)	31 3/4" (806)	33 3/4" (857)	37 3/4" (959)	41 3/4" (1060)
<b>UNIT SIZE</b>	19 3/4" (502)	25 3/4" (654)	29 3/4" (756)	31 3/4" (806)	33 3/4" (857)	37 3/4" (959)	41 3/4" (1060)
<b>ROUGH OPENING</b>	18" (457)	24" (610)	28" (711)	30" (762)	32" (813)	36" (914)	40" (1016)
<b>FRAME SIZE</b>	17 1/2" (445)	23 1/2" (597)	27 1/2" (699)	29 1/2" (749)	31 1/2" (800)	35 1/2" (902)	39 1/2" (1003)
<b>DAYLIGHT OPENING</b>	13 5/8" (346)	19 5/8" (498)	23 5/8" (600)	25 5/8" (651)	27 5/8" (702)	31 5/8" (803)	35 5/8" (905)

73 3/4" (1873) 72" (1829) 71 1/2" (1861) 67 5/8" (1718)								
	8QP1872-L	8QP2472-L	8QP2872-L	8QP3072-L	8QP3272-L	8QP3672-L	8QP4072-L	
	75 3/4" (1924) 74" (1880) 73 1/2" (1867) 69 5/8" (1768)							
		8QP1874-L	8QP2474-L	8QP2874-L	8QP3074-L	8QP3274-L	8QP3674-L	8QP4074-L

**ELEVATION SYMBOL LEGEND:**  
 VALUES IN ( ) ARE IN MILLIMETER CONVERSIONS.  
 ##\* NUMBER INDICATES DESIGN PRESSURE (DP) RATING WITH STANDARD GLAZING.  
 ###\* NUMBER INDICATES OPTIONAL DESIGN PRESSURE (DP) RATING.

SCALE: 1/4" = 1'

#### EXTENDED QUARTER SEGMENT

UNIT SIZE ROUGH OPENING FRAME SIZE DAYLIGHT OPENING	43 3/4" (1111) 42" (1067) 41 1/2" (1054) 37 5/8" (956)	45 3/4" (1162) 44" (1118) 43 1/2" (1105) 39 5/8" (1006)	49 3/4" (1264) 48" (1219) 47 1/2" (1207) 43 5/8" (1108)	55 3/4" (1416) 54" (1372) 53 1/2" (1359) 49 5/8" (1260)	57 3/4" (1467) 56" (1422) 55 1/2" (1410) 51 5/8" (1311)
13 3/4" (349) 12" (305) 18" (457) 17 1/2" (445) 7 5/8" (194)					
19 3/4" (502) 18" (457) 17 1/2" (445) 13 5/8" (346)					
25 3/4" (654) 24" (610) 23 1/2" (597) 19 5/8" (498)					
31 3/4" (806) 30" (762) 29 1/2" (749) 25 5/8" (651)					
37 3/4" (959) 36" (914) 35 1/2" (902) 31 5/8" (803)					
39 3/4" (1010) 38" (965) 37 1/2" (953) 33 5/8" (854)					
43 3/4" (1111) 42" (1067) 41 1/2" (1054) 37 5/8" (956)					
45 3/4" (1162) 44" (1118) 43 1/2" (1105) 39 5/8" (1006)					
49 3/4" (1264) 48" (1219) 47 1/2" (1207) 43 5/8" (1108)					

**ELEVATION SYMBOL LEGEND:**  
 VALUES IN ( ) ARE IN MILLIMETER CONVERSIONS.  
 ## NUMBER INDICATES DESIGN PRESSURE (DP) RATING WITH STANDARD GLAZING.  
 ### NUMBER INDICATES OPTIONAL DESIGN PRESSURE (DP) RATING.

SCALE: 1/4" = 1'

### EXTENDED QUARTER SEGMENT

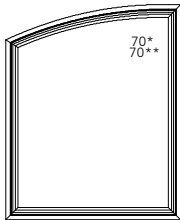
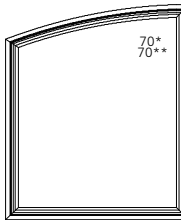
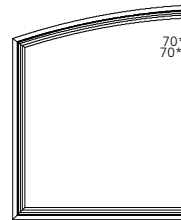
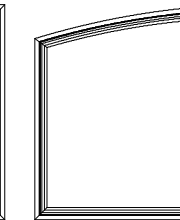
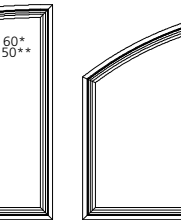
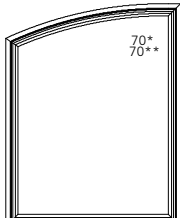
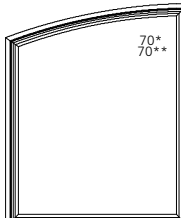
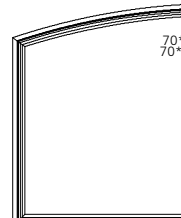
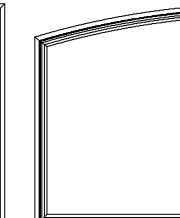
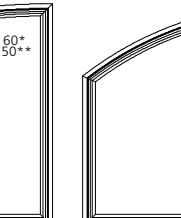
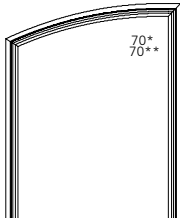
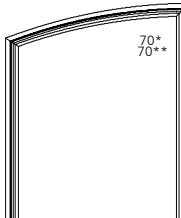
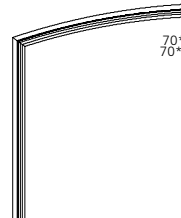
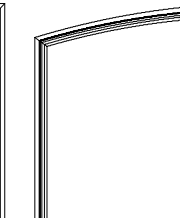
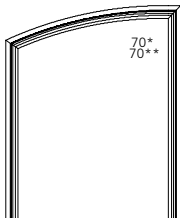
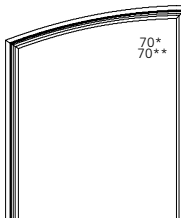
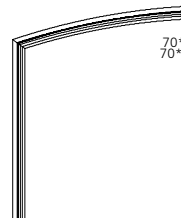
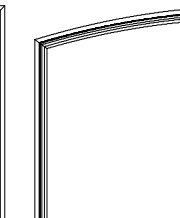
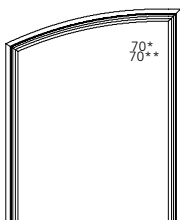
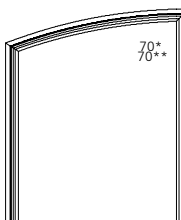
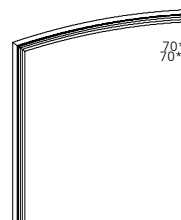
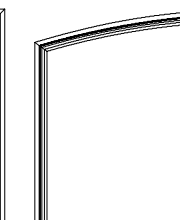
UNIT SIZE	43 3/4" (1111)	45 3/4" (1162)	49 3/4" (1264)	55 3/4" (1416)	57 3/4" (1467)	
ROUGH OPENING	42" (1067)	44" (1118)	48" (1219)	54" (1372)	56" (1422)	
FRAME SIZE	41 1/2" (1054)	43 1/2" (1105)	47 1/2" (1207)	53 1/2" (1359)	55 1/2" (1410)	
DAYLIGHT OPENING	37 5/8" (956)	39 5/8" (1006)	43 5/8" (1108)	49 5/8" (1260)	51 5/8" (1311)	
53 3/4" (1365) 52" (1321) 51 1/2" (1308) 47 5/8" (1210)	 70* 70**	 70* 70**	 70* 70**	 60* 50**	 60* 50**	
	8QP4252-L	8QP4452-L	8QP4852-L	8QP5452-L	8QP5652-L	
	55 3/4" (1416) 54" (1372) 53 1/2" (1359) 49 5/8" (1260)	 70* 70**	 70* 70**	 70* 70**	 60* 50**	 60* 50**
		8QP4254-L	8QP4454-L	8QP4854-L	8QP5454-L	8QP5654-L
		61 3/4" (1568) 60" (1524) 59 1/2" (1511) 55 5/8" (1413)	 70* 70**	 70* 70**	 70* 70**	 60* 50**
8QP4260-L			8QP4460-L	8QP4860-L	8QP5460-L	8QP5660-L
63 3/4" (1619) 62" (1575) 61 1/2" (1562) 57 5/8" (1464)			 70* 70**	 70* 70**	 70* 70**	 60* 50**
	8QP4262-L		8QP4462-L	8QP4862-L	8QP5462-L	8QP5662-L
	67 3/4" (1721) 66" (1676) 65 1/2" (1664) 61 5/8" (1565)		 70* 70**	 70* 70**	 70* 70**	 60* 50**
		8QP4266-L	8QP4466-L	8QP4866-L	8QP5466-L	8QP5666-L

**ELEVATION SYMBOL LEGEND:**  
 VALUES IN ( ) ARE IN MILLIMETER CONVERSIONS.  
 ##\* NUMBER INDICATES DESIGN PRESSURE (DP) RATING WITH STANDARD GLAZING.  
 ##\*\* NUMBER INDICATES OPTIONAL DESIGN PRESSURE (DP) RATING.

SCALE: 1/4" = 1'

#### EXTENDED QUARTER SEGMENT

UNIT SIZE  
ROUGH OPENING  
FRAME SIZE  
DAYLIGHT OPENING

43 3/4" (1111)  
42" (1067)  
41 1/2" (1054)  
37 5/8" (956)

45 3/4" (1162)  
44" (1118)  
43 1/2" (1105)  
39 5/8" (1006)

49 3/4" (1264)  
48" (1219)  
47 1/2" (1207)  
43 5/8" (1108)

55 3/4" (1416)  
54" (1372)  
53 1/2" (1359)  
49 5/8" (1260)

57 3/4" (1467)  
56" (1422)  
55 1/2" (1410)  
51 5/8" (1311)

73 3/4" (1873)  
72" (1829)  
71 1/2" (1861)  
67 5/8" (1718)

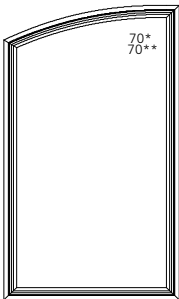

8QP4272-L

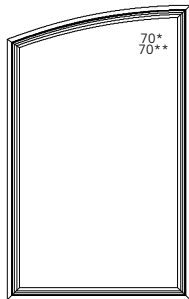

8QP4472-L

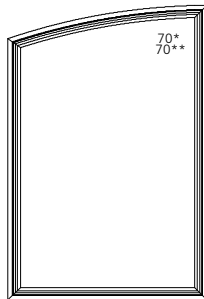

8QP4872-L

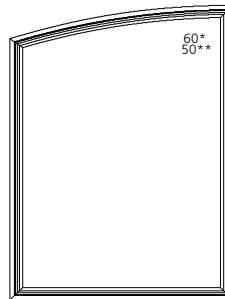

8QP5472-L

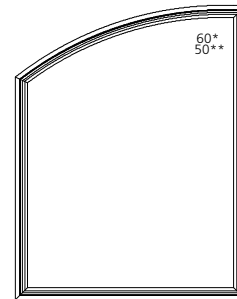

8QP5672-L

75 3/4" (1924)  
74" (1880)  
73 1/2" (1867)  
69 5/8" (1768)

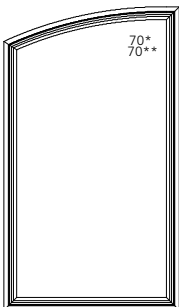

8QP4274-L

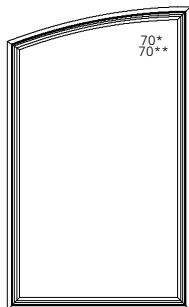

8QP4474-L

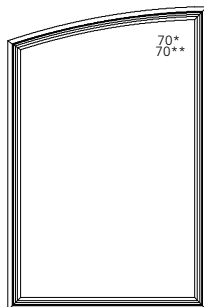

8QP4874-L

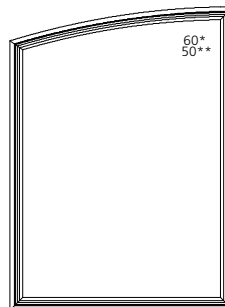

8QP5474-L

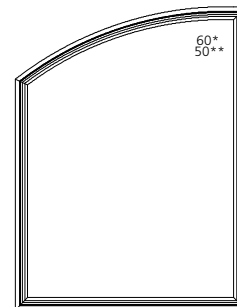

8QP5674-L





































**ELEVATION SYMBOL LEGEND:**

VALUES IN ( ) ARE IN MILLIMETER CONVERSIONS.  
**##\*** NUMBER INDICATES DESIGN PRESSURE (DP) RATING WITH STANDARD GLAZING.  
**##\*\*** NUMBER INDICATES OPTIONAL DESIGN PRESSURE (DP) RATING.

SCALE: 1/4" = 1'



#### EXTENDED QUARTER SEGMENT

UNIT SIZE	61 3/4" (1568)	67 3/4" (1721)	73 3/4" (1873)	75 3/4" (1924)
ROUGH OPENING	60" (1524)	66" (1676)	72" (1829)	74" (1880)
FRAME SIZE	59 1/2" (1511)	65 1/2" (1664)	71 1/2" (1861)	73 1/2" (1867)
DAYLIGHT OPENING	55 5/8" (1413)	61 5/8" (1565)	67 5/8" (1718)	69 5/8" (1768)
13 3/4" (349) 12" (305) 11 1/2" (292) 7 5/8" (194)	 8QP6012-L	 8QP6612-L	 8QP7212-L	 8QP7412-L
19 3/4" (502) 18" (457) 17 1/2" (445) 13 5/8" (346)	 8QP6018-L	 8QP6618-L	 8QP7218-L	 8QP7418-L
25 3/4" (654) 24" (610) 23 1/2" (597) 19 5/8" (498)	 8QP6024-L	 8QP6624-L	 8QP7224-L	 8QP7424-L
31 3/4" (806) 30" (762) 29 1/2" (749) 25 5/8" (651)	 8QP6030-L	 8QP6630-L	 8QP7230-L	 8QP7430-L
37 3/4" (959) 36" (914) 35 1/2" (902) 31 5/8" (803)	 8QP6036-L	 8QP6636-L	 8QP7236-L	 8QP7436-L
39 3/4" (1010) 38" (965) 37 1/2" (953) 33 5/8" (854)	 8QP6038-L	 8QP6638-L	 8QP7238-L	 8QP7438-L
43 3/4" (1111) 42" (1067) 41 1/2" (1054) 37 5/8" (956)	 8QP6042-L	 8QP6642-L	 8QP7242-L	 8QP7442-L
45 3/4" (1162) 44" (1118) 43 1/2" (1105) 39 5/8" (1006)	 8QP6044-L	 8QP6644-L	 8QP7244-L	 8QP7444-L
49 3/4" (1264) 48" (1219) 47 1/2" (1207) 43 5/8" (1108)	 8QP6048-L	 8QP6648-L	 8QP7248-L	 8QP7448-L

**ELEVATION SYMBOL LEGEND:**  
 VALUES IN () ARE IN MILLIMETER CONVERSIONS.  
 ##\* NUMBER INDICATES DESIGN PRESSURE (DP) RATING WITH STANDARD GLAZING.  
 ###\* NUMBER INDICATES OPTIONAL DESIGN PRESSURE (DP) RATING.

SCALE: 1/4" = 1'

**EXTENDED QUARTER SEGMENT**

**UNIT SIZE**  
**ROUGH OPENING**  
**FRAME SIZE**  
**DAYLIGHT OPENING**

61 3/4"(1568)  
60"(1524)  
59 1/2"(1511)  
55 5/8"(1413)

67 3/4"(1721)  
66"(1676)  
65 1/2"(1664)  
61 5/8"(1565)

73 3/4"(1873)  
72"(1829)  
71 1/2"(1861)  
67 5/8"(1718)

75 3/4"(1924)  
74"(1880)  
73 1/2"(1867)  
69 5/8"(1768)

53 3/4"(1365)  
52"(1321)  
51 1/2"(1308)  
47 5/8"(1210)

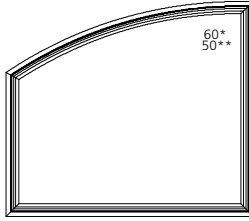

8QP6052-L

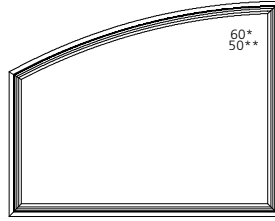

8QP6652-L

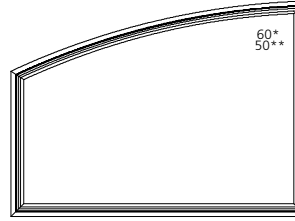

8QP7252-L

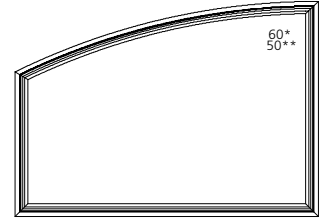

8QP7452-L

55 3/4"(1416)  
54"(1372)  
53 1/2"(1359)  
49 5/8"(1260)

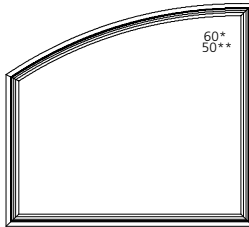

8QP6054-L

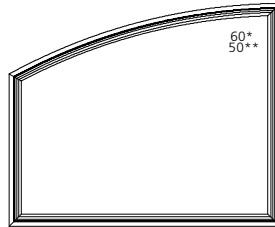

8QP6654-L

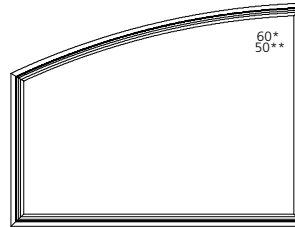

8QP7254-L

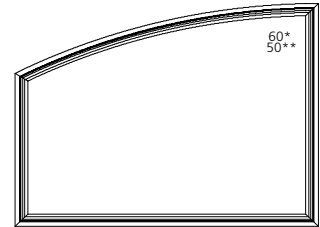

8QP7454-L

61 3/4"(1568)  
60"(1524)  
59 1/2"(1511)  
55 5/8"(1413)

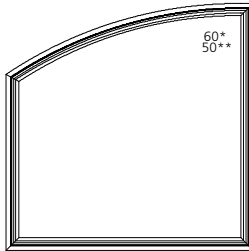

8QP6060-L

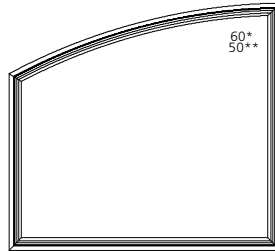

8QP6660-L

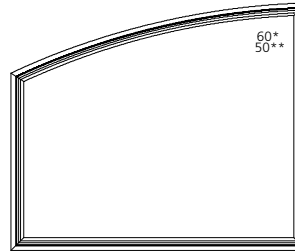

8QP7260-L

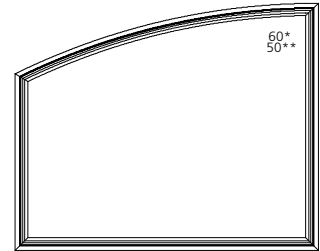

8QP7460-L

63 3/4"(1619)  
62"(1575)  
61 1/2"(1562)  
57 5/8"(1464)

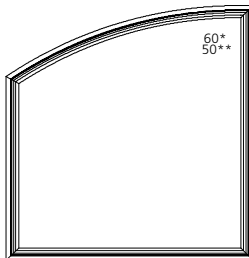

8QP6062-L

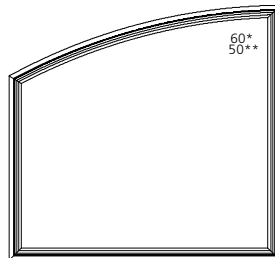

8QP6662-L

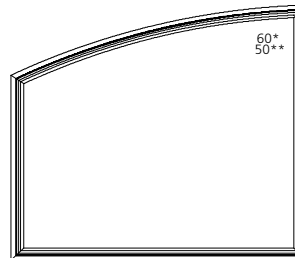

8QP7262-L

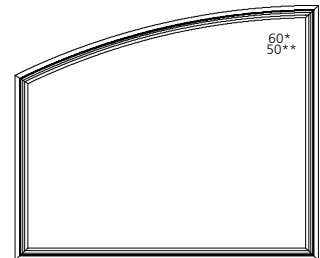

8QP7462-L

67 3/4"(1721)  
66"(1676)  
65 1/2"(1664)  
61 5/8"(1565)

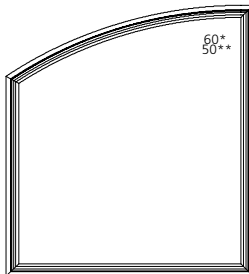

8QP6066-L

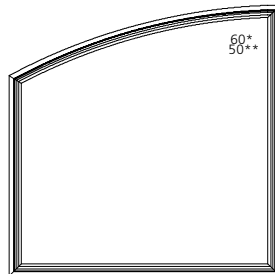

8QP6666-L

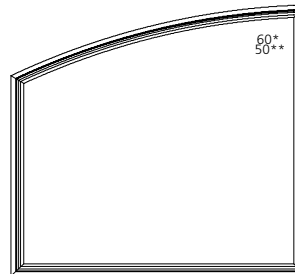

8QP7266-L

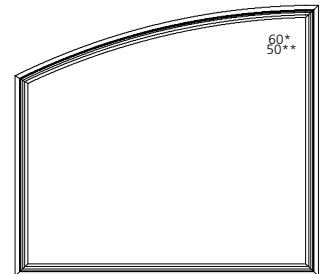

8QP7466-L

**ELEVATION SYMBOL LEGEND:**

VALUES IN () ARE IN MILLIMETER CONVERSIONS.  
##\* NUMBER INDICATES DESIGN PRESSURE (DP) RATING WITH STANDARD GLAZING.  
##\*\* NUMBER INDICATES OPTIONAL DESIGN PRESSURE (DP) RATING.

SCALE: 1/4" = 1'

**EXTENDED QUARTER SEGMENT**

UNIT SIZE  
ROUGH OPENING  
FRAME SIZE  
DAYLIGHT OPENING

61 3/4"(1568)  
60"(1524)  
59 1/2"(1511)  
55 5/8"(1413)

67 3/4"(1721)  
66"(1676)  
65 1/2"(1664)  
61 5/8"(1565)

73 3/4"(1873)  
72"(1829)  
71 1/2"(1861)  
67 5/8"(1718)

75 3/4"(1924)  
74"(1880)  
73 1/2"(1867)  
69 5/8"(1768)

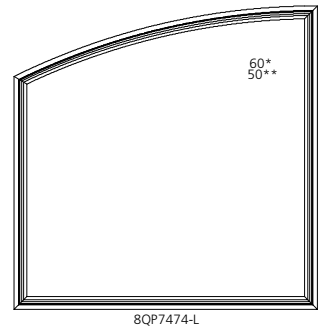
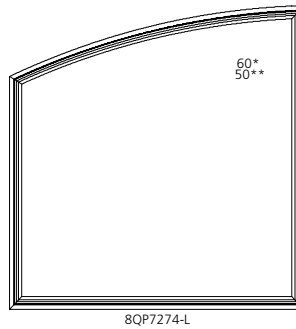
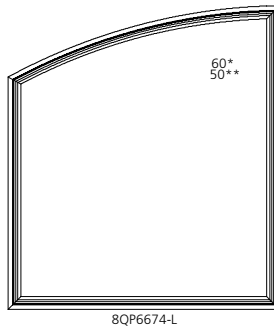
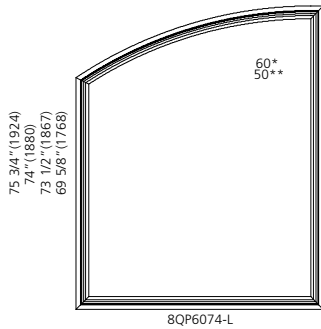
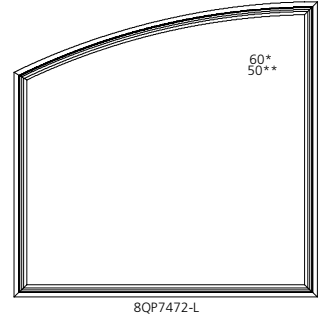
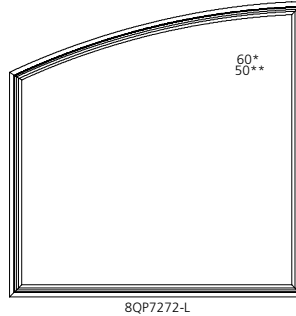
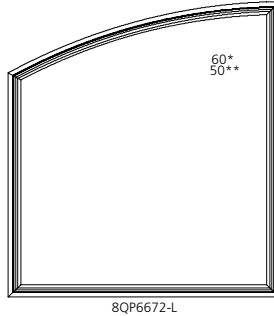
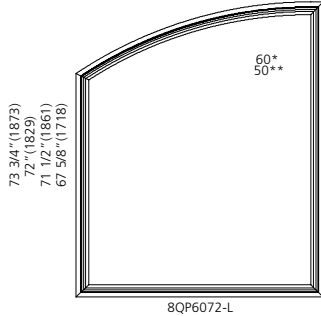

**ELEVATION SYMBOL LEGEND:**

VALUES IN ( ) ARE IN MILLIMETER CONVERSIONS.  
##\* NUMBER INDICATES DESIGN PRESSURE (DP) RATING WITH STANDARD GLAZING.  
###\* NUMBER INDICATES OPTIONAL DESIGN PRESSURE (DP) RATING.

SCALE: 1/4" = 1'

#### EXTENDED CIRCLE SEGMENT

UNIT SIZE	13 3/4" (349)	19 3/4" (502)	25 3/4" (654)	29 3/4" (756)	31 3/4" (806)	33 3/4" (857)	37 3/4" (959)	41 3/4" (1060)
ROUGH OPENING	12" (305)	18" (457)	24" (610)	28" (711)	30" (762)	32" (813)	36" (914)	40" (1016)
FRAME SIZE	11 1/2" (292)	17 1/2" (445)	23 1/2" (597)	27 1/2" (699)	29 1/2" (749)	31 1/2" (800)	35 1/2" (902)	39 1/2" (1003)
DAYLIGHT OPENING	7 5/8" (194)	13 5/8" (346)	19 5/8" (498)	23 5/8" (600)	25 5/8" (651)	27 5/8" (702)	31 5/8" (803)	35 5/8" (905)
19 3/4" (502) 18" (457) 17 1/2" (445) 13 5/8" (346)								
25 3/4" (654) 24" (610) 23 1/2" (597) 19 5/8" (498)								
31 3/4" (806) 30" (762) 29 1/2" (749) 25 5/8" (651)								
37 3/4" (959) 36" (914) 35 1/2" (902) 31 5/8" (803)								
39 3/4" (1010) 38" (965) 37 1/2" (953) 33 5/8" (854)								
43 3/4" (1111) 42" (1067) 41 1/2" (1054) 37 5/8" (956)								
45 3/4" (1162) 44" (1118) 43 1/2" (1105) 39 5/8" (1006)								
49 3/4" (1264) 48" (1219) 47 1/2" (1207) 43 5/8" (1108)								

**ELEVATION SYMBOL LEGEND:**  
 VALUES IN ( ) ARE IN MILLIMETER CONVERSIONS.  
 ###\* NUMBER INDICATES DESIGN PRESSURE (DP) RATING WITH STANDARD GLAZING.  
 ###\*\* NUMBER INDICATES OPTIONAL DESIGN PRESSURE (DP) RATING.

SCALE: 1/4" = 1'

#### EXTENDED CIRCLE SEGMENT

UNIT SIZE	13 3/4" (349)	19 3/4" (502)	25 3/4" (654)	29 3/4" (756)	31 3/4" (806)	33 3/4" (857)	37 3/4" (959)	41 3/4" (1060)
ROUGH OPENING	12" (305)	18" (457)	24" (610)	28" (711)	30" (762)	32" (813)	36" (914)	40" (1016)
FRAME SIZE	11 1/2" (292)	17 1/2" (445)	23 1/2" (597)	27 1/2" (699)	29 1/2" (749)	31 1/2" (800)	35 1/2" (902)	39 1/2" (1003)
DAYLIGHT OPENING	7 5/8" (194)	13 5/8" (346)	19 5/8" (498)	23 5/8" (600)	25 5/8" (651)	27 5/8" (702)	31 5/8" (803)	35 5/8" (905)
53 3/4" (1365) 52" (1321) 51 1/2" (1308) 47 5/8" (1210)								
55 3/4" (1416) 54" (1372) 53 1/2" (1359) 49 5/8" (1260)								
61 3/4" (1568) 60" (1524) 59 1/2" (1511) 55 5/8" (1413)								
63 3/4" (1619) 62" (1575) 61 1/2" (1562) 57 5/8" (1464)								
67 3/4" (1721) 66" (1676) 65 1/2" (1664) 61 5/8" (1565)								

**ELEVATION SYMBOL LEGEND:**  
 VALUES IN Ø ARE IN MILLIMETER CONVERSIONS.  
 ##\* NUMBER INDICATES DESIGN PRESSURE (DP) RATING WITH STANDARD GLAZING.  
 ###\* NUMBER INDICATES OPTIONAL DESIGN PRESSURE (DP) RATING.

SCALE: 1/4" = 1'

#### EXTENDED CIRCLE SEGMENT

UNIT SIZE	13 3/4" (349)	19 3/4" (502)	25 3/4" (654)	29 3/4" (756)	31 3/4" (806)	33 3/4" (857)	37 3/4" (959)	41 3/4" (1060)
ROUGH OPENING	12" (305)	18" (457)	24" (610)	28" (711)	30" (762)	32" (813)	36" (914)	40" (1016)
FRAME SIZE	11 1/2" (292)	17 1/2" (445)	23 1/2" (597)	27 1/2" (699)	29 1/2" (749)	31 1/2" (800)	35 1/2" (902)	39 1/2" (1003)
DAYLIGHT OPENING	7 5/8" (194)	13 5/8" (346)	19 5/8" (498)	23 5/8" (600)	25 5/8" (651)	27 5/8" (702)	31 5/8" (803)	35 5/8" (905)

73 3/4" (1873)		70*	8LP1272
		70**	
		70***	
72" (1829)		70*	8LP1872
		70**	
		70***	
71 1/2" (1861)		70*	8LP2472
		70**	
		70***	
67 5/8" (1718)		70*	8LP2872
		70**	
		70***	
73 3/4" (1873)		70*	8LP3072
		70**	
		70***	
72" (1829)		70*	8LP3272
		70**	
		70***	
71 1/2" (1861)		70*	8LP3672
		70**	
		70***	
67 5/8" (1718)		70*	8LP4072
		70**	
		70***	
75 3/4" (1924)		70*	8LP1274
		70**	
		70***	
74" (1880)		70*	8LP1874
		70**	
		70***	
73 1/2" (1867)		70*	8LP2474
		70**	
		70***	
69 5/8" (1768)		70*	8LP2874
		70**	
		70***	
73 3/4" (1873)		70*	8LP3074
		70**	
		70***	
72" (1829)		70*	8LP3274
		70**	
		70***	
71 1/2" (1861)		70*	8LP3674
		70**	
		70***	
67 5/8" (1718)		70*	8LP4074
		70**	
		70***	

**ELEVATION SYMBOL LEGEND:**  
 VALUES IN ( ) ARE IN MILLIMETER CONVERSIONS.  
 \*\*\* NUMBER INDICATES DESIGN PRESSURE (DP) RATING WITH STANDARD GLAZING.  
 \*\*\*\* NUMBER INDICATES OPTIONAL DESIGN PRESSURE (DP) RATING.

SCALE: 1/4" = 1'

#### EXTENDED CIRCLE SEGMENT

UNIT SIZE	43 3/4" (1111)	45 3/4" (1162)	49 3/4" (1264)	55 3/4" (1416)	57 3/4" (1467)
ROUGH OPENING	42" (1067)	44" (1118)	48" (1219)	54" (1372)	56" (1422)
FRAME SIZE	41 1/2" (1054)	43 1/2" (1105)	47 1/2" (1207)	53 1/2" (1359)	55 1/2" (1410)
DAYLIGHT OPENING	37 5/8" (956)	39 5/8" (1006)	43 5/8" (1108)	49 5/8" (1260)	51 5/8" (1311)
19 3/4" (502) 18" (457) 17 1/2" (445) 13 5/8" (346)					
25 3/4" (654) 24" (610) 23 1/2" (597) 19 5/8" (498)					
31 3/4" (806) 30" (762) 29 1/2" (749) 25 5/8" (651)					
37 3/4" (959) 36" (914) 35 1/2" (902) 31 5/8" (803)					
39 3/4" (1010) 38" (965) 37 1/2" (953) 33 5/8" (854)					
43 3/4" (1111) 42" (1067) 41 1/2" (1054) 37 5/8" (956)					
45 3/4" (1162) 44" (1118) 43 1/2" (1105) 39 5/8" (1006)					
49 3/4" (1264) 48" (1219) 47 1/2" (1207) 43 5/8" (1108)					

**ELEVATION SYMBOL LEGEND:**  
 VALUES IN ( ) ARE IN MILLIMETER CONVERSIONS.  
 ##\* NUMBER INDICATES DESIGN PRESSURE (DP) RATING WITH STANDARD GLAZING.  
 ###\* NUMBER INDICATES OPTIONAL DESIGN PRESSURE (DP) RATING.

SCALE: 1/4" = 1'

#### EXTENDED CIRCLE SEGMENT

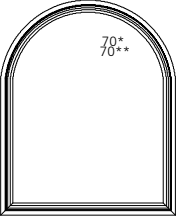
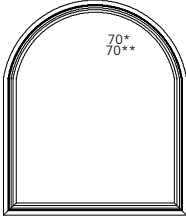
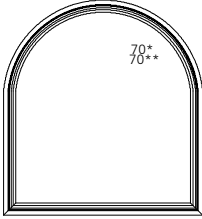
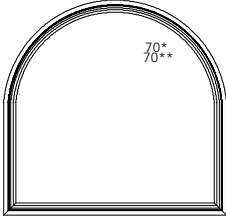
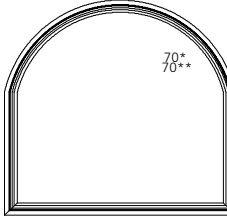
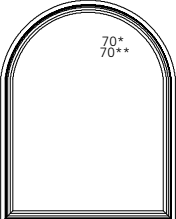
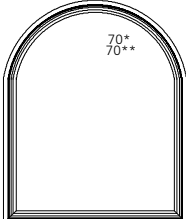
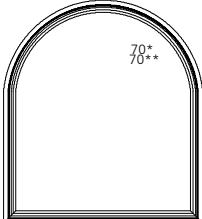
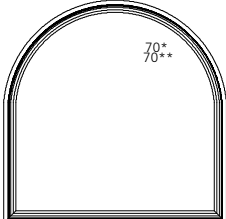
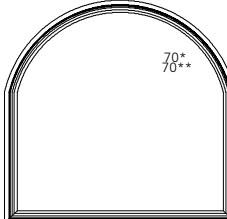
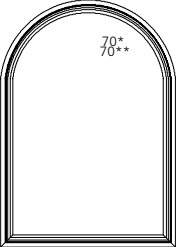
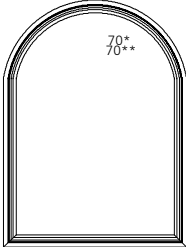
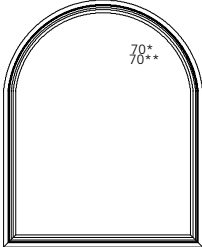
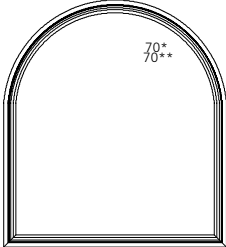
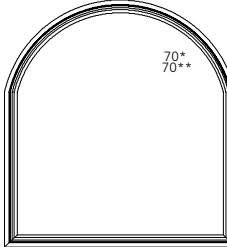
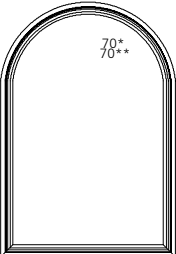
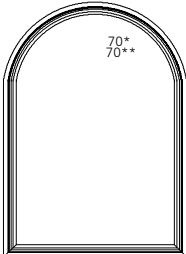
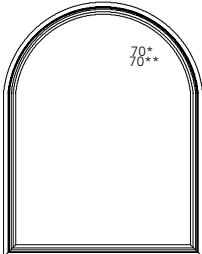
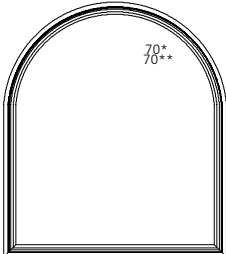
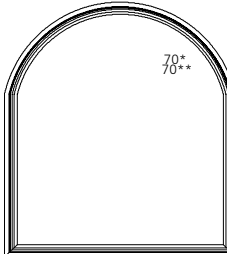
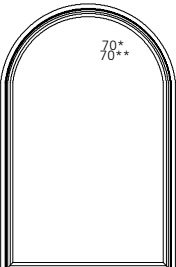
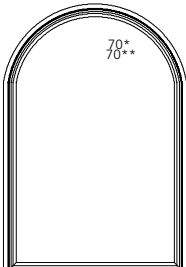
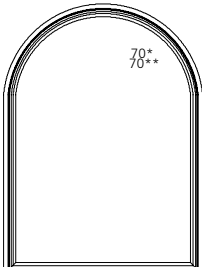
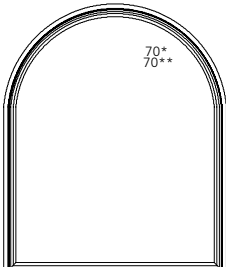
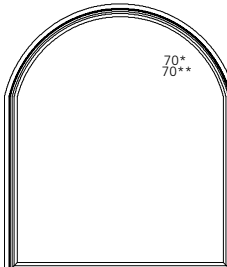
UNIT SIZE	43 3/4" (1111)	45 3/4" (1162)	49 3/4" (1264)	55 3/4" (1416)	57 3/4" (1467)
ROUGH OPENING	42" (1067)	44" (1118)	48" (1219)	54" (1372)	56" (1422)
FRAME SIZE	41 1/2" (1054)	43 1/2" (1105)	47 1/2" (1207)	53 1/2" (1359)	55 1/2" (1410)
DAYLIGHT OPENING	37 5/8" (956)	39 5/8" (1006)	43 5/8" (1108)	49 5/8" (1260)	51 5/8" (1311)
53 3/4" (1365) 52" (1321) 51 1/2" (1308) 47 5/8" (1210)	 8LP4252	 8LP4452	 8LP4852	 8LP5452	 8LP5652
55 3/4" (1416) 54" (1372) 53 1/2" (1359) 49 5/8" (1260)	 8LP4254	 8LP4454	 8LP4854	 8LP5454	 8LP5654
61 3/4" (1568) 60" (1524) 59 1/2" (1511) 55 5/8" (1413)	 8LP4260	 8LP4460	 8LP4860	 8LP5460	 8LP5660
63 3/4" (1619) 62" (1575) 61 1/2" (1562) 57 5/8" (1464)	 8LP4262	 8LP4462	 8LP4862	 8LP5462	 8LP5662
67 3/4" (1721) 66" (1676) 65 1/2" (1664) 61 5/8" (1565)	 8LP4266	 8LP4466	 8LP4866	 8LP5466	 8LP5666

**ELEVATION SYMBOL LEGEND:**  
 VALUES IN ( ) ARE IN MILLIMETER CONVERSIONS.  
 ##\* NUMBER INDICATES DESIGN PRESSURE (DP) RATING WITH STANDARD GLAZING.  
 ###\* NUMBER INDICATES OPTIONAL DESIGN PRESSURE (DP) RATING.

SCALE: 1/4" = 1'



**EXTENDED CIRCLE SEGMENT**

**UNIT SIZE**  
**ROUGH OPENING**  
**FRAME SIZE**  
**DAYLIGHT OPENING**

43 3/4" (1111)  
42" (1067)  
41 1/2" (1054)  
37 5/8" (956)

45 3/4" (1162)  
44" (1118)  
43 1/2" (1105)  
39 5/8" (1006)

49 3/4" (1264)  
48" (1219)  
47 1/2" (1207)  
43 5/8" (1108)

55 3/4" (1416)  
54" (1372)  
53 1/2" (1359)  
49 5/8" (1260)

57 3/4" (1467)  
56" (1422)  
55 1/2" (1410)  
51 5/8" (1311)

73 3/4" (1873)  
71" (1829)  
71" (1829)  
67 5/8" (1718)

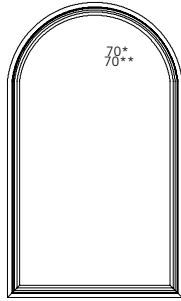

8LP4272

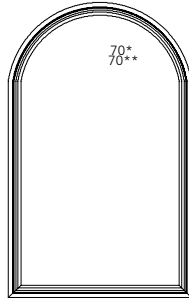

8LP4472

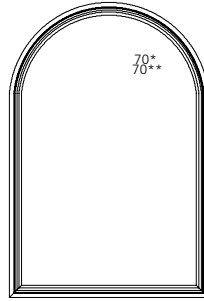

8LP4872

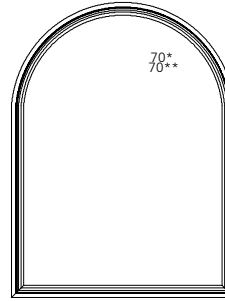

8LP5472

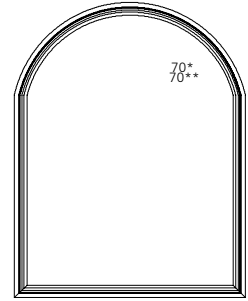

8LP5672

75 3/4" (1924)  
74" (1880)  
73 1/2" (1867)  
69 5/8" (1768)

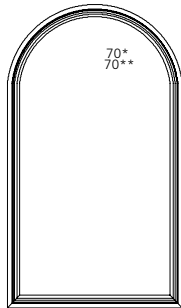

8LP4274

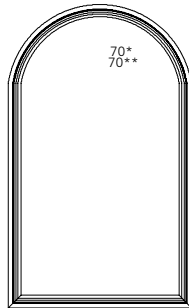

8LP4474

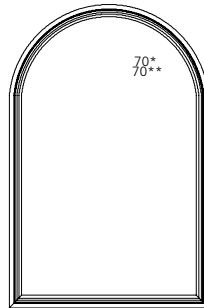

8LP4874

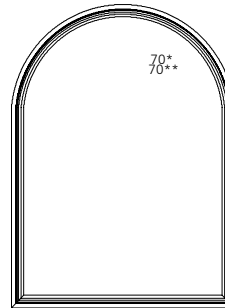

8LP5474

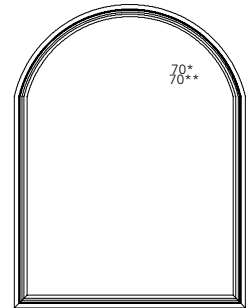

8LP5674

**ELEVATION SYMBOL LEGEND:**

VALUES IN () ARE IN MILLIMETER CONVERSIONS.  
### NUMBER INDICATES DESIGN PRESSURE (DP) RATING WITH STANDARD GLAZING.  
###\* NUMBER INDICATES OPTIONAL DESIGN PRESSURE (DP) RATING.

SCALE: 1/4" = 1'

#### EXTENDED CIRCLE SEGMENT

**UNIT SIZE**  
**ROUGH OPENING**  
**FRAME SIZE**  
**DAYLIGHT OPENING**

61 3/4"(1568)  
60"(1524)  
59 1/2"(1511)  
55 5/8"(1413)

67 3/4"(1721)  
66"(1676)  
65 1/2"(1664)  
61 5/8"(1565)

73 3/4"(1873)  
72"(1829)  
71 1/2"(1861)  
67 5/8"(1718)

75 3/4"(1924)  
74"(1880)  
73 1/2"(1867)  
69 5/8"(1768)

19 3/4"(502)  
18"(457)  
17 1/2"(445)  
13 5/8"(346)



8LP6018



8LP6618



8LP7218



8LP7418

25 3/4"(654)  
24"(610)  
23 1/2"(597)  
19 5/8"(498)



8LP6024



8LP6624



8LP7224



8LP7424

31 3/4"(806)  
30"(762)  
29 1/2"(749)  
25 5/8"(651)

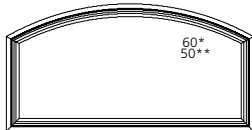

8LP6030

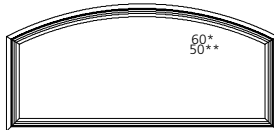

8LP6630

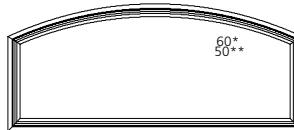

8LP7230

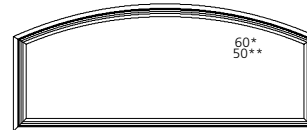

8LP7430

37 3/4"(959)  
36"(914)  
35 1/2"(902)  
31 5/8"(803)

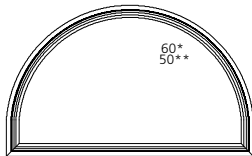

8LP6036

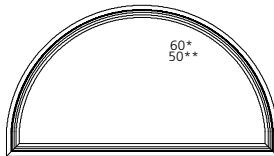

8LP6636

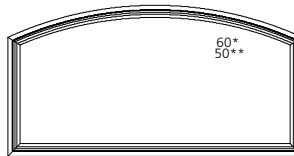

8LP7236

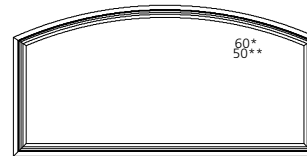

8LP7436

39 3/4"(1010)  
38"(965)  
37 1/2"(953)  
33 5/8"(854)

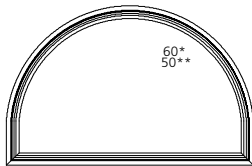

8LP6038

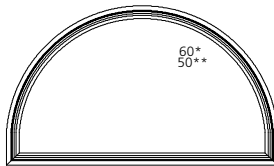

8LP6638

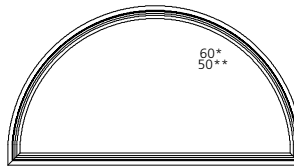

8LP7238

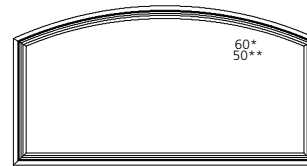

8LP7438

43 3/4"(1111)  
42"(1067)  
41 1/2"(1054)  
37 5/8"(956)

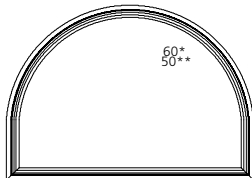

8LP6042

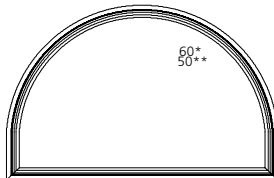

8LP6642

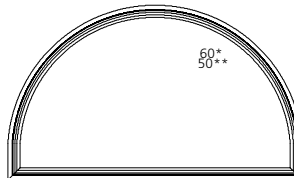

8LP7242

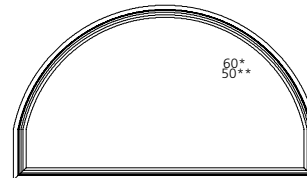

8LP7442

45 3/4"(1162)  
44"(1118)  
43 1/2"(1105)  
39 5/8"(1006)

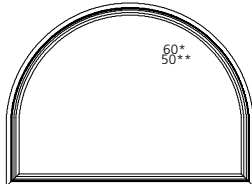

8LP6044

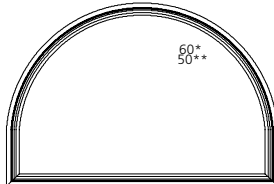

8LP6644

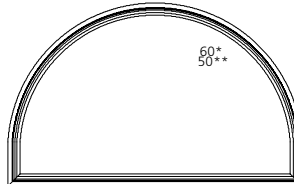

8LP7244

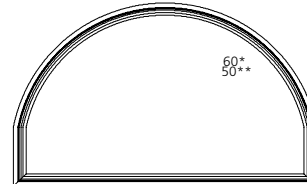

8LP7444

49 3/4"(1264)  
48"(1219)  
47 1/2"(1207)  
43 5/8"(1108)

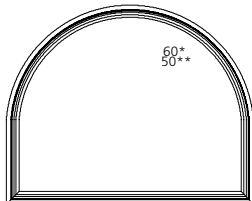

8LP6048

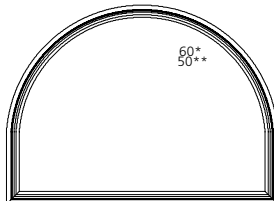

8LP6648

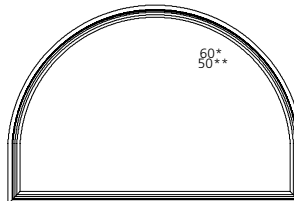

8LP7248

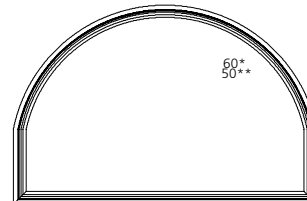

8LP7448

**ELEVATION SYMBOL LEGEND:**

VALUES IN () ARE IN MILLIMETER CONVERSIONS.  
##\* NUMBER INDICATES DESIGN PRESSURE (DP) RATING WITH STANDARD GLAZING.  
###\* NUMBER INDICATES OPTIONAL DESIGN PRESSURE (DP) RATING.

SCALE: 1/4" = 1'

#### EXTENDED CIRCLE SEGMENT

UNIT SIZE  
ROUGH OPENING  
FRAME SIZE  
DAYLIGHT OPENING

61 3/4" (1568)  
60" (1524)  
59 1/2" (1511)  
55 5/8" (1413)

67 3/4" (1721)  
66" (1676)  
65 1/2" (1664)  
61 5/8" (1565)

73 3/4" (1873)  
72" (1829)  
71 1/2" (1861)  
67 5/8" (1718)

75 3/4" (1924)  
74" (1880)  
73 1/2" (1867)  
69 5/8" (1768)

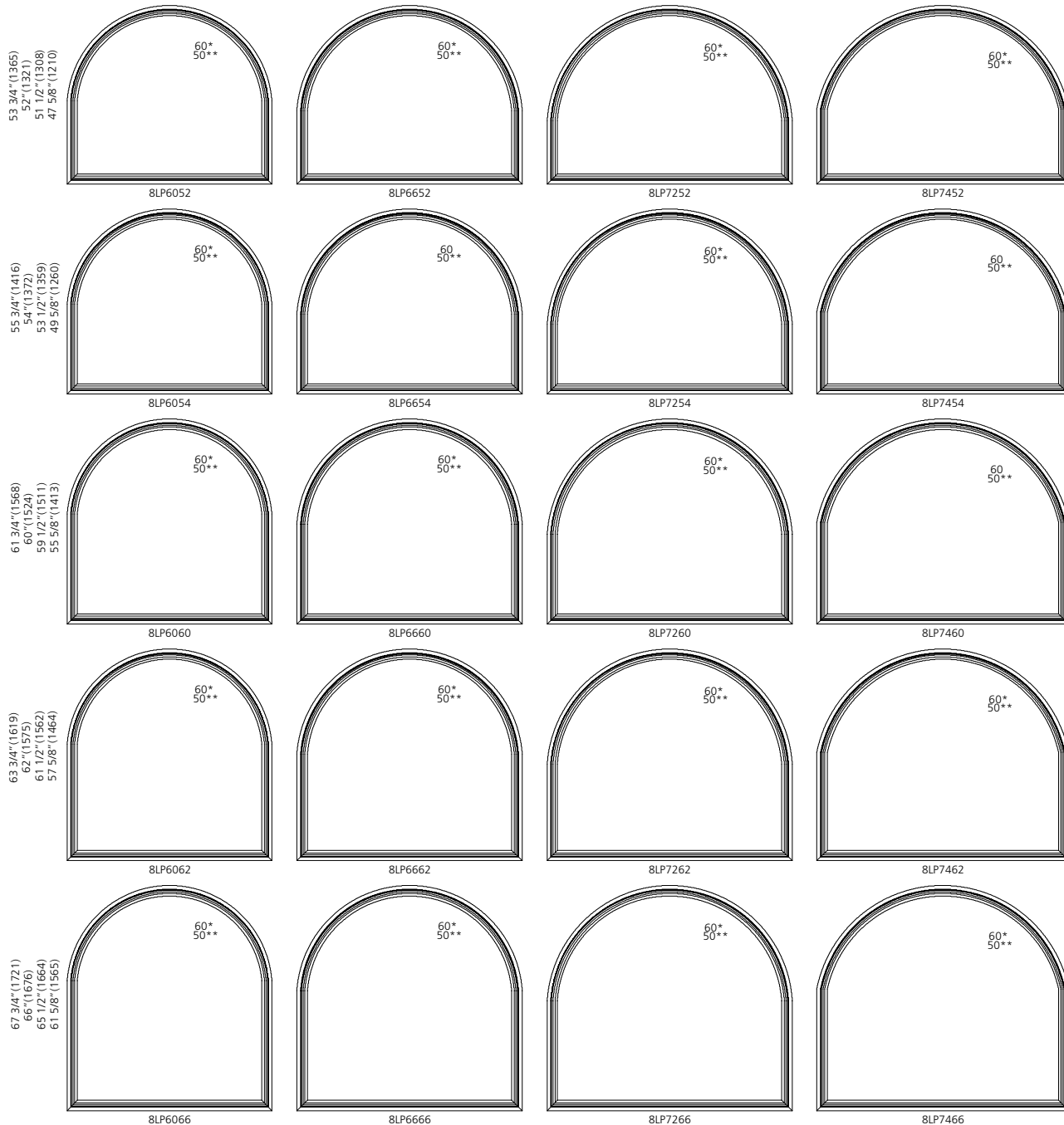

**ELEVATION SYMBOL LEGEND:**

VALUES IN ( ) ARE IN MILLIMETER CONVERSIONS.  
 \*\*\* NUMBER INDICATES DESIGN PRESSURE (DP) RATING WITH STANDARD GLAZING.  
 \*\*\*\* NUMBER INDICATES OPTIONAL DESIGN PRESSURE (DP) RATING.

SCALE: 1/4" = 1'

**EXTENDED CIRCLE SEGMENT**

**UNIT SIZE**  
**ROUGH OPENING**  
**FRAME SIZE**  
**DAYLIGHT OPENING**

61 3/4" (1568)  
60" (1524)  
59 1/2" (1511)  
55 5/8" (1413)

67 3/4" (1721)  
66" (1676)  
65 1/2" (1664)  
61 5/8" (1565)

73 3/4" (1873)  
72" (1829)  
71 1/2" (1861)  
67 5/8" (1718)

75 3/4" (1924)  
74" (1880)  
73 1/2" (1867)  
69 5/8" (1768)

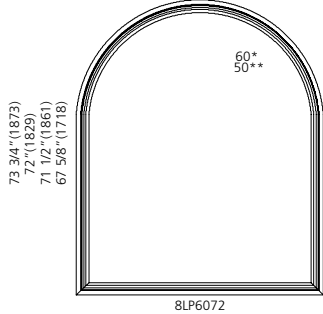

8LP6072

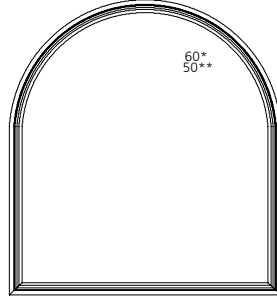

8LP6672

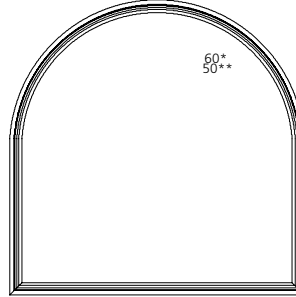

8LP7272

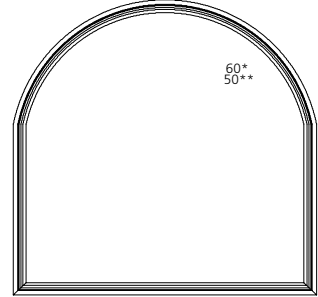

8LP7472

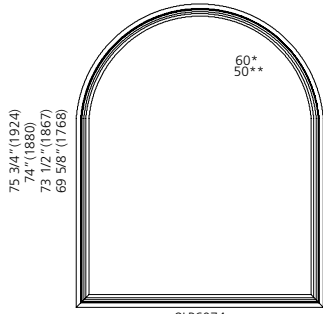

8LP6074

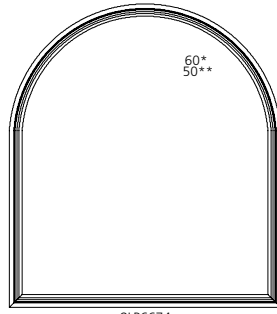

8LP6674

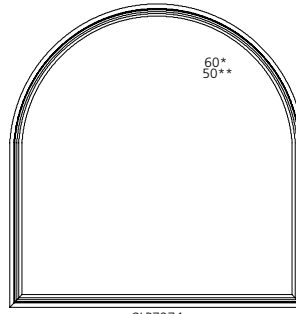

8LP7274

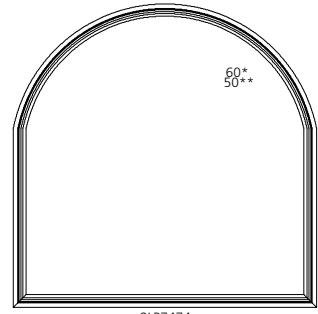

8LP7474

**ELEVATION SYMBOL LEGEND:**

VALUES IN ( ) ARE IN MILLIMETER CONVERSIONS.

##\* NUMBER INDICATES DESIGN PRESSURE (DP) RATING WITH STANDARD GLAZING.

###\* NUMBER INDICATES OPTIONAL DESIGN PRESSURE (DP) RATING.

SCALE: 1/4" = 1'











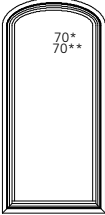

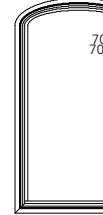
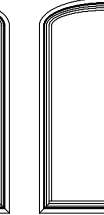
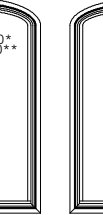
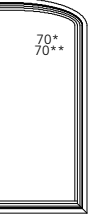

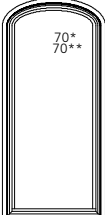
#### ELLIPSE TOP WINDOWS

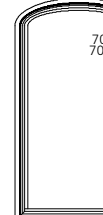
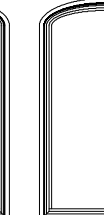
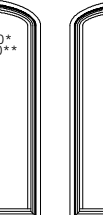
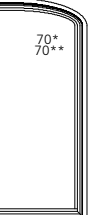
UNIT SIZE	25 3/4" (654)	29 3/4" (756)	31 3/4" (806)	33 3/4" (857)	37 3/4" (959)	41 3/4" (1060)	43 3/4" (1111)
ROUGH OPENING	24" (610)	28" (711)	30" (762)	32" (813)	36" (914)	40" (1016)	42" (1067)
FRAME SIZE	23 1/2" (597)	27 1/2" (699)	29 1/2" (749)	31 1/2" (800)	35 1/2" (902)	39 1/2" (1003)	41 1/2" (1054)
DAYLIGHT OPENING	19 5/8" (498)	23 5/8" (600)	25 5/8" (651)	27 5/8" (702)	31 5/8" (803)	35 5/8" (905)	37 5/8" (956)
13 3/4" (949) 12" (305) 11 1/2" (292) 7 5/8" (194)							
19 3/4" (502) 18" (457) 17 1/2" (445) 13 5/8" (346)							
25 3/4" (654) 24" (610) 23 1/2" (597) 19 5/8" (498)							
31 3/4" (806) 30" (762) 29 1/2" (749) 25 5/8" (651)							
37 3/4" (959) 36" (914) 35 1/2" (902) 31 5/8" (803)							
39 3/4" (1010) 38" (965) 37 1/2" (953) 33 5/8" (854)							
43 3/4" (1111) 42" (1067) 41 1/2" (1054) 37 5/8" (956)							
45 3/4" (1162) 44" (1118) 43 1/2" (1105) 39 5/8" (1006)							
49 3/4" (1264) 48" (1219) 47 1/2" (1207) 43 5/8" (1108)							

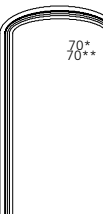
**ELEVATION SYMBOL LEGEND:**  
 VALUES IN ( ) ARE IN MILLIMETER CONVERSIONS.  
 ##\* NUMBER INDICATES DESIGN PRESSURE (DP) RATING WITH STANDARD GLAZING.  
 ###\* NUMBER INDICATES OPTIONAL DESIGN PRESSURE (DP) RATING.

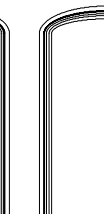
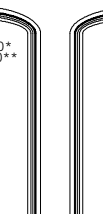
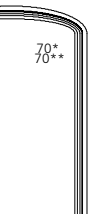
SCALE: 1/4" = 1'

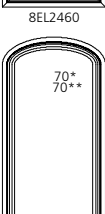
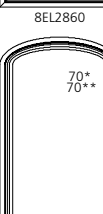
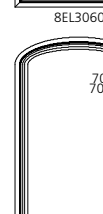
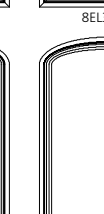
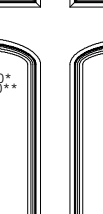
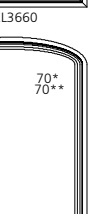
#### ELLIPSE TOP WINDOWS

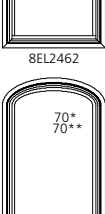
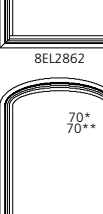
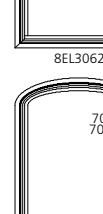
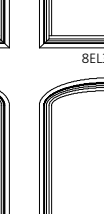
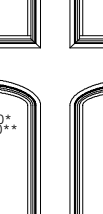
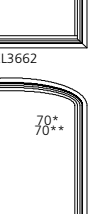
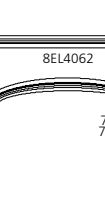
	25 3/4" (654)	29 3/4" (756)	31 3/4" (806)	33 3/4" (857)	37 3/4" (959)	41 3/4" (1060)	43 3/4" (1111)
UNIT SIZE	24" (610)	28" (711)	30" (762)	32" (813)	36" (914)	40" (1016)	42" (1067)
ROUGH OPENING	23 1/2" (597)	27 1/2" (699)	29 1/2" (749)	31 1/2" (800)	35 1/2" (902)	39 1/2" (1003)	41 1/2" (1054)
FRAME SIZE	19 5/8" (498)	23 5/8" (600)	25 5/8" (651)	27 5/8" (702)	31 5/8" (803)	35 5/8" (905)	37 5/8" (956)
DAYLIGHT OPENING							
53 3/4" (1365) 52" (1321) 51 1/2" (1308) 47 5/8" (1210)							
55 3/4" (1416) 54" (1372) 53 1/2" (1359) 49 5/8" (1260)							
61 3/4" (1568) 60" (1524) 59 1/2" (1511) 55 5/8" (1413)							
63 3/4" (1619) 62" (1575) 61 1/2" (1562) 57 5/8" (1464)							
67 3/4" (1721) 66" (1676) 65 1/2" (1664) 61 5/8" (1565)							

**ELEVATION SYMBOL LEGEND:**  
 VALUES IN ( ) ARE IN MILLIMETER CONVERSIONS.  
 ### NUMBER INDICATES DESIGN PRESSURE (DP) RATING WITH STANDARD GLAZING.  
 ###\* NUMBER INDICATES OPTIONAL DESIGN PRESSURE (DP) RATING.

SCALE: 1/4" = 1'

#### ELLIPSE TOP WINDOWS

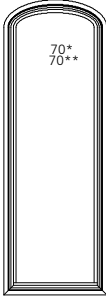
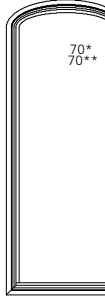
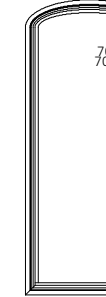
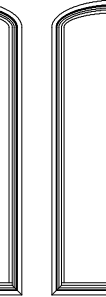
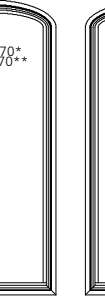
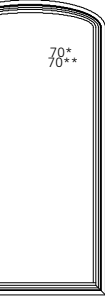
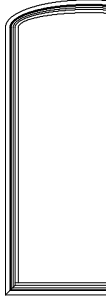
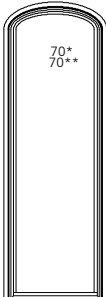
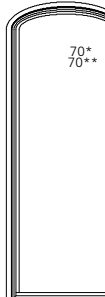
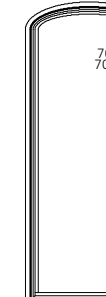
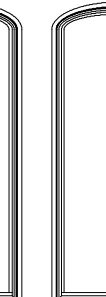
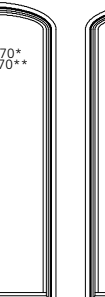
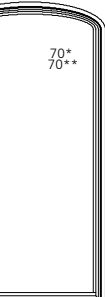
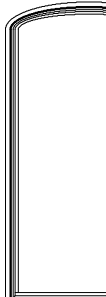
UNIT SIZE	25 3/4" (654)	29 3/4" (756)	31 3/4" (806)	33 3/4" (857)	37 3/4" (959)	41 3/4" (1060)	43 3/4" (1111)	
ROUGH OPENING	24" (610)	28" (711)	30" (762)	32" (813)	36" (914)	40" (1016)	42" (1067)	
FRAME SIZE	23 1/2" (597)	27 1/2" (699)	29 1/2" (749)	31 1/2" (800)	35 1/2" (902)	39 1/2" (1003)	41 1/2" (1054)	
DAYLIGHT OPENING	19 5/8" (498)	23 5/8" (600)	25 5/8" (651)	27 5/8" (702)	31 5/8" (803)	35 5/8" (905)	37 5/8" (956)	
73 3/4" (1873) 72" (1829) 71 1/2" (1861) 67 5/8" (1718)								
	8EL2472	8EL2872	8EL3072	8EL3272	8EL3672	8EL4072	8EL4272	
	75 3/4" (1924) 74" (1880) 73 1/2" (1867) 69 5/8" (1768)							
		8EL2474	8EL2874	8EL3074	8EL3274	8EL3674	8EL4074	8EL4274

**ELEVATION SYMBOL LEGEND:**  
 VALUES IN ( ) ARE IN MILLIMETER CONVERSIONS.  
 ##\* NUMBER INDICATES DESIGN PRESSURE (DP) RATING WITH STANDARD GLAZING.  
 ###\* NUMBER INDICATES OPTIONAL DESIGN PRESSURE (DP) RATING.

SCALE: 1/4" = 1'

#### ELLIPSE TOP WINDOWS

UNIT SIZE	45 3/4" (1162)	49 3/4" (1264)	55 3/4" (1416)	57 3/4" (1467)	61 3/4" (1568)
ROUGH OPENING	44" (1118)	48" (1219)	54" (1372)	56" (1422)	60" (1524)
FRAME SIZE	43 1/2" (1105)	47 1/2" (1207)	53 1/2" (1359)	55 1/2" (1410)	59 1/2" (1511)
DAYLIGHT OPENING	39 5/8" (1006)	43 5/8" (1108)	49 5/8" (1260)	51 5/8" (1311)	55 5/8" (1413)
19 3/4" (502) 18" (457) 17 1/2" (445) 13 5/8" (346)					
25 3/4" (654) 24" (610) 23 1/2" (597) 19 5/8" (498)					
31 3/4" (806) 30" (762) 29 1/2" (749) 25 5/8" (651)					
37 3/4" (959) 36" (914) 35 1/2" (902) 31 5/8" (803)					
39 3/4" (1010) 38" (965) 37 1/2" (953) 33 5/8" (854)					
43 3/4" (1111) 42" (1067) 41 1/2" (1054) 37 5/8" (956)					
45 3/4" (1162) 44" (1118) 43 1/2" (1105) 39 5/8" (1006)					
49 3/4" (1264) 48" (1219) 47 1/2" (1207) 43 5/8" (1108)					
53 3/4" (1365) 52" (1321) 51 1/2" (1308) 47 5/8" (1210)					

**ELEVATION SYMBOL LEGEND:**  
 VALUES IN ( ) ARE IN MILLIMETER CONVERSIONS.  
 \*\* NUMBER INDICATES DESIGN PRESSURE (DP) RATING WITH STANDARD GLAZING.  
 \*\*\* NUMBER INDICATES OPTIONAL DESIGN PRESSURE (DP) RATING.

SCALE: 1/4" = 1'



#### ELLIPSE TOP WINDOWS

	UNIT SIZE	45 3/4" (1162)	49 3/4" (1264)	55 3/4" (1416)	57 3/4" (1467)	61 3/4" (1568)	
	ROUGH OPENING	44" (1118)	48" (1219)	54" (1372)	56" (1422)	60" (1524)	
	FRAME SIZE	43 1/2" (1105)	47 1/2" (1207)	53 1/2" (1359)	55 1/2" (1410)	59 1/2" (1511)	
	DAYLIGHT OPENING	39 5/8" (1006)	43 5/8" (1108)	49 5/8" (1260)	51 5/8" (1311)	55 5/8" (1413)	
55 3/4" (1416) 54" (1372) 53 1/2" (1359) 49 5/8" (1260)							
	8EL4454	8EL4854	8EL5454	8EL5654	8EL6054		
	61 3/4" (1568) 60" (1524) 59 1/2" (1511) 55 5/8" (1413)						
		8EL4460	8EL4860	8EL5460	8EL5660	8EL6060	
		63 3/4" (1619) 62" (1575) 61 1/2" (1562) 57 5/8" (1464)					
8EL4462			8EL4862	8EL5462	8EL5662	8EL6062	
67 3/4" (1721) 66" (1676) 65 1/2" (1664) 61 5/8" (1565)							
	8EL4466		8EL4866	8EL5466	8EL5666	8EL6066	
	73 3/4" (1873) 72" (1829) 71 1/2" (1816) 67 5/8" (1718)						
		8EL4472	8EL4872	8EL5472	8EL5672	8EL6072	

**ELEVATION SYMBOL LEGEND:**  
 VALUES IN () ARE IN MILLIMETER CONVERSIONS.  
 ##\* NUMBER INDICATES DESIGN PRESSURE (DP) RATING WITH STANDARD GLAZING.  
 ###\* NUMBER INDICATES OPTIONAL DESIGN PRESSURE (DP) RATING.

SCALE: 1/4" = 1'

**ELLIPSE TOP WINDOWS**

	45 3/4" (1162)	49 3/4" (1264)	55 3/4" (1416)	57 3/4" (1467)	61 3/4" (1568)
<b>UNIT SIZE</b>	45 3/4" (1162)	49 3/4" (1264)	55 3/4" (1416)	57 3/4" (1467)	61 3/4" (1568)
<b>ROUGH OPENING</b>	44" (1118)	48" (1219)	54" (1372)	56" (1422)	60" (1524)
<b>FRAME SIZE</b>	43 1/2" (1105)	47 1/2" (1207)	53 1/2" (1359)	55 1/2" (1410)	59 1/2" (1511)
<b>DAYLIGHT OPENING</b>	39 5/8" (1006)	43 5/8" (1108)	49 5/8" (1260)	51 5/8" (1311)	55 5/8" (1413)

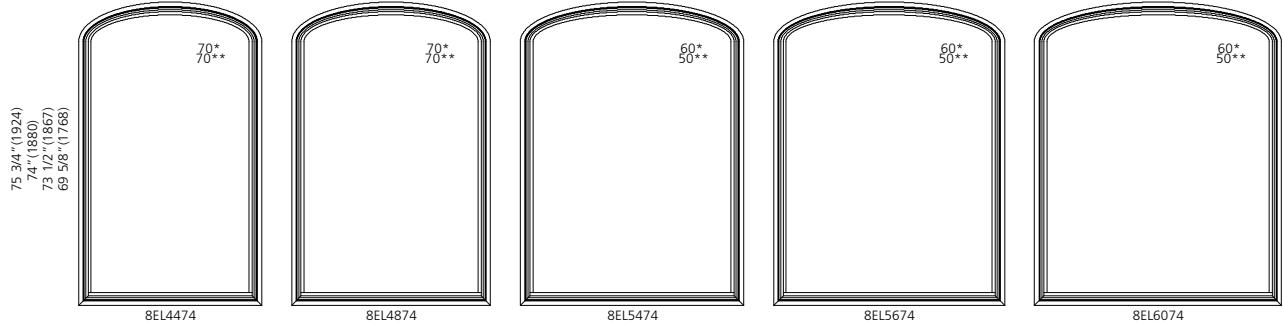

**ELEVATION SYMBOL LEGEND:**  
VALUES IN () ARE IN MILLIMETER CONVERSIONS.  
##\* NUMBER INDICATES DESIGN PRESSURE (DP) RATING WITH STANDARD GLAZING.  
### NUMBER INDICATES OPTIONAL DESIGN PRESSURE (DP) RATING.

### ELLIPSE TOP WINDOWS

UNIT SIZE  
ROUGH OPENING  
FRAME SIZE  
DAYLIGHT OPENING

25 3/4" (654) 24" (610) 23 1/2" (597) 19 5/8" (498)	67 3/4" (1721) 66" (1676) 65 1/2" (1664) 61 5/8" (1565)	73 3/4" (1873) 72" (1829) 71 1/2" (1861) 67 5/8" (1718)	75 3/4" (1924) 74" (1880) 73 1/2" (1867) 69 5/8" (1768)
	60* 50**	60* 50**	60* 50**
	8EL6624	8EL7224	8EL7424
31 3/4" (806) 30" (762) 29 1/2" (749) 25 5/8" (651)	60* 50**	60* 50**	60* 50**
	8EL6630	8EL7230	8EL7430
37 3/4" (959) 36" (914) 35 1/2" (902) 31 5/8" (803)	60* 50**	60* 50**	60* 50**
	8EL6636	8EL7236	8EL7436
39 3/4" (1010) 38" (965) 37 1/2" (953) 33 5/8" (854)	60* 50**	60* 50**	60* 50**
	8EL6638	8EL7238	8EL7438
43 3/4" (1111) 42" (1067) 41 1/2" (1054) 37 5/8" (956)	60* 50**	60* 50**	60* 50**
	8EL6642	8EL7242	8EL7442
45 3/4" (1162) 44" (1118) 43 1/2" (1105) 39 5/8" (1006)	60* 50**	60* 50**	60* 50**
	8EL6644	8EL7244	8EL7444
49 3/4" (1264) 48" (1219) 47 1/2" (1207) 43 5/8" (1108)	60* 50**	60* 50**	60* 50**
	8EL6648	8EL7248	8EL7448
53 3/4" (1365) 52" (1321) 51 1/2" (1308) 47 5/8" (1210)	60* 50**	60* 50**	60* 50**
	8EL6652	8EL7252	8EL7452

**ELEVATION SYMBOL LEGEND:**

VALUES IN ( ) ARE IN MILLIMETER CONVERSIONS.  
 ##\* NUMBER INDICATES DESIGN PRESSURE (DP) RATING WITH STANDARD GLAZING.  
 ##\*\* NUMBER INDICATES OPTIONAL DESIGN PRESSURE (DP) RATING.

SCALE: 1/4" = 1'

#### ELLIPSE TOP WINDOWS

UNIT SIZE  
ROUGH OPENING  
FRAME SIZE  
DAYLIGHT OPENING

67 3/4" (1721)  
66" (1676)  
65 1/2" (1664)  
61 5/8" (1565)

73 3/4" (1873)  
72" (1829)  
71 1/2" (1861)  
67 5/8" (1718)

75 3/4" (1924)  
74" (1880)  
73 1/2" (1867)  
69 5/8" (1768)

55 3/4" (1416)  
54" (1372)  
53 1/2" (1359)  
49 5/8" (1260)

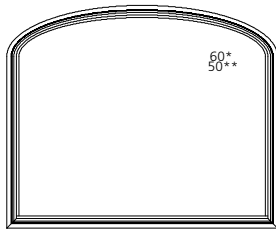

8EL6654

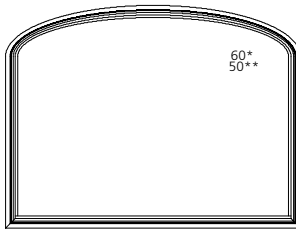

8EL7254

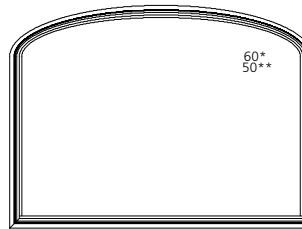

8EL7454

61 3/4" (1568)  
60" (1524)  
59 1/2" (1511)  
55 5/8" (1413)

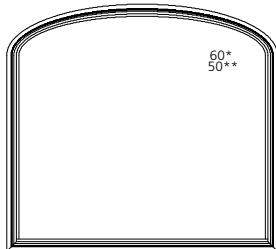

8EL6660

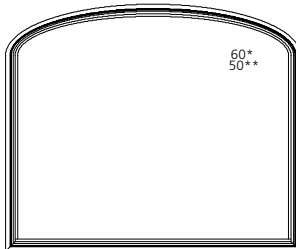

8EL7260

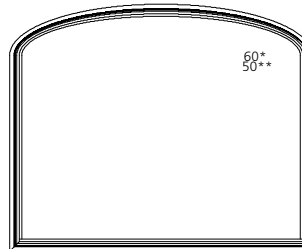

8EL7460

63 3/4" (1619)  
62" (1575)  
61 1/2" (1562)  
57 5/8" (1464)

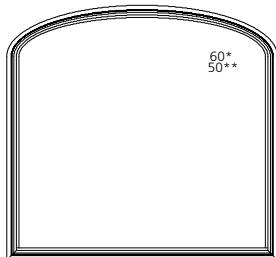

8EL6662

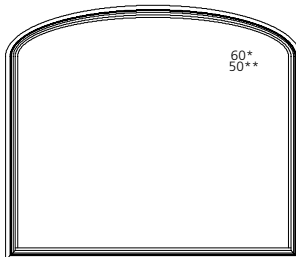

8EL7262

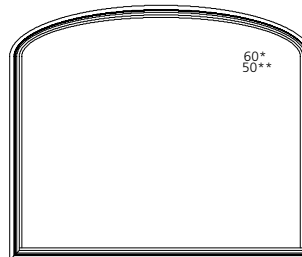

8EL7462

67 3/4" (1721)  
66" (1676)  
65 1/2" (1664)  
61 5/8" (1565)

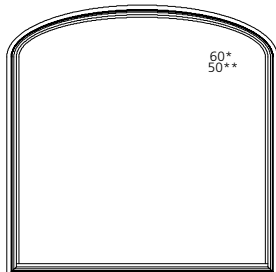

8EL6666

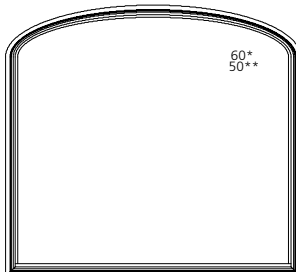

8EL7266

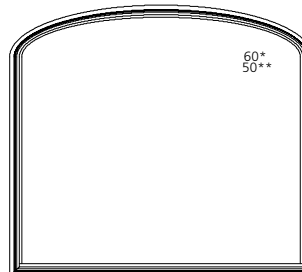

8EL7466

73 3/4" (1873)  
72" (1829)  
71 1/2" (1861)  
67 5/8" (1718)

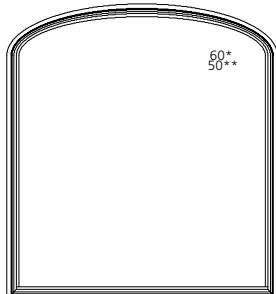

8EL6672

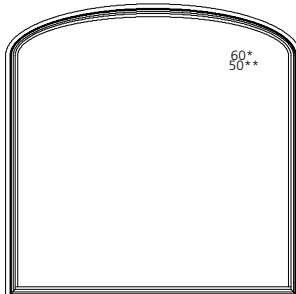

8EL7272

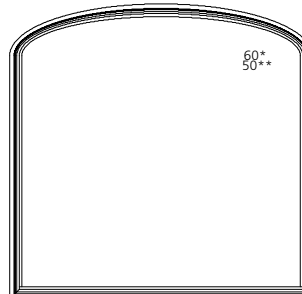

8EL7472

**ELEVATION SYMBOL LEGEND:**

VALUES IN ( ) ARE IN MILLIMETER CONVERSIONS.  
##\* - NUMBER INDICATES DESIGN PRESSURE (DP) RATING WITH STANDARD GLAZING.  
###\* - NUMBER INDICATES OPTIONAL DESIGN PRESSURE (DP) RATING.

SCALE: 1/4" = 1'

**ELLIPSE TOP WINDOWS**

UNIT SIZE  
ROUGH OPENING  
FRAME SIZE  
DAYLIGHT OPENING

67 3/4" (1721)  
66" (1676)  
65 1/2" (1664)  
61 5/8" (1565)

73 3/4" (1873)  
72" (1829)  
71 1/2" (1861)  
67 5/8" (1718)

75 3/4" (1924)  
74" (1880)  
73 1/2" (1867)  
69 5/8" (1768)

75 3/4" (1924)  
74" (1880)  
73 1/2" (1867)  
69 5/8" (1768)

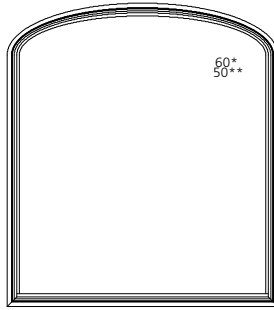

8EL6674

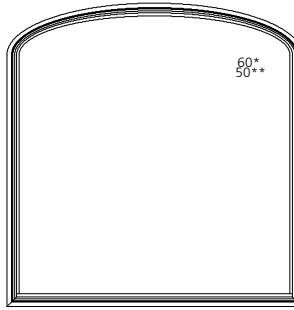

8EL7274

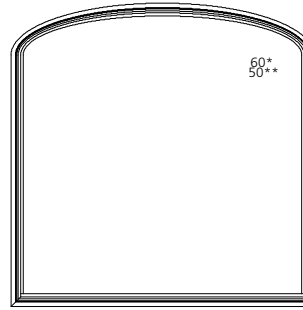

8EL7474

**ELEVATION SYMBOL LEGEND:**

VALUES IN () ARE IN MILLIMETER CONVERSIONS.  
##\* NUMBER INDICATES DESIGN PRESSURE (DP) RATING WITH STANDARD GLAZING.  
##\*\* NUMBER INDICATES OPTIONAL DESIGN PRESSURE (DP) RATING.

SCALE: 1/4" = 1'

**GLAZING OPTIONS**

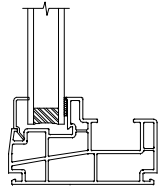

**3/4" IG  
1/8" GLASS SIZE**

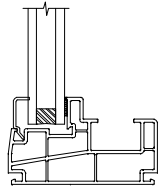

**3/4" IG  
3/16" GLASS SIZE**

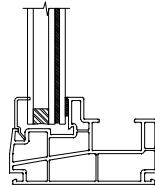

**3/4" LAMINATED GLASS  
1/8" GLASS SIZE**

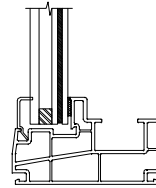

**3/4" LAMINATED GLASS  
3/16" GLASS SIZE**

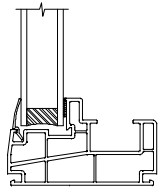

**7/8" IG  
1/8" GLASS SIZE**

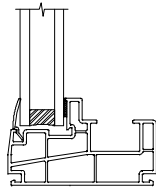

**7/8" IG  
3/16" GLASS SIZE**

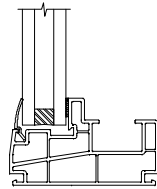

**7/8" IG  
1/4" GLASS SIZE**

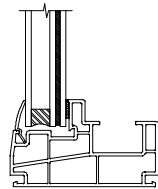

**7/8" IMPACT GLASS  
1/8" GLASS SIZE**

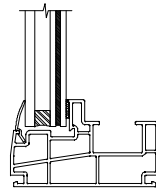

**7/8" IMPACT GLASS  
3/16" GLASS SIZE**

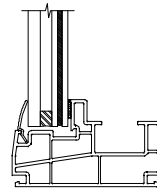

**7/8" IMPACT GLASS  
1/4" GLASS SIZE**

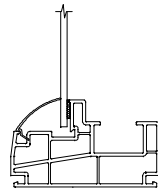

**SINGLE GLAZED  
1/8" GLASS SIZE**

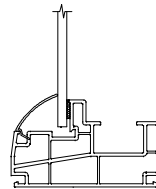

**SINGLE GLAZED  
3/16" GLASS SIZE**

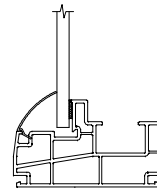

**SINGLE GLAZED  
1/4" GLASS SIZE**

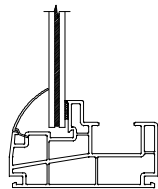

**SINGLE GLAZED IMPACT  
1/8" GLASS SIZE**

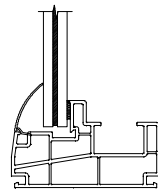

**SINGLE GLAZED IMPACT  
3/16" GLASS SIZE**

SCALE: 3" = 1'

---

**GRILLE PATTERNS**

---

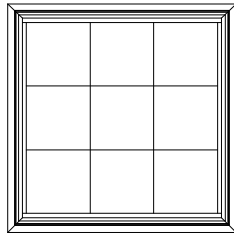

STANDARD

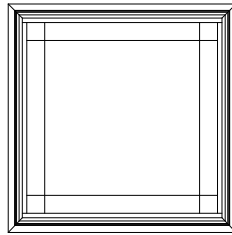

PRAIRIE

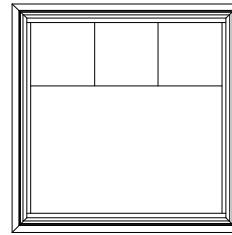

COLONIAL TOP 1/2

**GRILLE PATTERNS**  
**QUARTER ROUND**

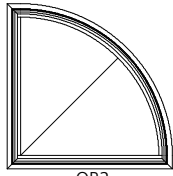

QR2

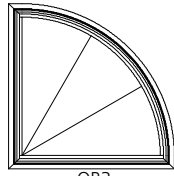

QR3

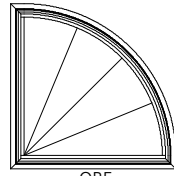

QR5

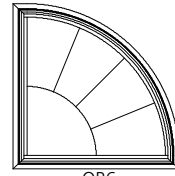

QR6

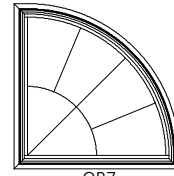

QR7

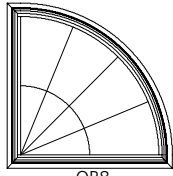

QR8

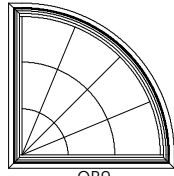

QR9

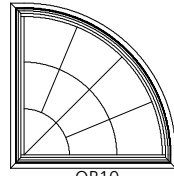

QR10

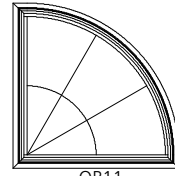

QR11

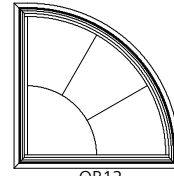

QR12

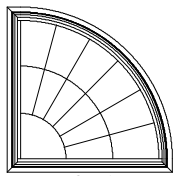

QR13

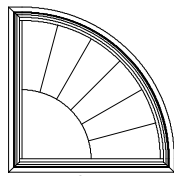

QR14

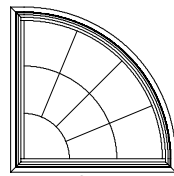

QR15

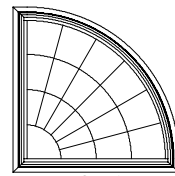

QR16

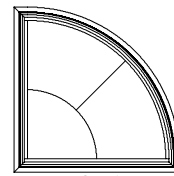

QR19

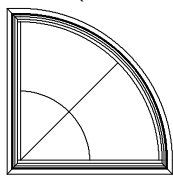

QR20

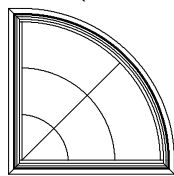

QR21

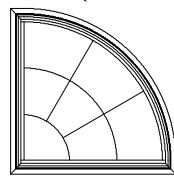

QR22

**HALF ROUND**

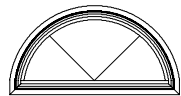

HR-3

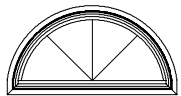

HR-5

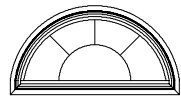

HR-6

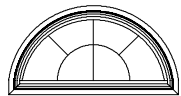

HR-7

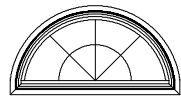

HR-8

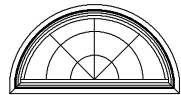

HR-9

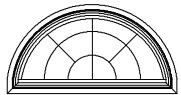

HR-10

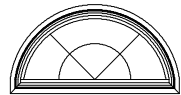

HR-11

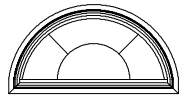

HR-12

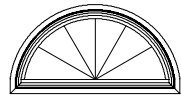

HR-13

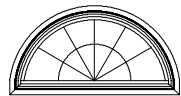

HR-14

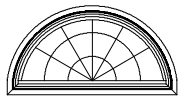

HR-15

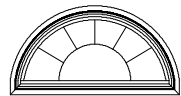

HR-16

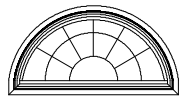

HR-17

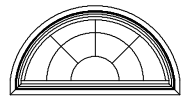

HR-18



HR-19

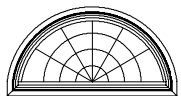

HR-20

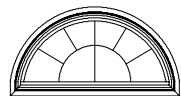

HR-23

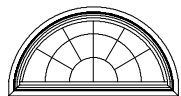

HR-24

**FULL ROUND**

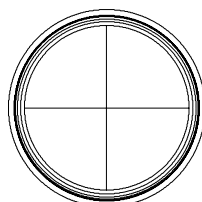

FR4

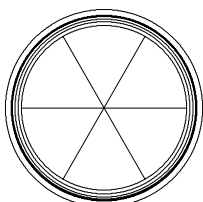

FR4

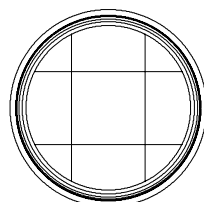

FR4



**GRILLE PATTERNS**  
**EXTENDED QUARTER ROUND**

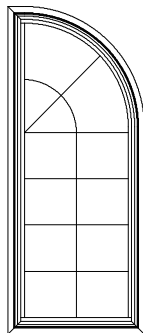

QT1

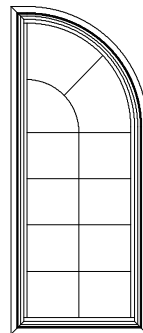

QT2

**EXTENDED HALF ROUND**

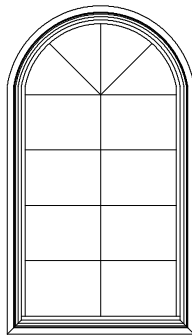

RT1

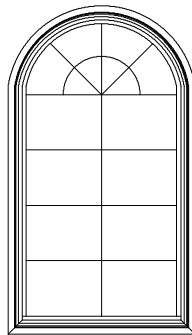

RT2

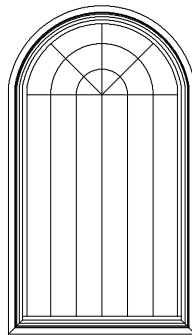

RT3

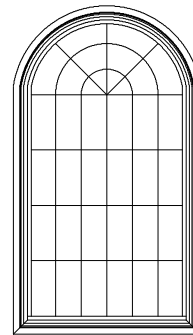

RT4

**EXTENDED CIRCLE SEGMENT**

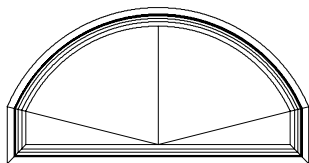

LP1

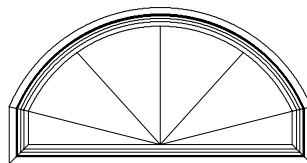

LP2

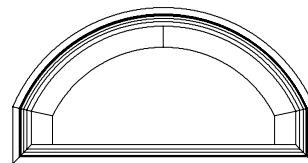

LP3

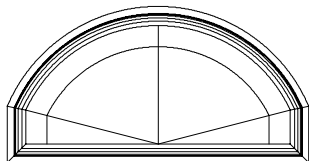

LP4

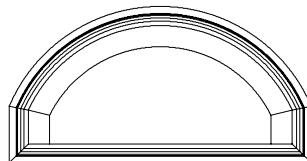

LP5

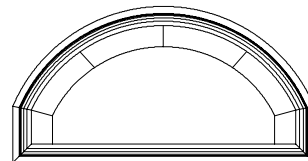

LP7

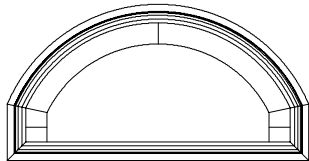

LP8

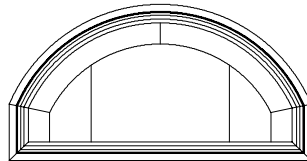

LP14

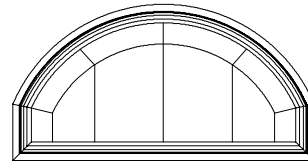

LP16

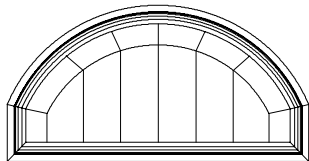

LP18

**PICTURE UNIT  
NAIL FIN**

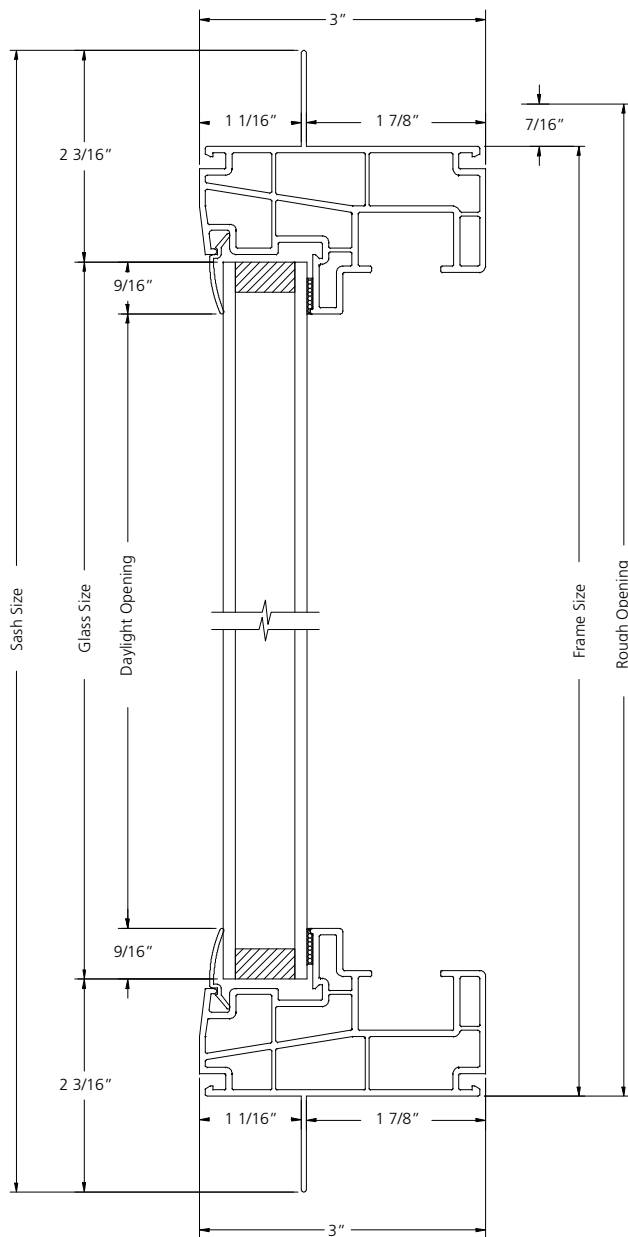

**VERTICAL SECTION**

SCALE: 6" = 1'

**PICTURE UNIT  
NAIL FIN**

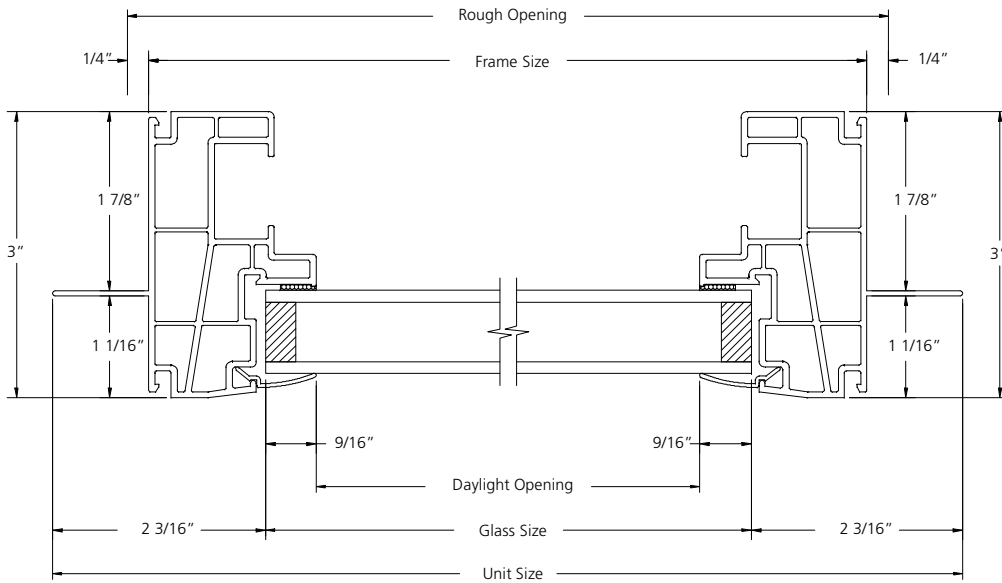

**HORIZONTAL SECTION**

SCALE: 6" = 1'

**PICTURE UNIT  
FLANGE**

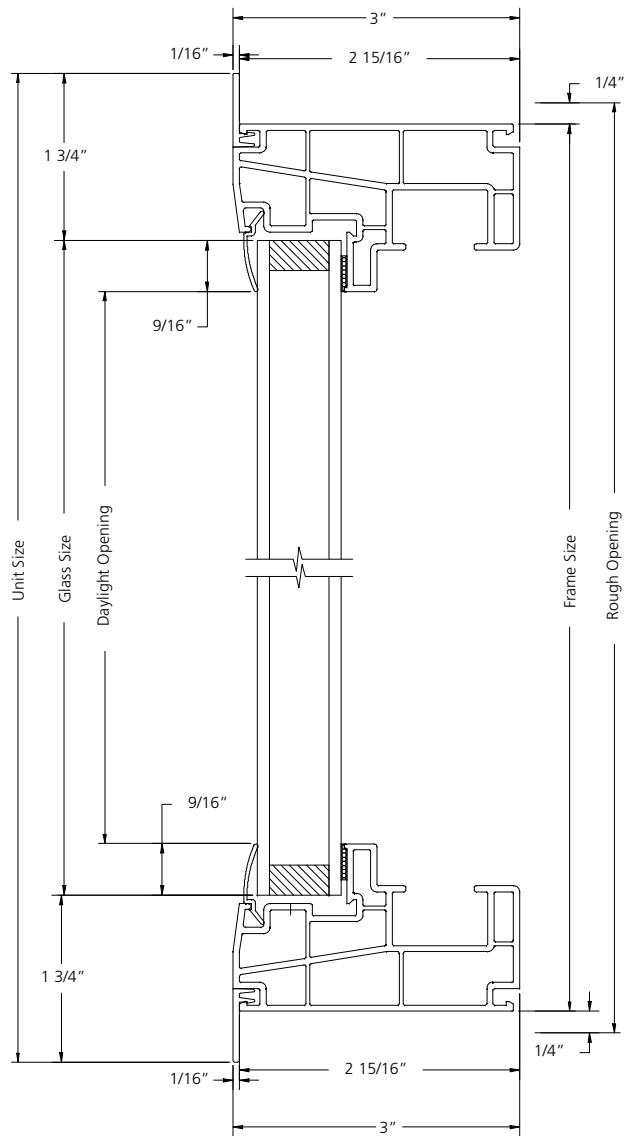

**VERTICAL SECTION**

SCALE: 6" = 1'

**PICTURE UNIT  
FLANGE**

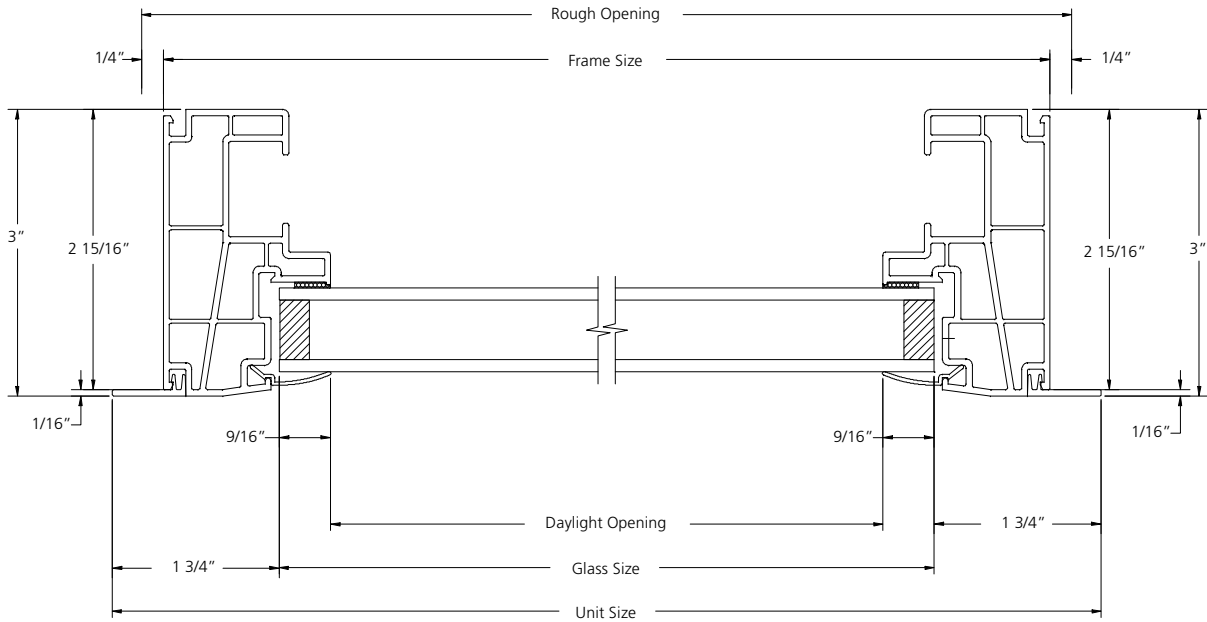

**HORIZONTAL SECTION**

SCALE: 6" = 1'

**PICTURE UNIT  
POCKET**

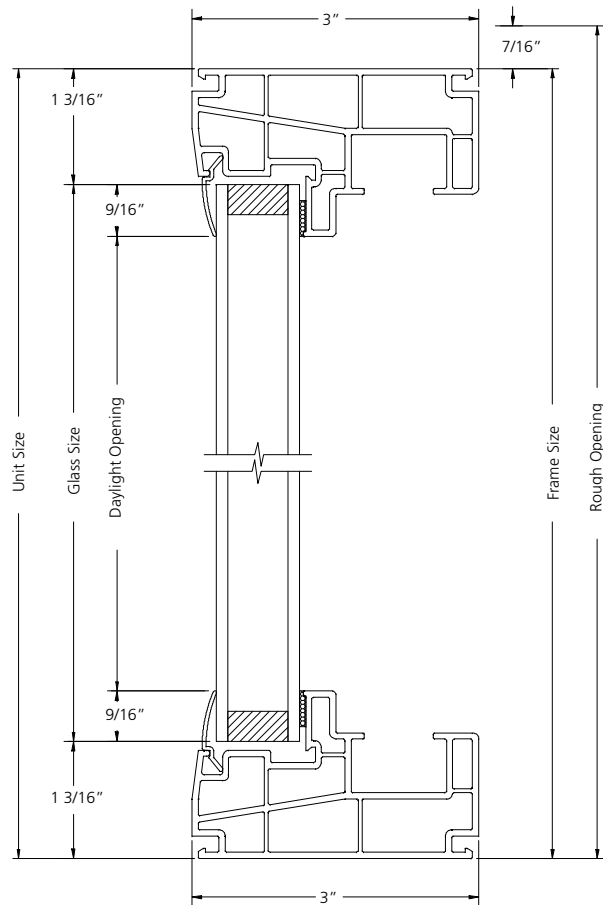

**VERTICAL SECTION**

SCALE: 6" = 1'

**PICTURE UNIT  
POCKET**

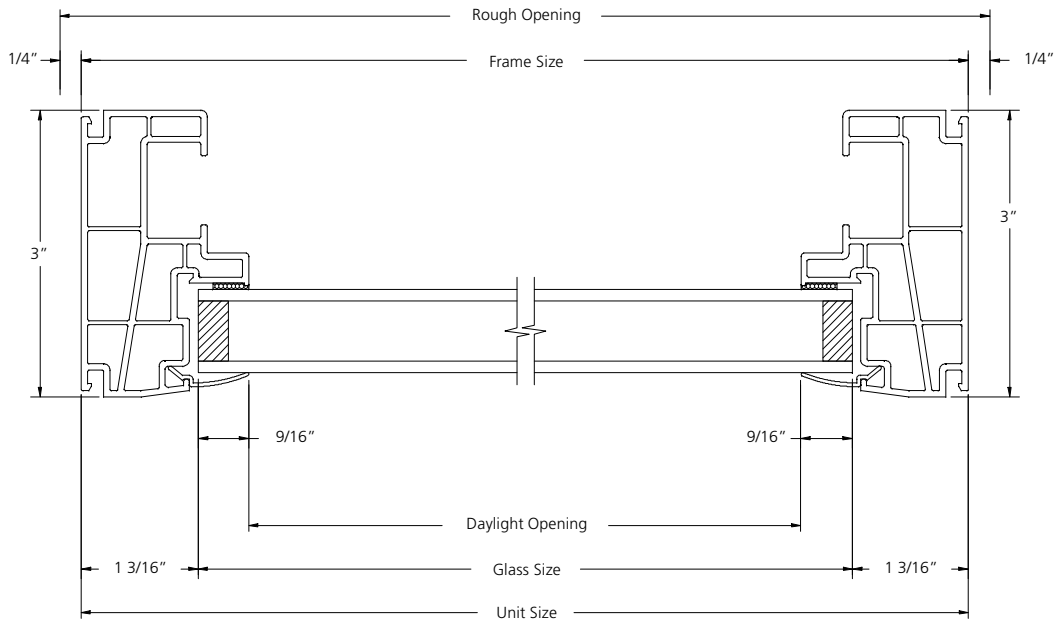

**HORIZONTAL SECTION**

SCALE: 6" = 1'