TABLE OF CONTENTS

Specifications	7-2
Quick Spec Guide	7-3
Elevations/Sizes: 1/4" Scale	
2-Panel Doors	7-4
3-Panel Doors	7-5
4-Panel Doors	7-6
Glazing Options: 3" Scale	7-7
Grille Patterns	7-8
Section Details: 3" & 6" Scale	7-9

PRODUCT SPECIFICATIONS

MATERIALS

The extruded vinyl profiles comply with the performance requirements of AAMA 303-97. Solid color extrusions are available in White and Desert Sand.

FRAME

All frames and sash are assembled using fusion-welding technology for added strength and durability. The frame jamb width is 5-15/16" (150.8mm), and the nominal extrusion exterior wall thickness is 0.080". The frame incorporates an integral nailing fin which can be easily removed to allow the unit to be used in a replacement window application. For added convenience, the frames can be ordered as Box frame with the nail fin already removed. Weep holes are included on the frame to ensure standing water is directed to the exterior plane of the unit. An interior and exterior accessory groove is standard to accommodate various frame accessory and assembly options on the product. The sliding patio door incorporates an extruded snap-in screen track on the exterior of the product. Transoms, and 2x5 structural mullion are available.

GLAZING

1" (25.4mm) tempered insulated glass consists of two lites of glass sealed around a spacer. The glass is mounted into the sash using a silicone-glazing compound. The insulating glass units comply with the performance requirements of the IGCC in accordance with either ASTM E774 or E2190. All units are exterior glazed.

GLAZING OPTIONS

1" (25.4mm) tempered insulated glass is available in clear, Low-E or Low-E 366, tinted, obscure or other specialty insulating glass as specified. Many glass options are available in ImpactGard® or monolithic glass. Optional Blinds Between the Glass in non-impact white doors are available in limited sizes and configurations.

WEATHER-STRIPPING

A fin-pile weather-strip is applied along the perimeter of the panels.

HARDWARE

The color matched handle set with a heavy duty lock is standard. The sliding patio door is available with an optional keyed cylinder lock for non-impact doors. Keyed locks are standard on impact doors. The non-impact handle is a contemporary D-handle. The impact handle is an over-sized hand pull to ensure ease of gliding for heavy panels. The sliding panel is equipped with heavy duty, metal rollers that glide effortlessly on a stainless steel panel track. Frame panel bumpers designed to limit the panel travel are included for mounting on the fixed panel frame. Coastal package is standard on impact doors and optional on non-impact doors.

INSECT SCREENS

The exterior fiberglass charcoal color insect screen is set in an aluminum frame to match the color of the unit. Insect screens are intended to allow air and light in and keep insects out. They are not intended to keep anyone or anything from falling through an open door or window. For safety screens or other security devices, contact your local building supply retailer.

GRILLES

SDL (Simulated Divided Lite) 1" (25.4mm) color-matched extruded aluminum contour muntins surface mounted on the exterior surfaces of the insulated or monolithic glass unit to provide a true divided lite appearance.

GBG (Grilles between the Glass) - 5/8" (16mm) and 7/8" (22.2mm) flat or 5/8" (16mm) contour grilles mounted between the glass panes suspended within the air cavity and color matched to the extrusion color.

ADDITIONAL ACCESSORIES

Additional accessories are available for JELD-WEN Vinyl products. Please contact your local building supply retailer for a complete listing of the additional accessories. See www.jeld-wen.com/findsupplier.

INSTALLATION

See www.jeld-wen.com/resources for instructions.

PERFORMANCE

NFRC Certified - (rated and labeled in accordance with NFRC)

AAMA/NWDMA I.S.2-97

Other rating standards may apply like AAMA 440-05, ASTM E1886/E1996, TAS, etc. See test reports for actual test protocols.

Please reference www.jeld-wen.com/performancecertatings for up-to-date Design Pressure and approval information.

QUICK SPEC GUIDE

SPECIFICATION	STANDARD FEATURES	OPTIONAL FEATURES <i>Some options may require additional lead times. Consult your JELD-WEN Sales Representative.</i>
COLOR	<ul style="list-style-type: none"> White 	<ul style="list-style-type: none"> Desert Sand
FRAME	<ul style="list-style-type: none"> Nail Fin 	<ul style="list-style-type: none"> Box Frame
GLAZING	<ul style="list-style-type: none"> 1" Insulated Tempered 	<ul style="list-style-type: none"> Tempered Low-E Tempered Bronze Tempered Gray Tempered Green Tempered Obscure Tempered Azurlite Tempered Graylite (Turtle) Tempered Bronze Reflective
IMPACTGARD PROTECTION		<ul style="list-style-type: none"> SGP Impact Single-Glaze SGP Impact Standard Insulated SGP Impact ImpactGard Insulated <p><i>Not available in tempered. All other tint and obscure glazing options apply.</i></p>
HARDWARE	<ul style="list-style-type: none"> Non-keyed Handle 	<ul style="list-style-type: none"> Oversized Keyed Handle for ImpactGard Brass Handle
HARDWARE COLOR	<ul style="list-style-type: none"> Matches Frame 	
SCREENS	<ul style="list-style-type: none"> Fiberglass 	
SCREEN FRAME COLOR	<ul style="list-style-type: none"> Matches Frame 	
GRILLES		<ul style="list-style-type: none"> SDL - 1" Simulated Divided Lite 5/8", 7/8" Flat GBG* 5/8" Contour GBG <p><i>*Check for availability</i></p>
JAMB	<ul style="list-style-type: none"> 5-15/16" 	

2-PANEL SLIDING PATIO DOORS

UNIT SIZE	62"(1575)	74"(1880)	98"(2489)
ROUGH OPENING	60"(1524)	72"(1829)	96"(2438)
FRAME SIZE	59 1/2"(1511)	71 1/2"(1861)	95 1/2"(2426)
DAYLIGHT OPENING	25"(635)	31"(787)	43"(1092)
	27 1/16"(687)	33 1/16"(840)	45 1/16"(1145)

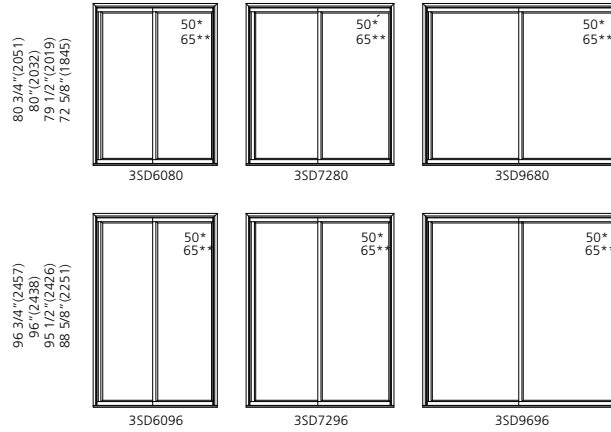

ELEVATION SYMBOL LEGEND:
VALUES IN () ARE IN MILLIMETER CONVERSIONS.
*** NUMBER INDICATES DESIGN PRESSURE (DP) RATING WITH STANDARD GLAZING.
**** NUMBER INDICATES OPTIONAL DESIGN PRESSURE (DP) RATING.

3-PANEL SLIDING PATIO DOORS

UNIT SIZE
ROUGH OPENING
FRAME SIZE
DAYLIGHT OPENING

112 13/16" (2866)
110 5/16" (2805)
109 13/16" (2790)
26" (660)
31 5/16" (795)

148 13/16" (3779)
146 5/16" (3716)
145 13/16" (3703)
38" (965)
42 5/16" (1075)

80 3/4" (2051)
80" (2032)
79 1/2" (2019)
72 5/8" (1845)

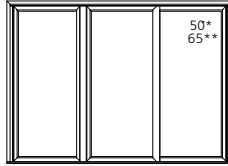

3SD11080-3

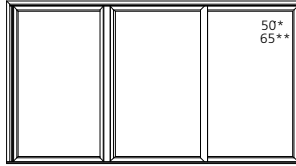

3SD14680-3

96 3/4" (2457)
96" (2438)
95 1/2" (2426)
88 5/8" (2251)

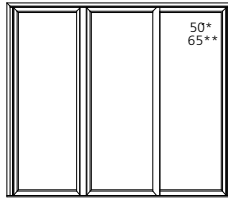

3SD11096-3

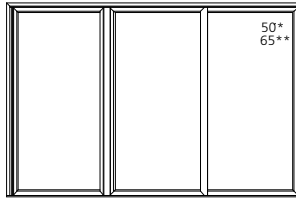

3SD14696-3

ELEVATION SYMBOL LEGEND:

VALUES IN () ARE IN MILLIMETER CONVERSIONS.

##* NUMBER INDICATES DESIGN PRESSURE (DP) RATING WITH STANDARD GLAZING.

##** NUMBER INDICATES OPTIONAL DESIGN PRESSURE (DP) RATING.

4-PANEL SLIDING PATIO DOORS

UNIT SIZE 121 5/8" (3089)
ROUGH OPENING 119 1/8" (3026)
FRAME SIZE 118 5/8" (3013)
DAYLIGHT OPENING 23 1/8" [2] (587)
23 3/8" [2] (594)

145 5/8" (3699)
143 1/8" (3635)
142 5/8" (3623)
29 1/8" [2] (740)
29 3/8" [2] (746)

193 5/8" (4918)
191 1/8" (4855)
190 5/8" (4842)
41 1/8" [2] (1045)
41 3/8" [2] (1051)

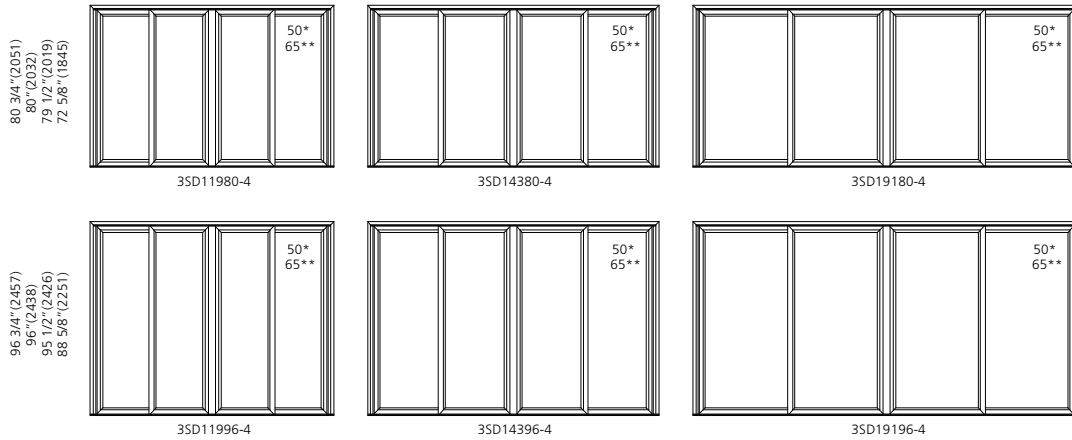

ELEVATION SYMBOL LEGEND:
VALUES IN () ARE IN MILLIMETER CONVERSIONS.
##* NUMBER INDICATES DESIGN PRESSURE (DP) RATING WITH STANDARD GLAZING.
###* NUMBER INDICATES OPTIONAL DESIGN PRESSURE (DP) RATING.

GLAZING OPTIONS

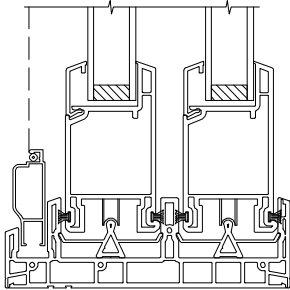

**1" IG
BBG ONLY**

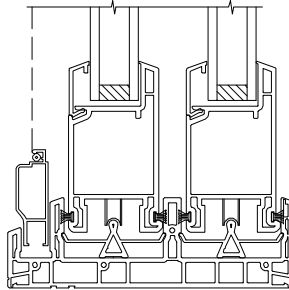

**1" IG
3/16" GLASS SIZE**

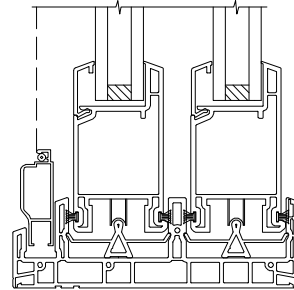

**1" IG
1/4" GLASS SIZE**

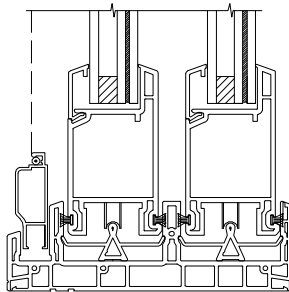

**1" IMPACT GLASS
3/16" GLASS SIZE**

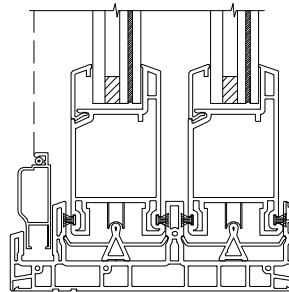

**1" IMPACT GLASS
1/4" GLASS SIZE**

GRILLE PATTERNS

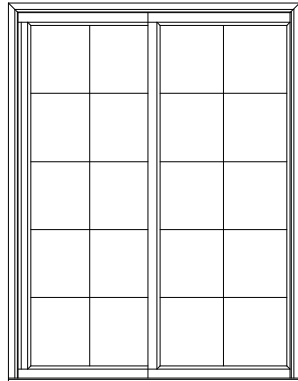

STANDARD

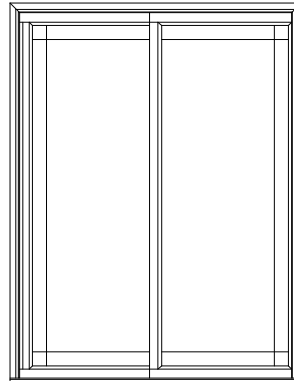

PRAIRIE

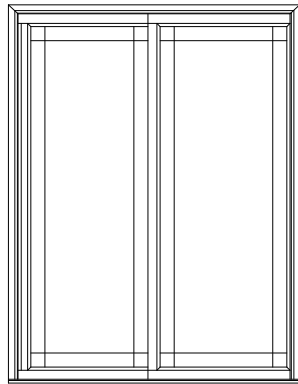

PRAIRIE SASH

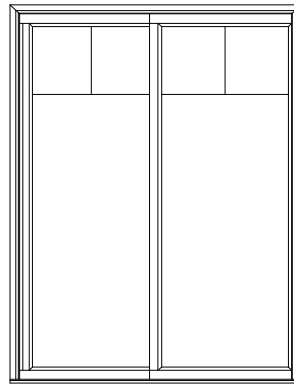

COLONIAL TOP SASH
1/2 LITE

2-PANEL SLIDING PATIO DOOR
NAIL FIN

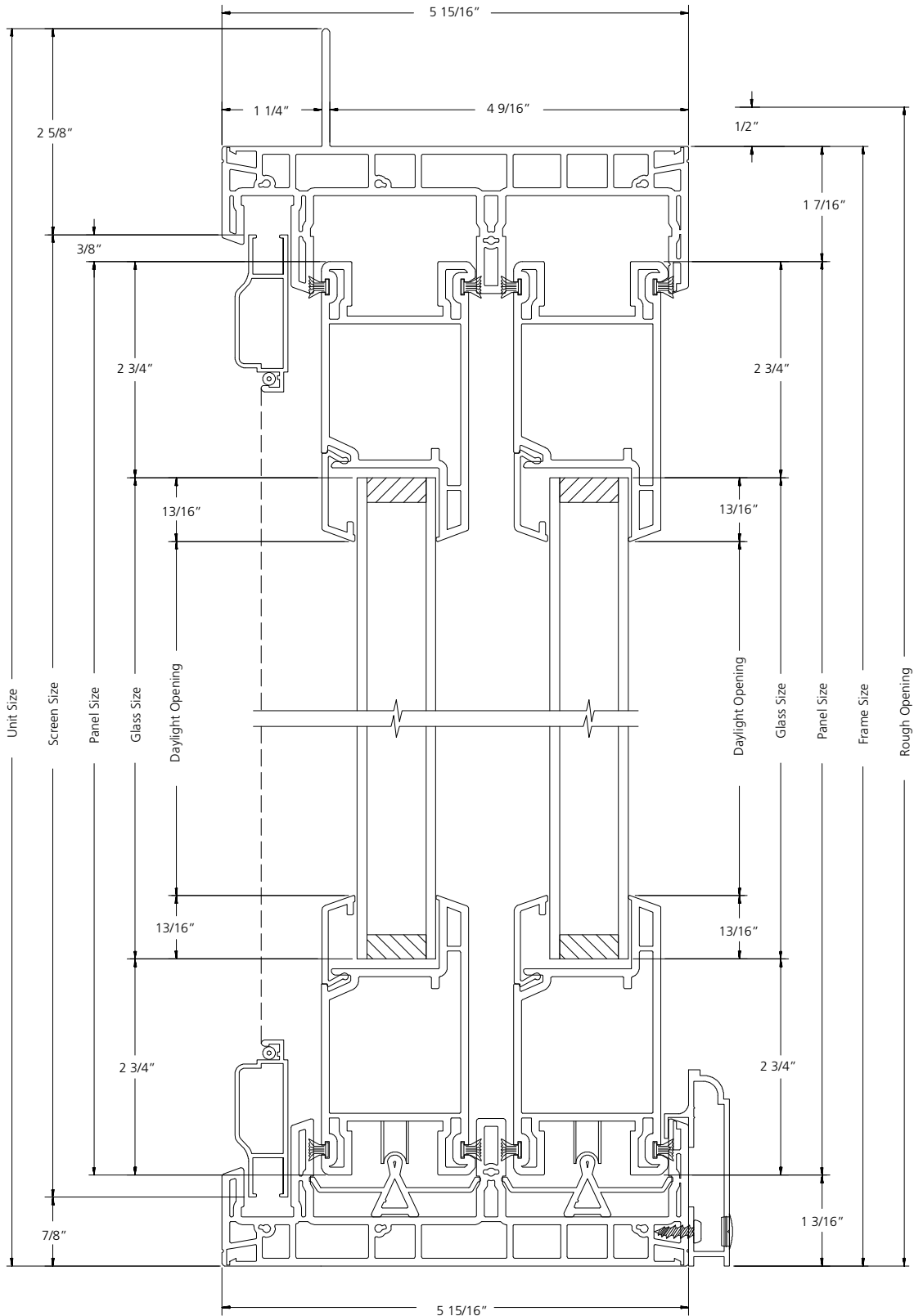

VERTICAL SECTION

SCALE: 6" = 1'

**2-PANEL SLIDING PATIO DOOR
NAIL FIN**

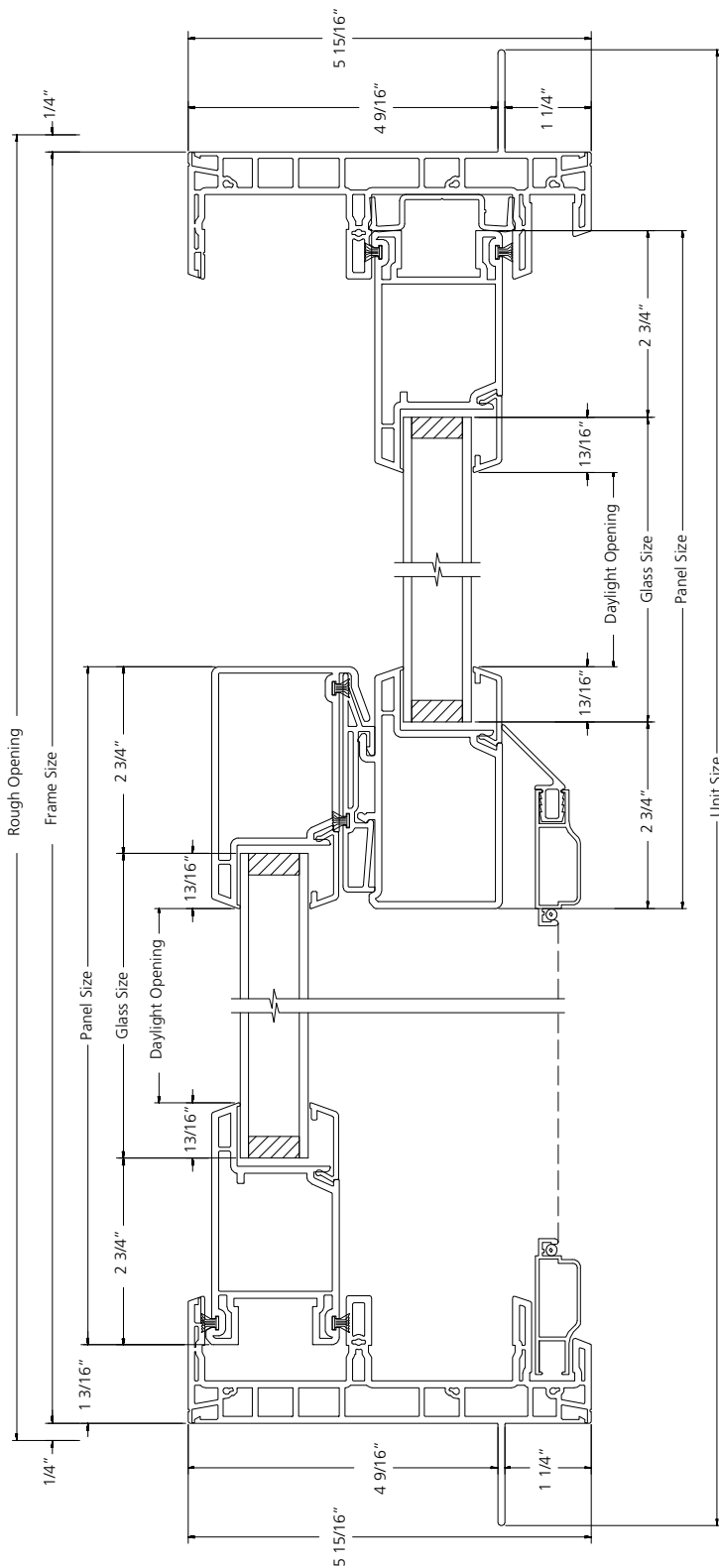

HORIZONTAL SECTION

**2-PANEL SLIDING PATIO DOOR
BOX**

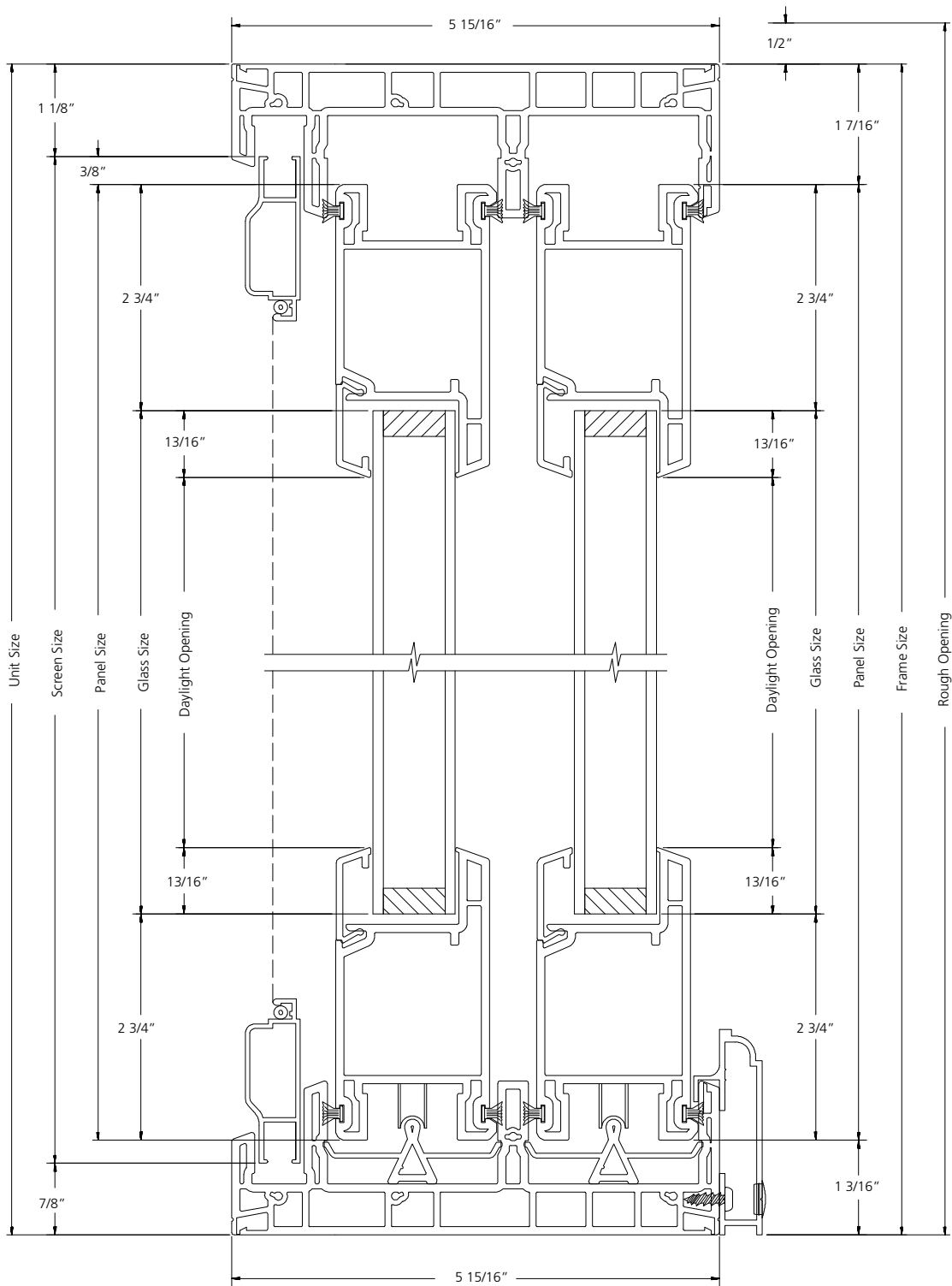

VERTICAL SECTION

SCALE: 6" = 1'

**2-PANEL SLIDING PATIO DOOR
BOX**

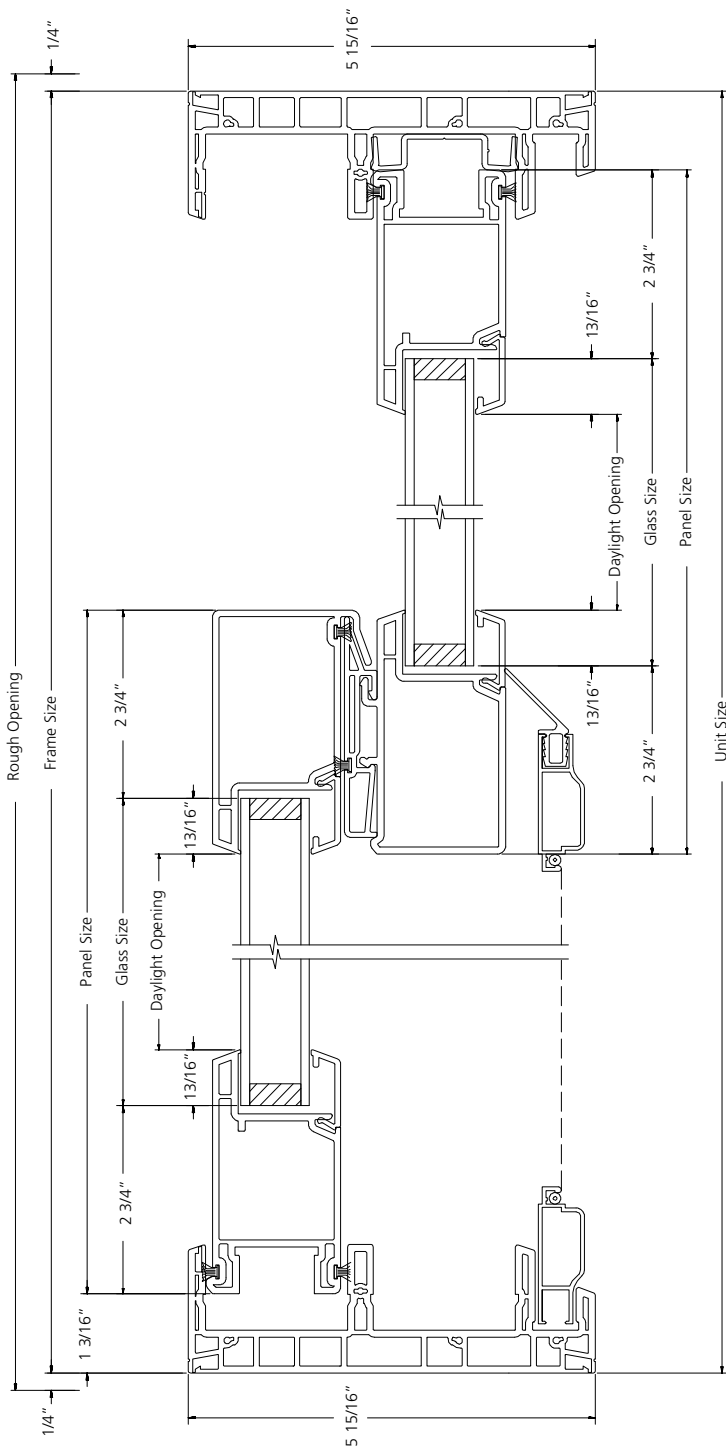

HORIZONTAL SECTION

**3-PANEL SLIDING PATIO DOOR
NAIL FIN**

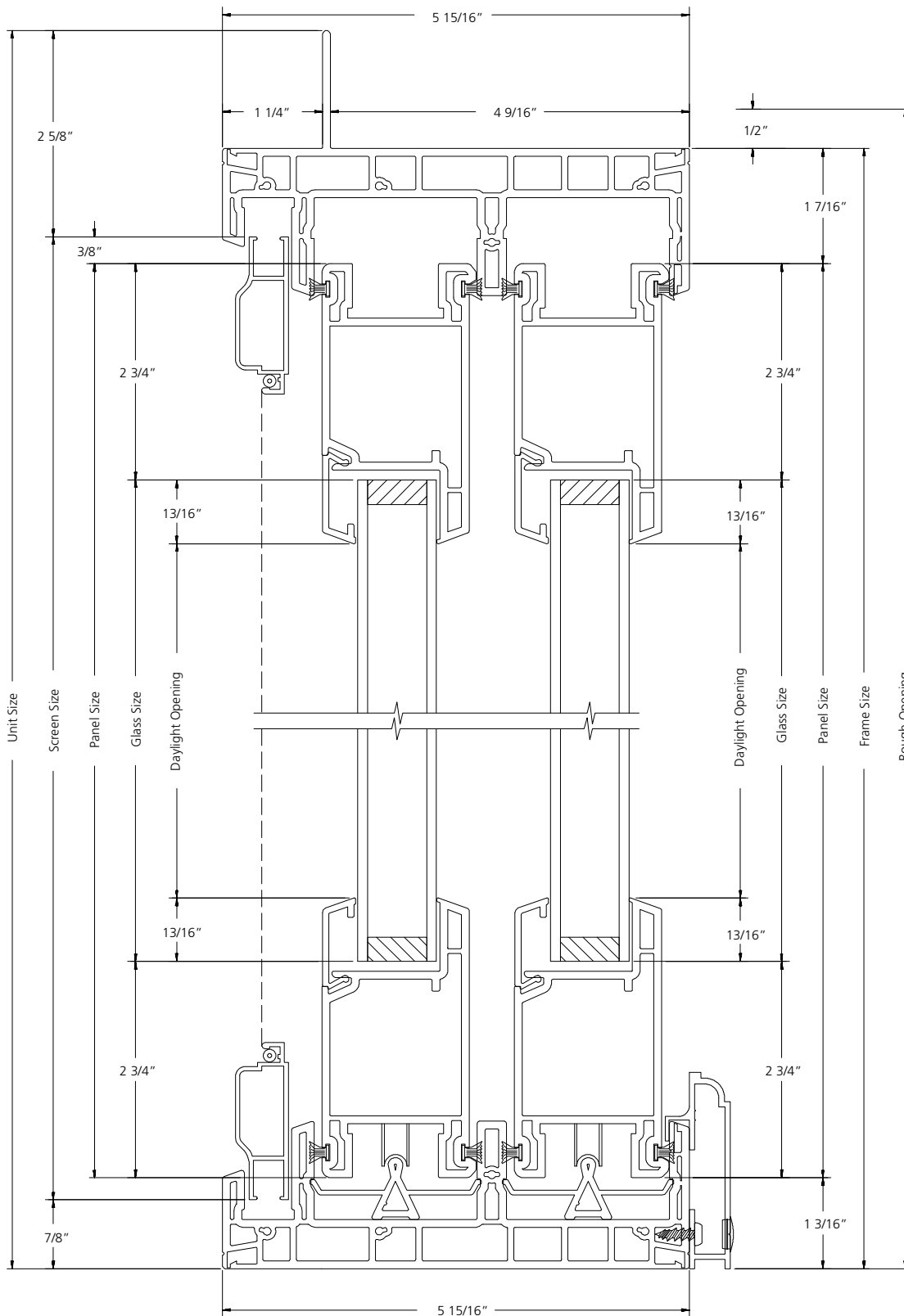

VERTICAL SECTION

SCALE: 6" = 1'

**3-PANEL SLIDING PATIO DOOR
NAIL FIN**

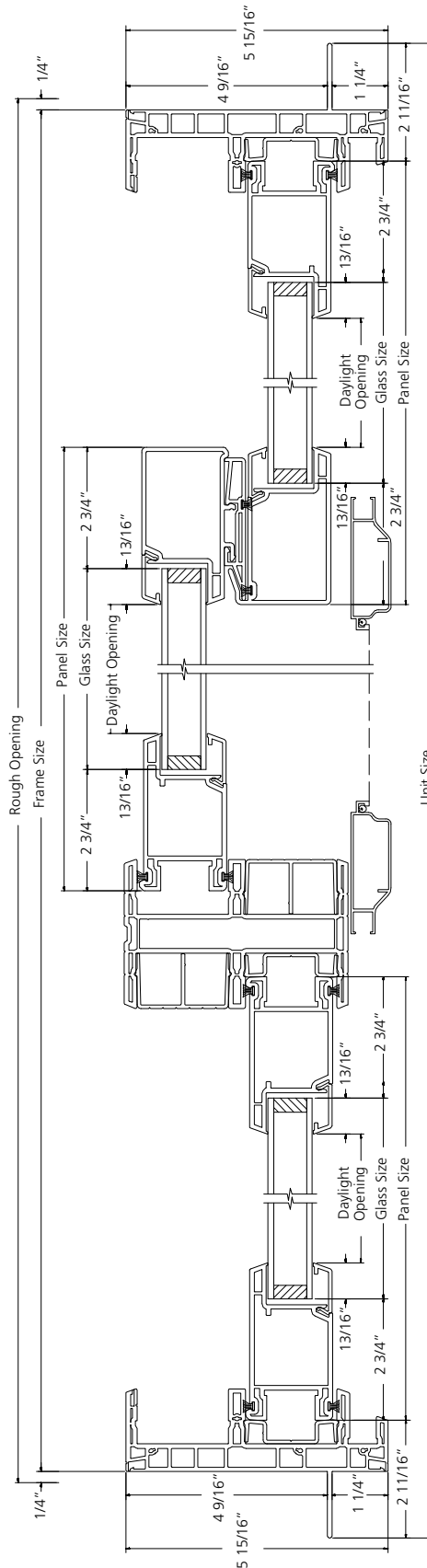

HORIZONTAL SECTION

SCALE: 3" = 1'

**3-PANEL SLIDING PATIO DOOR
BOX**

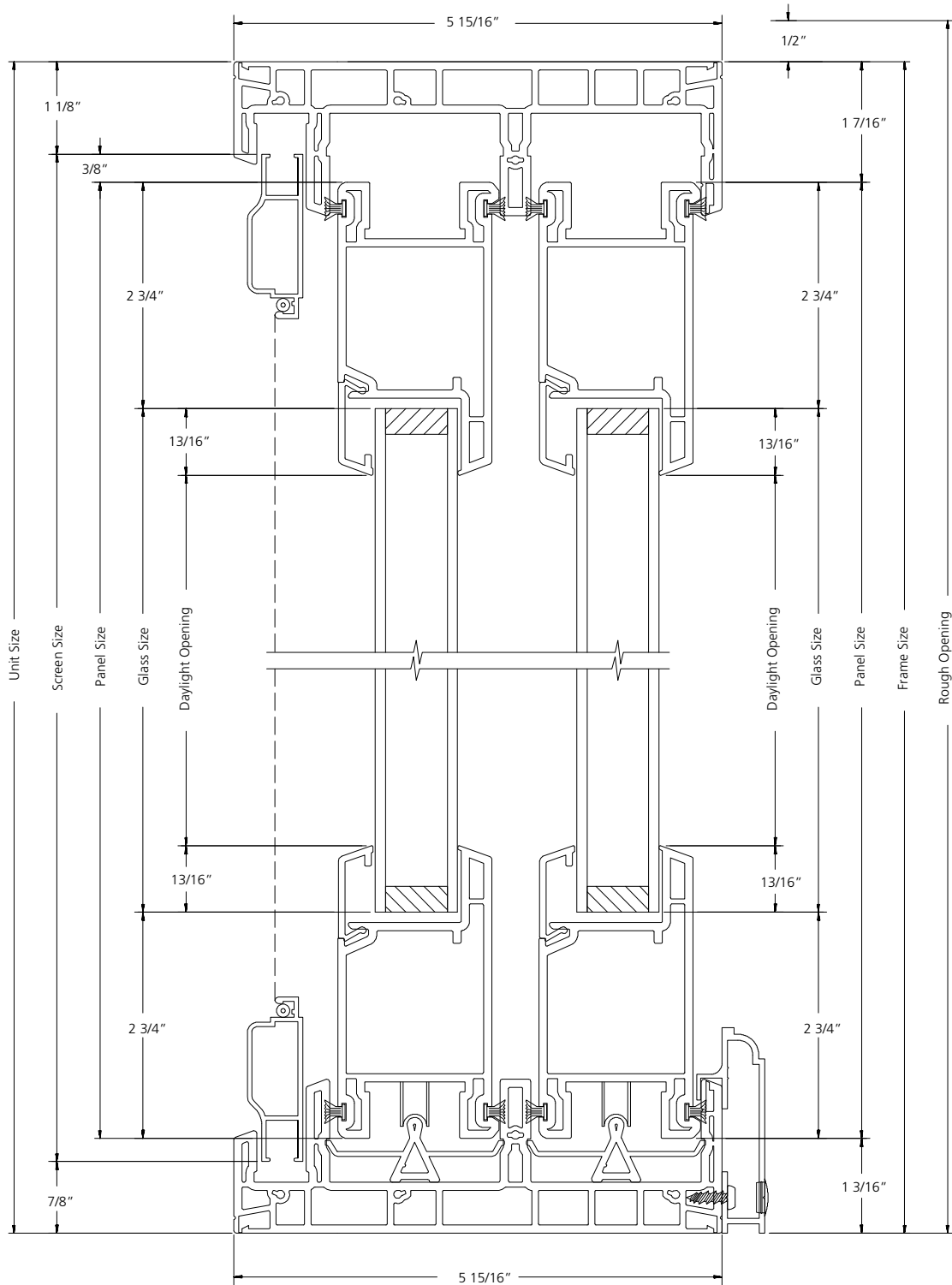

VERTICAL SECTION

SCALE: 6" = 1'

3-PANEL SLIDING PATIO DOOR BOX

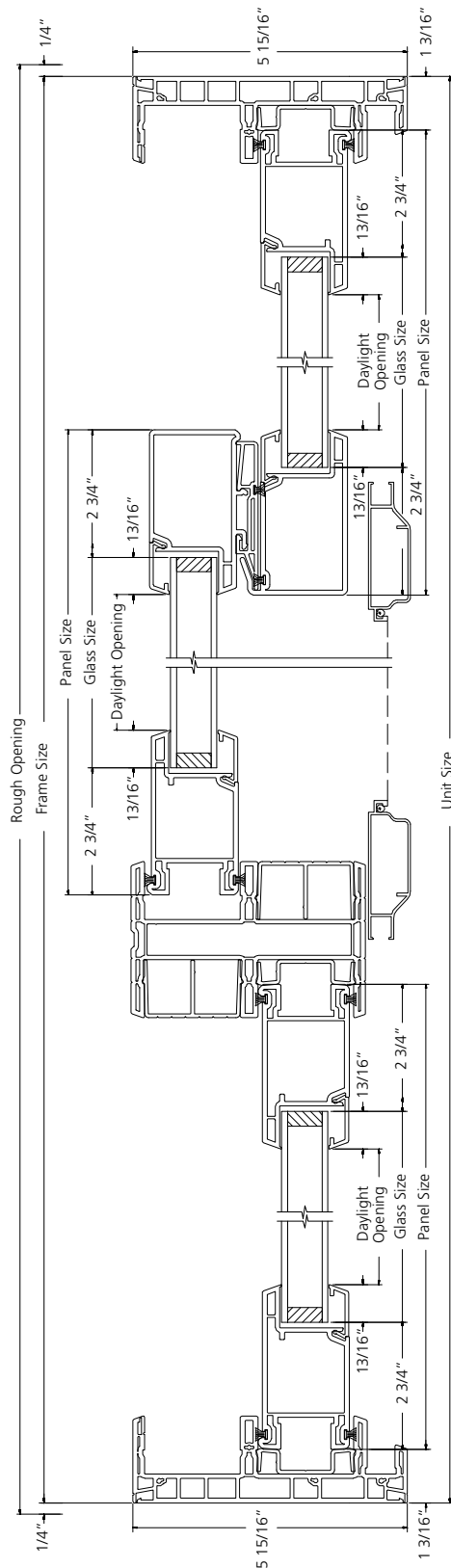

HORIZONTAL SECTION

SCALE: 3" = 1'

**4-PANEL SLIDING PATIO DOOR
NAIL FIN**

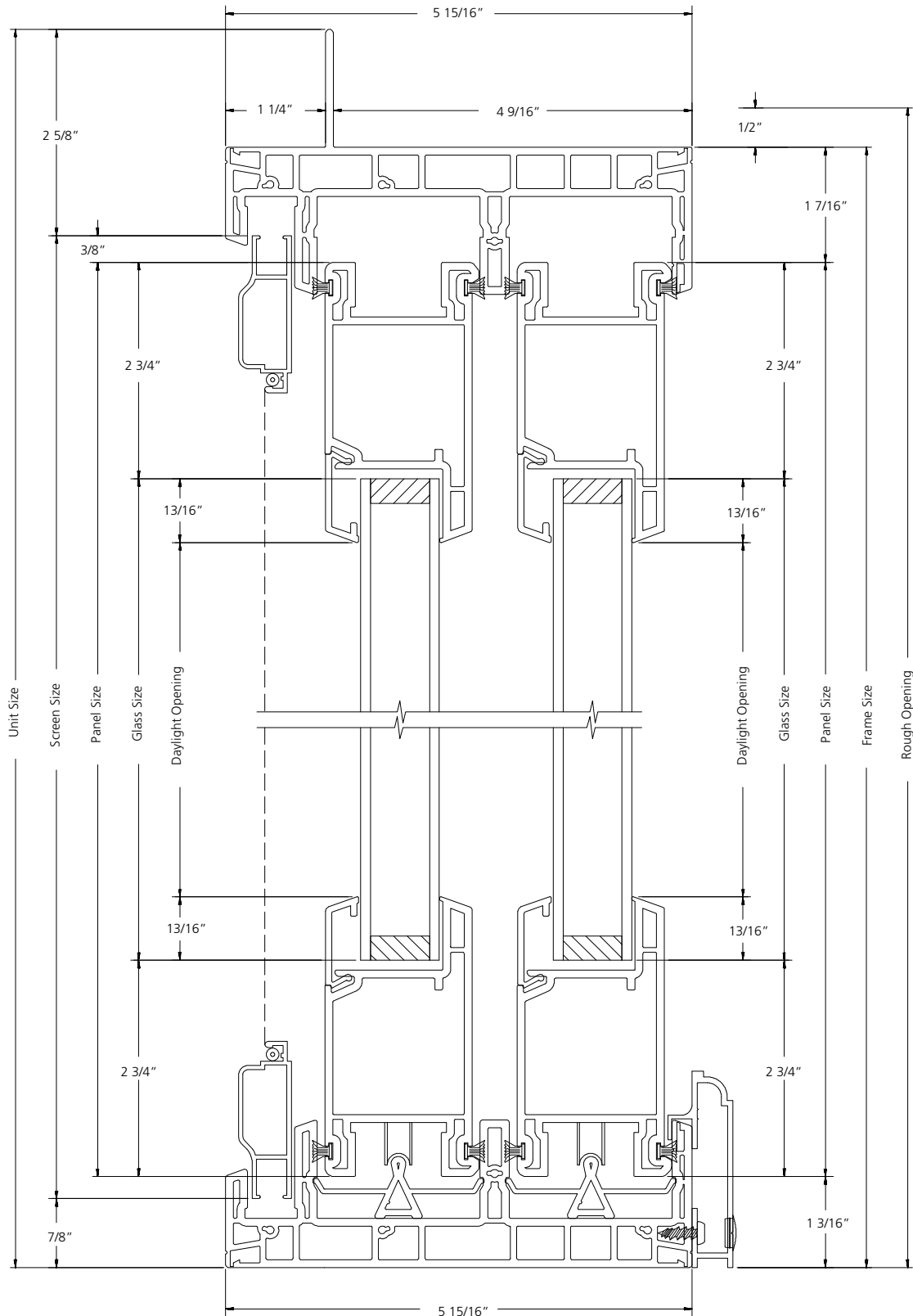

VERTICAL SECTION

SCALE: 6" = 1'

**4-PANEL SLIDING PATIO DOOR
NAIL FIN**

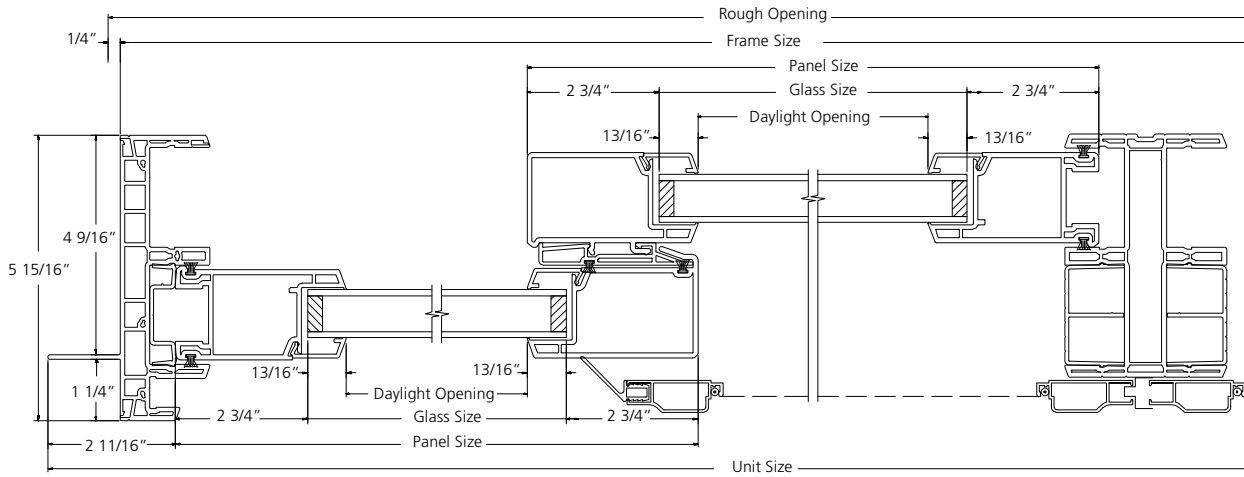

HORIZONTAL SECTION

SCALE: 6" = 1'

**4-PANEL SLIDING PATIO DOOR
BOX**

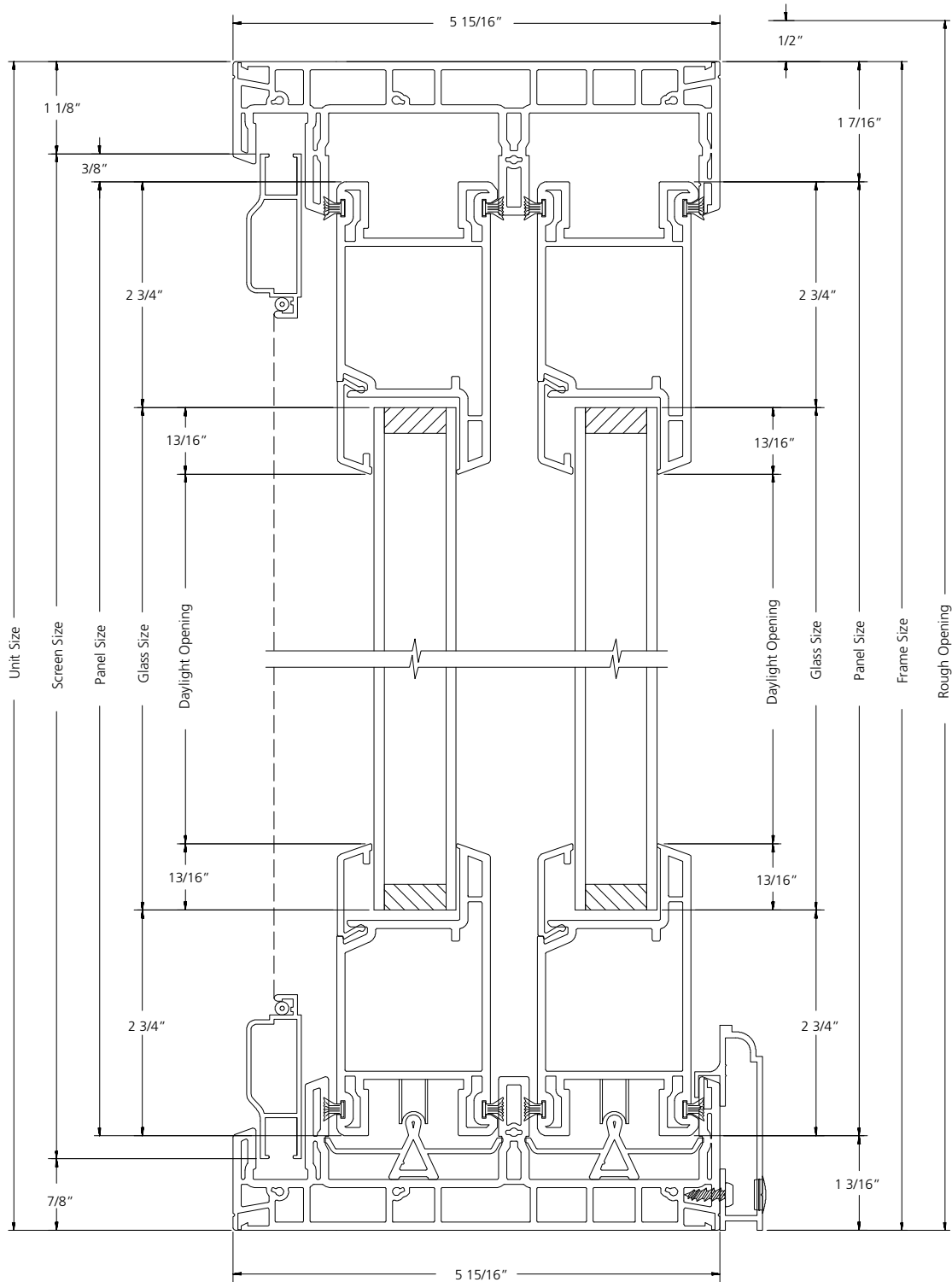

VERTICAL SECTION

SCALE: 6" = 1'

**4-PANEL SLIDING PATIO DOOR
BOX**

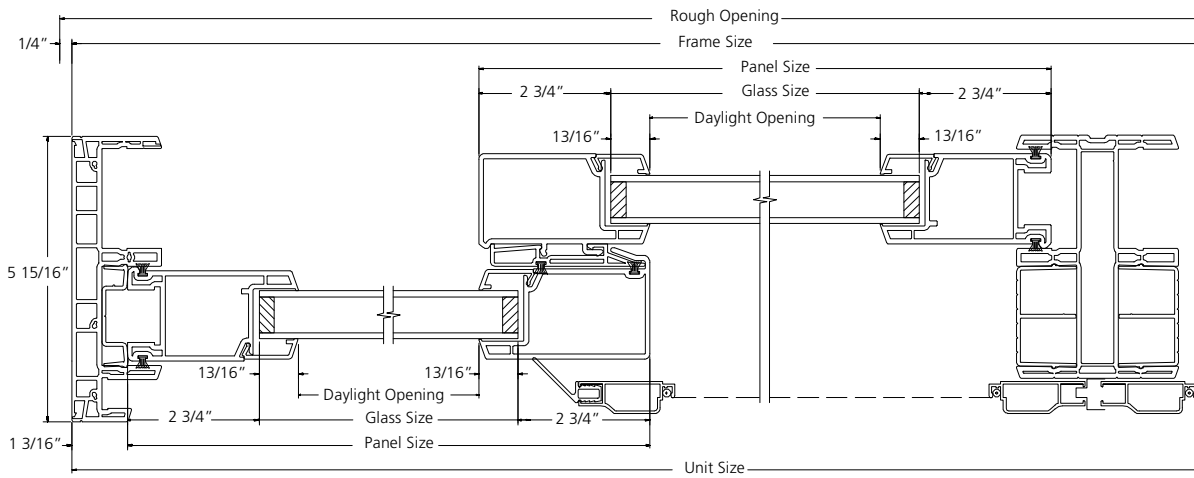

HORIZONTAL SECTION

SCALE: 6" = 1'