TABLE OF CONTENTS

Specifications	3-2
Quick Spec Guide	3-3
Elevations: 1/4" Scale	
Picture Units	3-4
Quarter Round	3-8
Half Round	3-9
Full Round	3-10
Octagon	3-11
Florida Quarter Round	3-12
Florida Half Round	3-13
Circle Segment	3-14
Extended Quarter Round	3-15
Extended Half Round	3-18
Extended Quarter Segment	3-22
Extended Circle Segment	3-26
Ellipse Top	3-30
Grille Patterns	3-34
Section Details: 6" Scale	3-36
Wall Details	3-42

PRODUCT SPECIFICATIONS

MATERIALS

White and MB-40 bronze electrostatically applied baked polyester paint.

FRAME

All rectangular frames are assembled with a silicone-injected corner key for added strength and durability. The frame jamb width is 2-11/16" (68.25 mm), and the nominal extrusion exterior wall thickness is 0.063". The frame incorporates a 1/2" front flange for typical Florida installations into block construction. Optional frame types: slip-on nailing fin.

GLAZING

3/4" (19mm) insulated glass consists of two lites of glass sealed around a spacer. 1/8" (3mm) and 3/16" (5mm) monolithic glazing. The glass is mounted into the sash using a silicone-glazing compound. The insulating glass units comply with the performance requirements of the IGCC in accordance with either ASTM E774 or E2190. All units are exterior glazed.

GLAZING OPTIONS

3/4" (19mm) insulated glass is available in clear, Low-E or Low-E 366, tinted, obscure or other specialty insulating glass as specified. 1/8" (3mm) and 3/16" (5mm) monolithic glazing. Many glass options are available in tempered glazing or monolithic glass.

GRILLES

GBG (Grilles between the Glass) - 5/8" (16mm) and 7/8" (22.2mm) flat or 5/8" (16mm) contour grilles mounted between the glass panes suspended within the air cavity and color matched to the extrusion color.

DA (Double Applied) - Aluminum 7/8" double applied flat/flat bar is applied to the exterior of the single glazed glass to give the detail of a true divided look.

ADDITIONAL ACCESSORIES

Please contact your local building supply retailer for a complete listing of the additional accessories. See www.jeld-wen.com/findsupplier.

INSTALLATION

See www.jeld-wen.com/resources for instructions.

PERFORMANCE

Please reference www.jeld-wen.com/performance ratings for up to date Design Pressure and approval information.

QUICK SPEC GUIDE

SPECIFICATION	STANDARD FEATURES	OPTIONAL FEATURES <i>Some options may require additional lead times. Consult your JELD-WEN Sales Representative.</i>
COLOR	<ul style="list-style-type: none"> • White • Bronze 	
SIZE	<ul style="list-style-type: none"> • Width: 13-1/2" - 75" • Height: 8" - 75" 	
FRAME	<ul style="list-style-type: none"> • Front Flange 	<ul style="list-style-type: none"> • Slip-On Fin
GLAZING	<ul style="list-style-type: none"> • Single-Glaze Clear 	<ul style="list-style-type: none"> • 3/4" Clear Insulated • 3/4" Low-E Insulated • Bronze • Gray • Green • Obscure • Azurlite • Graylite (Turtle) <p style="text-align: center;"><i>All glass available tempered</i></p>
GRILLES		<ul style="list-style-type: none"> • Double Applied Flat/Flat Bar (single-glaze only) • 5/8", 7/8" Flat GBG • 5/8" Contour
JAMB	<ul style="list-style-type: none"> • 2-11/16" 	

PICTURE UNITS

UNIT SIZE ROUGH OPENING FRAME SIZE DAYLIGHT OPENING	18" 17 1/2" 17" 14 19/32"	24" 23 1/2" 23" 20 19/32"	30" 29 1/2" 29" 26 19/32"	36" 35 1/2" 35" 32 19/32"	42" 41 1/2" 41" 38 19/32"	48" 47 1/2" 47" 44 19/32"	54" 53 1/2" 53" 50 19/32"
18" 17 1/2" 17" 14 19/32"	15* 4FW1818	15* 4FW2418	15* 4FW3018	15* 4FW3618	15* 4FW4218	15* 4FW4818	15* 4FW5418
24" 24 1/2" 24" 21 19/32"	15* 4FW1824	15* 4FW2424	15* 4FW3024	15* 4FW3624	15* 4FW4224	15* 4FW4824	15* 4FW5424
30" 29 1/2" 29" 26 19/32"	15* 4FW1830	15* 4FW2430	15* 4FW3030	15* 4FW3630	15* 4FW4230	15* 4FW4830	15* 4FW5430
36" 35 1/2" 35" 32 19/32"	15* 4FW1836	15* 4FW2436	15* 4FW3036	15* 4FW3636	15* 4FW4236	15* 4FW4836	15* 4FW5436
42" 41 1/2" 41" 38 19/32"	15* 4FW1842	15* 4FW2442	15* 4FW3042	15* 4FW3642	15* 4FW4242	15* 4FW4842	15* 4FW5442
48" 47 1/2" 47" 44 19/32"	15* 4FW1848	15* 4FW2448	15* 4FW3048	15* 4FW3648	15* 4FW4248	15* 4FW4848	15* 4FW5448
54" 53 1/2" 53" 50 19/32"	15* 4FW1854	15* 4FW2454	15* 4FW3054	15* 4FW3654	15* 4FW4254	15* 4FW4854	15* 4FW5454
60" 59 1/2" 59" 56 19/32"	15* 4FW1860	15* 4FW2460	15* 4FW3060	15* 4FW3660	15* 4FW4260	15* 4FW4860	15* 4FW5460

ELEVATION SYMBOL LEGEND:
##* NUMBER INDICATES DESIGN PRESSURE (DP) RATING WITH STANDARD GLAZING.

SCALE: 1/4" = 1'

PICTURE UNITS



	18"	24"	30"	36"	42"	48"	54"
UNIT SIZE	18"	24"	30"	36"	42"	48"	54"
ROUGH OPENING	17 1/2"	23 1/2"	29 1/2"	35 1/2"	41 1/2"	47 1/2"	53 1/2"
FRAME SIZE	17"	23"	29"	35"	41"	47"	53"
DAYLIGHT OPENING	14 19/32"	20 19/32"	26 19/32"	32 19/32"	38 19/32"	44 19/32"	50 19/32"
	4FW1866	4FW2466	4FW3066	4FW3666	4FW4266	4FW4866	4FW5466
	4FW1872	4FW2472	4FW3072	4FW3672	4FW4272	4FW4872	4FW5472
	4FW1876	4FW2476	4FW3076	4FW3676	4FW4276	4FW4876	4FW5476

ELEVATION SYMBOL LEGEND:
NUMBER INDICATES DESIGN PRESSURE (DP) RATING WITH STANDARD GLAZING.

SCALE: 1/4" = 1'

PICTURE UNITS

UNIT SIZE
ROUGH OPENING
FRAME SIZE
DAYLIGHT OPENING

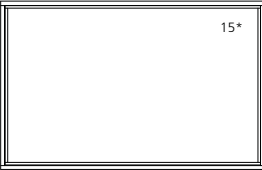
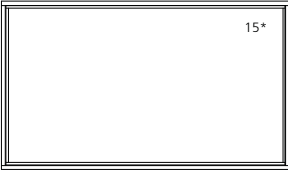
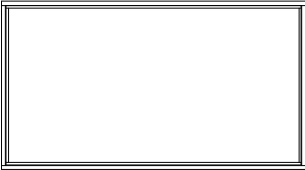
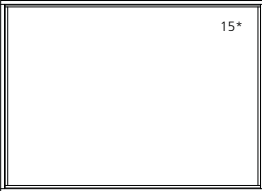
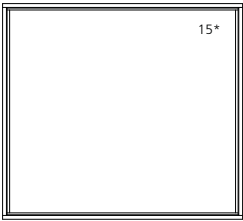
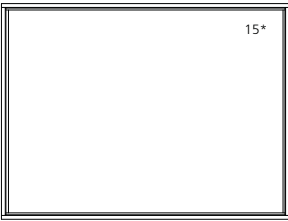
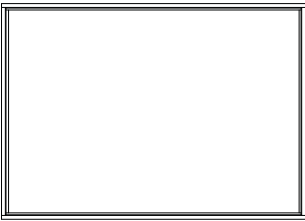
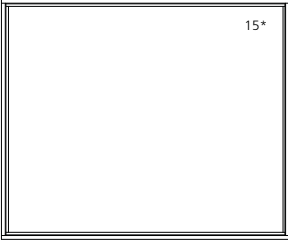
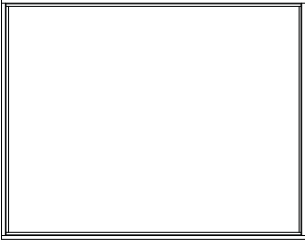
	60" 59 1/2" 59" 56 19/32"	66" 65 1/2" 65" 62 19/32"	72" 71 1/2" 71" 68 19/32"	76" 75 1/2" 75" 72 19/32"
18" 17 1/2" 17" 14 19/32"	 4FW6018	 4FW6618	 4FW7218	 4FW7618
24" 24 1/2" 24" 21 19/32"	 4FW6024	 4FW6624	 4FW7224	 4FW7624
30" 29 1/2" 29" 26 19/32"	 4FW6030	 4FW6630	 4FW7230	 4FW7630
36" 35 1/2" 35" 32 19/32"	 4FW6036	 4FW6636	 4FW7236	 4FW7636
42" 41 1/2" 41" 38 19/32"	 4FW6042	 4FW6642	 4FW7242	 4FW7642
48" 47 1/2" 47" 44 19/32"	 4FW6048	 4FW6648	 4FW7248	 4FW7648
54" 53 1/2" 53" 50 19/32"	 4FW6054	 4FW6654	 4FW7254	 4FW7654
60" 59 1/2" 59" 56 19/32"	 4FW6060	 4FW6660	 4FW7260	 4FW7660

ELEVATION SYMBOL LEGEND:
##* NUMBER INDICATES DESIGN PRESSURE (DP) RATING WITH STANDARD GLAZING.

SCALE: 1/4" = 1'

PICTURE UNITS

UNIT SIZE
ROUGH OPENING
FRAME SIZE
DAYLIGHT OPENING

	60" 59 1/2" 59" 56 19/32"	66" 65 1/2" 65" 62 19/32"	72" 71 1/2" 71" 68 19/32"	76" 75 1/2" 75" 72 19/32"
66" 65 1/2" 62 19/32"	15* 4FW6066	15* 4FW6666	15* 4FW7266	4FW7666
72" 71 1/2" 68 19/32"	15* 4FW6072	15* 4FW6672	15* 4FW7272	4FW7672
76" 75 1/2" 72 19/32"	4FW6076	4FW6676	4FW7276	

ELEVATION SYMBOL LEGEND:

##* NUMBER INDICATES DESIGN PRESSURE (DP) RATING WITH STANDARD GLAZING.

SCALE: 1/4" = 1'

QUARTER ROUND

UNIT SIZE
ROUGH OPENING
FRAME SIZE
DAYLIGHT OPENING

24"
23 1/2"
23"
20 19/32"

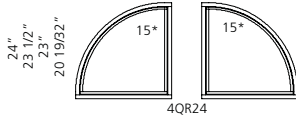

4QR24

30"
29 1/2"
29"
26 19/32"

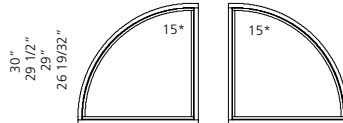

4QR30

36"
35 1/2"
35"
32 19/32"

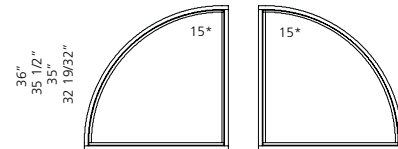

4QR36

UNIT SIZE
ROUGH OPENING
FRAME SIZE
DAYLIGHT OPENING

42"
41 1/2"
41"
38 19/32"

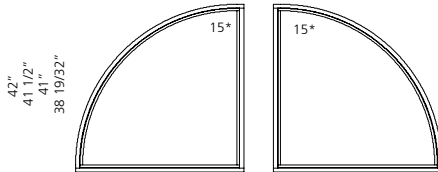

4QR42

48"
47 1/2"
47"
44 19/32"

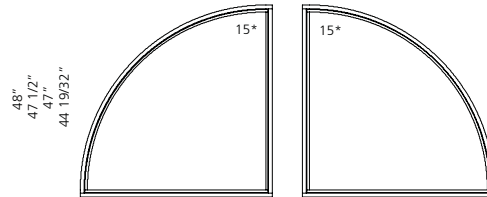

4QR48

UNIT SIZE
ROUGH OPENING
FRAME SIZE
DAYLIGHT OPENING

54"
53 1/2"
53"
50 19/32"

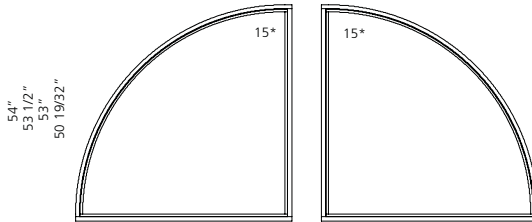

4QR54

60"
59 1/2"
59"
56 19/32"

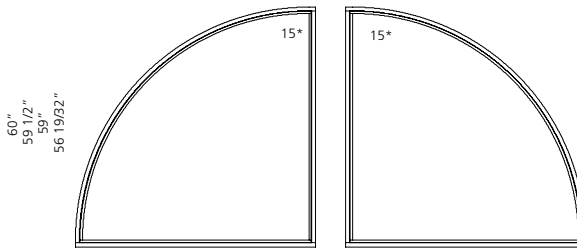

4QR60

ELEVATION SYMBOL LEGEND:
##* NUMBER INDICATES DESIGN PRESSURE (DP) RATING WITH STANDARD GLAZING.

SCALE: 1/4" = 1'

HALF ROUND

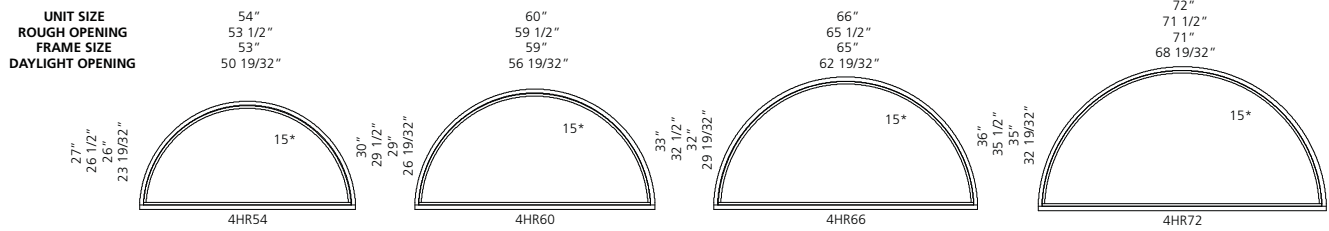
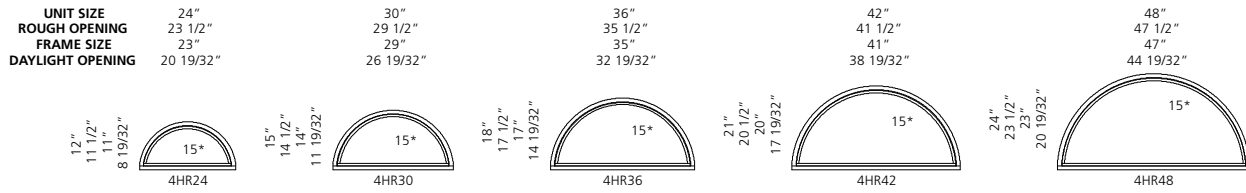

ELEVATION SYMBOL LEGEND:

NUMBER INDICATES DESIGN PRESSURE (DP) RATING WITH STANDARD GLAZING.

SCALE: 1/4" = 1'

FULL ROUND

UNIT SIZE 24"
ROUGH OPENING 23 1/2"
FRAME SIZE 23"
DAYLIGHT OPENING 20 19/32"

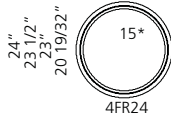

UNIT SIZE 30"
ROUGH OPENING 29 1/2"
FRAME SIZE 29"
DAYLIGHT OPENING 26 19/32"

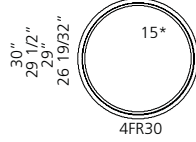

UNIT SIZE 36"
ROUGH OPENING 35 1/2"
FRAME SIZE 35"
DAYLIGHT OPENING 32 19/32"

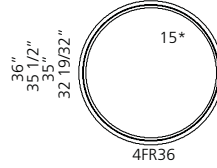

UNIT SIZE 42"
ROUGH OPENING 41 1/2"
FRAME SIZE 41"
DAYLIGHT OPENING 38 19/32"

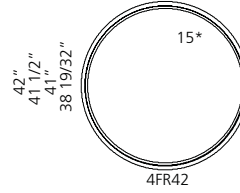

UNIT SIZE 48"
ROUGH OPENING 47 1/2"
FRAME SIZE 47"
DAYLIGHT OPENING 44 19/32"

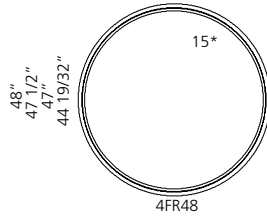

UNIT SIZE 54"
ROUGH OPENING 53 1/2"
FRAME SIZE 53"
DAYLIGHT OPENING 50 19/32"

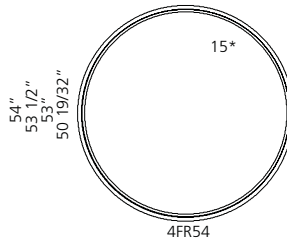

UNIT SIZE 60"
ROUGH OPENING 59 1/2"
FRAME SIZE 59"
DAYLIGHT OPENING 56 19/32"

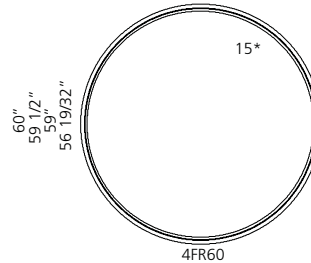

ELEVATION SYMBOL LEGEND:

##* NUMBER INDICATES DESIGN PRESSURE (DP) RATING WITH STANDARD GLAZING.

SCALE: 1/4" = 1'

OCTAGON

UNIT SIZE	24"
ROUGH OPENING	23 1/2"
FRAME SIZE	23"
DAYLIGHT OPENING	20 19/32"

24"
23 1/2"
23"
20 19/32"

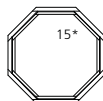

4OCT24

UNIT SIZE	30"
ROUGH OPENING	29 1/2"
FRAME SIZE	29"
DAYLIGHT OPENING	26 19/32"

30"
29 1/2"
29"
26 19/32"

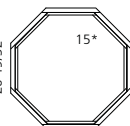

4OCT30

UNIT SIZE	36"
ROUGH OPENING	35 1/2"
FRAME SIZE	35"
DAYLIGHT OPENING	32 19/32"

36"
35 1/2"
35"
32 19/32"

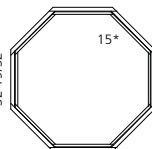

4OCT36

UNIT SIZE	42"
ROUGH OPENING	41 1/2"
FRAME SIZE	41"
DAYLIGHT OPENING	38 19/32"

42"
41 1/2"
41"
38 19/32"

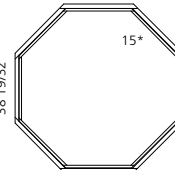

4OCT42

UNIT SIZE	48"
ROUGH OPENING	47 1/2"
FRAME SIZE	47"
DAYLIGHT OPENING	44 19/32"

48"
47 1/2"
47"
44 19/32"

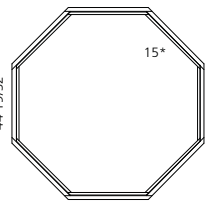

4OCT48

UNIT SIZE	54"
ROUGH OPENING	53 1/2"
FRAME SIZE	53"
DAYLIGHT OPENING	50 19/32"

54"
53 1/2"
53"
50 19/32"

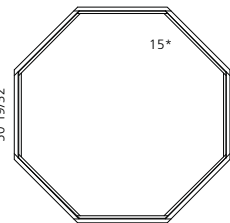

4OCT54

UNIT SIZE	60"
ROUGH OPENING	59 1/2"
FRAME SIZE	59"
DAYLIGHT OPENING	56 19/32"

60"
59 1/2"
59"
56 19/32"

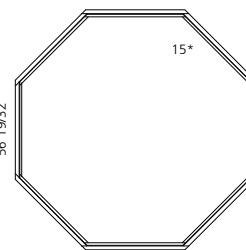

4OCT60

ELEVATION SYMBOL LEGEND:
NUMBER INDICATES DESIGN PRESSURE (DP) RATING WITH STANDARD GLAZING.

FLORIDA QUARTER ROUND

UNIT SIZE
ROUGH OPENING
FRAME SIZE
DAYLIGHT OPENING

19 1/8"
18 5/8"
18 1/8"
15 23/32"

19 1/8"
18 5/8"
18 1/8"
15 23/32"



4QR-1

26 1/2"
26"
25 1/2"
23 3/32"

26 1/2"
26"
25 1/2"
23 3/32"

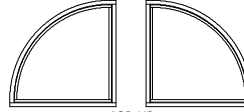

4QR-H3

UNIT SIZE
ROUGH OPENING
FRAME SIZE
DAYLIGHT OPENING

37"
36 1/2"
36"
33 19/32"

37"
36 1/2"
36"
33 19/32"

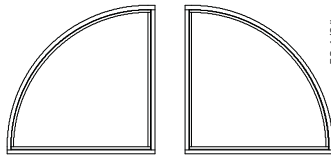

4QR-2

53 1/8"
52 5/8"
52 1/8"
49 23/32"

53 1/8"
52 5/8"
52 1/8"
49 23/32"

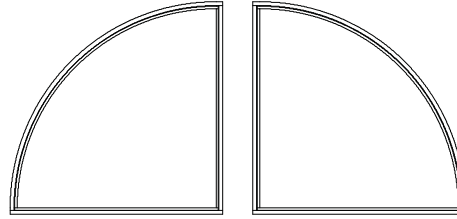

4QR-3

SCALE: 1/4" = 1'

FLORIDA HALF ROUND

UNIT SIZE	19 1/8"	26 1/2"	37"	53 1/8"
ROUGH OPENING	18 5/8"	26"	36 1/2"	52 5/8"
FRAME SIZE	18 1/8"	25 1/2"	36"	52 1/8"
DAYLIGHT OPENING	15 23/32"	23 3/32"	33 19/32"	49 23/32"

9 9/16"
9 1/16"
8 9/16"
6 5/32"



4HR-1

13 1/4"
12 3/4"
12 1/4"
9 27/32"



4HR-H3

18 1/2"
18"
17 1/2"
15 3/32"



4HR-2

26 9/16"
26 1/16"
25 9/16"
23 5/32"

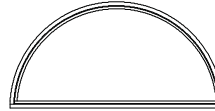

4HR-3

SCALE: 1/4" = 1'

CIRCLE SEGMENT

UNIT SIZE 24"
ROUGH OPENING 23 1/2"
FRAME SIZE 23"
DAYLIGHT OPENING 20 19/32"

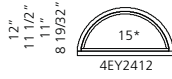

4EY2412

UNIT SIZE 30"
ROUGH OPENING 29 1/2"
FRAME SIZE 29"
DAYLIGHT OPENING 26 19/32"



4EY3015

UNIT SIZE 36"
ROUGH OPENING 35 1/2"
FRAME SIZE 35"
DAYLIGHT OPENING 32 19/32"

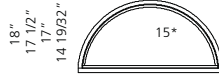

4EY3618

UNIT SIZE 42"
ROUGH OPENING 41 1/2"
FRAME SIZE 41"
DAYLIGHT OPENING 38 19/32"

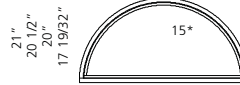

4EY4221

UNIT SIZE 48"
ROUGH OPENING 47 1/2"
FRAME SIZE 47"
DAYLIGHT OPENING 44 19/32"



4EY4824

UNIT SIZE 54"
ROUGH OPENING 53 1/2"
FRAME SIZE 53"
DAYLIGHT OPENING 50 19/32"

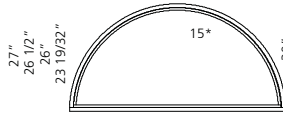

4EY5427

UNIT SIZE 60"
ROUGH OPENING 59 1/2"
FRAME SIZE 59"
DAYLIGHT OPENING 56 19/32"

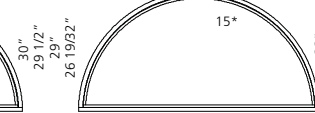

4EY6030

UNIT SIZE 66"
ROUGH OPENING 65 1/2"
FRAME SIZE 65"
DAYLIGHT OPENING 62 19/32"

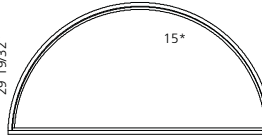

4EY6633

UNIT SIZE 72"
ROUGH OPENING 71 1/2"
FRAME SIZE 71"
DAYLIGHT OPENING 68 19/32"

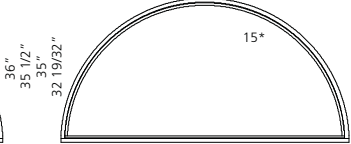

4EY7236

ELEVATION SYMBOL LEGEND:

NUMBER INDICATES DESIGN PRESSURE (DP) RATING WITH STANDARD GLAZING.

SCALE: 1/4" = 1'

EXTENDED QUARTER ROUND

UNIT SIZE	18"	24"	30"	36"	42"	48"	54"
ROUGH OPENING	17 1/2"	23 1/2"	29 1/2"	35 1/2"	41 1/2"	47 1/2"	53 1/2"
FRAME SIZE	17"	23"	29"	35"	41"	47"	53"
DAYLIGHT OPENING	14 19/32"	20 19/32"	26 19/32"	32 19/32"	38 19/32"	44 19/32"	50 19/32"

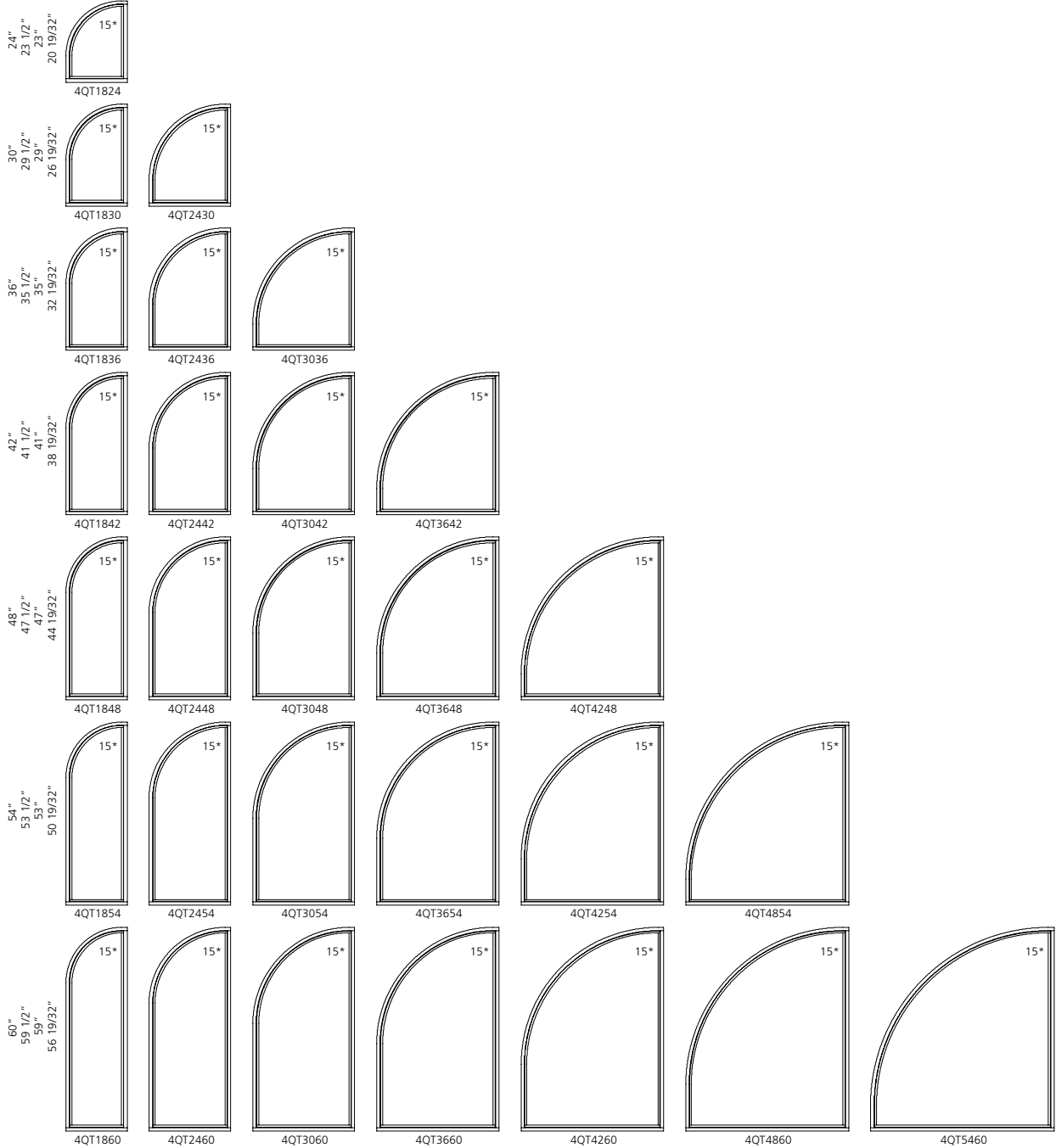

ELEVATION SYMBOL LEGEND:
##* NUMBER INDICATES DESIGN PRESSURE (DP) RATING WITH STANDARD GLAZING.

SCALE: 1/4" = 1'

EXTENDED QUARTER ROUND

UNIT SIZE	18"	24"	30"	36"	42"	48"	54"
ROUGH OPENING	17 1/2"	23 1/2"	29 1/2"	35 1/2"	41 1/2"	47 1/2"	53 1/2"
FRAME SIZE	17"	23"	29"	35"	41"	47"	53"
DAYLIGHT OPENING	14 19/32"	20 19/32"	26 19/32"	32 19/32"	38 19/32"	44 19/32"	50 19/32"

66" 65 1/2" 65" 62 19/32"							
	4QT1866	4QT2466	4QT3066	4QT3666	4QT4266	4QT4866	4QT5466
	72" 71 1/2" 71" 68 19/32"						
4QT1872		4QT2472	4QT3072	4QT3672	4QT4272	4QT4872	4QT5472
76" 75 1/2" 75" 72 19/32"							
	4QT1876	4QT2476	4QT3076	4QT3676	4QT4276	4QT4876	4QT5476

ELEVATION SYMBOL LEGEND:
NUMBER INDICATES DESIGN PRESSURE (DP) RATING WITH STANDARD GLAZING.

SCALE: 1/4" = 1'

EXTENDED QUARTER ROUND

UNIT SIZE	66"
ROUGH OPENING	65 1/2"
FRAME SIZE	65"
DAYLIGHT OPENING	62 19/32"

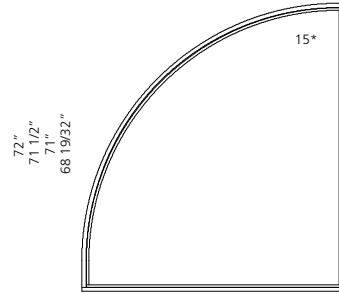

4QT6672

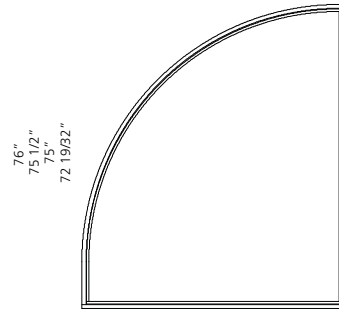

4QT6676







































ELEVATION SYMBOL LEGEND:

NUMBER INDICATES DESIGN PRESSURE (DP) RATING WITH STANDARD GLAZING.

SCALE: 1/4" = 1'

EXTENDED HALF ROUND

UNIT SIZE	24"	30"	36"	42"	48"	54"
ROUGH OPENING	23 1/2"	29 1/2"	35 1/2"	41 1/2"	47 1/2"	53 1/2"
FRAME SIZE	23"	29"	35"	41"	47"	53"
DAYLIGHT OPENING	20 19/32"	26 19/32"	32 19/32"	38 19/32"	44 19/32"	50 19/32"

24" 23 1/2" 23" 20 19/32"	 15* 45L2424	 15* 45L3024	 15* 45L3624			
30" 29 1/2" 29" 26 19/32"	 15* 45L2430	 15* 45L3030	 15* 45L3630	 15* 45L4230	 15* 45L4830	
36" 35 1/2" 35" 32 19/32"	 15* 45L2436	 15* 45L3036	 15* 45L3636	 15* 45L4236	 15* 45L4836	 15* 45L5436
42" 41 1/2" 41" 38 19/32"	 15* 45L2442	 15* 45L3042	 15* 45L3642	 15* 45L4242	 15* 45L4842	 15* 45L5442
48" 47 1/2" 47" 44 19/32"	 15* 45L2448	 15* 45L3048	 15* 45L3648	 15* 45L4248	 15* 45L4848	 15* 45L5448
54" 53 1/2" 53" 50 19/32"	 15* 45L2454	 15* 45L3054	 15* 45L3654	 15* 45L4254	 15* 45L4854	 15* 45L5454
60" 59 1/2" 59" 56 19/32"	 15* 45L2460	 15* 45L3060	 15* 45L3660	 15* 45L4260	 15* 45L4860	 15* 45L5460

ELEVATION SYMBOL LEGEND:
##* NUMBER INDICATES DESIGN PRESSURE (DP) RATING WITH STANDARD GLAZING.

SCALE: 1/4" = 1'

EXTENDED HALF ROUND

UNIT SIZE	24"	30"	36"	42"	48"	54"
ROUGH OPENING	23 1/2"	29 1/2"	35 1/2"	41 1/2"	47 1/2"	53 1/2"
FRAME SIZE	23"	29"	35"	41"	47"	53"
DAYLIGHT OPENING	20 19/32"	26 19/32"	32 19/32"	38 19/32"	44 19/32"	50 19/32"

66" 65 1/2" 65" 62 19/32"						
	4SL2466	4SL3066	4SL3666	4SL4266	4SL4866	4SL5466
	15*	15*	15*	15*	15*	15*
72" 71 1/2" 71" 68 19/32"						
	4SL2472	4SL3072	4SL3672	4SL4272	4SL4872	4SL5472
	15*	15*	15*	15*	15*	15*
76" 75 1/2" 75" 72 19/32"						
	4SL2476	4SL3076	4SL3676	4SL4276	4SL4876	4SL5476
	15*	15*	15*	15*	15*	15*

ELEVATION SYMBOL LEGEND:
NUMBER INDICATES DESIGN PRESSURE (DP) RATING WITH STANDARD GLAZING.

SCALE: 1/4" = 1'

EXTENDED HALF ROUND

UNIT SIZE
ROUGH OPENING
FRAME SIZE
DAYLIGHT OPENING

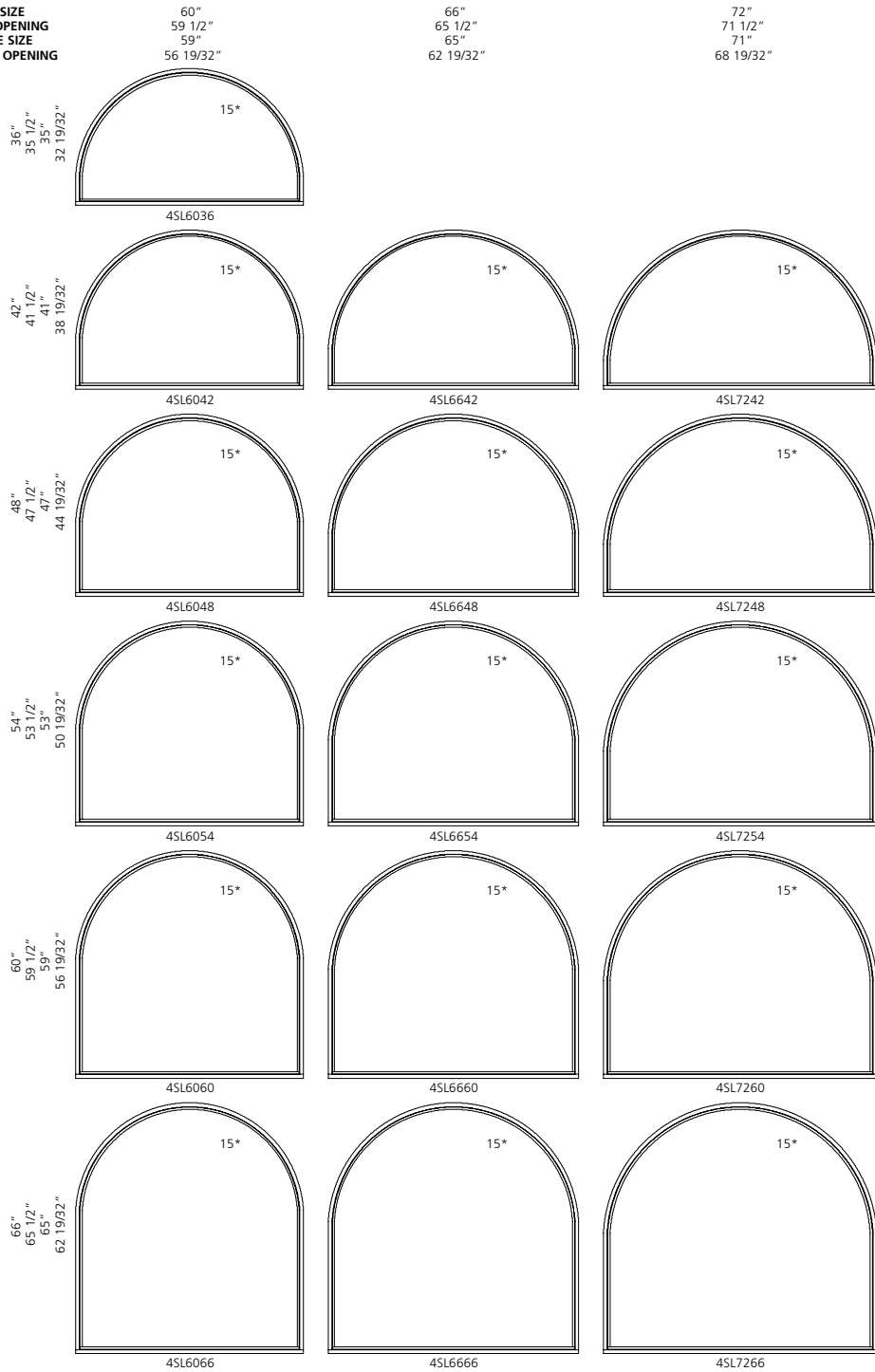

ELEVATION SYMBOL LEGEND:
###* NUMBER INDICATES DESIGN PRESSURE (DP) RATING WITH STANDARD GLAZING.

SCALE: 1/4" = 1'

EXTENDED HALF ROUND

UNIT SIZE
ROUGH OPENING
FRAME SIZE
DAYLIGHT OPENING

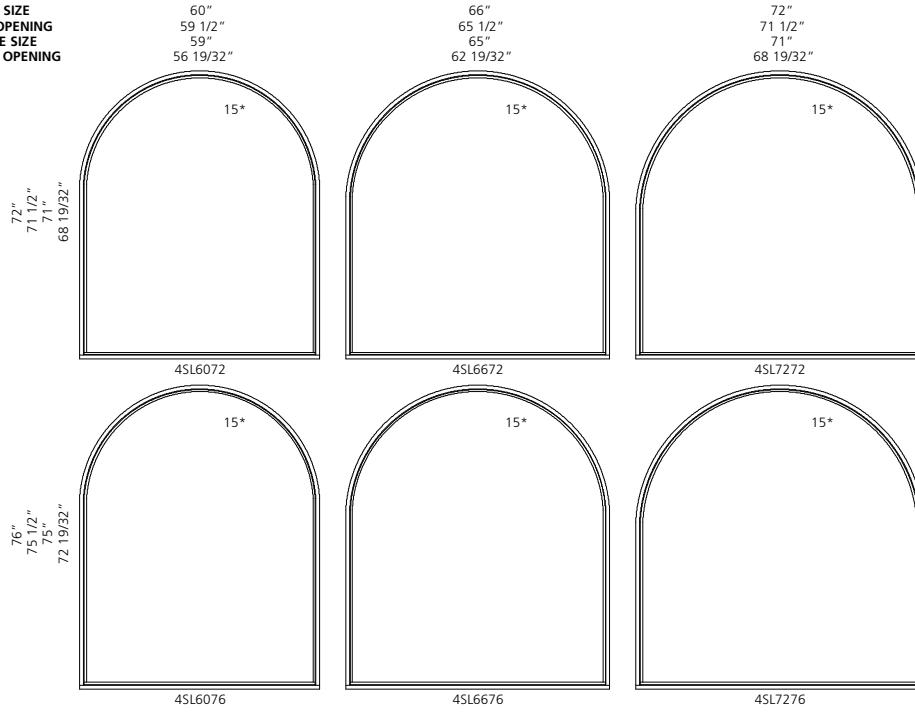

ELEVATION SYMBOL LEGEND:

NUMBER INDICATES DESIGN PRESSURE (DP) RATING WITH STANDARD GLAZING.

SCALE: 1/4" = 1'

EXTENDED QUARTER SEGMENT

UNIT SIZE	18"	24"	30"	36"	42"	48"	54"
ROUGH OPENING	17 1/2"	23 1/2"	29 1/2"	35 1/2"	41 1/2"	47 1/2"	53 1/2"
FRAME SIZE	17"	23"	29"	35"	41"	47"	53"
DAYLIGHT OPENING	14 19/32"	20 19/32"	26 19/32"	32 19/32"	38 19/32"	44 19/32"	50 19/32"
18" 17 1/2" 17" 14 19/32"	15*	15*	15*	15*	15*	15*	15*
24" 23 1/2" 23" 20 19/32"	15*	15*	15*	15*	15*	15*	15*
30" 29 1/2" 29" 26 19/32"	15*	15*	15*	15*	15*	15*	15*
36" 35 1/2" 35" 32 19/32"	15*	15*	15*	15*	15*	15*	15*
42" 41 1/2" 41" 38 19/32"	15*	15*	15*	15*	15*	15*	15*
48" 47 1/2" 47" 44 19/32"	15*	15*	15*	15*	15*	15*	15*
54" 53 1/2" 53" 50 19/32"	15*	15*	15*	15*	15*	15*	15*
60" 59 1/2" 59" 56 19/32"	15*	15*	15*	15*	15*	15*	15*

ELEVATION SYMBOL LEGEND:
NUMBER INDICATES DESIGN PRESSURE (DP) RATING WITH STANDARD GLAZING.

SCALE: 1/4" = 1'

EXTENDED QUARTER SEGMENT

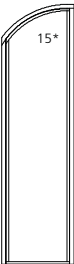
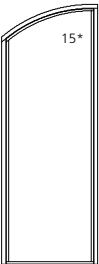
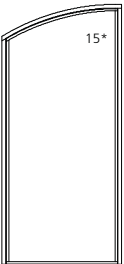
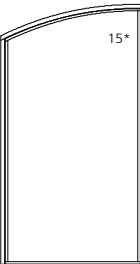
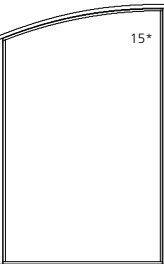
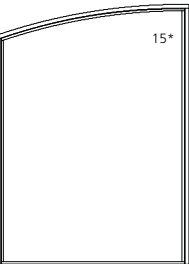
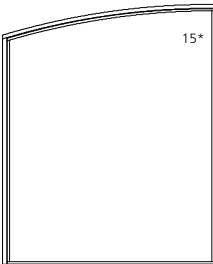
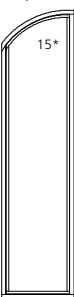
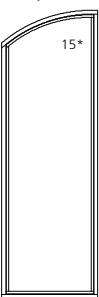
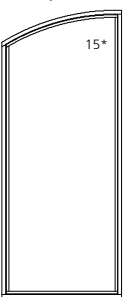
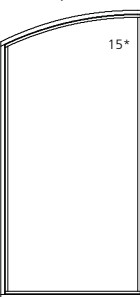
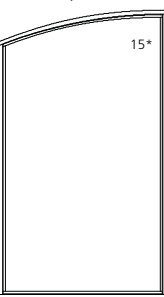
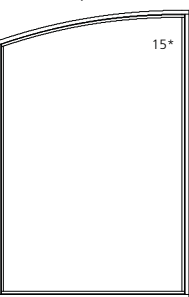
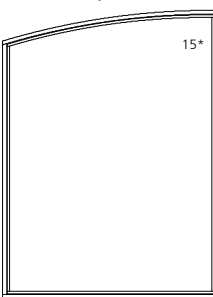
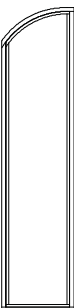
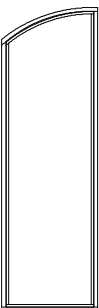
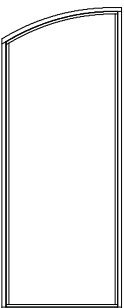
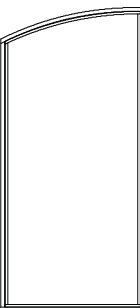
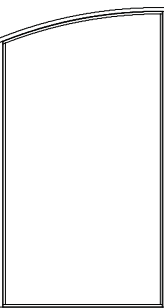
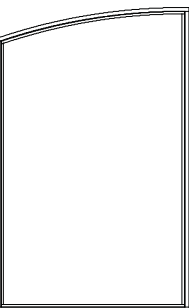
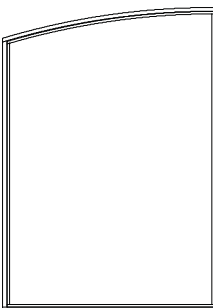
	18"	24"	30"	36"	42"	48"	54"
UNIT SIZE	18"	24"	30"	36"	42"	48"	54"
ROUGH OPENING	17 1/2"	23 1/2"	29 1/2"	35 1/2"	41 1/2"	47 1/2"	53 1/2"
FRAME SIZE	17"	23"	29"	35"	41"	47"	53"
DAYLIGHT OPENING	14 19/32"	20 19/32"	26 19/32"	32 19/32"	38 19/32"	44 19/32"	50 19/32"
	 4QP1866	 4QP2466	 4QP3066	 4QP3666	 4QP4266	 4QP4866	 4QP5466
	 4QP1872	 4QP2472	 4QP3072	 4QP3672	 4QP4272	 4QP4872	 4QP5472
	 4QP1876	 4QP2476	 4QP3076	 4QP3676	 4QP4276	 4QP4876	 4QP5476

ELEVATION SYMBOL LEGEND:
 ### NUMBER INDICATES DESIGN PRESSURE (DP) RATING WITH STANDARD GLAZING.

SCALE: 1/4" = 1'

EXTENDED QUARTER SEGMENT

UNIT SIZE ROUGH OPENING FRAME SIZE DAYLIGHT OPENING	60" 59 1/2" 59" 56 19/32"	66" 65 1/2" 65" 62 19/32"	72" 71 1/2" 71" 68 19/32"
18" 17 1/2" 17" 14 19/32"	4QP6018 15*	4QP6618 15*	4QP7218 15*
24" 23 1/2" 23" 20 19/32"	4QP6024 15*	4QP6624 15*	4QP7224 15*
30" 29 1/2" 29" 26 19/32"	4QP6030 15*	4QP6630 15*	4QP7230 15*
36" 35 1/2" 35" 32 19/32"	4QP6036 15*	4QP6636 15*	4QP7236 15*
42" 41 1/2" 41" 38 19/32"	4QP6042 15*	4QP6642 15*	4QP7242 15*
48" 47 1/2" 47" 44 19/32"	4QP6048 15*	4QP6648 15*	4QP7248 15*
54" 53 1/2" 53" 50 19/32"	4QP6054 15*	4QP6654 15*	4QP7254 15*
60" 59 1/2" 59" 56 19/32"	4QP6060 15*	4QP6660 15*	4QP7260 15*

ELEVATION SYMBOL LEGEND:
##* NUMBER INDICATES DESIGN PRESSURE (DP) RATING WITH STANDARD GLAZING.

SCALE: 1/4" = 1'

EXTENDED QUARTER SEGMENT



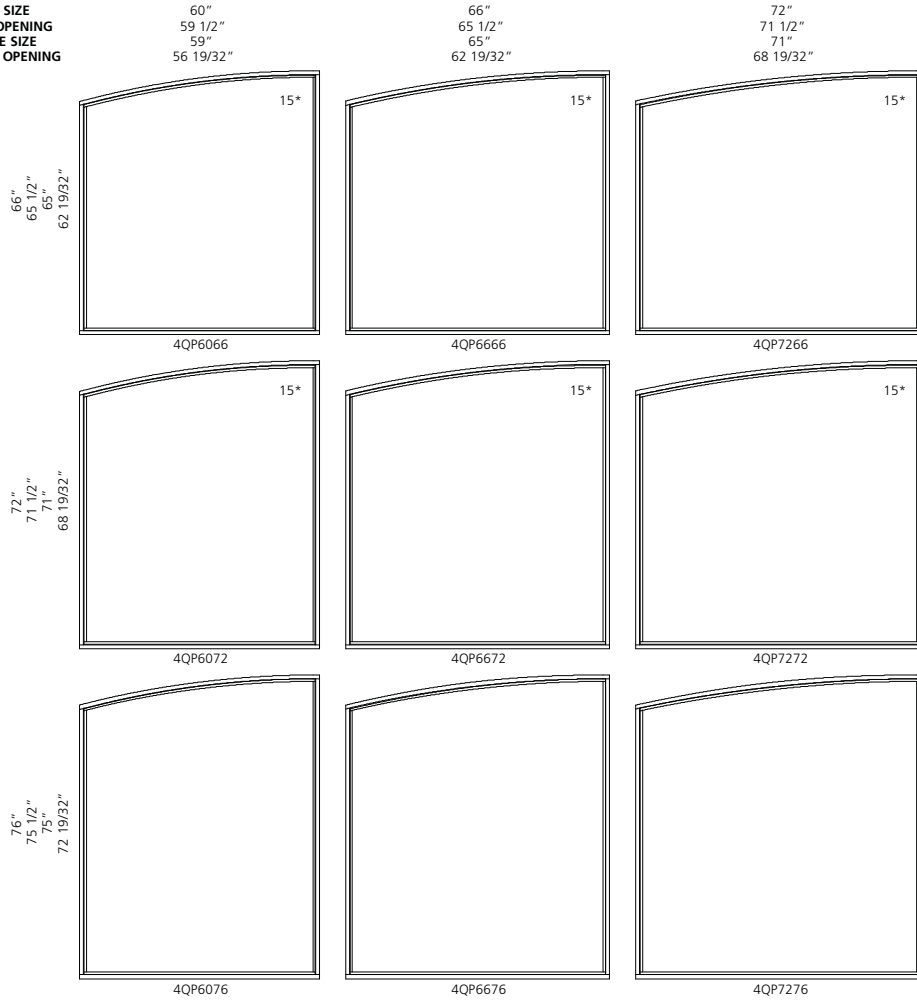















































UNIT SIZE
ROUGH OPENING
FRAME SIZE
DAYLIGHT OPENING



ELEVATION SYMBOL LEGEND:
NUMBER INDICATES DESIGN PRESSURE (DP) RATING WITH STANDARD GLAZING.

SCALE: 1/4" = 1'

EXTENDED CIRCLE SEGMENT

UNIT SIZE	18"	24"	30"	36"	42"	48"	54"
ROUGH OPENING	17 1/2"	23 1/2"	29 1/2"	35 1/2"	41 1/2"	47 1/2"	53 1/2"
FRAME SIZE	17"	23"	29"	35"	41"	47"	53"
DAYLIGHT OPENING	14 19/32"	20 19/32"	26 19/32"	32 19/32"	38 19/32"	44 19/32"	50 19/32"
18" 17 1/2" 17" 14 19/32"	 15* 4LP1818	 15* 4LP2418	 15* 4LP3018				
24" 23 1/2" 23" 20 19/32"	 15* 4LP1824	 15* 4LP2424	 15* 4LP3024	 15* 4LP3624	 15* 4LP4224		
30" 29 1/2" 29" 26 19/32"	 15* 4LP1830	 15* 4LP2430	 15* 4LP3030	 15* 4LP3630	 15* 4LP4230	 15* 4LP4830	 15* 4LP5430
36" 35 1/2" 35" 32 19/32"	 15* 4LP1836	 15* 4LP2436	 15* 4LP3036	 15* 4LP3636	 15* 4LP4236	 15* 4LP4836	 15* 4LP5436
42" 41 1/2" 41" 38 19/32"	 15* 4LP1842	 15* 4LP2442	 15* 4LP3042	 15* 4LP3642	 15* 4LP4242	 15* 4LP4842	 15* 4LP5442
48" 47 1/2" 47" 44 19/32"	 15* 4LP1848	 15* 4LP2448	 15* 4LP3048	 15* 4LP3648	 15* 4LP4248	 15* 4LP4848	 15* 4LP5448
54" 53 1/2" 53" 50 19/32"	 15* 4LP1854	 15* 4LP2454	 15* 4LP3054	 15* 4LP3654	 15* 4LP4254	 15* 4LP4854	 15* 4LP5454
60" 59 1/2" 59" 56 19/32"	 15* 4LP1860	 15* 4LP2460	 15* 4LP3060	 15* 4LP3660	 15* 4LP4260	 15* 4LP4860	 15* 4LP5460

ELEVATION SYMBOL LEGEND:
NUMBER INDICATES DESIGN PRESSURE (DP) RATING WITH STANDARD GLAZING.

SCALE: 1/4" = 1'

EXTENDED CIRCLE SEGMENT

UNIT SIZE	18"	24"	30"	36"	42"	48"	54"
ROUGH OPENING	17 1/2"	23 1/2"	29 1/2"	35 1/2"	41 1/2"	47 1/2"	53 1/2"
FRAME SIZE	17"	23"	29"	35"	41"	47"	53"
DAYLIGHT OPENING	14 19/32"	20 19/32"	26 19/32"	32 19/32"	38 19/32"	44 19/32"	50 19/32"

66" 65 1/2" 65" 62 19/32"							
	15*	15*	15*	15*	15*	15*	15*
	4LP1866	4LP2466	4LP3066	4LP3666	4LP4266	4LP4866	4LP5466
72" 71 1/2" 71" 68 19/32"							
	15*	15*	15*	15*	15*	15*	15*
	4LP1872	4LP2472	4LP3072	4LP3672	4LP4272	4LP4872	4LP5472

ELEVATION SYMBOL LEGEND:
NUMBER INDICATES DESIGN PRESSURE (DP) RATING WITH STANDARD GLAZING.

SCALE: 1/4" = 1'

EXTENDED CIRCLE SEGMENT

UNIT SIZE
ROUGH OPENING
FRAME SIZE
DAYLIGHT OPENING

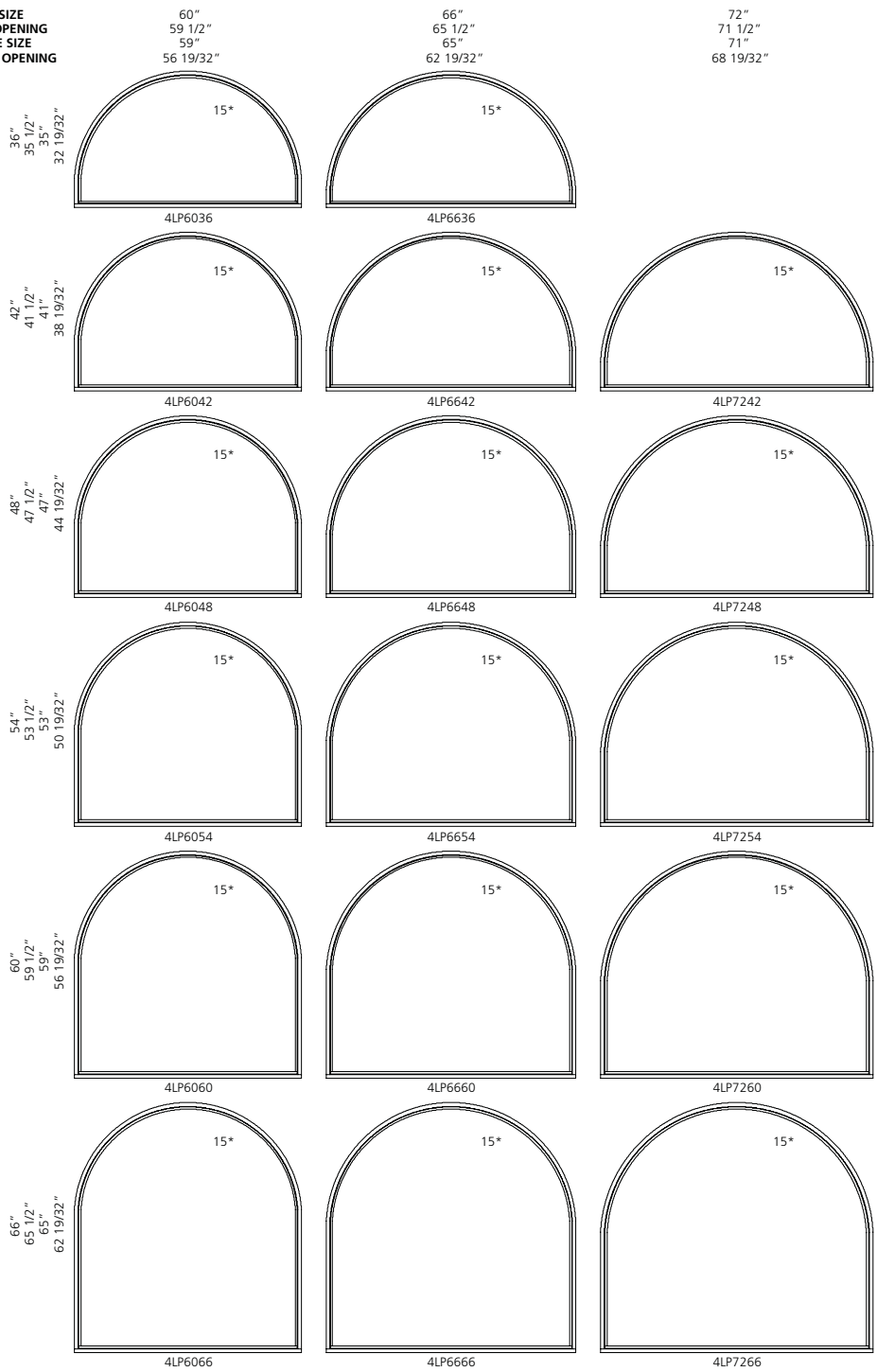

ELEVATION SYMBOL LEGEND:
##* NUMBER INDICATES DESIGN PRESSURE (DP) RATING WITH STANDARD GLAZING.

SCALE: 1/4" = 1'

EXTENDED CIRCLE SEGMENT



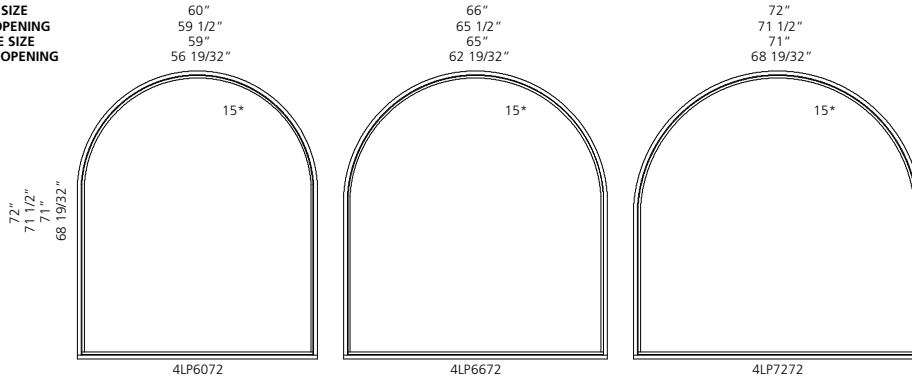







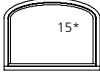



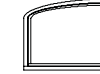
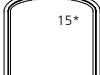





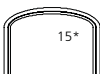



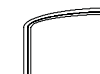
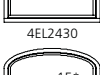











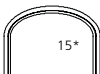







UNIT SIZE
ROUGH OPENING
FRAME SIZE
DAYLIGHT OPENING



ELEVATION SYMBOL LEGEND:
NUMBER INDICATES DESIGN PRESSURE (DP) RATING WITH STANDARD GLAZING.

SCALE: 1/4" = 1'

ELLIPSE TOP

UNIT SIZE	24"	30"	36"	42"	48"	54"
ROUGH OPENING	23 1/2"	29 1/2"	35 1/2"	41 1/2"	47 1/2"	53 1/2"
FRAME SIZE	23"	29"	35"	41"	47"	53"
DAYLIGHT OPENING	20 19/32"	26 19/32"	32 19/32"	38 19/32"	44 19/32"	50 19/32"
18" 17 1/2" 17" 14 19/32"	 4EL2418	 4EL3018	 4EL3618	 4EL4218	 4EL4818	 4EL5418
24" 23 1/2" 23" 20 19/32"	 4EL2424	 4EL3024	 4EL3624	 4EL4224	 4EL4824	 4EL5424
30" 29 1/2" 29" 26 19/32"	 4EL2430	 4EL3030	 4EL3630	 4EL4230	 4EL4830	 4EL5430
36" 35 1/2" 35" 32 19/32"	 4EL2436	 4EL3036	 4EL3636	 4EL4236	 4EL4836	 4EL5436
42" 41 1/2" 41" 38 19/32"	 4EL2442	 4EL3042	 4EL3642	 4EL4242	 4EL4842	 4EL5442
48" 47 1/2" 47" 44 19/32"	 4EL2448	 4EL3048	 4EL3648	 4EL4248	 4EL4848	 4EL5448
54" 53 1/2" 53" 50 19/32"	 4EL2454	 4EL3054	 4EL3654	 4EL4254	 4EL4854	 4EL5454
60" 59 1/2" 59" 56 19/32"	 4EL2460	 4EL3060	 4EL3660	 4EL4260	 4EL4860	 4EL5460

ELEVATION SYMBOL LEGEND:
 ##* NUMBER INDICATES DESIGN PRESSURE (DP) RATING WITH STANDARD GLAZING.

SCALE: 1/4" = 1'

ELLIPSE TOP

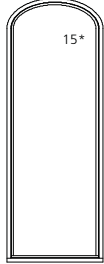
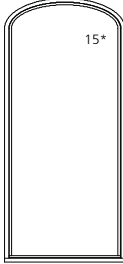
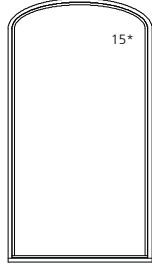
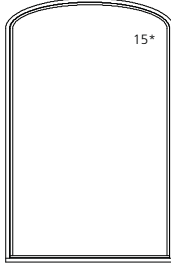
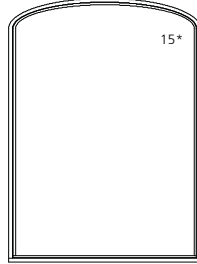
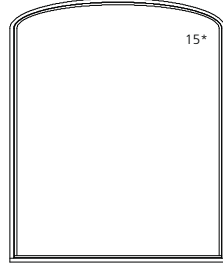
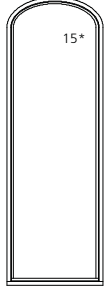
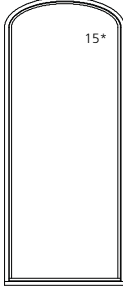
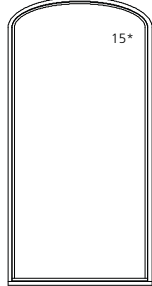
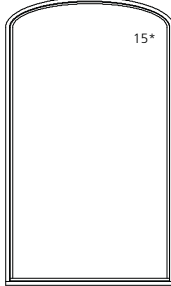
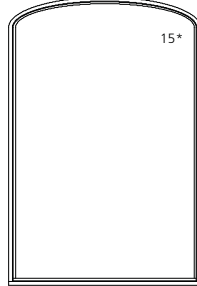
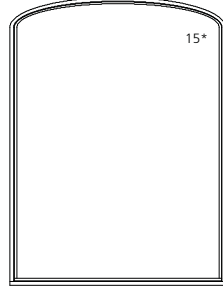
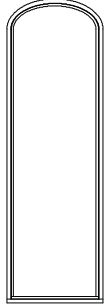
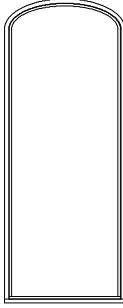
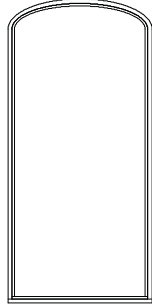
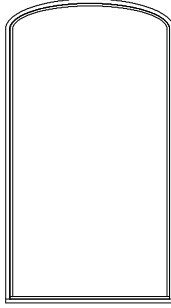
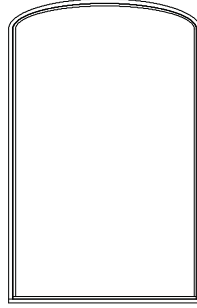
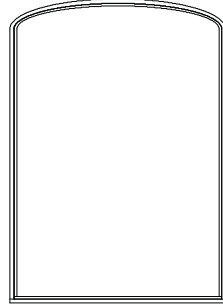
UNIT SIZE	24"	30"	36"	42"	48"	54"		
ROUGH OPENING	23 1/2"	29 1/2"	35 1/2"	41 1/2"	47 1/2"	53 1/2"		
FRAME SIZE	23"	29"	35"	41"	47"	53"		
DAYLIGHT OPENING	20 19/32"	26 19/32"	32 19/32"	38 19/32"	44 19/32"	50 19/32"		
66" 65 1/2" 65" 62 19/32"								
	4EL2466	4EL3066	4EL3666	4EL4266	4EL4866	4EL5466		
	72" 71 1/2" 71" 68 19/32"							
		4EL2472	4EL3072	4EL3672	4EL4272	4EL4872	4EL5472	
		76" 75 1/2" 75" 72 19/32"						
			4EL2476	4EL3076	4EL3676	4EL4276	4EL4876	4EL5476

ELEVATION SYMBOL LEGEND:
##* NUMBER INDICATES DESIGN PRESSURE (DP) RATING WITH STANDARD GLAZING.

SCALE: 1/4" = 1'

ELLIPSE TOP

UNIT SIZE ROUGH OPENING FRAME SIZE DAYLIGHT OPENING	60" 59 1/2" 59" 56 19/32"	66" 65 1/2" 65" 62 19/32"	72" 71 1/2" 71" 68 19/32"
18" 17 1/2" 17" 14 19/32"	4EL6018 15*	4EL6618 15*	4EL7218 15*
24" 23 1/2" 23" 20 19/32"	4EL6024 15*	4EL6624 15*	4EL7224 15*
30" 29 1/2" 29" 26 19/32"	4EL6030 15*	4EL6630 15*	4EL7230 15*
36" 35 1/2" 35" 32 19/32"	4EL6036 15*	4EL6636 15*	4EL7236 15*
42" 41 1/2" 41" 38 19/32"	4EL6042 15*	4EL6642 15*	4EL7242 15*
48" 47 1/2" 47" 44 19/32"	4EL6048 15*	4EL6648 15*	4EL7248 15*
54" 53 1/2" 53" 50 19/32"	4EL6054 15*	4EL6654 15*	4EL7254 15*
60" 59 1/2" 59" 56 19/32"	4EL6060 15*	4EL6660 15*	4EL7260 15*

ELEVATION SYMBOL LEGEND:
NUMBER INDICATES DESIGN PRESSURE (DP) RATING WITH STANDARD GLAZING.

SCALE: 1/4" = 1'

ELLIPSE TOP

UNIT SIZE
ROUGH OPENING
FRAME SIZE
DAYLIGHT OPENING

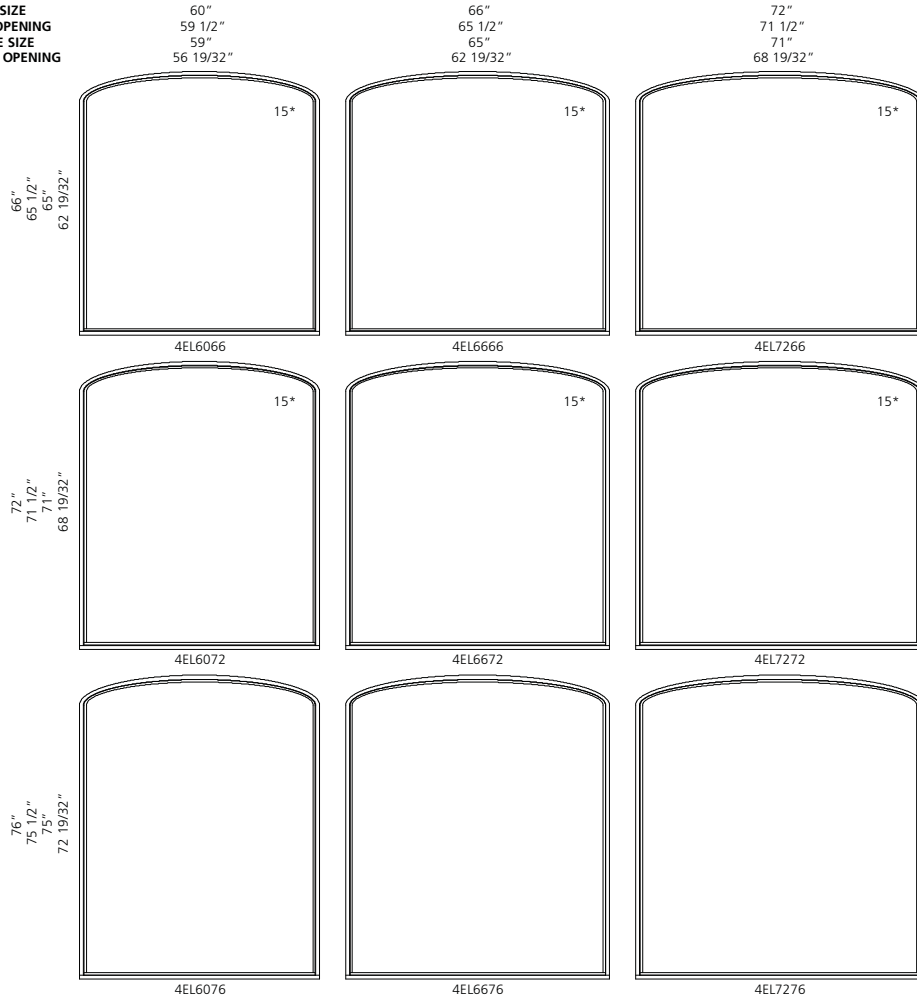

ELEVATION SYMBOL LEGEND:
###* NUMBER INDICATES DESIGN PRESSURE (DP) RATING WITH STANDARD GLAZING.

SCALE: 1/4" = 1'

GRILLE PATTERNS

QUARTER ROUND

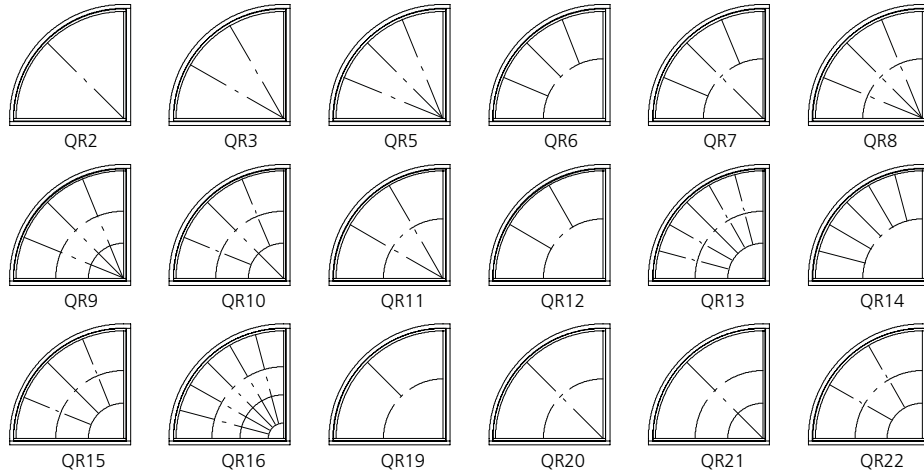

HALF ROUND

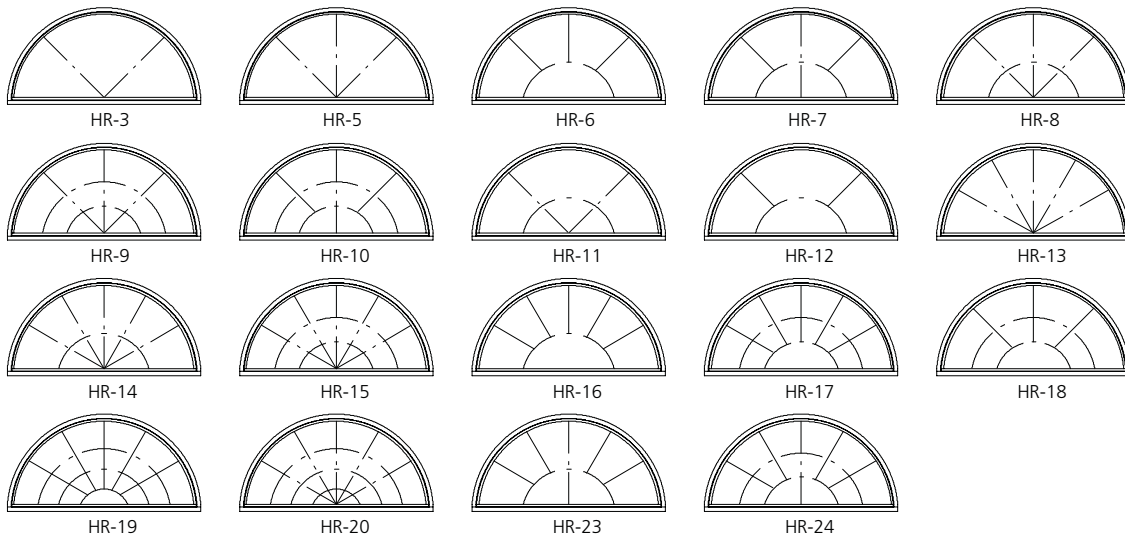

FULL ROUND

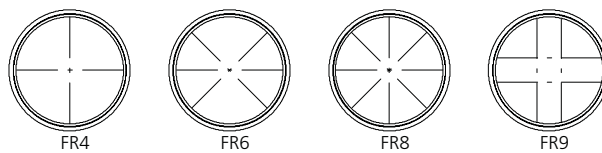

GRILLE PATTERNS

**EXTENDED
QUARTER ROUND**

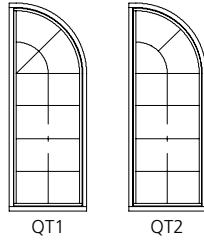

QT1

QT2

**EXTENDED
HALF ROUND**

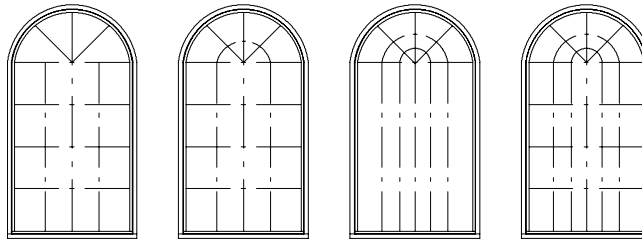

RT1

RT2

RT3

RT4

**EXTENDED
CIRCLE SEGMENT**

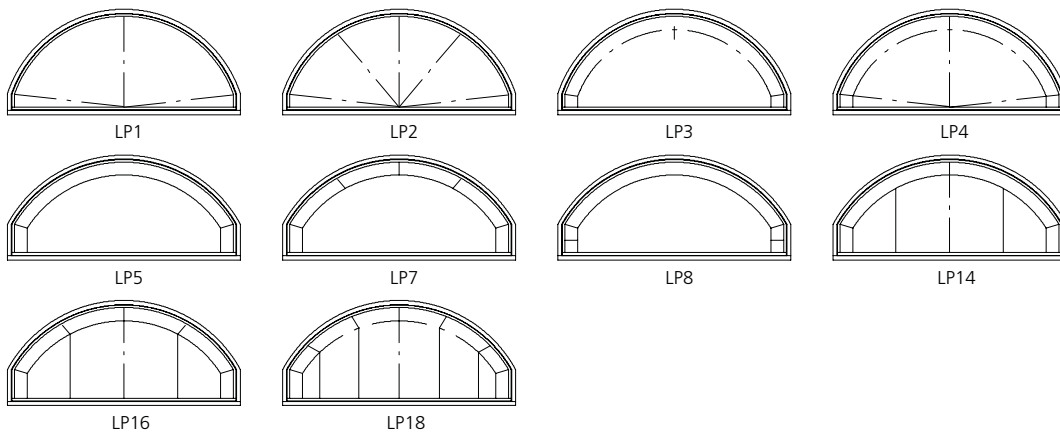

LP1

LP2

LP3

LP4

LP5

LP7

LP8

LP14

LP16

LP18

**PICTURE UNIT
FLANGE**

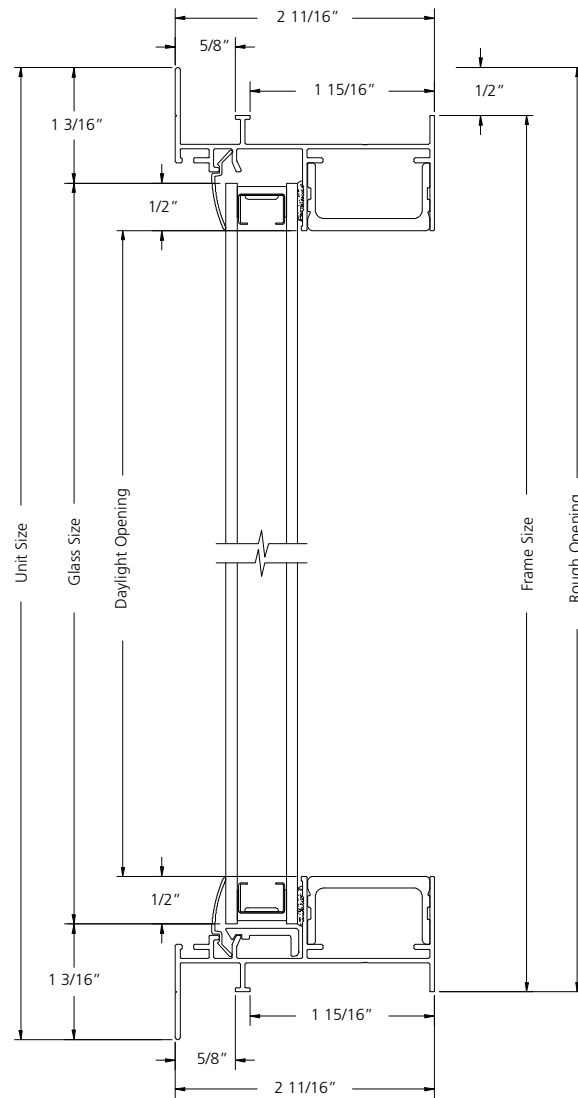

VERTICAL SECTION

SCALE: 6" = 1'

**PICTURE UNIT
FLANGE**

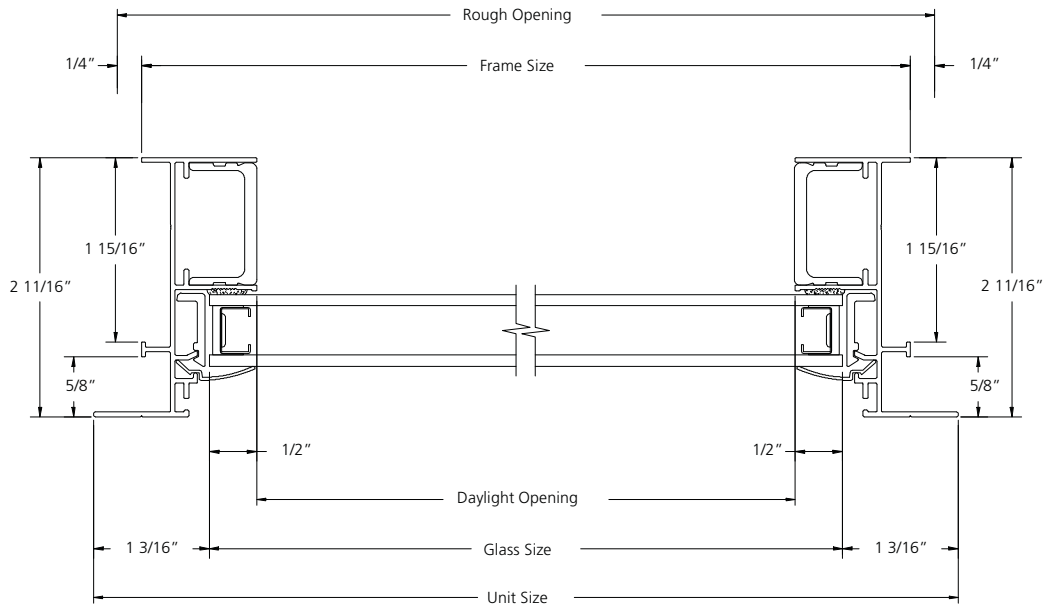

HORIZONTAL SECTION

SCALE: 6" = 1'

PICTURE UNIT
NAIL FIN

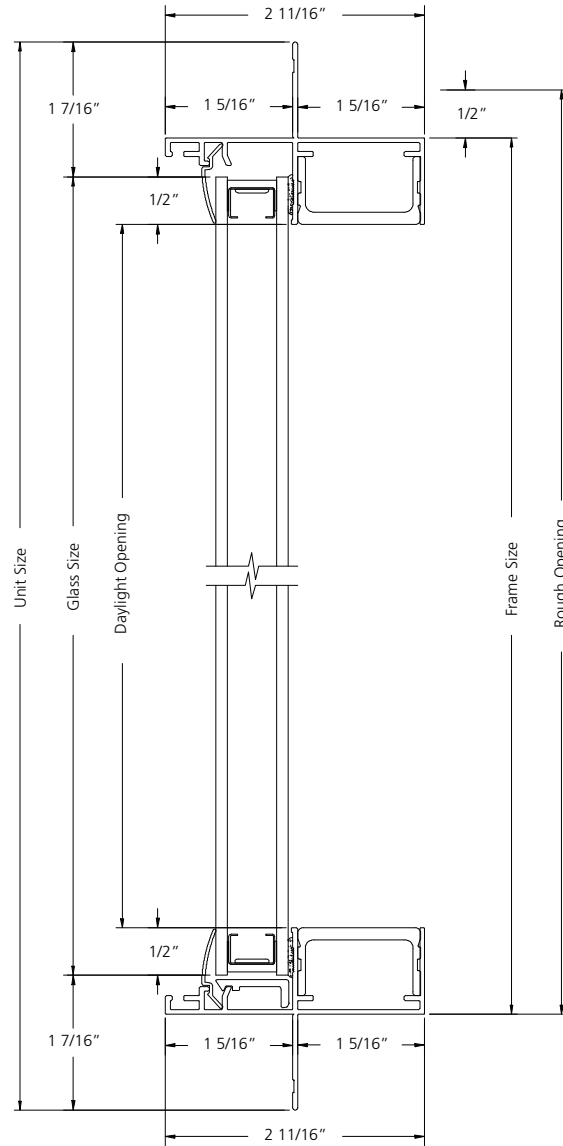

VERTICAL SECTION

SCALE: 6" = 1'

**PICTURE UNIT
NAIL FIN**

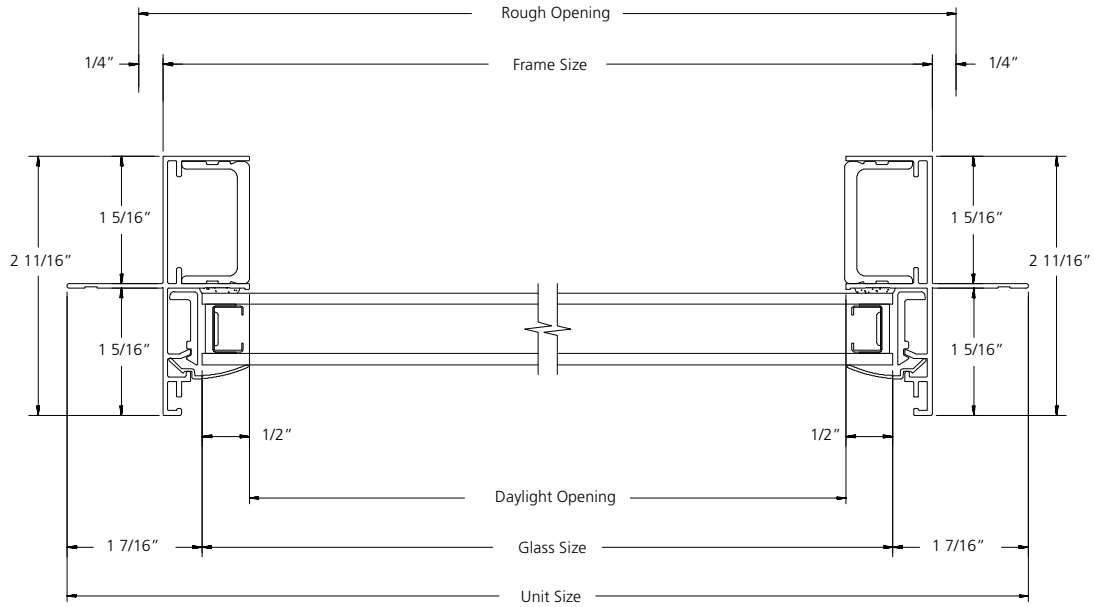

HORIZONTAL SECTION

SCALE: 6" = 1'

PICTURE UNIT
SLIP ON NAIL FIN

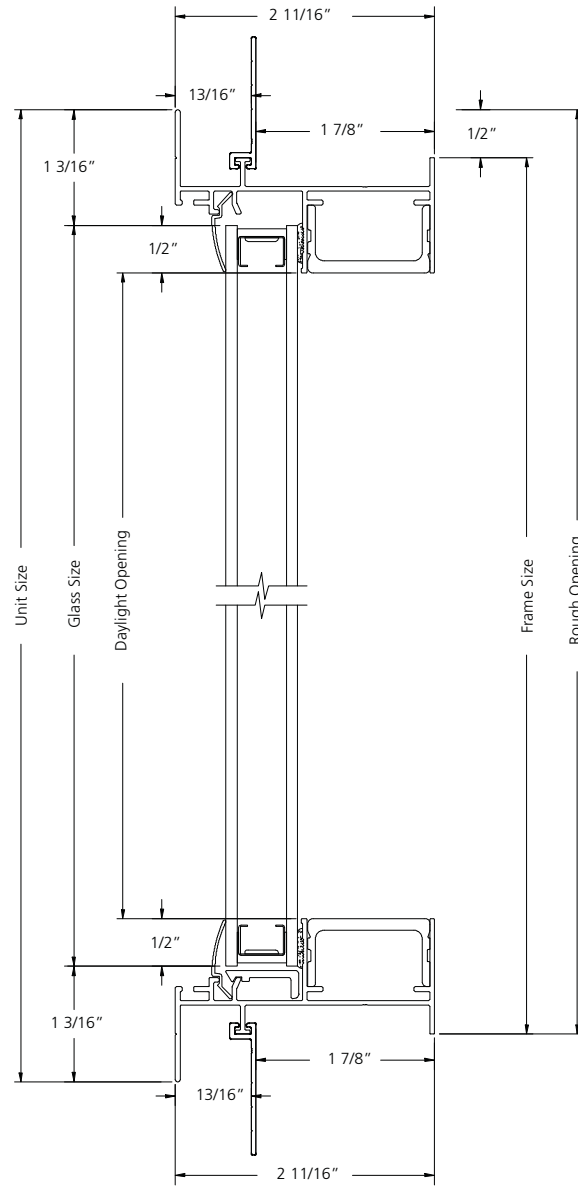

VERTICAL SECTION

SCALE: 6" = 1'

**PICTURE UNIT
SLIP ON NAIL FIN**

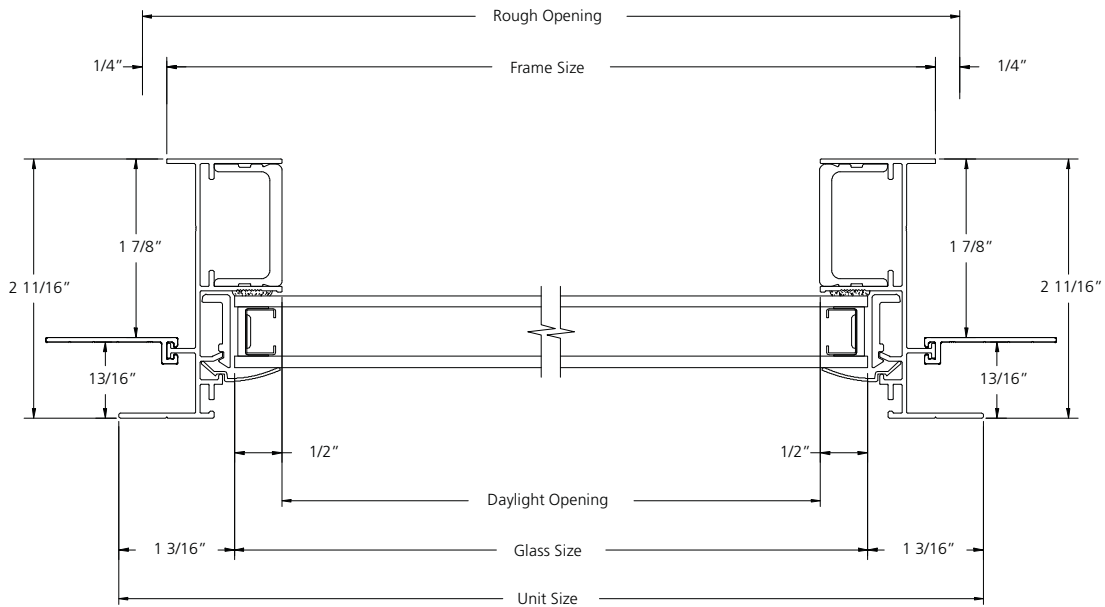

HORIZONTAL SECTION

SCALE: 6" = 1'

INSTALLATION WALL DETAIL
CMU

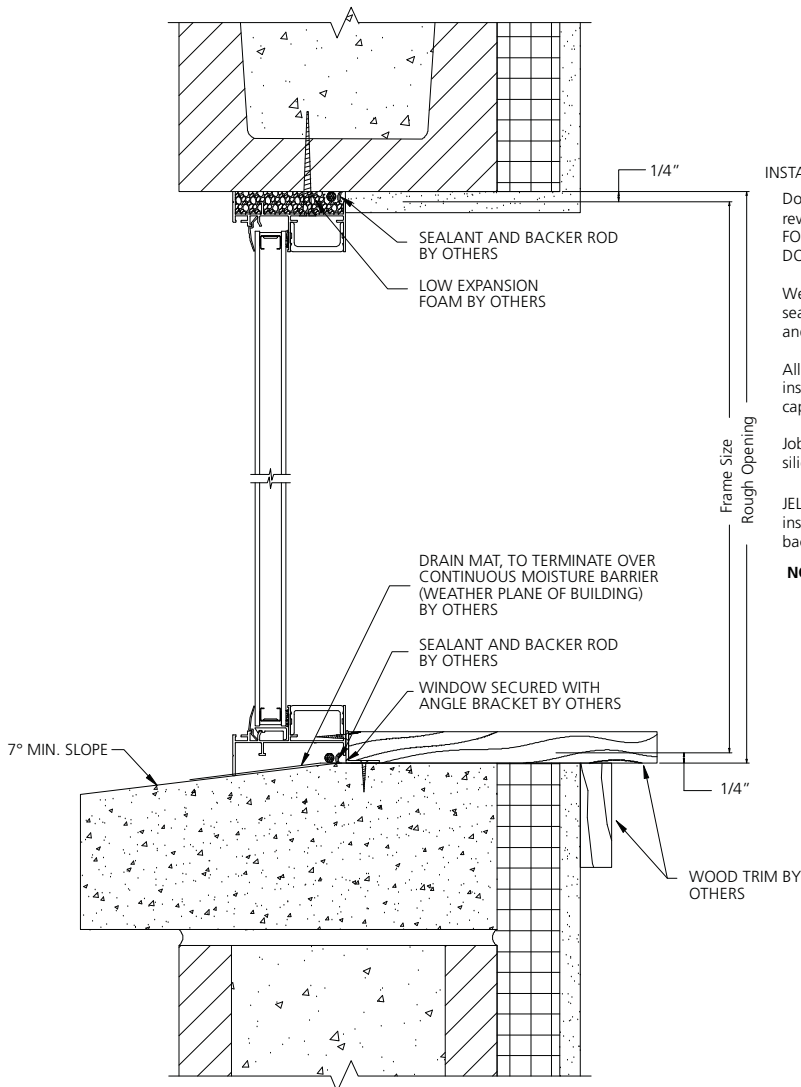

INSTALLATION:

Doors and windows to be installed per latest revision of ASTM E2112. STANDARD PRACTICE FOR INSTALLATION OF EXTERIOR WINDOWS, DOORS AND SKYLIGHTS.

Weather plane flashing must provide a continuous seal between weather plane of fenestration product and weather plane of wall system.

All metal to metal joints must be sealed after installation, this includes, but is not limited to drip caps and mullion covers.

Job site "Frame to Frame" Mull joints must be silicon sealed between frames.

JELD-WEN recommends all window products be installed with a sill pan or equivalent must include back dam and side dams @ 7/8".

NOTE: Please refer to the JELD-WEN web site for installation instructions at: www.jeld-wen.com

VERTICAL SECTION

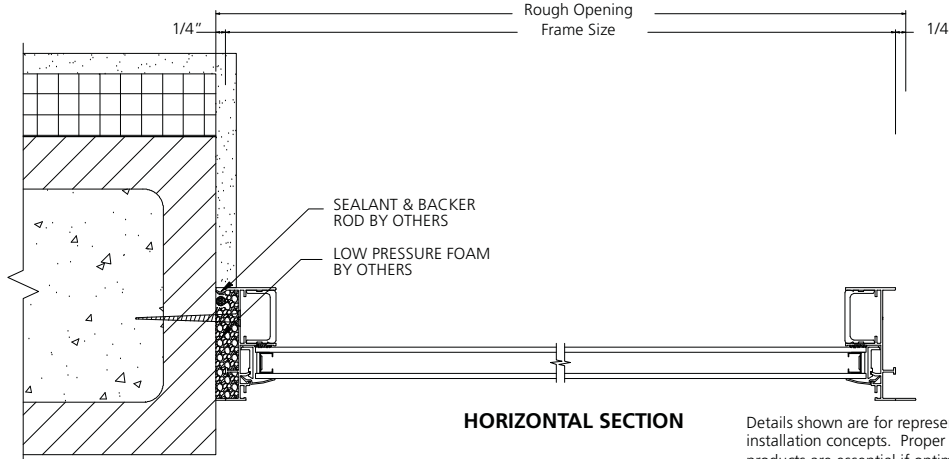

HORIZONTAL SECTION

Details shown are for representation only and intended to reflect basic installation concepts. Proper installation and maintenance of JELD-WEN products are essential if optimum performance is to be fully attained. Written installation instructions that provide guidelines are available on our website at www.jeld-wen.com/resources.

INSTALLATION WALL DETAIL
LAP SIDING

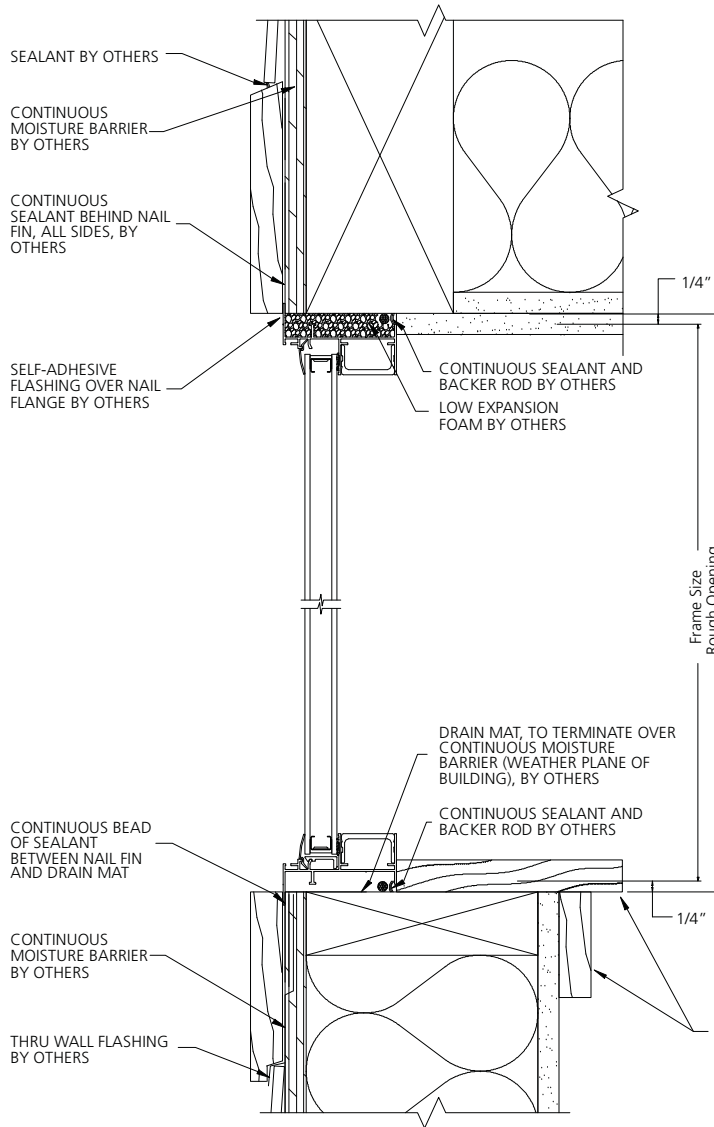

VERTICAL SECTION

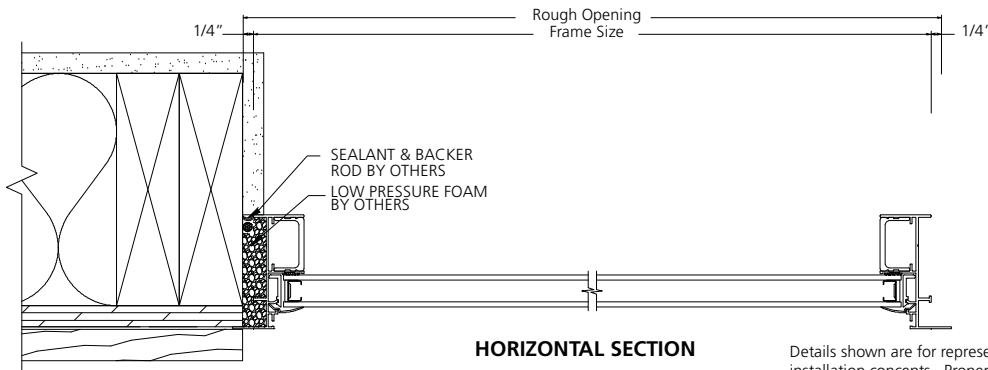

HORIZONTAL SECTION

INSTALLATION:

Doors and windows to be installed per latest revision of ASTM E2112. STANDARD PRACTICE FOR INSTALLATION OF EXTERIOR WINDOWS, DOORS AND SKYLIGHTS.

Weather plane flashing must provide a continuous seal between weather plane of fenestration product and weather plane of wall system.

All metal to metal joints must be sealed after installation, this includes, but is not limited to drip caps and mullion covers.

Job site "Frame to Frame" Mull joints must be silicon sealed between frames.

JELD-WEN recommends all window products be installed with a sill pan or equivalent must include back dam and side dams @ 7/8".

NOTE: Please refer to the JELD-WEN web site for installation instructions at: www.jeld-wen.com

Details shown are for representation only and intended to reflect basic installation concepts. Proper installation and maintenance of JELD-WEN products are essential if optimum performance is to be fully attained. Written installation instructions that provide guidelines are available on our website at www.jeld-wen.com/resources.

INSTALLATION WALL DETAIL
STUCCO

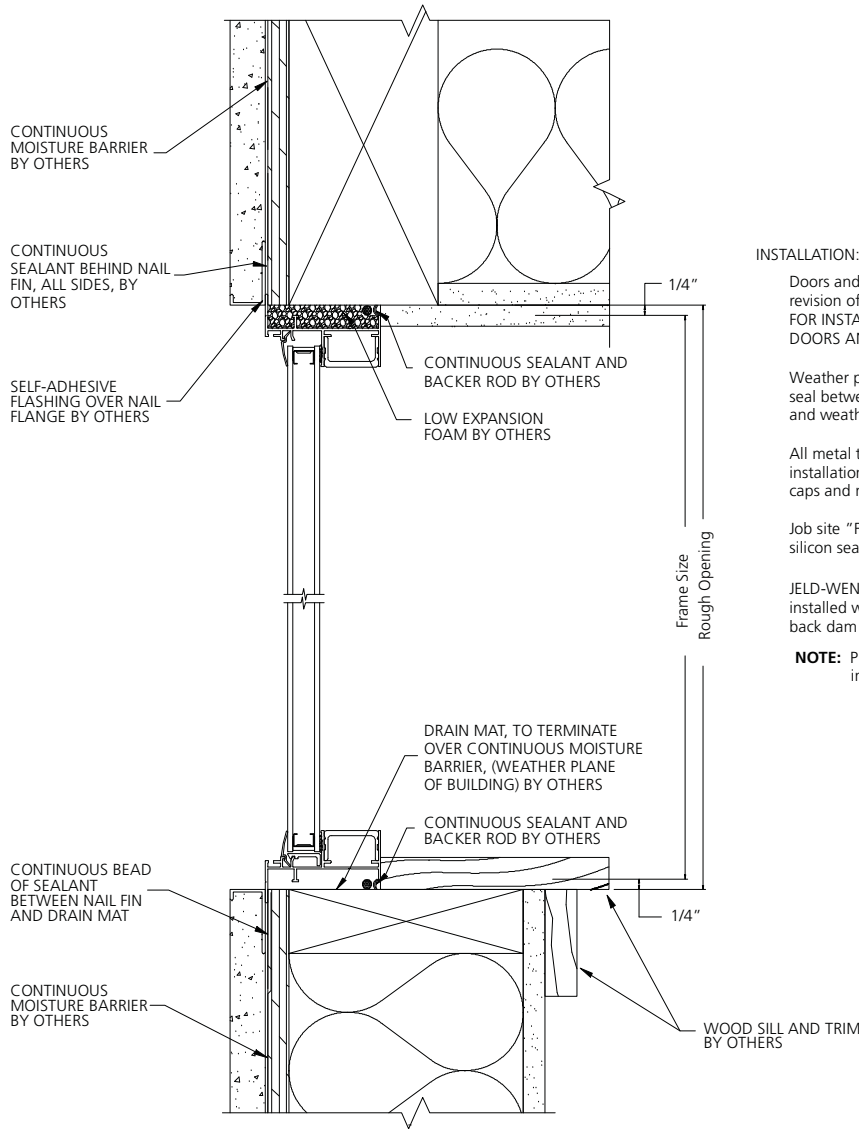

VERTICAL SECTION

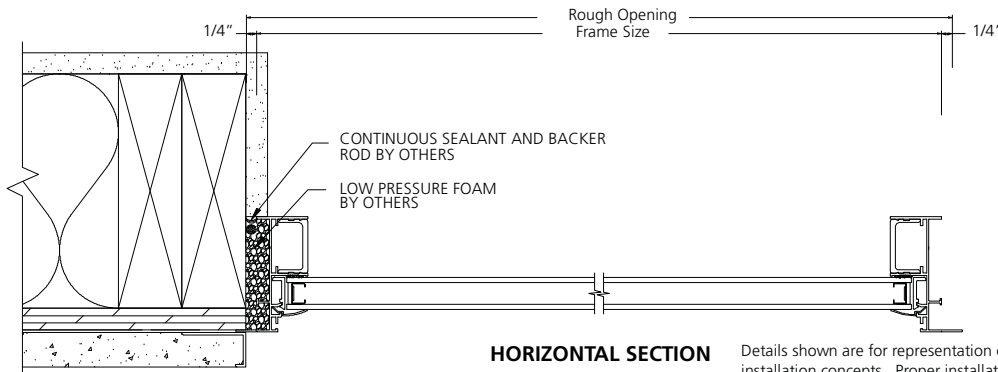

HORIZONTAL SECTION

INSTALLATION:

Doors and windows to be installed per latest revision of ASTM E2112. STANDARD PRACTICE FOR INSTALLATION OF EXTERIOR WINDOWS, DOORS AND SKYLIGHTS.

Weather plane flashing must provide a continuous seal between weather plane of fenestration product and weather plane of wall system.

All metal to metal joints must be sealed after installation, this includes, but is not limited to drip caps and mullion covers.

Job site "Frame to Frame" Mull joints must be silicon sealed between frames.

JELD-WEN recommends all window products be installed with a sill pan or equivalent must include back dam and side dams @ 7/8".

NOTE: Please refer to the JELD-WEN web site for installation instructions at: www.jeld-wen.com

Details shown are for representation only and intended to reflect basic installation concepts. Proper installation and maintenance of JELD-WEN products are essential if optimum performance is to be fully attained. Written installation instructions that provide guidelines are available on our website at www.jeld-wen.com/resources.