TABLE OF CONTENTS

Specifications	4-2
Quick Spec Guide	4-3
Elevations/Sizes: 1/4" Scale	
Picture Units	4-4
Quarter Round	4-17
Half Round	4-18
Full Round	4-19
Quarter Circle Segment	4-20
Circle Segment	4-21
Extended Quarter Round	4-22
Extended Half Round	4-23
Extended Quarter Segment	4-25
Extended Circle Segment	4-30
Trapezoid	4-35
Triangle	4-45
Clipped Corner	4-55
Pentagon	4-65
Section Details	4-70

PRODUCT SPECIFICATIONS

MATERIALS

Extruded vinyl profiles comply with the performance requirements of AAMA 303-97. Colors are White and Desert Sand.

FRAME

All frames and sash are assembled utilizing fusion-welded technology for added strength and durability. Frame jamb depth is 3-9/16" (90.49mm), and the exterior wall thickness is 0.060 of an inch nominal. Frames have wide profile with 3-1/2" (88.9mm) integral flat casing and come standard with integral nailing fin that can be easily removed for replacement purposes.

GLAZING

3/4" (19mm) insulated glass consists of two lites of glass sealed around a spacer. All insulating glass units comply with the performance requirements of the IGCC in accordance with either ASTM E774 or E2190. All units are exterior glazed.

GLAZING OPTIONS

3/4" (19mm) insulated glass available in clear, Low-E or Low-E 366, tinted, obscure or other specialty insulating glass as specified. All glass is available tempered.

GRILLES

GBG (Grilles between the Glass) - 5/8" (16mm) flat, 7/8" (22.2mm) flat, 5/8" (16mm) contour or 1" (26mm) contour grilles mounted between the glass panes suspended within the air cavity and color matched to the extrusion color.

INSTALLATION

Installation per JELD-WEN Installation Method for Vinyl Windows JII001, JII010 or JII011. See www.jeld-wen.com/resources for instructions.

PERFORMANCE











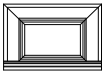
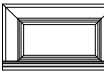
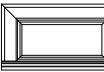
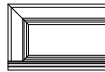
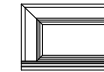
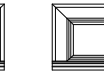

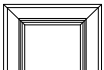



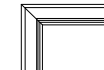
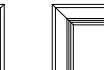

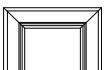



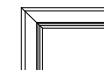
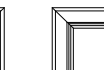

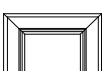



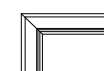





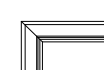

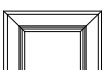



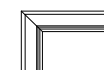

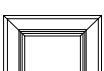

NFRC Certified - (rated and labeled in accordance with NFRC)

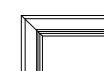
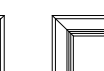
AAMA/NWDMA I.S.2-97
C35-DP rated

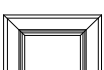
QUICK SPEC GUIDE

SPECIFICATION	STANDARD FEATURES	OPTIONAL FEATURES <i>Some options may require additional lead times. Consult your JELD-WEN Sales Representative.</i>
COLOR	<ul style="list-style-type: none"> White 	<ul style="list-style-type: none"> Desert Sand
SIZE (Rough Opening)	<ul style="list-style-type: none"> Width: 10" to 120" Height: 10" to 120" <p>50 sq. ft. maximum size in single unit</p>	Radius and Geometrics sizes limited to 50 sq. ft. maximum and may be further limited due to configuration.
FRAME	<ul style="list-style-type: none"> Applied Flat Casing J-Channel Accessory 	
GLAZING	<ul style="list-style-type: none"> Insulating Clear 	<ul style="list-style-type: none"> Insulating Low-E Obscure Bronze Gray <p><i>regional glass availabilities may differ</i></p>
GRILLES		<ul style="list-style-type: none"> 5/8", 1" Contour GBG (grilles between the glass) 5/8", 7/8" Flat GBG (grilles between the glass)
JAMB DEPTH	<ul style="list-style-type: none"> 2-29/32" 	<ul style="list-style-type: none"> 4-9/16" Extension Jambs Applied 6-9/16" Extension Jambs Applied
ACCESSORIES		<ul style="list-style-type: none"> Extension Jamb Retainer Drywall Retainer

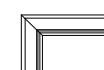









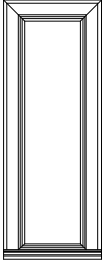
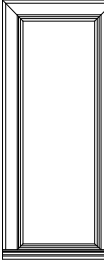

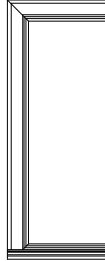
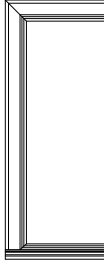
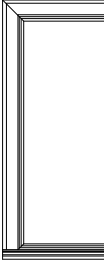

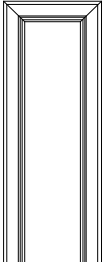
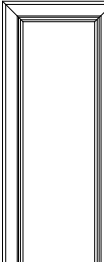
PICTURE UNITS

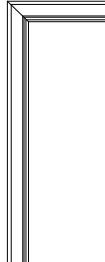
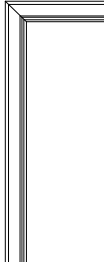
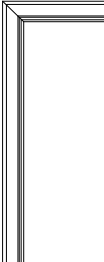
UNIT SIZE ROUGH OPENING FRAME SIZE DAYLIGHT OPENING	24 13/32" 18" 17 1/2" 13 7/8"	28 13/32" 22" 21 1/2" 17 7/8"	30 13/32" 24" 23 1/2" 19 7/8"	32 13/32" 26" 25 1/2" 21 7/8"	36 13/32" 30" 29 1/2" 25 7/8"	38 13/32" 32" 31 1/2" 27 7/8"	40 13/32" 34" 33 1/2" 29 7/8"
17 3/32" 12" 11 1/2" 7 7/8"	 MPCC1812	 MPCC2212	 MPCC2412	 MPCC2612	 MPCC3012	 MPCC3212	 MPCC3412
23 3/32" 18" 17 1/2" 13 7/8"	 MPCC1818	 MPCC2218	 MPCC2418	 MPCC2618	 MPCC3018	 MPCC3218	 MPCC3418
29 3/32" 24" 23 1/2" 19 7/8"	 MPCC1824	 MPCC2224	 MPCC2424	 MPCC2624	 MPCC3024	 MPCC3224	 MPCC3424
35 3/32" 30" 29 1/2" 25 7/8"	 MPCC1830	 MPCC2230	 MPCC2430	 MPCC2630	 MPCC3030	 MPCC3230	 MPCC3430
41 3/32" 36" 35 1/2" 31 7/8"	 MPCC1836	 MPCC2236	 MPCC2436	 MPCC2636	 MPCC3036	 MPCC3236	 MPCC3436
47 3/32" 42" 41 1/2" 37 7/8"	 MPCC1842	 MPCC2242	 MPCC2442	 MPCC2642	 MPCC3042	 MPCC3242	 MPCC3442
53 3/32" 48" 47 1/2" 43 7/8"	 MPCC1848	 MPCC2248	 MPCC2448	 MPCC2648	 MPCC3048	 MPCC3248	 MPCC3448
59 3/32" 54" 53 1/2" 49 7/8"	 MPCC1854	 MPCC2254	 MPCC2454	 MPCC2654	 MPCC3054	 MPCC3254	 MPCC3454

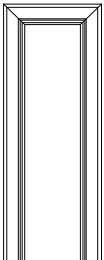
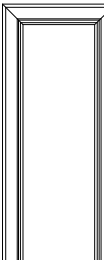
Note: Elevations shown DO NOT have exterior trim. Subtract 1/2" (12.7) from M.O. (Masonry Opening) for Unit Sizes. Masonry Openings above include Sill Nose, see Trim Options page for Sill Nose specifications. For other Trim Options refer to the Unit Sizing, Rough Opening & Masonry Openings page.

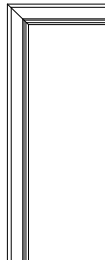
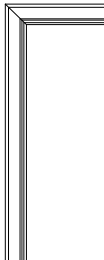
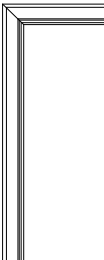
SCALE: 1/4" = 1'

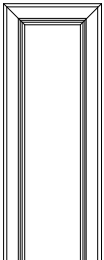
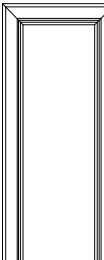

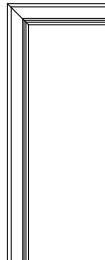
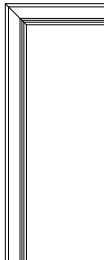
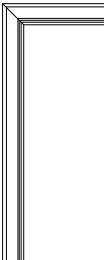



PICTURE UNITS

	24 13/32"	28 13/32"	30 13/32"	32 13/32"	36 13/32"	38 13/32"	40 13/32"		
UNIT SIZE	18"	22"	24"	26"	30"	32"	34"		
ROUGH OPENING	17 1/2"	21 1/2"	23 1/2"	25 1/2"	29 1/2"	31 1/2"	33 1/2"		
FRAME SIZE	13 7/8"	17 7/8"	19 7/8"	21 7/8"	25 7/8"	27 7/8"	29 7/8"		
DAYLIGHT OPENING									
65 3/32" 60" 59 1/2" 55 7/8"									
	MPCC1860	MPCC2260	MPCC2460	MPCC2660	MPCC3060	MPCC3260	MPCC3460		
	71 3/32" 66" 65 1/2" 61 7/8"								
		MPCC1866	MPCC2266	MPCC2466	MPCC2666	MPCC3066	MPCC3266	MPCC3466	
		77 3/32" 72" 71 1/2" 67 7/8"							
			MPCC1872	MPCC2272	MPCC2472	MPCC2672	MPCC3072	MPCC3272	MPCC3472
			83 3/32" 78" 77 1/2" 73 7/8"						
MPCC1878				MPCC2278	MPCC2478	MPCC2678	MPCC3078	MPCC3278	MPCC3478

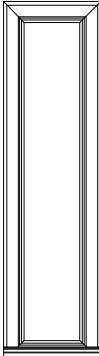
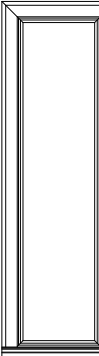
Note: Elevations shown DO NOT have exterior trim. Subtract 1/2" (12.7) from M.O. (Masonry Opening) for Unit Sizes. Masonry Openings above include Sill Nose, see Trim Options page for Sill Nose specifications. For other Trim Options refer to the Unit Sizing, Rough Opening & Masonry Openings page.

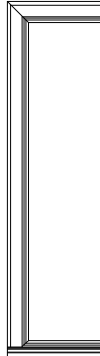
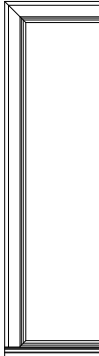
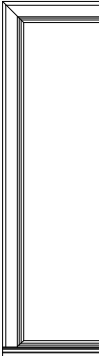
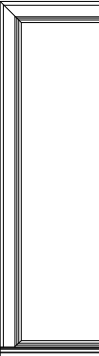
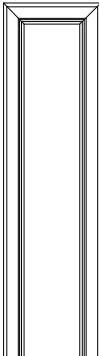
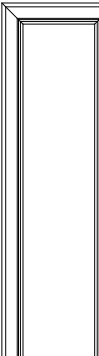
SCALE: 1/4" = 1'

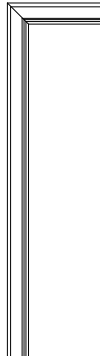
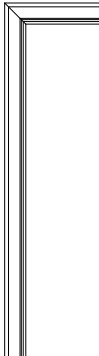
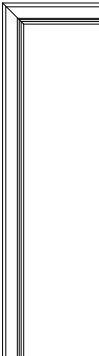
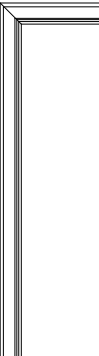
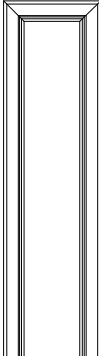
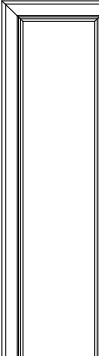
PICTURE UNITS

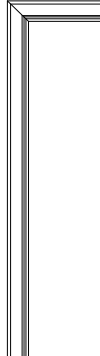
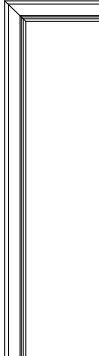
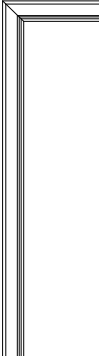
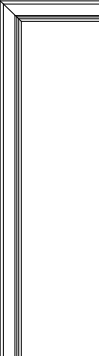
UNIT SIZE	24 13/32"	28 13/32"	30 13/32"	32 13/32"	36 13/32"	38 13/32"	40 13/32"		
ROUGH OPENING	18"	22"	24"	26"	30"	32"	34"		
FRAME SIZE	17 1/2"	21 1/2"	23 1/2"	25 1/2"	29 1/2"	31 1/2"	33 1/2"		
DAYLIGHT OPENING	13 7/8"	17 7/8"	19 7/8"	21 7/8"	25 7/8"	27 7/8"	29 7/8"		
89 3/32" 84" 83 1/2" 79 7/8"									
	MPCC1884	MPCC2284	MPCC2484	MPCC2684	MPCC3084	MPCC3284	MPCC3484		
	95 3/32" 90" 89 1/2" 85 7/8"								
		MPCC1890	MPCC2290	MPCC2490	MPCC2690	MPCC3090	MPCC3290	MPCC3490	
		101 3/32" 96" 95 1/2" 91 7/8"							
			MPCC1896	MPCC2296	MPCC2496	MPCC2696	MPCC3096	MPCC3296	MPCC3496

Note: Elevations shown DO NOT have exterior trim. Subtract 1/2" (12.7) from M.O. (Masonry Opening) for Unit Sizes. Masonry Openings above include Sill Nose, see Trim Options page for Sill Nose specifications. For other Trim Options refer to the Unit Sizing, Rough Opening & Masonry Openings page.

SCALE: 1/4" = 1'

PICTURE UNITS

UNIT SIZE
ROUGH OPENING
FRAME SIZE
DAYLIGHT OPENING

42 13/32"
36"
35 1/2"
31 7/8"

44 13/32"
38"
37 1/2"
33 7/8"

48 13/32"
42"
41 1/2"
37 7/8"

54 13/32"
48"
47 1/2"
43 7/8"

60 13/32"
54"
53 1/2"
49 7/8"

17 3/82"
12"
11 1/2"
7 7/8"



MPCC3612



MPCC3812



MPCC4212



MPCC4812



MPCC5412

23 3/32"
18"
17 1/2"
13 7/8"



MPCC3618



MPCC3818



MPCC4218



MPCC4818



MPCC5418

29 3/32"
24"
23 1/2"
19 7/8"

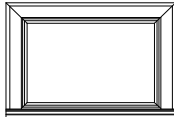

MPCC3624



MPCC3824

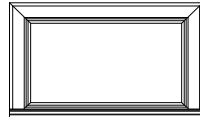

MPCC4224

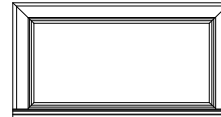

MPCC4824



MPCC5424

35 3/32"
30"
29 1/2"
25 7/8"

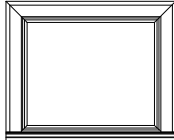

MPCC3630

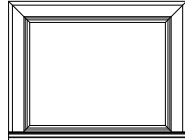

MPCC3830

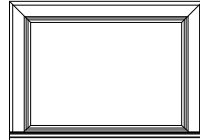

MPCC4230



MPCC4830



MPCC5430

41 3/32"
36"
35 1/2"
31 7/8"

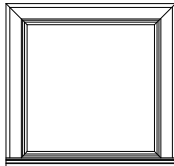

MPCC3636

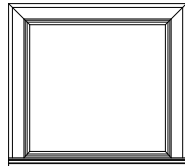

MPCC3836

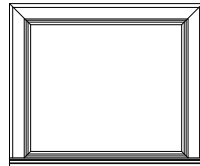

MPCC4236

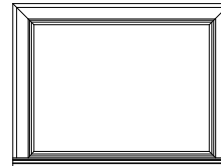

MPCC4836

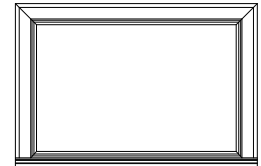

MPCC5436

47 3/32"
42"
41 1/2"
37 7/8"

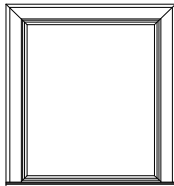

MPCC3642

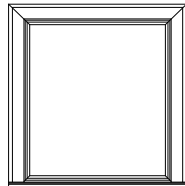

MPCC3842

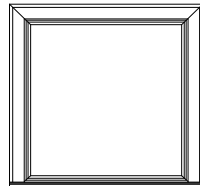

MPCC4242

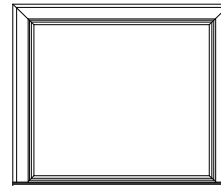

MPCC4842

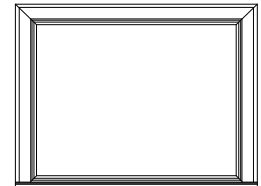

MPCC5442

53 3/32"
48"
47 1/2"
43 7/8"

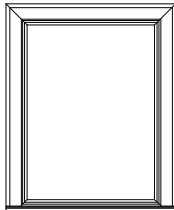

MPCC3648

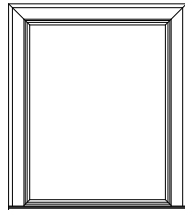

MPCC3848

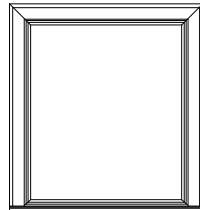

MPCC4248

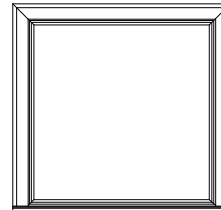

MPCC4848

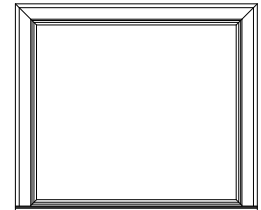

MPCC5448

59 3/32"
54"
53 1/2"
49 7/8"

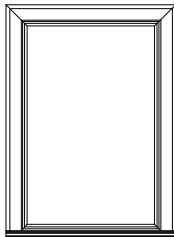

MPCC3654

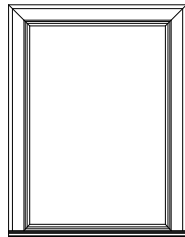

MPCC3854

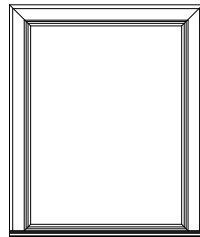

MPCC4254

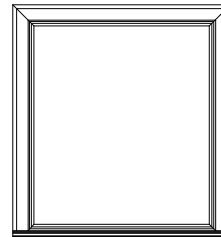

MPCC4854

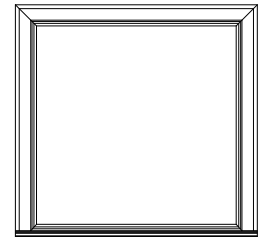

MPCC5454

Note: Elevations shown DO NOT have exterior trim. Subtract 1/2" (12.7) from M.O. (Masonry Opening) for Unit Sizes. Masonry Openings above include Sill Nose, see Trim Options page for Sill Nose specifications. For other Trim Options refer to the Unit Sizing, Rough Opening & Masonry Openings page.

SCALE: 1/4" = 1'

PICTURE UNITS

UNIT SIZE
ROUGH OPENING
FRAME SIZE
DAYLIGHT OPENING

42 13/32"
36"
35 1/2"
31 7/8"

44 13/32"
38"
37 1/2"
33 7/8"

48 13/32"
42"
41 1/2"
37 7/8"

54 13/32"
48"
47 1/2"
43 7/8"

60 13/32"
54"
53 1/2"
49 7/8"

65 3/32"
60"
59 1/2"
55 7/8"

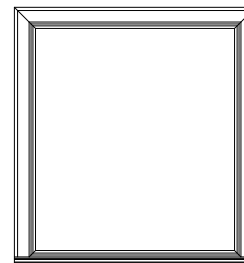
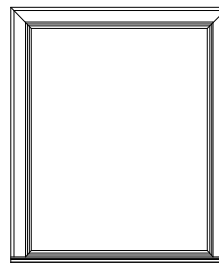
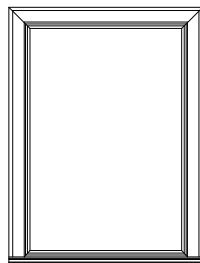
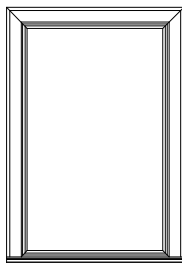
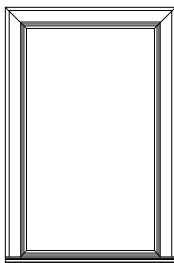

71 3/32"
66"
65 1/2"
61 7/8"

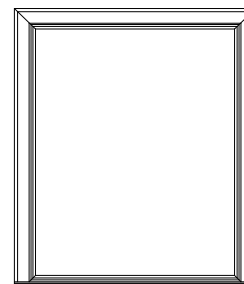
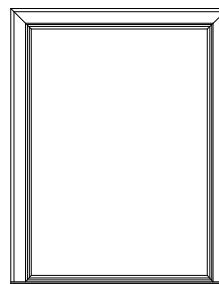
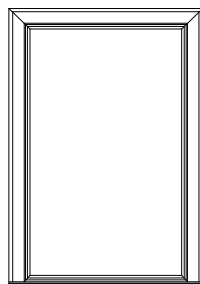
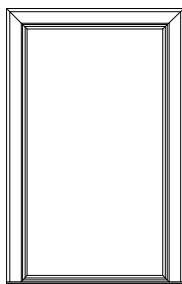
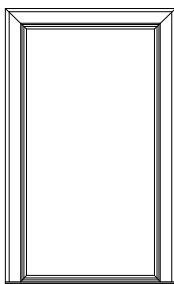

77 3/32"
72"
71 1/2"
67 7/8"

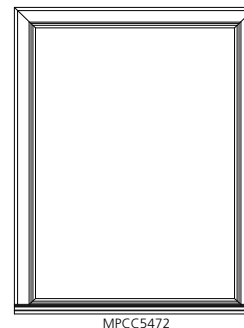
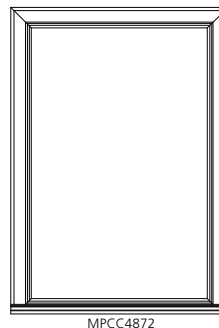
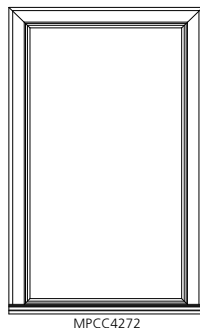
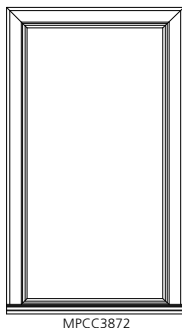
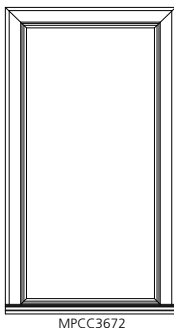

83 3/32"
78"
77 1/2"
73 7/8"

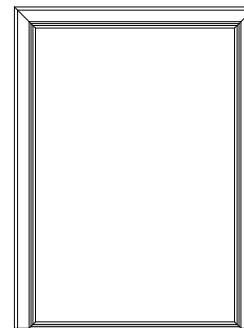
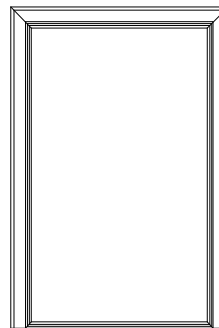
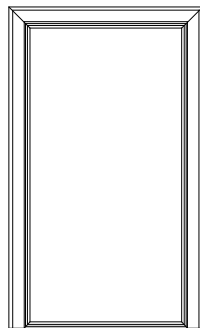
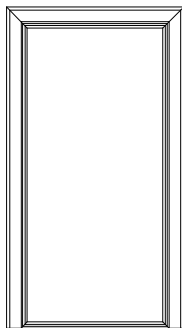
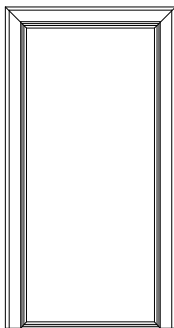

Note: Elevations shown DO NOT have exterior trim. Subtract 1/2" (12.7) from M.O. (Masonry Opening) for Unit Sizes. Masonry Openings above include Sill Nose, see Trim Options page for Sill Nose specifications. For other Trim Options refer to the Unit Sizing, Rough Opening & Masonry Openings page.

SCALE: 1/4" = 1'

PICTURE UNITS

UNIT SIZE
ROUGH OPENING
FRAME SIZE
DAYLIGHT OPENING

42 13/32"
36"
35 1/2"
31 7/8"

44 13/32"
38"
37 1/2"
33 7/8"

48 13/32"
42"
41 1/2"
37 7/8"

54 13/32"
48"
47 1/2"
43 7/8"

60 13/32"
54"
53 1/2"
49 7/8"

89 3/32"
84"
83 1/2"
79 7/8"

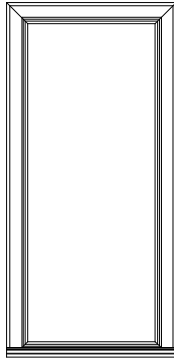

MPCC3684

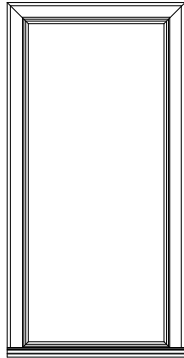

MPCC3884

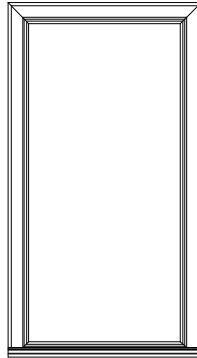

MPCC4284

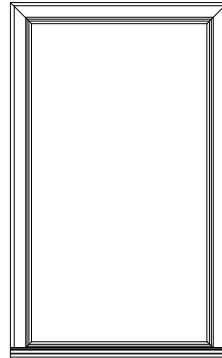

MPCC4884

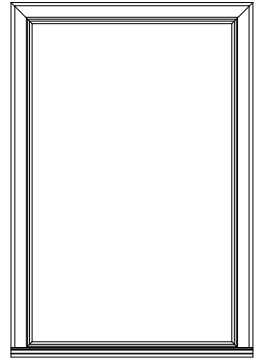

MPCC5484

95 3/32"
90"
89 1/2"
85 7/8"

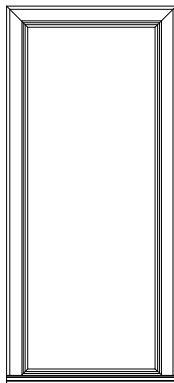

MPCC3690

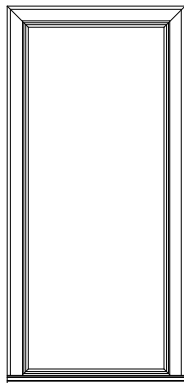

MPCC3890

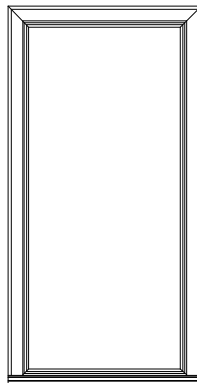

MPCC4290

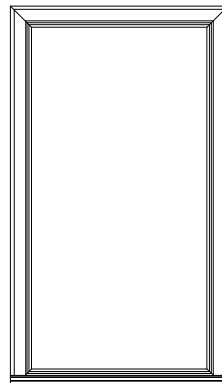

MPCC4890

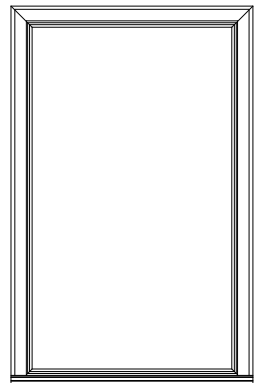

MPCC5490

101 3/32"
96"
95 1/2"
91 7/8"

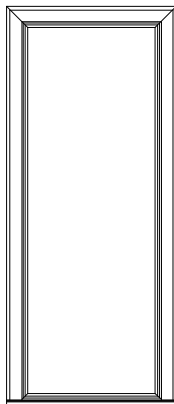

MPCC3696

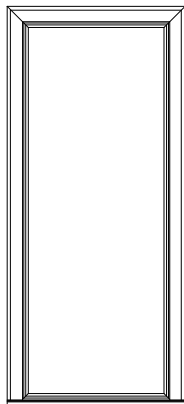

MPCC3896

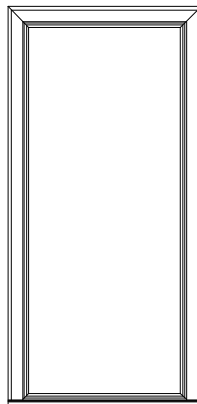

MPCC4296

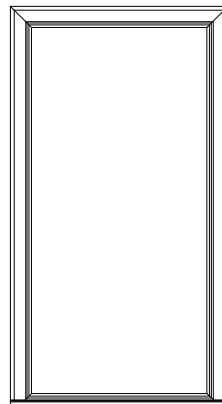

MPCC4896

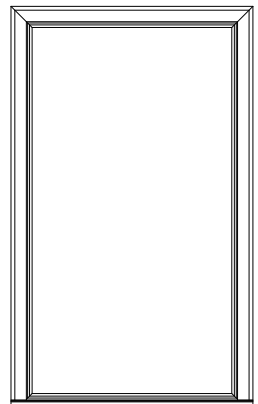

MPCC5496

Note: Elevations shown DO NOT have exterior trim. Subtract 1/2" (12.7) from M.O. (Masonry Opening) for Unit Sizes. Masonry Openings above include Sill Nose, see Trim Options page for Sill Nose specifications. For other Trim Options refer to the Unit Sizing, Rough Opening & Masonry Openings page.

SCALE: 1/4" = 1'

PICTURE UNITS

UNIT SIZE
ROUGH OPENING
FRAME SIZE
DAYLIGHT OPENING

66 13/32"
60"
59 1/2"
55 7/8"

72 13/32"
66"
65 1/2"
61 7/8"

78 13/32"
72"
71 1/2"
67 7/8"

17 3/32"
12"
11 1/2"
7 7/8"

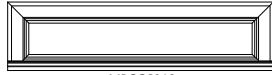

MPCC6012

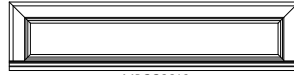

MPCC6612

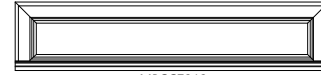

MPCC7212

23 3/32"
18"
17 1/2"
13 7/8"



MPCC6018



MPCC6618



MPCC7218

29 3/32"
24"
23 1/2"
19 7/8"



MPCC6024



MPCC6624



MPCC7224

35 3/32"
30"
29 1/2"
25 7/8"



MPCC6030



MPCC6630



MPCC7230

41 3/32"
36"
35 1/2"
31 7/8"

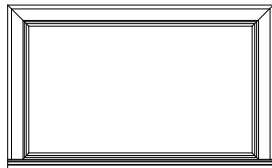

MPCC6036



MPCC6636



MPCC7236

47 3/32"
42"
41 1/2"
37 7/8"



MPCC6042

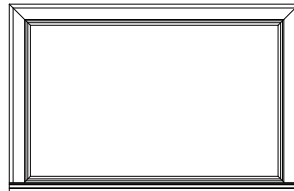

MPCC6642

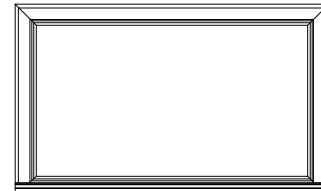

MPCC7242

53 3/32"
48"
47 1/2"
43 7/8"

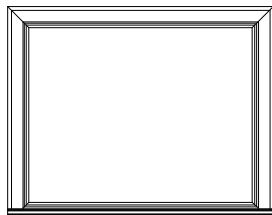

MPCC6048



MPCC6648



MPCC7248

59 3/32"
54"
53 1/2"
49 7/8"

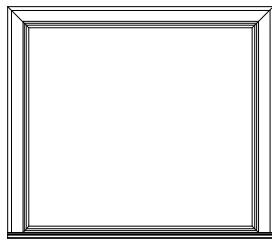

MPCC6054

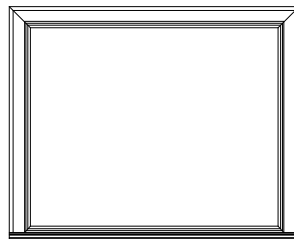

MPCC6654



MPCC7254

Note: Elevations shown DO NOT have exterior trim. Subtract 1/2" (12.7) from M.O. (Masonry Opening) for Unit Sizes. Masonry Openings above include Sill Nose, see Trim Options page for Sill Nose specifications. For other Trim Options refer to the Unit Sizing, Rough Opening & Masonry Openings page.

SCALE: 1/4" = 1'

PICTURE UNITS

UNIT SIZE
ROUGH OPENING
FRAME SIZE
DAYLIGHT OPENING

66 13/32"
60"
59 1/2"
55 7/8"

72 13/32"
66"
65 1/2"
61 7/8"

78 13/32"
72"
71 1/2"
67 7/8"

65 3/32"
60"
59 1/2"
55 7/8"

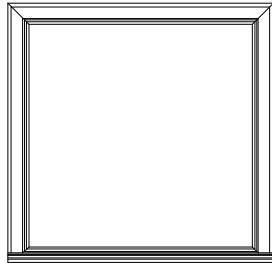

MPCC6060

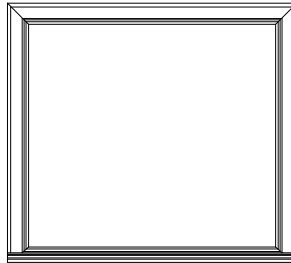

MPCC6660

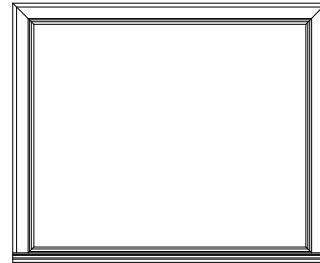

MPCC7260

71 3/32"
66"
65 1/2"
61 7/8"

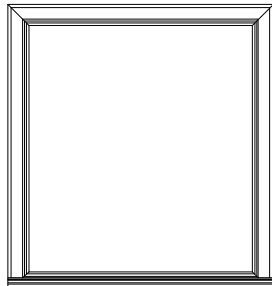

MPCC6066

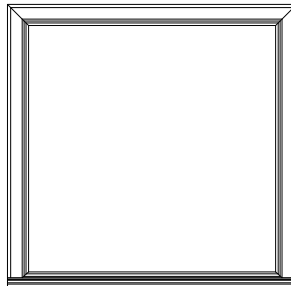

MPCC6666

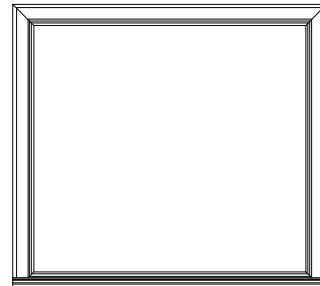

MPCC7266

77 3/32"
72"
71 1/2"
67 7/8"

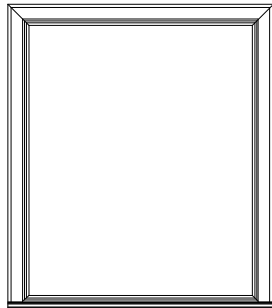

MPCC6072

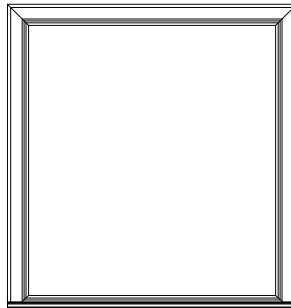

MPCC6672

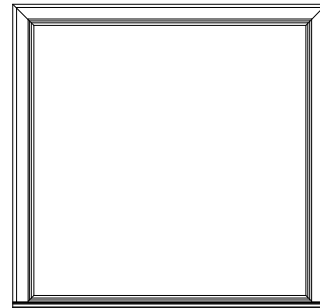

MPCC7272

83 3/32"
78"
77 1/2"
73 7/8"

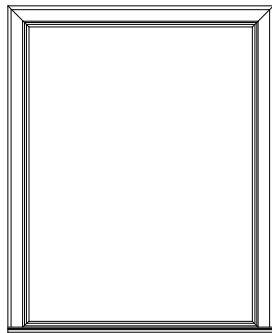

MPCC6078

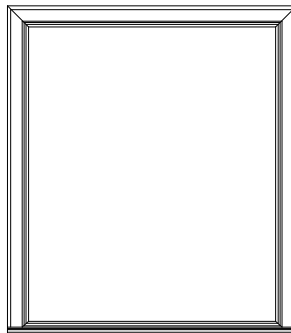

MPCC6678

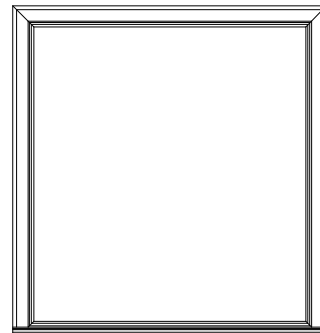

MPCC7278

Note: Elevations shown DO NOT have exterior trim. Subtract 1/2" (12.7) from M.O. (Masonry Opening) for Unit Sizes. Masonry Openings above include Sill Nose, see Trim Options page for Sill Nose specifications. For other Trim Options refer to the Unit Sizing, Rough Opening & Masonry Openings page.

SCALE: 1/4" = 1'

PICTURE UNITS

UNIT SIZE
ROUGH OPENING
FRAME SIZE
DAYLIGHT OPENING

66 13/32"
60"
59 1/2"
55 7/8"

72 13/32"
66"
65 1/2"
61 7/8"

78 13/32"
72"
71 1/2"
67 7/8"

89 3/32"
84"
83 1/2"
79 7/8"

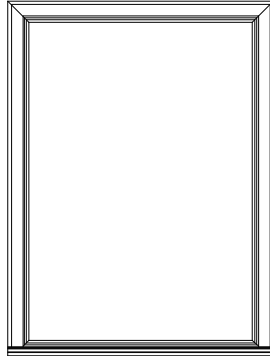

MPCC6084

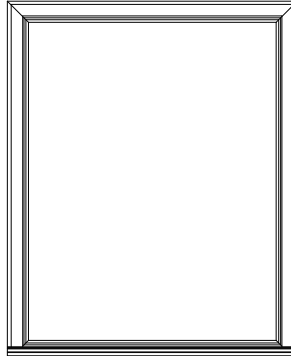

MPCC6684

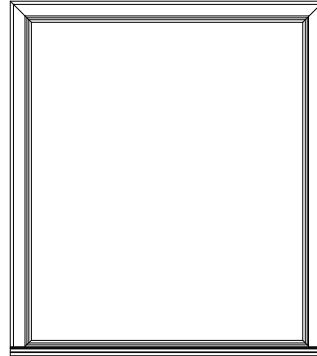

MPCC7284

95 3/32"
90"
89 1/2"
85 7/8"

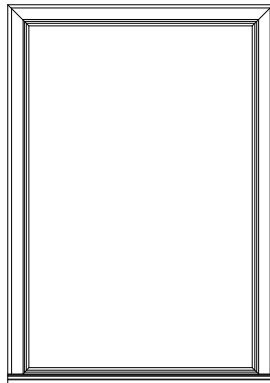

MPCC6090

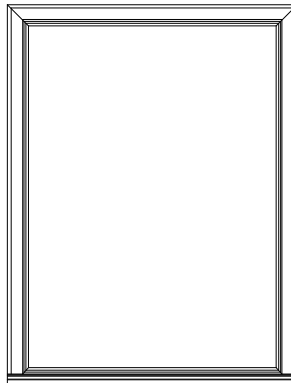

MPCC6690

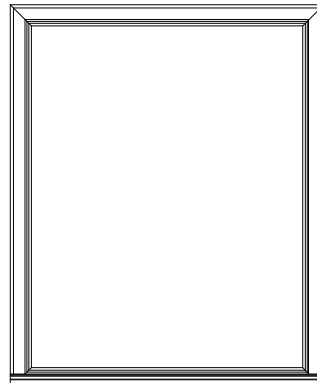

MPCC7290

101 3/32"
96"
95 1/2"
91 7/8"

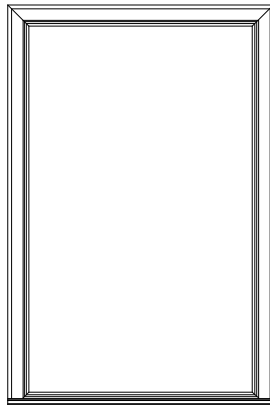

MPCC6096

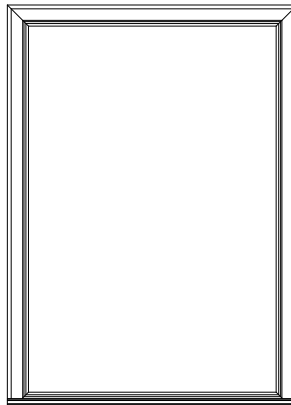

MPCC6696

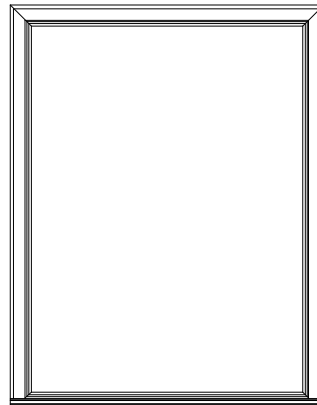

MPCC7296

Note: Elevations shown DO NOT have exterior trim. Subtract 1/2" (12.7) from M.O. (Masonry Opening) for Unit Sizes. Masonry Openings above include Sill Nose, see Trim Options page for Sill Nose specifications. For other Trim Options refer to the Unit Sizing, Rough Opening & Masonry Openings page.

SCALE: 1/4" = 1'

PICTURE UNITS

UNIT SIZE
ROUGH OPENING
FRAME SIZE
DAYLIGHT OPENING

84 13/32"
78"
77 1/2"
73 7/8"

90 13/32"
84"
83 1/2"
79 7/8"

96 13/32"
90"
89 1/2"
85 7/8"

17 3/32"
12"
11 1/2"
7 7/8"



MPCC7812



MPCC8412



MPCC9012

23 3/32"
18"
17 1/2"
13 7/8"



MPCC7818



MPCC8418



MPCC9018

29 3/32"
24"
23 1/2"
19 7/8"



MPCC7824



MPCC8424



MPCC9024

35 3/32"
30"
29 1/2"
25 7/8"



MPCC7830



MPCC8430



MPCC9030

41 3/32"
36"
35 1/2"
31 7/8"

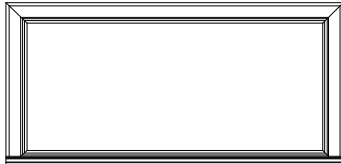

MPCC7836

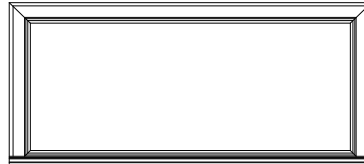

MPCC8436

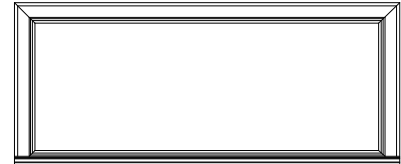

MPCC9036

47 3/32"
42"
41 1/2"
37 7/8"

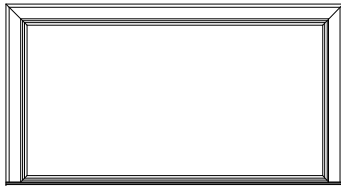

MPCC7842

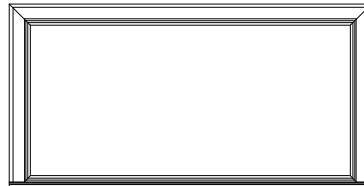

MPCC8442

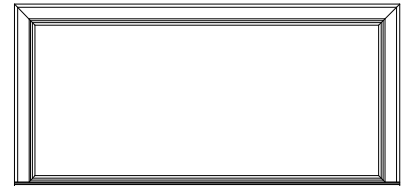

MPCC9042

53 3/32"
48"
47 1/2"
43 7/8"



MPCC7848



MPCC8448



MPCC9048

59 3/32"
54"
53 1/2"
49 7/8"

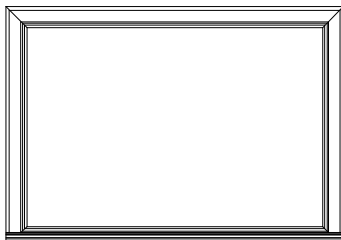

MPCC7854

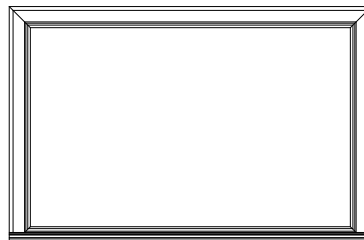

MPCC8454

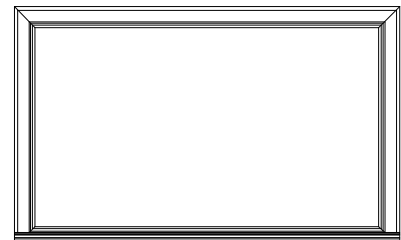

MPCC9054

Note: Elevations shown DO NOT have exterior trim. Subtract 1/2" (12.7) from M.O. (Masonry Opening) for Unit Sizes. Masonry Openings above include Sill Nose, see Trim Options page for Sill Nose specifications. For other Trim Options refer to the Unit Sizing, Rough Opening & Masonry Openings page.

SCALE: 1/4" = 1'

PICTURE UNITS

UNIT SIZE
ROUGH OPENING
FRAME SIZE
DAYLIGHT OPENING

84 13/32"
78"
77 1/2"
73 7/8"

90 13/32"
84"
83 1/2"
79 7/8"

96 13/32"
90"
89 1/2"
85 7/8"

65 3/32"
60"
59 1/2"
55 7/8"



MPCC7860



MPCC8460



MPCC9060

71 3/32"
66"
65 1/2"
61 7/8"

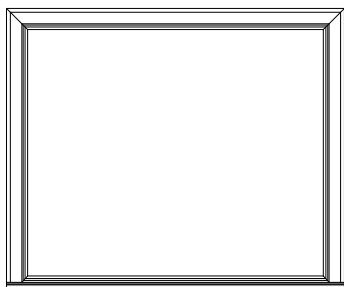

MPCC7866



MPCC8466



MPCC9066

77 3/32"
72"
71 1/2"
67 7/8"

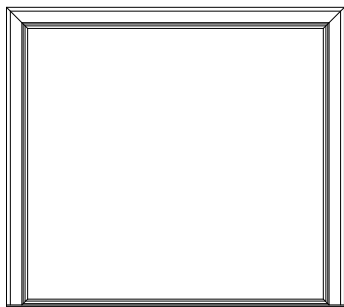

MPCC7872



MPCC8472



MPCC9072

83 3/32"
78"
77 1/2"

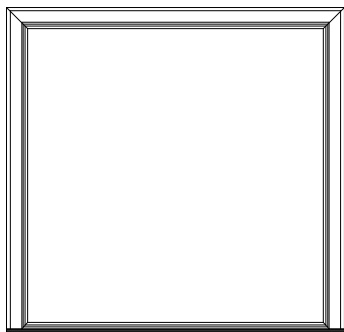

MPCC7878

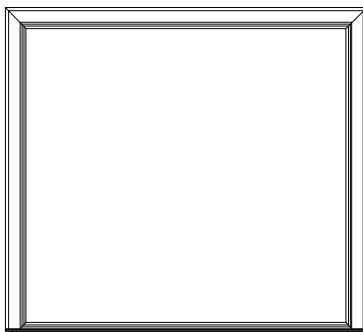

MPCC8478

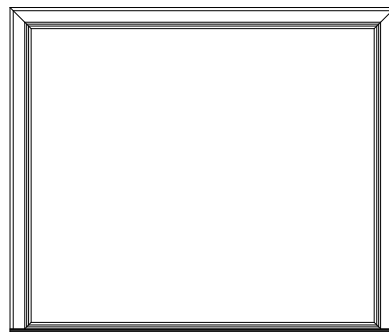

MPCC9078

Note: Elevations shown DO NOT have exterior trim. Subtract 1/2" (12.7) from M.O. (Masonry Opening) for Unit Sizes. Masonry Openings above include Sill Nose, see Trim Options page for Sill Nose specifications. For other Trim Options refer to the Unit Sizing, Rough Opening & Masonry Openings page.

SCALE: 1/4" = 1'

PICTURE UNITS

UNIT SIZE
ROUGH OPENING
FRAME SIZE
DAYLIGHT OPENING

84 13/32"
78"
77 1/2"
73 7/8"

90 13/32"
84"
83 1/2"
79 7/8"

89 3/32"
84"
83 1/2"
79 7/8"

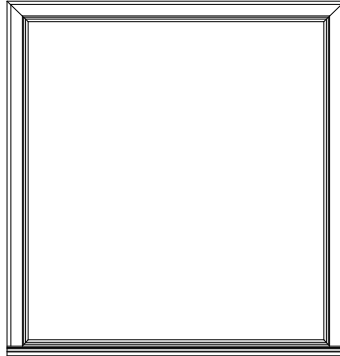

MPCC7884

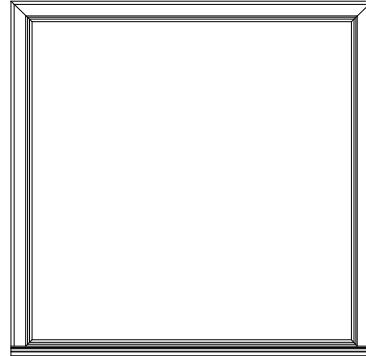

MPCC8484

95 3/32"
90"
89 1/2"
85 7/8"

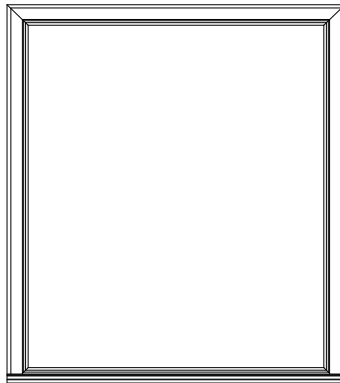

MPCC7890

Note: Elevations shown DO NOT have exterior trim. Subtract 1/2" (12.7) from M.O. (Masonry Opening) for Unit Sizes. Masonry Openings above include Sill Nose, see Trim Options page for Sill Nose specifications. For other Trim Options refer to the Unit Sizing, Rough Opening & Masonry Openings page.

SCALE: 1/4" = 1'

PICTURE UNITS

UNIT SIZE
ROUGH OPENING
FRAME SIZE
DAYLIGHT OPENING

102 13/32"
96"
95 1/2"
91 7/8"

17 3/32"
17"
11 1/2"
7 7/8"



MPCC9612

23 3/32"
18"
17 1/2"
13 7/8"



MPCC9618

29 3/32"
24"
23 1/2"
19 7/8"



MPCC9624

35 3/32"
30"
29 1/2"
25 7/8"



MPCC9630

41 3/32"
36"
35 1/2"
31 7/8"



MPCC9636

47 3/32"
42"
41 1/2"
37 7/8"



MPCC9642

53 3/32"
48"
47 1/2"
43 7/8"



MPCC9648

59 3/32"
54"
53 1/2"
49 7/8"



MPCC9654

UNIT SIZE
ROUGH OPENING
FRAME SIZE
DAYLIGHT OPENING

102 13/32"
96"
95 1/2"
91 7/8"

65 3/32"
60"
59 1/2"
55 7/8"

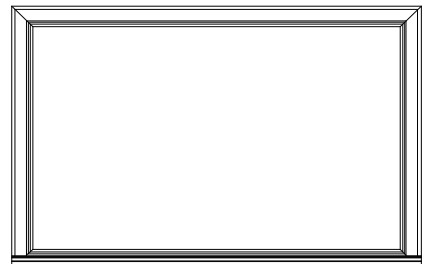

MPCC9660

71 3/32"
66"
65 1/2"
61 7/8"

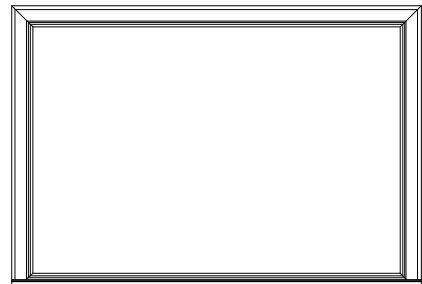

MPCC9666

77 3/32"
72"
71 1/2"
67 7/8"



MPCC9672

Note: Elevations shown DO NOT have exterior trim. Subtract 1/2" (12.7) from M.O. (Masonry Opening) for Unit Sizes. Masonry Openings above include Sill Nose, see Trim Options page for Sill Nose specifications. For other Trim Options refer to the Unit Sizing, Rough Opening & Masonry Openings page.

SCALE: 1/4" = 1'

QUARTER ROUND

UNIT SIZE 24 13/32"
ROUGH OPENING 18"
FRAME SIZE 17 1/2"
DAYLIGHT OPENING 13 7/8"



MQRC1818

UNIT SIZE 28 13/32"
ROUGH OPENING 22"
FRAME SIZE 21 1/2"
DAYLIGHT OPENING 17 7/8"

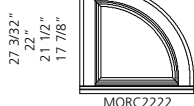

MQRC2222

UNIT SIZE 30 13/32"
ROUGH OPENING 24"
FRAME SIZE 23 1/2"
DAYLIGHT OPENING 19 7/8"

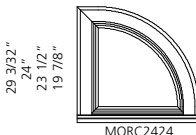

MQRC2424

UNIT SIZE 32 13/32"
ROUGH OPENING 26"
FRAME SIZE 25 1/2"
DAYLIGHT OPENING 21 7/8"

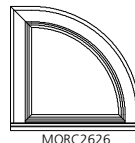

MQRC2626

UNIT SIZE 36 13/32"
ROUGH OPENING 30"
FRAME SIZE 29 1/2"
DAYLIGHT OPENING 25 7/8"

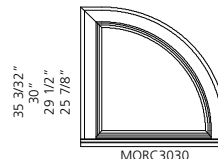

MQRC3030

UNIT SIZE 38 13/32"
ROUGH OPENING 32"
FRAME SIZE 31 1/2"
DAYLIGHT OPENING 27 7/8"



MQRC3232

UNIT SIZE 40 13/32"
ROUGH OPENING 34"
FRAME SIZE 33 1/2"
DAYLIGHT OPENING 29 7/8"



MQRC3434

UNIT SIZE 42 13/32"
ROUGH OPENING 36"
FRAME SIZE 35 1/2"
DAYLIGHT OPENING 31 7/8"

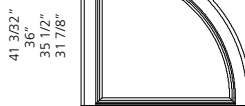

MQRC3636

UNIT SIZE 44 13/32"
ROUGH OPENING 38"
FRAME SIZE 37 1/2"
DAYLIGHT OPENING 33 7/8"

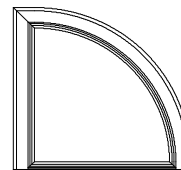

MQRC3838

UNIT SIZE 48 13/32"
ROUGH OPENING 42"
FRAME SIZE 41 1/2"
DAYLIGHT OPENING 37 7/8"



MQRC4242

UNIT SIZE 54 13/32"
ROUGH OPENING 48"
FRAME SIZE 47 1/2"
DAYLIGHT OPENING 43 7/8"

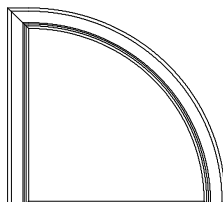

MQRC4848

UNIT SIZE 60 13/32"
ROUGH OPENING 54"
FRAME SIZE 53 1/2"
DAYLIGHT OPENING 49 7/8"

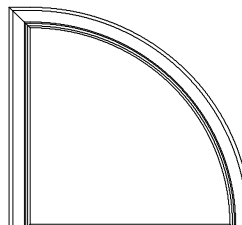

MQRC5454

UNIT SIZE 66 13/32"
ROUGH OPENING 60"
FRAME SIZE 59 1/2"
DAYLIGHT OPENING 55 7/8"

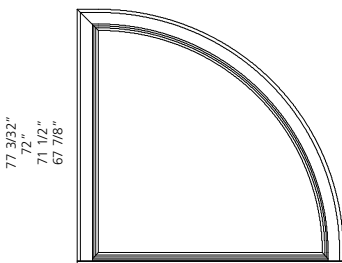

MQRC6060

UNIT SIZE 72 13/32"
ROUGH OPENING 66"
FRAME SIZE 65 1/2"
DAYLIGHT OPENING 61 7/8"

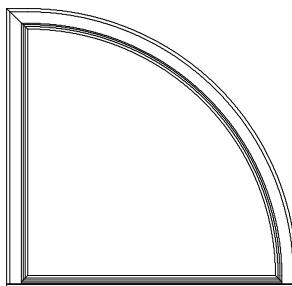

MQRC6666

UNIT SIZE 78 13/32"
ROUGH OPENING 72"
FRAME SIZE 71 1/2"
DAYLIGHT OPENING 67 7/8"

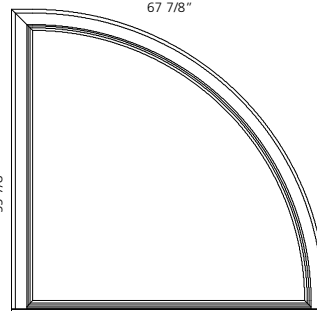

MQRC7272

Note: Elevations shown DO NOT have exterior trim. Subtract 1/2" (12.7) from M.O. (Masonry Opening) for Unit Sizes. Masonry Openings above include Sill Nose, see Trim Options page for Sill Nose specifications. For other Trim Options refer to the Unit Sizing, Rough Opening & Masonry Openings page.

SCALE: 1/4" = 1'

HALF ROUND

UNIT SIZE
ROUGH OPENING
FRAME SIZE
DAYLIGHT OPENING

38 13/32"
32"
31 1/2"
27 7/8"

21 3/32"
16"
15 1/2"
11 7/8"

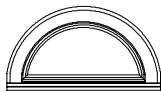

MHRC3216

40 13/32"
34"
33 1/2"
29 7/8"

22 3/32"
17"
16 1/2"
12 7/8"

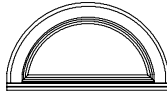

MHRC3417

42 13/32"
36"
35 1/2"
31 7/8"

23 3/32"
18"
17 1/2"
13 7/8"



MHRC3618

44 13/32"
38"
37 1/2"
33 7/8"

24 3/32"
19"
18 1/2"
14 7/8"



MHRC3819

UNIT SIZE
ROUGH OPENING
FRAME SIZE
DAYLIGHT OPENING

48 13/32"
42"
41 1/2"
37 7/8"

26 3/32"
21"
20 1/2"
16 7/8"

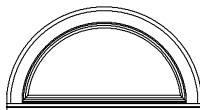

MHRC4221

50 13/32"
44"
43 1/2"
39 7/8"

27 3/32"
22"
21 1/2"
17 7/8"

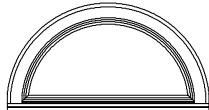

MHRC4422

54 13/32"
48"
47 1/2"
43 7/8"

29 3/32"
24"
23 1/2"
19 7/8"



MHRC4824

58 13/32"
52"
51 1/2"
47 7/8"

31 3/32"
26"
25 1/2"
21 7/8"



MHRC5226

UNIT SIZE
ROUGH OPENING
FRAME SIZE
DAYLIGHT OPENING

60 13/32"
54"
53 1/2"
49 7/8"

32 3/32"
27"
26 1/2"
22 7/8"

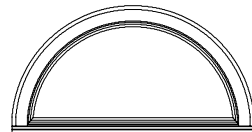

MHRC5427

66 13/32"
60"
59 1/2"
55 7/8"

35 3/32"
30"
29 1/2"
25 7/8"

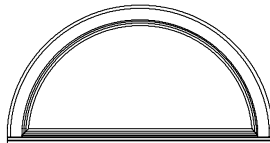

MHRC6030

70 13/32"
64"
63 1/2"
59 7/8"

37 3/32"
32"
31 1/2"
27 7/8"

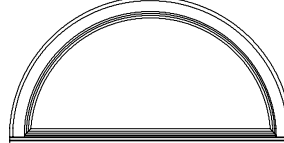

MHRC6432

UNIT SIZE
ROUGH OPENING
FRAME SIZE
DAYLIGHT OPENING

72 13/32"
66"
65 1/2"
61 7/8"

38 3/32"
33"
32 1/2"
28 7/8"

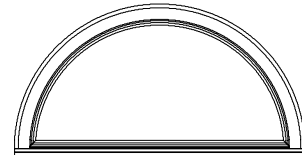

MHRC6633

74 13/32"
68"
67 1/2"
63 7/8"

39 3/32"
34"
33 1/2"
29 7/8"

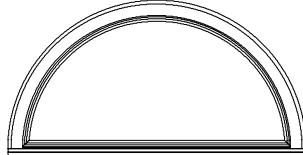

MHRC6834

78 13/32"
72"
71 1/2"
67 7/8"

41 3/32"
36"
35 1/2"
31 7/8"

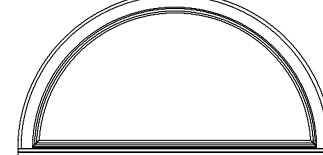

MHRC7236

Note: Elevations shown DO NOT have exterior trim. Subtract 1/2" (12.7) from M.O. (Masonry Opening) for Unit Sizes. Masonry Openings above include Sill Nose, see Trim Options page for Sill Nose specifications. For other Trim Options refer to the Unit Sizing, Rough Opening & Masonry Openings page.

SCALE: 1/4" = 1'

FULL ROUND

UNIT SIZE 40 13/32"
ROUGH OPENING 34"
FRAME SIZE 33 1/2"
DAYLIGHT OPENING 29 7/8"

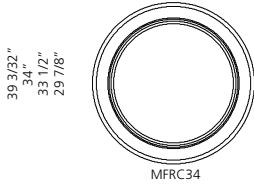

MFRC34

UNIT SIZE 42 13/32"
ROUGH OPENING 36"
FRAME SIZE 35 1/2"
DAYLIGHT OPENING 31 7/8"

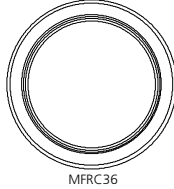

MFRC36

UNIT SIZE 44 13/32"
ROUGH OPENING 38"
FRAME SIZE 37 1/2"
DAYLIGHT OPENING 33 7/8"

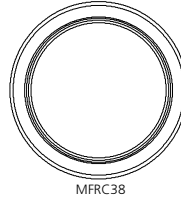

MFRC38

UNIT SIZE 48 13/32"
ROUGH OPENING 42"
FRAME SIZE 41 1/2"
DAYLIGHT OPENING 37 7/8"

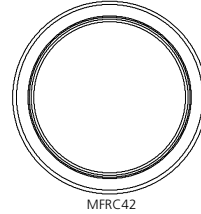

MFRC42

UNIT SIZE 54 13/32"
ROUGH OPENING 48"
FRAME SIZE 47 1/2"
DAYLIGHT OPENING 43 7/8"

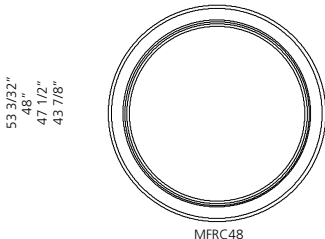

MFRC48

UNIT SIZE 60 13/32"
ROUGH OPENING 54"
FRAME SIZE 53 1/2"
DAYLIGHT OPENING 49 7/8"

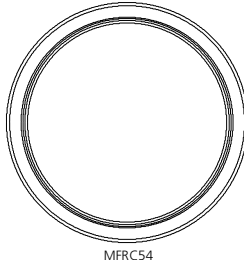

MFRC54

UNIT SIZE 66 13/32"
ROUGH OPENING 60"
FRAME SIZE 59 1/2"
DAYLIGHT OPENING 55 7/8"

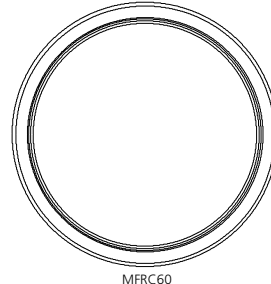

MFRC60

UNIT SIZE 72 13/32"
ROUGH OPENING 66"
FRAME SIZE 65 1/2"
DAYLIGHT OPENING 61 7/8"

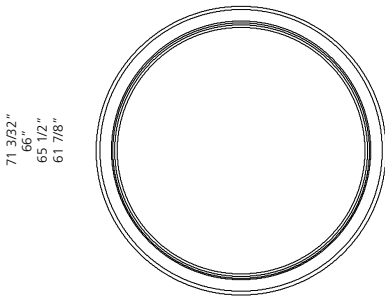

MFRC66

UNIT SIZE 78 13/32"
ROUGH OPENING 72"
FRAME SIZE 71 1/2"
DAYLIGHT OPENING 67 7/8"

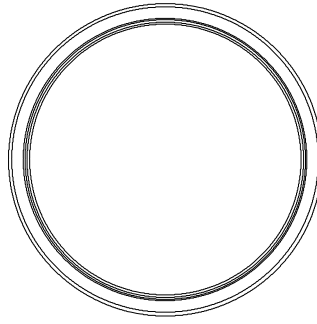

MFRC72

Note: Elevations shown DO NOT have exterior trim. Subtract 1/2" (12.7) from M.O. (Masonry Opening) for Unit Sizes. Masonry Openings above include Sill Nose, see Trim Options page for Sill Nose specifications. For other Trim Options refer to the Unit Sizing, Rough Opening & Masonry Openings page.

SCALE: 1/4" = 1'

QUARTER CIRCLE SEGMENT

UNIT SIZE
ROUGH OPENING
FRAME SIZE
DAYLIGHT OPENING

42 13/32"
36"
35 1/2"
31 7/8"

48 13/32"
42"
41 1/2"
37 7/8"

54 13/32"
48"
47 1/2"
43 7/8"

60 13/32"
54"
53 1/2"
49 7/8"

35 3/32"
30"
29 1/2"
25 7/8"

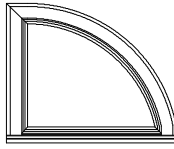

MQEC3630

41 3/32"
36"
35 1/2"
31 7/8"

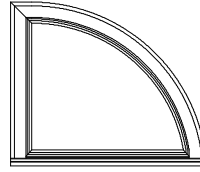

MQEC4236

47 3/32"
42"
41 1/2"
37 7/8"

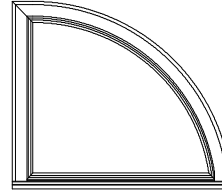

MQEC4842

53 3/32"
48"
47 1/2"
43 7/8"

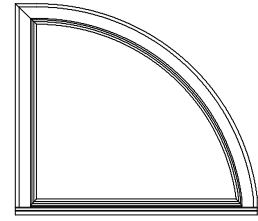

MQEC5448

UNIT SIZE
ROUGH OPENING
FRAME SIZE
DAYLIGHT OPENING

66 13/32"
60"
59 1/2"
55 7/8"

72 13/32"
66"
65 1/2"
61 7/8"

78 13/32"
72"
71 1/2"
67 7/8"

59 3/32"
54"
53 1/2"
49 7/8"

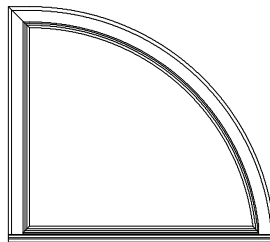

MQEC6054

65 3/32"
60"
59 1/2"
55 7/8"

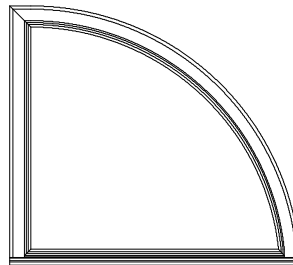

MQEC6660

71 3/32"
66"
65 1/2"
61 7/8"

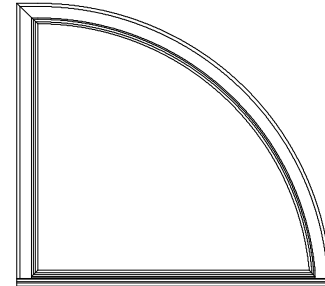

MQEC7266

Note: Elevations shown DO NOT have exterior trim. Subtract 1/2" (12.7) from M.O. (Masonry Opening) for Unit Sizes. Masonry Openings above include Sill Nose, see Trim Options page for Sill Nose specifications. For other Trim Options refer to the Unit Sizing, Rough Opening & Masonry Openings page.

SCALE: 1/4" = 1'

CIRCLE SEGMENT

UNIT SIZE	42 13/32"
ROUGH OPENING	36"
FRAME SIZE	35 1/2"
DAYLIGHT OPENING	31 7/8"

17 3/32"
12"
11 1/2"
7 7/8"



MEYC3612

UNIT SIZE	48 13/32"	54 13/32"
ROUGH OPENING	42"	48"
FRAME SIZE	41 1/2"	47 1/2"
DAYLIGHT OPENING	37 7/8"	43 7/8"

23 3/32"
18"
17 1/2"
13 7/8"



MEYC4218



MEYC4818

UNIT SIZE	60 13/32"	66 13/32"
ROUGH OPENING	54"	60"
FRAME SIZE	53 1/2"	59 1/2"
DAYLIGHT OPENING	49 7/8"	55 7/8"

29 3/32"
24"
23 1/2"
19 7/8"

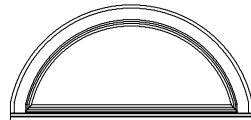

MEYC5424

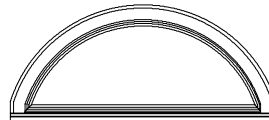

MEYC6024

UNIT SIZE	72 13/32"	78 13/32"
ROUGH OPENING	66"	72"
FRAME SIZE	65 1/2"	71 1/2"
DAYLIGHT OPENING	61 7/8"	67 7/8"

35 3/32"
30"
29 1/2"
25 7/8"

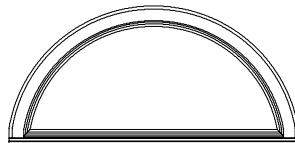

MEYC6630

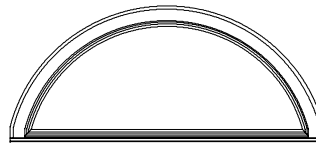

MEYC7230

Note: Elevations shown DO NOT have exterior trim. Subtract 1/2" (12.7) from M.O. (Masonry Opening) for Unit Sizes. Masonry Openings above include Sill Nose, see Trim Options page for Sill Nose specifications. For other Trim Options refer to the Unit Sizing, Rough Opening & Masonry Openings page.

SCALE: 1/4" = 1'

EXTENDED QUARTER ROUND

UNIT SIZE
ROUGH OPENING
FRAME SIZE
DAYLIGHT OPENING

24 13/32"
18"
17 1/2"
13 7/8"

30 13/32"
24"
23 1/2"
19 7/8"

36 13/32"
30"
29 1/2"
25 7/8"

42 13/32"
36"
35 1/2"
31 7/8"

53 3/32"
48"
47 1/2"
43 7/8"

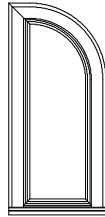

MQTC1848

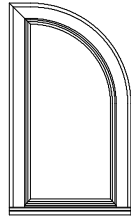

MQTC2448

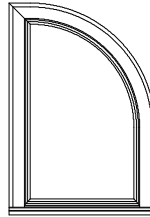

MQTC3048

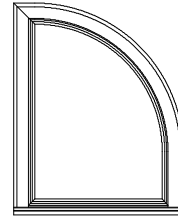

MQTC3648

59 3/32"
54"
53 1/2"
49 7/8"

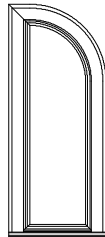

MQTC1854

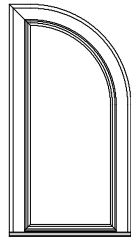

MQTC2454

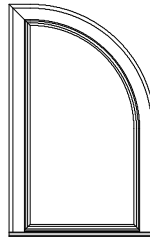

MQTC3054

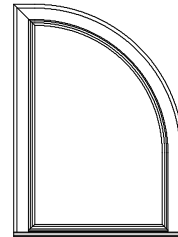

MQTC3654

65 3/32"
60"
59 1/2"
55 7/8"

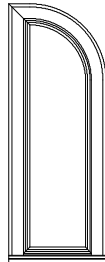

MQTC1860

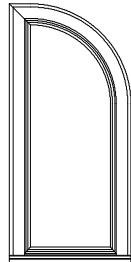

MQTC2460

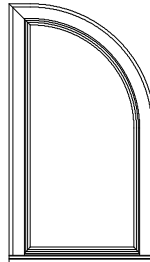

MQTC3060

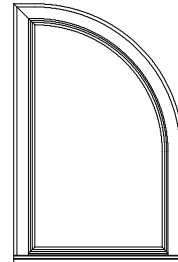

MQTC3660

71 3/32"
66"
65 1/2"
61 7/8"

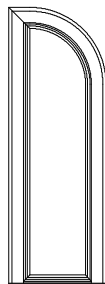

MQTC1866

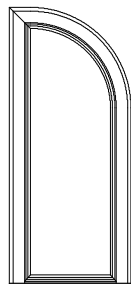

MQTC2466

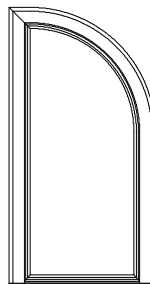

MQTC3066

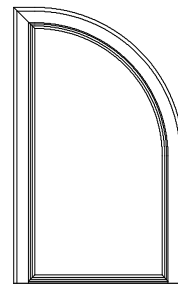

MQTC3666

77 3/32"
72"
71 1/2"
67 7/8"

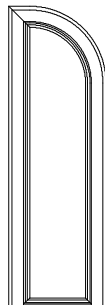

MQTC1872

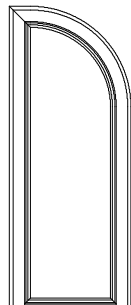

MQTC2472

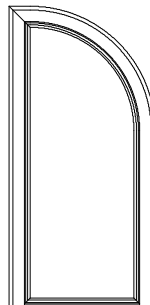

MQTC3072

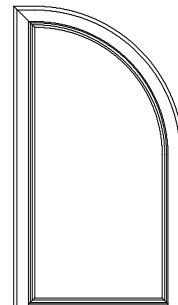

MQTC3672

Note: Elevations shown DO NOT have exterior trim. Subtract 1/2" (12.7) from M.O. (Masonry Opening) for Unit Sizes. Masonry Openings above include Sill Nose, see Trim Options page for Sill Nose specifications. For other Trim Options refer to the Unit Sizing, Rough Opening & Masonry Openings page.

SCALE: 1/4" = 1'

EXTENDED HALF ROUND

UNIT SIZE
ROUGH OPENING
FRAME SIZE
DAYLIGHT OPENING

42 13/32"
36"
35 1/2"
31 7/8"

48 13/32"
42"
41 1/2"
37 7/8"

54 13/32"
48"
47 1/2"
43 7/8"

41 3/32"
36"
35 1/2"
31 7/8"

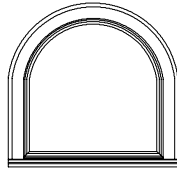

MSLC3636

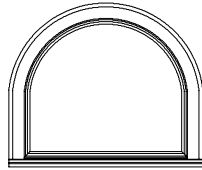

MSLC4236

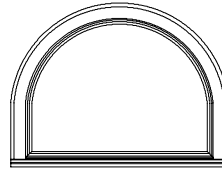

MSLC4836

53 3/32"
48"
47 1/2"
43 7/8"

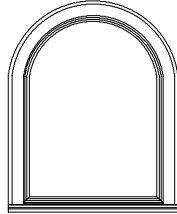

MSLC3648

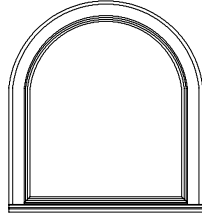

MSLC4248

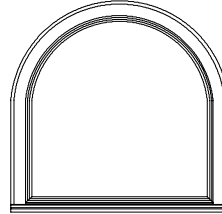

MSLC4848

59 3/32"
54"
53 1/2"
49 7/8"

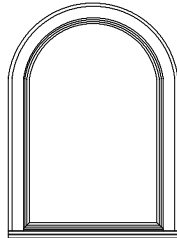

MSLC3654

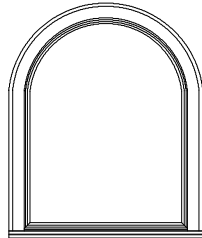

MSLC4254

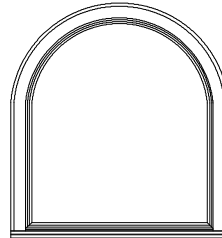

MSLC4854

65 3/32"
60"
59 1/2"
55 7/8"

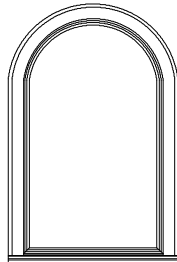

MSLC3660

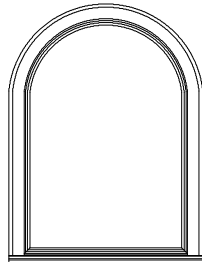

MSLC4260

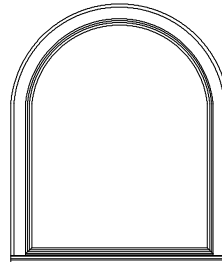

MSLC4860

71 3/32"
66"
65 1/2"
61 7/8"

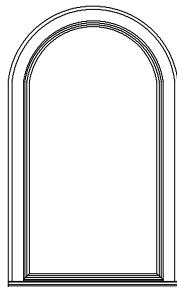

MSLC3666

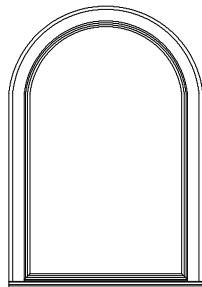

MSLC4266

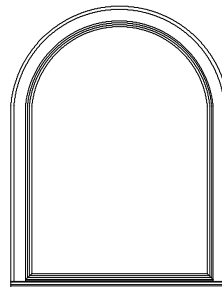

MSLC4866

Note: Elevations shown DO NOT have exterior trim. Subtract 1/2" (12.7) from M.O. (Masonry Opening) for Unit Sizes. Masonry Openings above include Sill Nose, see Trim Options page for Sill Nose specifications. For other Trim Options refer to the Unit Sizing, Rough Opening & Masonry Openings page.

SCALE: 1/4" = 1'

EXTENDED HALF ROUND

	42 13/32"	48 13/32"	54 13/32"
UNIT SIZE	42 13/32"	48 13/32"	54 13/32"
ROUGH OPENING	36"	42"	48"
FRAME SIZE	35 1/2"	41 1/2"	47 1/2"
DAYLIGHT OPENING	31 7/8"	37 7/8"	43 7/8"

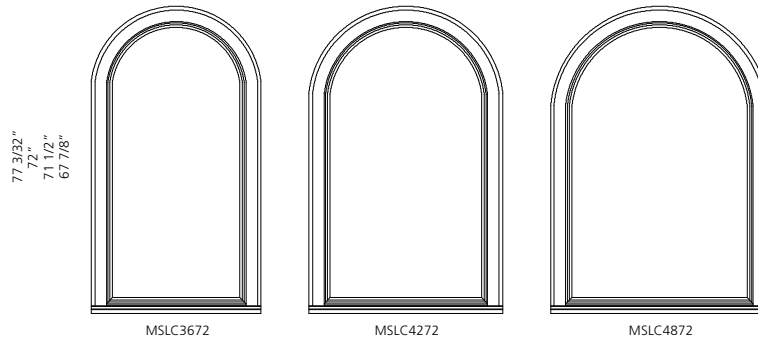

Note: Elevations shown DO NOT have exterior trim. Subtract 1/2" (12.7) from M.O. (Masonry Opening) for Unit Sizes. Masonry Openings above include Sill Nose, see Trim Options page for Sill Nose specifications. For other Trim Options refer to the Unit Sizing, Rough Opening & Masonry Openings page.

EXTENDED QUARTER SEGMENT

UNIT SIZE
ROUGH OPENING
FRAME SIZE
DAYLIGHT OPENING

30 13/32"
24"
23 1/2"
19 7/8"

36 13/32"
30"
29 1/2"
25 7/8"

42 13/32"
36"
35 1/2"
31 7/8"

48 13/32"
42"
41 1/2"
37 7/8"

54 13/32"
48"
47 1/2"
43 7/8"

29 3/32"
24"
23 1/2"
19 7/8"

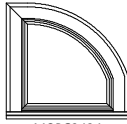

MQPC2424

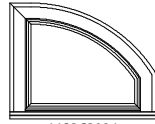

MQPC3024

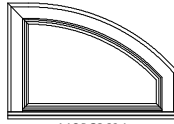

MQPC3624

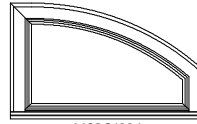

MQPC4224

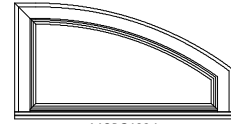

MQPC4824

35 3/32"
30"
29 1/2"
25 7/8"

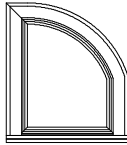

MQPC2430

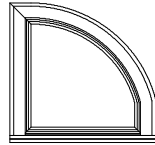

MQPC3030

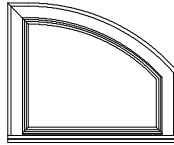

MQPC3630

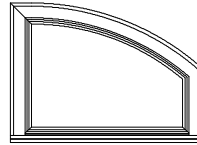

MQPC4230

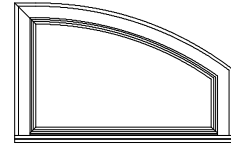

MQPC4830

41 3/32"
36"
35 1/2"
31 7/8"

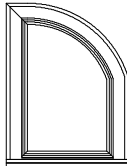

MQPC2436

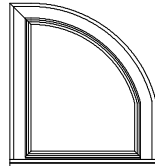

MQPC3036

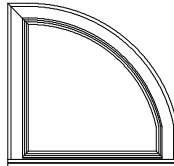

MQPC3636

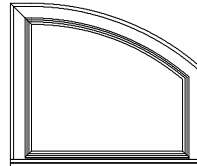

MQPC4236

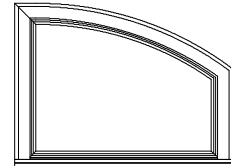

MQPC4836

47 3/32"
42"
41 1/2"
37 7/8"

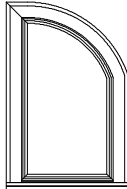

MQPC2442

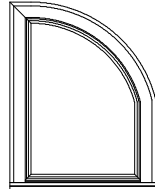

MQPC3042

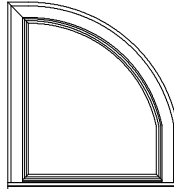

MQPC3642

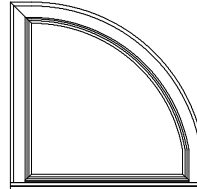

MQPC4242

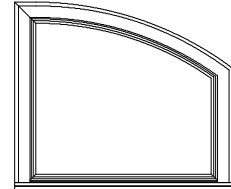

MQPC4842

53 3/32"
48"
47 1/2"
43 7/8"

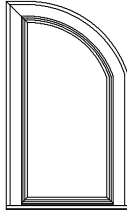

MQPC2448

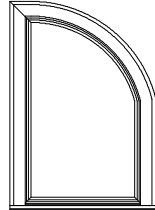

MQPC3048

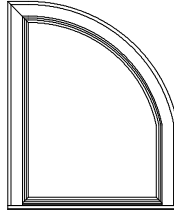

MQPC3648

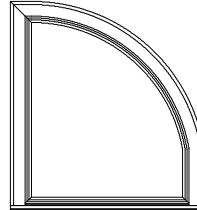

MQPC4248

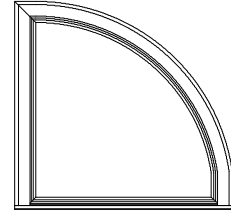

MQPC4848

59 3/32"
54"
53 1/2"
49 7/8"

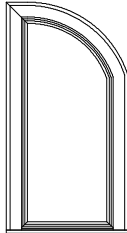

MQPC2454

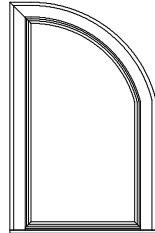

MQPC3054

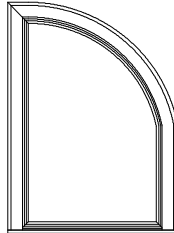

MQPC3654

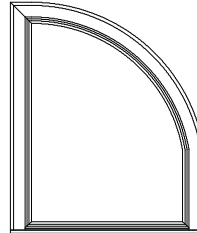

MQPC4254

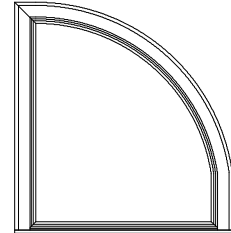

MQPC4854

65 3/32"
60"
59 1/2"
55 7/8"

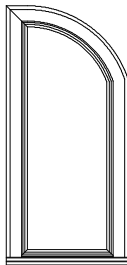

MQPC2460

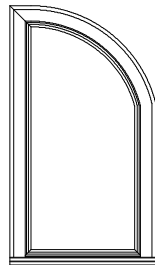

MQPC3060

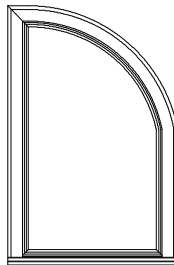

MQPC3660

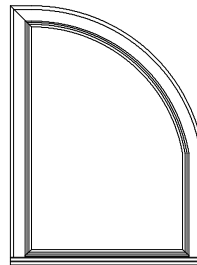

MQPC4260

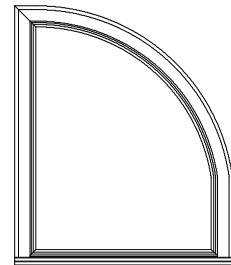

MQPC4860

Note: Elevations shown DO NOT have exterior trim. Subtract 1/2" (12.7) from M.O. (Masonry Opening) for Unit Sizes. Masonry Openings above include Sill Nose, see Trim Options page for Sill Nose specifications. For other Trim Options refer to the Unit Sizing, Rough Opening & Masonry Openings page.

SCALE: 1/4" = 1'

EXTENDED QUARTER SEGMENT

	30 13/32"	36 13/32"	42 13/32"	48 13/32"	54 13/32"
UNIT SIZE	30 13/32"	36 13/32"	42 13/32"	48 13/32"	54 13/32"
ROUGH OPENING	24"	30"	36"	42"	48"
FRAME SIZE	23 1/2"	29 1/2"	35 1/2"	41 1/2"	47 1/2"
DAYLIGHT OPENING	19 7/8"	25 7/8"	31 7/8"	37 7/8"	43 7/8"

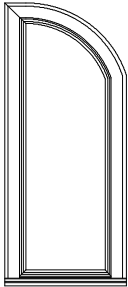
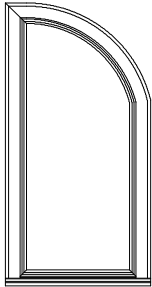
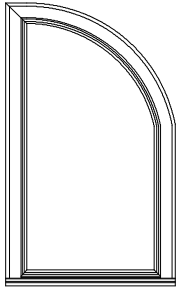
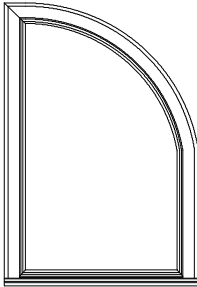
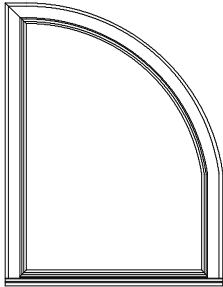
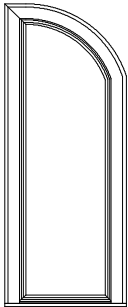
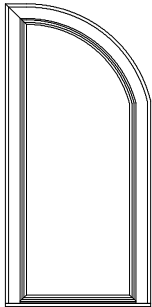
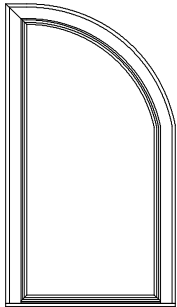
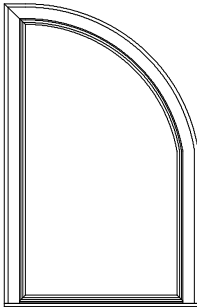
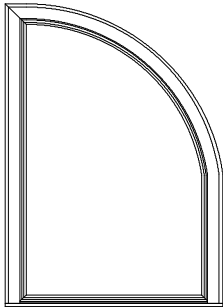
71 3/32" 66" 63 1/8" 61 7/8"						
	MQPC2466	MQPC3066	MQPC3666	MQPC4266	MQPC4866	
	77 3/32" 72" 71 1/2" 67 7/8"					
		MQPC2472	MQPC3072	MQPC3672	MQPC4272	MQPC4872

Note: Elevations shown DO NOT have exterior trim. Subtract 1/2" (12.7) from M.O. (Masonry Opening) for Unit Sizes. Masonry Openings above include Sill Nose, see Trim Options page for Sill Nose specifications. For other Trim Options refer to the Unit Sizing, Rough Opening & Masonry Openings page.

SCALE: 1/4" = 1'

EXTENDED QUARTER SEGMENT

UNIT SIZE
ROUGH OPENING
FRAME SIZE
DAYLIGHT OPENING

60 13/32"
54"
53 1/2"
49 7/8"

66 13/32"
60"
59 1/2"
55 7/8"

72 13/32"
66"
65 1/2"
61 7/8"

29 3/32"
24"
23 1/2"
19 7/8"

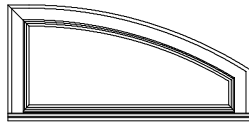

MQPC5424

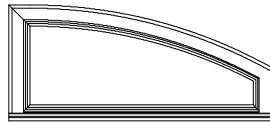

MQPC6024



MQPC6624

35 3/32"
30"
29 1/2"
25 7/8"

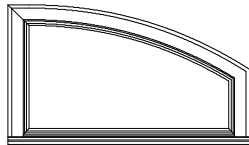

MQPC5430

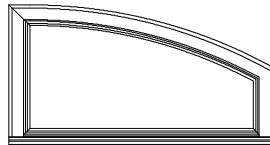

MQPC6030

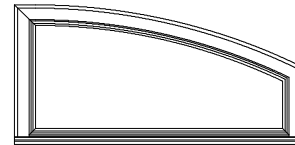

MQPC6630

41 3/32"
36"
35 1/2"
31 7/8"

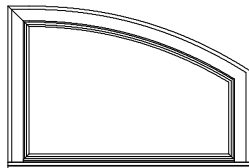

MQPC5436

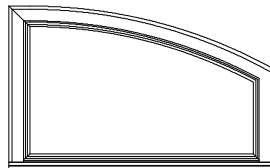

MQPC6036

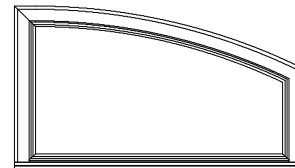

MQPC6636

47 3/32"
42"
41 1/2"
37 7/8"

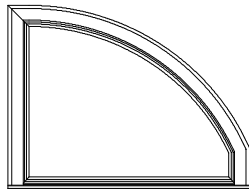

MQPC5442

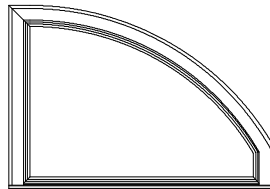

MQPC6042

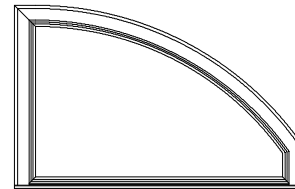

MQPC6642

53 3/32"
48"
47 1/2"
43 7/8"

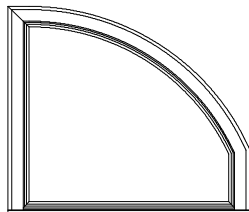

MQPC5448

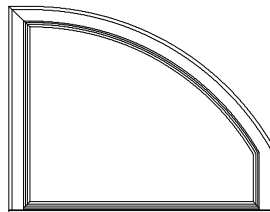

MQPC6048

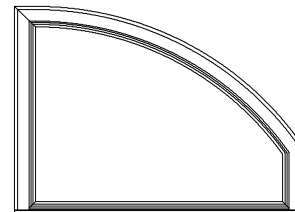

MQPC6648

59 3/32"
54"
53 1/2"
49 7/8"

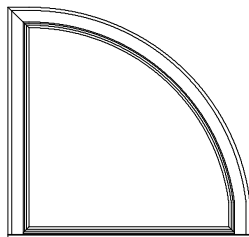

MQPC5454

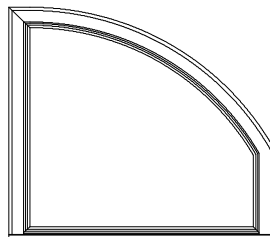

MQPC6054

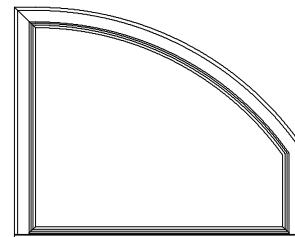

MQPC6654

65 3/32"
60"
59 1/2"
55 7/8"

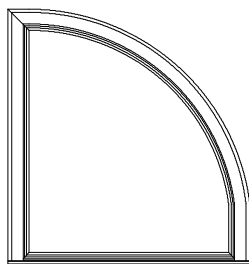

MQPC5460

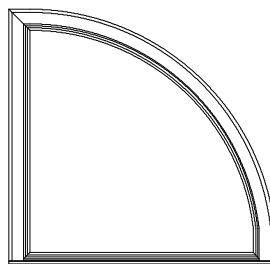

MQPC6060

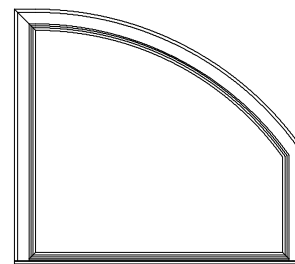

MQPC6660

Note: Elevations shown DO NOT have exterior trim. Subtract 1/2" (12.7) from M.O. (Masonry Opening) for Unit Sizes. Masonry Openings above include Sill Nose, see Trim Options page for Sill Nose specifications. For other Trim Options refer to the Unit Sizing, Rough Opening & Masonry Openings page.

SCALE: 1/4" = 1'

EXTENDED QUARTER SEGMENT

UNIT SIZE
ROUGH OPENING
FRAME SIZE
DAYLIGHT OPENING

60 13/32"
54"
53 1/2"
49 7/8"

66 13/32"
60"
59 1/2"
55 7/8"

72 13/32"
66"
65 1/2"
61 7/8"

71 3/32"
65"
65 1/2"
61 7/8"

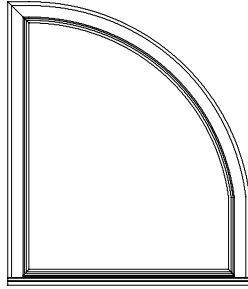

MQPC5466

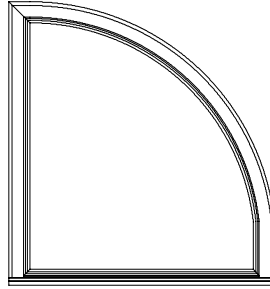

MQPC6066

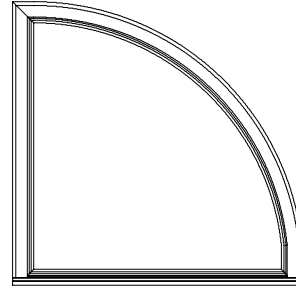

MQPC6666

77 3/32"
71"
71 1/2"
67 7/8"

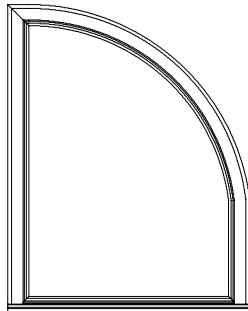

MQPC5472

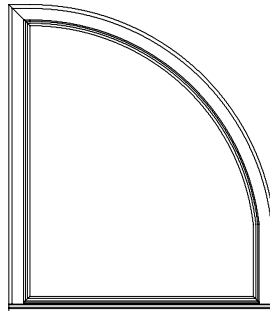

MQPC6072

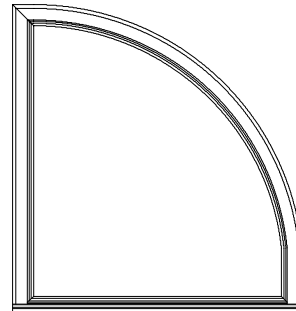

MQPC6672

Note: Elevations shown DO NOT have exterior trim. Subtract 1/2" (12.7) from M.O. (Masonry Opening) for Unit Sizes. Masonry Openings above include Sill Nose, see Trim Options page for Sill Nose specifications. For other Trim Options refer to the Unit Sizing, Rough Opening & Masonry Openings page.

SCALE: 1/4" = 1'

EXTENDED QUARTER SEGMENT

UNIT SIZE
ROUGH OPENING
FRAME SIZE
DAYLIGHT OPENING

78 13/32"
72"
71 1/2"
67 7/8"

29 3/32"
24"
23 1/2"
19 7/8"

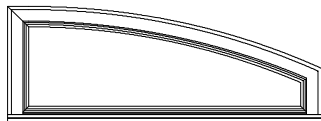

MQPC7224

35 3/32"
30"
29 1/2"
25 7/8"



MQPC7230

41 3/32"
36"
35 1/2"
31 7/8"



MQPC7236

47 3/32"
42"
41 1/2"
37 7/8"

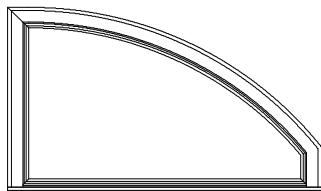

MQPC7242

53 3/32"
48"
47 1/2"
43 7/8"

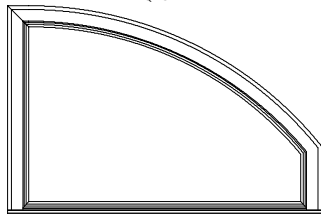

MQPC7248

59 3/32"
54"
53 1/2"
49 7/8"

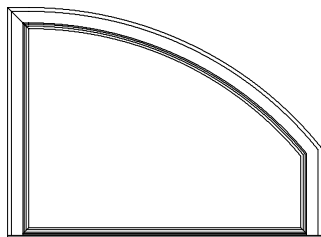

MQPC7254

65 3/32"
60"
59 1/2"
55 7/8"

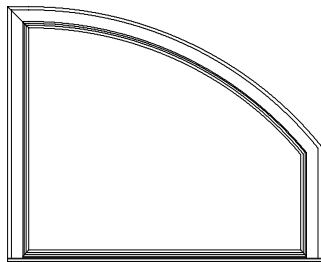

MQPC7260

UNIT SIZE
ROUGH OPENING
FRAME SIZE
DAYLIGHT OPENING

78 13/32"
72"
71 1/2"
67 7/8"

71 3/32"
66"
65 1/2"
61 7/8"

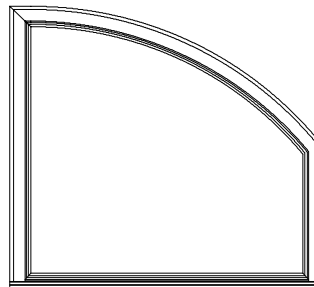

MQPC7266

77 3/32"
72"
71 1/2"
67 7/8"

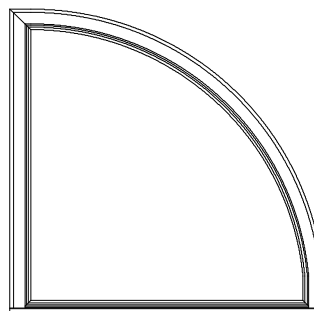

MQPC7272

Note: Elevations shown DO NOT have exterior trim. Subtract 1/2" (12.7) from M.O. (Masonry Opening) for Unit Sizes. Masonry Openings above include Sill Nose, see Trim Options page for Sill Nose specifications. For other Trim Options refer to the Unit Sizing, Rough Opening & Masonry Openings page.

SCALE: 1/4" = 1'

EXTENDED CIRCLE SEGMENT

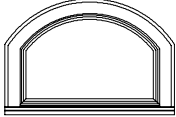
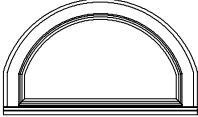
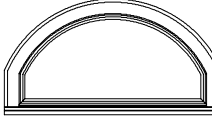
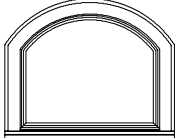
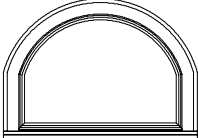
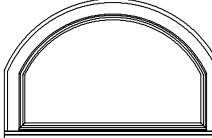
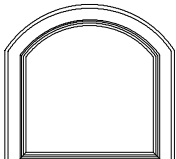
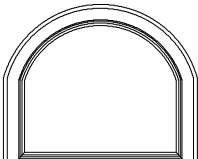
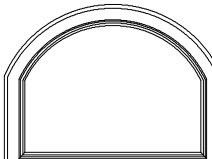
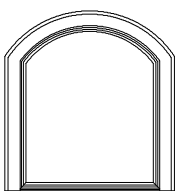
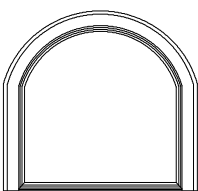
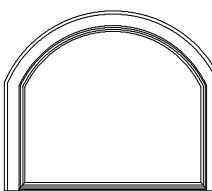
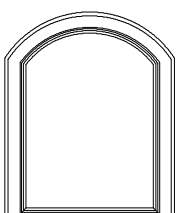
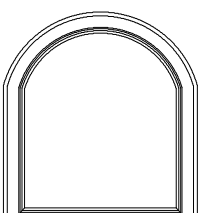
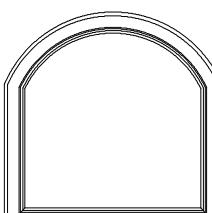
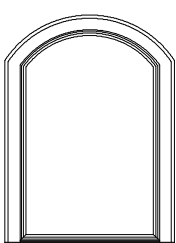
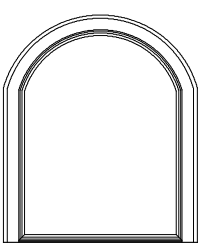
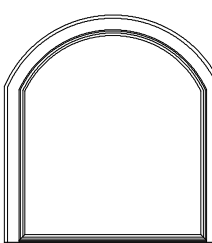
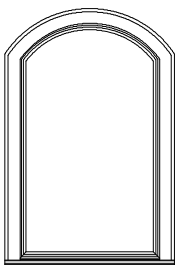
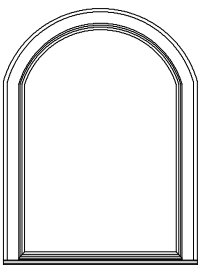
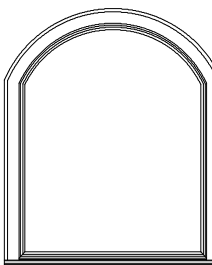
UNIT SIZE ROUGH OPENING FRAME SIZE DAYLIGHT OPENING	42 13/32" 36" 35 1/2" 31 7/8"	48 13/32" 42" 41 1/2" 37 7/8"	54 13/32" 48" 47 1/2" 43 7/8"
29 3/32" 24" 23 1/2" 19 7/8"	 MLPC3624	 MLPC4224	 MLPC4824
35 3/32" 30" 29 1/2" 25 7/8"	 MLPC3630	 MLPC4230	 MLPC4830
41 3/32" 36" 35 1/2" 31 7/8"	 MLPC3636	 MLPC4236	 MLPC4836
47 3/32" 42" 41 1/2" 37 7/8"	 MLPC3642	 MLPC4242	 MLPC4842
53 3/32" 48" 47 1/2" 43 7/8"	 MLPC3648	 MLPC4248	 MLPC4848
59 3/32" 54" 53 1/2" 49 7/8"	 MLPC3654	 MLPC4254	 MLPC4854
65 3/32" 60" 59 1/2" 55 7/8"	 MLPC3660	 MLPC4260	 MLPC4860

Note: Elevations shown DO NOT have exterior trim. Subtract 1/2" (12.7) from M.O. (Masonry Opening) for Unit Sizes. Masonry Openings above include Sill Nose, see Trim Options page for Sill Nose specifications. For other Trim Options refer to the Unit Sizing, Rough Opening & Masonry Openings page.

SCALE: 1/4" = 1'

EXTENDED CIRCLE SEGMENT

UNIT SIZE	42 13/32"	48 13/32"	54 13/32"
ROUGH OPENING	36"	42"	48"
FRAME SIZE	35 1/2"	41 1/2"	47 1/2"
DAYLIGHT OPENING	31 7/8"	37 7/8"	43 7/8"

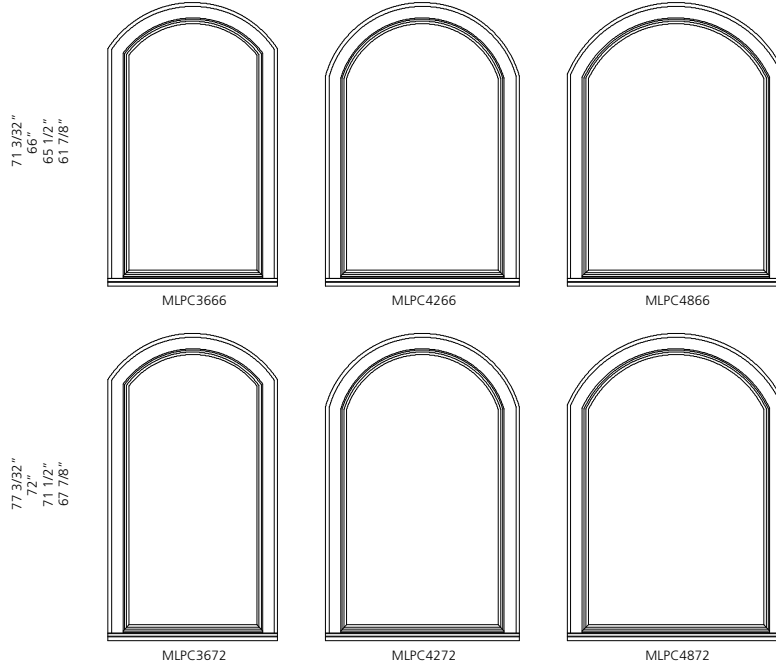

Note: Elevations shown DO NOT have exterior trim. Subtract 1/2" (12.7) from M.O. (Masonry Opening) for Unit Sizes. Masonry Openings above include Sill Nose, see Trim Options page for Sill Nose specifications. For other Trim Options refer to the Unit Sizing, Rough Opening & Masonry Openings page.

SCALE: 1/4" = 1'

EXTENDED CIRCLE SEGMENT

UNIT SIZE
ROUGH OPENING
FRAME SIZE
DAYLIGHT OPENING

60 13/32"
54"
53 1/2"
49 7/8"

66 13/32"
60"
59 1/2"
55 7/8"

72 13/32"
66"
65 1/2"
61 7/8"

29 3/32"
24"
23 1/2"
19 7/8"

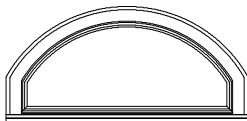

MLPC5424

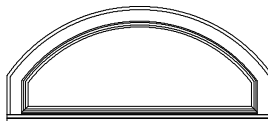

MLPC6024

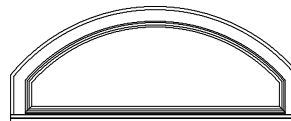

MLPC6624

35 3/32"
30"
29 1/2"
25 7/8"

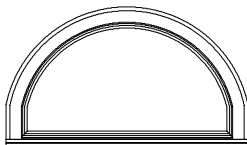

MLPC5430

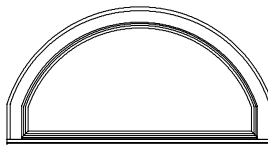

MLPC6030

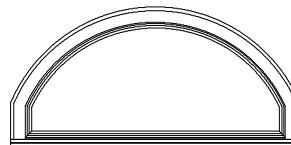

MLPC6630

41 3/32"
36"
35 1/2"
31 7/8"

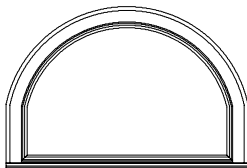

MLPC5436

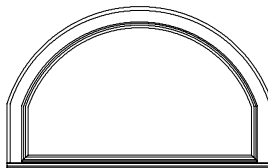

MLPC6036

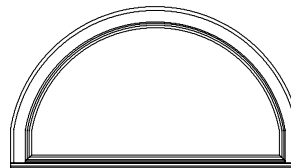

MLPC6636

47 3/32"
42"
41 1/2"
37 7/8"

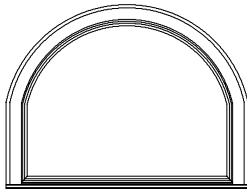

MLPC5442

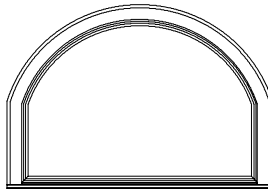

MLPC6042

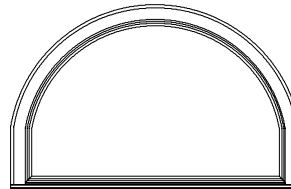

MLPC6642

53 3/32"
48"
47 1/2"
43 7/8"

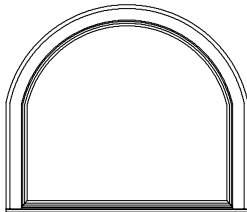

MLPC5448

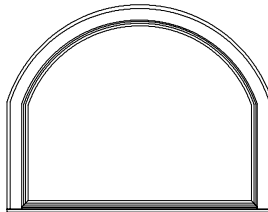

MLPC6048

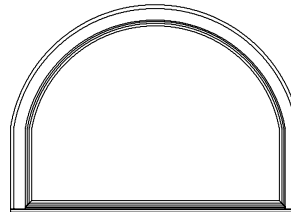

MLPC6648

59 3/32"
54"
53 1/2"
49 7/8"

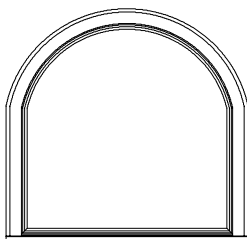

MLPC5454

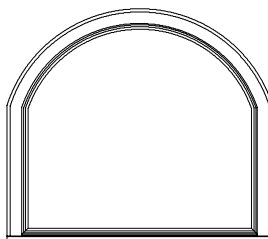

MLPC6054

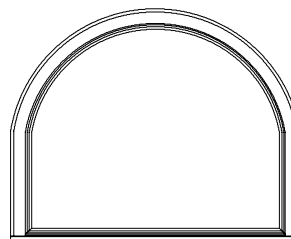

MLPC6654

65 3/32"
60"
59 1/2"
55 7/8"

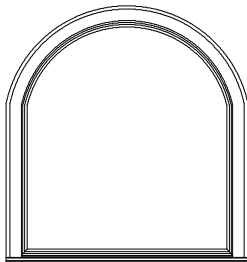

MLPC5460

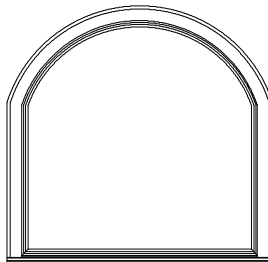

MLPC6060

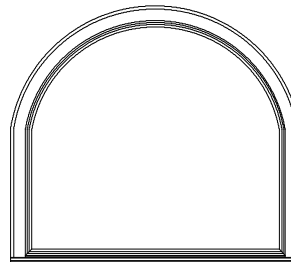

MLPC6660

Note: Elevations shown DO NOT have exterior trim. Subtract 1/2" (12.7) from M.O. (Masonry Opening) for Unit Sizes. Masonry Openings above include Sill Nose, see Trim Options page for Sill Nose specifications. For other Trim Options refer to the Unit Sizing, Rough Opening & Masonry Openings page.

SCALE: 1/4" = 1'

EXTENDED CIRCLE SEGMENT

UNIT SIZE
ROUGH OPENING
FRAME SIZE
DAYLIGHT OPENING

60 13/32"
54"
53 1/2"
49 7/8"

66 13/32"
60"
59 1/2"
55 7/8"

72 13/32"
66"
65 1/2"
61 7/8"

71 3/32"
66"
65 1/2"
61 7/8"

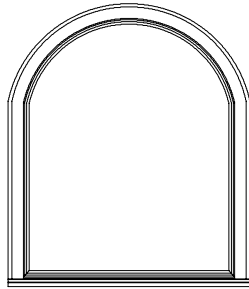

MLPC5466

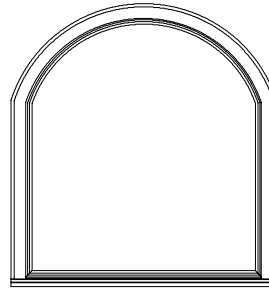

MLPC6066

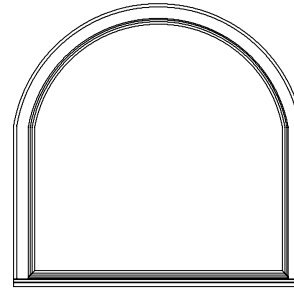

MLPC6666

77 3/32"
72"
71 1/2"
67 7/8"

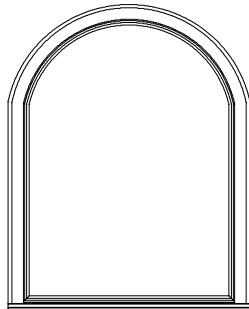

MLPC5472

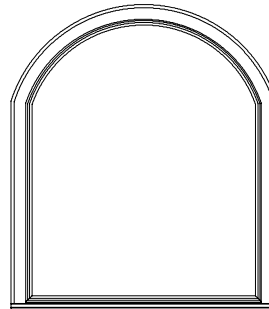

MLPC6072

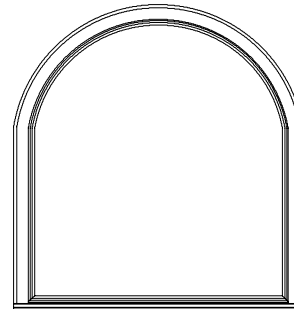

MLPC6672

Note: Elevations shown DO NOT have exterior trim. Subtract 1/2" (12.7) from M.O. (Masonry Opening) for Unit Sizes. Masonry Openings above include Sill Nose, see Trim Options page for Sill Nose specifications. For other Trim Options refer to the Unit Sizing, Rough Opening & Masonry Openings page.

SCALE: 1/4" = 1'

EXTENDED CIRCLE SEGMENT

UNIT SIZE
ROUGH OPENING
FRAME SIZE
DAYLIGHT OPENING

78 13/32"
72"
71 1/2"
67 7/8"

UNIT SIZE
ROUGH OPENING
FRAME SIZE
DAYLIGHT OPENING

78 13/32"
72"
71 1/2"
67 7/8"

29 3/32"
24"
23 1/2"
19 7/8"

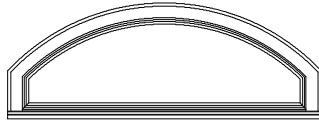

MLPC7224

35 3/32"
30"
29 1/2"
25 7/8"

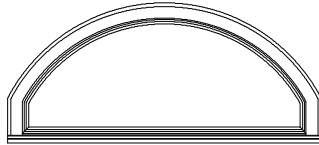

MLPC7230

41 3/32"
36"
35 1/2"
31 7/8"

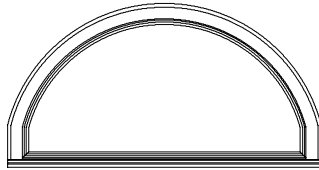

MLPC7236

47 3/32"
42"
41 1/2"
37 7/8"

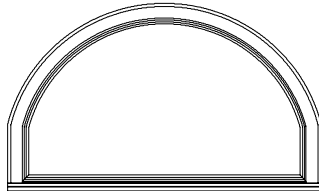

MLPC7242

53 3/32"
48"
47 1/2"
43 7/8"

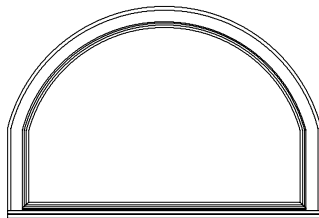

MLPC7248

59 3/32"
54"
53 1/2"
49 7/8"

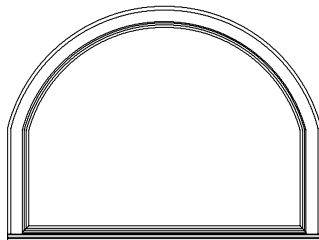

MLPC7254

65 3/32"
60"
59 1/2"
55 7/8"

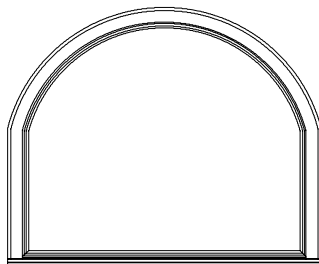

MLPC7260

71 3/32"
66"
65 1/2"
61 7/8"

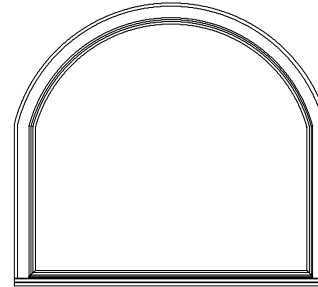

MLPC7266

77 3/32"
72"
71 1/2"
67 7/8"

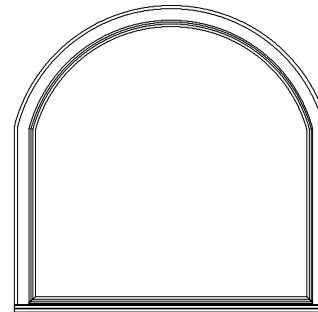

MLPC7272

Note: Elevations shown DO NOT have exterior trim. Subtract 1/2" (12.7) from M.O. (Masonry Opening) for Unit Sizes. Masonry Openings above include Sill Nose, see Trim Options page for Sill Nose specifications. For other Trim Options refer to the Unit Sizing, Rough Opening & Masonry Openings page.

SCALE: 1/4" = 1'

LEFT TRAPEZOID

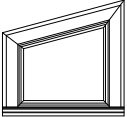
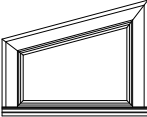
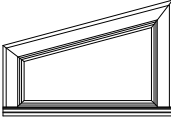
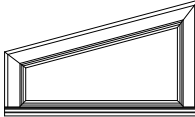
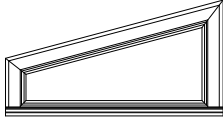
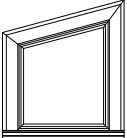
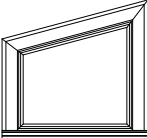
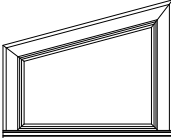
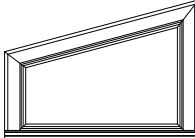
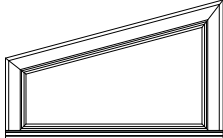
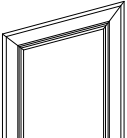
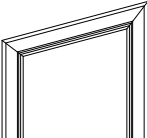
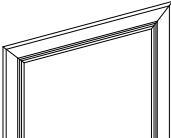
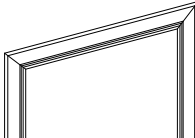
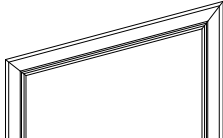
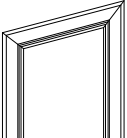
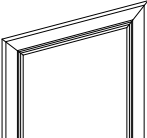
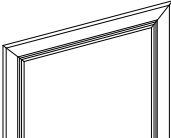
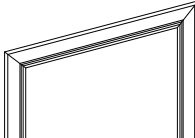
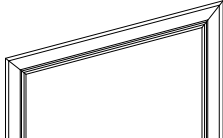
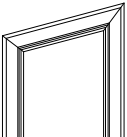
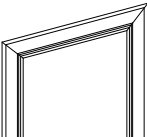
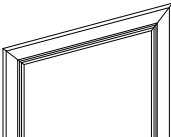
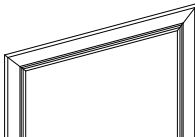
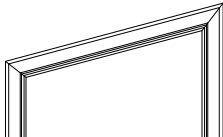
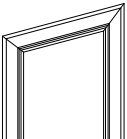
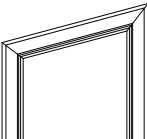
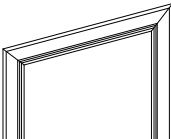
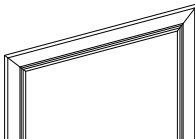
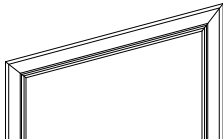
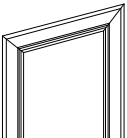
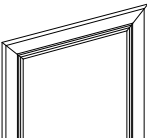
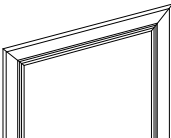
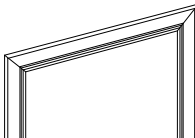
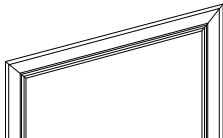
UNIT SIZE ROUGH OPENING FRAME SIZE DAYLIGHT OPENING	30 13/32" 24" 23 1/2" 19 7/8"	36 13/32" 30" 29 1/2" 25 7/8"	42 13/32" 36" 35 1/2" 31 7/8"	48 13/32" 42" 41 1/2" 37 7/8"	54 13/32" 48" 47 1/2" 43 7/8"
29 3/32" 24" 23 1/2" 19 7/8"	 7LATC2424	 7LATC3024	 7LATC3624	 7LATC4224	 7LATC4824
35 3/32" 30" 29 1/2" 25 7/8"	 7LATC2430	 7LATC3030	 7LATC3630	 7LATC4230	 7LATC4830
41 3/32" 36" 35 1/2" 31 7/8"	 7LATC2436	 7LATC3036	 7LATC3636	 7LATC4236	 7LATC4836
47 3/32" 42" 41 1/2" 37 7/8"	 7LATC2442	 7LATC3042	 7LATC3642	 7LATC4242	 7LATC4842
53 3/32" 48" 47 1/2" 43 7/8"	 7LATC2448	 7LATC3048	 7LATC3648	 7LATC4248	 7LATC4848
59 3/32" 54" 53 1/2" 49 7/8"	 7LATC2454	 7LATC3054	 7LATC3654	 7LATC4254	 7LATC4854
65 3/32" 60" 59 1/2" 55 7/8"	 7LATC2460	 7LATC3060	 7LATC3660	 7LATC4260	 7LATC4860

Note: Elevations shown DO NOT have exterior trim. Subtract 1/2" (12.7) from M.O. (Masonry Opening) for Unit Sizes. Masonry Openings above include Sill Nose, see Trim Options page for Sill Nose specifications. For other Trim Options refer to the Unit Sizing, Rough Opening & Masonry Openings page.

SCALE: 1/4" = 1'

LEFT TRAPEZOID

UNIT SIZE
ROUGH OPENING
FRAME SIZE
DAYLIGHT OPENING

30 13/32"
24"
23 1/2"
19 7/8"

36 13/32"
30"
29 1/2"
25 7/8"

42 13/32"
36"
35 1/2"
31 7/8"

48 13/32"
42"
41 1/2"
37 7/8"

54 13/32"
48"
47 1/2"
43 7/8"

71 3/32"
66"
65 1/2"
61 7/8"

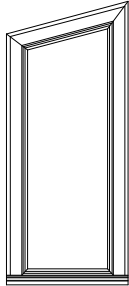

7LATC2466

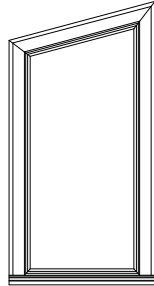

7LATC3066

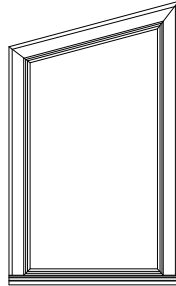

7LATC3666

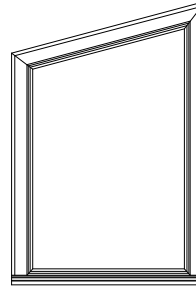

7LATC4266

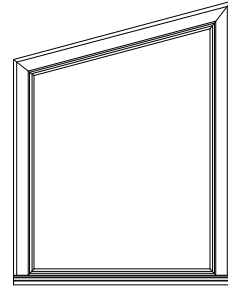

7LATC4866

77 3/32"
72"
71 1/2"
67 7/8"

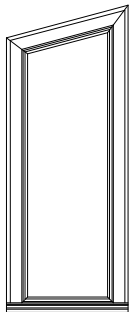

7LATC2472

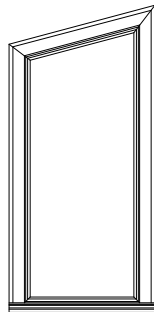

7LATC3072

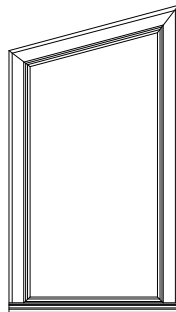

7LATC3672

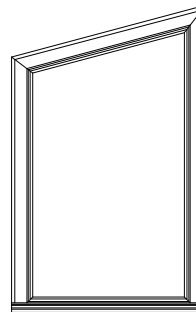

7LATC4272

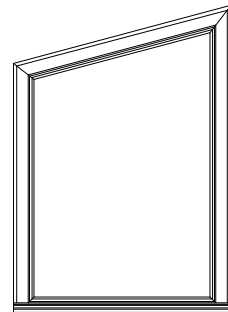

7LATC4872

Note: Elevations shown DO NOT have exterior trim. Subtract 1/2" (12.7) from M.O. (Masonry Opening) for Unit Sizes. Masonry Openings above include Sill Nose, see Trim Options page for Sill Nose specifications. For other Trim Options refer to the Unit Sizing, Rough Opening & Masonry Openings page.

SCALE: 1/4" = 1'

LEFT TRAPEZOID

UNIT SIZE
ROUGH OPENING
FRAME SIZE
DAYLIGHT OPENING

60 13/32"
54"
53 1/2"
49 7/8"

66 13/32"
60"
59 1/2"
55 7/8"

72 13/32"
66"
65 1/2"
61 7/8"

29 3/32"
24"
23 1/2"
19 7/8"



7LATC5424



7LATC6024



7LATC6624

35 3/32"
30"
29 1/2"
25 7/8"



7LATC5430



7LATC6030



7LATC6630

41 3/32"
36"
35 1/2"
31 7/8"

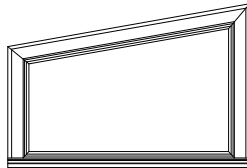

7LATC5436

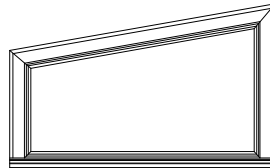

7LATC6036

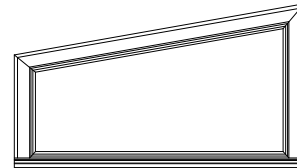

7LATC6636

47 3/32"
42"
41 1/2"
37 7/8"

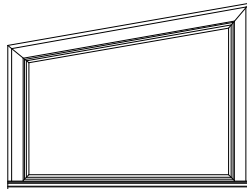

7LATC5442

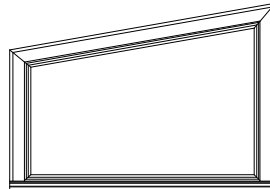

7LATC6042

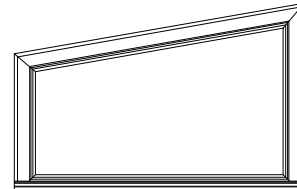

7LATC6642

53 3/32"
48"
47 1/2"
43 7/8"

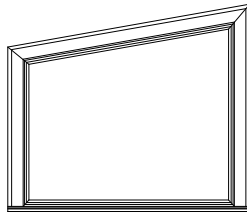

7LATC5448

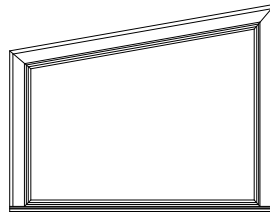

7LATC6048

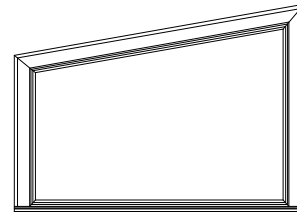

7LATC6648

59 3/32"
54"
53 1/2"
49 7/8"

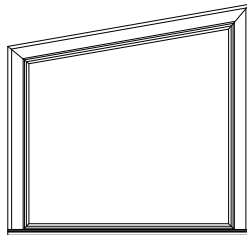

7LATC5454

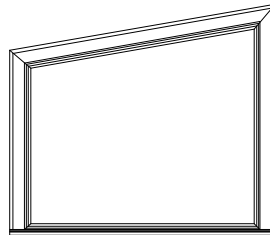

7LATC6054

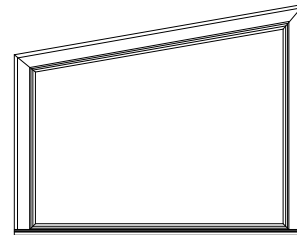

7LATC6654

65 3/32"
60"
59 1/2"
55 7/8"

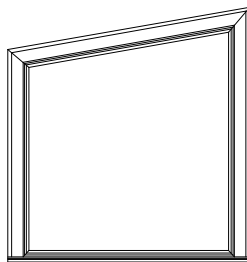

7LATC5460

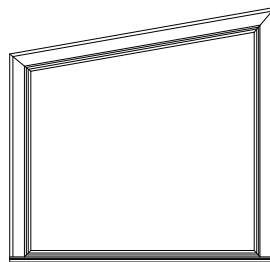

7LATC6060

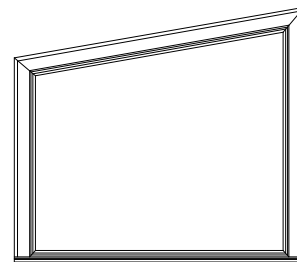

7LATC6660

Note: Elevations shown DO NOT have exterior trim. Subtract 1/2" (12.7) from M.O. (Masonry Opening) for Unit Sizes. Masonry Openings above include Sill Nose, see Trim Options page for Sill Nose specifications. For other Trim Options refer to the Unit Sizing, Rough Opening & Masonry Openings page.

SCALE: 1/4" = 1'

LEFT TRAPEZOID

UNIT SIZE
ROUGH OPENING
FRAME SIZE
DAYLIGHT OPENING

60 13/32"
54"
53 1/2"
49 7/8"

66 13/32"
60"
59 1/2"
55 7/8"

72 13/32"
66"
65 1/2"
61 7/8"

71 3/32"
66"
65 1/2"
61 7/8"

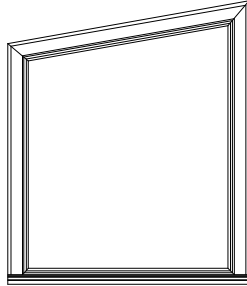

7LATC5466

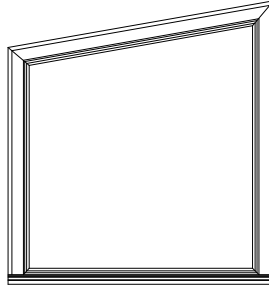

7LATC6066

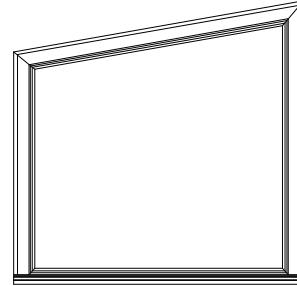

7LATC6666

77 3/32"
72"
71 1/2"
67 7/8"

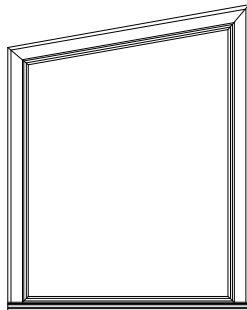

7LATC5472

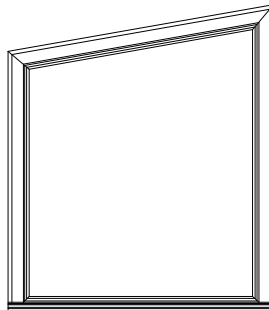

7LATC6072

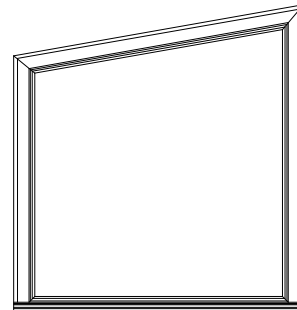

7LATC6672

Note: Elevations shown DO NOT have exterior trim. Subtract 1/2" (12.7) from M.O. (Masonry Opening) for Unit Sizes. Masonry Openings above include Sill Nose, see Trim Options page for Sill Nose specifications. For other Trim Options refer to the Unit Sizing, Rough Opening & Masonry Openings page.

SCALE: 1/4" = 1'

LEFT TRAPEZOID

UNIT SIZE
ROUGH OPENING
FRAME SIZE
DAYLIGHT OPENING

78 13/32"
72"
71 1/2"
67 7/8"

29 3/32"
24"
23 1/2"
19 7/8"

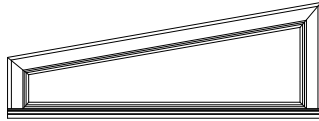

7LATC7224

35 3/32"
30"
29 1/2"
25 7/8"

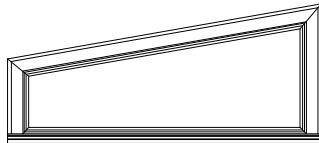

7LATC7230

41 3/32"
36"
35 1/2"
31 7/8"

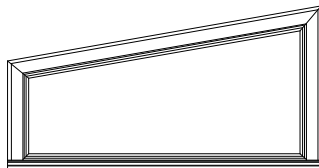

7LATC7236

47 3/32"
42"
41 1/2"
37 7/8"

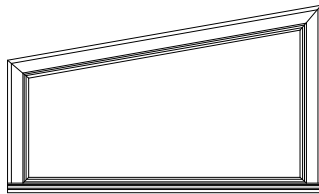

7LATC7242

53 3/32"
48"
47 1/2"
43 7/8"

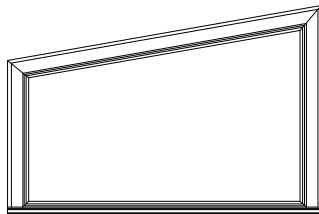

7LATC7248

59 3/32"
54"
53 1/2"
49 7/8"

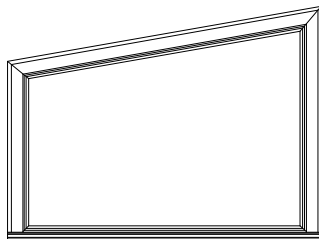

7LATC7254

65 3/32"
60"
59 1/2"
55 7/8"

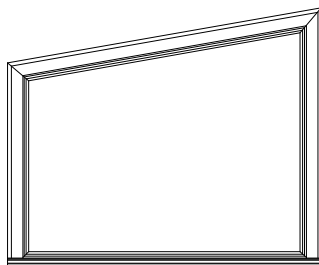

7LATC7260

UNIT SIZE
ROUGH OPENING
FRAME SIZE
DAYLIGHT OPENING

78 13/32"
72"
71 1/2"
67 7/8"

71 3/32"
66"
65 1/2"
61 7/8"

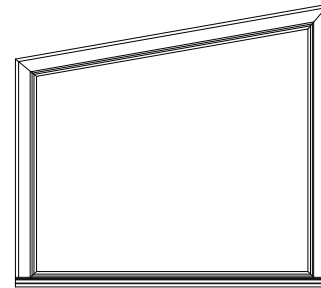

7LATC7266

77 3/32"
72"
71 1/2"
67 7/8"

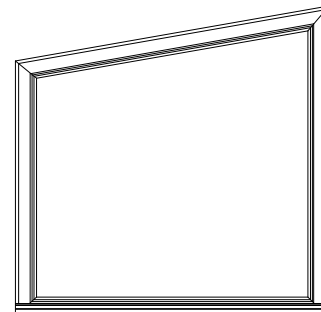

7LATC7272

Note: Elevations shown DO NOT have exterior trim. Subtract 1/2" (12.7) from M.O. (Masonry Opening) for Unit Sizes. Masonry Openings above include Sill Nose, see Trim Options page for Sill Nose specifications. For other Trim Options refer to the Unit Sizing, Rough Opening & Masonry Openings page.

SCALE: 1/4" = 1'

RIGHT TRAPEZOID

UNIT SIZE
ROUGH OPENING
FRAME SIZE
DAYLIGHT OPENING

30 13/32"
24"
23 1/2"
19 7/8"

36 13/32"
30"
29 1/2"
25 7/8"

42 13/32"
36"
35 1/2"
31 7/8"

48 13/32"
42"
41 1/2"
37 7/8"

54 13/32"
48"
47 1/2"
43 7/8"

29 3/32"
24"
23 1/2"
19 7/8"

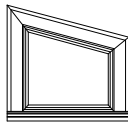

7RATC2424

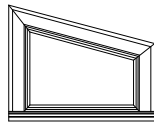

7RATC3024

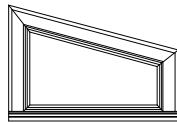

7RATC3624



7RATC4224



7RATC4824

35 3/32"
30"
29 1/2"
25 7/8"

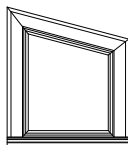

7RATC2430

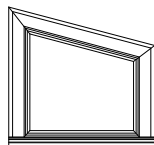

7RATC3030

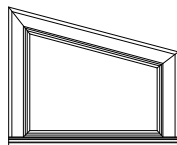

7RATC3630

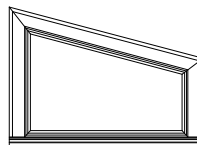

7RATC4230

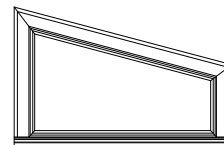

7RATC4830

41 3/32"
36"
35 1/2"
31 7/8"

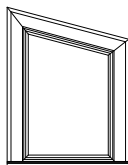

7RATC2436

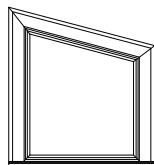

7RATC3036

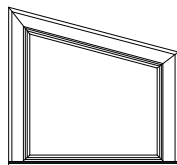

7RATC3636

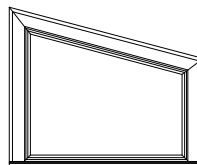

7RATC4236

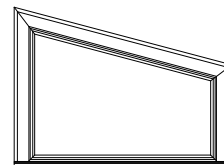

7RATC4836

47 3/32"
42"
41 1/2"
37 7/8"

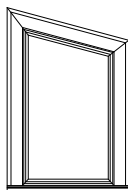

7RATC2442

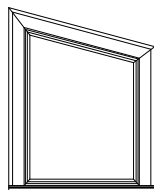

7RATC3042

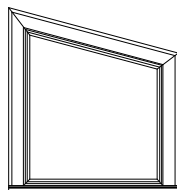

7RATC3642

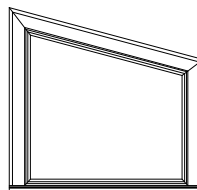

7RATC4242

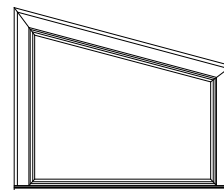

7RATC4842

53 3/32"
48"
47 1/2"
43 7/8"

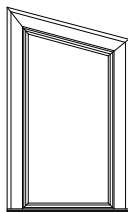

7RATC2448

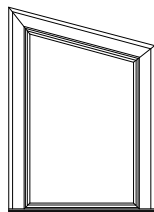

7RATC3048

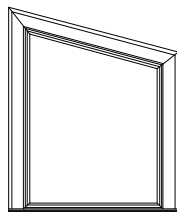

7RATC3648

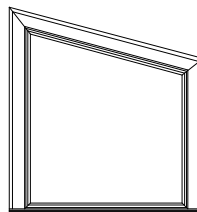

7RATC4248

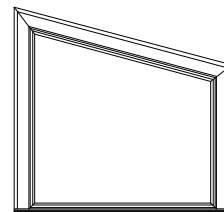

7RATC4848

59 3/32"
54"
53 1/2"
49 7/8"

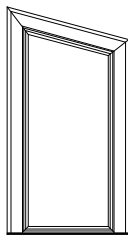

7RATC2454

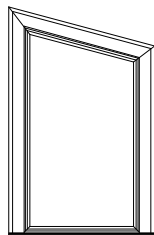

7RATC3054

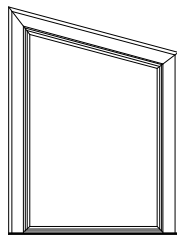

7RATC3654

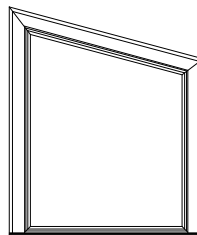

7RATC4254

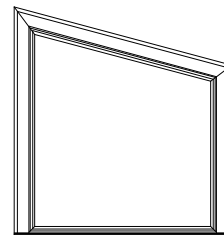

7RATC4854

65 3/32"
60"
59 1/2"
55 7/8"

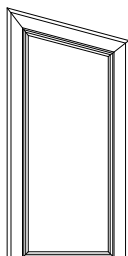

7RATC2460

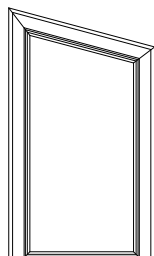

7RATC3060

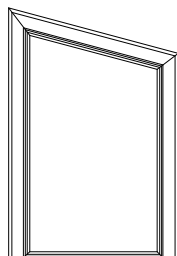

7RATC3660

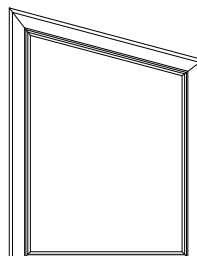

7RATC4260

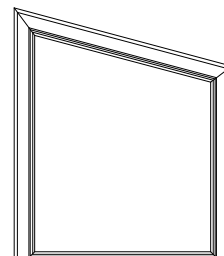

7RATC4860

Note: Elevations shown DO NOT have exterior trim. Subtract 1/2" (12.7) from M.O. (Masonry Opening) for Unit Sizes. Masonry Openings above include Sill Nose, see Trim Options page for Sill Nose specifications. For other Trim Options refer to the Unit Sizing, Rough Opening & Masonry Openings page.

SCALE: 1/4" = 1'

RIGHT TRAPEZOID

UNIT SIZE
ROUGH OPENING
FRAME SIZE
DAYLIGHT OPENING

30 13/32"
24"
23 1/2"
19 7/8"

36 13/32"
30"
29 1/2"
25 7/8"

42 13/32"
36"
35 1/2"
31 7/8"

48 13/32"
42"
41 1/2"
37 7/8"

54 13/32"
48"
47 1/2"
43 7/8"

71 3/32"
66"
65 1/2"
61 7/8"

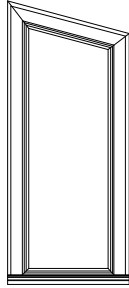

7RATC2466

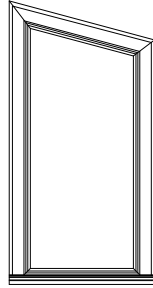

7RATC3066

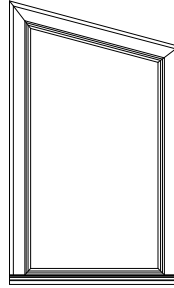

7RATC3666

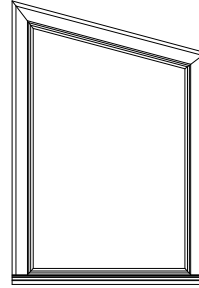

7RATC4266

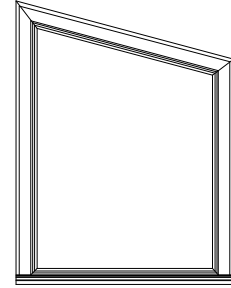

7RATC4866

77 3/32"
72"
71 1/2"
67 7/8"

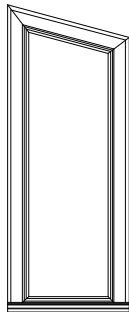

7RATC2472

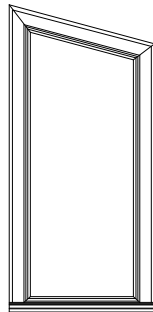

7RATC3072

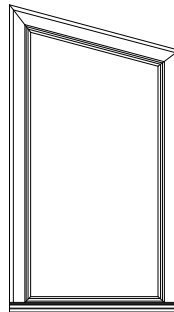

7RATC3672

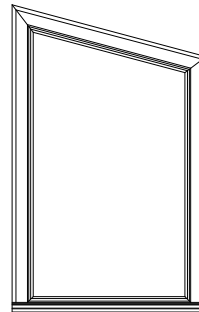

7RATC4272

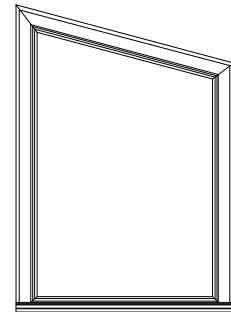

7RATC4872

Note: Elevations shown DO NOT have exterior trim. Subtract 1/2" (12.7) from M.O. (Masonry Opening) for Unit Sizes. Masonry Openings above include Sill Nose, see Trim Options page for Sill Nose specifications. For other Trim Options refer to the Unit Sizing, Rough Opening & Masonry Openings page.

SCALE: 1/4" = 1'

RIGHT TRAPEZOID

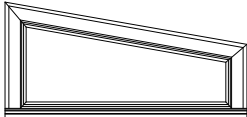
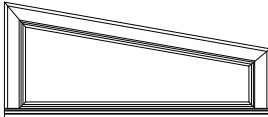
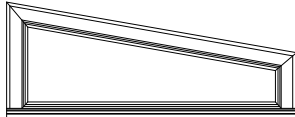
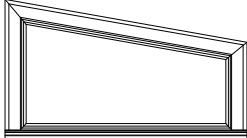
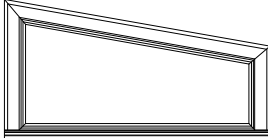
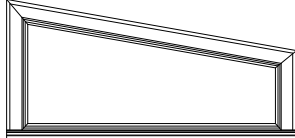
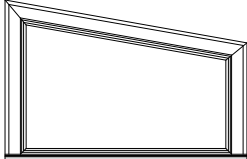
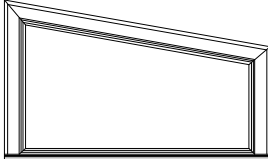
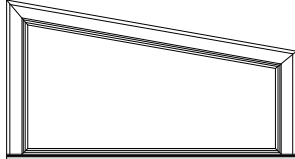
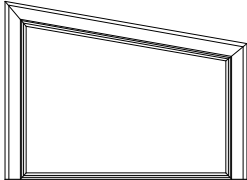
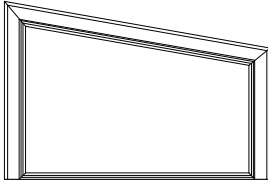
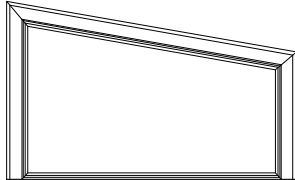
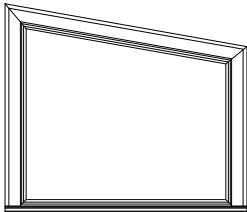
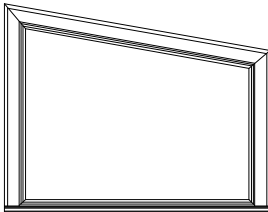
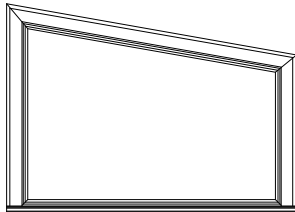
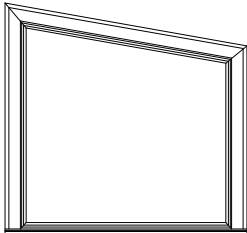
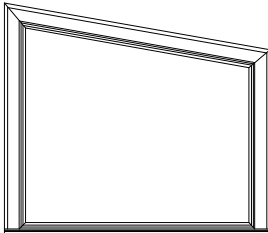
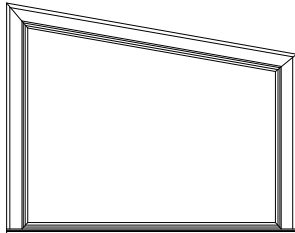
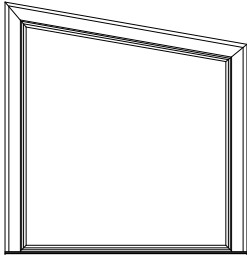
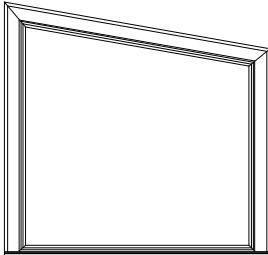
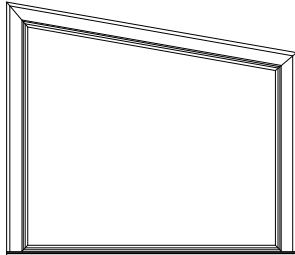
UNIT SIZE ROUGH OPENING FRAME SIZE DAYLIGHT OPENING	60 13/32" 54" 53 1/2" 49 7/8"	66 13/32" 60" 59 1/2" 55 7/8"	72 13/32" 66" 65 1/2" 61 7/8"
29 3/32" 34" 33 1/2" 19 7/8"	 7RATC5424	 7RATC6024	 7RATC6624
35 3/32" 40" 39 1/2" 25 7/8"	 7RATC5430	 7RATC6030	 7RATC6630
41 3/32" 46" 45 1/2" 31 7/8"	 7RATC5436	 7RATC6036	 7RATC6636
47 3/32" 52" 51 1/2" 37 7/8"	 7RATC5442	 7RATC6042	 7RATC6642
53 3/32" 58" 57 1/2" 43 7/8"	 7RATC5448	 7RATC6048	 7RATC6648
59 3/32" 64" 63 1/2" 49 7/8"	 7RATC5454	 7RATC6054	 7RATC6654
65 3/32" 70" 69 1/2" 55 7/8"	 7RATC5460	 7RATC6060	 7RATC6660

Note: Elevations shown DO NOT have exterior trim. Subtract 1/2" (12.7) from M.O. (Masonry Opening) for Unit Sizes. Masonry Openings above include Sill Nose, see Trim Options page for Sill Nose specifications. For other Trim Options refer to the Unit Sizing, Rough Opening & Masonry Openings page.

SCALE: 1/4" = 1'

RIGHT TRAPEZOID

UNIT SIZE
ROUGH OPENING
FRAME SIZE
DAYLIGHT OPENING

60 13/32"
54"
53 1/2"
49 7/8"

66 13/32"
60"
59 1/2"
55 7/8"

72 13/32"
66"
65 1/2"
61 7/8"

71 3/32"
66"
65 1/2"
61 7/8"

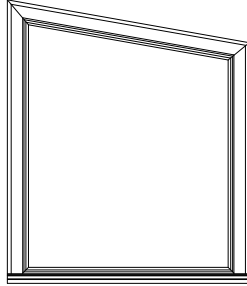

7RATC5466

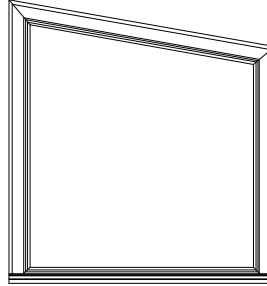

7RATC6066

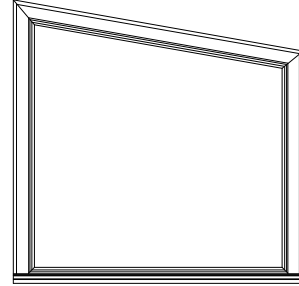

7RATC6666

77 3/32"
72"
71 1/2"
67 7/8"

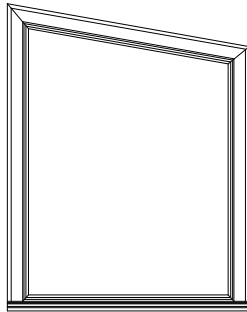

7RATC5472

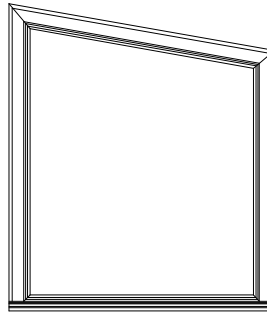

7RATC6072

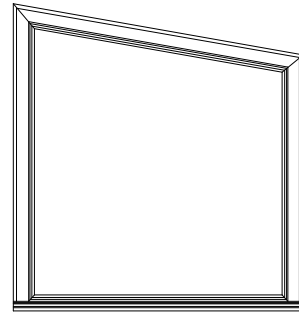

7RATC6672

Note: Elevations shown DO NOT have exterior trim. Subtract 1/2" (12.7) from M.O. (Masonry Opening) for Unit Sizes. Masonry Openings above include Sill Nose, see Trim Options page for Sill Nose specifications. For other Trim Options refer to the Unit Sizing, Rough Opening & Masonry Openings page.

SCALE: 1/4" = 1'

RIGHT TRAPEZOID

UNIT SIZE
ROUGH OPENING
FRAME SIZE
DAYLIGHT OPENING

78 13/32"
72"
71 1/2"
67 7/8"

UNIT SIZE
ROUGH OPENING
FRAME SIZE
DAYLIGHT OPENING

78 13/32"
72"
71 1/2"
67 7/8"

29 3/32"
24"
23 1/2"
19 7/8"

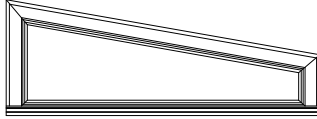

7RATC7224

35 3/32"
30"
29 1/2"
25 7/8"



7RATC7230

41 3/32"
36"
35 1/2"
31 7/8"

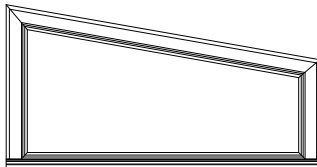

7RATC7236

47 3/32"
42"
41 1/2"
37 7/8"

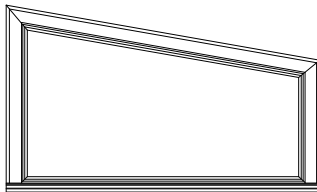

7RATC7242

53 3/32"
48"
47 1/2"
43 7/8"

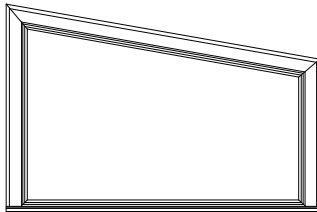

7RATC7248

59 3/32"
54"
53 1/2"
49 7/8"

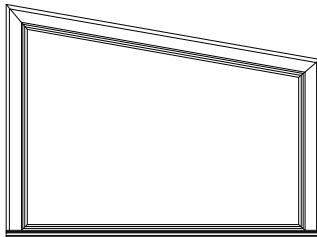

7RATC7254

65 3/32"
60"
59 1/2"
55 7/8"

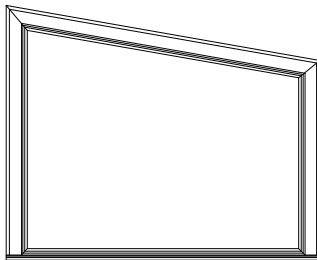

7RATC7260

71 3/32"
66"
65 1/2"
61 7/8"

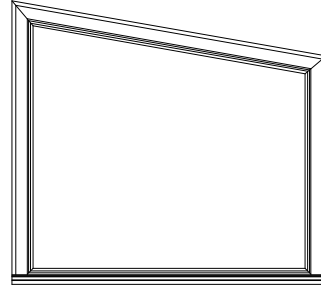

7RATC7266

77 3/32"
72"
71 1/2"
67 7/8"

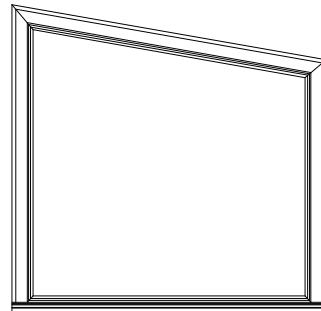



7RATC7272

Note: Elevations shown DO NOT have exterior trim. Subtract 1/2" (12.7) from M.O. (Masonry Opening) for Unit Sizes. Masonry Openings above include Sill Nose, see Trim Options page for Sill Nose specifications. For other Trim Options refer to the Unit Sizing, Rough Opening & Masonry Openings page.

SCALE: 1/4" = 1'

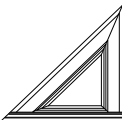
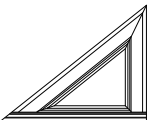
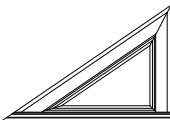
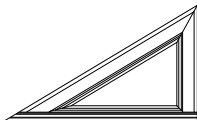
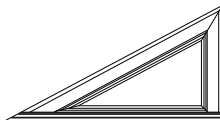
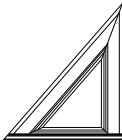
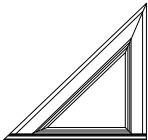
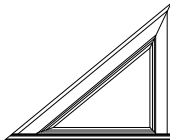
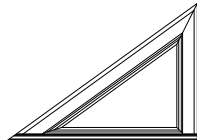
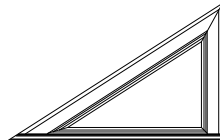
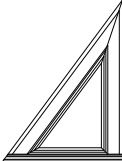
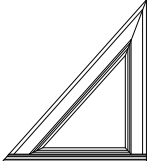
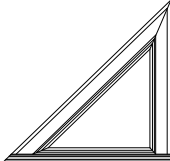
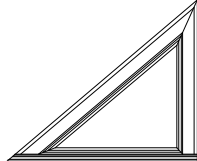
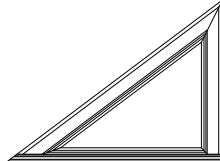
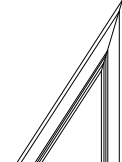
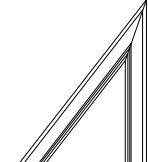
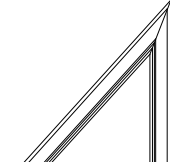
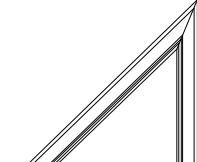
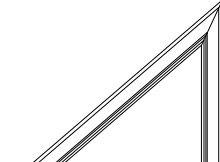
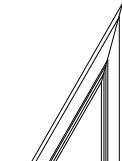
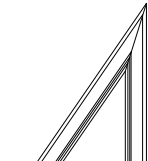
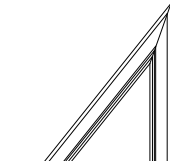
LEFT TRIANGLE

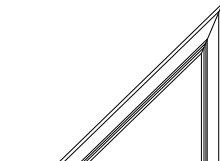
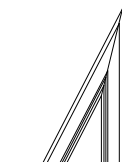
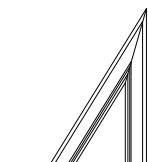
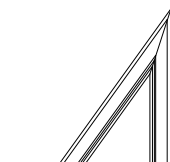
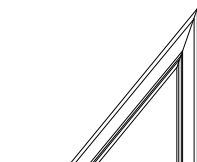
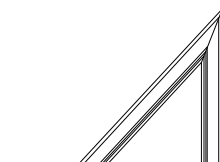
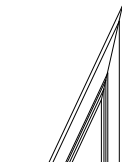
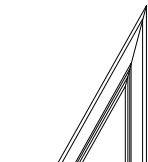
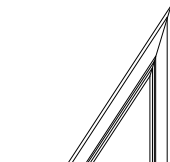
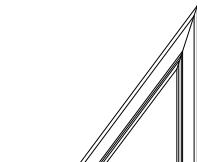
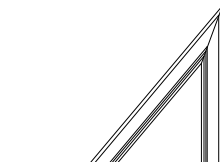
UNIT SIZE ROUGH OPENING FRAME SIZE DAYLIGHT OPENING	30 13/32" 24" 23 1/2" 19 7/8"	36 13/32" 30" 29 1/2" 25 7/8"	42 13/32" 36" 35 1/2" 31 7/8"	48 13/32" 42" 41 1/2" 37 7/8"	54 13/32" 48" 47 1/2" 43 7/8"
29 3/32" 24" 23 1/2" 19 7/8"	 7LRAC2424	 7LRAC3024	 7LRAC3624	 7LRAC4224	 7LRAC4824
35 3/32" 30" 29 1/2" 25 7/8"	 7LRAC2430	 7LRAC3030	 7LRAC3630	 7LRAC4230	 7LRAC4830
41 3/32" 36" 35 1/2" 31 7/8"	 7LRAC2436	 7LRAC3036	 7LRAC3636	 7LRAC4236	 7LRAC4836
47 3/32" 42" 41 1/2" 37 7/8"	 7LRAC2442	 7LRAC3042	 7LRAC3642	 7LRAC4242	 7LRAC4842
53 3/32" 48" 47 1/2" 43 7/8"	 7LRAC2448	 7LRAC3048	 7LRAC3648	 7LRAC4248	 7LRAC4848
59 3/32" 54" 53 1/2" 49 7/8"	 7LRAC2454	 7LRAC3054	 7LRAC3654	 7LRAC4254	 7LRAC4854
65 3/32" 60" 59 1/2" 55 7/8"	 7LRAC2460	 7LRAC3060	 7LRAC3660	 7LRAC4260	 7LRAC4860

Note: Elevations shown DO NOT have exterior trim. Subtract 1/2" (12.7) from M.O. (Masonry Opening) for Unit Sizes. Masonry Openings above include Sill Nose, see Trim Options page for Sill Nose specifications. For other Trim Options refer to the Unit Sizing, Rough Opening & Masonry Openings page.

SCALE: 1/4" = 1'

LEFT TRIANGLE

UNIT SIZE
ROUGH OPENING
FRAME SIZE
DAYLIGHT OPENING

30 13/32"
24"
23 1/2"
19 7/8"

36 13/32"
30"
29 1/2"
25 7/8"

42 13/32"
36"
35 1/2"
31 7/8"

48 13/32"
42"
41 1/2"
37 7/8"

54 13/32"
48"
47 1/2"
43 7/8"

71 3/32"
66"
65 1/2"
61 7/8"

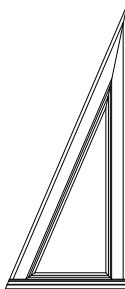

7LRAC2466

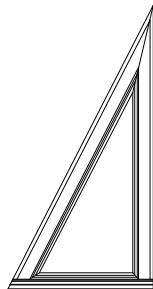

7LRAC3066

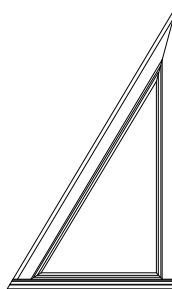

7LRAC3666

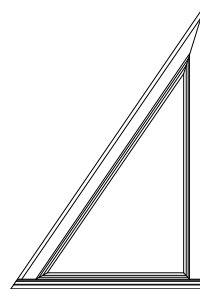

7LRAC4266

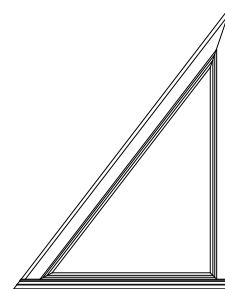

7LRAC4866

77 3/32"
72"
71 1/2"
67 7/8"

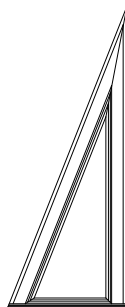

7LRAC2472

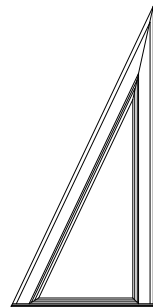

7LRAC3072

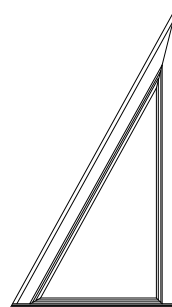

7LRAC3672

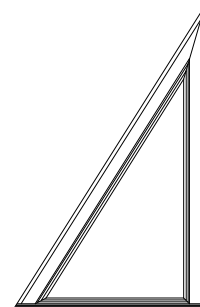

7LRAC4272

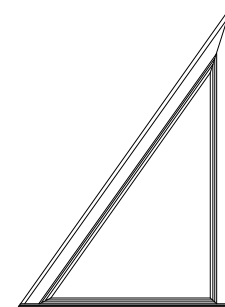

7LRAC4872

Note: Elevations shown DO NOT have exterior trim. Subtract 1/2" (12.7) from M.O. (Masonry Opening) for Unit Sizes. Masonry Openings above include Sill Nose, see Trim Options page for Sill Nose specifications. For other Trim Options refer to the Unit Sizing, Rough Opening & Masonry Openings page.

SCALE: 1/4" = 1'

LEFT TRIANGLE

UNIT SIZE
ROUGH OPENING
FRAME SIZE
DAYLIGHT OPENING

60 13/32"
54"
53 1/2"
49 7/8"

66 13/32"
60"
59 1/2"
55 7/8"

72 13/32"
66"
65 1/2"
61 7/8"

29 3/32"
24"
23 1/2"
19 7/8"

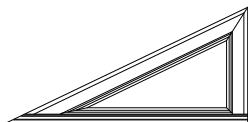

7LRAC5424

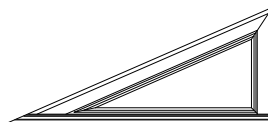

7LRAC6024

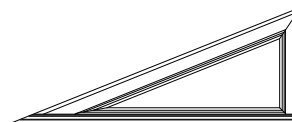

7LRAC6624

35 3/32"
30"
29 1/2"
25 7/8"

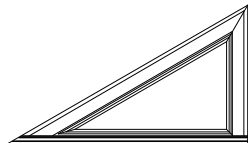

7LRAC5430

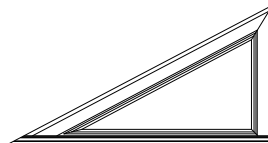

7LRAC6030

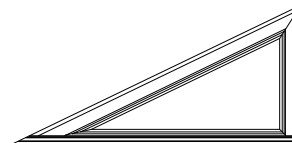

7LRAC6630

41 3/32"
36"
35 1/2"
31 7/8"

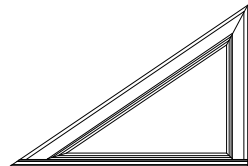

7LRAC5436

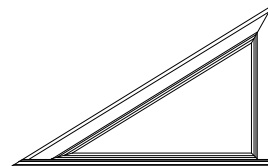

7LRAC6036

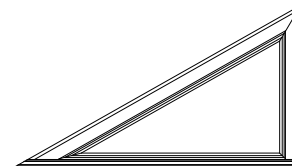

7LRAC6636

47 3/32"
42"
41 1/2"
37 7/8"

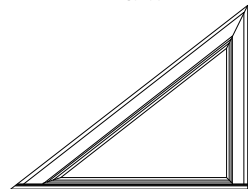

7LRAC5442

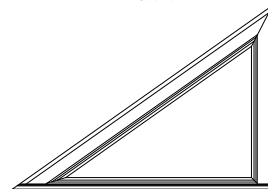

7LRAC6042

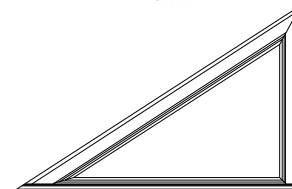

7LRAC6642

53 3/32"
48"
47 1/2"
43 7/8"

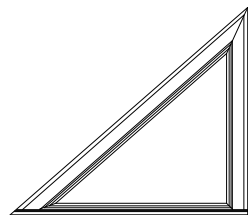

7LRAC5448

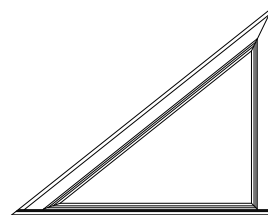

7LRAC6048

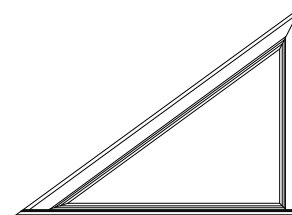

7LRAC6648

59 3/32"
54"
53 1/2"
49 7/8"

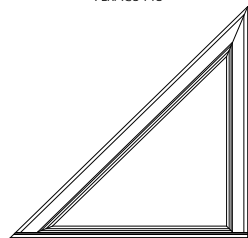

7LRAC5454

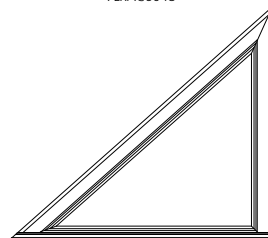

7LRAC6054

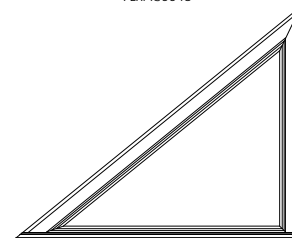

7LRAC6654

65 3/32"
60"
59 1/2"
55 7/8"

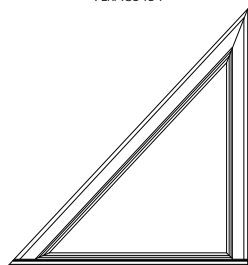

7LRAC5460

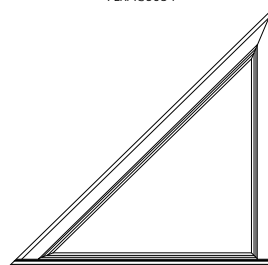

7LRAC6060

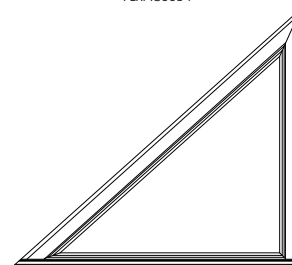

7LRAC6660

Note: Elevations shown DO NOT have exterior trim. Subtract 1/2" (12.7) from M.O. (Masonry Opening) for Unit Sizes. Masonry Openings above include Sill Nose, see Trim Options page for Sill Nose specifications. For other Trim Options refer to the Unit Sizing, Rough Opening & Masonry Openings page.

SCALE: 1/4" = 1'

LEFT TRIANGLE

UNIT SIZE
ROUGH OPENING
FRAME SIZE
DAYLIGHT OPENING

60 13/32"
54"
53 1/2"
49 7/8"

66 13/32"
60"
59 1/2"
55 7/8"

72 13/32"
66"
65 1/2"
61 7/8"

71 3/32"
66"
65 1/2"
61 7/8"

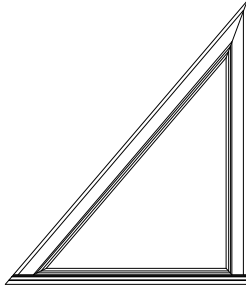

7LRAC5466

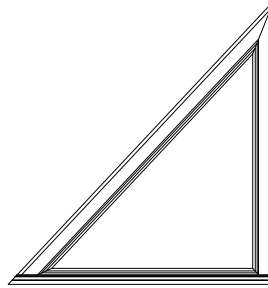

7LRAC6066

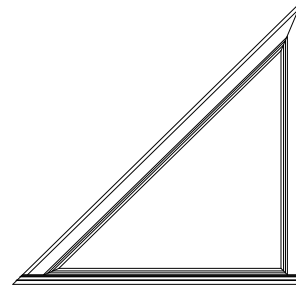

7LRAC6666

71 3/32"
72"
71 1/2"
67 7/8"

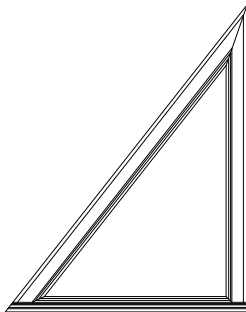

7LRAC5472

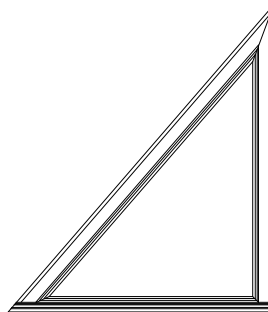

7LRAC6072

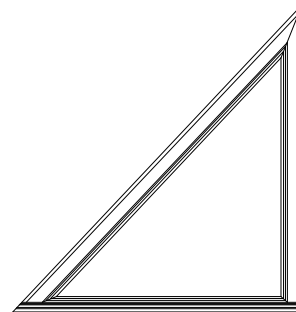

7LRAC6672

Note: Elevations shown DO NOT have exterior trim. Subtract 1/2" (12.7) from M.O. (Masonry Opening) for Unit Sizes. Masonry Openings above include Sill Nose, see Trim Options page for Sill Nose specifications. For other Trim Options refer to the Unit Sizing, Rough Opening & Masonry Openings page.

SCALE: 1/4" = 1'

LEFT TRIANGLE

UNIT SIZE
ROUGH OPENING
FRAME SIZE
DAYLIGHT OPENING

78 13/32"
72"
71 1/2"
67 7/8"

UNIT SIZE
ROUGH OPENING
FRAME SIZE
DAYLIGHT OPENING

78 13/32"
72"
71 1/2"
67 7/8"

29 3/32"
24"
23 1/2"
19 7/8"

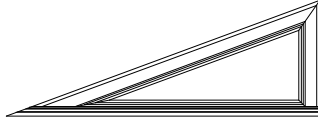

7LRAC7224

35 3/32"
30"
29 1/2"
25 7/8"

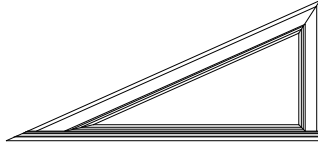

7LRAC7230

41 3/32"
36"
35 1/2"
31 7/8"

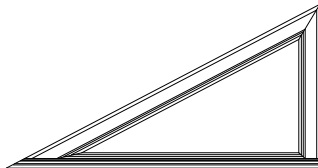

7LRAC7236

47 3/32"
42"
41 1/2"
37 7/8"

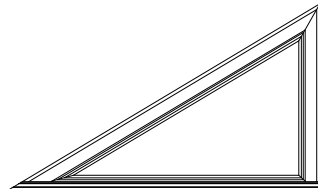

7LRAC7242

53 3/32"
48"
47 1/2"
43 7/8"

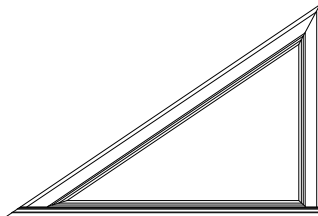

7LRAC7248

59 3/32"
54"
53 1/2"
49 7/8"

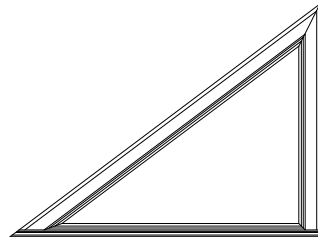

7LRAC7254

65 3/32"
60"
59 1/2"
55 7/8"

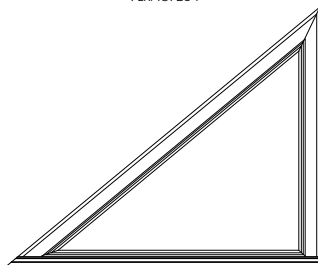

7LRAC7260

71 3/32"
66"
65 1/2"
61 7/8"

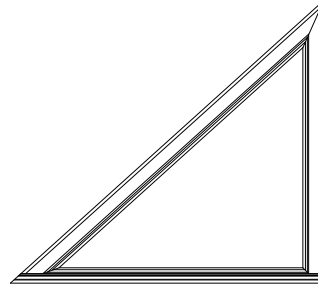

7LRAC7266

77 3/32"
72"
71 1/2"
67 7/8"

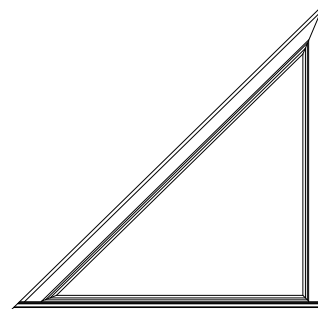



7LRAC7272

Note: Elevations shown DO NOT have exterior trim. Subtract 1/2" (12.7) from M.O. (Masonry Opening) for Unit Sizes. Masonry Openings above include Sill Nose, see Trim Options page for Sill Nose specifications. For other Trim Options refer to the Unit Sizing, Rough Opening & Masonry Openings page.

SCALE: 1/4" = 1'

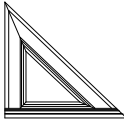
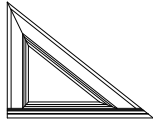
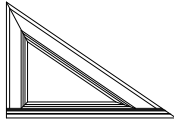
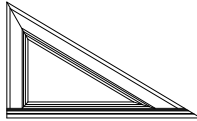
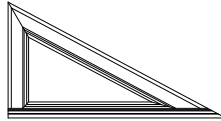
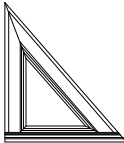
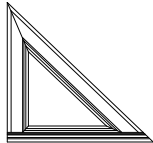
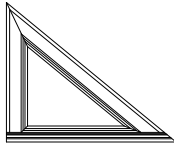
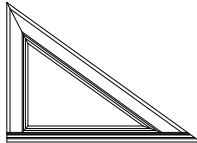
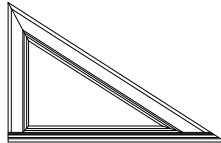
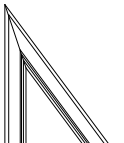
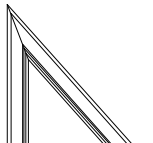
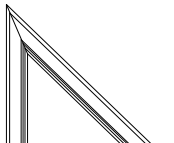
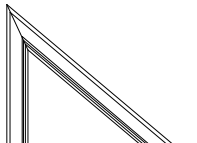
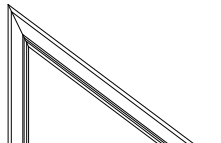
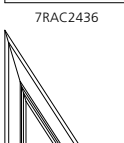
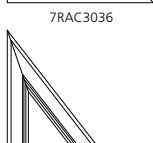
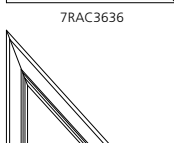
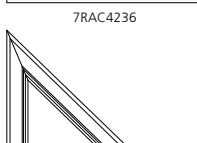
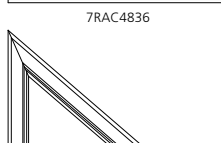
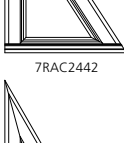
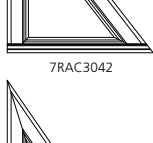
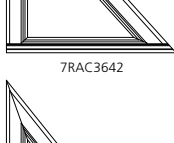
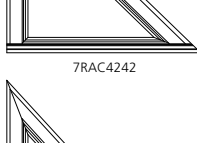
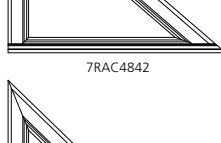
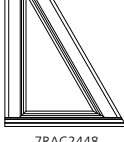
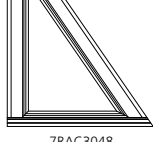
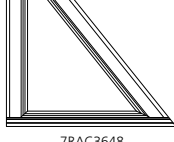
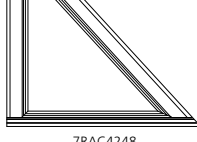
RIGHT TRIANGLE

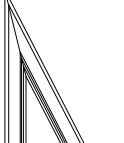
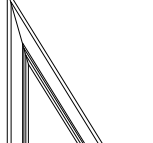
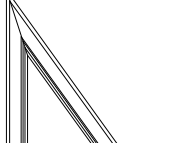
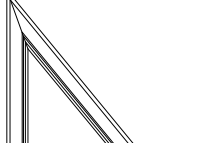
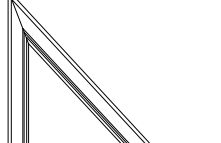
	30 13/32" 24" 23 1/2" 19 7/8"	36 13/32" 30" 29 1/2" 25 7/8"	42 13/32" 36" 35 1/2" 31 7/8"	48 13/32" 42" 41 1/2" 37 7/8"	54 13/32" 48" 47 1/2" 43 7/8"
29 3/32" 24" 23 1/2" 19 7/8"	 7RAC2424	 7RAC3024	 7RAC3624	 7RAC4224	 7RAC4824
35 3/32" 30" 29 1/2" 25 7/8"	 7RAC2430	 7RAC3030	 7RAC3630	 7RAC4230	 7RAC4830
41 3/32" 36" 35 1/2" 31 7/8"	 7RAC2436	 7RAC3036	 7RAC3636	 7RAC4236	 7RAC4836
47 3/32" 42" 41 1/2" 37 7/8"	 7RAC2442	 7RAC3042	 7RAC3642	 7RAC4242	 7RAC4842
53 3/32" 48" 47 1/2" 43 7/8"	 7RAC2448	 7RAC3048	 7RAC3648	 7RAC4248	 7RAC4848
59 3/32" 54" 53 1/2" 49 7/8"	 7RAC2454	 7RAC3054	 7RAC3654	 7RAC4254	 7RAC4854
65 3/32" 60" 59 1/2" 55 7/8"	 7RAC2460	 7RAC3060	 7RAC3660	 7RAC4260	 7RAC4860

Note: Elevations shown DO NOT have exterior trim. Subtract 1/2" (12.7) from M.O. (Masonry Opening) for Unit Sizes. Masonry Openings above include Sill Nose, see Trim Options page for Sill Nose specifications. For other Trim Options refer to the Unit Sizing, Rough Opening & Masonry Openings page.

SCALE: 1/4" = 1'

RIGHT TRIANGLE

UNIT SIZE
ROUGH OPENING
FRAME SIZE
DAYLIGHT OPENING

30 13/32"
24"
23 1/2"
19 7/8"

36 13/32"
30"
29 1/2"
25 7/8"

42 13/32"
36"
35 1/2"
31 7/8"

48 13/32"
42"
41 1/2"
37 7/8"

54 13/32"
48"
47 1/2"
43 7/8"

71 3/32"
66"
65 1/2"
61 7/8"

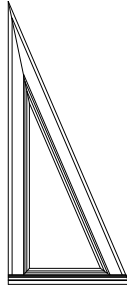

7RAC2466

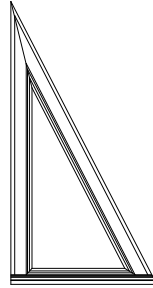

7RAC3066

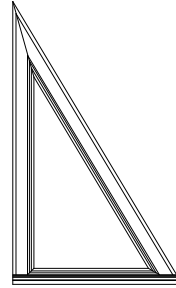

7RAC3666

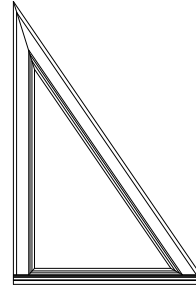

7RAC4266

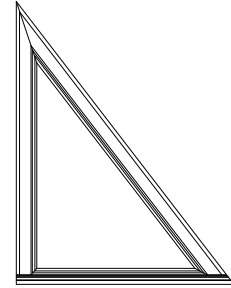

7RAC4866

77 3/32"
72"
71 1/2"
67 7/8"

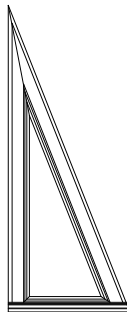

7RAC2472

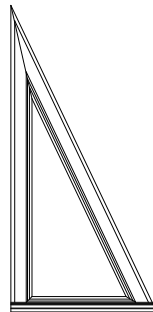

7RAC3072

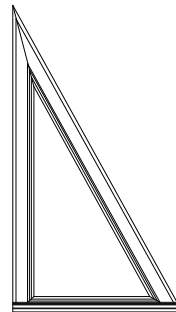

7RAC3672

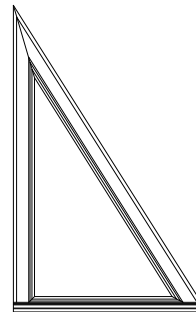

7RAC4272

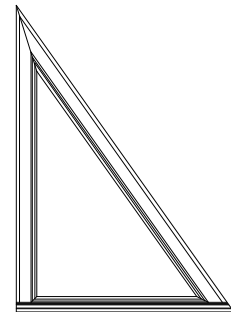

7RAC4872

Note: Elevations shown DO NOT have exterior trim. Subtract 1/2" (12.7) from M.O. (Masonry Opening) for Unit Sizes. Masonry Openings above include Sill Nose, see Trim Options page for Sill Nose specifications. For other Trim Options refer to the Unit Sizing, Rough Opening & Masonry Openings page.

SCALE: 1/4" = 1'

RIGHT TRIANGLE

UNIT SIZE
ROUGH OPENING
FRAME SIZE
DAYLIGHT OPENING

60 13/32"
54"
53 1/2"
49 7/8"

66 13/32"
60"
59 1/2"
55 7/8"

72 13/32"
66"
65 1/2"
61 7/8"

29 3/32"
24"
23 1/2"
19 7/8"

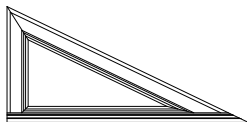

7RAC5424

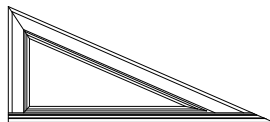

7RAC6024

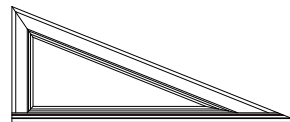

7RAC6624

35 3/32"
30"
29 1/2"
25 7/8"

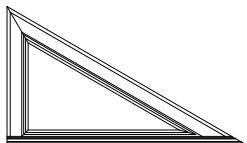

7RAC5430

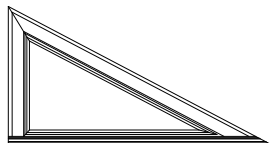

7RAC6030

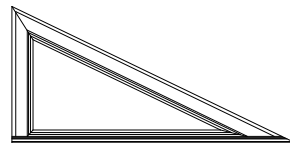

7RAC6630

41 3/32"
36"
35 1/2"
31 7/8"

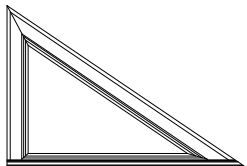

7RAC5436

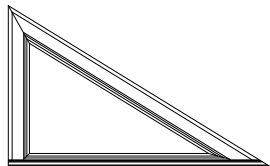

7RAC6036

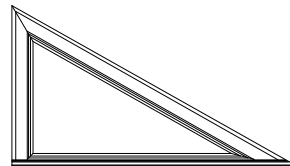

7RAC6636

47 3/32"
42"
41 1/2"
37 7/8"

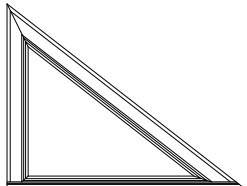

7RAC5442

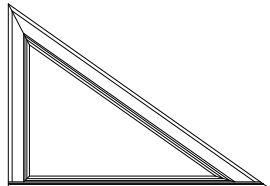

7RAC6042

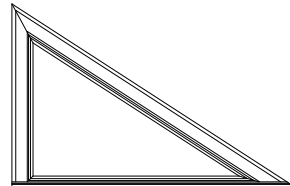

7RAC6642

53 3/32"
48"
47 1/2"
43 7/8"

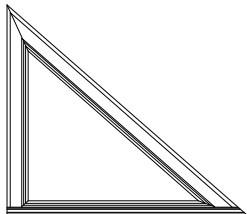

7RAC5448

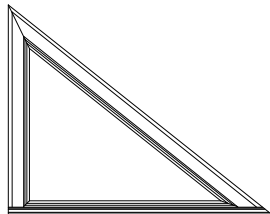

7RAC6048

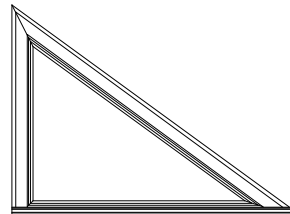

7RAC6648

59 3/32"
54"
53 1/2"
49 7/8"

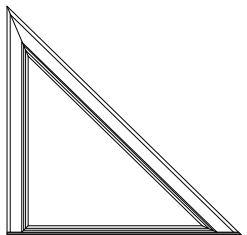

7RAC5454

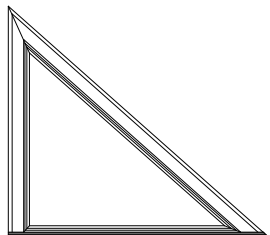

7RAC6054

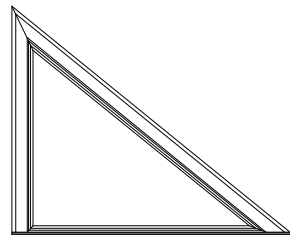

7RAC6654

65 3/32"
60"
59 1/2"
55 7/8"

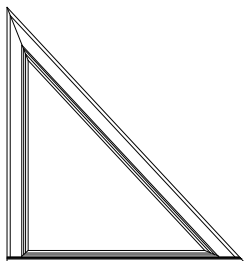

7RAC5460

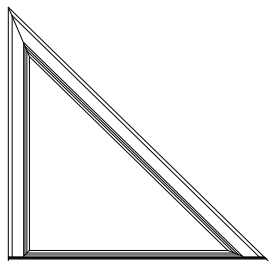

7RAC6060

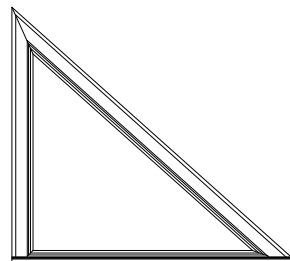

7RAC6660

Note: Elevations shown DO NOT have exterior trim. Subtract 1/2" (12.7) from M.O. (Masonry Opening) for Unit Sizes. Masonry Openings above include Sill Nose, see Trim Options page for Sill Nose specifications. For other Trim Options refer to the Unit Sizing, Rough Opening & Masonry Openings page.

SCALE: 1/4" = 1'

RIGHT TRIANGLE

UNIT SIZE
ROUGH OPENING
FRAME SIZE
DAYLIGHT OPENING

60 13/32"
54"
53 1/2"
49 7/8"

66 13/32"
60"
59 1/2"
55 7/8"

72 13/32"
66"
65 1/2"
61 7/8"

71 3/32"
66"
65 1/2"
61 7/8"

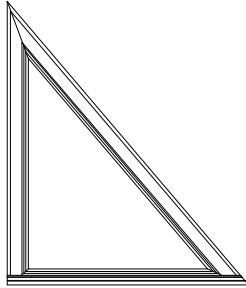

7RAC5466

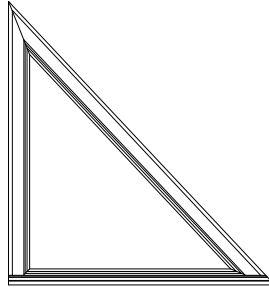

7RAC6066

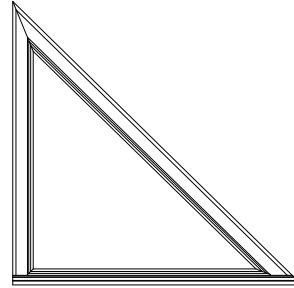

7RAC6666

77 3/32"
72"
71 1/2"
67 7/8"

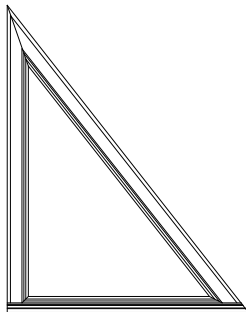

7RAC5472

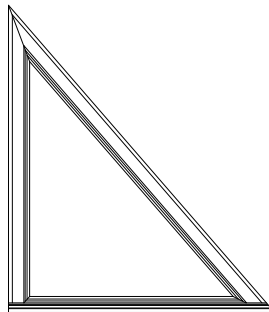

7RAC6072

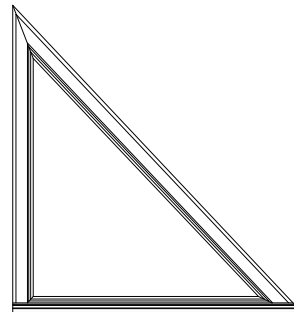

7RAC6672

Note: Elevations shown DO NOT have exterior trim. Subtract 1/2" (12.7) from M.O. (Masonry Opening) for Unit Sizes. Masonry Openings above include Sill Nose, see Trim Options page for Sill Nose specifications. For other Trim Options refer to the Unit Sizing, Rough Opening & Masonry Openings page.

SCALE: 1/4" = 1'

RIGHT TRIANGLE

UNIT SIZE
ROUGH OPENING
FRAME SIZE
DAYLIGHT OPENING

78 13/32"
72"
71 1/2"
67 7/8"

UNIT SIZE
ROUGH OPENING
FRAME SIZE
DAYLIGHT OPENING

78 13/32"
72"
71 1/2"
67 7/8"

29 3/32"
24"
23 1/2"
19 7/8"

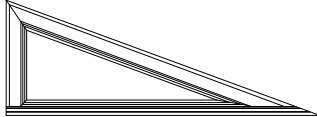

7RAC7224

35 3/32"
30"
29 1/2"
25 7/8"

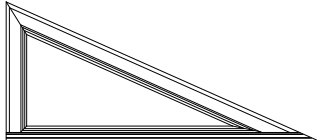

7RAC7230

41 3/32"
36"
35 1/2"
31 7/8"

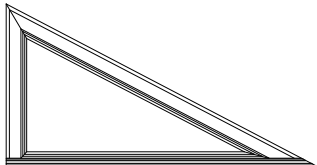

7RAC7236

47 3/32"
42"
41 1/2"
37 7/8"

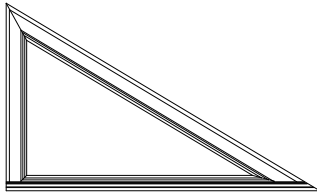

7RAC7242

53 3/32"
48"
47 1/2"
43 7/8"

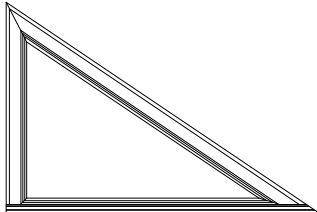

7RAC7248

59 3/32"
54"
53 1/2"
49 7/8"

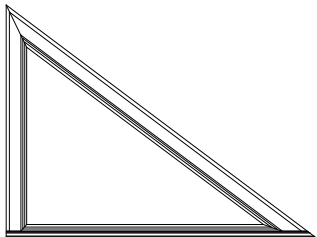

7RAC7254

65 3/32"
60"
59 1/2"
55 7/8"

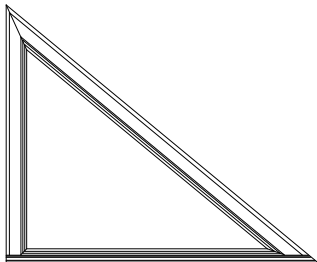

7RAC7260

71 3/32"
66"
65 1/2"
61 7/8"

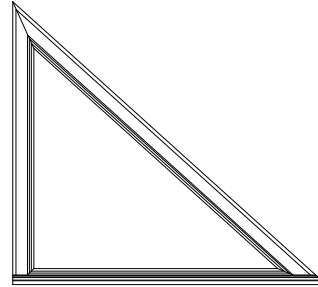

7RAC7266

77 3/32"
72"
71 1/2"
67 7/8"

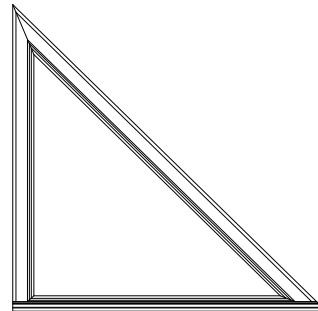

7RAC7272

Note: Elevations shown DO NOT have exterior trim. Subtract 1/2" (12.7) from M.O. (Masonry Opening) for Unit Sizes. Masonry Openings above include Sill Nose, see Trim Options page for Sill Nose specifications. For other Trim Options refer to the Unit Sizing, Rough Opening & Masonry Openings page.

SCALE: 1/4" = 1'

LEFT CLIPPED CORNER

UNIT SIZE
ROUGH OPENING
FRAME SIZE
DAYLIGHT OPENING

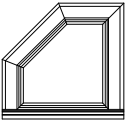
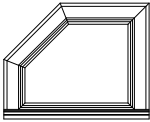
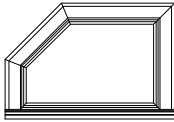
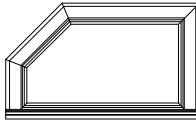
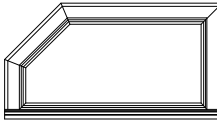
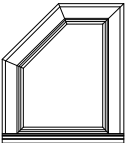
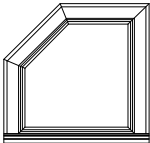
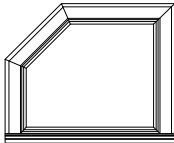
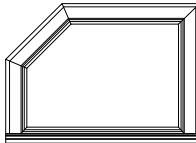
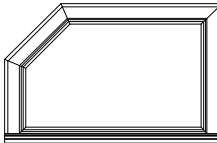
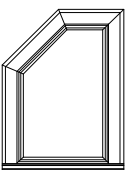
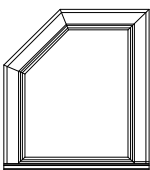
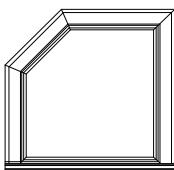
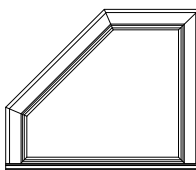
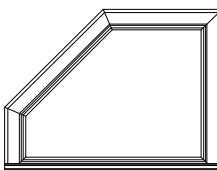
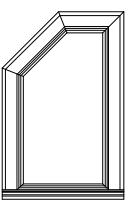
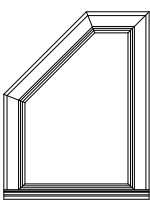
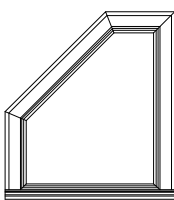
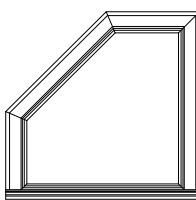
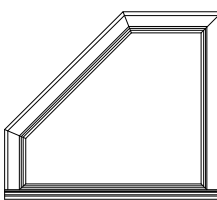
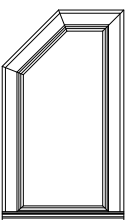
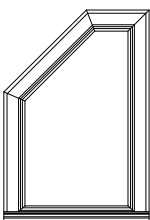
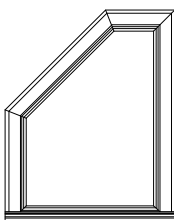
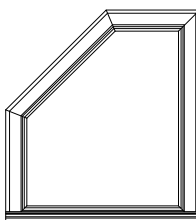
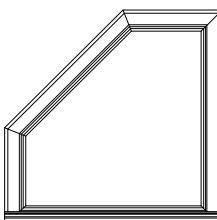
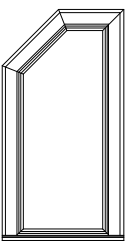
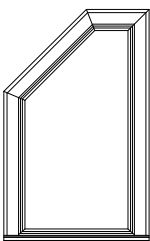
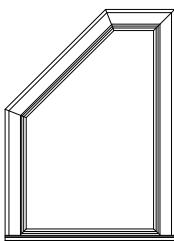
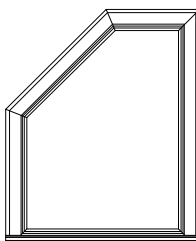
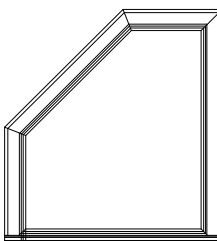
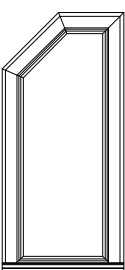
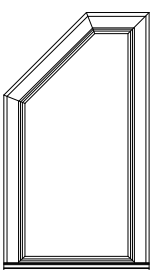
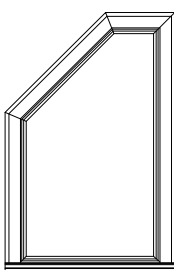
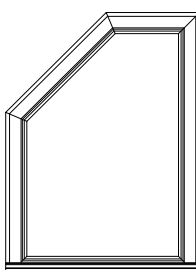
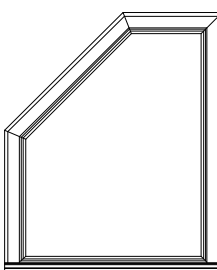
	30 13/32" 24" 23 1/2" 19 7/8"	36 13/32" 30" 29 1/2" 25 7/8"	42 13/32" 36" 35 1/2" 31 7/8"	48 13/32" 42" 41 1/2" 37 7/8"	54 13/32" 48" 47 1/2" 43 7/8"
29 3/32" 24" 23 1/2" 19 7/8"	 7LCCC2424	 7LCCC3024	 7LCCC3624	 7LCCC4224	 7LCCC4824
35 3/32" 30" 29 1/2" 25 7/8"	 7LCCC2430	 7LCCC3030	 7LCCC3630	 7LCCC4230	 7LCCC4830
41 3/32" 36" 35 1/2" 31 7/8"	 7LCCC2436	 7LCCC3036	 7LCCC3636	 7LCCC4236	 7LCCC4836
47 3/32" 42" 41 1/2" 37 7/8"	 7LCCC2442	 7LCCC3042	 7LCCC3642	 7LCCC4242	 7LCCC4842
53 3/32" 48" 47 1/2" 43 7/8"	 7LCCC2448	 7LCCC3048	 7LCCC3648	 7LCCC4248	 7LCCC4848
59 3/32" 54" 53 1/2" 49 7/8"	 7LCCC2454	 7LCCC3054	 7LCCC3654	 7LCCC4254	 7LCCC4854
65 3/32" 60" 59 1/2" 55 7/8"	 7LCCC2460	 7LCCC3060	 7LCCC3660	 7LCCC4260	 7LCCC4860

Note: Elevations shown DO NOT have exterior trim. Subtract 1/2" (12.7) from M.O. (Masonry Opening) for Unit Sizes. Masonry Openings above include Sill Nose, see Trim Options page for Sill Nose specifications. For other Trim Options refer to the Unit Sizing, Rough Opening & Masonry Openings page.

SCALE: 1/4" = 1'

LEFT CLIPPED CORNER

UNIT SIZE
ROUGH OPENING
FRAME SIZE
DAYLIGHT OPENING

30 13/32"
24"
23 1/2"
19 7/8"

36 13/32"
30"
29 1/2"
25 7/8"

42 13/32"
36"
35 1/2"
31 7/8"

48 13/32"
42"
41 1/2"
37 7/8"

54 13/32"
48"
47 1/2"
43 7/8"

71 3/8"
66"
65 1/2"
61 7/8"

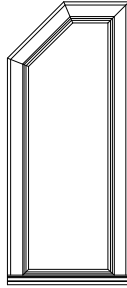

7LCCC2466

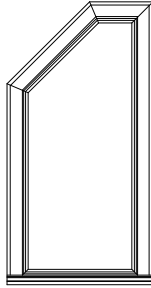

7LCCC3066

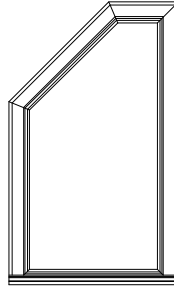

7LCCC3666

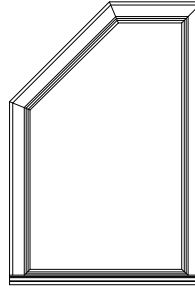

7LCCC4266

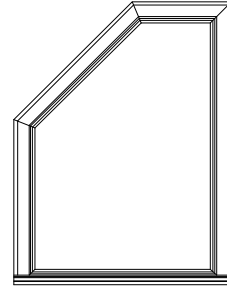

7LCCC4866

77 3/8"
72"
71 1/2"
67 7/8"

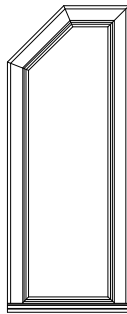

7LCCC2472

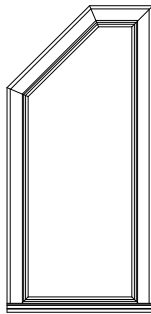

7LCCC3072

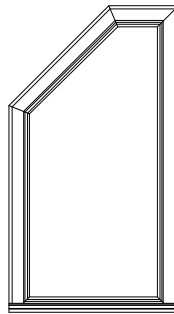

7LCCC3672

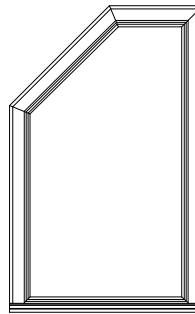

7LCCC4272

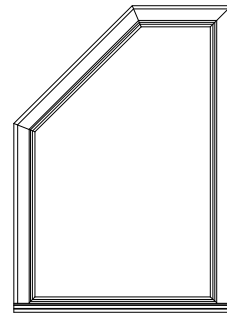



7LCCC4872

Note: Elevations shown DO NOT have exterior trim. Subtract 1/2" (12.7) from M.O. (Masonry Opening) for Unit Sizes. Masonry Openings above include Sill Nose, see Trim Options page for Sill Nose specifications. For other Trim Options refer to the Unit Sizing, Rough Opening & Masonry Openings page.

SCALE: 1/4" = 1'

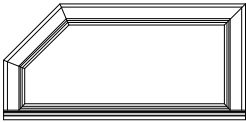
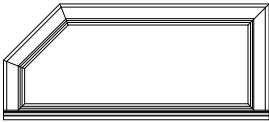
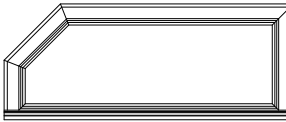
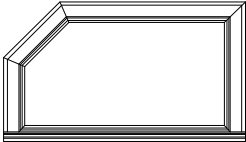
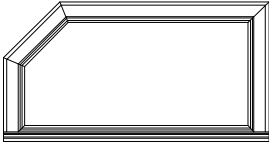
LEFT CLIPPED CORNER

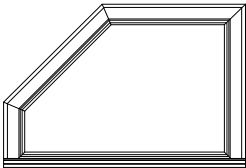
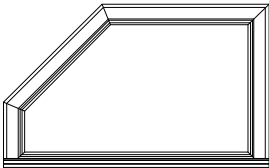
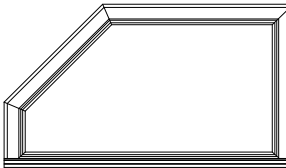
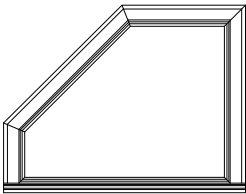
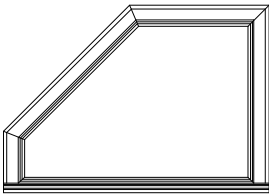
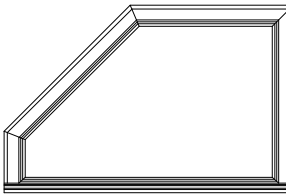
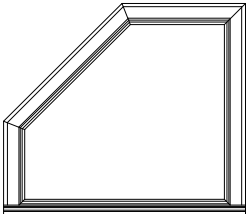
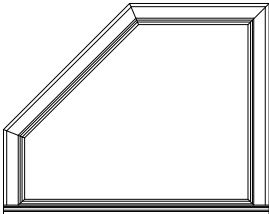
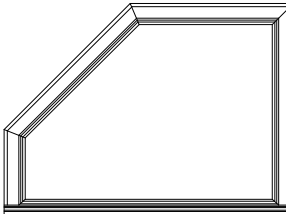
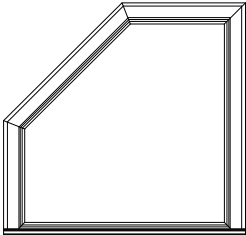
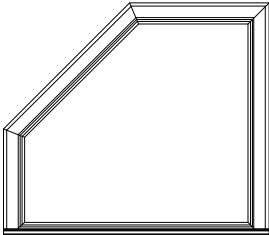
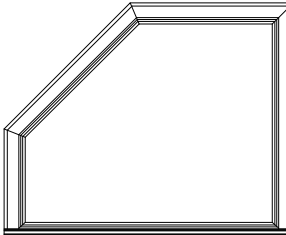
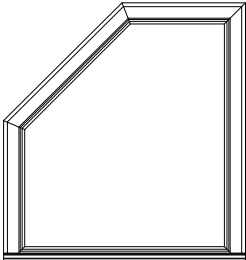
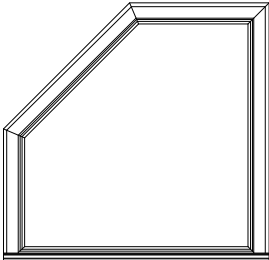
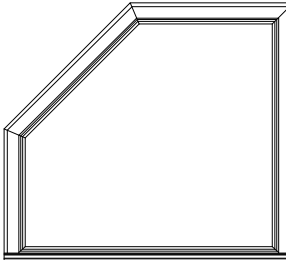
UNIT SIZE ROUGH OPENING FRAME SIZE DAYLIGHT OPENING	60 13/32" 54" 53 1/2" 49 7/8"	66 13/32" 60" 59 1/2" 55 7/8"	72 13/32" 66" 65 1/2" 61 7/8"
29 3/32" 24" 23 1/2" 19 7/8"	 7LCCC5424	 7LCCC6024	 7LCCC6624
35 3/32" 30" 29 1/2" 25 7/8"	 7LCCC5430	 7LCCC6030	 7LCCC6630
41 3/32" 36" 35 1/2" 31 7/8"	 7LCCC5436	 7LCCC6036	 7LCCC6636
47 3/32" 42" 41 1/2" 37 7/8"	 7LCCC5442	 7LCCC6042	 7LCCC6642
53 3/32" 48" 47 1/2" 43 7/8"	 7LCCC5448	 7LCCC6048	 7LCCC6648
59 3/32" 54" 53 1/2" 49 7/8"	 7LCCC5454	 7LCCC6054	 7LCCC6654
65 3/32" 60" 59 1/2" 55 7/8"	 7LCCC5460	 7LCCC6060	 7LCCC6660

Note: Elevations shown DO NOT have exterior trim. Subtract 1/2" (12.7) from M.O. (Masonry Opening) for Unit Sizes. Masonry Openings above include Sill Nose, see Trim Options page for Sill Nose specifications. For other Trim Options refer to the Unit Sizing, Rough Opening & Masonry Openings page.

SCALE: 1/4" = 1'

LEFT CLIPPED CORNER

UNIT SIZE
ROUGH OPENING
FRAME SIZE
DAYLIGHT OPENING

60 13/32"
54"
53 1/2"
49 7/8"

66 13/32"
60"
59 1/2"
55 7/8"

72 13/32"
66"
65 1/2"
61 7/8"

71 3/32"
66"
65 1/2"
61 7/8"

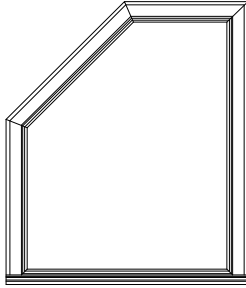

7LCCC5466

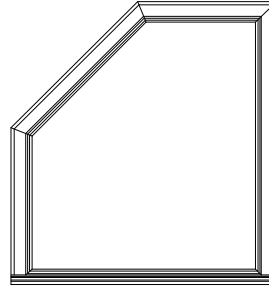

7LCCC6066

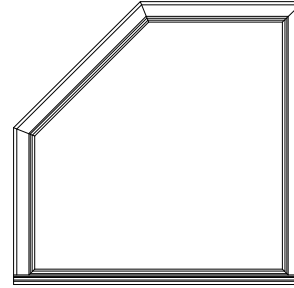

7LCCC6666

77 3/32"
72"
71 1/2"
67 7/8"

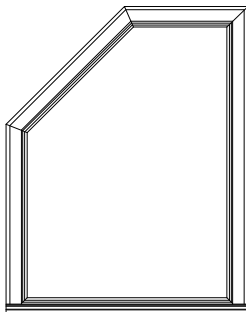

7LCCC5472

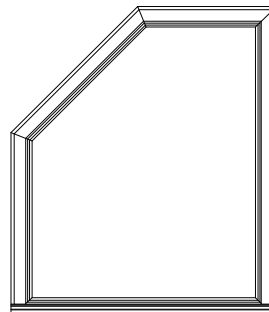

7LCCC6072

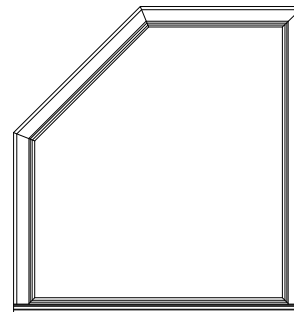

7LCCC6672

Note: Elevations shown DO NOT have exterior trim. Subtract 1/2" (12.7) from M.O. (Masonry Opening) for Unit Sizes. Masonry Openings above include Sill Nose, see Trim Options page for Sill Nose specifications. For other Trim Options refer to the Unit Sizing, Rough Opening & Masonry Openings page.

SCALE: 1/4" = 1'

LEFT CLIPPED CORNER

UNIT SIZE
ROUGH OPENING
FRAME SIZE
DAYLIGHT OPENING

78 13/32"
72"
71 1/2"
67 7/8"

29 3/32"
24"
23 1/2"
19 7/8"



7LCCC7224

35 3/32"
30"
29 1/2"
25 7/8"



7LCCC7230

41 3/32"
36"
35 1/2"
31 7/8"

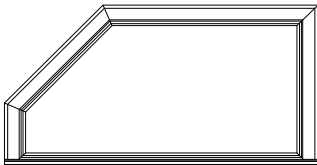

7LCCC7236

47 3/32"
42"
41 1/2"
37 7/8"

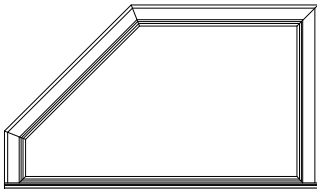

7LCCC7242

53 3/32"
48"
47 1/2"
43 7/8"

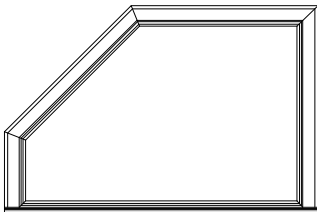

7LCCC7248

59 3/32"
54"
53 1/2"
49 7/8"

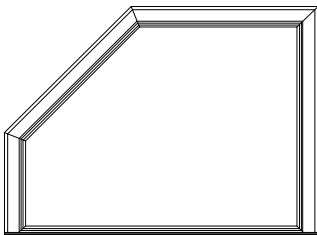

7LCCC7254

65 3/32"
60"
59 1/2"
55 7/8"

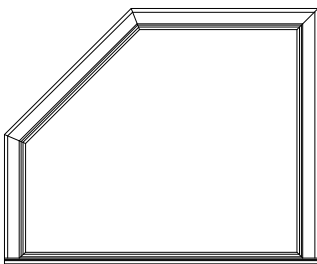

7LCCC7260

UNIT SIZE
ROUGH OPENING
FRAME SIZE
DAYLIGHT OPENING

78 13/32"
72"
71 1/2"
67 7/8"

71 3/32"
66"
65 1/2"
61 7/8"

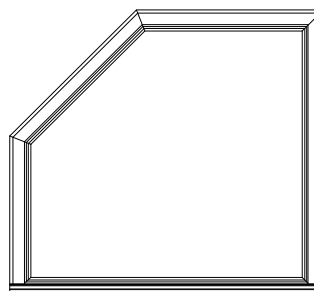

7LCCC7266

77 3/32"
72"
71 1/2"
67 7/8"

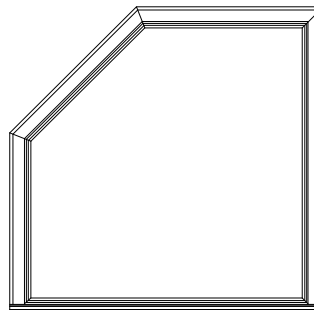

7LCCC7272

Note: Elevations shown DO NOT have exterior trim. Subtract 1/2" (12.7) from M.O. (Masonry Opening) for Unit Sizes. Masonry Openings above include Sill Nose, see Trim Options page for Sill Nose specifications. For other Trim Options refer to the Unit Sizing, Rough Opening & Masonry Openings page.

SCALE: 1/4" = 1'

RIGHT CLIPPED CORNER

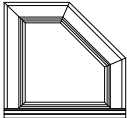
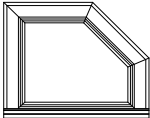
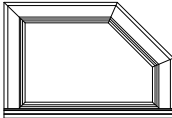
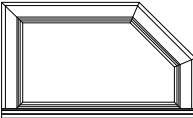
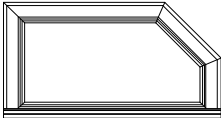
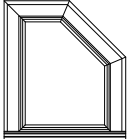
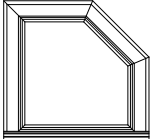
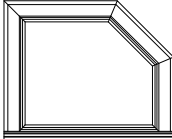
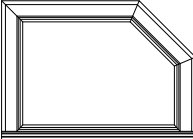
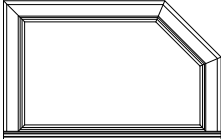
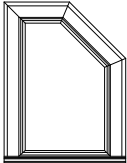
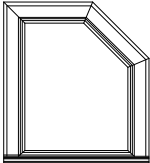
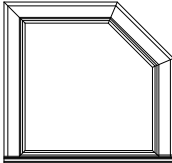
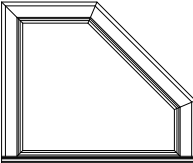
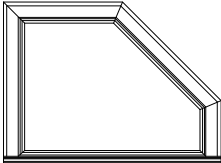
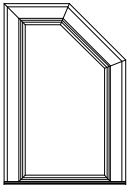
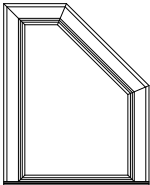
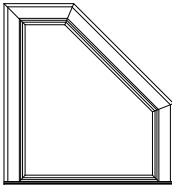
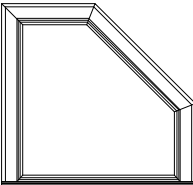
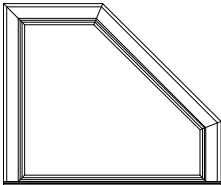
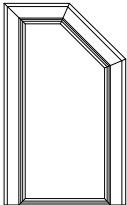
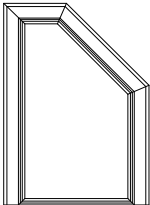
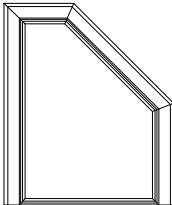
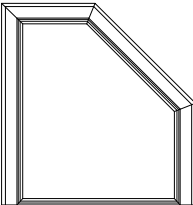
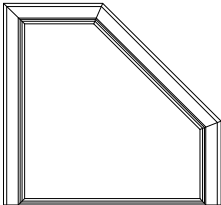
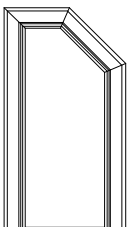
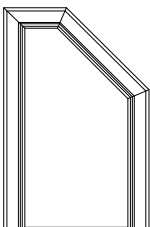
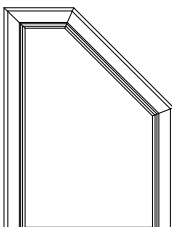
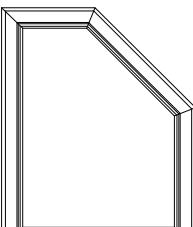
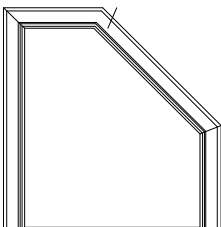
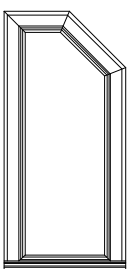
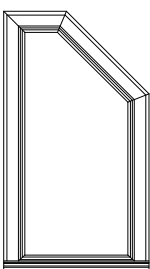
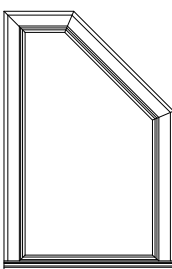
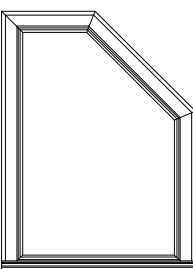
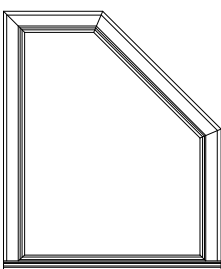
UNIT SIZE ROUGH OPENING FRAME SIZE DAYLIGHT OPENING	30 13/32" 24" 23 1/2" 19 7/8"	36 13/32" 30" 29 1/2" 25 7/8"	42 13/32" 36" 35 1/2" 31 7/8"	48 13/32" 42" 41 1/2" 37 7/8"	54 13/32" 48" 47 1/2" 43 7/8"
29 3/32" 24" 23 1/2" 19 7/8"	 7RCCC2424	 7RCCC3024	 7RCCC3624	 7RCCC4224	 7RCCC4824
35 3/32" 30" 29 1/2" 25 7/8"	 7RCCC2430	 7RCCC3030	 7RCCC3630	 7RCCC4230	 7RCCC4830
41 3/32" 36" 35 1/2" 31 7/8"	 7RCCC2436	 7RCCC3036	 7RCCC3636	 7RCCC4236	 7RCCC4836
47 3/32" 42" 41 1/2" 37 7/8"	 7RCCC2442	 7RCCC3042	 7RCCC3642	 7RCCC4242	 7RCCC4842
53 3/32" 48" 47 1/2" 43 7/8"	 7RCCC2448	 7RCCC3048	 7RCCC3648	 7RCCC4248	 7RCCC4848
59 3/32" 54" 53 1/2" 49 7/8"	 7RCCC2454	 7RCCC3054	 7RCCC3654	 7RCCC4254	 7RCCC4854
65 3/32" 60" 59 1/2" 55 7/8"	 7RCCC2460	 7RCCC3060	 7RCCC3660	 7RCCC4260	 7RCCC4860

Note: Elevations shown DO NOT have exterior trim. Subtract 1/2" (12.7) from M.O. (Masonry Opening) for Unit Sizes. Masonry Openings above include Sill Nose, see Trim Options page for Sill Nose specifications. For other Trim Options refer to the Unit Sizing, Rough Opening & Masonry Openings page.

SCALE: 1/4" = 1'

RIGHT CLIPPED CORNER

UNIT SIZE
ROUGH OPENING
FRAME SIZE
DAYLIGHT OPENING

30 13/32"
24"
23 1/2"
19 7/8"

36 13/32"
30"
29 1/2"
25 7/8"

42 13/32"
36"
35 1/2"
31 7/8"

48 13/32"
42"
41 1/2"
37 7/8"

54 13/32"
48"
47 1/2"
43 7/8"

71 3/32"
66"
65 1/2"
61 7/8"

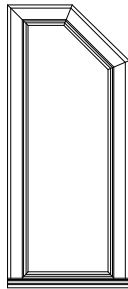

7RCCC2466

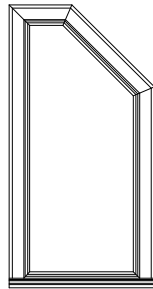

7RCCC3066

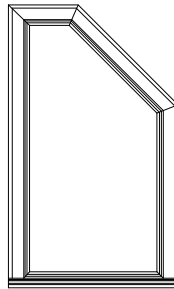

7RCCC3666

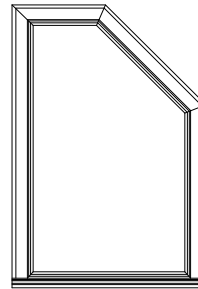

7RCCC4266

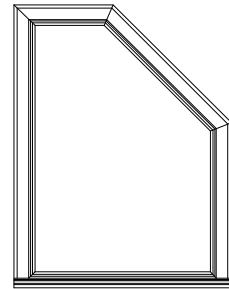

7RCCC4866

77 3/32"
72"
71 1/2"
67 7/8"

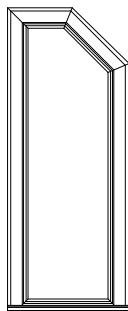

7RCCC2472

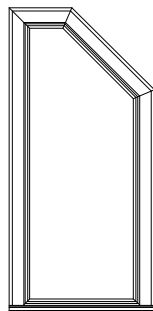

7RCCC3072

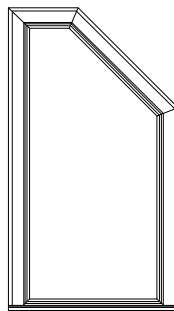

7RCCC3672

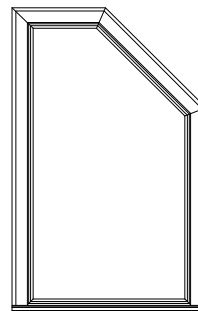

7RCCC4272

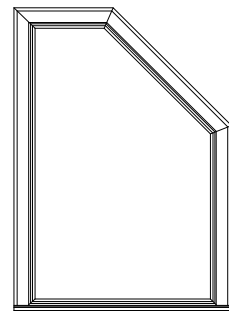

7RCCC4872

Note: Elevations shown DO NOT have exterior trim. Subtract 1/2" (12.7) from M.O. (Masonry Opening) for Unit Sizes. Masonry Openings above include Sill Nose, see Trim Options page for Sill Nose specifications. For other Trim Options refer to the Unit Sizing, Rough Opening & Masonry Openings page.

SCALE: 1/4" = 1'

RIGHT CLIPPED CORNER

UNIT SIZE
ROUGH OPENING
FRAME SIZE
DAYLIGHT OPENING

60 13/32"
54"
53 1/2"
49 7/8"

66 13/32"
60"
59 1/2"
55 7/8"

72 13/32"
66"
65 1/2"
61 7/8"

29 3/32"
24"
23 1/2"
19 7/8"

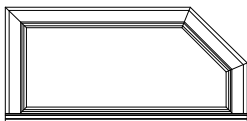

7RCCC5424

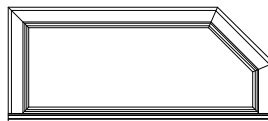

7RCCC6024

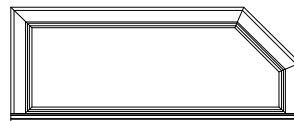

7RCCC6624

35 3/32"
30"
29 1/2"
25 7/8"

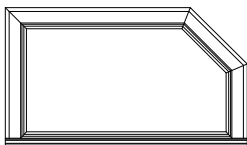

7RCCC5430



7RCCC6030



7RCCC6630

41 3/32"
36"
35 1/2"
31 7/8"

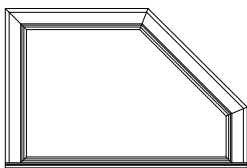

7RCCC5436

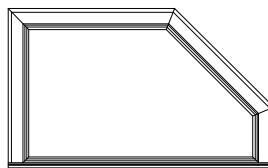

7RCCC6036

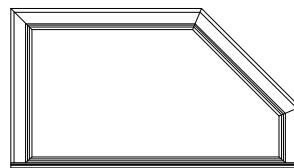

7RCCC6636

47 3/32"
42"
41 1/2"
37 7/8"

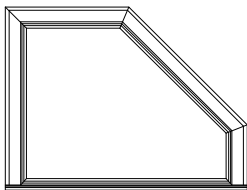

7RCCC5442

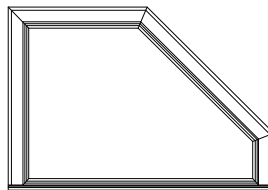

7RCCC6042

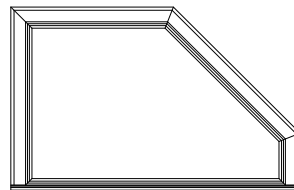

7RCCC6642

53 3/32"
48"
47 1/2"
43 7/8"

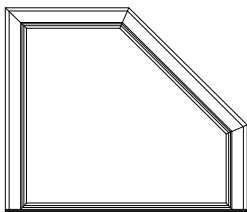

7RCCC5448

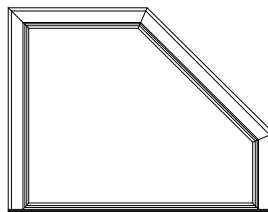

7RCCC6048

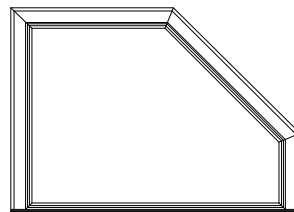

7RCCC6648

59 3/32"
54"
53 1/2"
49 7/8"

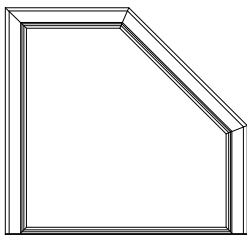

7RCCC5454

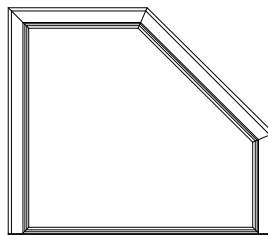

7RCCC6054

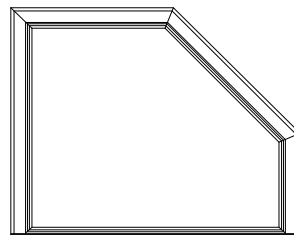

7RCCC6654

65 3/32"
60"
59 1/2"
55 7/8"

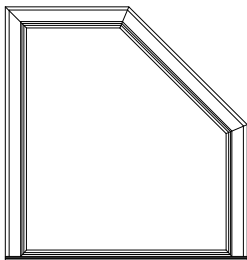

7RCCC5460

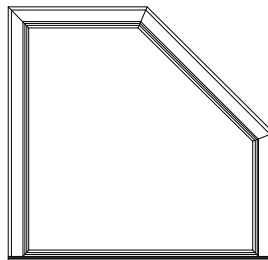

7RCCC6060

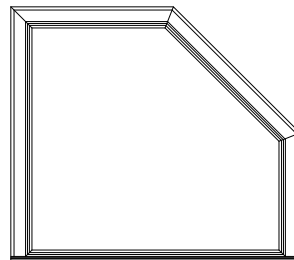

7RCCC6660

Note: Elevations shown DO NOT have exterior trim. Subtract 1/2" (12.7) from M.O. (Masonry Opening) for Unit Sizes. Masonry Openings above include Sill Nose, see Trim Options page for Sill Nose specifications. For other Trim Options refer to the Unit Sizing, Rough Opening & Masonry Openings page.

SCALE: 1/4" = 1'

RIGHT CLIPPED CORNER

UNIT SIZE
ROUGH OPENING
FRAME SIZE
DAYLIGHT OPENING

60 13/32"
54"
53 1/2"
49 7/8"

66 13/32"
60"
59 1/2"
55 7/8"

72 13/32"
66"
65 1/2"
61 7/8"

71 3/32"
66"
65 1/2"
61 7/8"

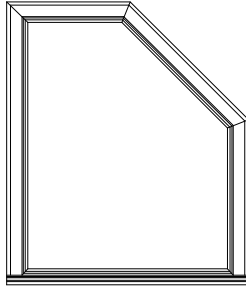

7RCCC5466

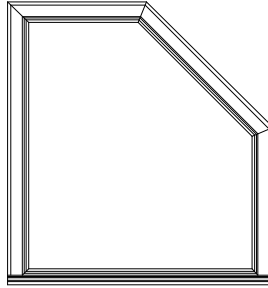

7RCCC6066

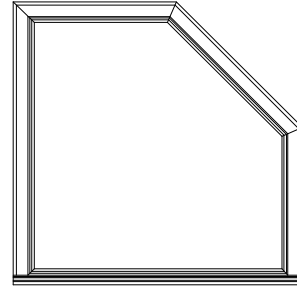

7RCCC6666

77 3/32"
72"
71 1/2"
67 7/8"

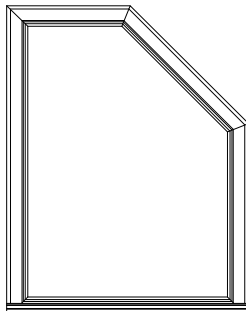

7RCCC5472

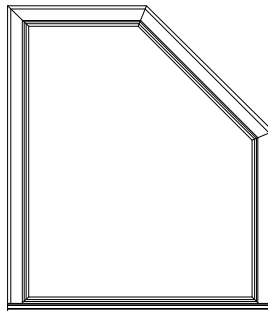

7RCCC6072

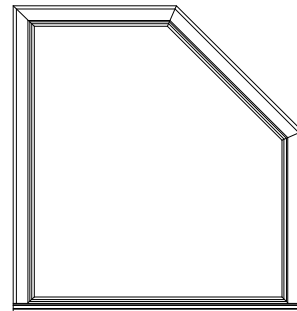

7RCCC6672

Note: Elevations shown DO NOT have exterior trim. Subtract 1/2" (12.7) from M.O. (Masonry Opening) for Unit Sizes. Masonry Openings above include Sill Nose, see Trim Options page for Sill Nose specifications. For other Trim Options refer to the Unit Sizing, Rough Opening & Masonry Openings page.

SCALE: 1/4" = 1'

RIGHT CLIPPED CORNER

UNIT SIZE
ROUGH OPENING
FRAME SIZE
DAYLIGHT OPENING

78 13/32"
72"
71 1/2"
67 7/8"

29 3/32"
24"
23 1/8"
19 7/16"



7RCCC7224

35 3/32"
30"
29 1/2"
25 7/16"

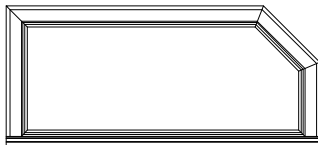

7RCCC7230

41 3/32"
36"
35 1/2"
31 7/16"

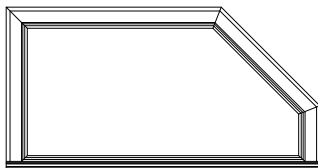

7RCCC7236

47 3/32"
42"
41 1/2"
37 7/16"

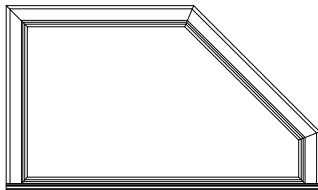

7RCCC7242

53 3/32"
48"
47 1/2"
43 7/16"

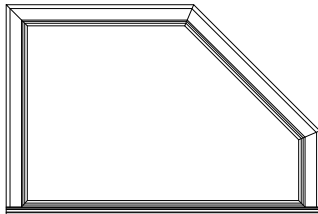

7RCCC7248

59 3/32"
54"
53 1/2"
49 7/16"

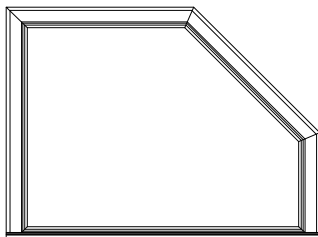

7RCCC7254

65 3/32"
60"
59 1/2"
55 7/16"

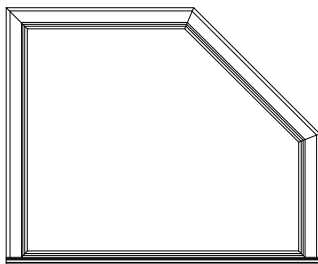

7RCCC7260

UNIT SIZE
ROUGH OPENING
FRAME SIZE
DAYLIGHT OPENING

78 13/32"
72"
71 1/2"
67 7/8"

71 3/32"
66"
65 1/2"
61 7/8"

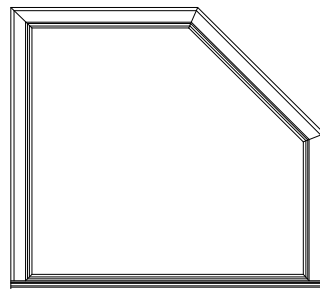

7RCCC7266

77 3/32"
72"
71 1/2"
67 7/8"

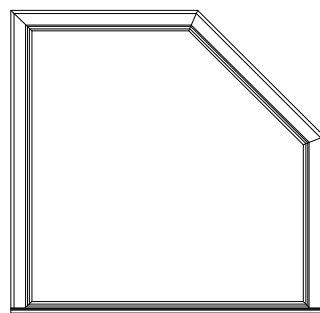

7RCCC7272

Note: Elevations shown DO NOT have exterior trim. Subtract 1/2" (12.7) from M.O. (Masonry Opening) for Unit Sizes. Masonry Openings above include Sill Nose, see Trim Options page for Sill Nose specifications. For other Trim Options refer to the Unit Sizing, Rough Opening & Masonry Openings page.

SCALE: 1/4" = 1'

PENTAGON

UNIT SIZE
ROUGH OPENING
FRAME SIZE
DAYLIGHT OPENING

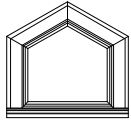
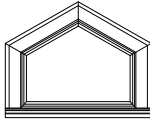
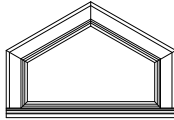
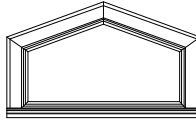
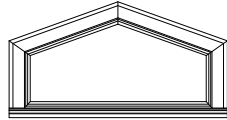
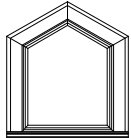
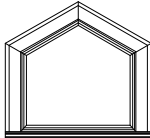
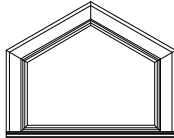
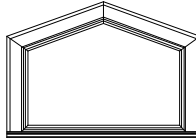
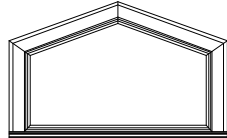
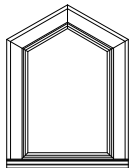
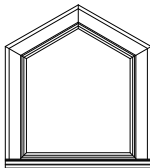
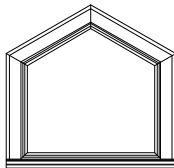
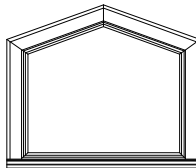
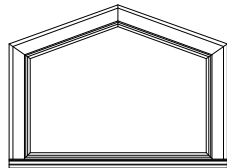
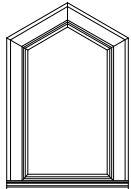
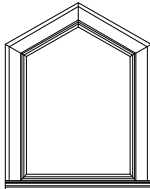
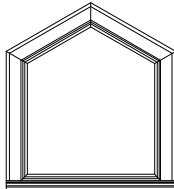
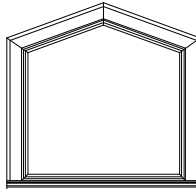
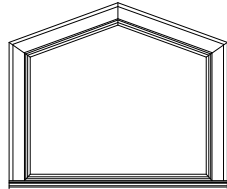
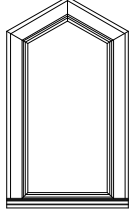
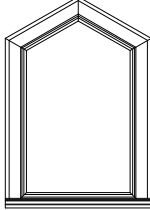
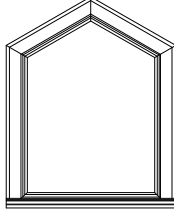
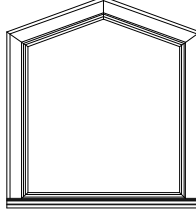
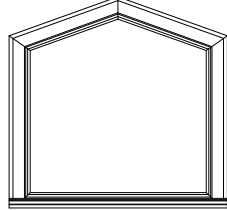
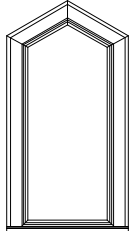
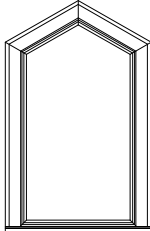
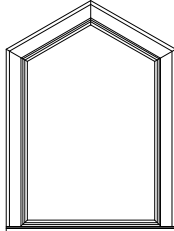
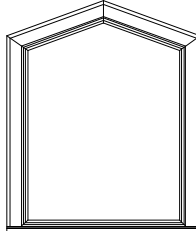
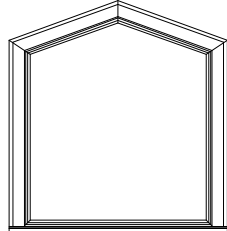
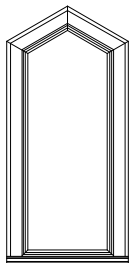
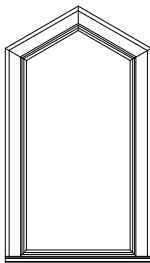
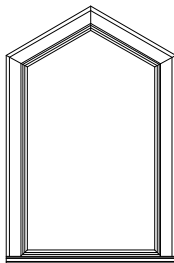
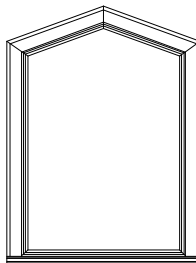
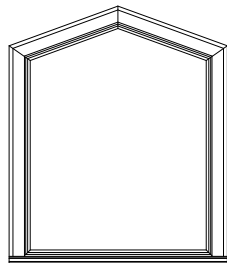
	30 13/32" 24" 23 1/2" 19 7/8"	36 13/32" 30" 29 1/2" 25 7/8"	42 13/32" 36" 35 1/2" 31 7/8"	48 13/32" 42" 41 1/2" 37 7/8"	54 13/32" 48" 47 1/2" 43 7/8"
29 3/32" 24" 23 1/2" 19 7/8"	 7GTC2424	 7GTC3024	 7GTC3624	 7GTC4224	 7GTC4824
35 3/32" 30" 29 1/2" 25 7/8"	 7GTC2430	 7GTC3030	 7GTC3630	 7GTC4230	 7GTC4830
41 3/32" 36" 35 1/2" 31 7/8"	 7GTC2436	 7GTC3036	 7GTC3636	 7GTC4236	 7GTC4836
47 3/32" 42" 41 1/2" 37 7/8"	 7GTC2442	 7GTC3042	 7GTC3642	 7GTC4242	 7GTC4842
53 3/32" 48" 47 1/2" 43 7/8"	 7GTC2448	 7GTC3048	 7GTC3648	 7GTC4248	 7GTC4848
59 3/32" 54" 53 1/2" 49 7/8"	 7GTC2454	 7GTC3054	 7GTC3654	 7GTC4254	 7GTC4854
65 3/32" 60" 59 1/2" 55 7/8"	 7GTC2460	 7GTC3060	 7GTC3660	 7GTC4260	 7GTC4860

Note: Elevations shown DO NOT have exterior trim. Subtract 1/2" (12.7) from M.O. (Masonry Opening) for Unit Sizes. Masonry Openings above include Sill Nose, see Trim Options page for Sill Nose specifications. For other Trim Options refer to the Unit Sizing, Rough Opening & Masonry Openings page.

SCALE: 1/4" = 1'

PENTAGON

UNIT SIZE
ROUGH OPENING
FRAME SIZE
DAYLIGHT OPENING

30 13/32"
24"
23 1/2"
19 7/8"

36 13/32"
30"
29 1/2"
25 7/8"

42 13/32"
36"
35 1/2"
31 7/8"

48 13/32"
42"
41 1/2"
37 7/8"

54 13/32"
48"
47 1/2"
43 7/8"

71 3/32"
66"
65 1/2"
61 7/8"

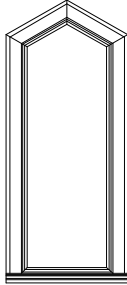

7GTC2466

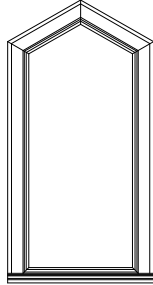

7GTC3066

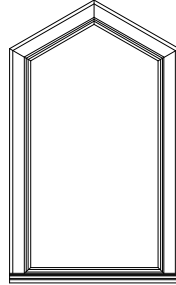

7GTC3666

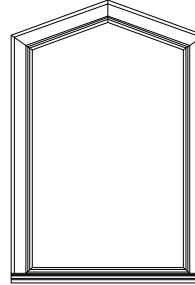

7GTC4266

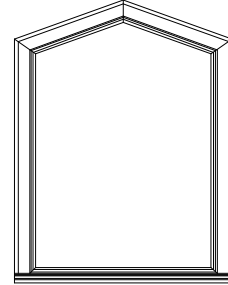

7GTC4866

77 3/32"
72"
71 1/2"
67 7/8"

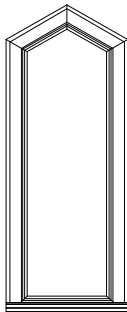

7GTC2472

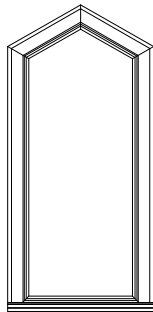

7GTC3072

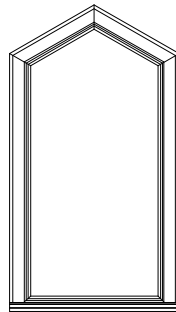

7GTC3672

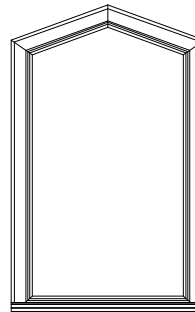

7GTC4272

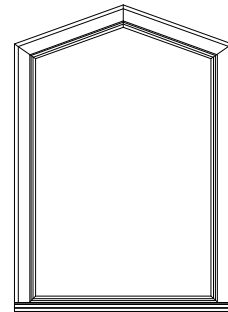

7GTC4872

Note: Elevations shown DO NOT have exterior trim. Subtract 1/2" (12.7) from M.O. (Masonry Opening) for Unit Sizes. Masonry Openings above include Sill Nose, see Trim Options page for Sill Nose specifications. For other Trim Options refer to the Unit Sizing, Rough Opening & Masonry Openings page.

SCALE: 1/4" = 1'

PENTAGON

UNIT SIZE
ROUGH OPENING
FRAME SIZE
DAYLIGHT OPENING

60 13/32"
54"
53 1/2"
49 7/8"

66 13/32"
60"
59 1/2"
55 7/8"

72 13/32"
66"
65 1/2"
61 7/8"

29 3/32"
24"
23 1/2"
19 7/8"

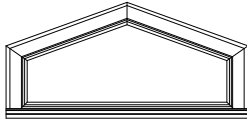

7GTC5424

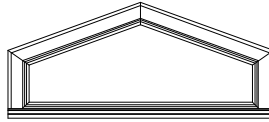

7GTC6024

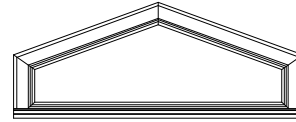

7GTC6624

35 3/32"
30"
29 1/2"
25 7/8"

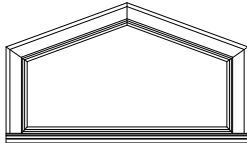

7GTC5430

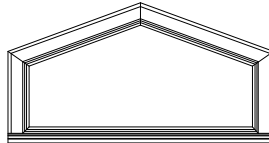

7GTC6030

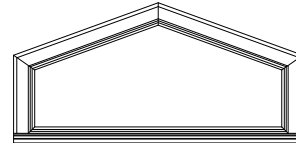

7GTC6630

41 3/32"
36"
35 1/2"
31 7/8"

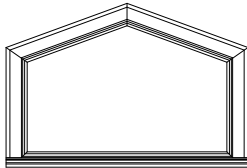

7GTC5436

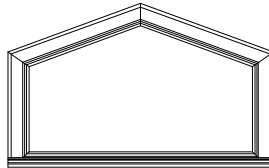

7GTC6036

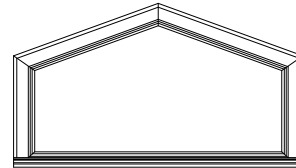

7GTC6636

47 3/32"
42"
41 1/2"
37 7/8"

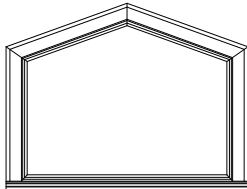

7GTC5442

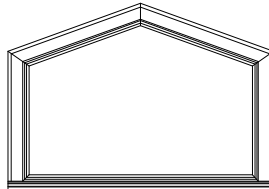

7GTC6042

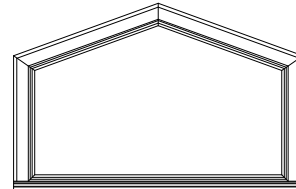

7GTC6642

53 3/32"
48"
47 1/2"
43 7/8"

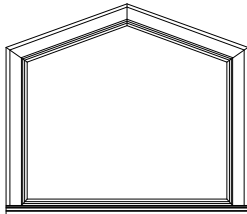

7GTC5448

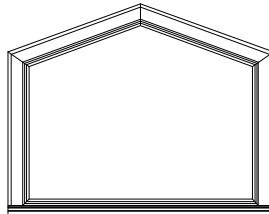

7GTC6048

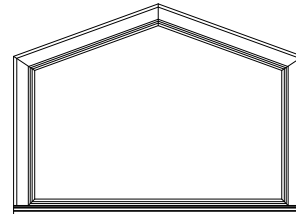

7GTC6648

59 3/32"
54"
53 1/2"
49 7/8"

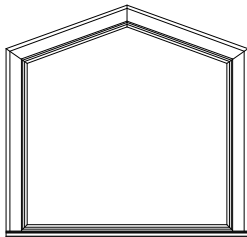

7GTC5454

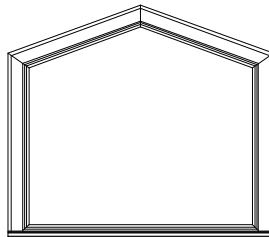

7GTC6054

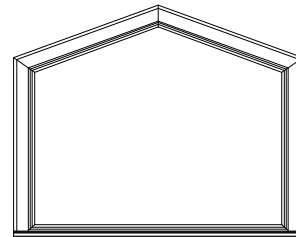

7GTC6654

65 3/32"
60"
59 1/2"
55 7/8"

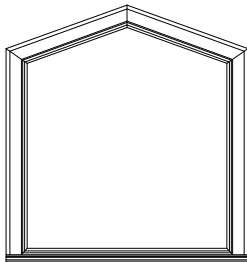

7GTC5460

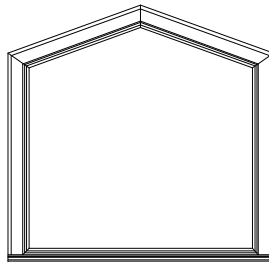

7GTC6060

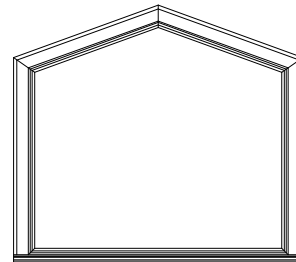

7GTC6660

Note: Elevations shown DO NOT have exterior trim. Subtract 1/2" (12.7) from M.O. (Masonry Opening) for Unit Sizes. Masonry Openings above include Sill Nose, see Trim Options page for Sill Nose specifications. For other Trim Options refer to the Unit Sizing, Rough Opening & Masonry Openings page.

SCALE: 1/4" = 1'

PENTAGON

UNIT SIZE
ROUGH OPENING
FRAME SIZE
DAYLIGHT OPENING

60 13/32"
54"
53 1/2"
49 7/8"

66 13/32"
60"
59 1/2"
55 7/8"

72 13/32"
66"
65 1/2"
61 7/8"

71 3/32"
66"
65 1/2"
61 7/8"

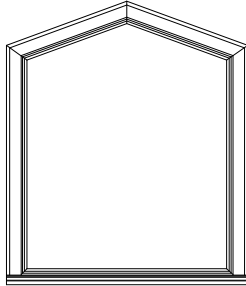

7GTC5466

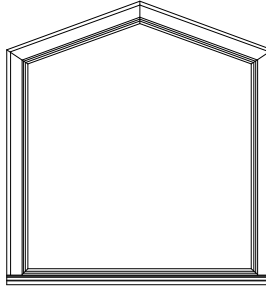

7GTC6066

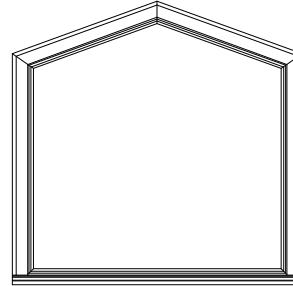

7GTC6666

77 3/32"
71"
71 1/2"
67 7/8"

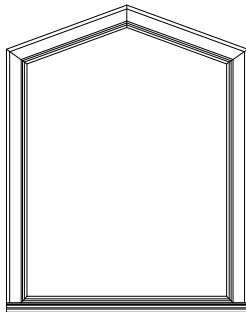

7GTC5472

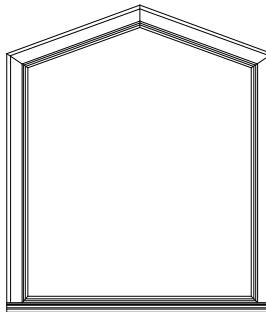

7GTC6072

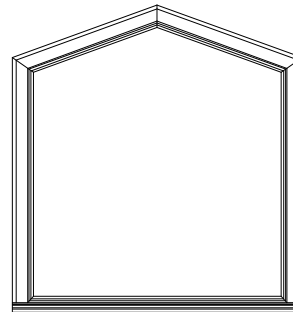

7GTC6672

Note: Elevations shown DO NOT have exterior trim. Subtract 1/2" (12.7) from M.O. (Masonry Opening) for Unit Sizes. Masonry Openings above include Sill Nose, see Trim Options page for Sill Nose specifications. For other Trim Options refer to the Unit Sizing, Rough Opening & Masonry Openings page.

SCALE: 1/4" = 1'

PENTAGON

UNIT SIZE
ROUGH OPENING
FRAME SIZE
DAYLIGHT OPENING

78 13/32"
72"
71 1/2"
67 7/8"

29 3/32"
24"
23 1/2"
19 7/8"

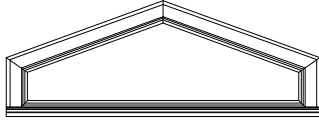

7GTC7224

35 3/32"
30"
29 1/2"
25 7/8"

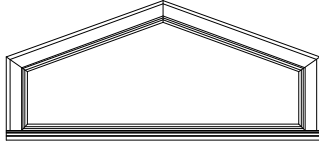

7GTC7230

41 3/32"
36"
35 1/2"
31 7/8"

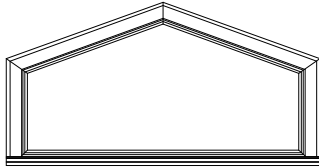

7GTC7236

47 3/32"
42"
41 1/2"
37 7/8"

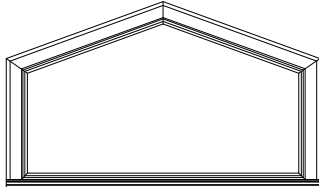

7GTC7242

53 3/32"
48"
47 1/2"
43 7/8"

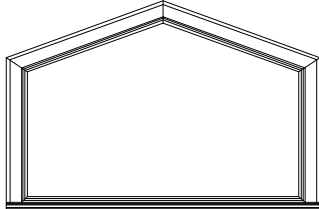

7GTC7248

59 3/32"
54"
53 1/2"
49 7/8"

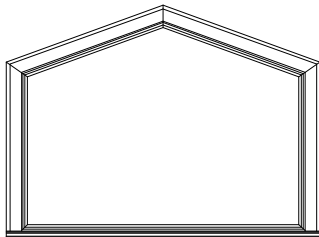

7GTC7254

65 3/32"
60"
59 1/2"
55 7/8"

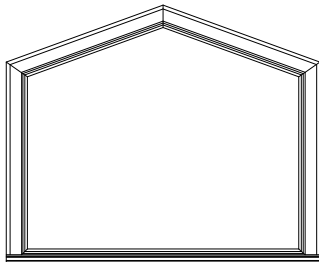

7GTC7260

UNIT SIZE
ROUGH OPENING
FRAME SIZE
DAYLIGHT OPENING

78 13/32"
72"
71 1/2"
67 7/8"

71 3/32"
66"
65 1/2"
61 7/8"

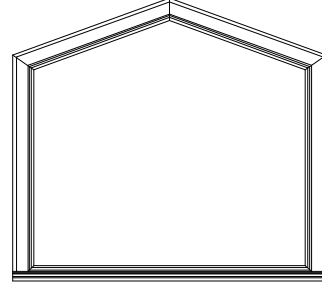

7GTC7266

77 3/32"
72"
71 1/2"
67 7/8"

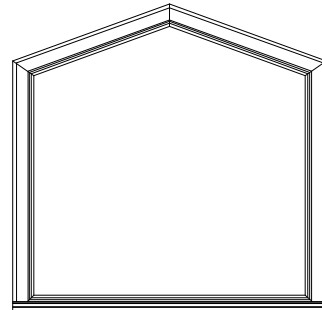

7GTC7272

Note: Elevations shown DO NOT have exterior trim. Subtract 1/2" (12.7) from M.O. (Masonry Opening) for Unit Sizes. Masonry Openings above include Sill Nose, see Trim Options page for Sill Nose specifications. For other Trim Options refer to the Unit Sizing, Rough Opening & Masonry Openings page.

SCALE: 1/4" = 1'

SINGLE UNITS

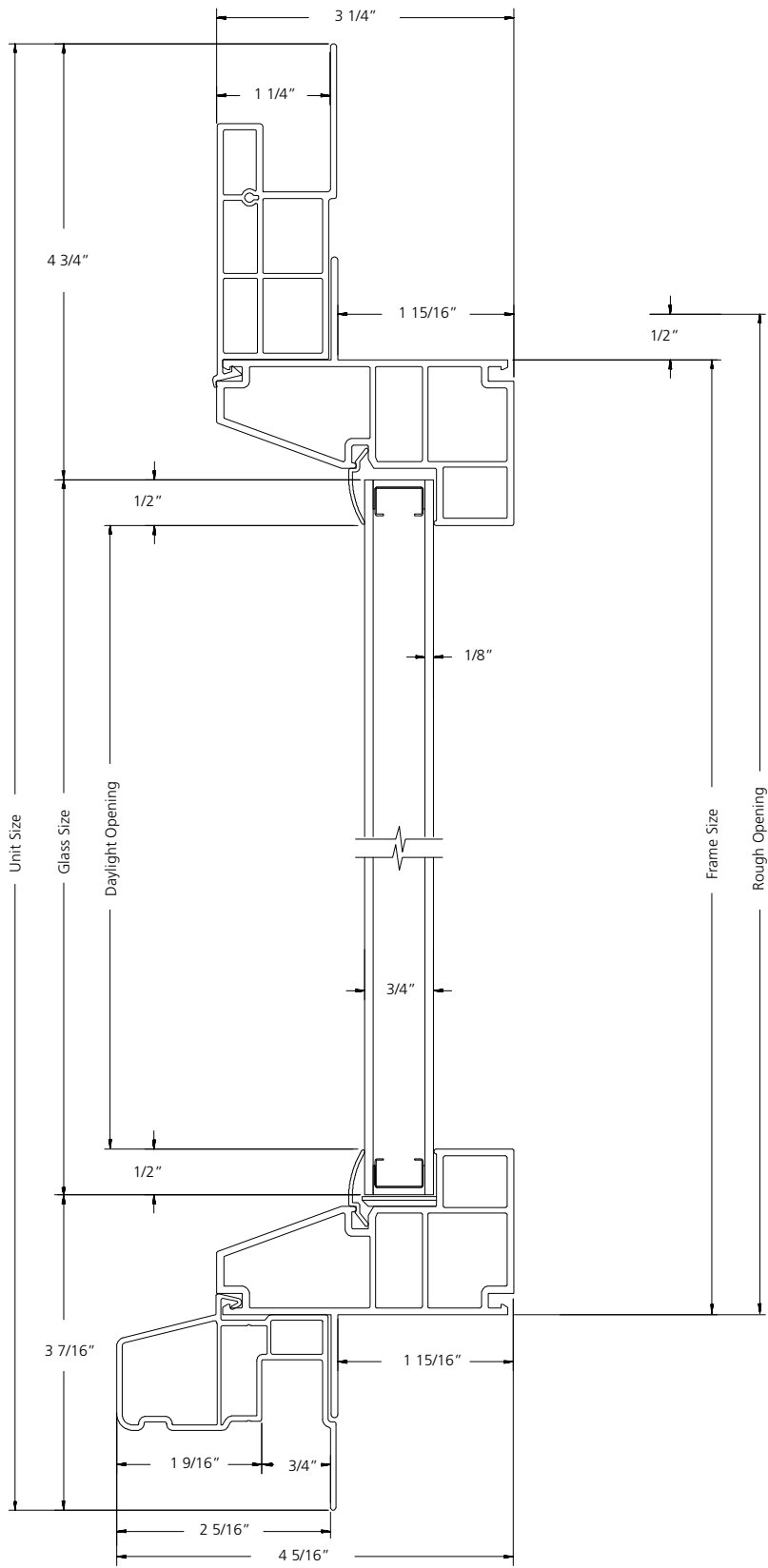

VERTICAL SECTION

SCALE: 6" = 1'

SINGLE UNITS

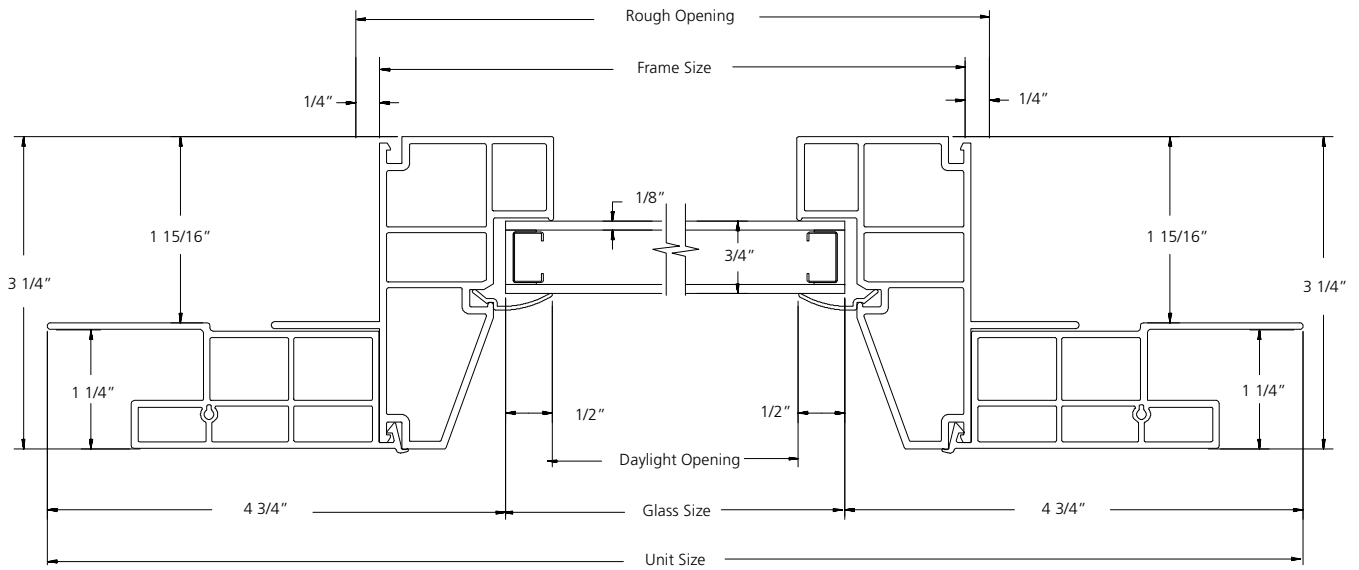

HORIZONTAL SECTION

SCALE: 6" = 1'