TABLE OF CONTENTS

Specifications	1-2
Quick Spec Guide	1-3
Elevations/Sizes: 1/4" Scale	
Full Casement	1-4
2-Wide Casement	1-6
Glazing Options: 3" Scale	1-7
Grille Patterns	1-8
Section Details: 6" Scale	1-9

PRODUCT SPECIFICATIONS

MATERIALS

Extruded vinyl profiles comply with the performance requirements of AAMA 303. The colors extend through the profile of the extrusion with White and Desert Sand colors available.

FRAME

All frames and sash are assembled using fusion-welding technology for added strength and durability. The frame jamb width 3-3/8" (85.725mm), and the nominal extrusion exterior wall thickness is 0.070". The wall depth of the premium product is 1- 15/16". The frame incorporates a traditional brickmould profile with an integral j-channel and nailing fin. Baffled weep holes are included on the frame to ensure standing water is directed to the exterior plane of the unit. The frame incorporates a concealed interior accessory groove to accommodate various frame accessory and assembly options on the product.

SASH

The casement sash is a nominal 2-1/4" (57.15mm) nominal thickness, and is assembled using fusion-welding technology for added strength and durability.

GLAZING

The 3/4" (19mm) and 7/8" (22.22mm) insulated glass consists of two lites of glass sealed around a spacer. The glass is mounted into the sash using a silicone-glazing compound. The insulating glass units comply with the performance requirements of the IGCC in accordance with either ASTM E774 or E2190. All units are exterior glazed.

GLAZING OPTIONS

The 3/4" (19mm) and 7/8" (22.22mm) insulated glass is available in clear, Low-E or Low-E 366, tinted, obscure or other specialty insulating glass options as specified. Many glass options are available in tempered glazing.

WEATHER-STRIPPING

A fin-pile weather-strip is applied along the perimeter of the operating sash. A double row of nylon encased, closed cell foam weather-strip is installed along the full perimeter of the frame.

HARDWARE

The concealed multipoint lock provides exceptional ease of use with the single actuating handle. The casement operator uses a corrosion resistant dual arm operator to ensure maximum performance. Narrower casement units may use a single arm dyad operator. Handing is available in left hand hinge, right hand hinge and stationary.

INSECT SCREENS

The interior fiberglass charcoal color insect screen is set in an aluminum frame to match the color of the unit. The screen is secured to the window using a pin and spring loaded plunger system. Insect screens are intended to allow air and light in and to keep insects out. They are not intended to keep anyone or anything from falling through an open door or window. For safety screens or other security devices contact your local building supply retailer.

GRILLES

GBG (Grilles between the Glass) - 5/8" (16mm) and 7/8" (22.2mm) flat or 1" (26mm) contour grilles mounted between the glass panes suspended within the air cavity and color matched to the extrusion color.

SDL (Simulated Divided Lite) - 7/8" (22.2mm) color-matched contour muntins surface mounted on the exterior surfaces of the insulated glass unit to provide a true divided lite appearance.

EXTENSION JAMBS

Extension jambs are regionally available for JELD-WEN vinyl products. The 4-9/16" and 6-9/16" extension jambs are available in pine clear vinyl wrapped, primed wood, red oak and maple finishes and can be specified on three or four sides of the product.

ADDITIONAL ACCESSORIES

Additional accessories are available for JELD-WEN Vinyl products. Please contact your local building supply retailer for a complete listing of the additional accessories.

INSTALLATION

Installation per JELD-WEN Installation Method for Vinyl Windows JII001, JII010 or JII011. See www.jeld-wen.com/resources for instructions.

PERFORMANCE

NFRC Certified - (rated and labeled in accordance with NFRC)

AAMA/WDMA/CSA 101/I.S.2/A440











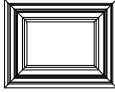
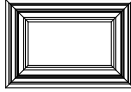
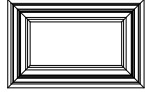

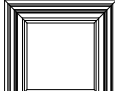
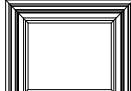



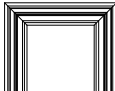
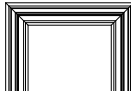



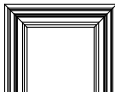

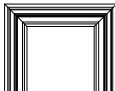
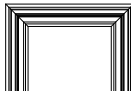

R20-DP rated

Optional DP-35 rating is available.

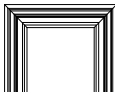
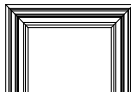
QUICK SPEC GUIDE

SPECIFICATION	STANDARD FEATURES	OPTIONAL FEATURES <i>Some options may require additional lead times. Consult your JELD-WEN Sales Representative.</i>
COLOR	<ul style="list-style-type: none"> White 	<ul style="list-style-type: none"> Desert Sand
SIZE	<ul style="list-style-type: none"> Width: 18" to 36" Height: 20" to 72" 15 sq. ft. maximum in single unit 	
FRAME	<ul style="list-style-type: none"> Traditional Brickmould Profile with J-Channel Nail Fin 	
GLAZING	<ul style="list-style-type: none"> Insulating Clear 	<ul style="list-style-type: none"> Low-E Obscure Bronze Gray Gluechip Rain Azurlite Laminated All glass available tempered <p><i>regional glass availabilities may differ</i></p>
HARDWARE	<ul style="list-style-type: none"> Regular Crank Handle E-Guard™ hardware 	<ul style="list-style-type: none"> Maximum Opening Hardware Coastal Package (regionally available)
HARDWARE COLOR	<ul style="list-style-type: none"> Color matched to extrusion 	
SCREENS	<ul style="list-style-type: none"> Fiberglass 	
SCREEN FRAME COLOR	<ul style="list-style-type: none"> Color matched to extrusion 	
GRILLES		<ul style="list-style-type: none"> 1" Contour GBG (grilles between the glass) 5/8" Flat GBG (grilles between the glass) 7/8" SDL (simulated divided lite) profiles
JAMB DEPTH	<ul style="list-style-type: none"> 3-3/8" 	

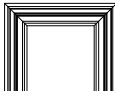
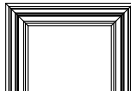
FULL CASEMENT UNITS

UNIT SIZE	22 1/16" (560)	28 1/16" (713)	32 1/16" (814)	34 1/16" (865)	40 1/16" (1018)
ROUGH OPENING	18" (457)	24" (610)	28" (711)	30" (762)	36" (914)
FRAME SIZE	17 1/2" (445)	23 1/2" (597)	27 1/2" (699)	29 1/2" (749)	35 1/2" (902)
DAYLIGHT OPENING	10 3/4" (273)	16 3/4" (425)	20 3/4" (527)	22 3/4" (578)	28 3/4" (730)
22 1/16" (560) 18" (457) 17 1/2" (445) 10 3/4" (273)	 PFCB1818	 PFCB2418	 PFCB2818	 PFCB3018	 PFCB3618
28 1/16" (713) 24" (610) 23 1/2" (597) 16 3/4" (425)	 PFCB1824	 PFCB2424	 PFCB2824	 PFCB3024	 PFCB3624
34 1/16" (865) 30" (762) 29 1/2" (749) 22 3/4" (578)	 PFCB1830	 PFCB2430	 PFCB2830	 PFCB3030	 PFCB3630
40 1/16" (1018) 36" (914) 35 1/2" (902) 28 3/4" (730)	 PFCB1836	 PFCB2436	 PFCB2836	 PFCB3036	 PFCB3636
46 1/16" (1170) 42" (1067) 41 1/2" (1054) 34 3/4" (883)	 PFCB1842	 PFCB2442	 PFCB2842	 PFCB3042	 PFCB3642
52 1/16" (1322) 48" (1219) 47 1/2" (1207) 40 3/4" (1035)	 PFCB1848	 PFCB2448	 PFCB2848	 PFCB3048	 PFCB3648
58 1/16" (1475) 54" (1372) 53 1/2" (1359) 46 3/4" (1187)	 PFCB1854	 PFCB2454	 PFCB2854	 PFCB3054	 PFCB3654

ELEVATION SYMBOL LEGEND:
VALUES IN () ARE IN MILLIMETER CONVERSIONS

Note: Elevations shown DO NOT have exterior trim. Subtract 1/2" (12.7) from M.O. (Masonry Opening) for Unit Sizes. Masonry Openings above include Sill Nose, see Trim Options page for Sill Nose specifications. For other Trim Options refer to the Unit Sizing, Rough Opening & Masonry Openings page.

SCALE: 1/4" = 1'

FULL CASEMENT UNITS



















































	UNIT SIZE	22 1/16" (560)	28 1/16" (713)	32 1/16" (814)	34 1/16" (865)	40 1/16" (1018)
	ROUGH OPENING	18" (457)	24" (610)	28" (711)	30" (762)	36" (914)
	FRAME SIZE	17 1/2" (445)	23 1/2" (597)	27 1/2" (699)	29 1/2" (749)	35 1/2" (902)
	DAYLIGHT OPENING	10 3/4" (273)	16 3/4" (425)	20 3/4" (527)	22 3/4" (578)	28 3/4" (730)
64 1/16" (1627)						
60" (1524)		PFCB1860	PFCB2460	PFCB2860	PFCB3060	PFCB3660
59 1/2" (1511)						
52 3/4" (1340)						
70 1/16" (1780)						
66" (1676)		PFCB1866	PFCB2466	PFCB2866	PFCB3066	PFCB3666
65 1/2" (1664)						
58 3/4" (1492)						
76 1/16" (1932)						
72" (1829)		PFCB1872	PFCB2472	PFCB2872	PFCB3072	PFCB3672
71 1/2" (1861)						
64 3/4" (1645)						

ELEVATION SYMBOL LEGEND:
VALUES IN () ARE IN MILLIMETER CONVERSIONS

Note: Elevations shown DO NOT have exterior trim. Subtract 1/2" (12.7) from M.O. (Masonry Opening) for Unit Sizes. Masonry Openings above include Sill Nose, see Trim Options page for Sill Nose specifications. For other Trim Options refer to the Unit Sizing, Rough Opening & Masonry Openings page.

SCALE: 1/4" = 1'

2 WIDE CASEMENT UNITS

UNIT SIZE ROUGH OPENING FRAME SIZE DAYLIGHT OPENING	40 1/16" (1018) 36" (914)	52 1/16" (1322) 48" (1219)	60 1/16" (1526) 56" (1422)	64 1/16" (1627) 60" (1524)	76 1/16" (1932) 72" (1829)
22 1/16" (560) 18" (457) 17 1/2" (445) 10 3/4" (273)	 PFCB3618-2	 PFCB4818-2	 PFCB5618-2	 PFCB6018-2	 PFCB7218-2
28 1/16" (713) 24" (610) 23 1/2" (597) 16 3/4" (425)	 PFCB3624-2	 PFCB4824-2	 PFCB5624-2	 PFCB6024-2	 PFCB7224-2
34 1/16" (865) 30" (762) 29 1/2" (749) 22 3/4" (578)	 PFCB3630-2	 PFCB4830-2	 PFCB5630-2	 PFCB6030-2	 PFCB7230-2
40 1/16" (1018) 36" (914) 35 1/2" (902) 28 3/4" (730)	 PFCB3636-2	 PFCB4836-2	 PFCB5636-2	 PFCB6036-2	 PFCB7236-2
46 1/16" (1170) 42" (1067) 41 1/2" (1054) 34 3/4" (883)	 PFCB3642-2	 PFCB4842-2	 PFCB5642-2	 PFCB6042-2	 PFCB7242-2
52 1/16" (1322) 48" (1219) 47 1/2" (1207) 40 3/4" (1035)	 PFCB3648-2	 PFCB4848-2	 PFCB5648-2	 PFCB6048-2	 PFCB7248-2
58 1/16" (1475) 54" (1372) 53 1/2" (1359) 46 3/4" (1187)	 PFCB3654-2	 PFCB4854-2	 PFCB5654-2	 PFCB6054-2	 PFCB7254-2
64 1/16" (1627) 60" (1524) 59 1/2" (1511) 52 3/4" (1340)	 PFCB3660-2	 PFCB4860-2	 PFCB5660-2	 PFCB6060-2	 PFCB7260-2
70 1/16" (1780) 66" (1676) 65 1/2" (1664) 58 3/4" (1492)	 PFCB3666-2	 PFCB4866-2	 PFCB5666-2	 PFCB6066-2	 PFCB7266-2
76 1/16" (1932) 72" (1829) 71 1/2" (1861) 64 3/4" (1645)	 PFCB3672-2	 PFCB4872-2	 PFCB5672-2	 PFCB6072-2	 PFCB7272-2

ELEVATION SYMBOL LEGEND:
VALUES IN () ARE IN MILLIMETER CONVERSIONS

Note: Elevations shown DO NOT have exterior trim. Subtract 1/2" (12.7) from M.O. (Masonry Opening) for Unit Sizes. Masonry Openings above include Sill Nose, see Trim Options page for Sill Nose specifications. For other Trim Options refer to the Unit Sizing, Rough Opening & Masonry Openings page.

SCALE: 1/8" = 1'

GLAZING OPTIONS

EXTERIOR GLAZED

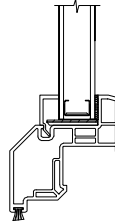

STANDARD 3/4" GLASS

GRILLE PATTERNS

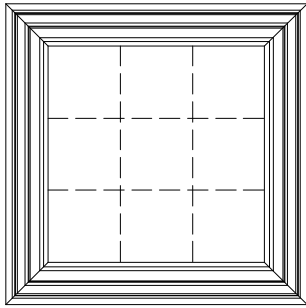

STANDARD

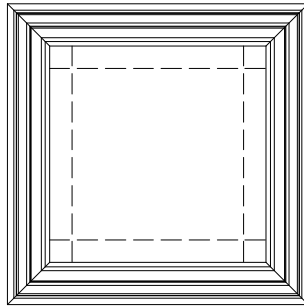

PRAIRIE

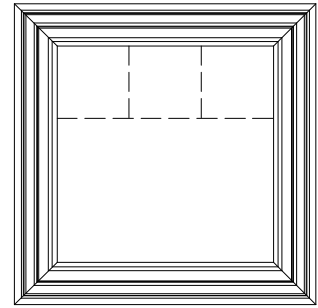

COLONIAL TOP SASH
1/2 LITE

FULL CASEMENT UNIT

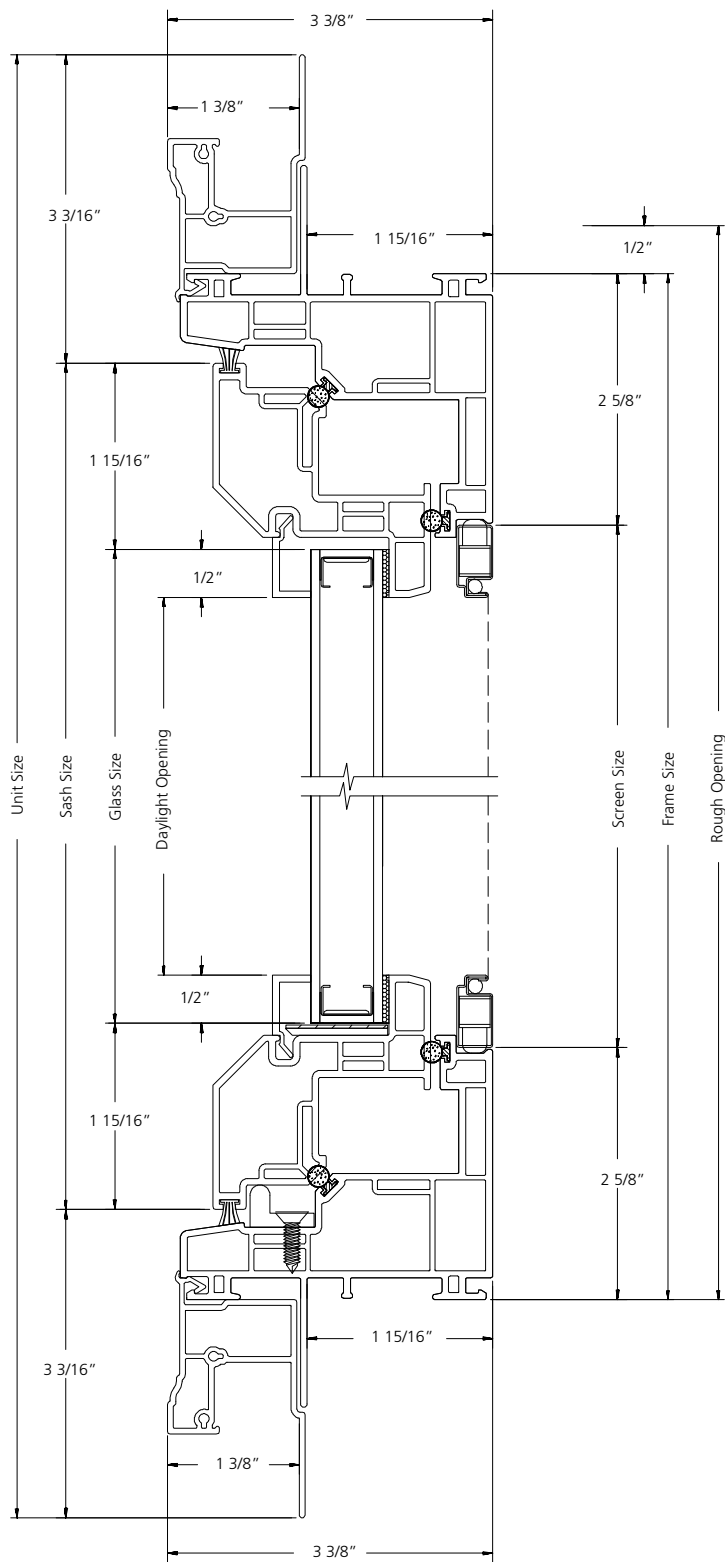

VERTICAL SECTION

SCALE: 6" = 1'

FULL CASEMENT UNIT

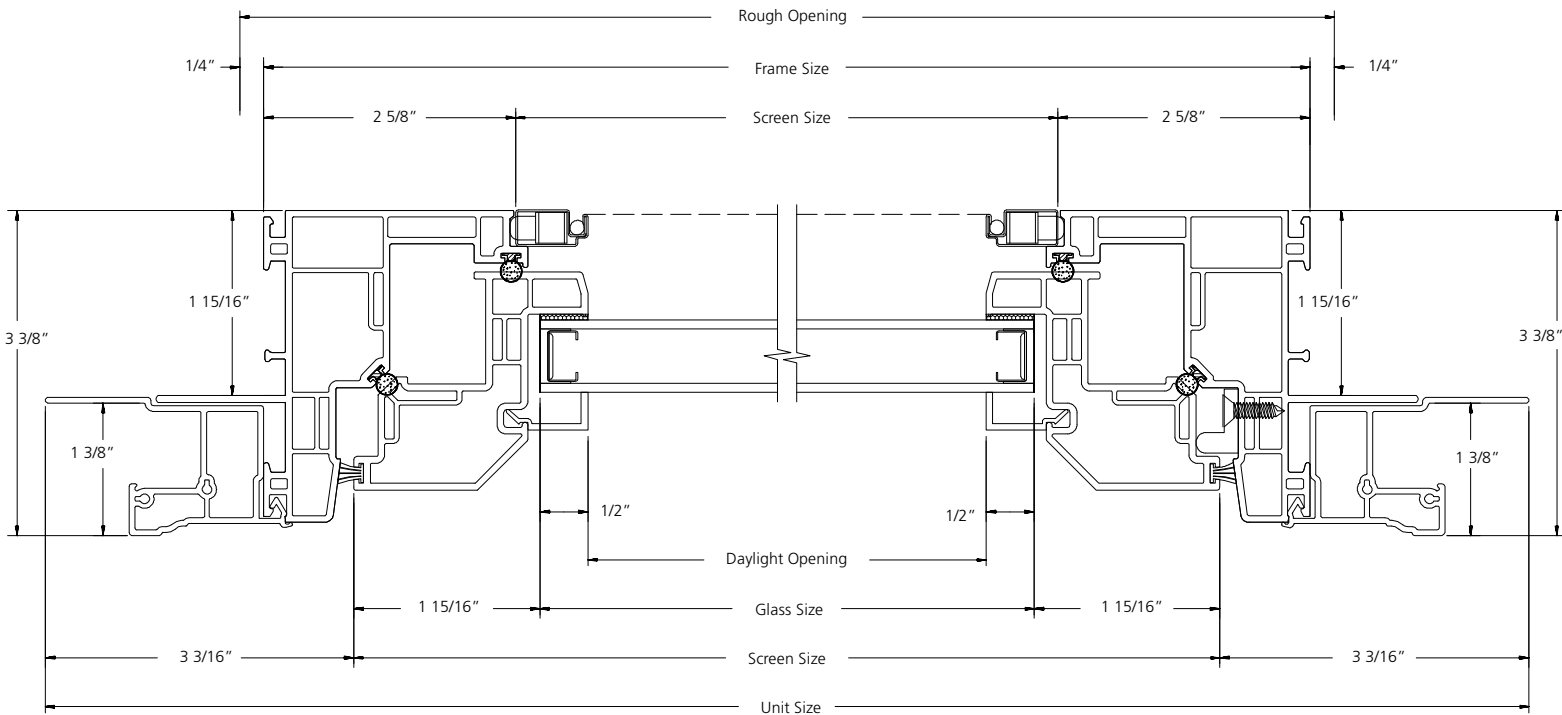

HORIZONTAL SECTION

SCALE: 6" = 1'

TWIN CASEMENT UNIT

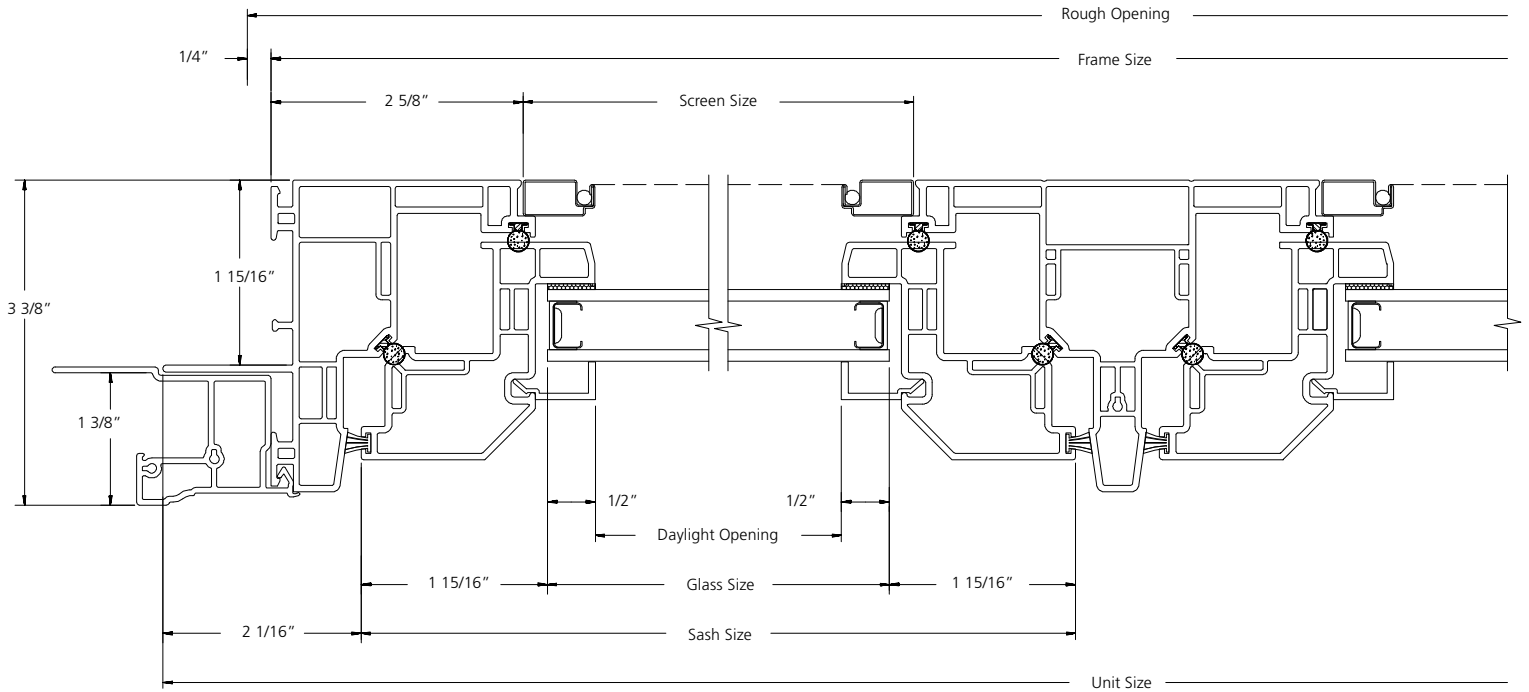

HORIZONTAL SECTION

SCALE: 6" = 1'