TABLE OF CONTENTS

Specifications	3-2
Quick Spec Guide	3-3
Elevations/Sizes: 1/4" Scale	
Double-Hung	3-4
2-Wide Double-Hung	3-12
3-Wide Double-Hung with Center Picture	3-17
Double-Hung with Half Round	3-20
2-Wide Double-Hung with Half Round	3-35
Glazing Options: 3" Scale	3-49
Grille Patterns	3-50
Section Details: 6" Scale	3-51

PRODUCT SPECIFICATIONS

MATERIALS

Extruded vinyl profiles comply with the performance requirements of AAMA 303. The colors extend through the profile of the extrusion with White and Desert Sand colors available. The product is not available in the Western United States markets.

FRAME

All frames and sash are assembled utilizing fusion-welded technology for added strength and durability. The frame jamb width is 3-5/8" (92.97mm), and the nominal extrusion exterior wall thickness is 0.060". The wall depth of the double-hung product is 2-1/2". The frame incorporates a traditional brickmould profile with an integral j-channel and nailing fin. The Brickmould Double-Hung product is designed with a traditional 5/4 (1-1/4") sill to match a traditional double-hung appearance. Additionally, the Brickmould Double-Hung window is designed with a sloped sill to maximize water runoff. Weep holes are included on the frame to ensure standing water is directed to the exterior plane of the unit. An interior accessory groove is standard to accommodate various frame accessory and assembly options on the product.

SASH

The tilt sash is 1-3/8" (35.18mm) nominal thickness and is assembled using fusion-welding technology for added strength and durability. The sash also uses a steel reinforcement bar in the horizontal working rail of each operating sash for additional strength.

GLAZING

3/4" (19mm) insulating glass consists of two lites of glass sealed around a spacer. The glass is mounted into the sash using a silicone-glazing compound. The insulating glass units comply with the performance requirements of the IGCC in accordance with either ASTM E774 or E2190. All units are exterior glazed.

GLAZING OPTIONS

3/4" (19mm) insulated glass is available in clear, Low-E or Low-E 366, tinted, obscure, or other specialty insulating glass as specified. Many glass options are available in tempered glazing.

WEATHER-STRIPPING

A fin-pile weather-strip is applied along dual full perimeters of operating sash. A high performance foam filled weather-strip is used at the meeting rail. In addition, an engineered TPE weather-strip is utilized on the bottom rail to provide maximum performance.

HARDWARE

A single action cam style lock is available on all windows. Block and tackle balance systems are utilized to support the vertical operation of the sash. Low profile thumb latches (sash retainers) and pivot pins are equipped for utilization of the "tilt" function.

INSECT SCREENS

The optional overlay full view fiberglass charcoal color insect screen is set in an aluminum frame to match the color of the unit. The screen is secured to the window using a pin and spring loaded plunger system. Insect screens are intended to allow air and light in and to keep insects out. They are not intended to keep anyone or anything from falling through an open door or window. For safety screens or other security devices contact your local building supply retailer.

GRILLES

GBG (Grilles between the Glass) - 5/8" (16mm) and 7/8" (22.2mm) flat or 1" (26mm) contour grilles mounted between the glass panes suspended within the air cavity and color matched to the extrusion color.

SDL (Simulated Divided Lite) - 7/8" (22.2mm) color-matched contour muntins surface mounted on the exterior surfaces of the insulated glass unit to provide a true divided lite appearance.

EXTENSION JAMBS

Extension jambs are regionally available for JELD-WEN Vinyl products. The 4-9/16" and 6-9/16" extension jambs are available in pine clear vinyl wrapped, primed wood, red oak and maple finishes and can be specified on three or four sides of the product.

ADDITIONAL ACCESSORIES

Additional accessories are available for JELD-WEN Vinyl products. Please contact your local building supply retailer for a complete listing of the additional accessories.

INSTALLATION

Installation per JELD-WEN Installation Method for Vinyl Windows JII001, JII010 or JII011. See www.jeld-wen.com/resources for instructions.

PERFORMANCE

NFRC Certified - (rated and labeled in accordance with NFRC)

AAMA/WDMA/CSA 101/I.S.2/A440

R20-DP rated

Optional DP-35 and DP-50 ratings are available

QUICK SPEC GUIDE

SPECIFICATION	STANDARD FEATURES	OPTIONAL FEATURES <i>Some options may require additional lead times. Consult your JELD-WEN Sales Representative.</i>
COLOR	<ul style="list-style-type: none"> White 	<ul style="list-style-type: none"> Desert Sand
SIZE	<ul style="list-style-type: none"> Width: 18" to 48" Height: 24" to 77" 	
FRAME	<ul style="list-style-type: none"> Integral Brickmould J-channel 	
GLAZING	<ul style="list-style-type: none"> Insulating Low-E 	<ul style="list-style-type: none"> Clear Low-E 366 Low-E Keep Clean Obscure Bronze Gray All glass available tempered <p><i>regional glass availabilities may differ</i></p>
HARDWARE	<ul style="list-style-type: none"> Block and Tackle Balance System Cam Lock Thumb Latches 	
HARDWARE COLOR	<ul style="list-style-type: none"> Color matched to extrusion 	
SCREENS	<ul style="list-style-type: none"> Fiberglass 	
SCREEN FRAME COLOR	<ul style="list-style-type: none"> Color matched to extrusion 	
GRILLES		<ul style="list-style-type: none"> 5/8", 1" Contour GBG (grilles between the glass) 5/8", 7/8" Flat GBG (grilles between the glass) 7/8" SDL (simulated divided lite) profiles
JAMB DEPTH	<ul style="list-style-type: none"> 3-5/8" 	<ul style="list-style-type: none"> 4-9/16" Extension Jambs Applied 6-9/16" Extension Jambs Applied
ACCESSORIES		<ul style="list-style-type: none"> Extension Jamb Retainer Drywall Retainer

DOUBLE-HUNG

UNIT SIZE	20 3/4" (527)	22 3/4" (578)	24 3/4" (629)	26 3/4" (679)	28 3/4" (730)	30 3/4" (781)	32 3/4" (832)	34 3/4" (883)
ROUGH OPENING	18" (457)	20" (508)	22" (559)	24" (610)	26" (660)	28" (711)	30" (762)	32" (813)
FRAME SIZE	17 1/2" (445)	18 1/2" (495)	21 1/2" (546)	23 1/2" (597)	25 1/2" (648)	27 1/2" (699)	29 1/2" (749)	31 1/2" (800)
DAYLIGHT OPENING	11" (279)[2]	13" (330)[2]	15" (381)[2]	17" (432)[2]	19" (483)[2]	21" (533)[2]	23" (584)[2]	25" (635)[2]
32 3/4" (832) 30" (762) 29 1/2" (749) 11 3/16" (284) 10 3/16" (262)								
MDHB1830	MDHB2030	MDHB2230	MDHB2430	MDHB2630	MDHB2830	MDHB3030	MDHB3230	
38 3/4" (984) 36" (914) 35 1/2" (902) 14 1/16" (358) 13 5/16" (338)								
MDHB1836	MDHB2036	MDHB2236	MDHB2436	MDHB2636	MDHB2836	MDHB3036	MDHB3236	
39 3/4" (1010) 37" (940) 36 1/2" (927) 14 1/16" (353) 13 13/16" (331)								
MDHB1837	MDHB2037	MDHB2237	MDHB2437	MDHB2637	MDHB2837	MDHB3037	MDHB3237	
40 3/4" (1035) 38" (965) 37 1/2" (953) 14 1/16" (386) 14 5/16" (364)								
MDHB1838	MDHB2038	MDHB2238	MDHB2438	MDHB2638	MDHB2838	MDHB3038	MDHB3238	
43 3/4" (1111) 41" (1041) 40 1/2" (1029) 15 1/16" (402) 15 13/16" (402)								
MDHB1841	MDHB2041	MDHB2241	MDHB2441	MDHB2641	MDHB2841	MDHB3041	MDHB3241	
44 3/4" (1137) 42" (1067) 41 1/2" (1054) 15 1/16" (437) 15 5/16" (414)								
MDHB1842	MDHB2042	MDHB2242	MDHB2442	MDHB2642	MDHB2842	MDHB3042	MDHB3242	
50 3/4" (1289) 48" (1219) 47 1/2" (1207) 19 1/16" (493) 19 5/16" (493)								
MDHB1848	MDHB2048	MDHB2248	MDHB2448	MDHB2648	MDHB2848	MDHB3048	MDHB3248	

ELEVATION SYMBOL LEGEND:

VALUES IN () ARE IN MILLIMETER CONVERSIONS

VALUES IN [] ARE NUMBER OF DAYLIGHT OPENINGS PER UNIT

NUMBER INDICATES DESIGN PRESSURE (DP) RATING WITH STANDARD GLAZING.

NUMBER INDICATES OPTIONAL DESIGN PRESSURE (DP) RATING.

Note: Elevations shown DO NOT have exterior trim. Subtract 1/2" (12.7) from M.O. (Masonry Opening) for Unit Sizes. Masonry Openings above include Sill Nose, see Trim Options page for Sill Nose specifications. For other Trim Options refer to the Unit Sizing, Rough Opening & Masonry Openings page.

SCALE: 1/4" = 1'

DOUBLE-HUNG

UNIT SIZE ROUGH OPENING FRAME SIZE DAYLIGHT OPENING	20 3/4"(527) 18"(457) 17 1/2"(445) 11"(279)[2]	22 3/4"(578) 20"(508) 18 1/2"(495) 13"(330)[2]	24 3/4"(629) 22"(559) 21 1/2"(546) 15"(381)[2]	26 3/4"(679) 24"(610) 23 1/2"(597) 17"(432)[2]	28 3/4"(730) 26"(660) 25 1/2"(648) 19"(483)[2]	30 3/4"(781) 28"(711) 27 1/2"(699) 21"(533)[2]	32 3/4"(832) 30"(762) 29 1/2"(749) 23"(584)[2]	34 3/4"(883) 32"(813) 31 1/2"(800) 25"(635)[2]
51 3/4"(1314) 49"(1245) 48 1/2"(1232) 20 1/16"(525) 19 13/16"(503)								
55 3/4"(1416) 53"(1346) 52 1/2"(1334) 22 1/16"(576) 21 3/16"(554)								
56 3/4"(1441) 54"(1372) 53 1/2"(1359) 23 3/16"(589) 22 5/16"(578)								
59 3/4"(1518) 57"(1449) 56 1/2"(1435) 24 1/16"(627) 23 13/16"(605)								
62 3/4"(1594) 60"(1524) 59 1/2"(1511) 26 3/16"(665) 25 5/16"(643)								
64 3/4"(1645) 62"(1575) 61 1/2"(1562) 27 3/16"(691) 26 5/16"(668)								

ELEVATION SYMBOL LEGEND:
VALUES IN () ARE IN MILLIMETER CONVERSIONS
VALUES IN [] ARE NUMBER OF DAYLIGHT OPENINGS PER UNIT
NUMBER INDICATES DESIGN PRESSURE (DP) RATING WITH STANDARD GLAZING.
NUMBER INDICATES OPTIONAL DESIGN PRESSURE (DP) RATING.

Note: Elevations shown DO NOT have exterior trim. Subtract 1/2" (12.7) from M.O. (Masonry Opening) for Unit Size Masonry Openings above include Sill Nose, see Trim Options page for Sill Nose specifications. For other Trim Options refer to the Unit Sizing, Rough Opening & Masonry Openings page.

SCALE: 1/4" = 1'

DOUBLE-HUNG

UNIT SIZE
ROUGH OPENING
FRAME SIZE
DAYLIGHT OPENING

20 3/4" (527)
18" (457)
17 1/2" (445)
11" (279)[2]
11 7/8" (302)[2]

22 3/4" (578)
20" (508)
18 1/2" (495)
13" (330)[2]
13 7/8" (352)[2]

24 3/4" (629)
22" (559)
21 1/2" (546)
15" (381)[2]
15 7/8" (403)[2]

26 3/4" (679)
24" (610)
23 1/2" (597)
17" (432)[2]
17 7/8" (454)[2]

28 3/4" (730)
26" (660)
25 1/2" (648)
19" (483)[2]
19 7/8" (505)[2]

30 3/4" (781)
28" (711)
27 1/2" (699)
21" (533)[2]
21 7/8" (556)[2]

32 3/4" (832)
30" (762)
29 1/2" (749)
23" (584)[2]
23 7/8" (607)[2]

34 3/4" (883)
32" (813)
31 1/2" (800)
25" (635)[2]
25 7/8" (657)[2]

67 3/4" (1721)
65" (1651)
64 1/2" (1638)
58 1/2" (1476)
27 13/16" (706)

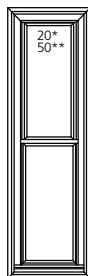

MDHB1865

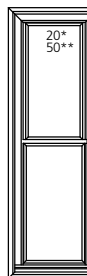

MDHB2065

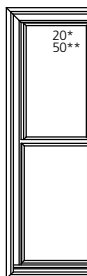

MDHB2265

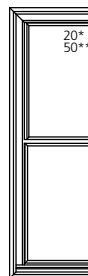

MDHB2465

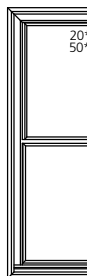

MDHB2665

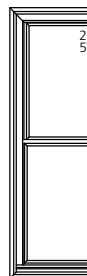

MDHB2865



MDHB3065

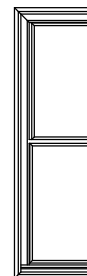

MDHB3265

68 3/4" (1746)
66" (1676)
65 1/2" (1664)
59 1/2" (1502)
28 5/16" (719)

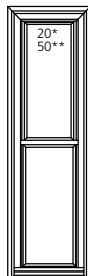

MDHB1866

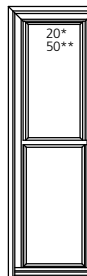

MDHB2066

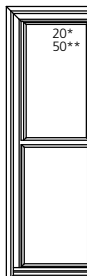

MDHB2266

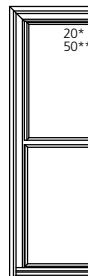

MDHB2466

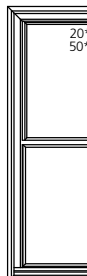

MDHB2666

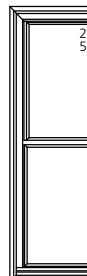

MDHB2866

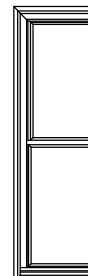

MDHB3066

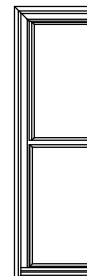

MDHB3266

71 3/4" (1822)
69" (1752)
68 1/2" (1740)
62 1/2" (1578)
29 13/16" (757)

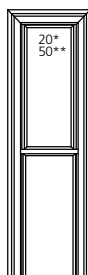

MDHB1869

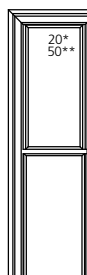

MDHB2069

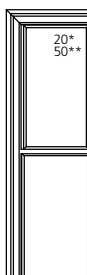

MDHB2269

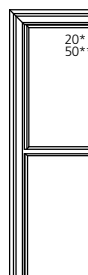

MDHB2469

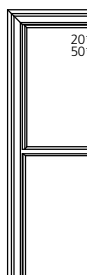

MDHB2669

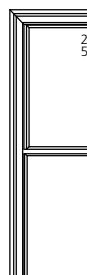

MDHB2869

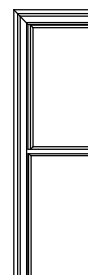

MDHB3069

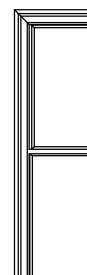

MDHB3269

74 3/4" (1899)
72" (1829)
71 1/2" (1816)
65 1/2" (1654)
31 5/16" (795)

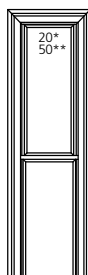

MDHB1872

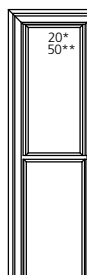

MDHB2072

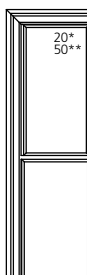

MDHB2272

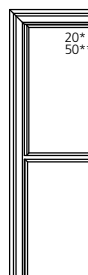

MDHB2472



MDHB2672

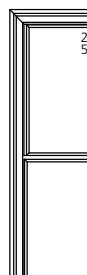

MDHB2872



MDHB3072

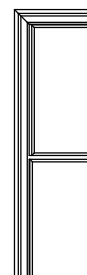

MDHB3272

76 3/4" (1949)
74" (1880)
73 1/2" (1867)
67 1/2" (1705)
32 3/16" (821)

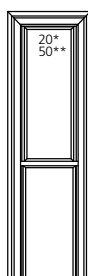

MDHB1874



MDHB2074



MDHB2274

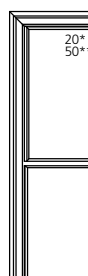

MDHB2474



MDHB2674

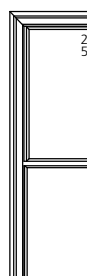

MDHB2874



MDHB3074



MDHB3274

ELEVATION SYMBOL LEGEND:
VALUES IN () ARE IN MILLIMETER CONVERSIONS
VALUES IN [] ARE NUMBER OF DAYLIGHT OPENINGS PER UNIT

NUMBER INDICATES DESIGN PRESSURE (DP) RATING WITH STANDARD GLAZING.
###* NUMBER INDICATES OPTIONAL DESIGN PRESSURE (DP) RATING.

E BASIC UNIT CLEAR OPENING EXCEEDS 20" IN WIDTH, 24" IN HEIGHT & A MINIMUM OF 5.7 SQ. FT.

Note: Elevations shown DO NOT have exterior trim. Subtract 1/2" (12.7) from M.O. (Masonry Opening) for Unit Sizes. Masonry Openings above include Sill Nose, see Trim Options page for Sill Nose specifications. For other Trim Options refer to the Unit Sizing, Rough Opening & Masonry Openings page.

SCALE: 1/4" = 1'

DOUBLE-HUNG

UNIT SIZE	20 3/4" (527)	22 3/4" (578)	24 3/4" (629)	26 3/4" (679)	28 3/4" (730)	30 3/4" (781)	32 3/4" (832)	34 3/4" (883)
ROUGH OPENING	18" (457)	20" (508)	22" (559)	24" (610)	26" (660)	28" (711)	30" (762)	32" (813)
FRAME SIZE	17 1/2" (445)	18 1/2" (495)	21 1/2" (546)	23 1/2" (597)	25 1/2" (648)	27 1/2" (699)	29 1/2" (749)	31 1/2" (800)
DAYLIGHT OPENING	11 7/8" (302)[2]	13 7/8" (352)[2]	15 7/8" (403)[2]	17 7/8" (454)[2]	19 7/8" (505)[2]	21 7/8" (556)[2]	23 7/8" (607)[2]	25 7/8" (657)[2]

79 3/4" (2026)	20" 50**	20" 50**	20" 50**	20" 50**	20" 50**	20" 50**	20" 50**	20" 50**
77" (1956)								
76 1/2" (1943)								
34 1/16" (881)								
33 13/16" (859)								

MDHB1877	MDHB2077	MDHB2277	MDHB2477	MDHB2677	MDHB2877	MDHB3077	MDHB3277
----------	----------	----------	----------	----------	----------	----------	----------

ELEVATION SYMBOL LEGEND:

VALUES IN () ARE IN MILLIMETER CONVERSIONS
VALUES IN [] ARE NUMBER OF DAYLIGHT OPENINGS PER UNIT

*** NUMBER INDICATES DESIGN PRESSURE (DP) RATING WITH STANDARD GLAZING.
*** NUMBER INDICATES OPTIONAL DESIGN PRESSURE (DP) RATING.

E BASIC UNIT CLEAR OPENING EXCEEDS 20" IN WIDTH, 24" IN HEIGHT & A MINIMUM OF 5.7 SQ. FT.

Note: Elevations shown DO NOT have exterior trim. Subtract 1/2" (12.7) from M.O. (Masonry Opening) for Unit Sizes. Masonry Openings above include Sill Nose, see Trim Options page for Sill Nose specifications. For other Trim Options refer to the Unit Sizing, Rough Opening & Masonry Openings page.

SCALE: 1/4" = 1'

DOUBLE-HUNG

UNIT SIZE
ROUGH OPENING
FRAME SIZE
DAYLIGHT OPENING

	36 3/4" (933) 34" (864) 33 1/2" (851) 27" (686)[2] 27 7/8" (708)[2]	38 3/4" (984) 36" (914) 35 1/2" (902) 29" (737)[2] 29 7/8" (579)[2]	40 3/4" (1035) 38" (965) 37 1/2" (953) 31" (787)[2] 31 7/8" (810)[2]	42 3/4" (1086) 40" (1016) 39 1/2" (1003) 33" (838)[2] 33 7/8" (860)[2]	44 3/4" (1137) 42" (1067) 41 1/2" (1054) 35" (889)[2] 35 7/8" (911)[2]	48 3/4" (1238) 46" (1168) 45 1/2" (1156) 39" (991)[2] 39 7/8" (1013)[2]
32 3/4" (832) 30" (762) 29 1/2" (749) 11 3/16" (284) 10 5/16" (262)						
38 3/4" (984) 36" (914) 35 1/2" (902) 14 3/16" (360) 13 5/16" (338)						
39 3/4" (1010) 37" (940) 36 1/2" (927) 14 1/16" (373) 13 13/16" (351)						
40 3/4" (1035) 38" (965) 37 1/2" (953) 15 3/16" (386) 14 5/16" (364)						
43 3/4" (1111) 41" (1041) 40 1/2" (1029) 16 1/16" (424) 15 13/16" (402)						
44 3/4" (1137) 42" (1067) 41 1/2" (1054) 17 3/16" (437) 16 5/16" (414)						
50 3/4" (1289) 48" (1219) 47 1/2" (1207) 20 3/16" (513) 19 5/16" (491)						
51 3/4" (1314) 49" (1245) 48 1/2" (1232) 20 1/16" (525) 19 13/16" (503)						

ELEVATION SYMBOL LEGEND:
VALUES IN () ARE IN MILLIMETER CONVERSIONS
VALUES IN [] ARE NUMBER OF DAYLIGHT OPENINGS PER UNIT
##* NUMBER INDICATES DESIGN PRESSURE (DP) RATING WITH STANDARD GLAZING.
###* NUMBER INDICATES OPTIONAL DESIGN PRESSURE (DP) RATING.

Note: Elevations shown DO NOT have exterior trim. Subtract 1/2" (12.7) from M.O. (Masonry Opening) for Unit Sizes. Masonry Openings above include Sill Nose, see Trim Options page for Sill Nose specifications. For other Trim Options refer to the Unit Sizing, Rough Opening & Masonry Openings page.

SCALE: 1/4" = 1'

DOUBLE-HUNG

UNIT SIZE
ROUGH OPENING
FRAME SIZE
DAYLIGHT OPENING

36 3/4"(933)
34"(864)
33 1/2"(851)
27"(686)[2]
27 7/8"(708)[2]

38 3/4"(984)
36"(914)
35 1/2"(902)
29"(737)[2]
29 7/8"(579)[2]

40 3/4"(1035)
38"(965)
37 1/2"(953)
31"(787)[2]
31 7/8"(810)[2]

42 3/4"(1086)
40"(1016)
39 1/2"(1003)
33"(838)[2]
33 7/8"(860)[2]

44 3/4"(1137)
42"(1067)
41 1/2"(1054)
35"(889)[2]
35 7/8"(911)[2]

48 3/4"(1238)
46"(1168)
45 1/2"(1156)
39"(991)[2]
39 7/8"(1013)[2]

55 3/4"(1416)
53"(1346)
52 1/2"(1334)
22 1/16"(576)
21 13/16"(554)

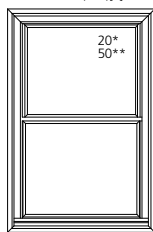

MDHB3453

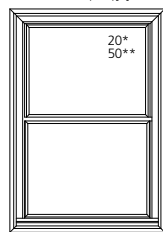

MDHB3653

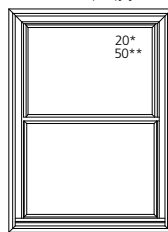

MDHB3853

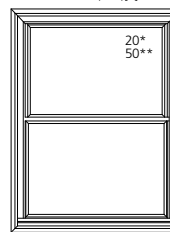

MDHB4053

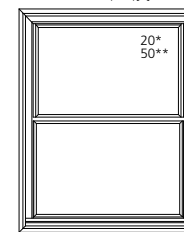

MDHB4253

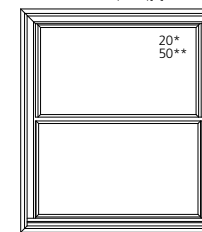

MDHB4653

56 3/4"(1441)
54"(1372)
53 1/2"(1359)
23 3/16"(589)
22 5/16"(578)

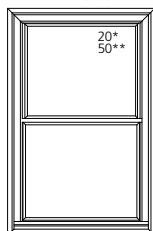

MDHB3454

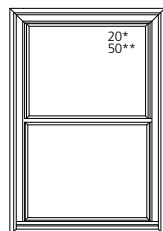

MDHB3654

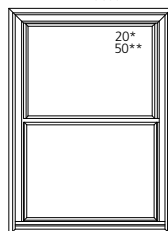

MDHB3854

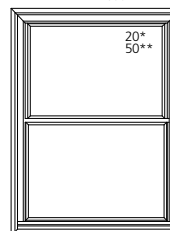

MDHB4054

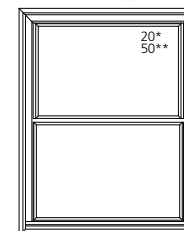

MDHB4254

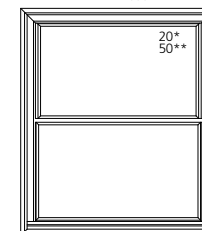

MDHB4654

59 3/4"(1518)
57"(1449)
56 1/2"(1435)
24 1/16"(627)
23 13/16"(605)

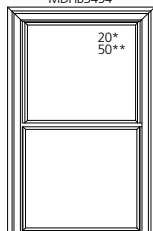

MDHB3457

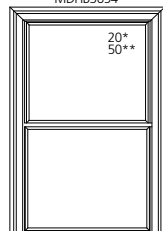

MDHB3657

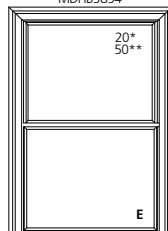

MDHB3857

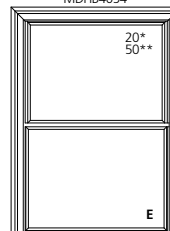

MDHB4057

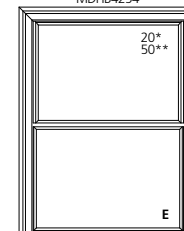

MDHB4257

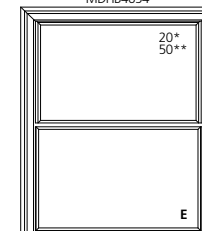

MDHB4657

62 3/4"(1594)
60"(1524)
59 1/2"(1511)
26 3/16"(665)
25 5/16"(643)

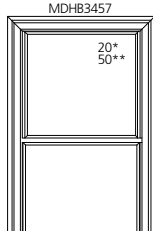

MDHB3460

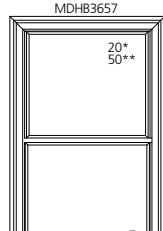

MDHB3660

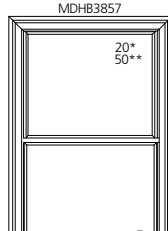

MDHB3860

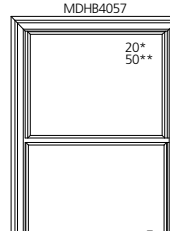

MDHB4060

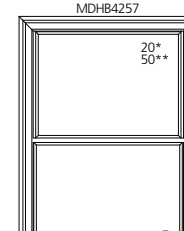

MDHB4260

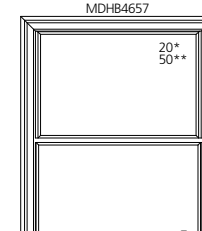

MDHB4660

64 3/4"(1645)
62"(1575)
61 1/2"(1562)
27 3/16"(691)
26 5/16"(668)

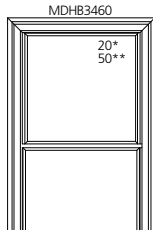

MDHB3462

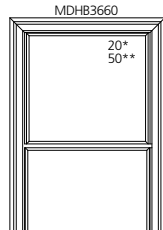

MDHB3662

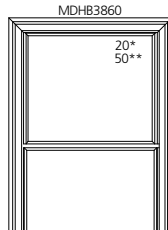

MDHB3862

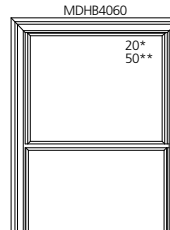

MDHB4062

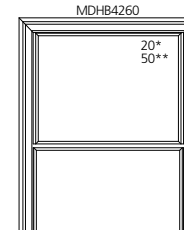

MDHB4262

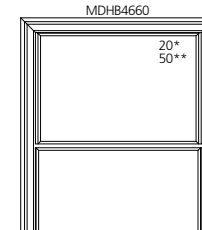

MDHB4662

67 3/4"(1721)
65"(1651)
64 1/2"(1638)
28 1/16"(729)
27 13/16"(706)

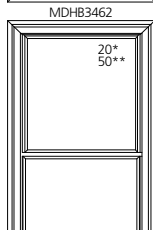

MDHB3465

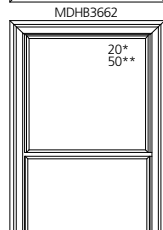

MDHB3665

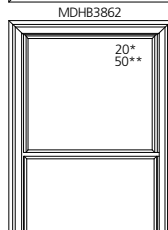

MDHB3865

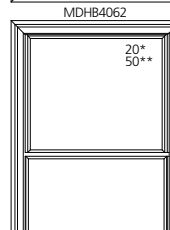

MDHB4065

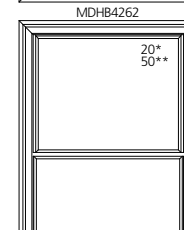

MDHB4265

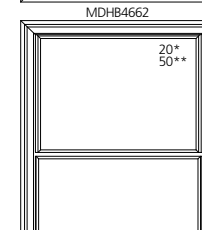

MDHB4665

ELEVATION SYMBOL LEGEND:

VALUES IN () ARE IN MILLIMETER CONVERSIONS
VALUES IN [] ARE NUMBER OF DAYLIGHT OPENINGS PER UNIT

NUMBER INDICATES DESIGN PRESSURE (DP) RATING WITH STANDARD GLAZING.

NUMBER INDICATES OPTIONAL DESIGN PRESSURE (DP) RATING.

E BASIC UNIT CLEAR OPENING EXCEEDS 20" IN WIDTH, 24" IN HEIGHT & A MINIMUM OF 5.7 SQ. FT.

Note: Elevations shown DO NOT have exterior trim. Subtract 1/2" (12.7) from M.O. (Masonry Opening) for Unit Sizes. Masonry Openings above include Sill Nose, see Trim Options page for Sill Nose specifications. For other Trim Options refer to the Unit Sizing, Rough Opening & Masonry Openings page.

SCALE: 1/4" = 1'

DOUBLE-HUNG

UNIT SIZE
ROUGH OPENING
FRAME SIZE
DAYLIGHT OPENING

36 3/4"(933)
34"(864)
33 1/2"(851)
27"(686)[2]
27 7/8"(708)[2]

38 3/4"(984)
36"(914)
35 1/2"(902)
29"(737)[2]
29 7/8"(579)[2]

40 3/4"(1035)
38"(965)
37 1/2"(953)
31"(787)[2]
31 7/8"(810)[2]

42 3/4"(1086)
40"(1016)
39 1/2"(1003)
33"(838)[2]
33 7/8"(860)[2]

44 3/4"(1137)
42"(1067)
41 1/2"(1054)
35"(889)[2]
35 7/8"(911)[2]

48 3/4"(1238)
46"(1168)
45 1/2"(1156)
39"(991)[2]
39 7/8"(1013)[2]

68 3/4"(1746)
66"(1676)
65 1/2"(1664)
29 3/16"(741)
28 5/16"(719)

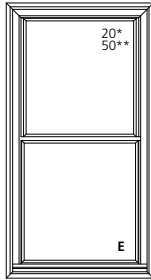

MDHB3466

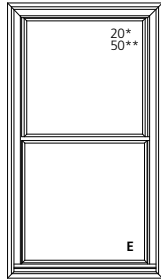

MDHB3666

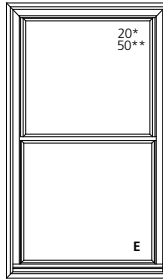

MDHB3866

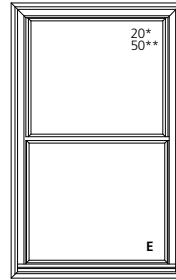

MDHB4066

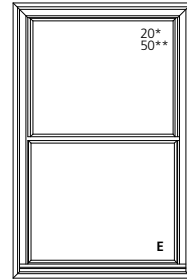

MDHB4266

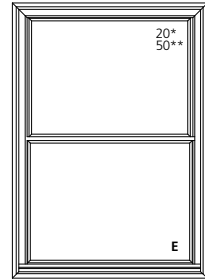

MDHB4666

71 3/4"(1822)
69"(1753)
68 1/2"(1740)
30 1/16"(779)
29 13/16"(757)

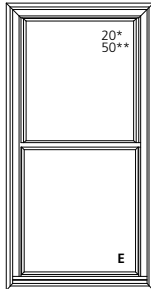

MDHB3469

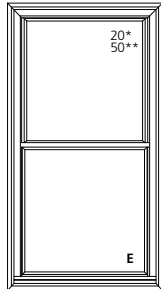

MDHB3669

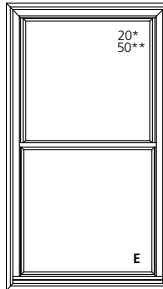

MDHB3869

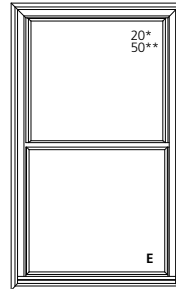

MDHB4069

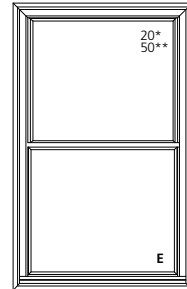

MDHB4269

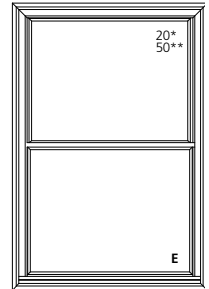

MDHB4669

74 3/4"(1899)
72"(1829)
71 1/2"(1861)
32 3/16"(818)
31 5/16"(795)

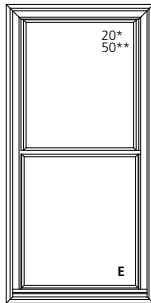

MDHB3472

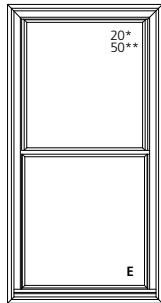

MDHB3672

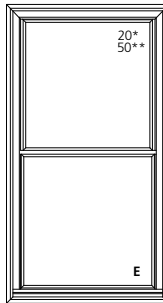

MDHB3872

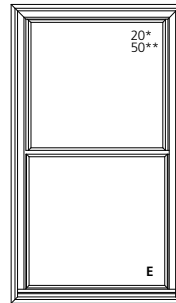

MDHB4072

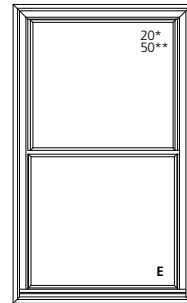

MDHB4272

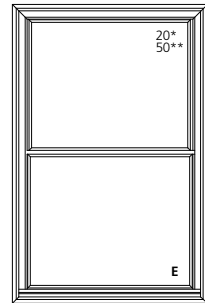

MDHB4672

76 3/4"(1949)
74"(1880)
73 1/2"(1867)
33 3/16"(843)
32 5/16"(821)

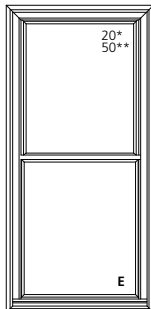

MDHB3474

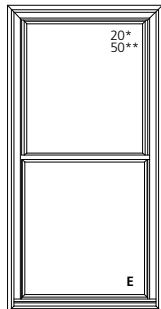

MDHB3674

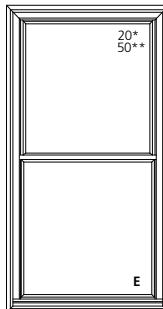

MDHB3874

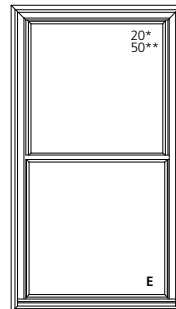

MDHB4074

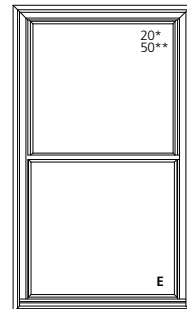

MDHB4274

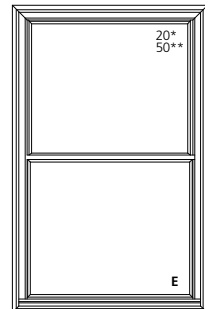

MDHB4674

79 3/4"(2026)
77"(1956)
76 1/2"(1943)
34 1/16"(881)
33 13/16"(859)

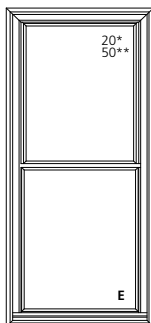

MDHB3477

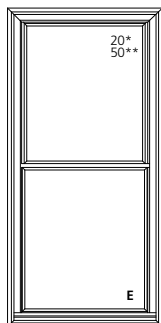

MDHB3677

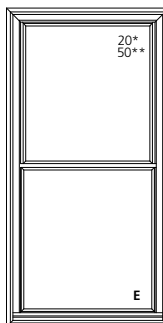

MDHB3877

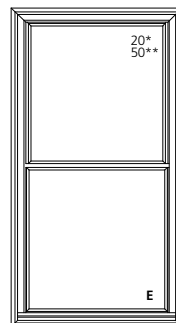

MDHB4077

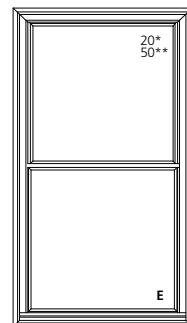

MDHB4277

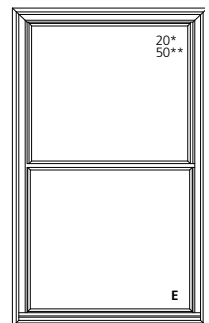

MDHB4677

ELEVATION SYMBOL LEGEND:

VALUES IN () ARE IN MILLIMETER CONVERSIONS
VALUES IN [] ARE NUMBER OF DAYLIGHT OPENINGS PER UNIT

NUMBER INDICATES DESIGN PRESSURE (DP) RATING WITH STANDARD GLAZING.

NUMBER INDICATES OPTIONAL DESIGN PRESSURE (DP) RATING.

E BASIC UNIT CLEAR OPENING EXCEEDS 20" IN WIDTH, 24" IN HEIGHT & A MINIMUM OF 5.7 SQ. FT.

Note: Elevations shown DO NOT have exterior trim. Subtract 1/2" (12.7) from M.O. (Masonry Opening) for Unit Sizes. Masonry Openings above include Sill Nose, see Trim Options page for Sill Nose specifications. For other Trim Options refer to the Unit Sizing, Rough Opening & Masonry Openings page.

SCALE: 1/4" = 1'

DOUBLE-HUNG

UNIT SIZE
ROUGH OPENING
FRAME SIZE
DAYLIGHT OPENING

50 3/4" (1289)
48" (1219)
47 1/2" (1207)
41" (1041) [2]
41 7/8" (1064) [2]

32 3/4" (832)
30" (762)
29 1/2" (749)
11 3/16" (284)
10 5/16" (262)

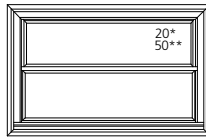

MDHB4830

38 3/4" (984)
36" (914)
35 1/2" (902)
14 3/16" (360)
13 5/16" (338)

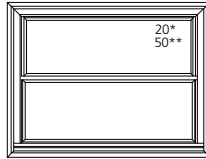

MDHB4836

39 3/4" (1010)
37" (940)
36 1/2" (927)
14 1/16" (373)
13 13/16 (351)

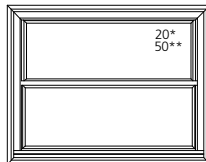

MDHB4837

40 3/4" (1035)
38" (965)
37 1/2" (953)
15 3/16" (386)
14 5/16" (364)

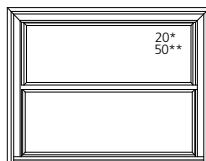

MDHB4838

43 3/4" (1111)
41" (1041)
40 1/2" (1029)
16 1/16" (424)
15 13/16" (402)

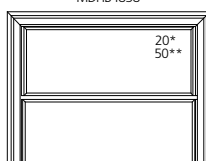

MDHB4841

44 3/4" (1137)
42" (1067)
41 1/2" (1054)
17 3/16" (437)
16 5/16" (414)

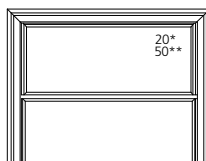

MDHB4842

50 3/4" (1289)
48" (1219)
47 1/2" (1207)
20 3/16" (513)
19 5/16" (491)

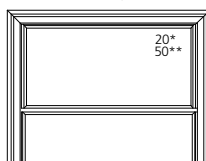

MDHB4848

51 3/4" (1314)
49" (1245)
48 1/2" (1232)
20 1/16" (525)
19 13/16 (503)

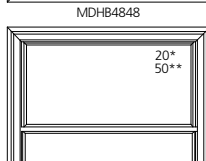

MDHB4849

UNIT SIZE
ROUGH OPENING
FRAME SIZE
DAYLIGHT OPENING

50 3/4" (1289)
48" (1219)
47 1/2" (1207)
41" (1041) [2]
41 7/8" (1064) [2]

55 3/4" (1416)
53" (1346)
52 1/2" (1334)
22 1/16" (576)
21 13/16 (554)

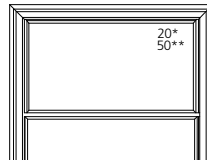

MDHB4853

56 3/4" (1441)
54" (1372)
53 1/2" (1359)
23 3/16" (589)
22 5/16 (578)

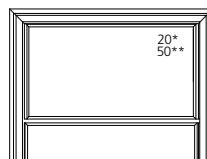

MDHB4854

59 3/4" (1518)
57" (1449)
56 1/2" (1435)
24 1/16" (627)
23 13/16 (605)

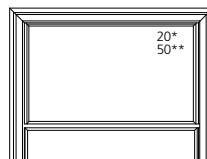

MDHB4857

62 3/4" (1594)
60" (1524)
59 1/2" (1511)
26 3/16" (665)
25 5/16 (643)

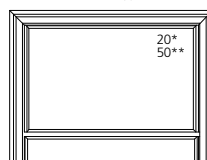

MDHB4860

64 3/4" (1645)
62" (1575)
61 1/2" (1562)
27 3/16" (691)
26 5/16 (668)

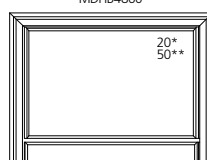

MDHB4862

67 3/4" (1721)
65" (1651)
64 1/2" (1638)
28 1/16" (729)
27 13/16 (706)

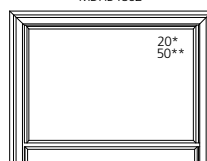

MDHB4865

UNIT SIZE
ROUGH OPENING
FRAME SIZE
DAYLIGHT OPENING

50 3/4" (1289)
48" (1219)
47 1/2" (1207)
41" (1041) [2]
41 7/8" (1064) [2]

68 3/4" (1746)
66" (1676)
65 1/2" (1664)
28 3/16" (741)
28 5/16 (719)

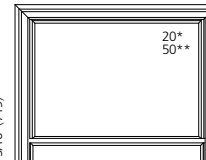

MDHB4866

71 3/4" (1822)
69" (1753)
68 1/2" (1740)
30 1/16" (779)
29 13/16 (757)

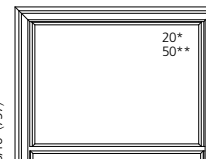

MDHB4869

74 3/4" (1899)
72" (1829)
71 1/2" (1861)
32 3/16" (818)
31 5/16 (795)

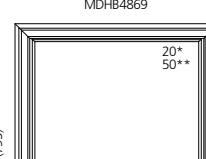

MDHB4872

76 3/4" (1949)
74" (1880)
73 1/2" (1867)
33 3/16" (843)
32 5/16 (821)

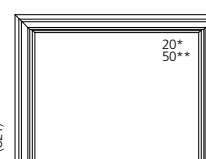

MDHB4874

79 3/4" (2026)
77" (1956)
76 1/2" (1943)
34 1/16" (881)
33 13/16 (859)

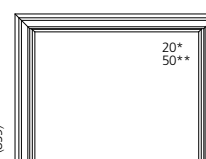

MDHB4877

ELEVATION SYMBOL LEGEND:

VALUES IN () ARE IN MILLIMETER CONVERSIONS
VALUES IN [] ARE NUMBER OF DAYLIGHT OPENINGS PER UNIT

##* NUMBER INDICATES DESIGN PRESSURE (DP) RATING WITH STANDARD GLAZING.

##** NUMBER INDICATES OPTIONAL DESIGN PRESSURE (DP) RATING.

E BASIC UNIT CLEAR OPENING EXCEEDS 20" IN WIDTH, 24" IN HEIGHT & A MINIMUM OF 5.7 SQ. FT.

2-WIDE DOUBLE-HUNG

UNIT SIZE
ROUGH OPENING
FRAME SIZE
DAYLIGHT OPENING











































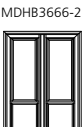









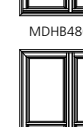
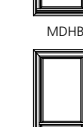









32 3/4" (832) 30" (762) 29 1/2" (749) 11 3/16" (284) 10 5/16" (262)	38 3/4" (984) 36" (914) 35 1/2" (902) 11" (279)[2] 11 7/8" (302)[2]	42 3/4" (1086) 40" (1016) 39 1/2" (1003) 13" (330)[2] 13 7/8" (352)[2]	46 3/4" (1187) 44" (1118) 43 1/2" (1105) 15" (381)[2] 15 7/8" (403)[2]	50 3/4" (1289) 48" (1219) 47 1/2" (1207) 17" (432)[2] 17 7/8" (454)[2]	54 3/4" (1391) 52" (1321) 51 1/2" (1308) 19" (483)[2] 19 7/8" (505)[2]	58 3/4" (1492) 56" (1422) 55 1/2" (1410) 21" (533)[2] 21 7/8" (556)[2]	62 3/4" (1594) 60" (1524) 59 1/2" (1511) 23" (584)[2] 23 7/8" (607)[2]	66 3/4" (1695) 64" (1626) 63 1/2" (1613) 25" (635)[2] 25 7/8" (657)[2]
	MDHB3630-2	MDHB4030-2	MDHB4430-2	MDHB4830-2	MDHB5230-2	MDHB5630-2	MDHB6030-2	MDHB6430-2
	MDHB3636-2	MDHB4036-2	MDHB4436-2	MDHB4836-2	MDHB5236-2	MDHB5636-2	MDHB6036-2	MDHB6436-2
	MDHB3637-2	MDHB4037-2	MDHB4437-2	MDHB4837-2	MDHB5237-2	MDHB5637-2	MDHB6037-2	MDHB6437-2
	MDHB3638-2	MDHB4038-2	MDHB4438-2	MDHB4838-2	MDHB5238-2	MDHB5638-2	MDHB6038-2	MDHB6438-2
	MDHB3641-2	MDHB4041-2	MDHB4441-2	MDHB4841-2	MDHB5241-2	MDHB5641-2	MDHB6041-2	MDHB6441-2
	MDHB3642-2	MDHB4042-2	MDHB4442-2	MDHB4842-2	MDHB5242-2	MDHB5642-2	MDHB6042-2	MDHB6442-2
	MDHB3648-2	MDHB4048-2	MDHB4448-2	MDHB4848-2	MDHB5248-2	MDHB5648-2	MDHB6048-2	MDHB6448-2
	MDHB3649-2	MDHB4049-2	MDHB4449-2	MDHB4849-2	MDHB5249-2	MDHB5649-2	MDHB6049-2	MDHB6449-2
	MDHB3653-2	MDHB4053-2	MDHB4453-2	MDHB4853-2	MDHB5253-2	MDHB5653-2	MDHB6053-2	MDHB6453-2
	MDHB3654-2	MDHB4054-2	MDHB4454-2	MDHB4854-2	MDHB5254-2	MDHB5654-2	MDHB6054-2	MDHB6454-2
	MDHB3657-2	MDHB4057-2	MDHB4457-2	MDHB4857-2	MDHB5257-2	MDHB5657-2	MDHB6057-2	MDHB6457-2

ELEVATION SYMBOL LEGEND:
VALUES IN () ARE IN MILLIMETER CONVERSIONS
VALUES IN [] ARE NUMBER OF DAYLIGHT OPENINGS PER UNIT

Note: Elevations shown DO NOT have exterior trim. Subtract 1/2" (12.7) from M.O. (Masonry Opening) for Unit Sizes. Masonry Openings above include Sill Nose, see Trim Options page for Sill Nose specifications. For other Trim Options refer to the Unit Sizing, Rough Opening & Masonry Openings page.

SCALE: 1/8" = 1'

2-WIDE DOUBLE-HUNG

UNIT SIZE	38 3/4"(984)	42 3/4"(1086)	46 3/4"(1187)	50 3/4"(1289)	54 3/4"(1391)	58 3/4"(1492)	62 3/4"(1594)	66 3/4"(1695)
ROUGH OPENING	36"(914)	40"(1016)	44"(1118)	48"(1219)	52"(1321)	56"(1422)	60"(1524)	64"(1626)
FRAME SIZE	35 1/2"(902)	39 1/2"(1003)	43 1/2"(1105)	47 1/2"(1207)	51 1/2"(1308)	55 1/2"(1410)	59 1/2"(1511)	63 1/2"(1613)
DAYLIGHT OPENING	11 7/8"(302)[2]	13 7/8"(352)[2]	15 7/8"(403)[2]	17 7/8"(454)[2]	19 7/8"(505)[2]	21 7/8"(556)[2]	23 7/8"(607)[2]	25 7/8"(657)[2]
62 3/4"(1594) 60"(1524) 59 1/2"(1511) 26 3/16"(665) 25 5/16"(643)	 MDHB3660-2	 MDHB4060-2	 MDHB4460-2	 MDHB4860-2	 MDHB5260-2	 MDHB5660-2	 MDHB6060-2	 MDHB6460-2
64 3/4"(1645) 62"(1575) 61 1/2"(1562) 27 3/16"(691) 26 5/16"(668)	 MDHB3662-2	 MDHB4062-2	 MDHB4462-2	 MDHB4862-2	 MDHB5262-2	 MDHB5662-2	 MDHB6062-2	 MDHB6462-2
67 3/4"(1721) 65"(1651) 64 1/2"(1638) 28 11/16"(729) 27 13/16"(706)	 MDHB3665-2	 MDHB4065-2	 MDHB4465-2	 MDHB4865-2	 MDHB5265-2	 MDHB5665-2	 MDHB6065-2	 MDHB6465-2
68 3/4"(1746) 66"(1676) 65 1/2"(1664) 29 3/16"(741) 28 5/16"(719)	 MDHB3666-2	 MDHB4066-2	 MDHB4466-2	 MDHB4866-2	 MDHB5266-2	 MDHB5666-2	 MDHB6066-2	 MDHB6466-2
71 3/4"(1822) 69"(1753) 68 1/2"(1740) 30 11/16"(779) 29 13/16"(757)	 MDHB3669-2	 MDHB4069-2	 MDHB4469-2	 MDHB4869-2	 MDHB5269-2	 MDHB5669-2	 MDHB6069-2	 MDHB6469-2
74 3/4"(1899) 72"(1829) 71 1/2"(1816) 32 3/16"(818) 31 5/16"(795)	 MDHB3672-2	 MDHB4072-2	 MDHB4472-2	 MDHB4872-2	 MDHB5272-2	 MDHB5672-2	 MDHB6072-2	 MDHB6472-2
76 3/4"(1949) 74"(1880) 73 1/2"(1867) 33 3/16"(843) 32 5/16"(821)	 MDHB3674-2	 MDHB4074-2	 MDHB4474-2	 MDHB4874-2	 MDHB5274-2	 MDHB5674-2	 MDHB6074-2	 MDHB6474-2
79 3/4"(2026) 77"(1956) 76 1/2"(1943) 34 11/16"(881) 33 13/16"(859)	 MDHB3677-2	 MDHB4077-2	 MDHB4477-2	 MDHB4877-2	 MDHB5277-2	 MDHB5677-2	 MDHB6077-2	 MDHB6477-2

ELEVATION SYMBOL LEGEND:

VALUES IN () ARE IN MILLIMETER CONVERSIONS
VALUES IN [] ARE NUMBER OF DAYLIGHT OPENINGS PER UNIT

E BASIC UNIT CLEAR OPENING EXCEEDS 20" IN WIDTH, 24" IN HEIGHT & A MINIMUM OF 5.7 SQ. FT.

Note: Elevations shown DO NOT have exterior trim. Subtract 1/2" (12.7) from M.O. (Masonry Opening) for Unit Sizes. Masonry Openings above include Sill Nose, see Trim Options page for Sill Nose specifications. For other Trim Options refer to the Unit Sizing, Rough Opening & Masonry Openings page.

SCALE: 1/8" = 1'

2-WIDE DOUBLE-HUNG

UNIT SIZE
ROUGH OPENING
FRAME SIZE
DAYLIGHT OPENING

	70 3/4" (1797) 68" (1727) 67 1/2" (1715) 27" (686)[2] 27 7/8" (708)[2]	74 3/4" (1899) 72" (1829) 71 1/2" (1861) 29" (737)[2] 29 7/8" (759)[2]	78 3/4" (2000) 76" (1930) 75 1/2" (1918) 31" (787)[2] 31 7/8" (810)[2]	82 3/4" (2102) 80" (2032) 79 1/2" (2019) 33" (838)[2] 33 7/8" (860)[2]	86 3/4" (2203) 84" (2134) 83 1/2" (2121) 35" (889)[2] 35 7/8" (911)[2]	92 3/4" (2356) 90" (2286) 89 1/2" (2273) 38" (965)[2] 38 7/8" (987)[2]
32 3/4" (832) 30" (762) 30 1/2" (769) 11 3/16" (284) 10 5/16" (262)						
38 3/4" (984) 36" (914) 35 1/2" (902) 14 3/16" (360) 13 5/16" (338)						
39 3/4" (1010) 37" (940) 36 1/2" (927) 14 11/16" (373) 13 13/16" (351)						
40 3/4" (1035) 38" (965) 37 1/2" (953) 15 3/16" (386) 14 5/16" (364)						
43 3/4" (1111) 41" (1041) 41 1/2" (1029) 16 11/16" (424) 15 13/16" (402)						
44 3/4" (1137) 42" (1067) 41 1/2" (1054) 17 3/16" (437) 16 5/16" (414)						
50 3/4" (1289) 48" (1219) 47 1/2" (1207) 20 3/16" (513) 19 5/16" (491)						
51 3/4" (1314) 49" (1245) 48 1/2" (1232) 20 11/16" (525) 19 13/16" (503)						
55 3/4" (1416) 53" (1346) 52 1/2" (1334) 22 11/16" (576) 21 13/16" (554)						
56 3/4" (1441) 54" (1371) 53 1/2" (1359) 23 3/16" (589) 22 5/16" (578)						
59 3/4" (1518) 57" (1448) 56 1/2" (1435) 24 11/16" (627) 23 13/16" (605)						

ELEVATION SYMBOL LEGEND:

VALUES IN () ARE IN MILLIMETER CONVERSIONS
VALUES IN [] ARE NUMBER OF DAYLIGHT OPENINGS PER UNIT

E BASIC UNIT CLEAR OPENING EXCEEDS 20" IN WIDTH, 24" IN HEIGHT & A MINIMUM OF 5.7 SQ. FT.

Note: Elevations shown DO NOT have exterior trim. Subtract 1/2" (12.7) from M.O. (Masonry Opening) for Unit Sizes. Masonry Openings above include Sill Nose, see Trim Options page for Sill Nose specifications. For other Trim Options refer to the Unit Sizing, Rough Opening & Masonry Openings page.

SCALE: 1/8" = 1'

2-WIDE DOUBLE-HUNG

UNIT SIZE
ROUGH OPENING
FRAME SIZE
DAYLIGHT OPENING

70 3/4" (1797)
68" (1727)
67 1/2" (1715)
27" (686)[2]
27 7/8" (708)[2]

74 3/4" (1899)
72" (1829)
71 1/2" (1861)
29" (737)[2]
29 7/8" (759)[2]

78 3/4" (2000)
76" (1930)
75 1/2" (1918)
31" (787)[2]
31 7/8" (810)[2]

82 3/4" (2102)
80" (2032)
79 1/2" (2019)
33" (838)[2]
33 7/8" (860)[2]

86 3/4" (2203)
84" (2134)
83 1/2" (2121)
35" (889)[2]
35 7/8" (911)[2]

92 3/4" (2356)
90" (2286)
89 1/2" (2273)
38" (965)[2]
38 7/8" (987)[2]

62 3/4" (1594)
60" (1524)
59 1/2" (1511)
26 3/16" (665)
25 5/16" (643)

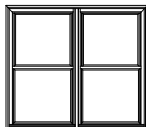

MDHB6860-2



MDHB7260-2



MDHB7660-2



MDHB8060-2



MDHB8460-2



MDHB9060-2

64 3/4" (1645)
62" (1575)
61 1/2" (1562)
27 3/16" (691)
26 5/16" (668)

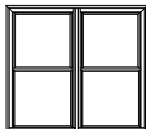

MDHB6862-2

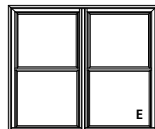

MDHB7262-2

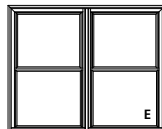

MDHB7662-2



MDHB8062-2



MDHB8462-2

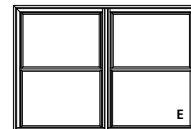

MDHB9062-2

67 3/4" (1721)
65" (1651)
64 1/2" (1638)
28 11/16" (729)
27 13/16" (706)

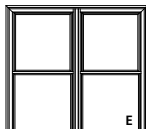

MDHB6865-2

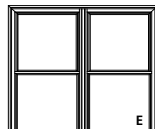

MDHB7265-2

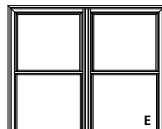

MDHB7665-2

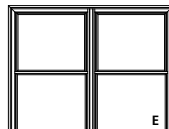

MDHB8065-2

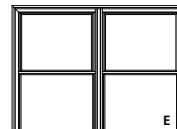

MDHB8465-2

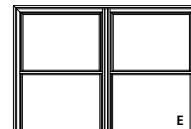

MDHB9065-2

68 3/4" (1746)
66" (1676)
65 1/2" (1664)
29 3/16" (741)
28 5/16" (719)

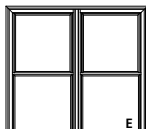

MDHB6866-2

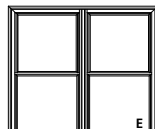

MDHB7266-2

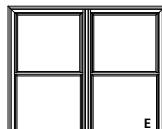

MDHB7666-2

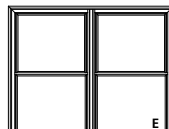

MDHB8066-2

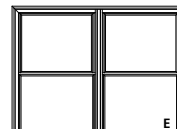

MDHB8466-2

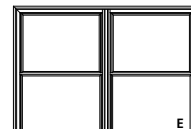

MDHB9066-2

71 3/4" (1822)
69" (1753)
68 1/2" (1740)
30 11/16" (779)
29 13/16" (757)



MDHB6869-2

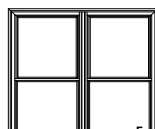

MDHB7269-2



MDHB7669-2

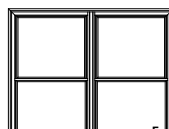

MDHB8069-2

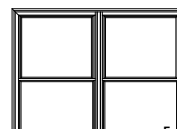

MDHB8469-2

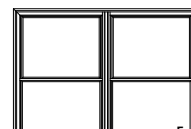

MDHB9069-2

74 3/4" (1899)
72" (1829)
71 1/2" (1861)
32 3/16" (818)
31 5/16" (795)



MDHB6872-2



MDHB7272-2

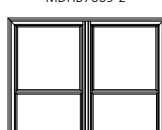

MDHB7672-2



MDHB8072-2

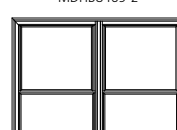

MDHB8472-2

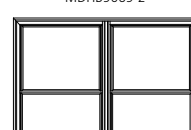

MDHB9072-2

76 3/4" (1949)
74" (1880)
73 1/2" (1867)
33 3/16" (843)
32 5/16" (821)

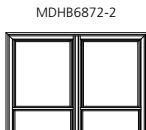

MDHB6874-2

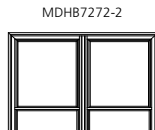

MDHB7274-2

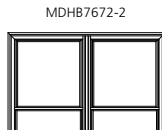

MDHB7674-2

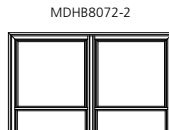

MDHB8074-2

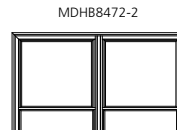

MDHB8474-2

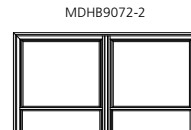

MDHB9074-2

79 3/4" (2026)
77" (1956)
76 1/2" (1943)
34 11/16" (881)
33 13/16" (859)



MDHB6877-2



MDHB7277-2



MDHB7677-2

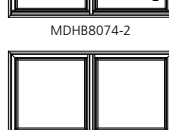

MDHB8077-2

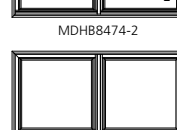

MDHB8477-2

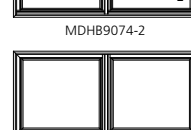

MDHB9077-2

ELEVATION SYMBOL LEGEND:

VALUES IN () ARE IN MILLIMETER CONVERSIONS
VALUES IN [] ARE NUMBER OF DAYLIGHT OPENINGS PER UNIT

E BASIC UNIT CLEAR OPENING EXCEEDS 20" IN WIDTH, 24" IN HEIGHT & A MINIMUM OF 5.7 SQ. FT.

Note: Elevations shown DO NOT have exterior trim. Subtract 1/2" (12.7) from M.O. (Masonry Opening) for Unit Sizes. Masonry Openings above include Sill Nose, see Trim Options page for Sill Nose specifications. For other Trim Options refer to the Unit Sizing, Rough Opening & Masonry Openings page.

SCALE: 1/8" = 1'

2-WIDE DOUBLE-HUNG

UNIT SIZE
ROUGH OPENING
FRAME SIZE
DAYLIGHT OPENING

98 3/4" (2508)
96" (2438)
95 1/2" (2426)
41" (1041)[2]
41 7/8" (1064)[2]

32 3/4" (832) 30" (762) 29 1/2" (749) 11 3/16" (284) 10 5/16" (262)		MDHB9630-2
38 3/4" (984) 36" (914) 35 1/2" (902) 14 3/16" (360) 13 5/16" (338)		MDHB9636-2
39 3/4" (1010) 37" (940) 36 1/2" (927) 14 11/16" (373) 13 13/16" (351)		MDHB9637-2
40 3/4" (1035) 38" (965) 37 1/2" (953) 15 3/16" (386) 14 5/16" (364)		MDHB9638-2
43 3/4" (1111) 41" (1041) 40 1/2" (1029) 16 11/16" (424) 15 13/16" (402)		MDHB9641-2
44 3/4" (1137) 42" (1067) 41 1/2" (1054) 17 3/16" (437) 16 5/16" (414)		MDHB9642-2
50 3/4" (1289) 48" (1219) 47 1/2" (1207) 20 3/16" (513) 19 5/16" (491)		MDHB9648-2
51 3/4" (1314) 49" (1245) 48 1/2" (1232) 20 11/16" (525) 19 13/16" (503)		MDHB9649-2
55 3/4" (1416) 53" (1346) 52 1/2" (1334) 22 11/16" (576) 21 13/16" (554)		MDHB9653-2
56 3/4" (1441) 54" (1372) 53 1/2" (1359) 23 3/16" (589) 22 5/16" (578)		MDHB9654-2
59 3/4" (1518) 57" (1443) 56 1/2" (1435) 24 11/16" (627) 23 13/16" (605)		MDHB9657-2

UNIT SIZE
ROUGH OPENING
FRAME SIZE
DAYLIGHT OPENING

98 3/4" (2508)
96" (2438)
95 1/2" (2426)
41" (1041)[2]
41 7/8" (1064)[2]

62 3/4" (1594) 60" (1524) 59 1/2" (1511) 26 3/16" (665) 25 5/16" (643)		MDHB9660-2
64 3/4" (1645) 62" (1575) 61 1/2" (1562) 27 3/16" (691) 26 5/16" (668)		MDHB9662-2
67 3/4" (1721) 65" (1651) 64 1/2" (1638) 28 11/16" (729) 27 13/16" (706)		MDHB9665-2
68 3/4" (1746) 66" (1676) 65 1/2" (1664) 29 3/16" (741) 28 5/16" (719)		MDHB9666-2
71 3/4" (1822) 69" (1753) 68 1/2" (1740) 30 11/16" (779) 29 13/16" (757)		MDHB9669-2
74 3/4" (1899) 72" (1829) 71 1/2" (1816) 32 3/16" (818) 31 5/16" (795)		MDHB9672-2
76 3/4" (1949) 74" (1880) 73 1/2" (1867) 33 3/16" (843) 32 5/16" (821)		MDHB9674-2
79 3/4" (2026) 77" (1956) 76 1/2" (1943) 34 11/16" (881) 33 13/16" (859)		MDHB9677-2

ELEVATION SYMBOL LEGEND:
VALUES IN () ARE IN MILLIMETER CONVERSIONS
VALUES IN [] ARE NUMBER OF DAYLIGHT OPENINGS PER UNIT

E BASIC UNIT CLEAR OPENING EXCEEDS 20" IN WIDTH, 24" IN HEIGHT & A MINIMUM OF 5.7 SQ. FT.

Note: Elevations shown DO NOT have exterior trim. Subtract 1/2" (12.7) from M.O. (Masonry Opening) for Unit Sizes. Masonry Openings above include Sill Nose, see Trim Options page for Sill Nose specifications. For other Trim Options refer to the Unit Sizing, Rough Opening & Masonry Openings page.

SCALE: 1/8" = 1'

3-WIDE DOUBLE-HUNG WITH CENTER PICTURE
WITH 24" FLANKER

UNIT SIZE ROUGH OPENING FRAME SIZE DAYLIGHT OPENING	86 3/4" (2203) 84" (2134) 83 1/2" (2121) 17" (432)[2] 17 7/8" (454)[2] 29 7/8" (759)	98 3/4" (2508) 96" (2438) 95 1/2" (2426) 17" (432)[2] 17 7/8" (454)[2] 41 7/8" (1064)	110 3/4" (2813) 108" (2743) 107 1/2" (2731) 17" (432)[2] 17 7/8" (454)[2] 53 7/8" (1368)
32 3/4" (832) 30" (762) 29 1/2" (749) 11 3/16" (284) 10 5/16" (262)			
38 3/4" (984) 36" (914) 35 1/2" (902) 14 3/16" (360) 13 5/16" (338)			
44 3/4" (1137) 42" (1067) 41 1/2" (1054) 17 3/16" (437) 16 5/16" (414)			
50 3/4" (1289) 48" (1219) 47 1/2" (1207) 20 3/16" (513) 19 5/16" (491)			
56 3/4" (1441) 54" (1372) 53 1/2" (1359) 23 3/16" (589) 22 5/16" (578)			
62 3/4" (1594) 60" (1524) 59 1/2" (1511) 26 3/16" (665) 25 5/16" (643)			
68 3/4" (1746) 66" (1676) 65 1/2" (1664) 29 3/16" (741) 28 5/16" (719)			
74 3/4" (1899) 72" (1829) 71 1/2" (1816) 32 3/16" (818) 31 5/16" (795)			

ELEVATION SYMBOL LEGEND:
VALUES IN () ARE IN MILLIMETER CONVERSIONS
VALUES IN [] ARE NUMBER OF DAYLIGHT OPENINGS PER UNIT

Note: Elevations shown DO NOT have exterior trim. Subtract 1/2" (12.7) from M.O. (Masonry Opening) for Unit Sizes. Masonry Openings above include Sill Nose, see Trim Options page for Sill Nose specifications. For other Trim Options refer to the Unit Sizing, Rough Opening & Masonry Openings page.

SCALE: 1/8" = 1'

3-WIDE DOUBLE-HUNG WITH CENTER PICTURE WITH 30" FLANKER

UNIT SIZE ROUGH OPENING FRAME SIZE DAYLIGHT OPENING	98 3/4" (2508) 96" (2438) 95 1/2" (2426) 23" (584) [2] 23 7/8" (607) [2] 29 7/8" (759)	110 3/4" (2813) 108" (2743) 107 1/2" (2731) 23" (584) [2] 23 7/8" (607) [2] 41 7/8" (1064)	122 3/4" (3118) 120" (3048) 119 1/2" (3035) 23" (584) [2] 23 7/8" (607) [2] 53 7/8" (1368)
32 3/4" (832) 30" (762) 29 1/2" (749) 11 3/16" (284) 10 5/16" (262)			
38 3/4" (984) 36" (914) 35 1/2" (902) 14 3/16" (360) 13 5/16" (338)			
44 3/4" (1137) 42" (1067) 41 1/2" (1054) 17 3/16" (437) 16 5/16" (414)			
50 3/4" (1289) 48" (1219) 47 1/2" (1207) 20 3/16" (513) 19 5/16" (491)			
56 3/4" (1441) 54" (1372) 53 1/2" (1359) 23 3/16" (589) 22 5/16" (578)			
62 3/4" (1594) 60" (1524) 59 1/2" (1511) 26 3/16" (665) 25 5/16" (643)			
68 3/4" (1746) 66" (1676) 65 1/2" (1664) 29 3/16" (741) 28 5/16" (719)			
74 3/4" (1899) 72" (1829) 71 1/2" (1816) 32 3/16" (818) 31 5/16" (795)			

ELEVATION SYMBOL LEGEND:
VALUES IN () ARE IN MILLIMETER CONVERSIONS
VALUES IN [] ARE NUMBER OF DAYLIGHT OPENINGS PER UNIT

Note: Elevations shown DO NOT have exterior trim. Subtract 1/2" (12.7) from M.O. (Masonry Opening) for Unit Sizes. Masonry Openings above include Sill Nose, see Trim Options page for Sill Nose specifications. For other Trim Options refer to the Unit Sizing, Rough Opening & Masonry Openings page.

SCALE: 1/8" = 1'

3-WIDE DOUBLE-HUNG WITH CENTER PICTURE
WITH 36" FLANKER

UNIT SIZE ROUGH OPENING FRAME SIZE DAYLIGHT OPENING	110 3/4"(2813) 108"(2743) 107 1/2"(2731) 29"(737)[2] 29 7/8"(759)[2] 29 7/8"(759)	122 3/4"(3118) 120"(3048) 119 1/2"(3035) 29"(737)[2] 29 7/8"(759)[2] 41 7/8"(1064)
32 3/4"(832) 30"(762) 29 1/2"(749) 11 3/16"(284) 10 5/16"(262)		
38 3/4"(984) 36"(914) 35 1/2"(902) 14 3/16"(360) 13 5/16"(338)		
44 3/4"(1137) 42"(1067) 41 1/2"(1054) 17 3/16"(437) 16 5/16"(414)		
50 3/4"(1289) 48"(1219) 47 1/2"(1207) 20 3/16"(513) 19 5/16"(491)		
56 3/4"(1441) 54"(1372) 53 1/2"(1359) 23 3/16"(589) 22 5/16"(578)		
62 3/4"(1594) 60"(1524) 59 1/2"(1511) 26 3/16"(665) 25 5/16"(643)		
68 3/4"(1746) 66"(1676) 65 1/2"(1664) 29 3/16"(741) 28 5/16"(719)		
74 3/4"(1899) 72"(1829) 71 1/2"(1861) 32 3/16"(818) 31 5/16"(795)		

ELEVATION SYMBOL LEGEND:

VALUES IN () ARE IN MILLIMETER CONVERSIONS
VALUES IN [] ARE NUMBER OF DAYLIGHT OPENINGS PER UNIT

E BASIC UNIT CLEAR OPENING EXCEEDS 20" IN WIDTH, 24" IN HEIGHT & A MINIMUM OF 5.7 SQ. FT.

Note: Elevations shown DO NOT have exterior trim. Subtract 1/2" (12.7) from M.O. (Masonry Opening) for Unit Sizes. Masonry Openings above include Sill Nose, see Trim Options page for Sill Nose specifications. For other Trim Options refer to the Unit Sizing, Rough Opening & Masonry Openings page.

SCALE: 1/8" = 1'

DOUBLE-HUNG WITH HALF ROUND

UNIT SIZE
ROUGH OPENING
FRAME SIZE
DAYLIGHT OPENING

32 3/4" (832)
30" (762)
29 1/2" (749)
23" (584) [2]
23 7/8" (607) [2]
25 1/8" (638)

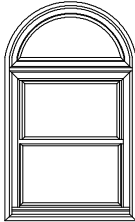

MDHB3036-R

54 3/4" (1391)
52" (1321)
51 1/2" (1308)
44 3/16" (1130)
43 5/16" (1113)
10 1/8" (257)

55 3/4" (1416)
53" (1346)
52 1/2" (1334)
46 1/16" (1170)
45 1/16" (1153)
10 1/8" (257)

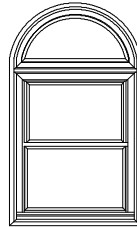

MDHB3037-R

32 3/4" (832)
30" (762)
29 1/2" (749)
23" (584) [2]
23 7/8" (607) [2]
25 1/8" (638)

56 3/4" (1441)
54" (1372)
53 1/2" (1359)
45 3/16" (1156)
44 5/16" (1139)
10 1/8" (257)

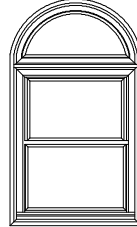

MDHB3038-R

32 3/4" (832)
30" (762)
29 1/2" (749)
23" (584) [2]
23 7/8" (607) [2]
25 1/8" (638)

58 3/4" (1492)
56" (1422)
55 1/2" (1410)
46 11/16" (1182)
45 13/16" (1165)
10 1/8" (257)

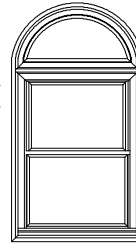

MDHB3041-R

32 3/4" (832)
30" (762)
29 1/2" (749)
23" (584) [2]
23 7/8" (607) [2]
25 1/8" (638)

60 3/4" (1543)
58" (1473)
57 1/2" (1460)
47 3/16" (1207)
46 5/16" (1190)
10 1/8" (257)

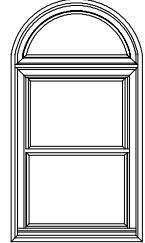

MDHB3042-R

32 3/4" (832)
30" (762)
29 1/2" (749)
23" (584) [2]
23 7/8" (607) [2]
25 1/8" (638)

UNIT SIZE
ROUGH OPENING
FRAME SIZE
DAYLIGHT OPENING

32 3/4" (832)
30" (762)
29 1/2" (749)
23" (584) [2]
23 7/8" (607) [2]
25 1/8" (638)

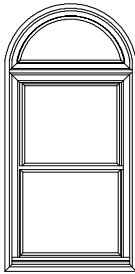

MDHB3048-R

66 3/4" (1695)
64" (1626)
63 1/2" (1613)
50 3/16" (1271)
49 5/16" (1254)
10 1/8" (257)

67 3/4" (1721)
65" (1651)
64 1/2" (1638)
51 1/16" (1297)
50 1/16" (1280)
10 1/8" (257)

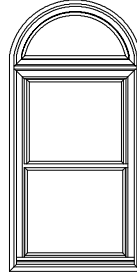

MDHB3049-R

32 3/4" (832)
30" (762)
29 1/2" (749)
23" (584) [2]
23 7/8" (607) [2]
25 1/8" (638)

71 3/4" (1822)
69" (1753)
68 1/2" (1740)
52 11/16" (1334)
51 13/16" (1317)
10 1/8" (257)

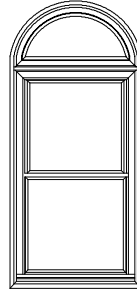

MDHB3053-R

32 3/4" (832)
30" (762)
29 1/2" (749)
23" (584) [2]
23 7/8" (607) [2]
25 1/8" (638)

72 3/4" (1848)
70" (1779)
69 1/2" (1765)
53 3/16" (1350)
52 5/16" (1333)
10 1/8" (257)

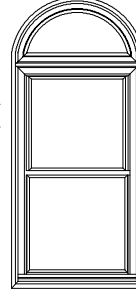

MDHB3054-R

32 3/4" (832)
30" (762)
29 1/2" (749)
23" (584) [2]
23 7/8" (607) [2]
25 1/8" (638)

75 3/4" (1924)
73" (1854)
72 1/2" (1842)
54 11/16" (1387)
53 9/16" (1370)
10 1/8" (257)

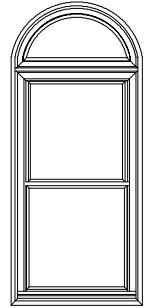

MDHB3057-R

32 3/4" (832)
30" (762)
29 1/2" (749)
23" (584) [2]
23 7/8" (607) [2]
25 1/8" (638)

UNIT SIZE
ROUGH OPENING
FRAME SIZE
DAYLIGHT OPENING

32 3/4" (832)
30" (762)
29 1/2" (749)
23" (584) [2]
23 7/8" (607) [2]
25 1/8" (638)

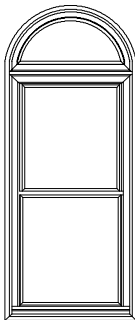

MDHB3060-R

79 3/4" (2000)
76" (1930)
75 1/2" (1918)
56 3/16" (1429)
55 1/16" (1412)
10 1/8" (257)

80 3/4" (2051)
78" (1981)
77 1/2" (1969)
57 1/16" (1446)
56 1/16" (1429)
10 1/8" (257)

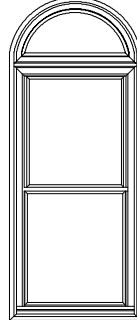

MDHB3062-R

32 3/4" (832)
30" (762)
29 1/2" (749)
23" (584) [2]
23 7/8" (607) [2]
25 1/8" (638)

83 3/4" (2127)
81" (2057)
80 1/2" (2045)
58 11/16" (1470)
57 9/16" (1453)
10 1/8" (257)

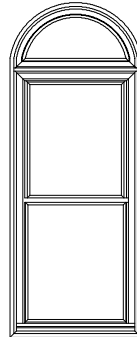

MDHB3065-R

32 3/4" (832)
30" (762)
29 1/2" (749)
23" (584) [2]
23 7/8" (607) [2]
25 1/8" (638)

84 3/4" (2153)
82" (2083)
81 1/2" (2070)
59 3/16" (1495)
58 5/16" (1478)
10 1/8" (257)

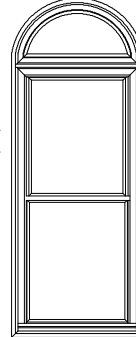

MDHB3066-R

32 3/4" (832)
30" (762)
29 1/2" (749)
23" (584) [2]
23 7/8" (607) [2]
25 1/8" (638)

87 3/4" (2229)
85" (2159)
84 1/2" (2146)
60 11/16" (1521)
59 9/16" (1504)
10 1/8" (257)

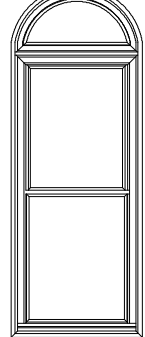

MDHB3069-R

32 3/4" (832)
30" (762)
29 1/2" (749)
23" (584) [2]
23 7/8" (607) [2]
25 1/8" (638)

ELEVATION SYMBOL LEGEND:
VALUES IN () ARE IN MILLIMETER CONVERSIONS
VALUES IN [] ARE NUMBER OF DAYLIGHT OPENINGS PER UNIT

Note: Elevations shown DO NOT have exterior trim. Subtract 1/2" (12.7) from M.O. (Masonry Opening) for Unit Sizes. Masonry Openings above include Sill Nose, see Trim Options page for Sill Nose specifications. For other Trim Options refer to the Unit Sizing, Rough Opening & Masonry Openings page.

SCALE: 1/4" = 1'

DOUBLE-HUNG WITH HALF ROUND

UNIT SIZE
ROUGH OPENING
FRAME SIZE
DAYLIGHT OPENING

32 3/4" (832)
30" (762)
29 1/2" (749)
23" (584)[2]
23 7/8" (607)[2]
25 1/8" (638)

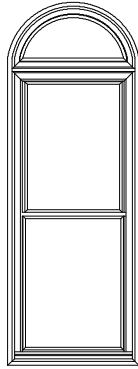

90 3/4" (2305)
88" (2235)
87 1/2" (2223)
32 3/16" (818)
31 5/16" (795)
10 1/8" (257)

MDHB3072-R

32 3/4" (832)
30" (762)
29 1/2" (749)
23" (584)[2]
23 7/8" (607)[2]
25 1/8" (638)

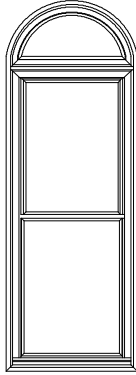

92 3/4" (2356)
90" (2286)
89 1/2" (2273)
33 3/16" (843)
32 5/16" (821)
10 1/8" (257)

MDHB3074-R

32 3/4" (832)
30" (762)
29 1/2" (749)
23" (584)[2]
23 7/8" (607)[2]
25 1/8" (638)

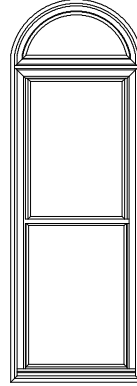

95 3/4" (2432)
92 1/2" (2350)
34 11/16" (881)
33 13/16" (859)
10 1/8" (257)

MDHB3077-R

UNIT SIZE
ROUGH OPENING
FRAME SIZE
DAYLIGHT OPENING

34 3/4" (883)
32" (813)
31 1/2" (800)
25" (635)[2]
25 7/8" (657)[2]
27 1/8" (689)

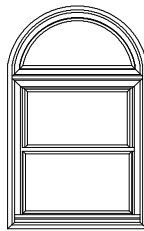

55 3/4" (1416)
53" (1346)
52 1/2" (1334)
14 3/16" (360)
13 5/16" (338)
11 1/8" (283)

MDHB3236-R

34 3/4" (883)
32" (813)
31 1/2" (800)
25" (635)[2]
25 7/8" (657)[2]
27 1/8" (689)

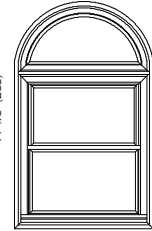

56 3/4" (1441)
54" (1372)
53 1/2" (1359)
14 1/16" (357)
13 11/16" (351)
11 1/8" (283)

MDHB3237-R

34 3/4" (883)
32" (813)
31 1/2" (800)
25" (635)[2]
25 7/8" (657)[2]
27 1/8" (689)

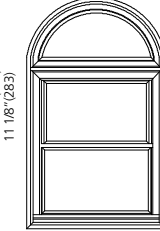

57 3/4" (1467)
55" (1397)
54 1/2" (1384)
15 3/16" (386)
14 5/16" (364)
11 1/8" (283)

MDHB3238-R

34 3/4" (883)
32" (813)
31 1/2" (800)
25" (635)[2]
25 7/8" (657)[2]
27 1/8" (689)

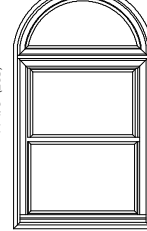

59 3/4" (1518)
57" (1449)
56 1/2" (1435)
16 11/16" (424)
15 13/16" (402)
11 1/8" (283)

MDHB3241-R

UNIT SIZE
ROUGH OPENING
FRAME SIZE
DAYLIGHT OPENING

34 3/4" (883)
32" (813)
31 1/2" (800)
25" (635)[2]
25 7/8" (657)[2]
27 1/8" (689)

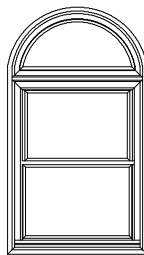

61 3/4" (1568)
59" (1499)
58 1/2" (1486)
17 3/16" (437)
16 5/16" (414)
11 1/8" (283)

MDHB3242-R

34 3/4" (883)
32" (813)
31 1/2" (800)
25" (635)[2]
25 7/8" (657)[2]
27 1/8" (689)

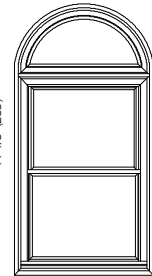

65 3/4" (1670)
63" (1600)
62 1/2" (1588)
18 3/16" (461)
17 5/16" (441)
11 1/8" (283)

MDHB3248-R

34 3/4" (883)
32" (813)
31 1/2" (800)
25" (635)[2]
25 7/8" (657)[2]
27 1/8" (689)

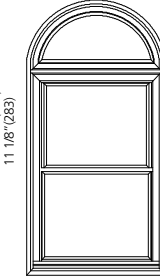

66 3/4" (1695)
64" (1626)
63 1/2" (1613)
20 11/16" (525)
19 13/16" (503)
11 1/8" (283)

MDHB3249-R

34 3/4" (883)
32" (813)
31 1/2" (800)
25" (635)[2]
25 7/8" (657)[2]
27 1/8" (689)

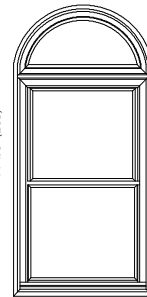

70 3/4" (1797)
68" (1727)
67 1/2" (1715)
22 11/16" (576)
21 13/16" (554)
11 1/8" (283)

MDHB3253-R

ELEVATION SYMBOL LEGEND:

VALUES IN () ARE IN MILLIMETER CONVERSIONS
VALUES IN [] ARE NUMBER OF DAYLIGHT OPENINGS PER UNIT

E BASIC UNIT CLEAR OPENING EXCEEDS 20" IN WIDTH, 24" IN HEIGHT & A MINIMUM OF 5.7 SQ. FT.

Note: Elevations shown DO NOT have exterior trim. Subtract 1/2" (12.7) from M.O. (Masonry Opening) for Unit Sizes. Masonry Openings above include Sill Nose, see Trim Options page for Sill Nose specifications. For other Trim Options refer to the Unit Sizing, Rough Opening & Masonry Openings page.

SCALE: 1/4" = 1'

DOUBLE-HUNG WITH HALF ROUND

UNIT SIZE
ROUGH OPENING
FRAME SIZE
DAYLIGHT OPENING

34 3/4" (883)
32" (813)
31 1/2" (800)
25" (635)[2]
25 7/8" (657)[2]
27 1/8" (689)

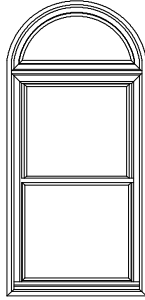

71 3/4" (1822)
69" (1753)
68 1/2" (1740)
23 3/16" (598)
22 5/16" (578)
11 1/8" (283)

MDHB3254-R

34 3/4" (883)
32" (813)
31 1/2" (800)
25" (635)[2]
25 7/8" (657)[2]
27 1/8" (689)

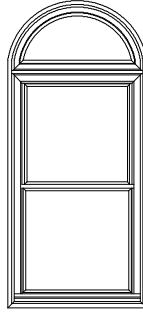

74 3/4" (1899)
72 1/2" (1859)
71 1/2" (1846)
24 1/16" (627)
23 13/16" (605)
11 1/8" (283)

MDHB3257-R

34 3/4" (883)
32" (813)
31 1/2" (800)
25" (635)[2]
25 7/8" (657)[2]
27 1/8" (689)

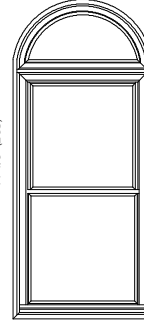

77 3/4" (1975)
75" (1905)
74 1/2" (1892)
26 3/16" (665)
25 5/16" (643)
11 1/8" (283)

MDHB3260-R

34 3/4" (883)
32" (813)
31 1/2" (800)
25" (635)[2]
25 7/8" (657)[2]
27 1/8" (689)

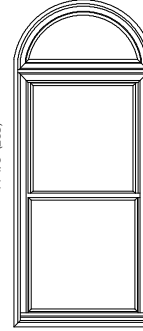

79 3/4" (2026)
77" (1956)
76 1/2" (1943)
27 3/16" (691)
26 5/16" (668)
11 1/8" (283)

MDHB3262-R

UNIT SIZE
ROUGH OPENING
FRAME SIZE
DAYLIGHT OPENING

34 3/4" (883)
32" (813)
31 1/2" (800)
25" (635)[2]
25 7/8" (657)[2]
27 1/8" (689)

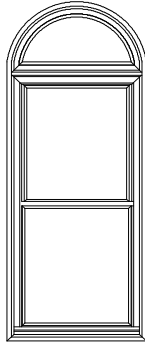

83 3/4" (2127)
81" (2057)
80 1/2" (2045)
28 1/16" (729)
27 13/16" (706)
11 1/8" (283)

MDHB3265-R

34 3/4" (883)
32" (813)
31 1/2" (800)
25" (635)[2]
25 7/8" (657)[2]
27 1/8" (689)

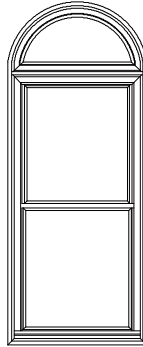

84 3/4" (2153)
82 1/2" (2083)
81 1/2" (2070)
29 3/16" (741)
28 5/16" (719)
11 1/8" (283)

MDHB3266-R

34 3/4" (883)
32" (813)
31 1/2" (800)
25" (635)[2]
25 7/8" (657)[2]
27 1/8" (689)

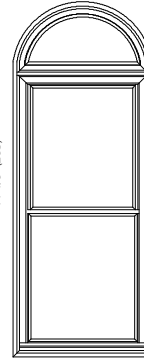

88 3/4" (2254)
86" (2184)
85 1/2" (2172)
30 11/16" (779)
29 13/16" (757)
11 1/8" (283)

MDHB3269-R

34 3/4" (883)
32" (813)
31 1/2" (800)
25" (635)[2]
25 7/8" (657)[2]
27 1/8" (689)

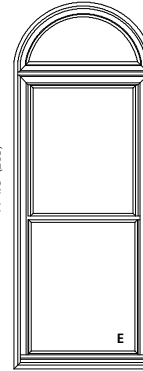

91 3/4" (2330)
89" (2261)
88 1/2" (2248)
32 3/16" (818)
31 5/16" (795)
11 1/8" (283)

MDHB3272-R

UNIT SIZE
ROUGH OPENING
FRAME SIZE
DAYLIGHT OPENING

34 3/4" (883)
32" (813)
31 1/2" (800)
25" (635)[2]
25 7/8" (657)[2]
27 1/8" (689)

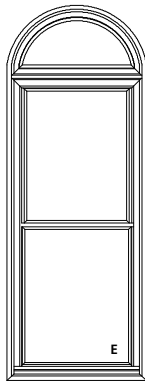

93 3/4" (2381)
91" (2311)
90 1/2" (2299)
33 3/16" (843)
32 5/16" (821)
11 1/8" (283)

MDHB3274-R

34 3/4" (883)
32" (813)
31 1/2" (800)
25" (635)[2]
25 7/8" (657)[2]
27 1/8" (689)

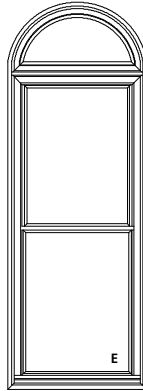

96 3/4" (2457)
94 1/2" (2387)
93 1/2" (2375)
34 1/16" (859)
33 13/16" (859)
11 1/8" (283)

MDHB3277-R

ELEVATION SYMBOL LEGEND:

VALUES IN () ARE IN MILLIMETER CONVERSIONS
VALUES IN [] ARE NUMBER OF DAYLIGHT OPENINGS PER UNIT

E BASIC UNIT CLEAR OPENING EXCEEDS 20" IN WIDTH, 24" IN HEIGHT & A MINIMUM OF 5.7 SQ. FT.

Note: Elevations shown DO NOT have exterior trim. Subtract 1/2" (12.7) from M.O. (Masonry Opening) for Unit Sizes. Masonry Openings above include Sill Nose, see Trim Options page for Sill Nose specifications. For other Trim Options refer to the Unit Sizing, Rough Opening & Masonry Openings page.

SCALE: 1/4" = 1'

DOUBLE-HUNG WITH HALF ROUND

UNIT SIZE
ROUGH OPENING
FRAME SIZE
DAYLIGHT OPENING

36 3/4" (933)
34" (864)
33 1/2" (851)
27" (686)[2]
27 7/8" (708)[2]
29 1/8" (740)

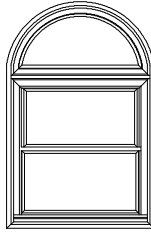

MDHB3436-R

56 3/4" (1441)
54" (1372)
53 1/2" (1359)
14 3/16" (360)
13 5/16" (338)
12 1/8" (308)

57 3/4" (1467)
55" (1397)
54 1/2" (1384)
14 11/16" (373)
13 13/16" (352)
12 1/8" (308)

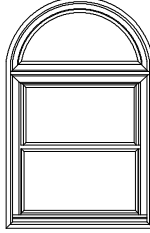

MDHB3437-R

58 3/4" (1492)
56" (1422)
55 1/2" (1410)
15 3/16" (386)
14 5/16" (364)
12 1/8" (308)

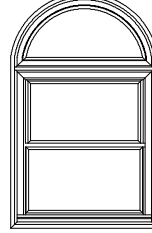

MDHB3438-R

60 3/4" (1543)
58" (1473)
57 1/2" (1460)
16 11/16" (424)
15 13/16" (402)
12 1/8" (308)



MDHB3441-R

UNIT SIZE
ROUGH OPENING
FRAME SIZE
DAYLIGHT OPENING

36 3/4" (933)
34" (864)
33 1/2" (851)
27" (686)[2]
27 7/8" (708)[2]
29 1/8" (740)

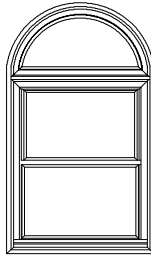

MDHB3442-R

62 3/4" (1594)
60" (1524)
59 1/2" (1511)
17 3/16" (437)
16 5/16" (414)
12 1/8" (308)

68 3/4" (1746)
66" (1676)
65 1/2" (1664)
20 3/16" (513)
19 5/16" (491)
12 1/8" (308)

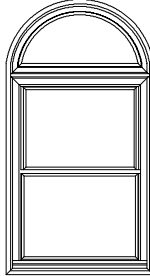

MDHB3448-R

69 3/4" (1772)
67" (1702)
66 1/2" (1689)
20 11/16" (525)
19 13/16" (503)
12 1/8" (308)

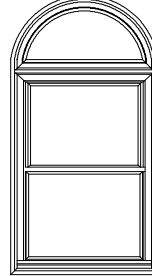

MDHB3449-R

73 3/4" (1873)
71" (1803)
70 1/2" (1791)
22 11/16" (576)
21 13/16" (554)
12 1/8" (308)

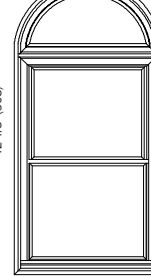

MDHB3453-R

UNIT SIZE
ROUGH OPENING
FRAME SIZE
DAYLIGHT OPENING

36 3/4" (933)
34" (864)
33 1/2" (851)
27" (686)[2]
27 7/8" (708)[2]
29 1/8" (740)

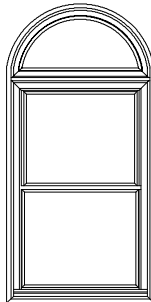

MDHB3454-R

74 3/4" (1899)
72" (1829)
71 1/2" (1861)
23 3/16" (589)
22 5/16" (578)
12 1/8" (308)

77 3/4" (1975)
75" (1905)
74 1/2" (1892)
24 11/16" (627)
23 13/16" (605)
12 1/8" (308)

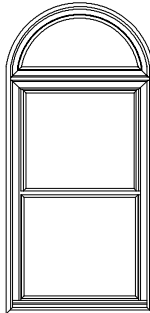

MDHB3457-R

80 3/4" (2051)
78" (1981)
77 1/2" (1969)
26 3/16" (665)
25 5/16" (643)
12 1/8" (308)

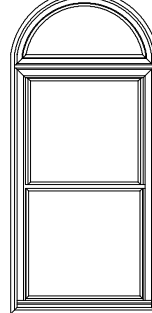

MDHB3460-R

82 3/4" (2102)
80" (2032)
79 1/2" (2019)
27 3/16" (691)
26 5/16" (668)
12 1/8" (308)

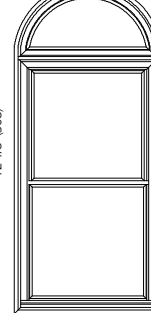

MDHB3462-R

ELEVATION SYMBOL LEGEND:

VALUES IN () ARE IN MILLIMETER CONVERSIONS
VALUES IN [] ARE NUMBER OF DAYLIGHT OPENINGS PER UNIT

E BASIC UNIT CLEAR OPENING EXCEEDS 20" IN WIDTH, 24" IN HEIGHT & A MINIMUM OF 5.7 SQ. FT.

Note: Elevations shown DO NOT have exterior trim. Subtract 1/2" (12.7) from M.O. (Masonry Opening) for Unit Sizes. Masonry Openings above include Sill Nose, see Trim Options page for Sill Nose specifications. For other Trim Options refer to the Unit Sizing, Rough Opening & Masonry Openings page.

SCALE: 1/4" = 1'

DOUBLE-HUNG WITH HALF ROUND

UNIT SIZE 36 3/4" (933)
ROUGH OPENING 34" (864)
FRAME SIZE 33 1/2" (851)
DAYLIGHT OPENING 27" (686)[2]
27 7/8" (708)[2]
29 1/8" (740)

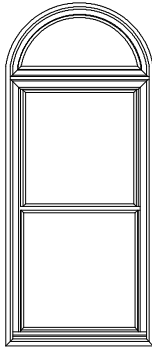

MDHB3465-R

85 3/4" (2178)
83" (2108)
82 1/2" (2063)
28 11/16" (729)
27 13/16" (706)
12 1/8" (308)

UNIT SIZE 36 3/4" (933)
ROUGH OPENING 34" (864)
FRAME SIZE 33 1/2" (851)
DAYLIGHT OPENING 27" (686)[2]
27 7/8" (708)[2]
29 1/8" (740)

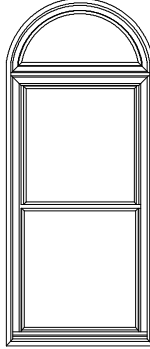

MDHB3466-R

86 3/4" (2203)
84" (2134)
83 1/2" (2121)
29 3/16" (741)
28 5/16" (719)
12 1/8" (308)

UNIT SIZE 36 3/4" (933)
ROUGH OPENING 34" (864)
FRAME SIZE 33 1/2" (851)
DAYLIGHT OPENING 27" (686)[2]
27 7/8" (708)[2]
29 1/8" (740)

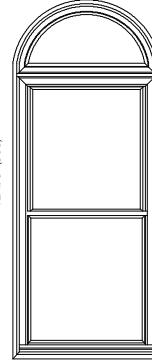

MDHB3469-R

89 3/4" (2280)
87" (2210)
86 1/2" (2197)
30 11/16" (779)
29 13/16" (757)
12 1/8" (308)

UNIT SIZE 36 3/4" (933)
ROUGH OPENING 34" (864)
FRAME SIZE 33 1/2" (851)
DAYLIGHT OPENING 27" (686)[2]
27 7/8" (708)[2]
29 1/8" (740)

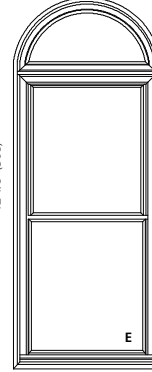

MDHB3472-R

92 3/4" (2356)
90" (2286)
89 1/2" (2273)
31 5/16" (795)
31 5/16" (795)
12 1/8" (308)

UNIT SIZE 36 3/4" (933)
ROUGH OPENING 34" (864)
FRAME SIZE 33 1/2" (851)
DAYLIGHT OPENING 27" (686)[2]
27 7/8" (708)[2]
29 1/8" (740)

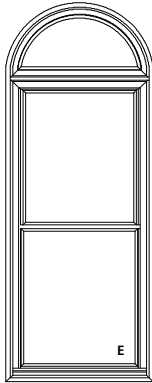

MDHB3474-R

94 3/4" (2407)
92" (2337)
91 1/2" (2324)
33 3/16" (843)
32 5/16" (824)
12 1/8" (308)

UNIT SIZE 36 3/4" (933)
ROUGH OPENING 34" (864)
FRAME SIZE 33 1/2" (851)
DAYLIGHT OPENING 27" (686)[2]
27 7/8" (708)[2]
29 1/8" (740)

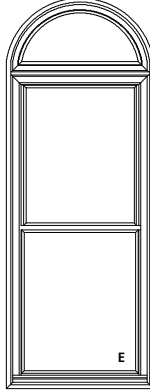

MDHB3477-R

97 3/4" (2483)
95" (2413)
94 1/2" (2400)
34 11/16" (881)
33 13/16" (859)
12 1/8" (308)

UNIT SIZE 38 3/4" (984)
ROUGH OPENING 36" (914)
FRAME SIZE 35 1/2" (902)
DAYLIGHT OPENING 29" (737)[2]
29 7/8" (579)[2]
31 1/8" (791)

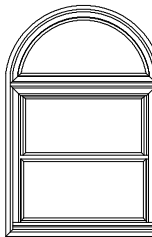

MDHB3636-R

57 3/4" (1467)
55" (1397)
54 1/2" (1384)
14 3/16" (360)
13 5/16" (338)
13 1/8" (333)

UNIT SIZE 38 3/4" (984)
ROUGH OPENING 36" (914)
FRAME SIZE 35 1/2" (902)
DAYLIGHT OPENING 29" (737)[2]
29 7/8" (579)[2]
31 1/8" (791)

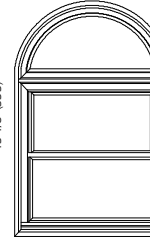

MDHB3637-R

58 3/4" (1492)
56" (1422)
55 1/2" (1410)
14 11/16" (373)
13 13/16" (351)
13 1/8" (333)

UNIT SIZE 38 3/4" (984)
ROUGH OPENING 36" (914)
FRAME SIZE 35 1/2" (902)
DAYLIGHT OPENING 29" (737)[2]
29 7/8" (579)[2]
31 1/8" (791)

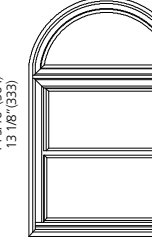

MDHB3638-R

59 3/4" (1518)
57" (1448)
56 1/2" (1435)
15 3/16" (386)
14 5/16" (364)
13 1/8" (333)

UNIT SIZE 38 3/4" (984)
ROUGH OPENING 36" (914)
FRAME SIZE 35 1/2" (902)
DAYLIGHT OPENING 29" (737)[2]
29 7/8" (579)[2]
31 1/8" (791)

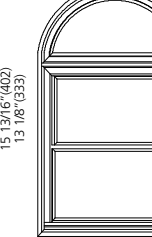

MDHB3641-R

61 3/4" (1568)
59" (1498)
58 1/2" (1486)
16 11/16" (424)
15 13/16" (402)
13 1/8" (333)

ELEVATION SYMBOL LEGEND:
VALUES IN () ARE IN MILLIMETER CONVERSIONS
VALUES IN [] ARE NUMBER OF DAYLIGHT OPENINGS PER UNIT

E BASIC UNIT CLEAR OPENING EXCEEDS 20" IN WIDTH, 24" IN HEIGHT & A MINIMUM OF 5.7 SQ. FT.

Note: Elevations shown DO NOT have exterior trim. Subtract 1/2" (12.7) from M.O. (Masonry Opening) for Unit Sizes. Masonry Openings above include Sill Nose, see Trim Options page for Sill Nose specifications. For other Trim Options refer to the Unit Sizing, Rough Opening & Masonry Openings page.

SCALE: 1/4" = 1'

DOUBLE-HUNG WITH HALF ROUND

UNIT SIZE
ROUGH OPENING
FRAME SIZE
DAYLIGHT OPENING

38 3/4" (984)
36" (914)
35 1/2" (902)
29" (737)[2]
29 7/8" (579)[2]
31 1/8" (791)

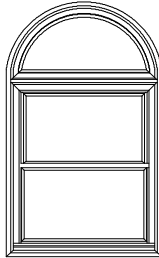

MDHB3642-R

38 3/4" (984)
36" (914)
35 1/2" (902)
29" (737)[2]
29 7/8" (579)[2]
31 1/8" (791)

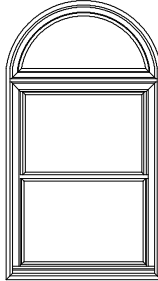

MDHB3648-R

38 3/4" (984)
36" (914)
35 1/2" (902)
29" (737)[2]
29 7/8" (579)[2]
31 1/8" (791)

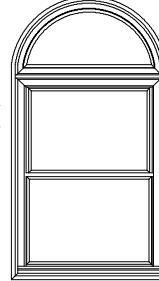

MDHB3649-R

38 3/4" (984)
36" (914)
35 1/2" (902)
29" (737)[2]
29 7/8" (579)[2]
31 1/8" (791)

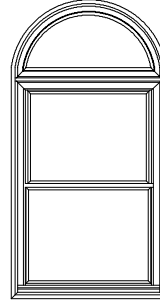

MDHB3653-R

UNIT SIZE
ROUGH OPENING
FRAME SIZE
DAYLIGHT OPENING

38 3/4" (984)
36" (914)
35 1/2" (902)
29" (737)[2]
29 7/8" (579)[2]
31 1/8" (791)

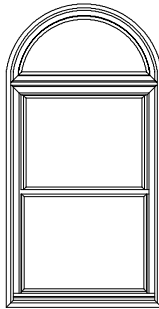

MDHB3654-R

38 3/4" (984)
36" (914)
35 1/2" (902)
29" (737)[2]
29 7/8" (579)[2]
31 1/8" (791)

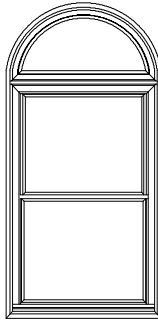

MDHB3657-R

38 3/4" (984)
36" (914)
35 1/2" (902)
29" (737)[2]
29 7/8" (579)[2]
31 1/8" (791)

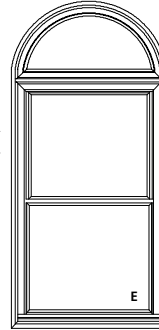

MDHB3660-R

38 3/4" (984)
36" (914)
35 1/2" (902)
29" (737)[2]
29 7/8" (579)[2]
31 1/8" (791)

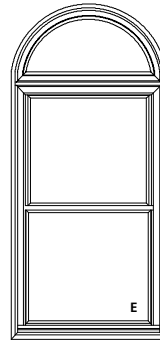

MDHB3662-R

UNIT SIZE
ROUGH OPENING
FRAME SIZE
DAYLIGHT OPENING

38 3/4" (984)
36" (914)
35 1/2" (902)
29" (737)[2]
29 7/8" (579)[2]
31 1/8" (791)

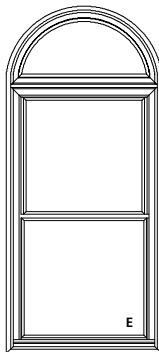

MDHB3665-R

38 3/4" (984)
36" (914)
35 1/2" (902)
29" (737)[2]
29 7/8" (579)[2]
31 1/8" (791)

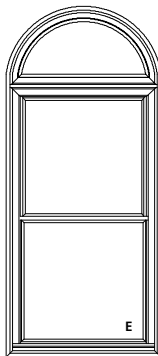

MDHB3666-R

38 3/4" (984)
36" (914)
35 1/2" (902)
29" (737)[2]
29 7/8" (579)[2]
31 1/8" (791)

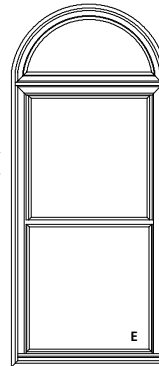

MDHB3669-R

38 3/4" (984)
36" (914)
35 1/2" (902)
29" (737)[2]
29 7/8" (579)[2]
31 1/8" (791)

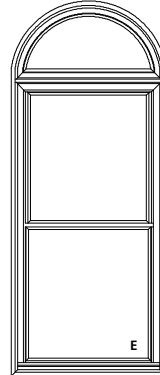

MDHB3672-R

ELEVATION SYMBOL LEGEND:

VALUES IN () ARE IN MILLIMETER CONVERSIONS
VALUES IN [] ARE NUMBER OF DAYLIGHT OPENINGS PER UNIT

E BASIC UNIT CLEAR OPENING EXCEEDS 20" IN WIDTH, 24" IN HEIGHT & A MINIMUM OF 5.7 SQ. FT.

Note: Elevations shown DO NOT have exterior trim. Subtract 1/2" (12.7) from M.O. (Masonry Opening) for Unit Sizes. Masonry Openings above include Sill Nose, see Trim Options page for Sill Nose specifications. For other Trim Options refer to the Unit Sizing, Rough Opening & Masonry Openings page.

SCALE: 1/4" = 1'

DOUBLE-HUNG WITH HALF ROUND

UNIT SIZE
ROUGH OPENING
FRAME SIZE
DAYLIGHT OPENING

38 3/4" (984)
36" (914)
35 1/2" (902)
29" (737)[2]
29 7/8" (579)[2]
31 1/8" (791)

38 3/4" (984)
36" (914)
35 1/2" (902)
29" (737)[2]
29 7/8" (579)[2]
31 1/8" (791)

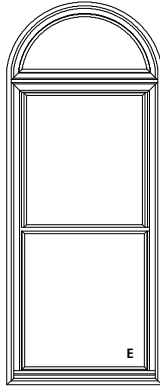

MDHB3674-R

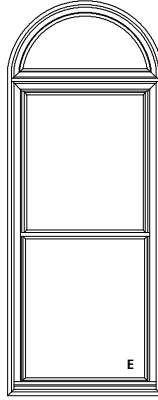

MDHB3677-R

95 3/4" (2432)
93" (2362)
92 1/2" (2350)
93 3/16" (843)
93 1/8" (831)
13 1/8" (333)

98 3/4" (2508)
96" (2438)
95 1/2" (2426)
94 11/16" (881)
93 13/16" (859)
13 1/8" (333)

UNIT SIZE
ROUGH OPENING
FRAME SIZE
DAYLIGHT OPENING

40 3/4" (1035)
38" (965)
37 1/2" (953)
31" (787)[2]
31 7/8" (810)[2]
33 1/8" (841)

40 3/4" (1035)
38" (965)
37 1/2" (953)
31" (787)[2]
31 7/8" (810)[2]
33 1/8" (841)

40 3/4" (1035)
38" (965)
37 1/2" (953)
31" (787)[2]
31 7/8" (810)[2]
33 1/8" (841)

40 3/4" (1035)
38" (965)
37 1/2" (953)
31" (787)[2]
31 7/8" (810)[2]
33 1/8" (841)

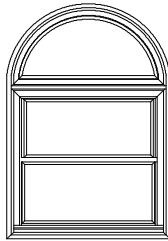

MDHB3836-R

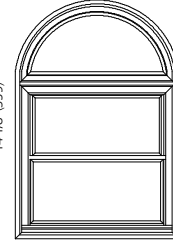

MDHB3837-R

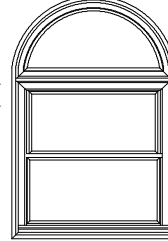

MDHB3838-R

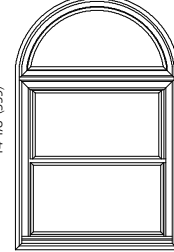

MDHB3841-R

58 3/4" (1492)
56" (1422)
55 1/2" (1410)
14 3/16" (360)
13 1/8" (333)
14 1/8" (359)

59 3/4" (1518)
57" (1449)
56 1/2" (1435)
14 11/16" (373)
13 13/16" (351)
14 1/8" (359)

60 3/4" (1543)
58" (1473)
57 1/2" (1460)
15 3/16" (386)
14 5/16" (364)
14 1/8" (359)

62 3/4" (1594)
60" (1524)
59 1/2" (1511)
16 11/16" (424)
15 13/16" (402)
14 1/8" (359)

UNIT SIZE
ROUGH OPENING
FRAME SIZE
DAYLIGHT OPENING

40 3/4" (1035)
38" (965)
37 1/2" (953)
31" (787)[2]
31 7/8" (810)[2]
33 1/8" (841)

40 3/4" (1035)
38" (965)
37 1/2" (953)
31" (787)[2]
31 7/8" (810)[2]
33 1/8" (841)

40 3/4" (1035)
38" (965)
37 1/2" (953)
31" (787)[2]
31 7/8" (810)[2]
33 1/8" (841)

40 3/4" (1035)
38" (965)
37 1/2" (953)
31" (787)[2]
31 7/8" (810)[2]
33 1/8" (841)

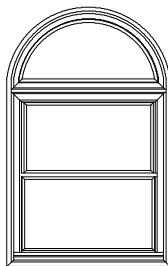

MDHB3842-R

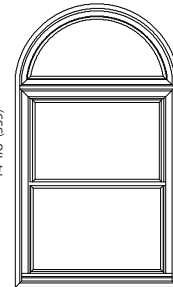

MDHB3848-R

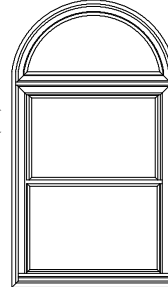

MDHB3849-R

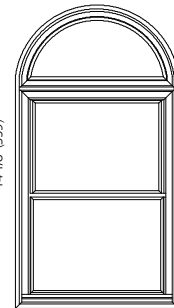

MDHB3853-R

64 3/4" (1645)
62" (1575)
61 1/2" (1562)
17 3/16" (437)
16 3/8" (414)
14 1/8" (359)

70 3/4" (1797)
68" (1727)
67 1/2" (1715)
20 3/16" (513)
19 5/16" (491)
14 1/8" (359)

71 3/4" (1822)
69" (1753)
68 1/2" (1740)
20 11/16" (525)
19 13/16" (503)
14 1/8" (359)

75 3/4" (1924)
73" (1854)
72 1/2" (1842)
22 11/16" (576)
21 13/16" (554)
14 1/8" (359)

ELEVATION SYMBOL LEGEND:

VALUES IN () ARE IN MILLIMETER CONVERSIONS
VALUES IN [] ARE NUMBER OF DAYLIGHT OPENINGS PER UNIT

E BASIC UNIT CLEAR OPENING EXCEEDS 20" IN WIDTH, 24" IN HEIGHT & A MINIMUM OF 5.7 SQ. FT.

Note: Elevations shown DO NOT have exterior trim. Subtract 1/2" (12.7) from M.O. (Masonry Opening) for Unit Sizes. Masonry Openings above include Sill Nose, see Trim Options page for Sill Nose specifications. For other Trim Options refer to the Unit Sizing, Rough Opening & Masonry Openings page.

SCALE: 1/4" = 1'

DOUBLE-HUNG WITH HALF ROUND

UNIT SIZE
ROUGH OPENING
FRAME SIZE
DAYLIGHT OPENING

40 3/4" (1035)
38" (965)
37 1/2" (953)
31" (787) [2]
31 7/8" (810) [2]
33 1/8" (841)

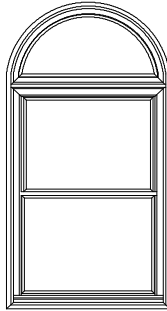

MDHB3854-R

76 3/4" (1949)
74" (1880)
73 1/2" (1867)
73 1/2" (1867)
72 1/2" (1854)
72 1/2" (1854)
14 1/8" (359)

40 3/4" (1035)
38" (965)
37 1/2" (953)
31" (787) [2]
31 7/8" (810) [2]
33 1/8" (841)

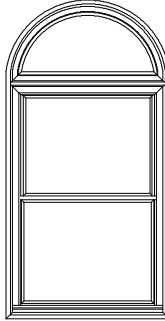

MDHB3857-R

79 3/4" (2026)
77" (1956)
76 1/2" (1943)
74 11/16" (627)
73 13/16" (605)
14 1/8" (359)

40 3/4" (1035)
38" (965)
37 1/2" (953)
31" (787) [2]
31 7/8" (810) [2]
33 1/8" (841)

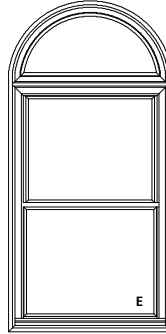

MDHB3860-R

82 3/4" (2102)
80" (2032)
79 1/2" (2019)
26 3/16" (665)
25 5/16" (643)
14 1/8" (359)

40 3/4" (1035)
38" (965)
37 1/2" (953)
31" (787) [2]
31 7/8" (810) [2]
33 1/8" (841)

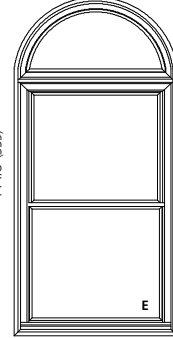

MDHB3862-R

84 3/4" (2153)
82" (2083)
81 1/2" (2070)
27 3/16" (691)
26 5/16" (668)
14 1/8" (359)

UNIT SIZE
ROUGH OPENING
FRAME SIZE
DAYLIGHT OPENING

40 3/4" (1035)
38" (965)
37 1/2" (953)
31" (787) [2]
31 7/8" (810) [2]
33 1/8" (841)

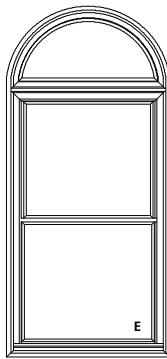

MDHB3865-R

87 3/4" (2229)
85" (2159)
84 1/2" (2146)
84 1/2" (2146)
83 1/2" (2133)
72 1/2" (1854)
14 1/8" (359)

40 3/4" (1035)
38" (965)
37 1/2" (953)
31" (787) [2]
31 7/8" (810) [2]
33 1/8" (841)

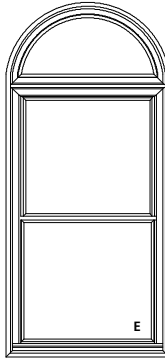

MDHB3866-R

88 3/4" (2254)
86" (2184)
85 1/2" (2172)
29 3/16" (741)
28 5/16" (719)
14 1/8" (359)

40 3/4" (1035)
38" (965)
37 1/2" (953)
31" (787) [2]
31 7/8" (810) [2]
33 1/8" (841)

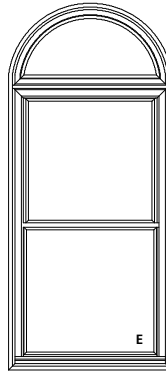

MDHB3869-R

91 3/4" (2330)
89" (2261)
88 1/2" (2248)
30 11/16" (779)
29 13/16" (757)
14 1/8" (359)

40 3/4" (1035)
38" (965)
37 1/2" (953)
31" (787) [2]
31 7/8" (810) [2]
33 1/8" (841)

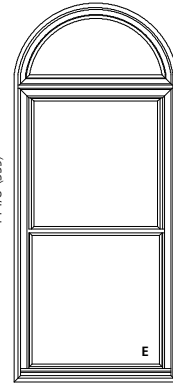

MDHB3872-R

94 3/4" (2407)
92" (2337)
91 1/2" (2324)
32 3/16" (818)
31 5/16" (795)
14 1/8" (359)

UNIT SIZE
ROUGH OPENING
FRAME SIZE
DAYLIGHT OPENING

40 3/4" (1035)
38" (965)
37 1/2" (953)
31" (787) [2]
31 7/8" (810) [2]
33 1/8" (841)

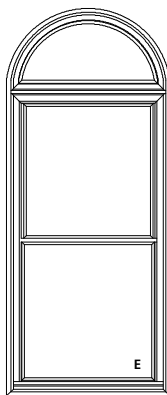

MDHB3874-R

96 3/4" (2457)
94" (2388)
93 1/2" (2380)
93 1/2" (2380)
92 1/2" (2367)
33 5/16" (821)
14 1/8" (359)

40 3/4" (1035)
38" (965)
37 1/2" (953)
31" (787) [2]
31 7/8" (810) [2]
33 1/8" (841)

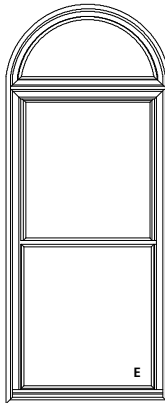

MDHB3877-R

99 3/4" (2534)
97" (2464)
96 1/2" (2451)
34 11/16" (881)
33 13/16" (859)
14 1/8" (359)

ELEVATION SYMBOL LEGEND:
VALUES IN () ARE IN MILLIMETER CONVERSIONS
VALUES IN [] ARE NUMBER OF DAYLIGHT OPENINGS PER UNIT

E BASIC UNIT CLEAR OPENING EXCEEDS 20" IN WIDTH, 24" IN HEIGHT & A MINIMUM OF 5.7 SQ. FT.

Note: Elevations shown DO NOT have exterior trim. Subtract 1/2" (12.7) from M.O. (Masonry Opening) for Unit Sizes. Masonry Openings above include Sill Nose, see Trim Options page for Sill Nose specifications. For other Trim Options refer to the Unit Sizing, Rough Opening & Masonry Openings page.

SCALE: 1/4" = 1'

DOUBLE-HUNG WITH HALF ROUND

UNIT SIZE 42 3/4" (1086)
ROUGH OPENING 40" (1016)
FRAME SIZE 39 1/2" (1003)
DAYLIGHT OPENING 33" (838)[2]
33 7/8" (860)[2]
35 1/8" (892)

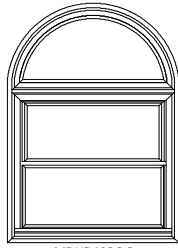

MDHB4036-R

59 3/4" (1518)
57" (1449)
56 1/2" (1435)
14 3/16" (360)
13 9/16" (338)
15 1/8" (384)

42 3/4" (1086)
40" (1016)
39 1/2" (1003)
33" (838)[2]
33 7/8" (860)[2]
35 1/8" (892)

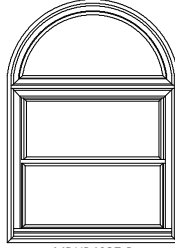

MDHB4037-R

60 3/4" (1543)
58" (1473)
57 1/2" (1460)
14 11/16" (373)
13 13/16" (351)
15 1/8" (384)

42 3/4" (1086)
40" (1016)
39 1/2" (1003)
33" (838)[2]
33 7/8" (860)[2]
35 1/8" (892)

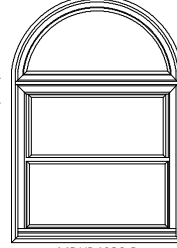

MDHB4038-R

61 3/4" (1568)
59" (1499)
58 1/2" (1486)
15 3/16" (386)
14 5/16" (364)
15 1/8" (384)

42 3/4" (1086)
40" (1016)
39 1/2" (1003)
33" (838)[2]
33 7/8" (860)[2]
35 1/8" (892)

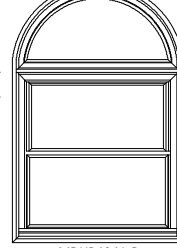

MDHB4041-R

63 3/4" (1619)
61" (1549)
60 1/2" (1537)
16 11/16" (424)
15 13/16" (402)
15 1/8" (384)

UNIT SIZE 42 3/4" (1086)
ROUGH OPENING 40" (1016)
FRAME SIZE 39 1/2" (1003)
DAYLIGHT OPENING 33" (838)[2]
33 7/8" (860)[2]
35 1/8" (892)

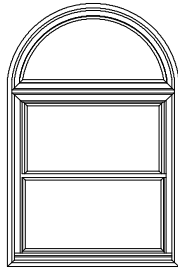

MDHB4042-R

65 3/4" (1670)
63" (1600)
62 1/2" (1588)
17 3/16" (437)
16 9/16" (414)
15 1/8" (384)

42 3/4" (1086)
40" (1016)
39 1/2" (1003)
33" (838)[2]
33 7/8" (860)[2]
35 1/8" (892)

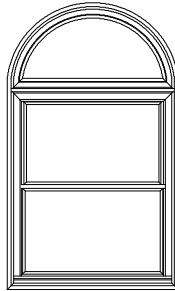

MDHB4048-R

71 3/4" (1822)
69" (1753)
68 1/2" (1740)
20 3/16" (513)
19 5/16" (491)
15 1/8" (384)

42 3/4" (1086)
40" (1016)
39 1/2" (1003)
33" (838)[2]
33 7/8" (860)[2]
35 1/8" (892)

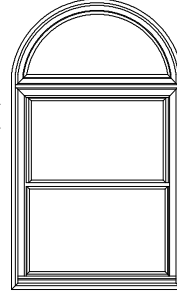

MDHB4049-R

72 3/4" (1848)
70" (1797)
69 1/2" (1765)
20 11/16" (525)
19 13/16" (503)
15 1/8" (384)

42 3/4" (1086)
40" (1016)
39 1/2" (1003)
33" (838)[2]
33 7/8" (860)[2]
35 1/8" (892)

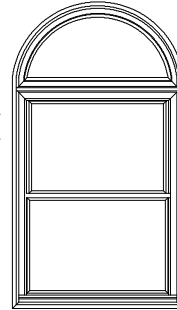

MDHB4053-R

76 3/4" (1949)
74" (1880)
73 1/2" (1867)
22 11/16" (576)
21 13/16" (554)
15 1/8" (384)

UNIT SIZE 42 3/4" (1086)
ROUGH OPENING 40" (1016)
FRAME SIZE 39 1/2" (1003)
DAYLIGHT OPENING 33" (838)[2]
33 7/8" (860)[2]
35 1/8" (892)

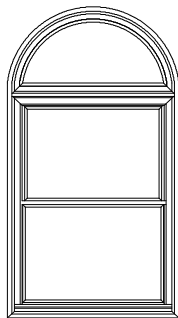

MDHB4054-R

77 3/4" (1975)
75" (1905)
74 1/2" (1892)
23 3/16" (589)
22 5/16" (578)
15 1/8" (384)

42 3/4" (1086)
40" (1016)
39 1/2" (1003)
33" (838)[2]
33 7/8" (860)[2]
35 1/8" (892)

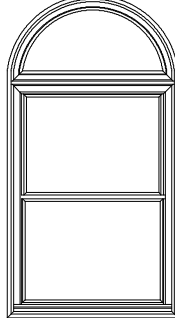

MDHB4057-R

80 3/4" (2051)
78" (1981)
77 1/2" (1969)
24 11/16" (627)
23 13/16" (605)
15 1/8" (384)

42 3/4" (1086)
40" (1016)
39 1/2" (1003)
33" (838)[2]
33 7/8" (860)[2]
35 1/8" (892)

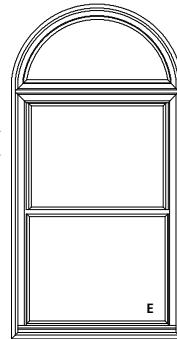

MDHB4060-R

83 3/4" (2127)
81" (2057)
80 1/2" (2045)
26 3/16" (665)
25 5/16" (643)
15 1/8" (384)

42 3/4" (1086)
40" (1016)
39 1/2" (1003)
33" (838)[2]
33 7/8" (860)[2]
35 1/8" (892)

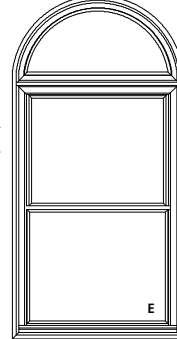

MDHB4062-R

85 3/4" (2178)
83" (2108)
82 1/2" (2093)
27 3/16" (691)
26 5/16" (668)
15 1/8" (384)

ELEVATION SYMBOL LEGEND:
VALUES IN () ARE IN MILLIMETER CONVERSIONS
VALUES IN [] ARE NUMBER OF DAYLIGHT OPENINGS PER UNIT

E BASIC UNIT CLEAR OPENING EXCEEDS 20" IN WIDTH, 24" IN HEIGHT & A MINIMUM OF 5.7 SQ. FT.

Note: Elevations shown DO NOT have exterior trim. Subtract 1/2" (12.7) from M.O. (Masonry Opening) for Unit Sizes. Masonry Openings above include Sill Nose, see Trim Options page for Sill Nose specifications. For other Trim Options refer to the Unit Sizing, Rough Opening & Masonry Openings page.

SCALE: 1/4" = 1'

DOUBLE-HUNG WITH HALF ROUND

UNIT SIZE
ROUGH OPENING
FRAME SIZE
DAYLIGHT OPENING

42 3/4" (1086)
40" (1016)
39 1/2" (1003)
33" (838)[2]
33 7/8" (860)[2]
35 1/8" (892)

88 3/4" (2254)
86" (2184)
85 1/2" (2172)
28 11/16" (729)
27 13/16" (706)
15 1/8" (384)

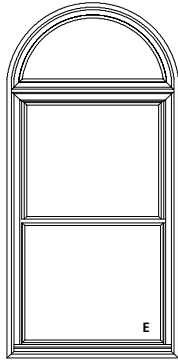

MDHB4065-R

42 3/4" (1086)
40" (1016)
39 1/2" (1003)
33" (838)[2]
33 7/8" (860)[2]
35 1/8" (892)

89 3/4" (2280)
87 1/2" (2210)
86" (2177)
29 31/16" (741)
28 51/16" (719)
15 1/8" (384)

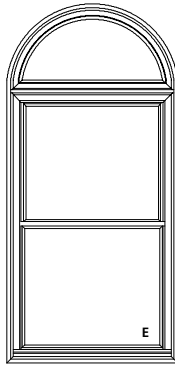

MDHB4066-R

42 3/4" (1086)
40" (1016)
39 1/2" (1003)
33" (838)[2]
33 7/8" (860)[2]
35 1/8" (892)

92 3/4" (2356)
90" (2286)
89 1/2" (2273)
30 11/16" (779)
29 13/16" (757)
15 1/8" (384)

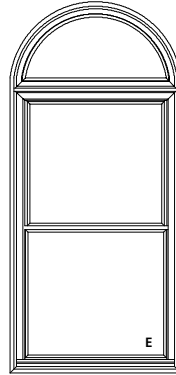

MDHB4069-R

42 3/4" (1086)
40" (1016)
39 1/2" (1003)
33" (838)[2]
33 7/8" (860)[2]
35 1/8" (892)

95 3/4" (2432)
93" (2362)
92 1/2" (2350)
32 3/16" (818)
31 5/16" (795)
15 1/8" (384)

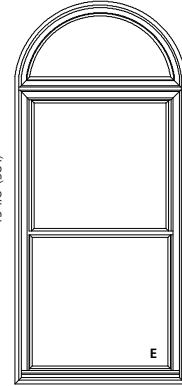

MDHB4072-R

UNIT SIZE
ROUGH OPENING
FRAME SIZE
DAYLIGHT OPENING

42 3/4" (1086)
40" (1016)
39 1/2" (1003)
33" (838)[2]
33 7/8" (860)[2]
35 1/8" (892)

97 3/4" (2483)
95" (2413)
94 1/2" (2400)
33 3/16" (843)
32 5/16" (821)
15 1/8" (384)

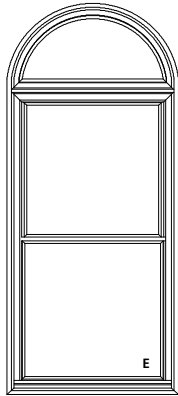

MDHB4074-R

42 3/4" (1086)
40" (1016)
39 1/2" (1003)
33" (838)[2]
33 7/8" (860)[2]
35 1/8" (892)

100 3/4" (2559)
98 1/2" (2489)
97 1/2" (2477)
34 11/16" (881)
33 13/16" (859)
15 1/8" (384)

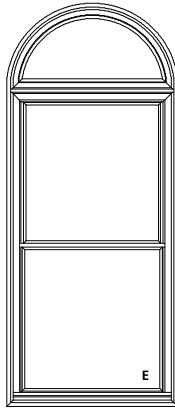

MDHB4077-R

UNIT SIZE
ROUGH OPENING
FRAME SIZE
DAYLIGHT OPENING

44 3/4" (1137)
42" (1067)
41 1/2" (1054)
35" (889)[2]
35 7/8" (911)[2]
37 1/8" (943)

60 3/4" (1543)
58" (1473)
57 1/2" (1460)
14 3/16" (360)
13 5/16" (338)
16 1/8" (410)

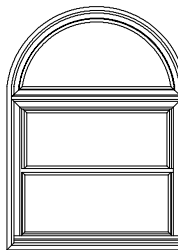

MDHB4236-R

44 3/4" (1137)
42" (1067)
41 1/2" (1054)
35" (889)[2]
35 7/8" (911)[2]
37 1/8" (943)

61 3/4" (1568)
59" (1498)
58 1/2" (1486)
14 11/16" (373)
13 13/16" (351)
16 1/8" (410)

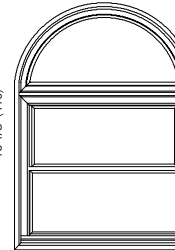

MDHB4237-R

44 3/4" (1137)
42" (1067)
41 1/2" (1054)
35" (889)[2]
35 7/8" (911)[2]
37 1/8" (943)

62 3/4" (1594)
60" (1524)
59 1/2" (1511)
15 3/16" (386)
14 5/16" (364)
16 1/8" (410)

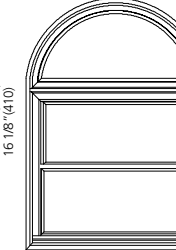

MDHB4238-R

44 3/4" (1137)
42" (1067)
41 1/2" (1054)
35" (889)[2]
35 7/8" (911)[2]
37 1/8" (943)

64 3/4" (1645)
62" (1575)
61 1/2" (1562)
15 11/16" (402)
14 13/16" (402)
16 1/8" (410)

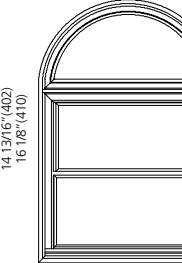

MDHB4241-R

ELEVATION SYMBOL LEGEND:
VALUES IN () ARE IN MILLIMETER CONVERSIONS
VALUES IN [] ARE NUMBER OF DAYLIGHT OPENINGS PER UNIT

E BASIC UNIT CLEAR OPENING EXCEEDS 20" IN WIDTH, 24" IN HEIGHT & A MINIMUM OF 5.7 SQ. FT.

Note: Elevations shown DO NOT have exterior trim. Subtract 1/2" (12.7) from M.O. (Masonry Opening) for Unit Sizes. Masonry Openings above include Sill Nose, see Trim Options page for Sill Nose specifications. For other Trim Options refer to the Unit Sizing, Rough Opening & Masonry Openings page.

SCALE: 1/4" = 1'

DOUBLE-HUNG WITH HALF ROUND

UNIT SIZE
ROUGH OPENING
FRAME SIZE
DAYLIGHT OPENING

44 3/4" (1137)
42" (1067)
41 1/2" (1054)
35" (889)[2]
35 7/8" (911)[2]
37 1/8" (943)

66 3/4" (1695)
64" (1626)
63 1/2" (1613)
17 3/16" (437)
16 3/16" (414)
16 1/8" (410)

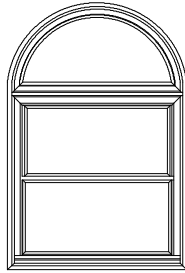

MDHB4242-R

44 3/4" (1137)
42" (1067)
41 1/2" (1054)
35" (889)[2]
35 7/8" (911)[2]
37 1/8" (943)

72 3/4" (1848)
70" (1797)
69 1/2" (1765)
20 3/16" (513)
19 5/16" (491)
16 1/8" (410)

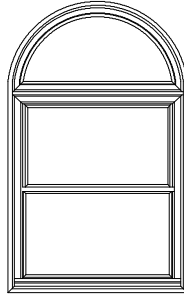

MDHB4248-R

44 3/4" (1137)
42" (1067)
41 1/2" (1054)
35" (889)[2]
35 7/8" (911)[2]
37 1/8" (943)

73 3/4" (1873)
71" (1803)
70 1/2" (1791)
20 1/16" (525)
19 13/16" (503)
16 1/8" (410)

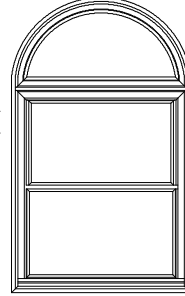

MDHB4249-R

44 3/4" (1137)
42" (1067)
41 1/2" (1054)
35" (889)[2]
35 7/8" (911)[2]
37 1/8" (943)

77 3/4" (1975)
75" (1905)
74 1/2" (1892)
22 11/16" (576)
21 13/16" (554)
16 1/8" (410)

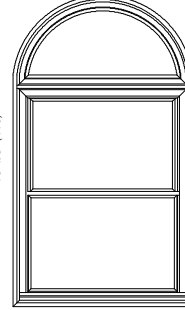

MDHB4253-R

UNIT SIZE
ROUGH OPENING
FRAME SIZE
DAYLIGHT OPENING

44 3/4" (1137)
42" (1067)
41 1/2" (1054)
35" (889)[2]
35 7/8" (911)[2]
37 1/8" (943)

78 3/4" (2000)
76" (1930)
75 1/2" (1918)
23 3/16" (589)
22 1/16" (567)
16 1/8" (410)

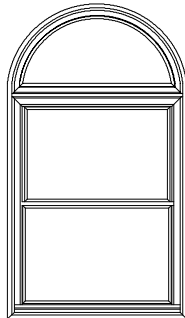

MDHB4254-R

44 3/4" (1137)
42" (1067)
41 1/2" (1054)
35" (889)[2]
35 7/8" (911)[2]
37 1/8" (943)

81 3/4" (2076)
79" (2007)
78 1/2" (1994)
24 11/16" (627)
23 13/16" (605)
16 1/8" (410)

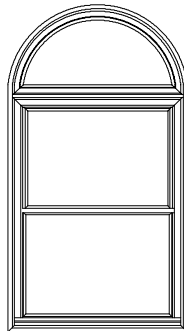

MDHB4257-R

44 3/4" (1137)
42" (1067)
41 1/2" (1054)
35" (889)[2]
35 7/8" (911)[2]
37 1/8" (943)

84 3/4" (2153)
82" (2083)
81 1/2" (2070)
26 3/16" (665)
25 5/16" (643)
16 1/8" (410)

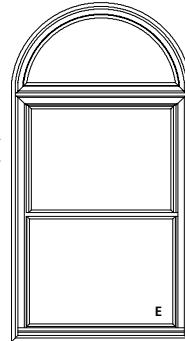

MDHB4260-R

44 3/4" (1137)
42" (1067)
41 1/2" (1054)
35" (889)[2]
35 7/8" (911)[2]
37 1/8" (943)

86 3/4" (2203)
84" (2134)
83 1/2" (2121)
27 3/16" (691)
26 5/16" (668)
16 1/8" (410)

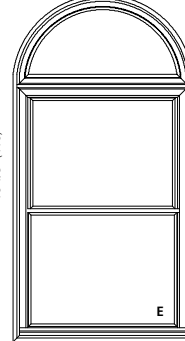

MDHB4262-R

UNIT SIZE
ROUGH OPENING
FRAME SIZE
DAYLIGHT OPENING

44 3/4" (1137)
42" (1067)
41 1/2" (1054)
35" (889)[2]
35 7/8" (911)[2]
37 1/8" (943)

89 3/4" (2280)
87" (2210)
86 1/2" (2197)
28 11/16" (729)
27 1/16" (706)
16 1/8" (410)

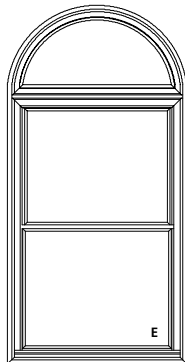

MDHB4265-R

44 3/4" (1137)
42" (1067)
41 1/2" (1054)
35" (889)[2]
35 7/8" (911)[2]
37 1/8" (943)

90 3/4" (2305)
88" (2235)
87 1/2" (2223)
29 3/16" (741)
28 5/16" (719)
16 1/8" (410)

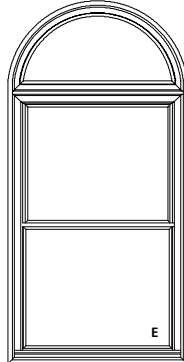

MDHB4266-R

44 3/4" (1137)
42" (1067)
41 1/2" (1054)
35" (889)[2]
35 7/8" (911)[2]
37 1/8" (943)

93 3/4" (2381)
91" (2311)
90 1/2" (2299)
30 11/16" (779)
29 13/16" (757)
16 1/8" (410)

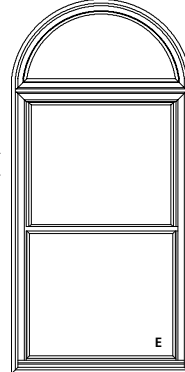

MDHB4269-R

44 3/4" (1137)
42" (1067)
41 1/2" (1054)
35" (889)[2]
35 7/8" (911)[2]
37 1/8" (943)

96 3/4" (2457)
94" (2388)
93 1/2" (2380)
32 3/16" (818)
31 5/16" (795)
16 1/8" (410)

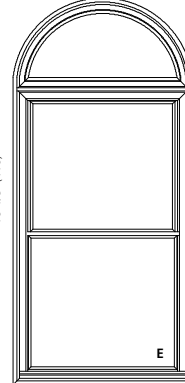

MDHB4272-R

ELEVATION SYMBOL LEGEND:
VALUES IN () ARE IN MILLIMETER CONVERSIONS
VALUES IN [] ARE NUMBER OF DAYLIGHT OPENINGS PER UNIT

E BASIC UNIT CLEAR OPENING EXCEEDS 20" IN WIDTH, 24" IN HEIGHT & A MINIMUM OF 5.7 SQ. FT.

Note: Elevations shown DO NOT have exterior trim. Subtract 1/2" (12.7) from M.O. (Masonry Opening) for Unit Sizes. Masonry Openings above include Sill Nose, see Trim Options page for Sill Nose specifications. For other Trim Options refer to the Unit Sizing, Rough Opening & Masonry Openings page.

SCALE: 1/4" = 1'

DOUBLE-HUNG WITH HALF ROUND

UNIT SIZE
ROUGH OPENING
FRAME SIZE
DAYLIGHT OPENING

44 3/4" (1137)
42" (1067)
41 1/2" (1054)
35" (889)[2]
35 7/8" (911)[2]
37 1/8" (943)

44 3/4" (1137)
42" (1067)
41 1/2" (1054)
35" (889)[2]
35 7/8" (911)[2]
37 1/8" (943)

98 3/4" (2508)
96" (2438)
95 1/2" (2426)
33 3/16" (843)
32 5/16" (821)
16 1/8" (410)

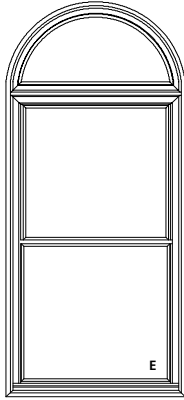

MDHB4274-R

101 3/4" (2584)
99" (2515)
98 1/2" (2505)
34 11/16" (881)
33 13/16" (859)
16 1/8" (410)

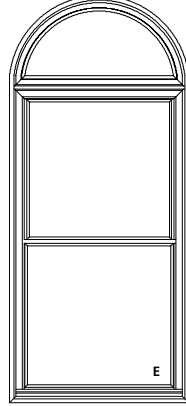

MDHB4277-R

UNIT SIZE
ROUGH OPENING
FRAME SIZE
DAYLIGHT OPENING

48 3/4" (1238)
46" (1168)
45 1/2" (1156)
39" (991)[2]
39 7/8" (1013)[2]
41 1/8" (1045)

48 3/4" (1238)
46" (1168)
45 1/2" (1156)
39" (991)[2]
39 7/8" (1013)[2]
41 1/8" (1045)

48 3/4" (1238)
46" (1168)
45 1/2" (1156)
39" (991)[2]
39 7/8" (1013)[2]
41 1/8" (1045)

48 3/4" (1238)
46" (1168)
45 1/2" (1156)
39" (991)[2]
39 7/8" (1013)[2]
41 1/8" (1045)

62 3/4" (1594)
60" (1524)
59 1/2" (1511)
14 3/16" (360)
13 5/16" (338)
18 1/8" (460)

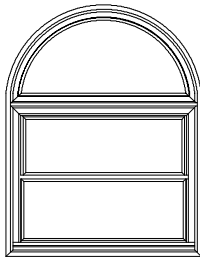

MDHB4636-R

63 3/4" (1619)
61" (1549)
60 1/2" (1537)
14 11/16" (373)
13 13/16" (351)
18 1/8" (460)

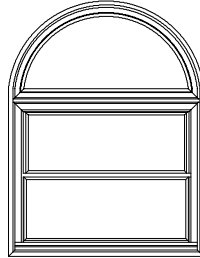

MDHB4637-R

64 3/4" (1645)
62" (1575)
61 1/2" (1562)
15 3/16" (386)
14 5/16" (364)
18 1/8" (460)

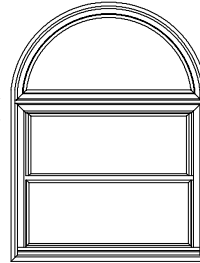

MDHB4638-R

66 3/4" (1695)
64" (1626)
63 1/2" (1613)
16 11/16" (424)
15 13/16" (402)
18 1/8" (460)

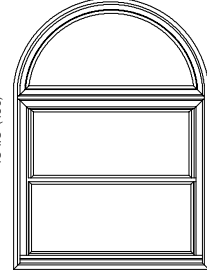

MDHB4641-R

UNIT SIZE
ROUGH OPENING
FRAME SIZE
DAYLIGHT OPENING

48 3/4" (1238)
46" (1168)
45 1/2" (1156)
39" (991)[2]
39 7/8" (1013)[2]
41 1/8" (1045)

48 3/4" (1238)
46" (1168)
45 1/2" (1156)
39" (991)[2]
39 7/8" (1013)[2]
41 1/8" (1045)

48 3/4" (1238)
46" (1168)
45 1/2" (1156)
39" (991)[2]
39 7/8" (1013)[2]
41 1/8" (1045)

48 3/4" (1238)
46" (1168)
45 1/2" (1156)
39" (991)[2]
39 7/8" (1013)[2]
41 1/8" (1045)

68 3/4" (1746)
66" (1676)
65 1/2" (1664)
17 3/16" (437)
16 5/16" (414)
18 1/8" (460)

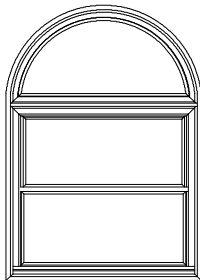

MDHB4642-R

74 3/4" (1899)
72" (1829)
71 1/2" (1861)
20 3/16" (513)
19 5/16" (491)
18 1/8" (460)

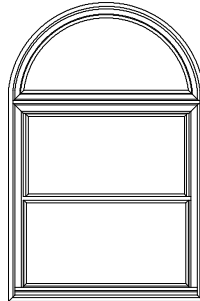

MDHB4648-R

75 3/4" (1924)
73" (1854)
72 1/2" (1842)
20 11/16" (525)
19 13/16" (503)
18 1/8" (460)

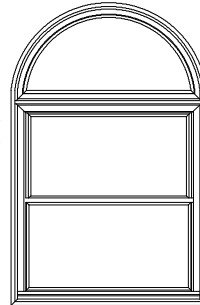

MDHB4649-R

79 3/4" (2026)
77" (1956)
76 1/2" (1943)
22 11/16" (576)
21 13/16" (554)
18 1/8" (460)

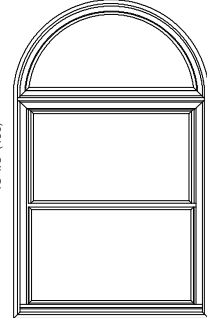

MDHB4653-R

ELEVATION SYMBOL LEGEND:
VALUES IN () ARE IN MILLIMETER CONVERSIONS
VALUES IN [] ARE NUMBER OF DAYLIGHT OPENINGS PER UNIT

E BASIC UNIT CLEAR OPENING EXCEEDS 20" IN WIDTH, 24" IN HEIGHT & A MINIMUM OF 5.7 SQ. FT.

Note: Elevations shown DO NOT have exterior trim. Subtract 1/2" (12.7) from M.O. (Masonry Opening) for Unit Sizes. Masonry Openings above include Sill Nose, see Trim Options page for Sill Nose specifications. For other Trim Options refer to the Unit Sizing, Rough Opening & Masonry Openings page.

SCALE: 1/4" = 1'

DOUBLE-HUNG WITH HALF ROUND

UNIT SIZE
ROUGH OPENING
FRAME SIZE
DAYLIGHT OPENING

48 3/4" (1238)
46" (1168)
45 1/2" (1156)
39" (991) [2]
39 7/8" (1013) [2]
41 1/8" (1045)

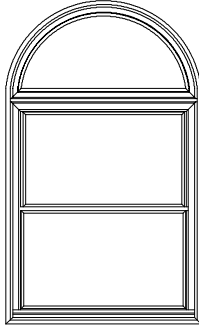

MDHB4654-R

80 3/4" (2051)
76" (1961)
73 1/2" (1889)
72 5/16" (1878)
22 5/16" (578)
18 1/8" (460)

83 3/4" (2127)
81" (2057)
80 1/2" (2045)
24 11/16" (627)
23 3/16" (605)
18 1/8" (460)

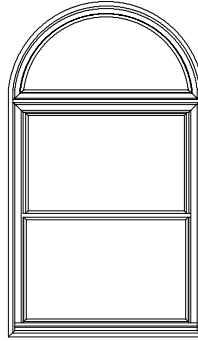

MDHB4657-R

48 3/4" (1238)
46" (1168)
45 1/2" (1156)
39" (991) [2]
39 7/8" (1013) [2]
41 1/8" (1045)

86 3/4" (2203)
84" (2134)
83 1/2" (2121)
26 3/16" (665)
25 5/16" (643)
18 1/8" (460)

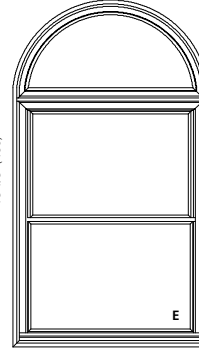

MDHB4660-R

48 3/4" (1238)
46" (1168)
45 1/2" (1156)
39" (991) [2]
39 7/8" (1013) [2]
41 1/8" (1045)

88 3/4" (2254)
86" (2184)
85 1/2" (2172)
27 3/16" (691)
26 5/16" (668)
18 1/8" (460)

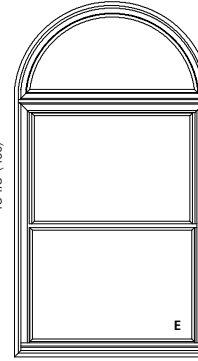

MDHB4662-R

48 3/4" (1238)
46" (1168)
45 1/2" (1156)
39" (991) [2]
39 7/8" (1013) [2]
41 1/8" (1045)

UNIT SIZE
ROUGH OPENING
FRAME SIZE
DAYLIGHT OPENING

48 3/4" (1238)
46" (1168)
45 1/2" (1156)
39" (991) [2]
39 7/8" (1013) [2]
41 1/8" (1045)

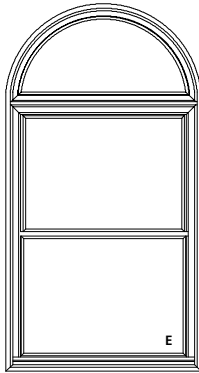

MDHB4665-R

91 3/4" (2330)
89" (2261)
88 1/2" (2249)
27 1/16" (709)
27 13/16" (706)
18 1/8" (460)

92 3/4" (2356)
90" (2286)
89 1/2" (2273)
29 3/16" (741)
28 3/16" (719)
18 1/8" (460)

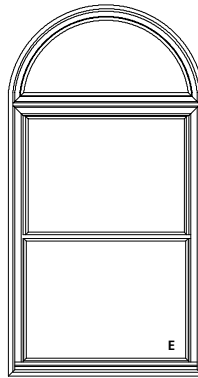

MDHB4666-R

48 3/4" (1238)
46" (1168)
45 1/2" (1156)
39" (991) [2]
39 7/8" (1013) [2]
41 1/8" (1045)

95 3/4" (2432)
93" (2362)
92 1/2" (2350)
30 11/16" (779)
29 13/16" (757)
18 1/8" (460)

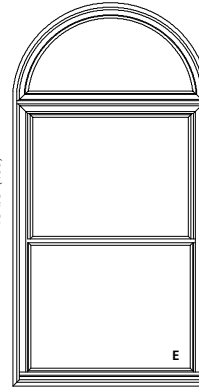

MDHB4669-R

48 3/4" (1238)
46" (1168)
45 1/2" (1156)
39" (991) [2]
39 7/8" (1013) [2]
41 1/8" (1045)

98 3/4" (2508)
96" (2438)
95 1/2" (2426)
32 3/16" (818)
31 5/16" (795)
18 1/8" (460)

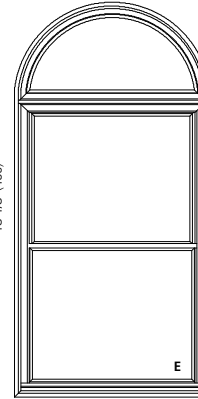

MDHB4672-R

48 3/4" (1238)
46" (1168)
45 1/2" (1156)
39" (991) [2]
39 7/8" (1013) [2]
41 1/8" (1045)

UNIT SIZE
ROUGH OPENING
FRAME SIZE
DAYLIGHT OPENING

48 3/4" (1238)
46" (1168)
45 1/2" (1156)
39" (991) [2]
39 7/8" (1013) [2]
41 1/8" (1045)

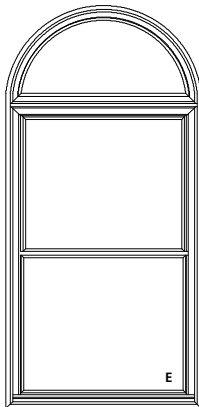

MDHB4674-R

100 3/4" (2559)
96" (2489)
95 1/2" (2477)
33 1/16" (842)
32 5/16" (821)
18 1/8" (460)

103 3/4" (2635)
101" (2565)
100 1/2" (2553)
34 11/16" (881)
33 13/16" (859)
18 1/8" (460)

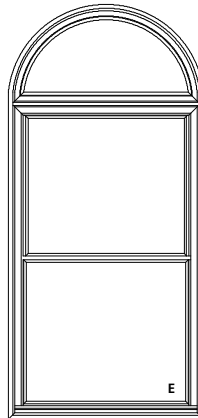

MDHB4677-R

48 3/4" (1238)
46" (1168)
45 1/2" (1156)
39" (991) [2]
39 7/8" (1013) [2]
41 1/8" (1045)

ELEVATION SYMBOL LEGEND:
VALUES IN () ARE IN MILLIMETER CONVERSIONS
VALUES IN [] ARE NUMBER OF DAYLIGHT OPENINGS PER UNIT

E BASIC UNIT CLEAR OPENING EXCEEDS 20" IN WIDTH, 24" IN HEIGHT & A MINIMUM OF 5.7 SQ. FT.

Note: Elevations shown DO NOT have exterior trim. Subtract 1/2" (12.7) from M.O. (Masonry Opening) for Unit Sizes. Masonry Openings above include Sill Nose, see Trim Options page for Sill Nose specifications. For other Trim Options refer to the Unit Sizing, Rough Opening & Masonry Openings page.

SCALE: 1/4" = 1'

DOUBLE-HUNG WITH HALF ROUND

UNIT SIZE
ROUGH OPENING
FRAME SIZE
DAYLIGHT OPENING

50 3/4"(1289)
48"(1219)
47 1/2"(1207)
41"(1041)[]2
41 7/8"(1064)[]2
43 1/8"(1095)

63 3/4"(1619)
61"(1549)
60 1/2"(1537)
14 3/16"(360)
13 5/16"(338)
19 1/8"(486)

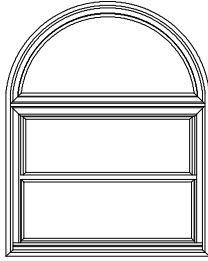

MDHB4836-R

50 3/4"(1289)
48"(1219)
47 1/2"(1207)
41"(1041)[]2
41 7/8"(1064)[]2
43 1/8"(1095)

64 3/4"(1645)
62"(1575)
61 1/2"(1563)
14 11/16"(373)
13 13/16"(351)
19 1/8"(486)

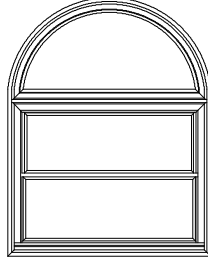

MDHB4837-R

50 3/4"(1289)
48"(1219)
47 1/2"(1207)
41"(1041)[]2
41 7/8"(1064)[]2
43 1/8"(1095)

65 3/4"(1670)
63"(1600)
62 1/2"(1588)
15 3/16"(386)
14 5/16"(364)
19 1/8"(486)

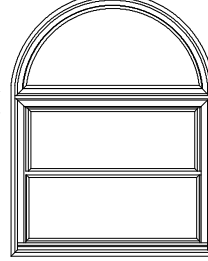

MDHB4838-R

50 3/4"(1289)
48"(1219)
47 1/2"(1207)
41"(1041)[]2
41 7/8"(1064)[]2
43 1/8"(1095)

67 3/4"(1721)
65"(1651)
64 1/2"(1638)
16 11/16"(424)
15 13/16"(402)
19 1/8"(486)

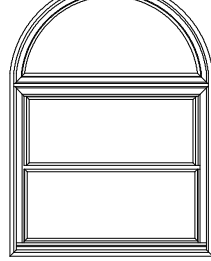

MDHB4841-R

UNIT SIZE
ROUGH OPENING
FRAME SIZE
DAYLIGHT OPENING

50 3/4"(1289)
48"(1219)
47 1/2"(1207)
41"(1041)[]2
41 7/8"(1064)[]2
43 1/8"(1095)

69 3/4"(1772)
67"(1702)
66 1/2"(1689)
17 3/16"(437)
16 5/16"(414)
19 1/8"(486)

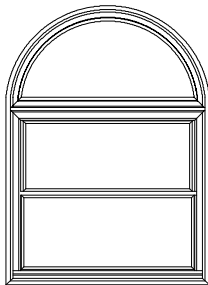

MDHB4842-R

50 3/4"(1289)
48"(1219)
47 1/2"(1207)
41"(1041)[]2
41 7/8"(1064)[]2
43 1/8"(1095)

75 3/4"(1924)
73"(1854)
72 1/2"(1842)
20 3/16"(513)
19 5/16"(491)
19 1/8"(486)

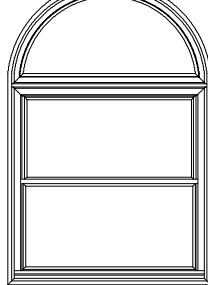

MDHB4848-R

50 3/4"(1289)
48"(1219)
47 1/2"(1207)
41"(1041)[]2
41 7/8"(1064)[]2
43 1/8"(1095)

76 3/4"(1949)
74"(1880)
73 1/2"(1867)
20 11/16"(525)
19 13/16"(503)
19 1/8"(486)

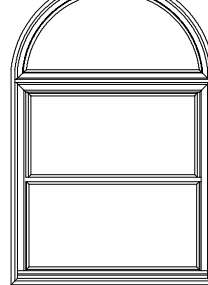

MDHB4849-R

50 3/4"(1289)
48"(1219)
47 1/2"(1207)
41"(1041)[]2
41 7/8"(1064)[]2
43 1/8"(1095)

80 3/4"(2051)
78"(1981)
77 1/2"(1969)
22 11/16"(576)
21 13/16"(554)
19 1/8"(486)

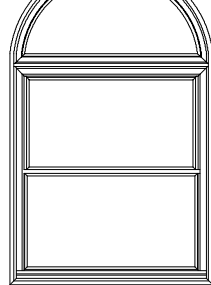

MDHB4853-R

UNIT SIZE
ROUGH OPENING
FRAME SIZE
DAYLIGHT OPENING

50 3/4"(1289)
48"(1219)
47 1/2"(1207)
41"(1041)[]2
41 7/8"(1064)[]2
43 1/8"(1095)

81 3/4"(2076)
79"(2007)
78 1/2"(1994)
23 3/16"(589)
22 5/16"(578)
19 1/8"(486)

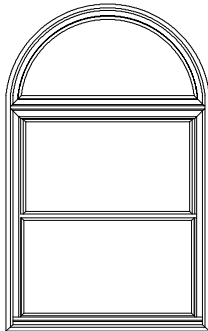

MDHB4854-R

50 3/4"(1289)
48"(1219)
47 1/2"(1207)
41"(1041)[]2
41 7/8"(1064)[]2
43 1/8"(1095)

84 3/4"(2153)
81"(2083)
80 1/2"(2070)
24 11/16"(627)
23 13/16"(605)
19 1/8"(486)

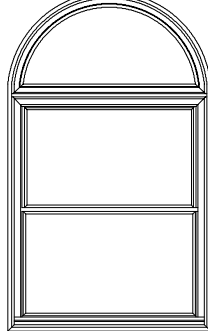

MDHB4857-R

50 3/4"(1289)
48"(1219)
47 1/2"(1207)
41"(1041)[]2
41 7/8"(1064)[]2
43 1/8"(1095)

87 3/4"(2229)
85"(2159)
84 1/2"(2146)
26 3/16"(665)
25 5/16"(643)
19 1/8"(486)

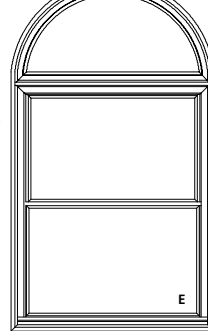

MDHB4860-R

50 3/4"(1289)
48"(1219)
47 1/2"(1207)
41"(1041)[]2
41 7/8"(1064)[]2
43 1/8"(1095)

89 3/4"(2280)
87"(2210)
86 1/2"(2197)
27 3/16"(691)
26 5/16"(668)
19 1/8"(486)

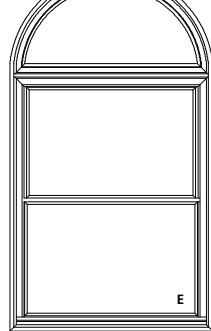

MDHB4862-R

ELEVATION SYMBOL LEGEND:
VALUES IN () ARE IN MILLIMETER CONVERSIONS
VALUES IN [] ARE NUMBER OF DAYLIGHT OPENINGS PER UNIT

E BASIC UNIT CLEAR OPENING EXCEEDS 20" IN WIDTH, 24" IN HEIGHT & A MINIMUM OF 5.7 SQ. FT.

Note: Elevations shown DO NOT have exterior trim. Subtract 1/2" (12.7) from M.O. (Masonry Opening) for Unit Sizes. Masonry Openings above include Sill Nose, see Trim Options page for Sill Nose specifications. For other Trim Options refer to the Unit Sizing, Rough Opening & Masonry Openings page.

SCALE: 1/4" = 1'

DOUBLE-HUNG WITH HALF ROUND

UNIT SIZE
ROUGH OPENING
FRAME SIZE
DAYLIGHT OPENING

50 3/4" (1289)
48" (1219)
47 1/2" (1207)
41" (1041) [2]
41 7/8" (1064) [2]
43 1/8" (1095)

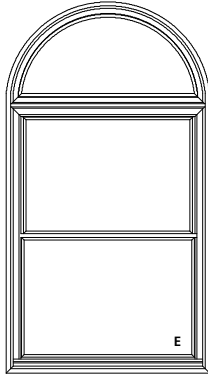

93 3/4" (2356)
90" (2286)
88 1/2" (2253)
83 1/16" (2129)
77 13/16" (2006)
19 1/8" (486)

MDHB4865-R

50 3/4" (1289)
48" (1219)
47 1/2" (1207)
41" (1041) [2]
41 7/8" (1064) [2]
43 1/8" (1095)

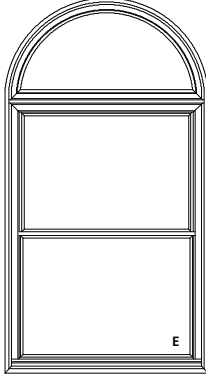

93 3/4" (2381)
91" (2311)
90 1/2" (2299)
29 3/16" (741)
28 5/16" (719)
19 1/8" (486)

MDHB4866-R

50 3/4" (1289)
48" (1219)
47 1/2" (1207)
41" (1041) [2]
41 7/8" (1064) [2]
43 1/8" (1095)

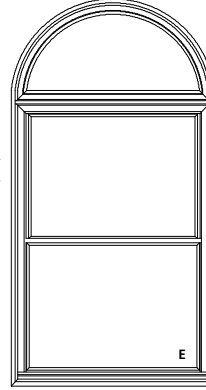

96 3/4" (2457)
94" (2388)
93 1/2" (2380)
30 11/16" (779)
29 13/16" (757)
19 1/8" (486)

MDHB4869-R

50 3/4" (1289)
48" (1219)
47 1/2" (1207)
41" (1041) [2]
41 7/8" (1064) [2]
43 1/8" (1095)

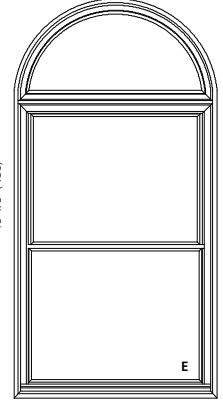

99 3/4" (2534)
97" (2465)
95 1/2" (2451)
32 3/16" (818)
31 5/16" (795)
19 1/8" (486)

MDHB4872-R

UNIT SIZE
ROUGH OPENING
FRAME SIZE
DAYLIGHT OPENING

50 3/4" (1289)
48" (1219)
47 1/2" (1207)
41" (1041) [2]
41 7/8" (1064) [2]
43 1/8" (1095)

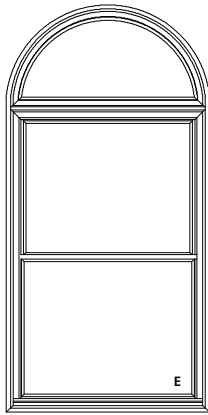

101 3/4" (2584)
99" (2515)
98 1/2" (2503)
33 3/16" (843)
32 5/16" (821)
19 1/8" (486)

MDHB4874-R

50 3/4" (1289)
48" (1219)
47 1/2" (1207)
41" (1041) [2]
41 7/8" (1064) [2]
43 1/8" (1095)

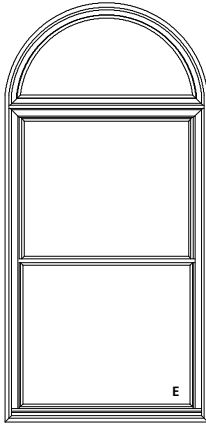

104 3/4" (2661)
102" (2591)
101 1/2" (2578)
34 11/16" (881)
33 13/16" (859)
19 1/8" (486)

MDHB4877-R

















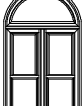





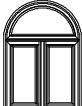

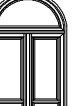
ELEVATION SYMBOL LEGEND:
VALUES IN () ARE IN MILLIMETER CONVERSIONS
VALUES IN [] ARE NUMBER OF DAYLIGHT OPENINGS PER UNIT

E BASIC UNIT CLEAR OPENING EXCEEDS 20" IN WIDTH, 24" IN HEIGHT & A MINIMUM OF 5.7 SQ. FT.

Note: Elevations shown DO NOT have exterior trim. Subtract 1/2" (12.7) from M.O. (Masonry Opening) for Unit Sizes. Masonry Openings above include Sill Nose, see Trim Options page for Sill Nose specifications. For other Trim Options refer to the Unit Sizing, Rough Opening & Masonry Openings page.

SCALE: 1/4" = 1'

2-WIDE DOUBLE-HUNG WITH HALF ROUND

UNIT SIZE ROUGH OPENING FRAME SIZE DAYLIGHT OPENING	38 3/4" (984) 36" (914) 35 1/2" (902) 11" (279)[2] 11 7/8" (302)[2] 31 1/8" (791)	 MDHB3636-2R	38 3/4" (984) 36" (914) 35 1/2" (902) 11" (279)[2] 11 7/8" (302)[2] 31 1/8" (791)	 MDHB3637-2R	38 3/4" (984) 36" (914) 35 1/2" (902) 11" (279)[2] 11 7/8" (302)[2] 31 1/8" (791)	 MDHB3638-2R	38 3/4" (984) 36" (914) 35 1/2" (902) 11" (279)[2] 11 7/8" (302)[2] 31 1/8" (791)	 MDHB3641-2R	38 3/4" (984) 36" (914) 35 1/2" (902) 11" (279)[2] 11 7/8" (302)[2] 31 1/8" (791)	 MDHB3642-2R	38 3/4" (984) 36" (914) 35 1/2" (902) 11" (279)[2] 11 7/8" (302)[2] 31 1/8" (791)	 MDHB3648-2R
UNIT SIZE ROUGH OPENING FRAME SIZE DAYLIGHT OPENING	38 3/4" (984) 36" (914) 35 1/2" (902) 11" (279)[2] 11 7/8" (302)[2] 31 1/8" (791)	 MDHB3649-2R	38 3/4" (984) 36" (914) 35 1/2" (902) 11" (279)[2] 11 7/8" (302)[2] 31 1/8" (791)	 MDHB3653-2R	38 3/4" (984) 36" (914) 35 1/2" (902) 11" (279)[2] 11 7/8" (302)[2] 31 1/8" (791)	 MDHB3654-2R	38 3/4" (984) 36" (914) 35 1/2" (902) 11" (279)[2] 11 7/8" (302)[2] 31 1/8" (791)	 MDHB3657-2R	38 3/4" (984) 36" (914) 35 1/2" (902) 11" (279)[2] 11 7/8" (302)[2] 31 1/8" (791)	 MDHB3660-2R	38 3/4" (984) 36" (914) 35 1/2" (902) 11" (279)[2] 11 7/8" (302)[2] 31 1/8" (791)	 MDHB3662-2R
UNIT SIZE ROUGH OPENING FRAME SIZE DAYLIGHT OPENING	38 3/4" (984) 36" (914) 35 1/2" (902) 11" (279)[2] 11 7/8" (302)[2] 31 1/8" (791)	 MDHB3665-2R	38 3/4" (984) 36" (914) 35 1/2" (902) 11" (279)[2] 11 7/8" (302)[2] 31 1/8" (791)	 MDHB3666-2R	38 3/4" (984) 36" (914) 35 1/2" (902) 11" (279)[2] 11 7/8" (302)[2] 31 1/8" (791)	 MDHB3669-2R	38 3/4" (984) 36" (914) 35 1/2" (902) 11" (279)[2] 11 7/8" (302)[2] 31 1/8" (791)	 MDHB3672-2R	38 3/4" (984) 36" (914) 35 1/2" (902) 11" (279)[2] 11 7/8" (302)[2] 31 1/8" (791)	 MDHB3674-2R	38 3/4" (984) 36" (914) 35 1/2" (902) 11" (279)[2] 11 7/8" (302)[2] 31 1/8" (791)	 MDHB3677-2R
UNIT SIZE ROUGH OPENING FRAME SIZE DAYLIGHT OPENING	42 3/4" (1086) 40" (1016) 39 1/2" (1003) 13" (330)[2] 13 7/8" (352)[2] 35 1/8" (892)	 MDHB4036-2R	42 3/4" (1086) 40" (1016) 39 1/2" (1003) 13" (330)[2] 13 7/8" (352)[2] 35 1/8" (892)	 MDHB4037-2R	42 3/4" (1086) 40" (1016) 39 1/2" (1003) 13" (330)[2] 13 7/8" (352)[2] 35 1/8" (892)	 MDHB4038-2R	42 3/4" (1086) 40" (1016) 39 1/2" (1003) 13" (330)[2] 13 7/8" (352)[2] 35 1/8" (892)	 MDHB4041-2R	42 3/4" (1086) 40" (1016) 39 1/2" (1003) 13" (330)[2] 13 7/8" (352)[2] 35 1/8" (892)	 MDHB4042-2R	42 3/4" (1086) 40" (1016) 39 1/2" (1003) 13" (330)[2] 13 7/8" (352)[2] 35 1/8" (892)	 MDHB4043-2R

ELEVATION SYMBOL LEGEND:
 VALUES IN () ARE IN MILLIMETER CONVERSIONS
 VALUES IN [] ARE NUMBER OF DAYLIGHT OPENINGS PER UNIT

Note: Elevations shown DO NOT have exterior trim. Subtract 1/2" (12.7) from M.O. (Masonry Opening) for Unit Sizes. Masonry Openings above include Sill Nose, see Trim Options page for Sill Nose specifications. For other Trim Options refer to the Unit Sizing, Rough Opening & Masonry Openings page.

SCALE: 1/8" = 1'

2-WIDE DOUBLE-HUNG WITH HALF ROUND

UNIT SIZE 42 3/4" (1086)
ROUGH OPENING 40" (1016)
FRAME SIZE 39 1/2" (1003)
DAYLIGHT OPENING 13" (330)[2]
13 7/8" (352)[2]
35 1/8" (892)

71 3/4" (1822)
69" (1753)
68 1/2" (1740)
20 3/16" (513)
19 5/16" (491)
15 1/8" (384)

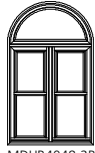

MDHB4048-2R

72 3/4" (1848)
70" (1778)
69 1/2" (1765)
20 11/16" (525)
19 13/16" (503)
15 1/8" (384)



MDHB4049-2R

76 3/4" (1949)
74" (1880)
73 1/2" (1867)
21 1/16" (536)
21 3/16" (534)
15 1/8" (384)



MDHB4053-2R

77 3/4" (1975)
75" (1905)
74 1/2" (1892)
23 3/16" (589)
22 5/16" (578)
15 1/8" (384)



MDHB4054-2R

80 3/4" (2051)
78" (1981)
77 1/2" (1969)
24 11/16" (627)
23 13/16" (605)
15 1/8" (384)



MDHB4057-2R

UNIT SIZE 42 3/4" (1086)
ROUGH OPENING 40" (1016)
FRAME SIZE 39 1/2" (1003)
DAYLIGHT OPENING 13" (330)[2]
13 7/8" (352)[2]
35 1/8" (892)

83 3/4" (2127)
81" (2057)
80 1/2" (2045)
26 3/16" (665)
25 5/16" (643)
15 1/8" (384)

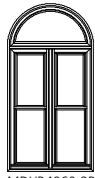

MDHB4060-2R

85 3/4" (2178)
83" (2108)
82 1/2" (2063)
27 3/16" (691)
26 5/16" (668)
15 1/8" (384)



MDHB4062-2R

88 3/4" (2254)
86" (2184)
85 1/2" (2172)
28 11/16" (729)
27 13/16" (706)
15 1/8" (384)



MDHB4065-2R

89 3/4" (2280)
87" (2210)
86 1/2" (2197)
29 3/16" (741)
28 5/16" (719)
15 1/8" (384)



MDHB4066-2R

92 3/4" (2356)
90" (2286)
89 1/2" (2273)
30 11/16" (779)
29 13/16" (757)
15 1/8" (384)



MDHB4069-2R

UNIT SIZE 42 3/4" (1086)
ROUGH OPENING 40" (1016)
FRAME SIZE 39 1/2" (1003)
DAYLIGHT OPENING 13" (330)[2]
13 7/8" (352)[2]
35 1/8" (892)

97 3/4" (2483)
93" (2363)
92 1/2" (2350)
32 3/16" (818)
31 5/16" (795)
15 1/8" (384)



MDHB4072-2R

97 3/4" (2483)
95" (2413)
94 1/2" (2400)
33 3/16" (843)
32 5/16" (821)
15 1/8" (384)



MDHB4074-2R

100 3/4" (2559)
98" (2489)
97 1/2" (2477)
34 11/16" (881)
33 3/16" (859)
15 1/8" (384)



MDHB4077-2R

UNIT SIZE 46 3/4" (1187)
ROUGH OPENING 44" (1067)
FRAME SIZE 43 1/2" (1105)
DAYLIGHT OPENING 15" (381)[2]
15 7/8" (403)[2]
39 1/8" (994)

61 3/4" (1568)
59" (1449)
58 1/2" (1486)
14 3/16" (360)
13 5/16" (338)
17 1/8" (435)



MDHB4436-2R

62 3/4" (1594)
60" (1524)
59 1/2" (1511)
14 11/16" (373)
13 13/16" (351)
17 1/8" (435)



MDHB4437-2R

63 3/4" (1619)
61" (1549)
60 1/2" (1537)
15 3/16" (386)
14 5/16" (364)
17 1/8" (435)



MDHB4438-2R

66 3/4" (1695)
64" (1626)
63 1/2" (1613)
16 11/16" (424)
15 13/16" (402)
17 1/8" (435)



MDHB4441-2R

67 3/4" (1721)
65" (1651)
64 1/2" (1638)
17 3/16" (437)
16 5/16" (414)
17 1/8" (435)



MDHB4442-2R

ELEVATION SYMBOL LEGEND:
VALUES IN () ARE IN MILLIMETER CONVERSIONS
VALUES IN [] ARE NUMBER OF DAYLIGHT OPENINGS PER UNIT

Note: Elevations shown DO NOT have exterior trim. Subtract 1/2" (12.7) from M.O. (Masonry Opening) for Unit Sizes. Masonry Openings above include Sill Nose, see Trim Options page for Sill Nose specifications. For other Trim Options refer to the Unit Sizing, Rough Opening & Masonry Openings page.

SCALE: 1/8" = 1'

2-WIDE DOUBLE-HUNG WITH HALF ROUND

UNIT SIZE	46 3/4"(1187)	46 3/4"(1187)	46 3/4"(1187)	46 3/4"(1187)	46 3/4"(1187)
ROUGH OPENING	44"(1067)	44"(1067)	44"(1067)	44"(1067)	44"(1067)
FRAME SIZE	43 1/2"(1105)	43 1/2"(1105)	43 1/2"(1105)	43 1/2"(1105)	43 1/2"(1105)
DAYLIGHT OPENING	15"(381)[2] 15 7/8"(403)[2] 39 1/8"(994)	15"(381)[2] 15 7/8"(403)[2] 39 1/8"(994)	15"(381)[2] 15 7/8"(403)[2] 39 1/8"(994)	15"(381)[2] 15 7/8"(403)[2] 39 1/8"(994)	15"(381)[2] 15 7/8"(403)[2] 39 1/8"(994)
	73 3/4"(1873) 71"(1803) 70 1/2"(1791) 20 3/16"(513) 19 5/16"(491) 17 1/8"(435)	74 3/4"(1899) 72"(1829) 71 1/2"(1861) 20 11/16"(525) 19 13/16"(503) 17 1/8"(435)	78 3/4"(2000) 76"(1930) 75 1/2"(1918) 22 11/16"(576) 21 13/16"(554) 17 1/8"(435)	79 3/4"(2026) 77"(1956) 76 1/2"(1943) 23 3/16"(589) 22 5/16"(578) 17 1/8"(435)	82 3/4"(2102) 80"(2032) 79 1/2"(2019) 24 11/16"(627) 23 13/16"(605) 17 1/8"(435)
	MDHB4448-2R	MDHB4449-2R	MDHB4453-2R	MDHB4454-2R	MDHB4457-2R
UNIT SIZE	46 3/4"(1187)	46 3/4"(1187)	46 3/4"(1187)	46 3/4"(1187)	46 3/4"(1187)
ROUGH OPENING	44"(1067)	44"(1067)	44"(1067)	44"(1067)	44"(1067)
FRAME SIZE	43 1/2"(1105)	43 1/2"(1105)	43 1/2"(1105)	43 1/2"(1105)	43 1/2"(1105)
DAYLIGHT OPENING	15"(381)[2] 15 7/8"(403)[2] 39 1/8"(994)	15"(381)[2] 15 7/8"(403)[2] 39 1/8"(994)	15"(381)[2] 15 7/8"(403)[2] 39 1/8"(994)	15"(381)[2] 15 7/8"(403)[2] 39 1/8"(994)	15"(381)[2] 15 7/8"(403)[2] 39 1/8"(994)
	85 3/4"(2178) 83"(2108) 82 1/2"(2063) 26 3/16"(665) 25 5/16"(643) 17 1/8"(435)	87 3/4"(2229) 85"(2159) 84 1/2"(2146) 27 3/16"(691) 26 5/16"(668) 17 1/8"(435)	90 3/4"(2305) 88"(2235) 87 1/2"(2223) 28 11/16"(729) 27 13/16"(706) 17 1/8"(435)	91 3/4"(2330) 89"(2261) 88 1/2"(2248) 29 3/16"(741) 28 5/16"(719) 17 1/8"(435)	94 3/4"(2407) 92"(2337) 91 1/2"(2324) 30 11/16"(779) 29 13/16"(757) 17 1/8"(435)
	MDHB4460-2R	MDHB4462-2R	MDHB4465-2R	MDHB4466-2R	MDHB4469-2R
UNIT SIZE	46 3/4"(1187)	46 3/4"(1187)	46 3/4"(1187)	46 3/4"(1187)	46 3/4"(1187)
ROUGH OPENING	44"(1067)	44"(1067)	44"(1067)	44"(1067)	44"(1067)
FRAME SIZE	43 1/2"(1105)	43 1/2"(1105)	43 1/2"(1105)	43 1/2"(1105)	43 1/2"(1105)
DAYLIGHT OPENING	15"(381)[2] 15 7/8"(403)[2] 39 1/8"(994)	15"(381)[2] 15 7/8"(403)[2] 39 1/8"(994)	15"(381)[2] 15 7/8"(403)[2] 39 1/8"(994)	15"(381)[2] 15 7/8"(403)[2] 39 1/8"(994)	15"(381)[2] 15 7/8"(403)[2] 39 1/8"(994)
	97 3/4"(2483) 95"(2414) 94 1/2"(2400) 32 3/16"(818) 31 5/16"(795) 17 1/8"(435)	99 3/4"(2534) 97"(2464) 96 1/2"(2451) 33 3/16"(843) 32 5/16"(821) 17 1/8"(435)	102 3/4"(2610) 100"(2540) 99 1/2"(2527) 34 11/16"(881) 33 13/16"(859) 17 1/8"(435)		
	MDHB4472-2R	MDHB4474-2R	MDHB4477-2R		
UNIT SIZE	50 3/4"(1289)	50 3/4"(1289)	50 3/4"(1289)	50 3/4"(1289)	50 3/4"(1289)
ROUGH OPENING	48"(1219)	48"(1219)	48"(1219)	48"(1219)	48"(1219)
FRAME SIZE	47 1/2"(1207)	47 1/2"(1207)	47 1/2"(1207)	47 1/2"(1207)	47 1/2"(1207)
DAYLIGHT OPENING	17"(432)[2] 17 7/8"(454)[2] 43 1/8"(1095)	17"(432)[2] 17 7/8"(454)[2] 43 1/8"(1095)	17"(432)[2] 17 7/8"(454)[2] 43 1/8"(1095)	17"(432)[2] 17 7/8"(454)[2] 43 1/8"(1095)	17"(432)[2] 17 7/8"(454)[2] 43 1/8"(1095)
	63 3/4"(1619) 61"(1549) 60 1/2"(1537) 14 3/16"(360) 13 5/16"(338) 19 1/8"(486)	64 3/4"(1645) 62"(1575) 61 1/2"(1562) 14 11/16"(373) 13 13/16"(351) 19 1/8"(486)	65 3/4"(1670) 63"(1600) 62 1/2"(1588) 15 3/16"(386) 14 5/16"(364) 19 1/8"(486)	68 3/4"(1746) 66"(1676) 65 1/2"(1664) 16 11/16"(424) 15 13/16"(402) 19 1/8"(486)	69 3/4"(1772) 67"(1702) 66 1/2"(1689) 17 3/16"(437) 16 5/16"(414) 19 1/8"(486)
	MDHB4836-2R	MDHB4837-2R	MDHB4838-2R	MDHB4841-2R	MDHB4842-2R

ELEVATION SYMBOL LEGEND:
VALUES IN () ARE IN MILLIMETER CONVERSIONS
VALUES IN [] ARE NUMBER OF DAYLIGHT OPENINGS PER UNIT

Note: Elevations shown DO NOT have exterior trim. Subtract 1/2" (12.7) from M.O. (Masonry Opening) for Unit Sizes. Masonry Openings above include Sill Nose, see Trim Options page for Sill Nose specifications. For other Trim Options refer to the Unit Sizing, Rough Opening & Masonry Openings page.

SCALE: 1/8" = 1'

2-WIDE DOUBLE-HUNG WITH HALF ROUND

UNIT SIZE
ROUGH OPENING
FRAME SIZE
DAYLIGHT OPENING

54 3/4" (1391)
52" (1321)
51 1/2" (1308)
19" (483)[2]
19 7/8" (505)[2]
47 1/8" (1197)

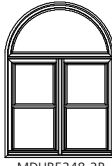

MDHB5248-2R

77 3/4" (1975)
75" (1905)
74 1/2" (1892)
20 3/16" (513)
19 5/16" (491)
21 1/8" (537)

78 3/4" (2000)
76" (1930)
75 1/2" (1918)
20 11/16" (525)
19 13/16" (503)
21 1/8" (537)



MDHB5249-2R

82 3/4" (2102)
80" (2032)
79 1/2" (2019)
23 11/16" (576)
21 13/16" (554)
21 1/8" (537)

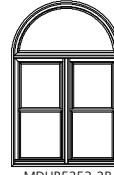

MDHB5253-2R

83 3/4" (2127)
81" (2057)
80 1/2" (2045)
23 3/16" (589)
22 5/16" (578)
21 1/8" (537)

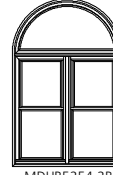

MDHB5254-2R

86 3/4" (2203)
84" (2134)
83 1/2" (2121)
23 11/16" (627)
23 13/16" (605)
21 1/8" (537)

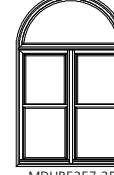

MDHB5257-2R

UNIT SIZE
ROUGH OPENING
FRAME SIZE
DAYLIGHT OPENING

54 3/4" (1391)
52" (1321)
51 1/2" (1308)
19" (483)[2]
19 7/8" (505)[2]
47 1/8" (1197)



MDHB5260-2R

89 3/4" (2280)
87" (2210)
86 1/2" (2197)
26 3/16" (665)
25 5/16" (643)
21 1/8" (537)

91 3/4" (2330)
89" (2261)
88 1/2" (2248)
27 3/16" (691)
26 9/16" (668)
21 1/8" (537)



MDHB5262-2R

94 3/4" (2407)
92" (2337)
91 1/2" (2324)
28 11/16" (729)
27 13/16" (706)
21 1/8" (537)

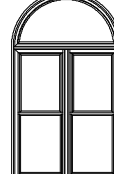

MDHB5265-2R

97 3/4" (2483)
95" (2413)
94 1/2" (2350)
29 3/16" (741)
28 5/16" (719)
21 1/8" (537)

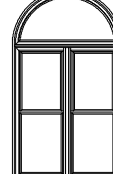

MDHB5266-2R

98 3/4" (2508)
96" (2438)
95 1/2" (2426)
30 11/16" (779)
29 13/16" (757)
21 1/8" (537)

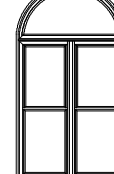

MDHB5269-2R

UNIT SIZE
ROUGH OPENING
FRAME SIZE
DAYLIGHT OPENING

54 3/4" (1391)
52" (1321)
51 1/2" (1308)
19" (483)[2]
19 7/8" (505)[2]
47 1/8" (1197)

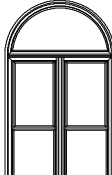

MDHB5272-2R

101 3/4" (2585)
99" (2515)
98 1/2" (2502)
32 3/16" (818)
31 5/16" (795)
21 1/8" (537)

103 3/4" (2636)
101" (2565)
100 1/2" (2553)
33 3/16" (843)
32 5/16" (821)
21 1/8" (537)



MDHB5274-2R

106 3/4" (2712)
104" (2642)
103 1/2" (2629)
34 11/16" (881)
33 13/16" (859)
21 1/8" (537)



MDHB5277-2R

109 3/4" (2788)
107" (2718)
106 1/2" (2705)
35 11/16" (911)
34 9/16" (889)
21 1/8" (537)

UNIT SIZE
ROUGH OPENING
FRAME SIZE
DAYLIGHT OPENING

58 3/4" (1492)
56" (1422)
55 1/2" (1410)
21" (533)[2]
21 7/8" (556)[2]
51 1/8" (1299)



MDHB5636-2R

67 3/4" (1721)
65" (1651)
64 1/2" (1638)
14 3/16" (360)
13 5/16" (338)
23 1/8" (587)

68 3/4" (1746)
66" (1676)
65 1/2" (1664)
14 11/16" (373)
13 13/16" (351)
23 1/8" (587)



MDHB5637-2R

69 3/4" (1771)
67" (1701)
66 1/2" (1688)
15 3/16" (386)
14 5/16" (364)
23 1/8" (587)



MDHB5638-2R

72 3/4" (1848)
70" (1778)
69 1/2" (1765)
16 11/16" (424)
15 13/16" (402)
23 1/8" (587)

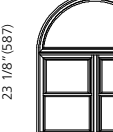

MDHB5641-2R

73 3/4" (1873)
71" (1803)
70 1/2" (1791)
17 3/16" (437)
16 5/16" (414)
23 1/8" (587)



MDHB5642-2R

ELEVATION SYMBOL LEGEND:
VALUES IN () ARE IN MILLIMETER CONVERSIONS
VALUES IN [] ARE NUMBER OF DAYLIGHT OPENINGS PER UNIT

Note: Elevations shown DO NOT have exterior trim. Subtract 1/2" (12.7) from M.O. (Masonry Opening) for Unit Sizes. Masonry Openings above include Sill Nose, see Trim Options page for Sill Nose specifications. For other Trim Options refer to the Unit Sizing, Rough Opening & Masonry Openings page.

SCALE: 1/8" = 1'

2-WIDE DOUBLE-HUNG WITH HALF ROUND

UNIT SIZE
ROUGH OPENING
FRAME SIZE
DAYLIGHT OPENING

58 3/4" (1492)
56" (1422)
55 1/2" (1410)
21" (533) [2]
21 7/8" (556) [2]
51 1/8" (1299)

79 3/4" (2026)
77" (1956)
76 1/2" (1943)
20 3/16" (513)
19 5/16" (491)
23 1/8" (587)

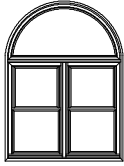

MDHB5648-2R

80 3/4" (2051)
78" (1989)
77 1/2" (1969)
20 11/16" (525)
19 13/16" (503)
23 1/8" (587)

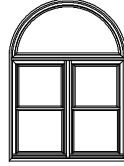

MDHB5649-2R

84 3/4" (2153)
82" (2083)
81 1/2" (2070)
22 11/16" (576)
21 13/16" (554)
23 1/8" (587)

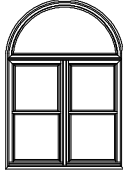

MDHB5653-2R

58 3/4" (1492)
56" (1422)
55 1/2" (1410)
21" (533) [2]
21 7/8" (556) [2]
51 1/8" (1299)

85 3/4" (2178)
83" (2108)
82 1/2" (2063)
23 3/16" (589)
22 5/16" (578)
23 1/8" (587)

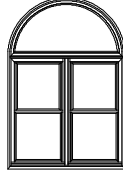

MDHB5654-2R

58 3/4" (1492)
56" (1422)
55 1/2" (1410)
21" (533) [2]
21 7/8" (556) [2]
51 1/8" (1299)

88 3/4" (2254)
86" (2184)
85 1/2" (2171)
24 11/16" (627)
23 13/16" (605)
23 1/8" (587)

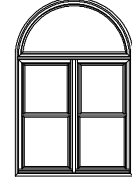

MDHB5657-2R

UNIT SIZE
ROUGH OPENING
FRAME SIZE
DAYLIGHT OPENING

58 3/4" (1492)
56" (1422)
55 1/2" (1410)
21" (533) [2]
21 7/8" (556) [2]
51 1/8" (1299)

91 3/4" (2330)
89" (2261)
88 1/2" (2248)
26 3/16" (665)
25 5/16" (643)
23 1/8" (587)

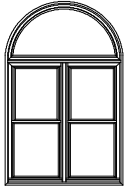

MDHB5660-2R

93 3/4" (2381)
91" (2311)
90 1/2" (2299)
27 3/16" (691)
26 5/16" (668)
23 1/8" (587)

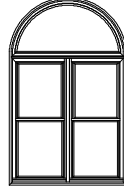

MDHB5662-2R

96 3/4" (2457)
94" (2388)
93 1/2" (2380)
28 11/16" (729)
27 13/16" (706)
23 1/8" (587)

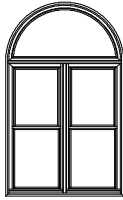

MDHB5665-2R

58 3/4" (1492)
56" (1422)
55 1/2" (1410)
21" (533) [2]
21 7/8" (556) [2]
51 1/8" (1299)

97 3/4" (2483)
95" (2414)
94 1/2" (2400)
29 3/16" (741)
28 5/16" (719)
23 1/8" (587)



MDHB5666-2R

58 3/4" (1492)
56" (1422)
55 1/2" (1410)
21" (533) [2]
21 7/8" (556) [2]
51 1/8" (1299)

100 3/4" (2559)
98" (2489)
97 1/2" (2477)
30 11/16" (779)
29 13/16" (757)
23 1/8" (587)

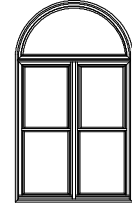

MDHB5669-2R

UNIT SIZE
ROUGH OPENING
FRAME SIZE
DAYLIGHT OPENING

58 3/4" (1492)
56" (1422)
55 1/2" (1410)
21" (533) [2]
21 7/8" (556) [2]
51 1/8" (1299)

103 3/4" (2636)
101" (2565)
100 1/2" (2553)
32 3/16" (818)
31 5/16" (795)
23 1/8" (587)

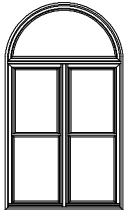

MDHB5672-2R

105 3/4" (2687)
103 3/4" (2650)
102 1/2" (2634)
33 3/16" (843)
32 5/16" (821)
23 1/8" (587)

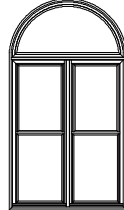

MDHB5674-2R

108 3/4" (2763)
106" (2692)
105 1/2" (2680)
34 11/16" (881)
33 13/16" (859)
23 1/8" (587)

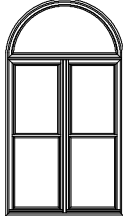

MDHB5677-2R

58 3/4" (1492)
56" (1422)
55 1/2" (1410)
21" (533) [2]
21 7/8" (556) [2]
51 1/8" (1299)

UNIT SIZE
ROUGH OPENING
FRAME SIZE
DAYLIGHT OPENING

62 3/4" (1594)
60" (1524)
59 1/2" (1511)
23" (584) [2]
23 7/8" (607) [2]
55 1/8" (1400)

69 3/4" (1772)
67" (1702)
66 1/2" (1689)
14 3/16" (360)
13 5/16" (338)
25 1/8" (638)

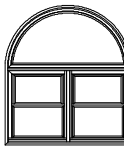

MDHB6036-2R

70 3/4" (1797)
68" (1727)
67 1/2" (1715)
14 11/16" (373)
13 13/16" (351)
25 1/8" (638)



MDHB6037-2R

71 3/4" (1822)
69" (1753)
68 1/2" (1740)
15 3/16" (386)
14 5/16" (364)
25 1/8" (638)



MDHB6038-2R

62 3/4" (1594)
60" (1524)
59 1/2" (1511)
23" (584) [2]
23 7/8" (607) [2]
55 1/8" (1400)

74 3/4" (1899)
72" (1829)
71 1/2" (1816)
16 11/16" (421)
15 13/16" (402)
25 1/8" (638)



MDHB6041-2R

62 3/4" (1594)
60" (1524)
59 1/2" (1511)
23" (584) [2]
23 7/8" (607) [2]
55 1/8" (1400)

ELEVATION SYMBOL LEGEND:
VALUES IN () ARE IN MILLIMETER CONVERSIONS
VALUES IN [] ARE NUMBER OF DAYLIGHT OPENINGS PER UNIT

Note: Elevations shown DO NOT have exterior trim. Subtract 1/2" (12.7) from M.O. (Masonry Opening) for Unit Sizes. Masonry Openings above include Sill Nose, see Trim Options page for Sill Nose specifications. For other Trim Options refer to the Unit Sizing, Rough Opening & Masonry Openings page.

SCALE: 1/8" = 1'

2-WIDE DOUBLE-HUNG WITH HALF ROUND

UNIT SIZE
ROUGH OPENING
FRAME SIZE
DAYLIGHT OPENING

62 3/4" (1594)
60" (1524)
59 1/2" (1511)
23" (584)[2]
23 7/8" (607)[2]
55 1/8" (1400)

75 3/4" (1924)
73" (1854)
72 1/2" (1842)
17 3/16" (437)
16 5/16" (414)
25 1/8" (638)

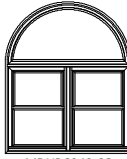

MDHB6042-2R

62 3/4" (1594)
60" (1524)
59 1/2" (1511)
23" (584)[2]
23 7/8" (607)[2]
55 1/8" (1400)

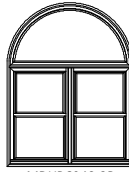

MDHB6048-2R

62 3/4" (1594)
60" (1524)
59 1/2" (1511)
23" (584)[2]
23 7/8" (607)[2]
55 1/8" (1400)

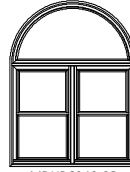

MDHB6049-2R

62 3/4" (1594)
60" (1524)
59 1/2" (1511)
23" (584)[2]
23 7/8" (607)[2]
55 1/8" (1400)



MDHB6053-2R

UNIT SIZE
ROUGH OPENING
FRAME SIZE
DAYLIGHT OPENING

62 3/4" (1594)
60" (1524)
59 1/2" (1511)
23" (584)[2]
23 7/8" (607)[2]
55 1/8" (1400)

87 3/4" (2229)
85" (2159)
84 1/2" (2146)
23 3/16" (589)
22 5/16" (578)
25 1/8" (638)

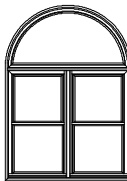

MDHB6054-2R

62 3/4" (1594)
60" (1524)
59 1/2" (1511)
23" (584)[2]
23 7/8" (607)[2]
55 1/8" (1400)

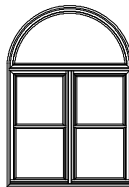

MDHB6057-2R

62 3/4" (1594)
60" (1524)
59 1/2" (1511)
23" (584)[2]
23 7/8" (607)[2]
55 1/8" (1400)

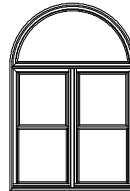

MDHB6060-2R

62 3/4" (1594)
60" (1524)
59 1/2" (1511)
23" (584)[2]
23 7/8" (607)[2]
55 1/8" (1400)

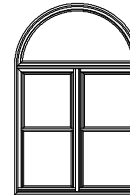

MDHB6062-2R

UNIT SIZE
ROUGH OPENING
FRAME SIZE
DAYLIGHT OPENING

62 3/4" (1594)
60" (1524)
59 1/2" (1511)
23" (584)[2]
23 7/8" (607)[2]
55 1/8" (1400)

98 3/4" (2508)
96" (2438)
95 1/2" (2426)
28 11/16" (729)
27 13/16" (706)
25 1/8" (638)

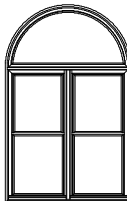

MDHB6065-2R

62 3/4" (1594)
60" (1524)
59 1/2" (1511)
23" (584)[2]
23 7/8" (607)[2]
55 1/8" (1400)

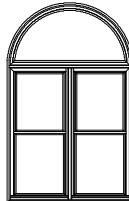

MDHB6066-2R

62 3/4" (1594)
60" (1524)
59 1/2" (1511)
23" (584)[2]
23 7/8" (607)[2]
55 1/8" (1400)

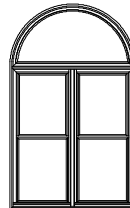

MDHB6069-2R

62 3/4" (1594)
60" (1524)
59 1/2" (1511)
23" (584)[2]
23 7/8" (607)[2]
55 1/8" (1400)

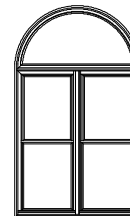

MDHB6072-2R

UNIT SIZE
ROUGH OPENING
FRAME SIZE
DAYLIGHT OPENING

62 3/4" (1594)
60" (1524)
59 1/2" (1511)
23" (584)[2]
23 7/8" (607)[2]
55 1/8" (1400)

107 3/4" (2738)
105" (2667)
104 1/2" (2654)
33 3/16" (843)
32 5/16" (821)
25 1/8" (638)

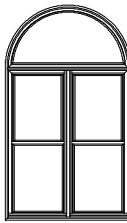

MDHB6074-2R

62 3/4" (1594)
60" (1524)
59 1/2" (1511)
23" (584)[2]
23 7/8" (607)[2]
55 1/8" (1400)

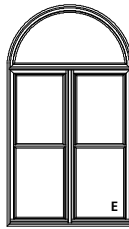

MDHB6077-2R

82 3/4" (2102)
80" (2032)
79 1/2" (2019)
20 3/16" (513)
19 5/16" (491)
25 1/8" (638)

93 3/4" (2381)
91" (2311)
90 1/2" (2298)
26 3/16" (663)
25 5/16" (641)
25 1/8" (638)

102 3/4" (2610)
100" (2540)
99 1/2" (2527)
30 1/16" (767)
29 13/16" (757)
25 1/8" (638)

86 3/4" (2203)
84" (2134)
83 1/2" (2121)
22 11/16" (576)
21 13/16" (554)
25 1/8" (638)

97 3/4" (2483)
95" (2413)
94 1/2" (2400)
27 3/16" (691)
26 5/16" (668)
25 1/8" (638)

105 3/4" (2687)
103" (2616)
102 1/2" (2604)
32 3/16" (818)
31 5/16" (795)
25 1/8" (638)

ELEVATION SYMBOL LEGEND:
VALUES IN () ARE IN MILLIMETER CONVERSIONS
VALUES IN [] ARE NUMBER OF DAYLIGHT OPENINGS PER UNIT

E BASIC UNIT CLEAR OPENING EXCEEDS 20" IN WIDTH, 24" IN HEIGHT & A MINIMUM OF 5.7 SQ. FT.

Note: Elevations shown DO NOT have exterior trim. Subtract 1/2" (12.7) from M.O. (Masonry Opening) for Unit Sizes. Masonry Openings above include Sill Nose, see Trim Options page for Sill Nose specifications. For other Trim Options refer to the Unit Sizing, Rough Opening & Masonry Openings page.

SCALE: 1/8" = 1'

2-WIDE DOUBLE-HUNG WITH HALF ROUND

UNIT SIZE
ROUGH OPENING
FRAME SIZE
DAYLIGHT OPENING

66 3/4" (1695)
64" (1626)
63 1/2" (1359)
25" (635) [2]
25 7/8" (657) [2]
59 1/8" (1502)

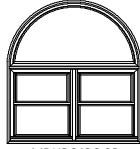

MDHB6436-2R

71 3/4" (1822)
69" (1753)
68 1/2" (1740)
14 3/16" (360)
13 5/16" (338)
27 1/8" (689)

72 3/4" (1848)
70" (1778)
69 1/2" (1765)
14 1/16" (373)
13 1/16" (351)
27 1/8" (689)

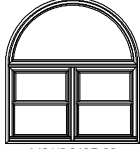

MDHB6437-2R

73 3/4" (1873)
71" (1803)
70 1/2" (1791)
15 3/16" (386)
14 5/16" (364)
27 1/8" (689)

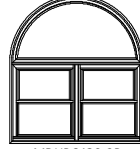

MDHB6438-2R

76 3/4" (1949)
74" (1880)
73 1/2" (1867)
16 1/16" (424)
15 13/16" (402)
27 1/8" (689)

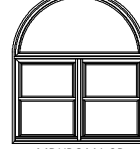

MDHB6441-2R

UNIT SIZE
ROUGH OPENING
FRAME SIZE
DAYLIGHT OPENING

66 3/4" (1695)
64" (1626)
63 1/2" (1359)
25" (635) [2]
25 7/8" (657) [2]
59 1/8" (1502)

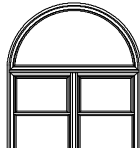

MDHB6442-2R

77 3/4" (1975)
75" (1905)
74 1/2" (1892)
17 3/16" (437)
16 5/16" (414)
27 1/8" (689)

83 3/4" (2127)
81" (2057)
80 1/2" (2045)
20 3/16" (513)
19 5/16" (491)
27 1/8" (689)

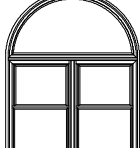

MDHB6448-2R

84 3/4" (2153)
82" (2083)
81 1/2" (2070)
20 11/16" (525)
19 13/16" (503)
27 1/8" (689)

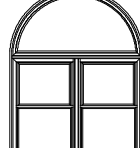

MDHB6449-2R

88 3/4" (2254)
86" (2184)
85 1/2" (2172)
21 1/16" (530)
21 13/16" (554)
27 1/8" (689)

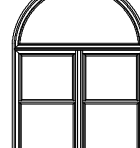

MDHB6453-2R

UNIT SIZE
ROUGH OPENING
FRAME SIZE
DAYLIGHT OPENING

66 3/4" (1695)
64" (1626)
63 1/2" (1359)
25" (635) [2]
25 7/8" (657) [2]
59 1/8" (1502)

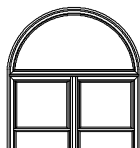

MDHB6454-2R

89 3/4" (2280)
87" (2210)
86 1/2" (2197)
23 3/16" (589)
22 5/16" (578)
27 1/8" (689)

92 3/4" (2356)
90" (2286)
89 1/2" (2273)
24 11/16" (627)
23 13/16" (605)
27 1/8" (689)

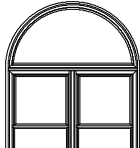

MDHB6457-2R

97 3/4" (2483)
95" (2413)
94 1/2" (2400)
26 3/16" (665)
25 5/16" (643)
27 1/8" (689)

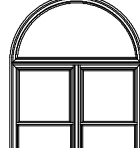

MDHB6460-2R

97 3/4" (2483)
95" (2413)
94 1/2" (2400)
27 3/16" (691)
26 5/16" (668)
27 1/8" (689)

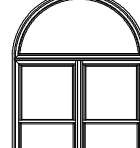

MDHB6462-2R

UNIT SIZE
ROUGH OPENING
FRAME SIZE
DAYLIGHT OPENING

66 3/4" (1695)
64" (1626)
63 1/2" (1359)
25" (635) [2]
25 7/8" (657) [2]
59 1/8" (1502)

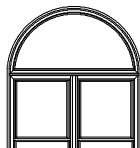

MDHB6465-2R

100 3/4" (2559)
98" (2489)
97 1/2" (2477)
28 11/16" (729)
27 13/16" (706)
27 1/8" (689)

101 3/4" (2585)
99" (2515)
98 1/2" (2502)
29 3/16" (741)
28 5/16" (719)
27 1/8" (689)

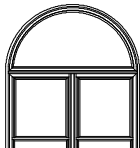

MDHB6466-2R

104 3/4" (2661)
102" (2591)
101 1/2" (2578)
30 11/16" (779)
29 13/16" (757)
27 1/8" (689)

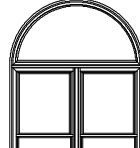

MDHB6469-2R

107 3/4" (2738)
105" (2667)
104 1/2" (2654)
32 3/16" (831)
31 5/16" (795)
27 1/8" (689)

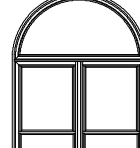

MDHB6472-2R

ELEVATION SYMBOL LEGEND:

VALUES IN () ARE IN MILLIMETER CONVERSIONS
VALUES IN [] ARE NUMBER OF DAYLIGHT OPENINGS PER UNIT

E BASIC UNIT CLEAR OPENING EXCEEDS 20" IN WIDTH, 24" IN HEIGHT & A MINIMUM OF 5.7 SQ. FT.

Note: Elevations shown DO NOT have exterior trim. Subtract 1/2" (12.7) from M.O. (Masonry Opening) for Unit Sizing. Masonry Openings above include Sill Nose, see Trim Options page for Sill Nose specifications. For other Trim Options refer to the Unit Sizing, Rough Opening & Masonry Openings page.

SCALE: 1/8" = 1'

2-WIDE DOUBLE-HUNG WITH HALF ROUND

UNIT SIZE
ROUGH OPENING
FRAME SIZE
DAYLIGHT OPENING

66 3/4" (1695)
64" (1626)
63 1/2" (1359)
25" (635)[2]
25 7/8" (657)[2]
59 1/8" (1502)

66 3/4" (1695)
64" (1626)
63 1/2" (1359)
25" (635)[2]
25 7/8" (657)[2]
59 1/8" (1502)

109 3/4" (2788)
107 1/2" (2719)
105 1/2" (2681)
33 3/16" (843)
32 5/16" (821)
27 1/8" (689)

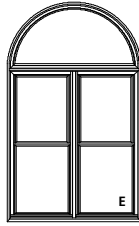

MDHB6474-2R

112 3/4" (2865)
110" (2794)
109 1/2" (2781)
34 11/16" (881)
33 13/16" (859)
27 1/8" (689)

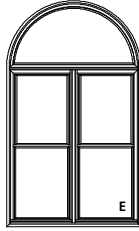

MDHB6477-2R

UNIT SIZE
ROUGH OPENING
FRAME SIZE
DAYLIGHT OPENING

70 3/4" (1797)
68" (1727)
67 1/2" (1715)
27" (686)[2]
27 7/8" (708)[2]
63 1/8" (1603)

70 3/4" (1797)
68" (1727)
67 1/2" (1715)
27" (686)[2]
27 7/8" (708)[2]
63 1/8" (1603)

70 3/4" (1797)
68" (1727)
67 1/2" (1715)
27" (686)[2]
27 7/8" (708)[2]
63 1/8" (1603)

70 3/4" (1797)
68" (1727)
67 1/2" (1715)
27" (686)[2]
27 7/8" (708)[2]
63 1/8" (1603)

73 3/4" (1873)
71 (1803)
70 1/2" (1773)
14 3/16" (360)
13 5/16" (338)
29 1/8" (740)

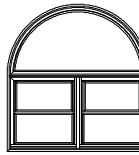

MDHB6836-2R

74 3/4" (1899)
72" (1829)
71 1/2" (1861)
14 11/16" (373)
13 13/16" (351)
29 1/8" (740)

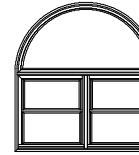

MDHB6837-2R

75 3/4" (1924)
73" (1854)
72 1/2" (1842)
15 3/16" (386)
14 5/16" (364)
29 1/8" (740)

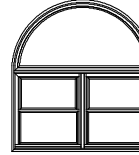

MDHB6838-2R

78 3/4" (2000)
76" (1930)
75 1/2" (1918)
16 11/16" (424)
15 13/16" (402)
29 1/8" (740)

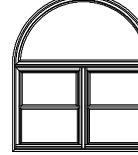

MDHB6841-2R

UNIT SIZE
ROUGH OPENING
FRAME SIZE
DAYLIGHT OPENING

70 3/4" (1797)
68" (1727)
67 1/2" (1715)
27" (686)[2]
27 7/8" (708)[2]
63 1/8" (1603)

70 3/4" (1797)
68" (1727)
67 1/2" (1715)
27" (686)[2]
27 7/8" (708)[2]
63 1/8" (1603)

70 3/4" (1797)
68" (1727)
67 1/2" (1715)
27" (686)[2]
27 7/8" (708)[2]
63 1/8" (1603)

70 3/4" (1797)
68" (1727)
67 1/2" (1715)
27" (686)[2]
27 7/8" (708)[2]
63 1/8" (1603)

79 3/4" (2026)
77 (1956)
76 1/2" (1926)
19 3/16" (437)
16 5/16" (414)
29 1/8" (740)

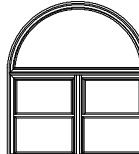

MDHB6842-2R

85 3/4" (2178)
83" (2108)
82 1/2" (2063)
20 3/16" (513)
19 5/16" (491)
29 1/8" (740)

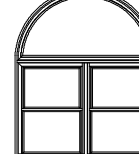

MDHB6848-2R

86 3/4" (2203)
84" (2134)
83 1/2" (2121)
20 11/16" (525)
19 13/16" (503)
29 1/8" (740)

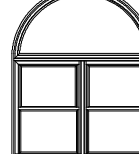

MDHB6849-2R

90 3/4" (2305)
88" (2235)
87 1/2" (2223)
22 11/16" (576)
21 13/16" (554)
29 1/8" (740)

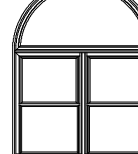

MDHB6853-2R

UNIT SIZE
ROUGH OPENING
FRAME SIZE
DAYLIGHT OPENING

70 3/4" (1797)
68" (1727)
67 1/2" (1715)
27" (686)[2]
27 7/8" (708)[2]
63 1/8" (1603)

70 3/4" (1797)
68" (1727)
67 1/2" (1715)
27" (686)[2]
27 7/8" (708)[2]
63 1/8" (1603)

70 3/4" (1797)
68" (1727)
67 1/2" (1715)
27" (686)[2]
27 7/8" (708)[2]
63 1/8" (1603)

70 3/4" (1797)
68" (1727)
67 1/2" (1715)
27" (686)[2]
27 7/8" (708)[2]
63 1/8" (1603)

91 3/4" (2330)
89" (2261)
88 1/2" (2248)
22 3/16" (567)
22 5/16" (578)
29 1/8" (740)

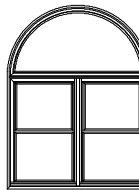

MDHB6854-2R

94 3/4" (2407)
92" (2337)
91 1/2" (2324)
24 11/16" (627)
23 13/16" (605)
29 1/8" (740)

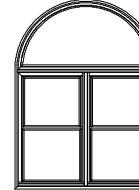

MDHB6857-2R

97 3/4" (2483)
95" (2414)
94 1/2" (2400)
26 3/16" (665)
25 5/16" (643)
29 1/8" (740)

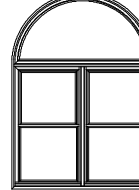

MDHB6860-2R

101 3/4" (2585)
99" (2515)
98 1/2" (2502)
27 3/16" (691)
26 5/16" (668)
29 1/8" (740)

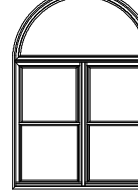

MDHB6862-2R

ELEVATION SYMBOL LEGEND:

VALUES IN () ARE IN MILLIMETER CONVERSIONS
VALUES IN [] ARE NUMBER OF DAYLIGHT OPENINGS PER UNIT

E BASIC UNIT CLEAR OPENING EXCEEDS 20" IN WIDTH, 24" IN HEIGHT & A MINIMUM OF 5.7 SQ. FT.

Note: Elevations shown DO NOT have exterior trim. Subtract 1/2" (12.7) from M.O. (Masonry Opening) for Unit Sizes. Masonry Openings above include Sill Nose, see Trim Options page for Sill Nose specifications. For other Trim Options refer to the Unit Sizing, Rough Opening & Masonry Openings page.

SCALE: 1/8" = 1'

2-WIDE DOUBLE-HUNG WITH HALF ROUND

UNIT SIZE
ROUGH OPENING
FRAME SIZE
DAYLIGHT OPENING

70 3/4" (1797)
68" (1727)
67 1/2" (1715)
27" (686)[2]
27 7/8" (708)[2]
63 1/8" (1603)

102 3/4" (2610)
100" (2540)
99 1/2" (2527)
28 11/16" (729)
27 13/16" (706)
29 1/8" (740)

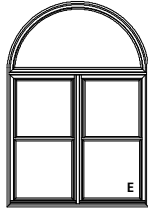

MDHB6865-2R

70 3/4" (1797)
68" (1727)
67 1/2" (1715)
27" (686)[2]
27 7/8" (708)[2]
63 1/8" (1603)

103 3/4" (2636)
101" (2565)
100 1/2" (2553)
29 3/16" (741)
28 5/16" (719)
29 1/8" (740)

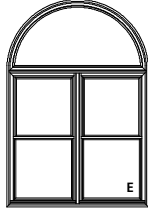

MDHB6866-2R

70 3/4" (1797)
68" (1727)
67 1/2" (1715)
27" (686)[2]
27 7/8" (708)[2]
63 1/8" (1603)

106 3/4" (2712)
104" (2642)
103 1/2" (2629)
30 11/16" (779)
29 13/16" (757)
29 1/8" (740)

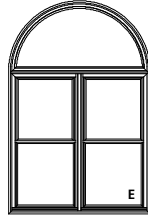

MDHB6869-2R

70 3/4" (1797)
68" (1727)
67 1/2" (1715)
27" (686)[2]
27 7/8" (708)[2]
63 1/8" (1603)

109 3/4" (2788)
107" (2718)
106 1/2" (2705)
32 3/16" (818)
31 5/16" (795)
29 1/8" (740)

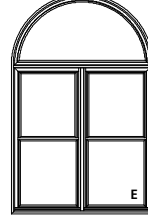

MDHB6872-2R

UNIT SIZE
ROUGH OPENING
FRAME SIZE
DAYLIGHT OPENING

70 3/4" (1797)
68" (1727)
67 1/2" (1715)
27" (686)[2]
27 7/8" (708)[2]
63 1/8" (1603)

111 3/4" (2839)
109" (2769)
108 1/2" (2756)
33 3/16" (843)
32 5/16" (821)
29 1/8" (740)

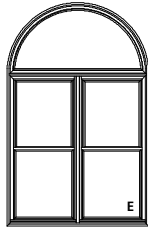

MDHB6874-2R

70 3/4" (1797)
68" (1727)
67 1/2" (1715)
27" (686)[2]
27 7/8" (708)[2]
63 1/8" (1603)

114 3/4" (2915)
112" (2849)
111 1/2" (2832)
34 11/16" (881)
33 13/16" (859)
29 1/8" (740)

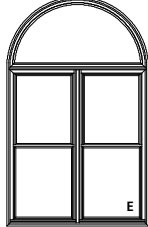

MDHB6877-2R

UNIT SIZE
ROUGH OPENING
FRAME SIZE
DAYLIGHT OPENING

74 3/4" (1899)
72" (1829)
71 1/2" (1861)
29" (737)[2]
29 7/8" (759)[2]
67 1/8" (1705)

75 3/4" (1924)
73" (1854)
72 1/2" (1842)
14 3/16" (360)
13 5/16" (338)
31 1/8" (791)

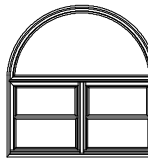

MDHB7236-2R

74 3/4" (1899)
72" (1829)
71 1/2" (1861)
29" (737)[2]
29 7/8" (759)[2]
67 1/8" (1705)

76 3/4" (1949)
74" (1880)
73 1/2" (1867)
14 11/16" (373)
13 13/16" (351)
31 1/8" (791)

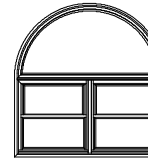

MDHB7237-2R

74 3/4" (1899)
72" (1829)
71 1/2" (1861)
29" (737)[2]
29 7/8" (759)[2]
67 1/8" (1705)

77 3/4" (1975)
75" (1905)
74 1/2" (1892)
15 3/16" (386)
14 5/16" (364)
31 1/8" (791)



MDHB7238-2R

74 3/4" (1899)
72" (1829)
71 1/2" (1861)
29" (737)[2]
29 7/8" (759)[2]
67 1/8" (1705)

80 3/4" (2051)
78" (1981)
77 1/2" (1969)
16 11/16" (424)
15 13/16" (402)
31 1/8" (791)



MDHB7241-2R

UNIT SIZE
ROUGH OPENING
FRAME SIZE
DAYLIGHT OPENING

74 3/4" (1899)
72" (1829)
71 1/2" (1861)
29" (737)[2]
29 7/8" (759)[2]
67 1/8" (1705)

81 3/4" (2076)
79" (2007)
78 1/2" (1994)
17 3/16" (437)
16 5/16" (414)
31 1/8" (791)

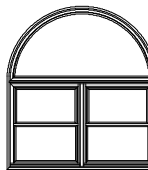

MDHB7242-2R

74 3/4" (1899)
72" (1829)
71 1/2" (1861)
29" (737)[2]
29 7/8" (759)[2]
67 1/8" (1705)

87 3/4" (2229)
85" (2159)
84 1/2" (2146)
20 3/16" (513)
19 5/16" (491)
31 1/8" (791)

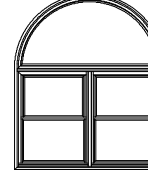

MDHB7248-2R

74 3/4" (1899)
72" (1829)
71 1/2" (1861)
29" (737)[2]
29 7/8" (759)[2]
67 1/8" (1705)

88 3/4" (2254)
86" (2184)
85 1/2" (2172)
20 11/16" (525)
19 13/16" (503)
31 1/8" (791)

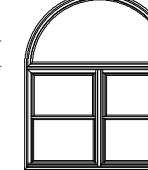

MDHB7249-2R

74 3/4" (1899)
72" (1829)
71 1/2" (1861)
29" (737)[2]
29 7/8" (759)[2]
67 1/8" (1705)

92 3/4" (2356)
90" (2286)
89 1/2" (2273)
22 11/16" (576)
21 13/16" (554)
31 1/8" (791)

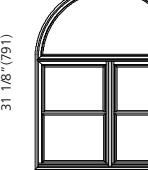

MDHB7253-2R

ELEVATION SYMBOL LEGEND:

VALUES IN () ARE IN MILLIMETER CONVERSIONS
VALUES IN [] ARE NUMBER OF DAYLIGHT OPENINGS PER UNIT

E BASIC UNIT CLEAR OPENING EXCEEDS 20" IN WIDTH, 24" IN HEIGHT & A MINIMUM OF 5.7 SQ. FT.

Note: Elevations shown DO NOT have exterior trim. Subtract 1/2" (12.7) from M.O. (Masonry Opening) for Unit Sizes. Masonry Openings above include Sill Nose, see Trim Options page for Sill Nose specifications. For other Trim Options refer to the Unit Sizing, Rough Opening & Masonry Openings page.

SCALE: 1/8" = 1'

2-WIDE DOUBLE-HUNG WITH HALF ROUND

UNIT SIZE
ROUGH OPENING
FRAME SIZE
DAYLIGHT OPENING

74 3/4" (1899)
72" (1829)
71 1/2" (1861)
29" (737)[2]
29 7/8" (759)[2]
67 1/8" (1705)

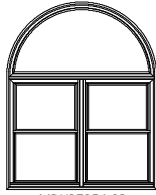

MDHB7254-2R

93 3/4" (2381)
91" (2311)
90 1/2" (2299)
23 3/16" (589)
22 5/16" (578)
31 1/8" (791)

96 3/4" (2457)
94" (2388)
93 1/2" (2380)
24 1/16" (627)
23 13/16" (605)
31 1/8" (791)

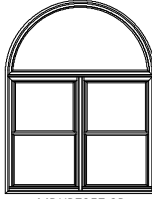

MDHB7257-2R

74 3/4" (1899)
72" (1829)
71 1/2" (1861)
29" (737)[2]
29 7/8" (759)[2]
67 1/8" (1705)

99 3/4" (2534)
97" (2464)
96 1/2" (2451)
26 3/16" (665)
25 5/16" (643)
31 1/8" (791)

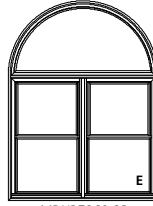

MDHB7260-2R

74 3/4" (1899)
72" (1829)
71 1/2" (1861)
29" (737)[2]
29 7/8" (759)[2]
67 1/8" (1705)

101 3/4" (2585)
99" (2515)
98 1/2" (2502)
27 3/16" (691)
26 5/16" (668)
31 1/8" (791)

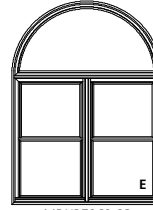

MDHB7262-2R

UNIT SIZE
ROUGH OPENING
FRAME SIZE
DAYLIGHT OPENING

74 3/4" (1899)
72" (1829)
71 1/2" (1861)
29" (737)[2]
29 7/8" (759)[2]
67 1/8" (1705)

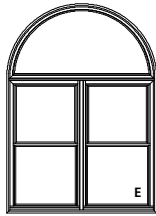

MDHB7265-2R

104 3/4" (2661)
102" (2591)
101 1/2" (2578)
28 11/16" (729)
27 13/16" (706)
31 1/8" (791)

105 3/4" (2687)
103" (2616)
102 1/2" (2604)
29 3/16" (741)
28 5/16" (719)
31 1/8" (791)

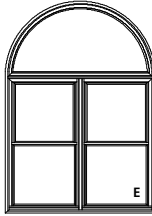

MDHB7266-2R

74 3/4" (1899)
72" (1829)
71 1/2" (1861)
29" (737)[2]
29 7/8" (759)[2]
67 1/8" (1705)

108 3/4" (2763)
106" (2692)
105 1/2" (2680)
30 1/16" (779)
29 13/16" (757)
31 1/8" (791)

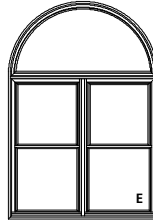

MDHB7269-2R

74 3/4" (1899)
72" (1829)
71 1/2" (1861)
29" (737)[2]
29 7/8" (759)[2]
67 1/8" (1705)

111 3/4" (2839)
109" (2769)
108 1/2" (2756)
32 3/16" (818)
31 5/16" (795)
31 1/8" (791)

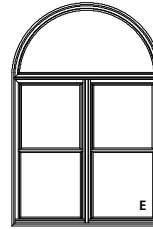

MDHB7272-2R

UNIT SIZE
ROUGH OPENING
FRAME SIZE
DAYLIGHT OPENING

74 3/4" (1899)
72" (1829)
71 1/2" (1861)
29" (737)[2]
29 7/8" (759)[2]
67 1/8" (1705)

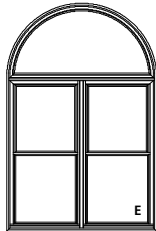

MDHB7274-2R

113 3/4" (2890)
111" (2819)
110 1/2" (2807)
33 3/16" (843)
32 5/16" (821)
31 1/8" (791)

116 3/4" (2966)
114" (2896)
113 1/2" (2883)
34 1/16" (861)
33 13/16" (859)
31 1/8" (791)

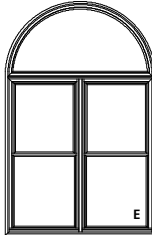

MDHB7277-2R

74 3/4" (1899)
72" (1829)
71 1/2" (1861)
29" (737)[2]
29 7/8" (759)[2]
67 1/8" (1705)

UNIT SIZE
ROUGH OPENING
FRAME SIZE
DAYLIGHT OPENING

78 3/4" (2000)
76" (1930)
75 1/2" (1918)
31" (787)[2]
31 7/8" (810)[2]
71 1/8" (1807)

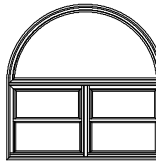

MDHB7636-2R

77 3/4" (1975)
75" (1905)
74 1/2" (1892)
14 3/16" (360)
13 5/16" (338)
33 1/8" (841)

78 3/4" (2000)
76" (1930)
75 1/2" (1918)
14 11/16" (373)
13 13/16" (351)
33 1/8" (841)

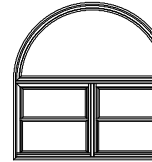

MDHB7637-2R

78 3/4" (2000)
76" (1930)
75 1/2" (1918)
31" (787)[2]
31 7/8" (810)[2]
71 1/8" (1807)

79 3/4" (2026)
77" (1956)
76 1/2" (1943)
15 3/16" (386)
14 5/16" (364)
33 1/8" (841)



MDHB7638-2R

78 3/4" (2000)
76" (1930)
75 1/2" (1918)
31" (787)[2]
31 7/8" (810)[2]
71 1/8" (1807)

82 3/4" (2102)
80" (2032)
79 1/2" (2019)
16 11/16" (424)
15 13/16" (402)
33 1/8" (841)



MDHB7641-2R

78 3/4" (2000)
76" (1930)
75 1/2" (1918)
31" (787)[2]
31 7/8" (810)[2]
71 1/8" (1807)

ELEVATION SYMBOL LEGEND:
VALUES IN () ARE IN MILLIMETER CONVERSIONS
VALUES IN [] ARE NUMBER OF DAYLIGHT OPENINGS PER UNIT

E BASIC UNIT CLEAR OPENING EXCEEDS 20" IN WIDTH, 24" IN HEIGHT & A MINIMUM OF 5.7 SQ. FT.

Note: Elevations shown DO NOT have exterior trim. Subtract 1/2" (12.7) from M.O. (Masonry Opening) for Unit Sizes. Masonry Openings above include Sill Nose, see Trim Options page for Sill Nose specifications. For other Trim Options refer to the Unit Sizing, Rough Opening & Masonry Openings page.

SCALE: 1/8" = 1'

2-WIDE DOUBLE-HUNG WITH HALF ROUND

UNIT SIZE
ROUGH OPENING
FRAME SIZE
DAYLIGHT OPENING

78 3/4" (2000)
76" (1930)
75 1/2" (1918)
31" (787)[2]
31 7/8" (810)[2]
71 1/8" (1807)

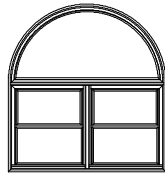

MDHB7642-2R

83 3/4" (2127)
81" (2057)
80 1/2" (2045)
17 3/16" (437)
16 5/16" (414)
33 1/8" (841)

89 3/4" (2280)
87" (2210)
86 1/2" (2197)
20 3/16" (513)
19 5/16" (491)
33 1/8" (841)

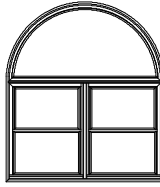

MDHB7648-2R

90 3/4" (2305)
88" (2235)
87 1/2" (2223)
20 11/16" (525)
19 13/16" (503)
33 1/8" (841)

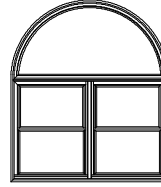

MDHB7649-2R

94 3/4" (2407)
92" (2337)
91 1/2" (2324)
22 11/16" (576)
21 13/16" (554)
33 1/8" (841)

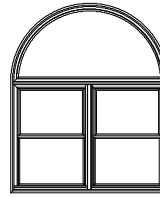

MDHB7653-2R

UNIT SIZE
ROUGH OPENING
FRAME SIZE
DAYLIGHT OPENING

78 3/4" (2000)
76" (1930)
75 1/2" (1918)
31" (787)[2]
31 7/8" (810)[2]
71 1/8" (1807)

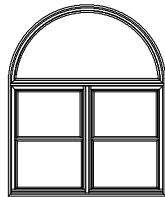

MDHB7654-2R

97 3/4" (2483)
93" (2363)
92 1/2" (2350)
23 3/16" (589)
22 5/16" (578)
33 1/8" (841)

98 3/4" (2508)
96" (2438)
95 1/2" (2426)
24 11/16" (627)
23 13/16" (605)
33 1/8" (841)

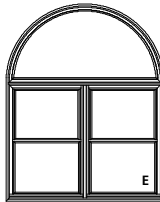

MDHB7657-2R

101 3/4" (2585)
99" (2515)
98 1/2" (2502)
26 3/16" (665)
25 5/16" (643)
33 1/8" (841)

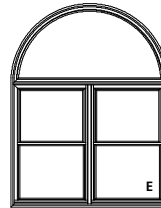

MDHB7660-2R

103 3/4" (2636)
101" (2565)
100 1/2" (2553)
27 3/16" (691)
26 5/16" (668)
33 1/8" (841)

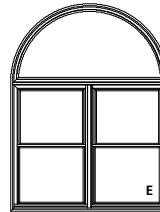

MDHB7662-2R

UNIT SIZE
ROUGH OPENING
FRAME SIZE
DAYLIGHT OPENING

78 3/4" (2000)
76" (1930)
75 1/2" (1918)
31" (787)[2]
31 7/8" (810)[2]
71 1/8" (1807)

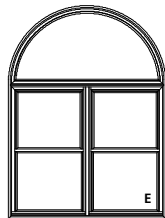

MDHB7665-2R

106 3/4" (2712)
104" (2642)
103 1/2" (2629)
28 11/16" (729)
27 13/16" (706)
33 1/8" (841)

107 3/4" (2738)
105" (2667)
104 1/2" (2654)
29 3/16" (741)
28 5/16" (719)
33 1/8" (841)

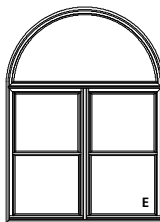

MDHB7666-2R

110 3/4" (2814)
108" (2743)
107 1/2" (2731)
30 11/16" (779)
29 13/16" (757)
33 1/8" (841)

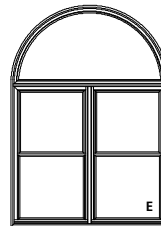

MDHB7669-2R

113 3/4" (2890)
111" (2819)
110 1/2" (2807)
32 3/16" (818)
31 5/16" (795)
33 1/8" (841)

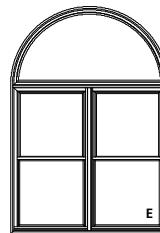

MDHB7672-2R

UNIT SIZE
ROUGH OPENING
FRAME SIZE
DAYLIGHT OPENING

78 3/4" (2000)
76" (1930)
75 1/2" (1918)
31" (787)[2]
31 7/8" (810)[2]
71 1/8" (1807)

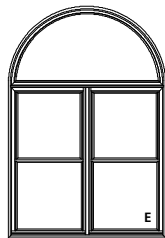

MDHB7674-2R

115 3/4" (2940)
113" (2870)
112 1/2" (2858)
33 3/16" (843)
32 5/16" (821)
33 1/8" (841)

118 3/4" (3016)
116" (2946)
115 1/2" (2934)
34 11/16" (881)
33 13/16" (859)
33 1/8" (841)

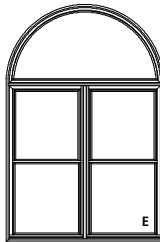

MDHB7677-2R

ELEVATION SYMBOL LEGEND:

VALUES IN () ARE IN MILLIMETER CONVERSIONS
VALUES IN [] ARE NUMBER OF DAYLIGHT OPENINGS PER UNIT

E BASIC UNIT CLEAR OPENING EXCEEDS 20" IN WIDTH, 24" IN HEIGHT & A MINIMUM OF 5.7 SQ. FT.

Note: Elevations shown DO NOT have exterior trim. Subtract 1/2" (12.7) from M.O. (Masonry Opening) for Unit Sizes. Masonry Openings above include Sill Nose, see Trim Options page for Sill Nose specifications. For other Trim Options refer to the Unit Sizing, Rough Opening & Masonry Openings page.

SCALE: 1/8" = 1'

2-WIDE DOUBLE-HUNG WITH HALF ROUND

UNIT SIZE
ROUGH OPENING
FRAME SIZE
DAYLIGHT OPENING

86 3/4" (2203)
84" (2134)
83 1/2" (2121)
35" (889)[2]
35 7/8" (911)[2]
79 1/8" (2010)

81 3/4" (2076)
79" (2007)
78 1/2" (1994)
14 3/16" (360)
13 5/16" (338)
37 1/8" (943)

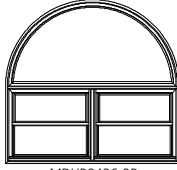

MDHB8436-2R

UNIT SIZE
ROUGH OPENING
FRAME SIZE
DAYLIGHT OPENING

86 3/4" (2203)
84" (2134)
83 1/2" (2121)
35" (889)[2]
35 7/8" (911)[2]
79 1/8" (2010)

87 3/4" (2229)
85" (2159)
84 1/2" (2146)
17 3/16" (437)
16 5/16" (414)
37 1/8" (943)

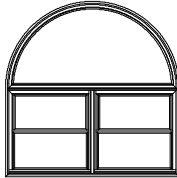

MDHB8442-2R

UNIT SIZE
ROUGH OPENING
FRAME SIZE
DAYLIGHT OPENING

86 3/4" (2203)
84" (2134)
83 1/2" (2121)
35" (889)[2]
35 7/8" (911)[2]
79 1/8" (2010)

99 3/4" (2534)
97" (2464)
96 1/2" (2451)
23 3/16" (589)
22 5/16" (578)
37 1/8" (943)

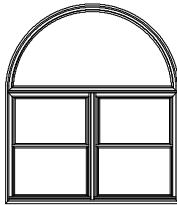

MDHB8454-2R

UNIT SIZE
ROUGH OPENING
FRAME SIZE
DAYLIGHT OPENING

86 3/4" (2203)
84" (2134)
83 1/2" (2121)
35" (889)[2]
35 7/8" (911)[2]
79 1/8" (2010)

110 3/4" (2814)
108" (2743)
107 1/2" (2731)
28 11/16" (729)
27 13/16" (706)
37 1/8" (943)

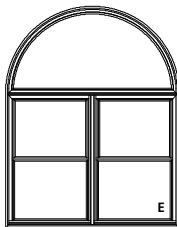

MDHB8465-2R

82 3/4" (2102)
80" (2032)
79 1/2" (2019)
14 11/16" (373)
13 13/16" (351)
37 1/8" (943)

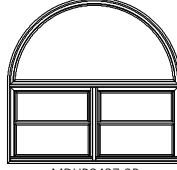

MDHB8437-2R

93 3/4" (2381)
91" (2311)
90 1/2" (2299)
20 3/16" (513)
19 5/16" (491)
37 1/8" (943)

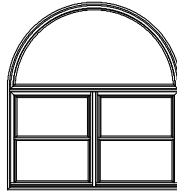

MDHB8448-2R

102 3/4" (2610)
100" (2540)
99 1/2" (2527)
24 11/16" (627)
23 13/16" (605)
37 1/8" (943)

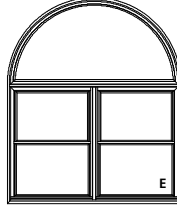

MDHB8457-2R

111 3/4" (2839)
109" (2769)
108 1/2" (2756)
29 3/16" (741)
28 5/16" (719)
37 1/8" (943)

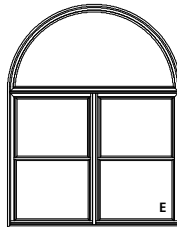

MDHB8466-2R

83 3/4" (2127)
81" (2057)
80 1/2" (2045)
15 3/16" (386)
14 5/16" (364)
37 1/8" (943)

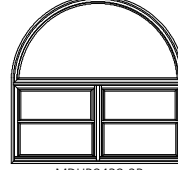

MDHB8438-2R

94 3/4" (2407)
92" (2337)
91 1/2" (2324)
20 11/16" (525)
19 13/16" (503)
37 1/8" (943)

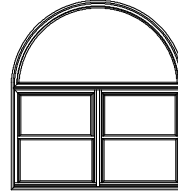

MDHB8449-2R

105 3/4" (2687)
103" (2617)
102 1/2" (2604)
26 3/16" (665)
25 5/16" (643)
37 1/8" (943)

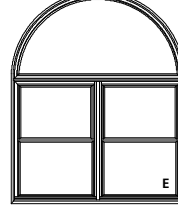

MDHB8460-2R

114 3/4" (2915)
112" (2845)
111 1/2" (2832)
30 11/16" (779)
29 13/16" (757)
37 1/8" (943)

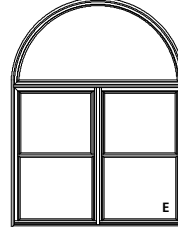

MDHB8469-2R

86 3/4" (2203)
84" (2134)
83 1/2" (2121)
35" (889)[2]
35 7/8" (911)[2]
79 1/8" (2010)

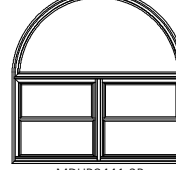

MDHB8441-2R

98 3/4" (2508)
96" (2438)
95 1/2" (2426)
22 11/16" (576)
21 13/16" (554)
37 1/8" (943)

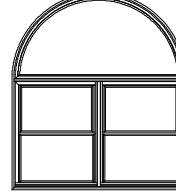

MDHB8453-2R

107 3/4" (2738)
105" (2667)
104 1/2" (2654)
27 3/16" (691)
26 5/16" (668)
37 1/8" (943)

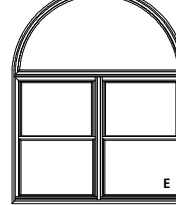

MDHB8462-2R

117 3/4" (2990)
115" (2921)
114 1/2" (2908)
32 3/16" (818)
31 5/16" (795)
37 1/8" (943)

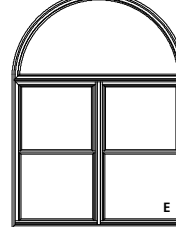

MDHB8472-2R

ELEVATION SYMBOL LEGEND:

VALUES IN () ARE IN MILLIMETER CONVERSIONS
VALUES IN [] ARE NUMBER OF DAYLIGHT OPENINGS PER UNIT

E BASIC UNIT CLEAR OPENING EXCEEDS 20" IN WIDTH, 24" IN HEIGHT & A MINIMUM OF 5.7 SQ. FT.

Note: Elevations shown DO NOT have exterior trim. Subtract 1/2" (12.7) from M.O. (Masonry Opening) for Unit Sizes. Masonry Openings above include Sill Nose, see Trim Options page for Sill Nose specifications. For other Trim Options refer to the Unit Sizing, Rough Opening & Masonry Openings page.

SCALE: 1/8" = 1'

2-WIDE DOUBLE-HUNG WITH HALF ROUND

UNIT SIZE
ROUGH OPENING
FRAME SIZE
DAYLIGHT OPENING

86 3/4" (2203)
84" (2134)
83 1/2" (2121)
35" (889)[2]
35 7/8" (911)[2]
79 1/8" (2010)

86 3/4" (2203)
84" (2134)
83 1/2" (2121)
35" (889)[2]
35 7/8" (911)[2]
79 1/8" (2010)

119 3/4" (3042)
117" (2972)
116 1/2" (2959)
33 3/16" (843)
32 5/16" (821)
37 1/8" (943)

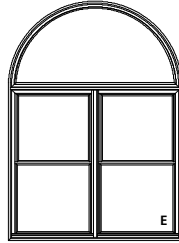

MDHB8474-2R

122 3/4" (3118)
120" (3048)
119 1/2" (3035)
34 11/16" (881)
33 13/16" (859)
37 1/8" (943)

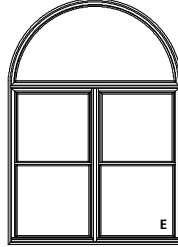

MDHB8477-2R

UNIT SIZE
ROUGH OPENING
FRAME SIZE
DAYLIGHT OPENING

98 3/4" (2508)
96" (2438)
95 1/2" (2426)
41" (1041)[2]
41 7/8" (1064)[2]
91 1/8" (2315)

98 3/4" (2508)
96" (2438)
95 1/2" (2426)
41" (1041)[2]
41 7/8" (1064)[2]
91 1/8" (2315)

98 3/4" (2508)
96" (2438)
95 1/2" (2426)
41" (1041)[2]
41 7/8" (1064)[2]
91 1/8" (2315)

87 3/4" (2229)
85" (2159)
84 1/2" (2146)
14 3/16" (360)
13 5/16" (338)
43 1/8" (1095)

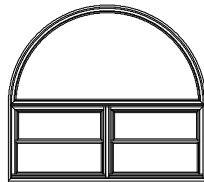

MDHB9636-2R

88 3/4" (2254)
86" (2184)
85 1/2" (2172)
14 11/16" (373)
13 13/16" (351)
43 1/8" (1095)

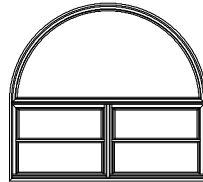

MDHB9637-2R

89 3/4" (2280)
87" (2210)
86 1/2" (2197)
15 3/16" (386)
14 5/16" (364)
43 1/8" (1095)

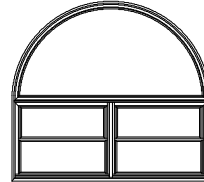

MDHB9638-2R

UNIT SIZE
ROUGH OPENING
FRAME SIZE
DAYLIGHT OPENING

98 3/4" (2508)
96" (2438)
95 1/2" (2426)
41" (1041)[2]
41 7/8" (1064)[2]
91 1/8" (2315)

98 3/4" (2508)
96" (2438)
95 1/2" (2426)
41" (1041)[2]
41 7/8" (1064)[2]
91 1/8" (2315)

98 3/4" (2508)
96" (2438)
95 1/2" (2426)
41" (1041)[2]
41 7/8" (1064)[2]
91 1/8" (2315)

92 3/4" (2356)
90" (2286)
89 1/2" (2273)
16 11/16" (424)
15 13/16" (402)
43 1/8" (1095)

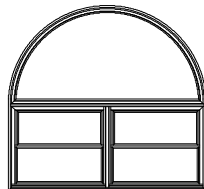

MDHB9641-2R

93 3/4" (2381)
91" (2311)
90 1/2" (2299)
17 3/16" (437)
16 5/16" (414)
43 1/8" (1095)

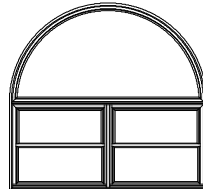

MDHB9642-2R

99 3/4" (2534)
97" (2464)
96 1/2" (2451)
20 3/16" (513)
19 5/16" (491)
43 1/8" (1095)

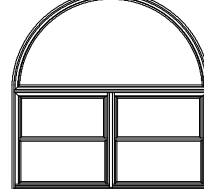

MDHB9648-2R

UNIT SIZE
ROUGH OPENING
FRAME SIZE
DAYLIGHT OPENING

98 3/4" (2508)
96" (2438)
95 1/2" (2426)
41" (1041)[2]
41 7/8" (1064)[2]
91 1/8" (2315)

98 3/4" (2508)
96" (2438)
95 1/2" (2426)
41" (1041)[2]
41 7/8" (1064)[2]
91 1/8" (2315)

98 3/4" (2508)
96" (2438)
95 1/2" (2426)
41" (1041)[2]
41 7/8" (1064)[2]
91 1/8" (2315)

100 3/4" (2559)
98" (2489)
97 1/2" (2477)
20 11/16" (525)
19 13/16" (503)
43 1/8" (1095)

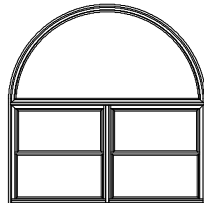

MDHB9649-2R

104 3/4" (2661)
102" (2591)
101 1/2" (2578)
22 11/16" (576)
21 13/16" (554)
43 1/8" (1095)

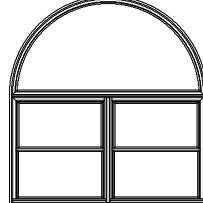

MDHB9653-2R

105 3/4" (2687)
103" (2617)
102 1/2" (2604)
23 3/16" (589)
22 5/16" (578)
43 1/8" (1095)

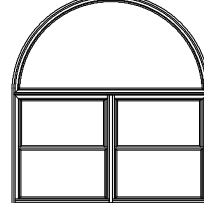

MDHB9654-2R

ELEVATION SYMBOL LEGEND:

VALUES IN () ARE IN MILLIMETER CONVERSIONS
VALUES IN [] ARE NUMBER OF DAYLIGHT OPENINGS PER UNIT

E BASIC UNIT CLEAR OPENING EXCEEDS 20" IN WIDTH, 24" IN HEIGHT & A MINIMUM OF 5.7 SQ. FT.

Note: Elevations shown DO NOT have exterior trim. Subtract 1/2" (12.7) from M.O. (Masonry Opening) for Unit Sizes. Masonry Openings above include Sill Nose, see Trim Options page for Sill Nose specifications. For other Trim Options refer to the Unit Sizing, Rough Opening & Masonry Openings page.

SCALE: 1/8" = 1'

2-WIDE DOUBLE-HUNG WITH HALF ROUND

UNIT SIZE
ROUGH OPENING
FRAME SIZE
DAYLIGHT OPENING

98 3/4" (2508)
96" (2438)
95 1/2" (2426)
41" (1041)[2]
41 7/8" (1064)[2]
91 1/8" (2315)

108 3/4" (2763)
106" (2669)
105 1/2" (2680)
24 11/16" (627)
23 13/16" (605)
43 1/8" (1095)

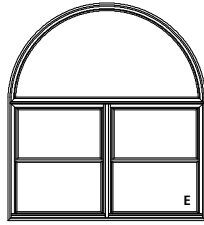

MDHB9657-2R

98 3/4" (2508)
96" (2438)
95 1/2" (2426)
41" (1041)[2]
41 7/8" (1064)[2]
91 1/8" (2315)

111 3/4" (2839)
109" (2769)
108 1/2" (2756)
26 3/16" (665)
25 5/16" (643)
43 1/8" (1095)

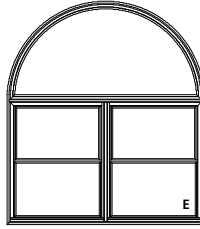

MDHB9660-2R

98 3/4" (2508)
96" (2438)
95 1/2" (2426)
41" (1041)[2]
41 7/8" (1064)[2]
91 1/8" (2315)

113 3/4" (2890)
111" (2819)
110 1/2" (2807)
27 3/16" (691)
26 5/16" (668)
43 1/8" (1095)

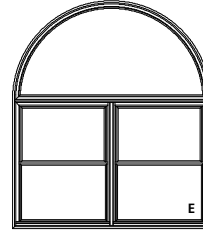

MDHB9662-2R

UNIT SIZE
ROUGH OPENING
FRAME SIZE
DAYLIGHT OPENING

98 3/4" (2508)
96" (2438)
95 1/2" (2426)
41" (1041)[2]
41 7/8" (1064)[2]
91 1/8" (2315)

116 3/4" (2965)
114" (2895)
113 1/2" (2883)
28 11/16" (729)
27 13/16" (706)
43 1/8" (1095)

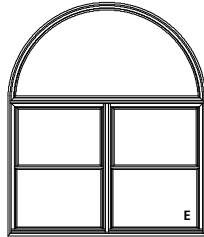

MDHB9665-2R

98 3/4" (2508)
96" (2438)
95 1/2" (2426)
41" (1041)[2]
41 7/8" (1064)[2]
91 1/8" (2315)

117 3/4" (2990)
115" (2921)
114 1/2" (2908)
29 3/16" (741)
28 5/16" (719)
43 1/8" (1095)

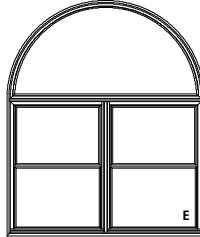

MDHB9666-2R

98 3/4" (2508)
96" (2438)
95 1/2" (2426)
41" (1041)[2]
41 7/8" (1064)[2]
91 1/8" (2315)

120 3/4" (3067)
118" (2997)
117 1/2" (2985)
30 11/16" (779)
29 13/16" (757)
43 1/8" (1095)

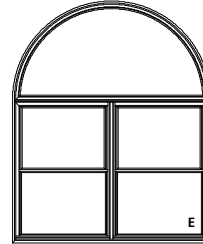

MDHB9669-2R

UNIT SIZE
ROUGH OPENING
FRAME SIZE
DAYLIGHT OPENING

98 3/4" (2508)
96" (2438)
95 1/2" (2426)
41" (1041)[2]
41 7/8" (1064)[2]
91 1/8" (2315)

123 3/4" (3143)
121" (3073)
120 1/2" (3061)
32 3/16" (818)
31 5/16" (795)
43 1/8" (1095)

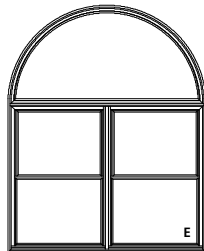

MDHB9672-2R

98 3/4" (2508)
96" (2438)
95 1/2" (2426)
41" (1041)[2]
41 7/8" (1064)[2]
91 1/8" (2315)

125 3/4" (3194)
123" (3124)
122 1/2" (3112)
33 3/16" (843)
32 5/16" (821)
43 1/8" (1095)

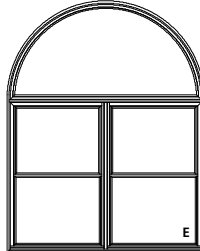

MDHB9674-2R

98 3/4" (2508)
96" (2438)
95 1/2" (2426)
41" (1041)[2]
41 7/8" (1064)[2]
91 1/8" (2315)

128 3/4" (3270)
126" (3200)
125 1/2" (3188)
34 11/16" (881)
33 13/16" (859)
43 1/8" (1095)

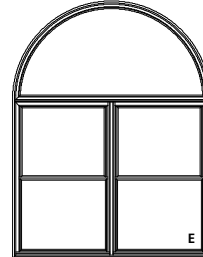

MDHB9677-2R

ELEVATION SYMBOL LEGEND:

VALUES IN () ARE IN MILLIMETER CONVERSIONS
VALUES IN [] ARE NUMBER OF DAYLIGHT OPENINGS PER UNIT

E BASIC UNIT CLEAR OPENING EXCEEDS 20" IN WIDTH, 24" IN HEIGHT & A MINIMUM OF 5.7 SQ. FT.

Note: Elevations shown DO NOT have exterior trim. Subtract 1/2" (12.7) from M.O. (Masonry Opening) for Unit Sizes. Masonry Openings above include Sill Nose, see Trim Options page for Sill Nose specifications. For other Trim Options refer to the Unit Sizing, Rough Opening & Masonry Openings page.

SCALE: 1/8" = 1'

GLAZING OPTIONS

EXTERIOR GLAZED

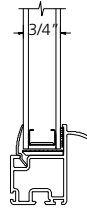

STANDARD 3/4" GLASS

GRILLES & SDL LITE PATTERNS

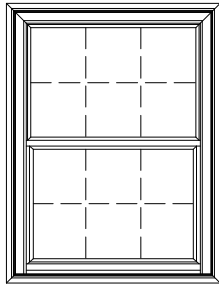

STANDARD

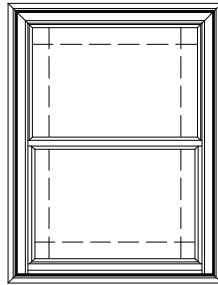

PRAIRIE

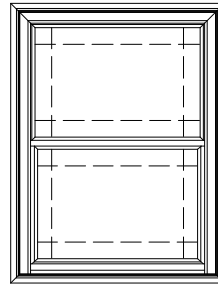

PRAIRIE SASH

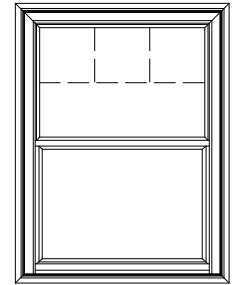

COLONIAL TOP SASH
1/2 LITE

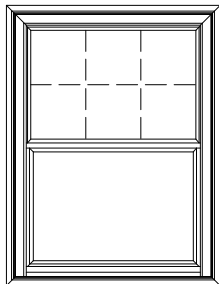

COLONIAL TOP SASH

DOUBLE-HUNG
DP 20

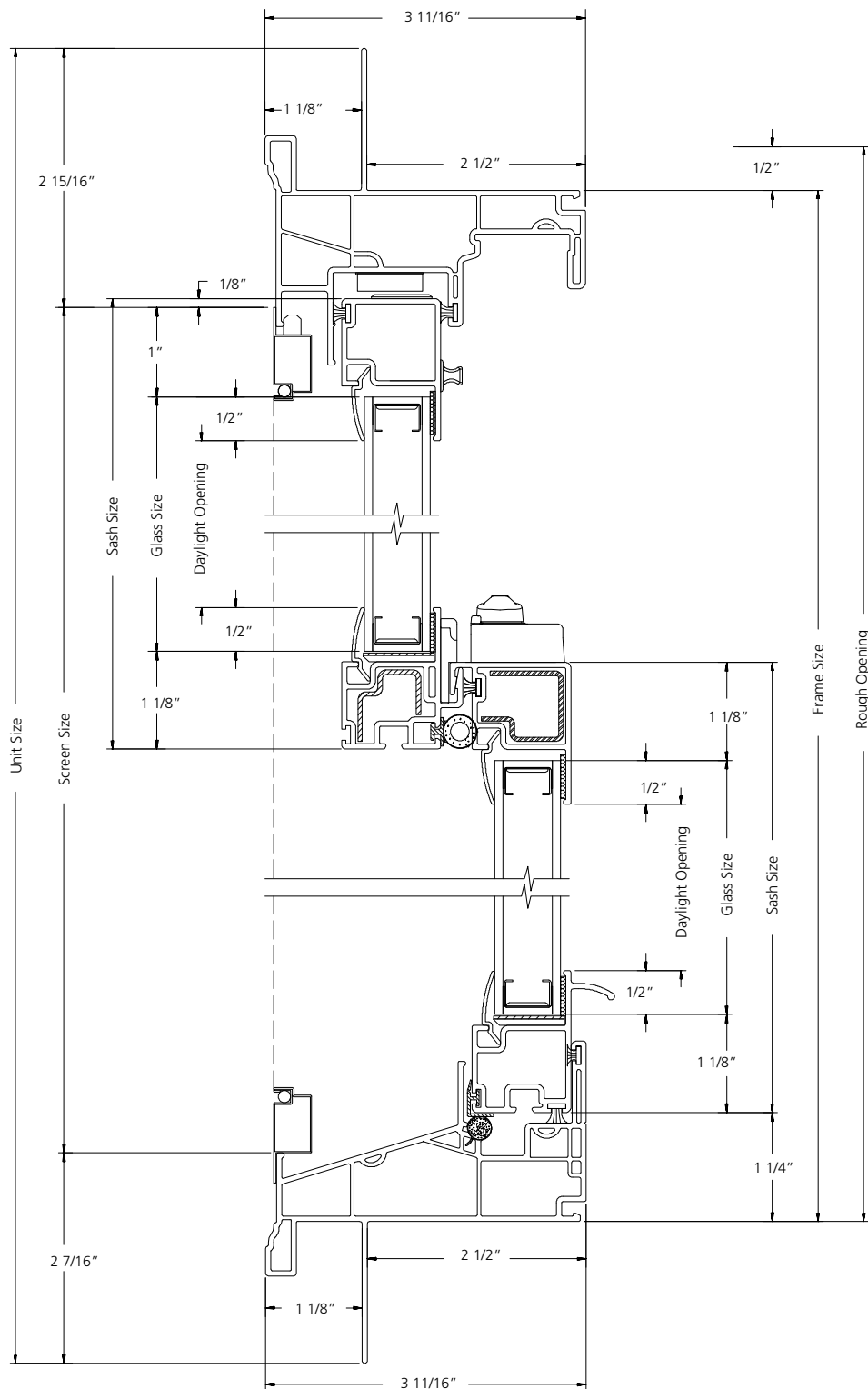

VERTICAL SECTION

SCALE: 6" = 1'

DOUBLE-HUNG
DP 20

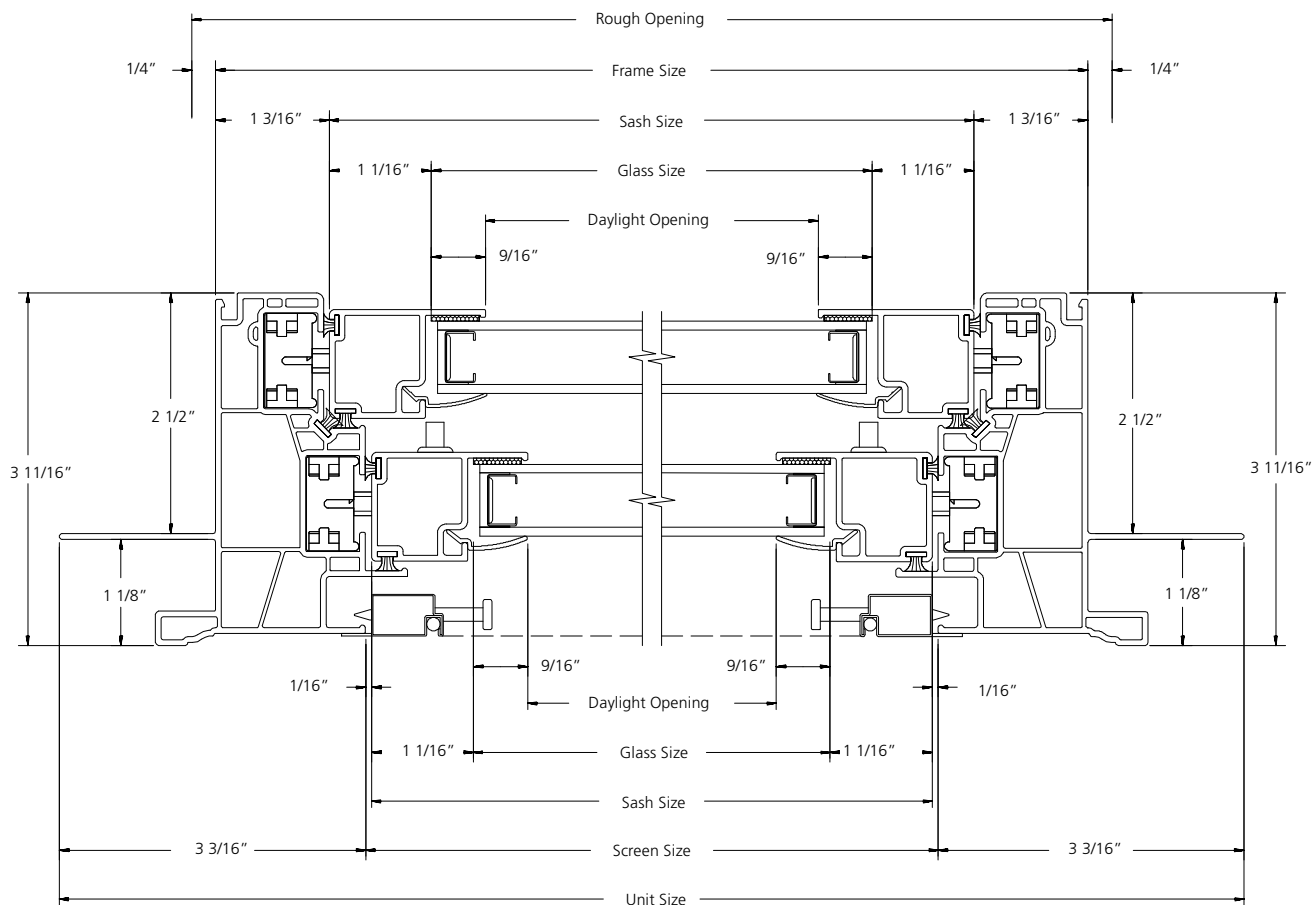

HORIZONTAL SECTION

SCALE: 6" = 1'

**2-WIDE DOUBLE-HUNG
DP 20**

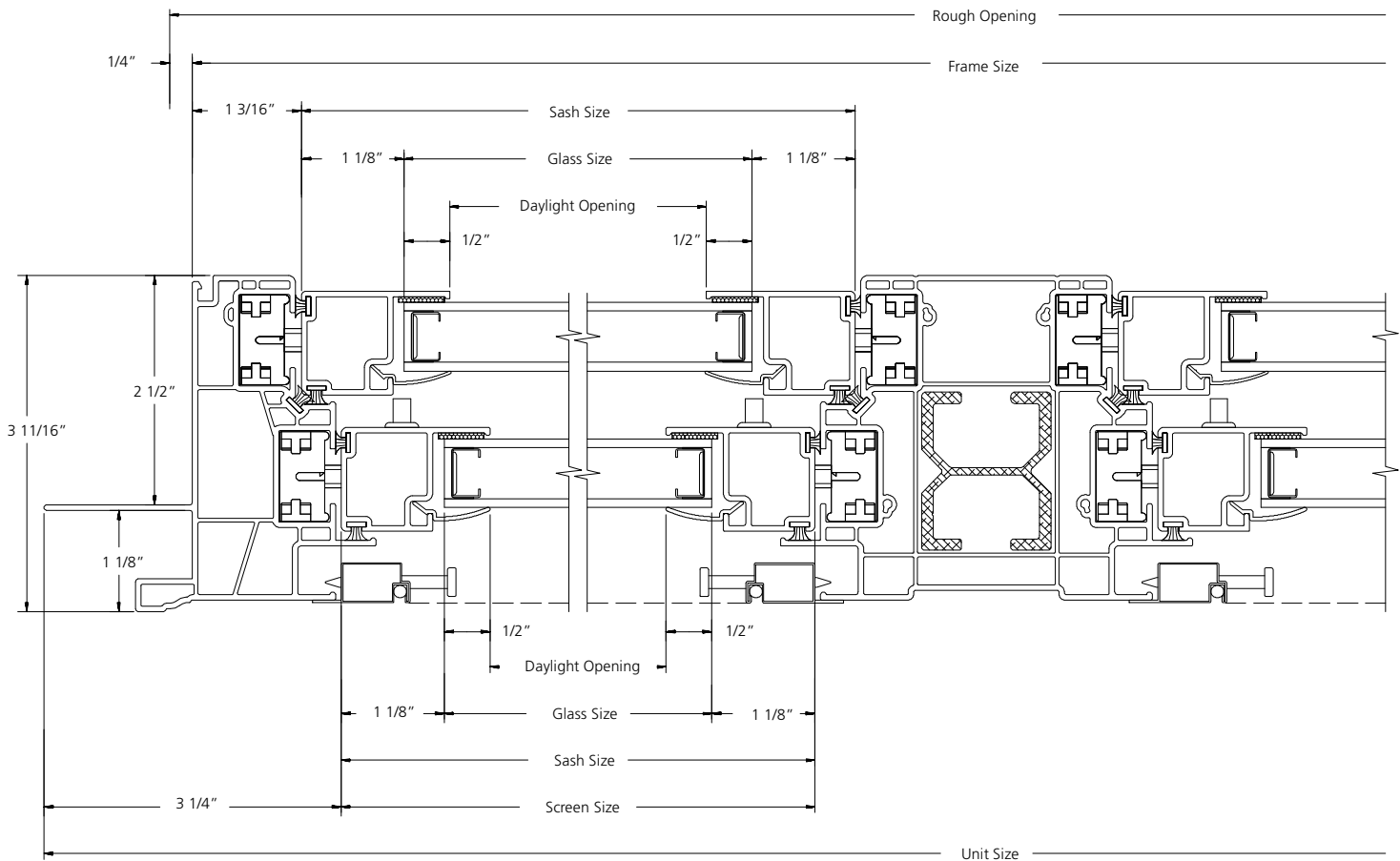

HORIZONTAL SECTION

SCALE: 6" = 1'

3-WIDE DOUBLE-HUNG
DP 20

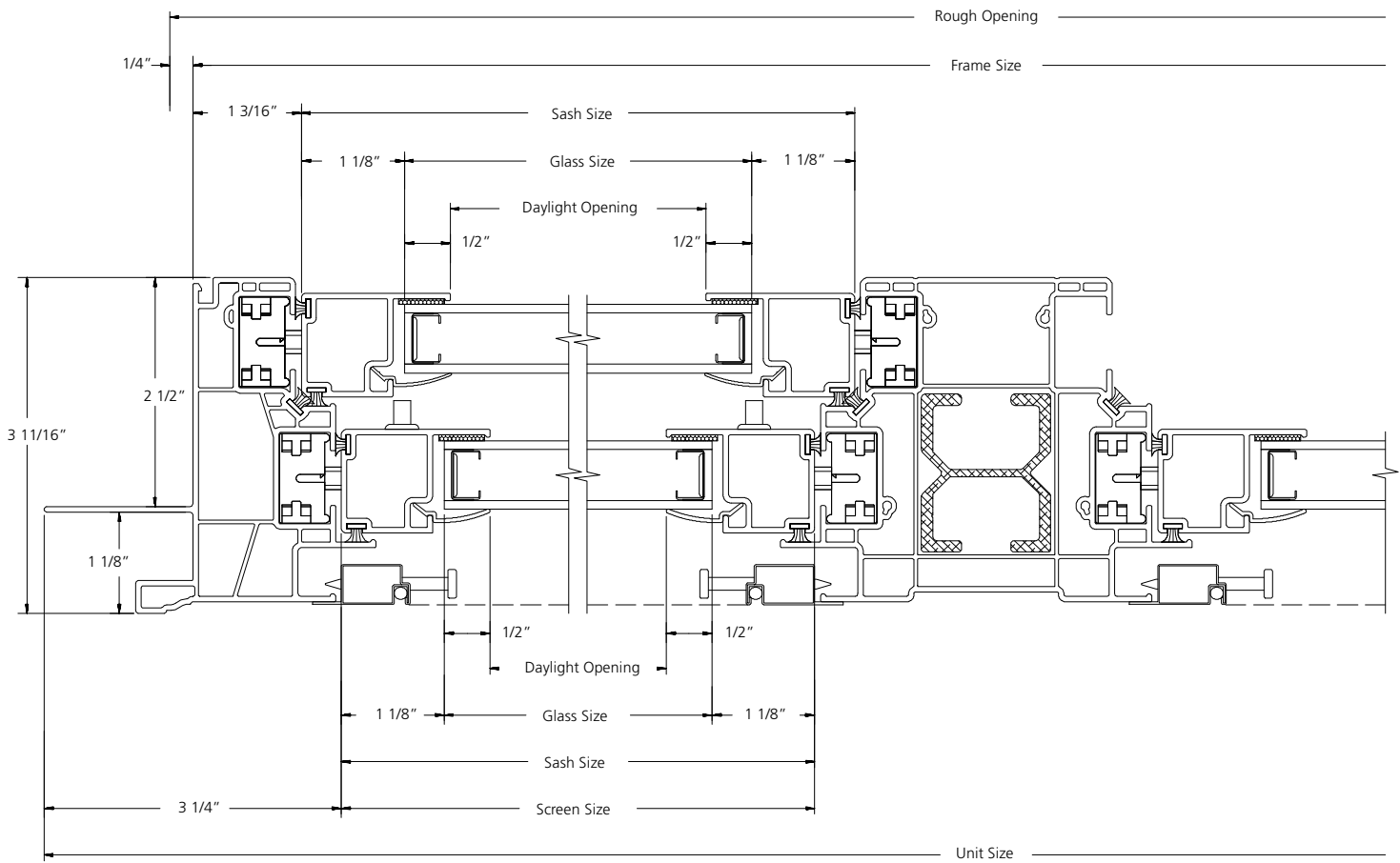

HORIZONTAL SECTION

SCALE: 6" = 1'

DOUBLE-HUNG WITH TRANSOM
DP 20

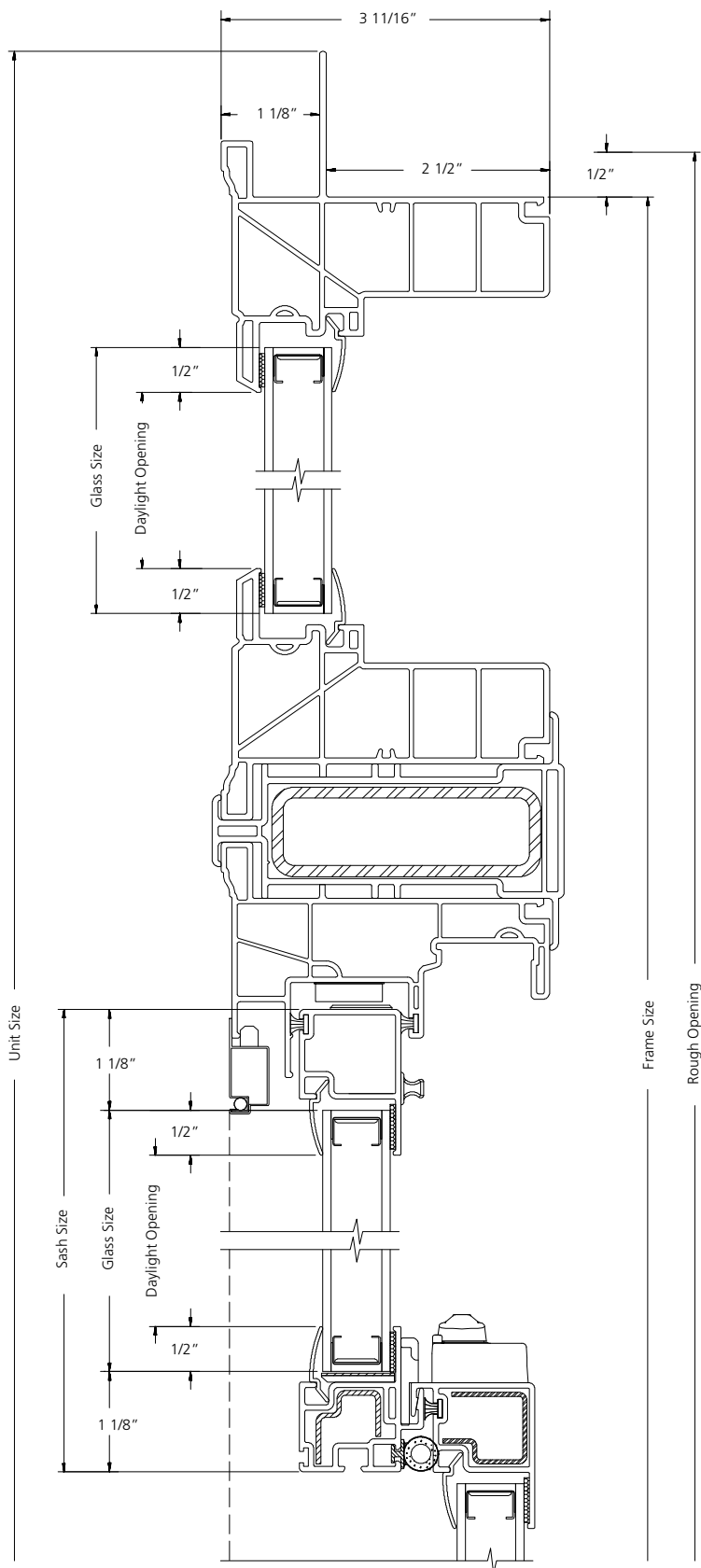

VERTICAL SECTION

SCALE: 6" = 1'

DOUBLE-HUNG
DP 50

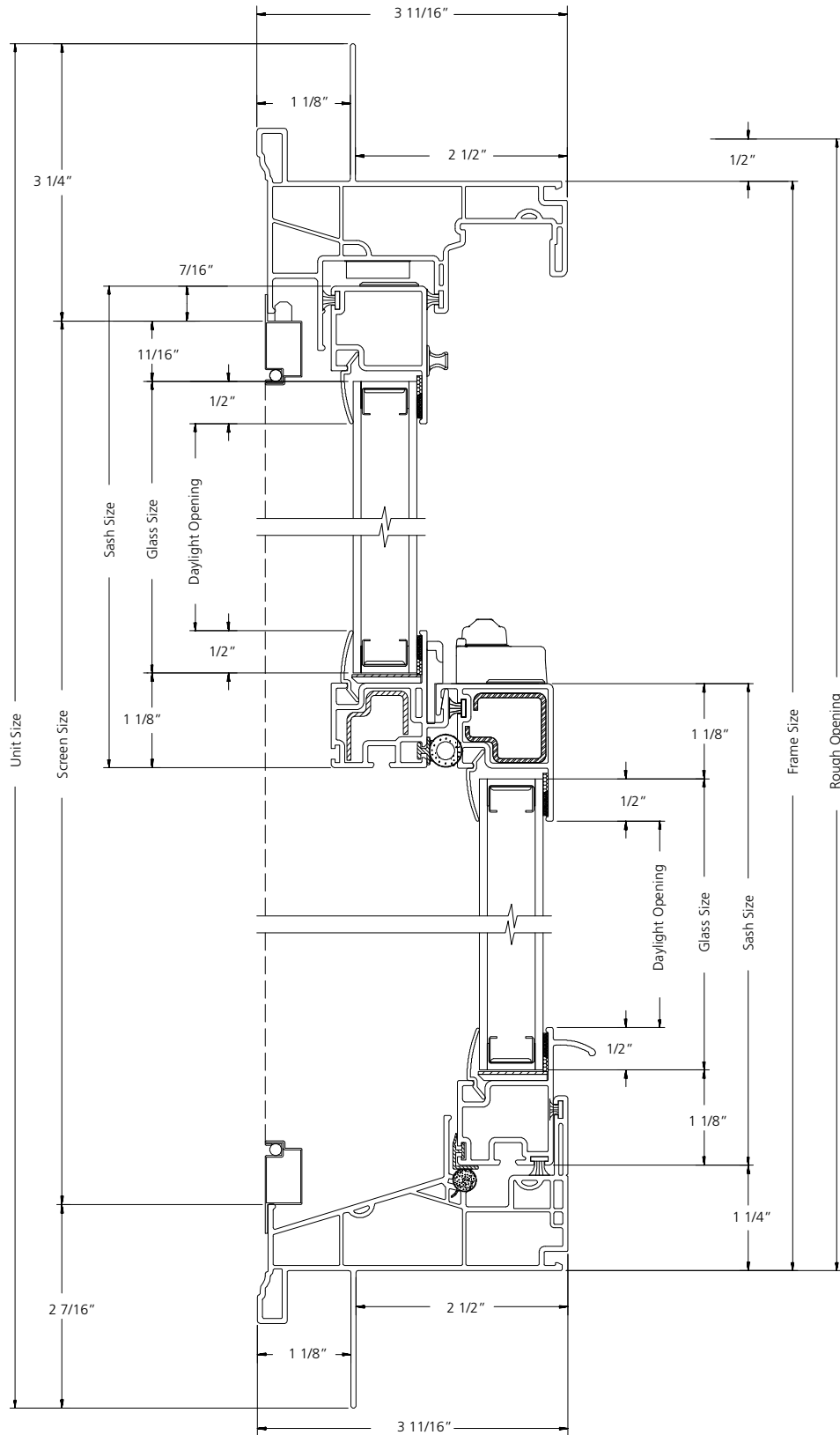

VERTICAL SECTION

SCALE: 6" = 1'

**DOUBLE-HUNG
DP 50**

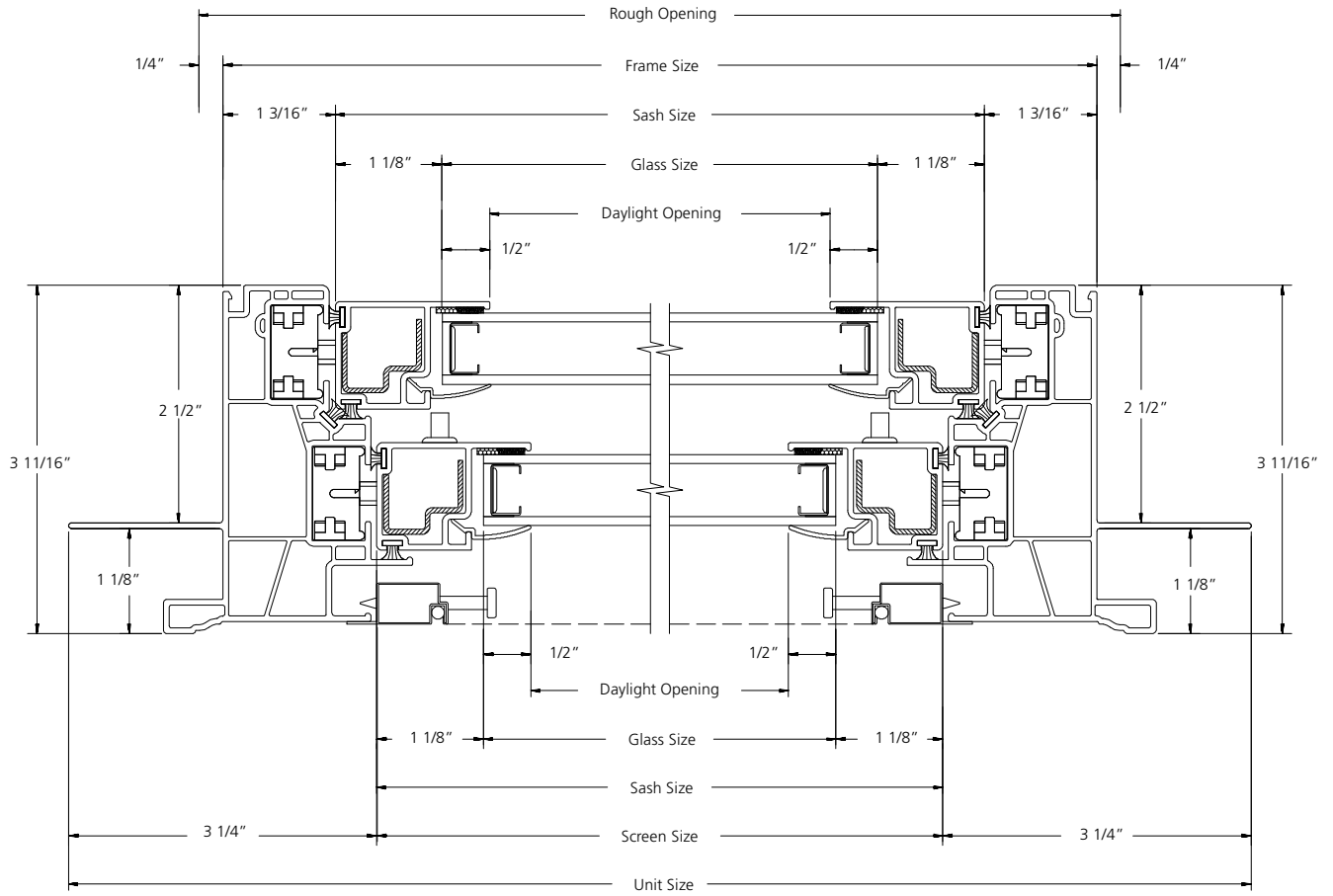

HORIZONTAL SECTION

SCALE: 6" = 1'

2-WIDE DOUBLE-HUNG
DP 50

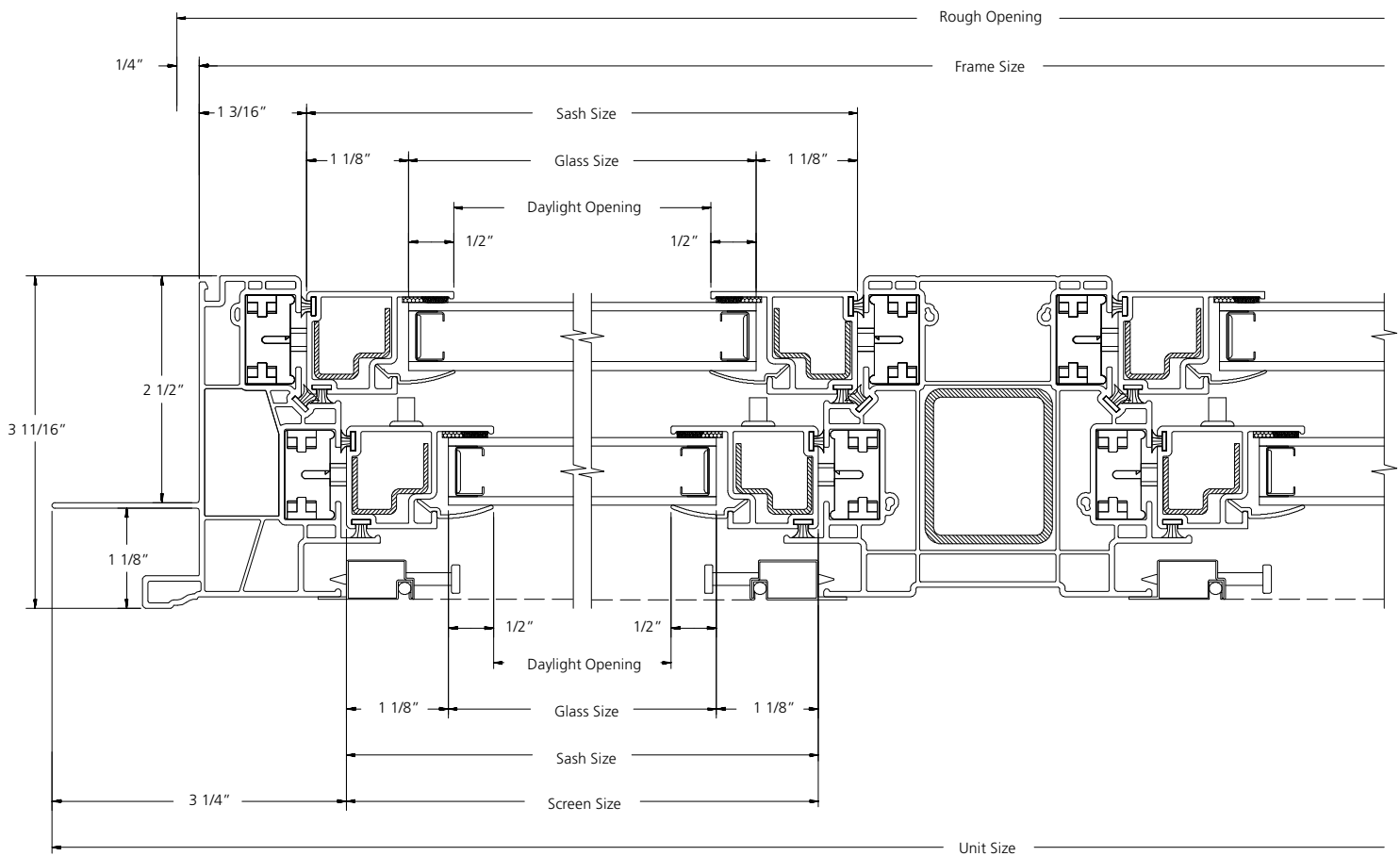

HORIZONTAL SECTION

SCALE: 6" = 1'

3-WIDE DOUBLE-HUNG
DP 50

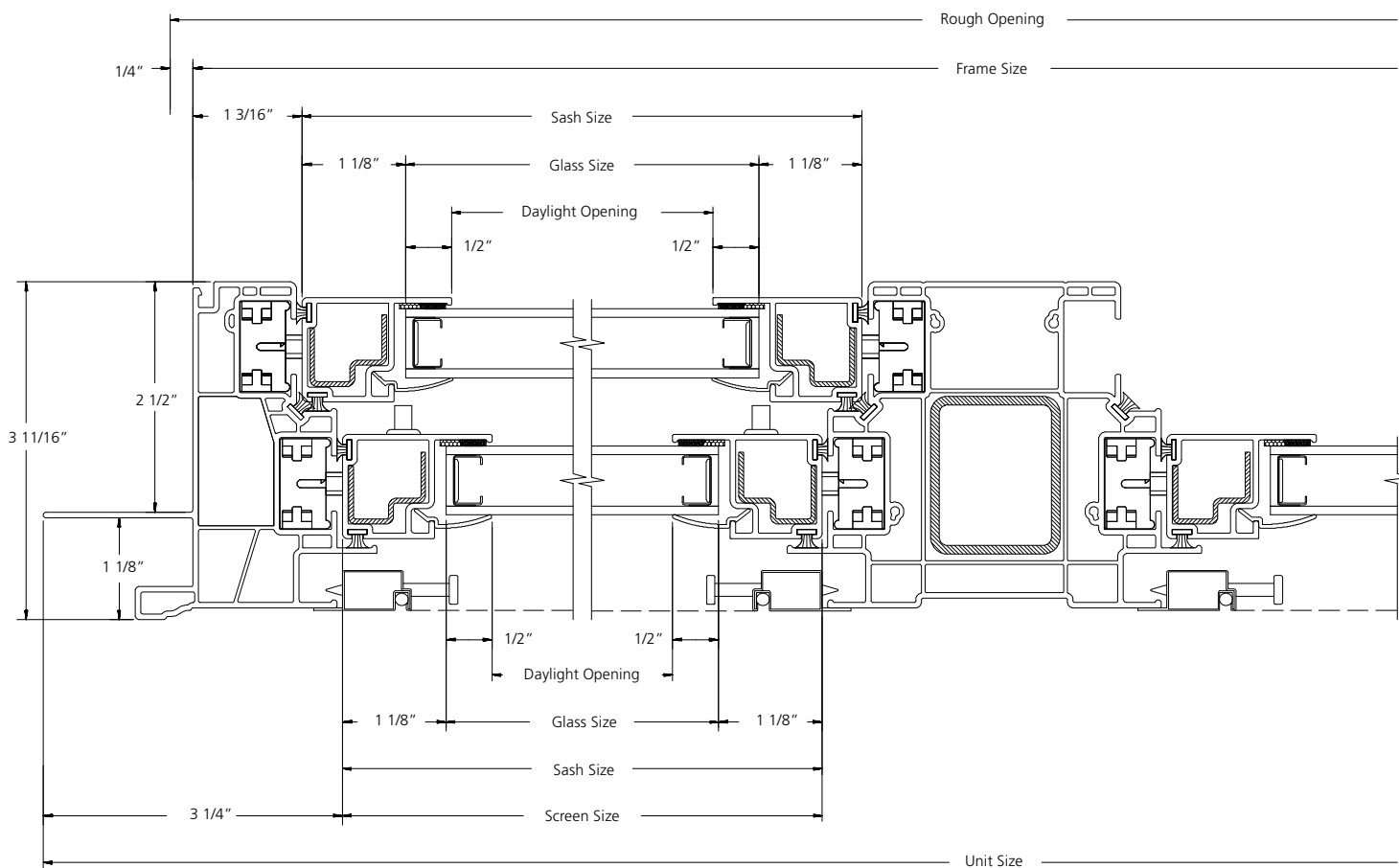

HORIZONTAL SECTION

SCALE: 6" = 1'

DOUBLE-HUNG WITH TRANSOM
DP 50

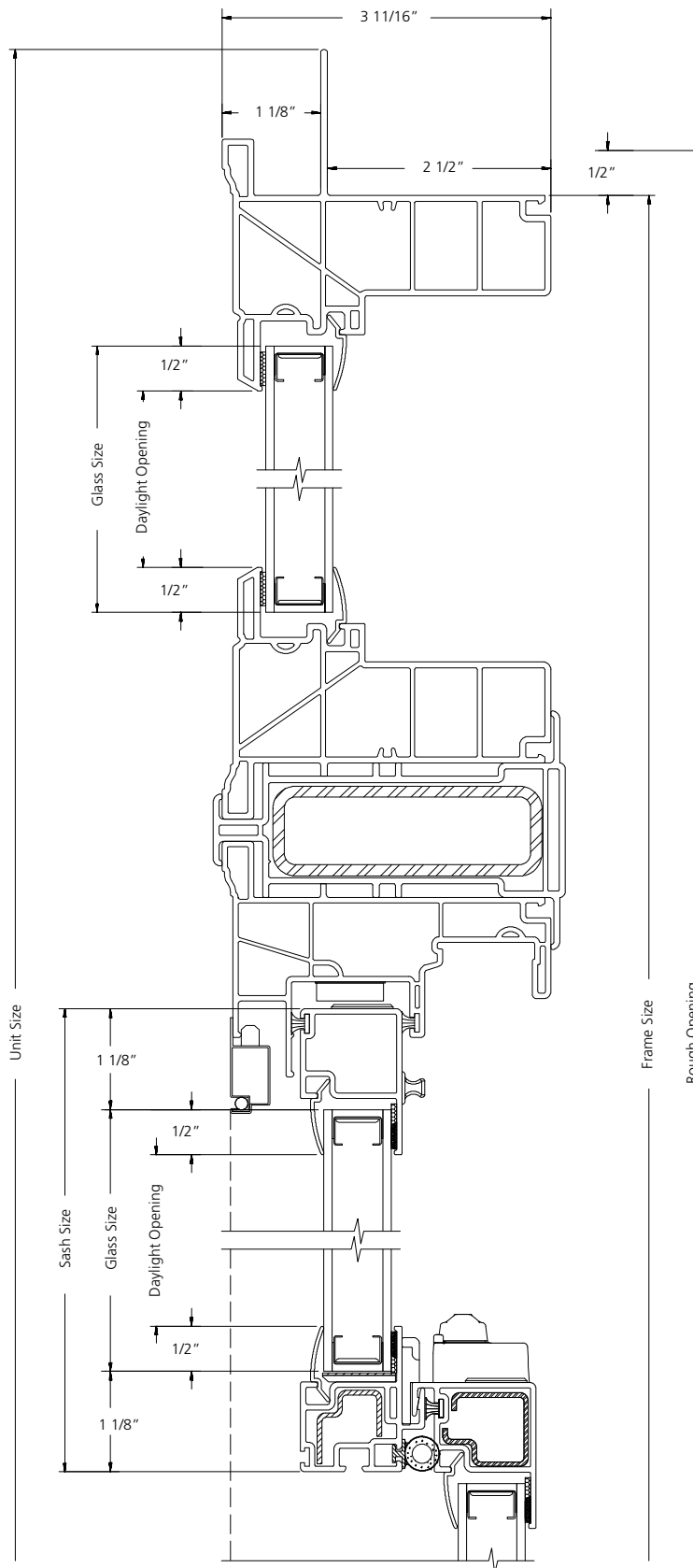

VERTICAL SECTION

SCALE: 6" = 1'