TABLE OF CONTENTS

Specifications	4-2
Quick Spec Guide	4-3
Elevations/Sizes: 1/4" Scale	
Picture Units	4-4
2-Wide Picture Units	4-26
3-Wide Picture Units	4-30
Quarter Round	4-32
Half Round	4-35
Full Round	4-36
Oval	4-37
Quarter Circle Segment	4-38
Circle Segment	4-39
Extended Quarter Round	4-40
Extended Half Round	4-41
Extended Quarter Segment	4-42
Extended Circle Segment	4-46
Glazing Options: 3" Scale	4-50
Grille Patterns	4-51
Section Details: 6" Scale	4-53

PRODUCT SPECIFICATIONS

MATERIALS

Extruded vinyl profiles comply with the performance requirements of AAMA 303. White and Desert Sand colors are available.

FRAME

All frames and sash are assembled utilizing fusion-welded technology for added strength and durability. Frame jamb depth is 3-11/16" (96.66mm,) and the exterior wall thickness is 0.060 of an inch nominal.

The frame incorporates a traditional brickmould profile with an integral j-channel and nailing fin. Weep holes are included on the frame to ensure standing water is directed to the exterior plane of the unit. An interior accessory groove is standard to accommodate various frame accessory and assembly options on the product.

GLAZING

34" (19mm) insulating glass consists of two lites of glass sealed around a spacer. The glass is mounted into the sash using a silicone-glazing compound. All insulating glass units comply with the performance requirements of the IGCC in accordance with either ASTM E774 or E2190. The units are interior glazed.

GLAZING OPTIONS

3/4" (19mm) insulated glass is available in clear, Low-E or Low-E 366, tinted, obscure, or other specialty insulating glass as specified. Many glass options are available in tempered glazing.

GRILLES

GBG (Grilles between the Glass) - 5/8" (16mm) and 7/8" (22.2mm) flat or 1" (26mm) contour grilles mounted between the glass panes suspended within the air cavity and color matched to the extrusion color.

SDL (Simulated Divided Lite) - 7/8" (22.2mm) color-matched contour muntins surface mounted on the exterior surfaces of the insulated glass unit to provide a true divided lite appearance.

EXTENSION JAMBS

Extension jambs are regionally available for JELD-WEN Vinyl products. The 4-9/16" and 6-9/16" extension jambs are available in pine clear vinyl wrapped, primed wood, red oak and maple finishes and can be specified on three or four sides of the product.

ADDITIONAL ACCESSORIES

Additional accessories are available for JELD-WEN Vinyl products. Please contact your local building supply retailer for a complete listing of the additional accessories.

INSTALLATION

Installation per JELD-WEN Installation Method for Vinyl Windows JII001, JII010 or JII011. See www.jeld-wen.com/resources for instructions.

PERFORMANCE

NFRC Certified - (rated and labeled in accordance with NFRC)

AAMA/WDMA/CSA 101/I.S.2/A440

















































































R20-DP rated

Optional DP-50 ratings are available

QUICK SPEC GUIDE

SPECIFICATION	STANDARD FEATURES	OPTIONAL FEATURES <i>Some options may require additional lead times. Consult your JELD-WEN Sales Representative.</i>
COLOR	<ul style="list-style-type: none"> White 	<ul style="list-style-type: none"> Desert Sand
SIZE (Rough Opening)	<ul style="list-style-type: none"> Width: 12" to 48" Height: 24" to 96" 	
FRAME	<ul style="list-style-type: none"> Integral Brickmould J-channel 	
GLAZING	<ul style="list-style-type: none"> Insulating Low-E 	<ul style="list-style-type: none"> Clear Low-E 366 Low-E Keep Clean Obscure Bronze Gray All glass available tempered <p><i>regional glass availabilities may differ</i></p>
GRILLES		<ul style="list-style-type: none"> 5/8", 1" Contour GBG (grilles between the glass) 5/8", 7/8" Flat GBG (grilles between the glass) 7/8" SDL (simulated divided lite) profiles
JAMB DEPTH	<ul style="list-style-type: none"> 3-1/2" 	<ul style="list-style-type: none"> 4-9/16" Extension Jambs Applied 6-9/16" Extension Jambs Applied
ACCESSORIES		<ul style="list-style-type: none"> Extension Jamb Retainer Drywall Retainer

PICTURE UNITS

UNIT SIZE	14 3/4" (375)	20 3/4" (527)	22 3/4" (278)	24 3/4" (629)	26 3/4" (679)	28 3/4" (730)	30 3/4" (781)	32 3/4" (832)	34 3/4" (883)
ROUGH OPENING	12" (305)	18" (457)	20" (508)	22" (559)	24" (610)	26" (660)	28" (711)	30" (762)	32" (813)
FRAME SIZE	11 1/2" (292)	17 1/2" (445)	19 1/2" (495)	21 1/2" (546)	23 1/2" (597)	25 1/2" (648)	27 1/2" (699)	29 1/2" (749)	31 1/2" (800)
DAYLIGHT OPENING	7 1/8" (181)	13 1/8" (333)	15 1/8" (384)	17 1/8" (435)	19 1/8" (486)	21 1/8" (537)	23 1/8" (587)	25 1/8" (638)	27 1/8" (689)
14 3/4" (375) 12" (305) 11 1/2" (292) 7 1/8" (181)									
20 3/4" (527) 18" (457) 17 1/2" (445) 13 1/8" (333)									
26 3/4" (679) 24" (610) 23 1/2" (597) 19 1/8" (486)									
32 3/4" (832) 30" (762) 29 1/2" (749) 25 1/8" (638)									
38 3/4" (984) 36" (914) 35 1/2" (902) 31 1/8" (791)									
39 3/4" (1010) 37" (941) 36 1/2" (927) 32 1/8" (816)									
40 3/4" (1035) 38" (966) 37 1/2" (953) 33 1/8" (841)									
43 3/4" (1111) 41" (1042) 40 1/2" (1029) 36 1/8" (918)									
44 3/4" (1137) 42" (1067) 41 1/2" (1054) 37 1/8" (943)									

ELEVATION SYMBOL LEGEND:

VALUES IN () ARE IN MILLIMETER CONVERSIONS
 VALUES IN [] ARE NUMBER OF DAYLIGHT OPENINGS PER UNIT











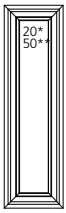

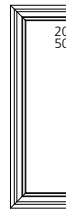
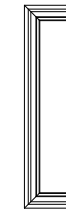
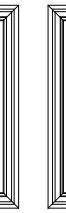
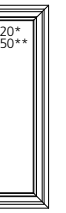

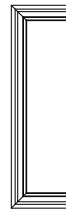
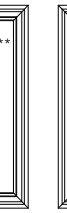
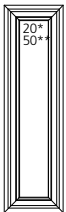

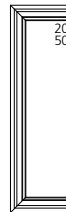
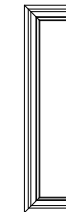
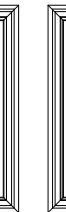
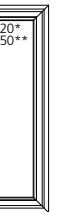

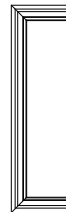
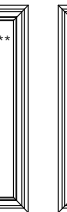
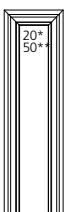

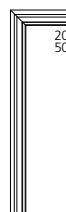
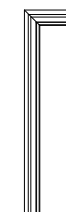
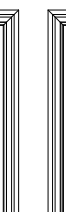
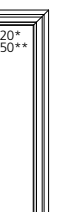
NUMBER INDICATES DESIGN PRESSURE (DP) RATING WITH STANDARD GLAZING.

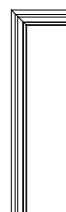
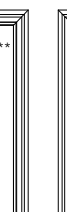
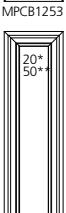
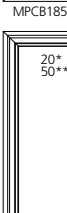
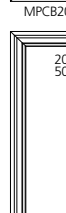
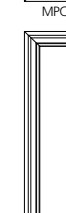
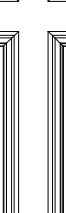
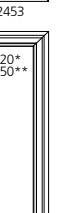
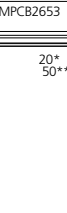
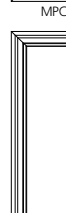
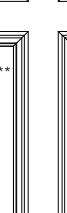
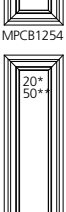
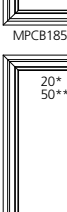
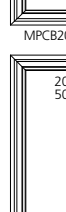
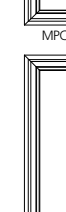
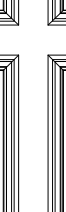
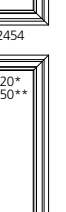
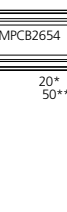
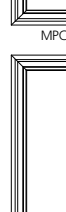
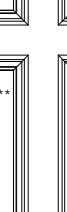
NUMBER INDICATES OPTIONAL DESIGN PRESSURE (DP) RATING.

Note: Elevations shown DO NOT have exterior trim. Subtract 1/2" (12.7) from M.O. (Masonry Opening) for Unit Sizes. Masonry Openings above include Sill Nose, see Trim Options page for Sill Nose specifications. For other Trim Options refer to the Unit Sizing, Rough Opening & Masonry Openings page.

SCALE: 1/4" = 1'

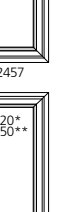
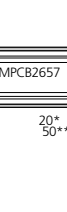
PICTURE UNITS

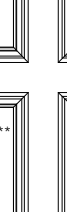
UNIT SIZE	14 3/4" (375)	20 3/4" (527)	22 3/4" (278)	24 3/4" (629)	26 3/4" (679)	28 3/4" (730)	30 3/4" (781)	32 3/4" (832)	34 3/4" (883)
ROUGH OPENING	12" (305)	18" (457)	20" (508)	22" (559)	24" (610)	26" (660)	28" (711)	30" (762)	32" (813)
FRAME SIZE	11 1/2" (292)	17 1/2" (445)	19 1/2" (495)	21 1/2" (546)	23 1/2" (597)	25 1/2" (648)	27 1/2" (699)	29 1/2" (749)	31 1/2" (800)
DAYLIGHT OPENING	7 1/8" (181)	13 1/8" (333)	15 1/8" (384)	17 1/8" (435)	19 1/8" (486)	21 1/8" (537)	23 1/8" (587)	25 1/8" (638)	27 1/8" (689)
50 3/4" (1289) 48" (1219) 47 1/2" (1207) 43 1/8" (1095)									
	MPCB1248	MPCB1848	MPCB2048	MPCB2248	MPCB2448	MPCB2648	MPCB2848	MPCB3048	MPCB3248
51 3/4" (1314) 49" (1245) 48 1/2" (1232) 44 1/8" (1121)									
	MPCB1249	MPCB1849	MPCB2049	MPCB2249	MPCB2449	MPCB2649	MPCB2849	MPCB3049	MPCB3249
55 3/4" (1416) 53" (1347) 52 1/2" (1334) 48 1/8" (1222)									
	MPCB1253	MPCB1853	MPCB2053	MPCB2253	MPCB2453	MPCB2653	MPCB2853	MPCB3053	MPCB3253
56 3/4" (1441) 54" (1372) 53 1/2" (1359) 49 1/8" (1248)									
	MPCB1254	MPCB1854	MPCB2054	MPCB2254	MPCB2454	MPCB2654	MPCB2854	MPCB3054	MPCB3254
59 3/4" (1518) 57" (1449) 56 1/2" (1435) 52 1/8" (1324)									
	MPCB1257	MPCB1857	MPCB2057	MPCB2257	MPCB2457	MPCB2657	MPCB2857	MPCB3057	MPCB3257
62 3/4" (1594) 60" (1524) 59 1/2" (1511) 55 1/8" (1400)									
	MPCB1260	MPCB1860	MPCB2060	MPCB2260	MPCB2460	MPCB2660	MPCB2860	MPCB3060	MPCB3260

ELEVATION SYMBOL LEGEND:

VALUES IN () ARE IN MILLIMETER CONVERSIONS

VALUES IN [] ARE NUMBER OF DAYLIGHT OPENINGS PER UNIT













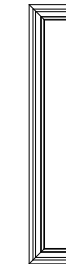







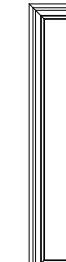







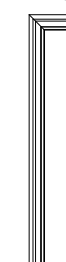







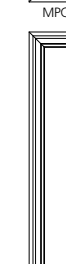

NUMBER INDICATES DESIGN PRESSURE (DP) RATING WITH STANDARD GLAZING.

NUMBER INDICATES OPTIONAL DESIGN PRESSURE (DP) RATING.

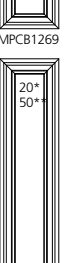
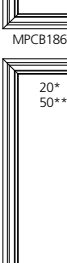
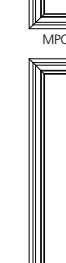
Note: Elevations shown DO NOT have exterior trim. Subtract 1/2" (12.7) from M.O. (Masonry Opening) for Unit Sizes. Masonry Openings above include Sill Nose, see Trim Options page for Sill Nose specifications. For other Trim Options refer to the Unit Sizing, Rough Opening & Masonry Openings page.

SCALE: 1/4" = 1'

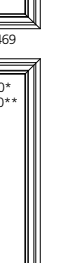
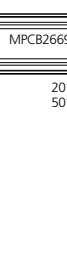
PICTURE UNITS

UNIT SIZE	14 3/4"(375)	20 3/4"(527)	22 3/4"(278)	24 3/4"(629)	26 3/4"(679)	28 3/4"(730)	30 3/4"(781)	32 3/4"(832)	34 3/4"(883)				
ROUGH OPENING	12"(305)	18"(457)	20"(508)	22"(559)	24"(610)	26"(660)	28"(711)	30"(762)	32"(813)				
FRAME SIZE	11 1/2"(292)	17 1/2"(445)	19 1/2"(495)	21 1/2"(546)	23 1/2"(597)	25 1/2"(648)	27 1/2"(699)	29 1/2"(749)	31 1/2"(800)				
DAYLIGHT OPENING	7 1/8"(181)	13 1/8"(333)	15 1/8"(384)	17 1/8"(435)	19 1/8"(486)	21 1/8"(537)	23 1/8"(587)	25 1/8"(638)	27 1/8"(689)				
64 3/4"(1645) 62"(1576) 61 1/2"(1562) 57 1/8"(1451)													
	MPCB1262	MPCB1862	MPCB2062	MPCB2262	MPCB2462	MPCB2662	MPCB2862	MPCB3062	MPCB3262				
	67 3/4"(1721) 65"(1652) 64 1/2"(1638) 60 1/8"(1527)												
		MPCB1265	MPCB1865	MPCB2065	MPCB2265	MPCB2465	MPCB2665	MPCB2865	MPCB3065	MPCB3265			
		68 3/4"(1746) 66"(1676) 65 1/2"(1664) 61 1/8"(1553)											
			MPCB1266	MPCB1866	MPCB2066	MPCB2266	MPCB2466	MPCB2666	MPCB2866	MPCB3066	MPCB3266		
			71 3/4"(1822) 69"(1753) 68 1/2"(1740) 64 1/8"(1629)										
				MPCB1269	MPCB1869	MPCB2069	MPCB2269	MPCB2469	MPCB2669	MPCB2869	MPCB3069	MPCB3269	
				74 3/4"(1898) 72"(1829) 71 1/2"(1816) 67 1/8"(1705)									
					MPCB1272	MPCB1872	MPCB2072	MPCB2272	MPCB2472	MPCB2672	MPCB2872	MPCB3072	MPCB3272

ELEVATION SYMBOL LEGEND:

VALUES IN () ARE IN MILLIMETER CONVERSIONS

VALUES IN [] ARE NUMBER OF DAYLIGHT OPENINGS PER UNIT











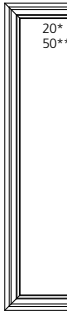

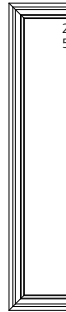
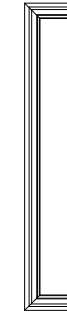
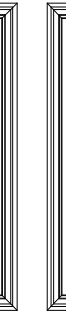
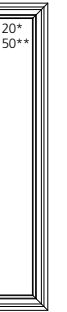

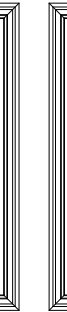

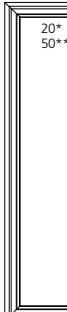

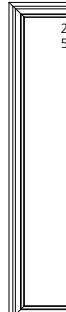
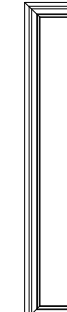
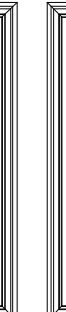
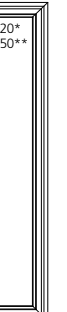

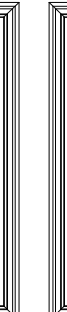

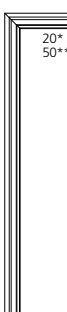
NUMBER INDICATES DESIGN PRESSURE (DP) RATING WITH STANDARD GLAZING.

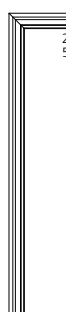
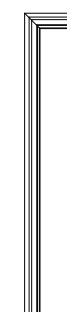
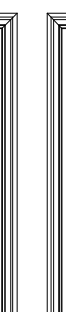
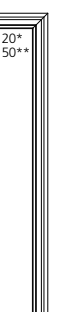
NUMBER INDICATES OPTIONAL DESIGN PRESSURE (DP) RATING.

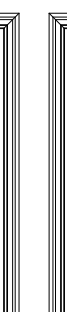
Note: Elevations shown DO NOT have exterior trim. Subtract 1/2" (12.7) from M.O. (Masonry Opening) for Unit Sizes. Masonry Openings above include Sill Nose, see Trim Options page for Sill Nose specifications. For other Trim Options refer to the Unit Sizing, Rough Opening & Masonry Openings page.

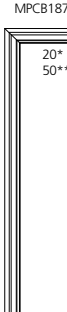
SCALE: 1/4" = 1'

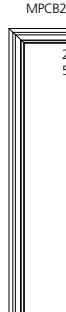
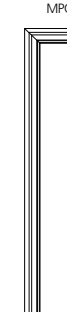
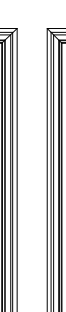
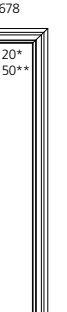
PICTURE UNITS

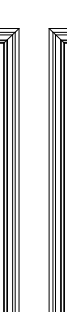
UNIT SIZE	14 3/4"(375)	20 3/4"(527)	22 3/4"(278)	24 3/4"(629)	26 3/4"(679)	28 3/4"(730)	30 3/4"(781)	32 3/4"(832)	34 3/4"(883)				
ROUGH OPENING	12"(305)	18"(457)	20"(508)	22"(559)	24"(610)	26"(660)	28"(711)	30"(762)	32"(813)				
FRAME SIZE	11 1/2"(292)	17 1/2"(445)	19 1/2"(495)	21 1/2"(546)	23 1/2"(597)	25 1/2"(648)	27 1/2"(699)	29 1/2"(749)	31 1/2"(800)				
DAYLIGHT OPENING	7 1/8"(181)	13 1/8"(333)	15 1/8"(384)	17 1/8"(435)	19 1/8"(486)	21 1/8"(537)	23 1/8"(587)	25 1/8"(638)	27 1/8"(689)				
76 3/4"(1949) 74"(1880) 73 1/2"(1867) 69 1/8"(1756)													
	MPCB1274	MPCB1874	MPCB2074	MPCB2274	MPCB2474	MPCB2674	MPCB2874	MPCB3074	MPCB3274	MPCB3274			
	79 3/4"(2026) 77"(1957) 76 1/2"(1943) 72 1/8"(1832)												
		MPCB1277	MPCB1877	MPCB2077	MPCB2277	MPCB2477	MPCB2677	MPCB2877	MPCB3077	MPCB3277	MPCB3277		
		80 3/4"(2051) 78"(1981) 77 1/2"(1969) 73 1/8"(1857)											
			MPCB1278	MPCB1878	MPCB2078	MPCB2278	MPCB2478	MPCB2678	MPCB2878	MPCB3078	MPCB3278	MPCB3278	
			86 3/4"(2203) 84"(2134) 83 1/2"(2121) 79 1/8"(2010)										
				MPCB1284	MPCB1884	MPCB2084	MPCB2284	MPCB2484	MPCB2684	MPCB2884	MPCB3084	MPCB3284	MPCB3284

ELEVATION SYMBOL LEGEND:

VALUES IN () ARE IN MILLIMETER CONVERSIONS
 VALUES IN [] ARE NUMBER OF DAYLIGHT OPENINGS PER UNIT

NUMBER INDICATES DESIGN PRESSURE (DP) RATING WITH STANDARD GLAZING.

###* NUMBER INDICATES OPTIONAL DESIGN PRESSURE (DP) RATING.

Note: Elevations shown DO NOT have exterior trim. Subtract 1/2" (12.7) from M.O. (Masonry Opening) for Unit Sizes. Masonry Openings above include Sill Nose, see Trim Options page for Sill Nose specifications. For other Trim Options refer to the Unit Sizing, Rough Opening & Masonry Openings page.

SCALE: 1/4" = 1'

PICTURE UNITS

	14 3/4" (375)	20 3/4" (527)	22 3/4" (278)	24 3/4" (629)	26 3/4" (679)	28 3/4" (730)	30 3/4" (781)	32 3/4" (832)	34 3/4" (883)
UNIT SIZE	14 3/4" (375)	20 3/4" (527)	22 3/4" (278)	24 3/4" (629)	26 3/4" (679)	28 3/4" (730)	30 3/4" (781)	32 3/4" (832)	34 3/4" (883)
ROUGH OPENING	12" (305)	18" (457)	20" (508)	22" (559)	24" (610)	26" (660)	28" (711)	30" (762)	32" (813)
FRAME SIZE	11 1/2" (292)	17 1/2" (445)	19 1/2" (495)	21 1/2" (546)	23 1/2" (597)	25 1/2" (648)	27 1/2" (699)	29 1/2" (749)	31 1/2" (800)
DAYLIGHT OPENING	7 1/8" (181)	13 1/8" (333)	15 1/8" (384)	17 1/8" (435)	19 1/8" (486)	21 1/8" (537)	23 1/8" (587)	25 1/8" (638)	27 1/8" (689)
	MPCB1290	MPCB1890	MPCB2090	MPCB2290	MPCB2490	MPCB2690	MPCB2890	MPCB3090	MPCB3290
	MPCB1296	MPCB1896	MPCB2096	MPCB2296	MPCB2496	MPCB2696	MPCB2896	MPCB3096	MPCB3296

92 3/4" (2356)
90" (2286)
89 1/2" (2273)
85 1/8" (2162)

98 3/4" (2508)
96" (2438)
95 1/2" (2426)
91 1/8" (2315)

ELEVATION SYMBOL LEGEND:

VALUES IN () ARE IN MILLIMETER CONVERSIONS
VALUES IN [] ARE NUMBER OF DAYLIGHT OPENINGS PER UNIT

NUMBER INDICATES DESIGN PRESSURE (DP) RATING WITH STANDARD GLAZING.











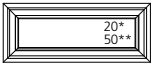

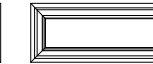
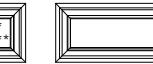
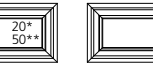
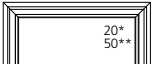



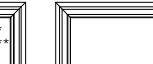
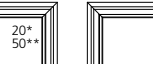
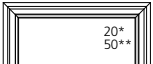



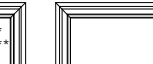
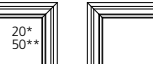
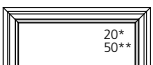

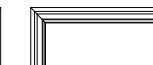
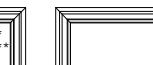
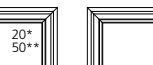
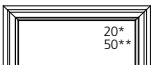



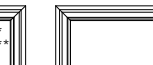

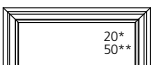

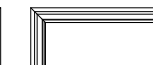
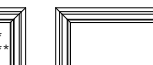

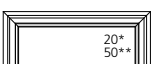

NUMBER INDICATES OPTIONAL DESIGN PRESSURE (DP) RATING.

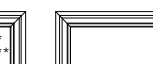
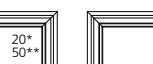
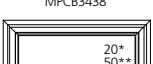
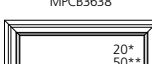
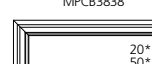
Note: Elevations shown DO NOT have exterior trim. Subtract 1/2" (12.7) from M.O. (Masonry Opening) for Unit Sizes. Masonry Openings above include Sill Nose, see Trim Options page for Sill Nose specifications. For other Trim Options refer to the Unit Sizing, Rough Opening & Masonry Openings page.

SCALE: 1/4" = 1'

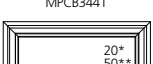
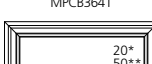
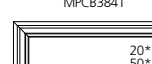
PICTURE UNITS

UNIT SIZE
ROUGH OPENING
FRAME SIZE
DAYLIGHT OPENING

	36 3/4"(933) 34"(864) 33 1/2"(851) 29 1/8"(740)	38 3/4"(984) 36"(914) 35 1/2"(902) 31 1/8"(791)	40 3/4"(1035) 38"(965) 37 1/2"(953) 33 1/8"(841)	42 3/4"(1086) 40"(1016) 39 1/2"(1003) 35 1/8"(892)	44 3/4"(1137) 42"(1067) 41 1/2"(1054) 37 1/8"(943)	48 3/4"(1238) 46"(1168) 45 1/2"(1156) 41 1/8"(1045)
14 3/4"(375) 12"(305) 11 1/2"(292) 7 1/8"(181)	 20* 50**	 20* 50**	 20* 50**	 20* 50**	 20* 50**	 20* 50**
	MPCB3412	MPCB3612	MPCB3812	MPCB4012	MPCB4212	MPCB4612
20 3/4"(527) 18"(457) 17 1/2"(445) 13 1/8"(333)	 20* 50**	 20* 50**	 20* 50**	 20* 50**	 20* 50**	 20* 50**
	MPCB3418	MPCB3618	MPCB3818	MPCB4018	MPCB4218	MPCB4618
26 3/4"(679) 24"(610) 23 1/2"(597) 19 1/8"(486)	 20* 50**	 20* 50**	 20* 50**	 20* 50**	 20* 50**	 20* 50**
	MPCB3424	MPCB3624	MPCB3824	MPCB4024	MPCB4224	MPCB4624
32 3/4"(832) 30"(762) 29 1/2"(749) 25 1/8"(638)	 20* 50**	 20* 50**	 20* 50**	 20* 50**	 20* 50**	 20* 50**
	MPCB3430	MPCB3630	MPCB3830	MPCB4030	MPCB4230	MPCB4630
38 3/4"(984) 36"(914) 35 1/2"(902) 31 1/8"(791)	 20* 50**	 20* 50**	 20* 50**	 20* 50**	 20* 50**	 20* 50**
	MPCB3436	MPCB3636	MPCB3836	MPCB4036	MPCB4236	MPCB4636
39 3/4"(1010) 37"(941) 36 1/2"(927) 32 1/8"(816)	 20* 50**	 20* 50**	 20* 50**	 20* 50**	 20* 50**	 20* 50**
	MPCB3437	MPCB3637	MPCB3837	MPCB4037	MPCB4237	MPCB4637
40 3/4"(1035) 38"(966) 37 1/2"(953) 33 1/8"(841)	 20* 50**	 20* 50**	 20* 50**	 20* 50**	 20* 50**	 20* 50**
	MPCB3438	MPCB3638	MPCB3838	MPCB4038	MPCB4238	MPCB4638
43 3/4"(1111) 41"(1042) 40 1/2"(1029) 36 1/8"(918)	 20* 50**	 20* 50**	 20* 50**	 20* 50**	 20* 50**	 20* 50**
	MPCB3441	MPCB3641	MPCB3841	MPCB4041	MPCB4241	MPCB4641
44 3/4"(1137) 42"(1067) 41 1/2"(1054) 37 1/8"(943)	 20* 50**	 20* 50**	 20* 50**	 20* 50**	 20* 50**	 20* 50**
	MPCB3442	MPCB3642	MPCB3842	MPCB4042	MPCB4242	MPCB4642

ELEVATION SYMBOL LEGEND:

VALUES IN () ARE IN MILLIMETER CONVERSIONS

VALUES IN [] ARE NUMBER OF DAYLIGHT OPENINGS PER UNIT



NUMBER INDICATES DESIGN PRESSURE (DP) RATING WITH STANDARD GLAZING.

NUMBER INDICATES OPTIONAL DESIGN PRESSURE (DP) RATING.

Note: Elevations shown DO NOT have exterior trim. Subtract 1/2" (12.7) from M.O. (Masonry Opening) for Unit Sizes. Masonry Openings above include Sill Nose, see Trim Options page for Sill Nose specifications. For other Trim Options refer to the Unit Sizing, Rough Opening & Masonry Openings page.

SCALE: 1/4" = 1'

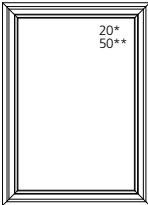
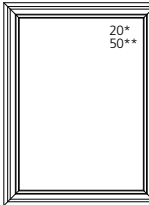
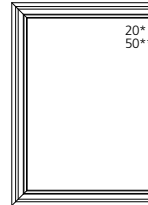
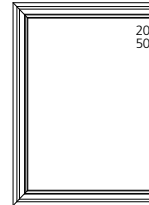
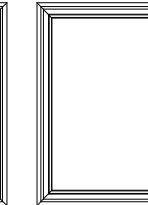
PICTURE UNITS

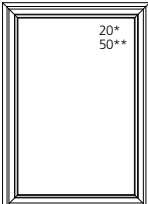
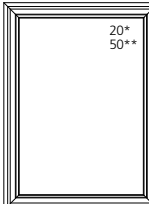
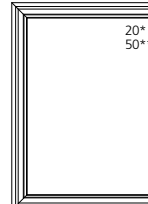
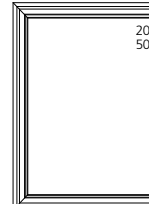
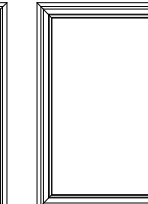
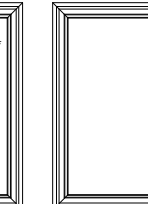
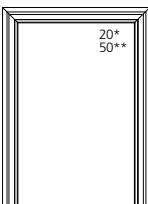
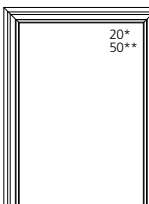
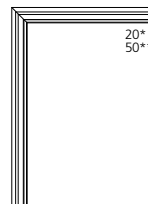
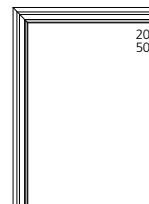
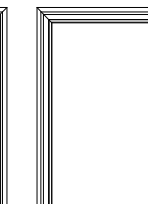
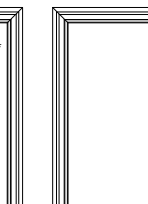
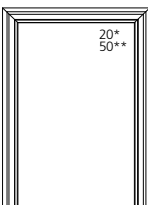
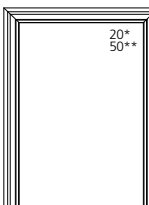
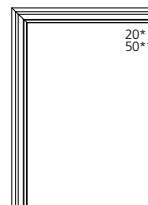
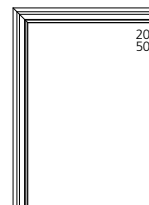
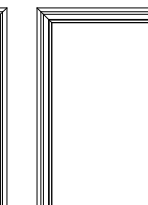
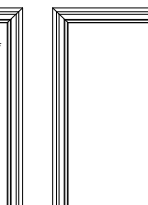
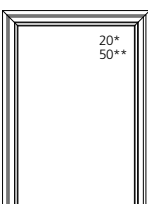
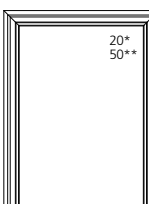
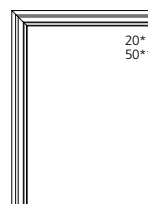
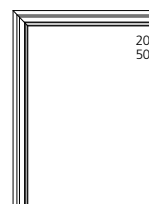
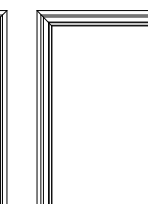
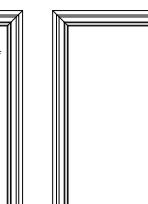
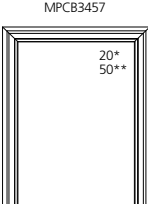
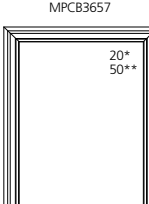
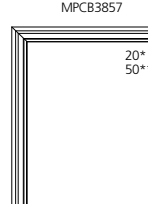
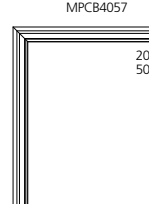
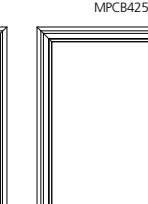
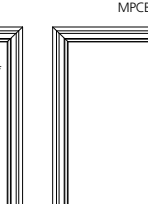
UNIT SIZE	36 3/4" (933)	38 3/4" (984)	40 3/4" (1035)	42 3/4" (1086)	44 3/4" (1137)	48 3/4" (1238)
ROUGH OPENING	34" (864)	36" (914)	38" (965)	40" (1016)	42" (1067)	46" (1168)
FRAME SIZE	33 1/2" (851)	35 1/2" (902)	37 1/2" (953)	39 1/2" (1003)	41 1/2" (1054)	45 1/2" (1156)
DAYLIGHT OPENING	29 1/8" (740)	31 1/8" (791)	33 1/8" (841)	35 1/8" (892)	37 1/8" (943)	41 1/8" (1045)
50 3/4" (1289) 48" (1219) 47 1/2" (1207) 43 1/8" (1095)	 MPCB3448	 MPCB3648	 MPCB3848	 MPCB4048	 MPCB4248	 MPCB4648
51 3/4" (1314) 49" (1245) 48 1/2" (1232) 44 1/8" (1121)	 MPCB3449	 MPCB3649	 MPCB3849	 MPCB4049	 MPCB4249	 MPCB4649
55 3/4" (1416) 53" (1347) 52 1/2" (1334) 48 1/8" (1222)	 MPCB3453	 MPCB3653	 MPCB3853	 MPCB4053	 MPCB4253	 MPCB4653
56 3/4" (1441) 54" (1372) 53 1/2" (1359) 49 1/8" (1248)	 MPCB3454	 MPCB3654	 MPCB3854	 MPCB4054	 MPCB4254	 MPCB4654
59 3/4" (1518) 57" (1449) 56 1/2" (1435) 52 1/8" (1324)	 MPCB3457	 MPCB3657	 MPCB3857	 MPCB4057	 MPCB4257	 MPCB4657
62 3/4" (1594) 60" (1524) 59 1/2" (1511) 55 1/8" (1400)	 MPCB3460	 MPCB3660	 MPCB3860	 MPCB4060	 MPCB4260	 MPCB4660

ELEVATION SYMBOL LEGEND:

VALUES IN () ARE IN MILLIMETER CONVERSIONS

VALUES IN [] ARE NUMBER OF DAYLIGHT OPENINGS PER UNIT









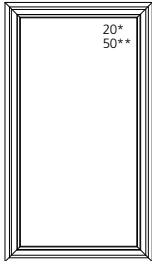
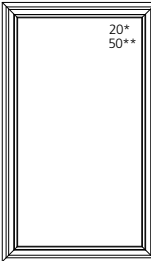
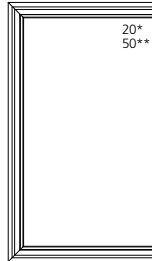
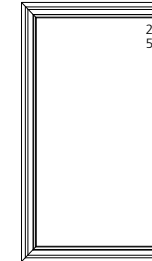

NUMBER INDICATES DESIGN PRESSURE (DP) RATING WITH STANDARD GLAZING.

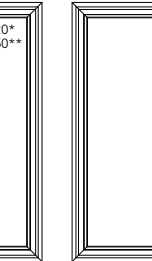
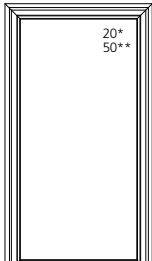
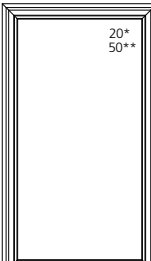
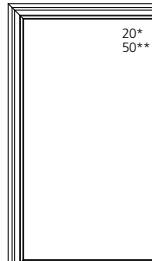
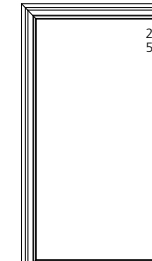
NUMBER INDICATES OPTIONAL DESIGN PRESSURE (DP) RATING.

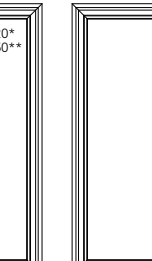
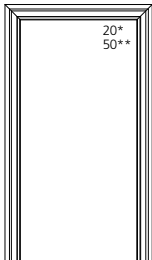
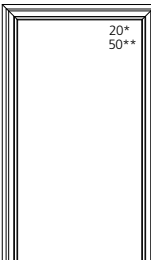
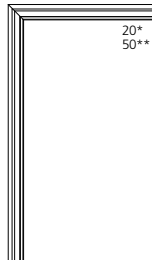
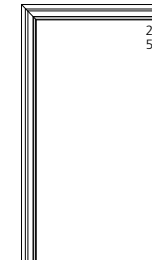
Note: Elevations shown DO NOT have exterior trim. Subtract 1/2" (12.7) from M.O. (Masonry Opening) for Unit Sizes. Masonry Openings above include Sill Nose, see Trim Options page for Sill Nose specifications. For other Trim Options refer to the Unit Sizing, Rough Opening & Masonry Openings page.

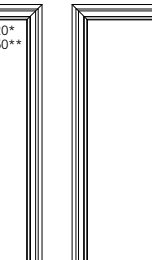
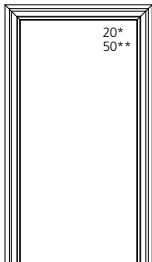
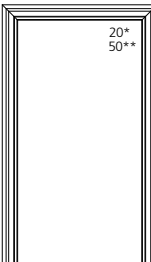
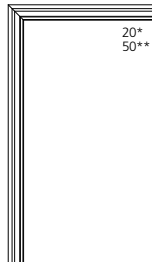
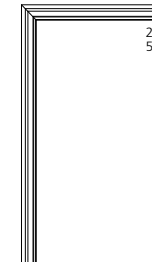
SCALE: 1/4" = 1'

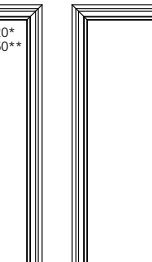
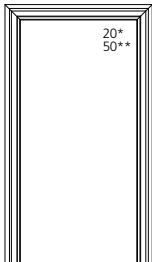
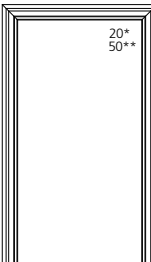
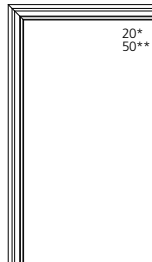
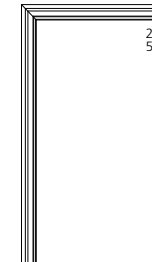
PICTURE UNITS

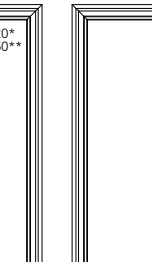
UNIT SIZE	36 3/4" (933)	38 3/4" (984)	40 3/4" (1035)	42 3/4" (1086)	44 3/4" (1137)	48 3/4" (1238)				
ROUGH OPENING	34" (864)	36" (914)	38" (965)	40" (1016)	42" (1067)	46" (1168)				
FRAME SIZE	33 1/2" (851)	35 1/2" (902)	37 1/2" (953)	39 1/2" (1003)	41 1/2" (1054)	45 1/2" (1156)				
DAYLIGHT OPENING	29 1/8" (740)	31 1/8" (791)	33 1/8" (841)	35 1/8" (892)	37 1/8" (943)	41 1/8" (1045)				
64 3/4" (1645) 62" (1576) 61 1/2" (1562) 57 1/8" (1451)	 MPCB3462	 MPCB3662	 MPCB3862	 MPCB4062	 MPCB4262	 MPCB4662				
	67 3/4" (1721) 65" (1652) 64 1/2" (1638) 60 1/8" (1527)	 MPCB3465	 MPCB3665	 MPCB3865	 MPCB4065	 MPCB4265	 MPCB4665			
		68 3/4" (1746) 66" (1676) 65 1/2" (1664) 61 1/8" (1553)	 MPCB3466	 MPCB3666	 MPCB3866	 MPCB4066	 MPCB4266	 MPCB4666		
			71 3/4" (1822) 69" (1753) 68 1/2" (1740) 64 1/8" (1629)	 MPCB3469	 MPCB3669	 MPCB3869	 MPCB4069	 MPCB4269	 MPCB4669	
				74 3/4" (1898) 72" (1829) 71 1/2" (1861) 67 1/8" (1705)	 MPCB3472	 MPCB3672	 MPCB3872	 MPCB4072	 MPCB4272	 MPCB4672

ELEVATION SYMBOL LEGEND:

VALUES IN () ARE IN MILLIMETER CONVERSIONS

VALUES IN [] ARE NUMBER OF DAYLIGHT OPENINGS PER UNIT

NUMBER INDICATES DESIGN PRESSURE (DP) RATING WITH STANDARD GLAZING.

NUMBER INDICATES OPTIONAL DESIGN PRESSURE (DP) RATING.

Note: Elevations shown DO NOT have exterior trim. Subtract 1/2" (12.7) from M.O. (Masonry Opening) for Unit Sizes. Masonry Openings above include Sill Nose, see Trim Options page for Sill Nose specifications. For other Trim Options refer to the Unit Sizing, Rough Opening & Masonry Openings page.

SCALE: 1/4" = 1'

PICTURE UNITS

UNIT SIZE
ROUGH OPENING
FRAME SIZE
DAYLIGHT OPENING

36 3/4" (933)
34" (864)
33 1/2" (851)
29 1/8" (740)

38 3/4" (984)
36" (914)
35 1/2" (902)
31 1/8" (791)

40 3/4" (1035)
38" (965)
37 1/2" (953)
33 1/8" (841)

42 3/4" (1086)
40" (1016)
39 1/2" (1003)
35 1/8" (892)

44 3/4" (1137)
42" (1067)
41 1/2" (1054)
37 1/8" (943)

48 3/4" (1238)
46" (1168)
45 1/2" (1156)
41 1/8" (1045)

76 3/4" (1949)
74" (1880)
73 1/2" (1867)
69 1/8" (1756)

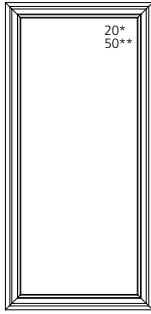

MPCB3474

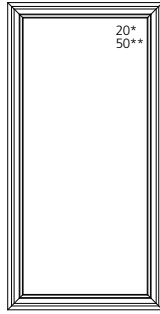

MPCB3674

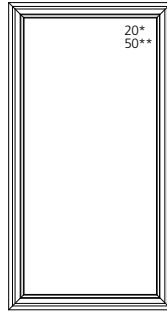

MPCB3874

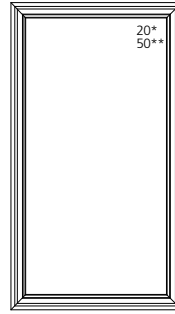

MPCB4074

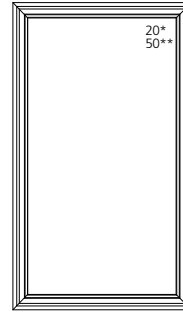

MPCB4274

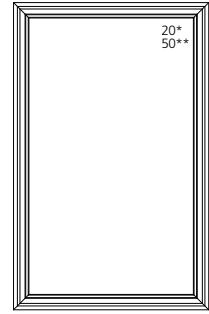

MPCB4674

79 3/4" (2026)
77" (1957)
76 1/2" (1943)
72 1/8" (1832)

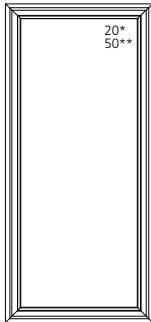

MPCB3477

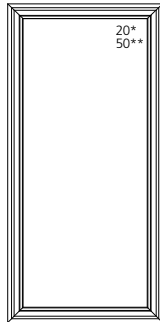

MPCB3677

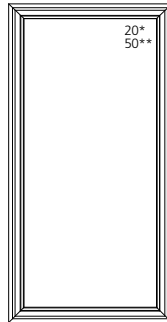

MPCB3877

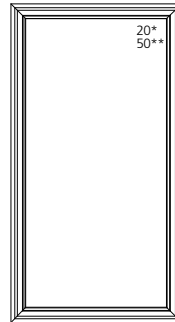

MPCB4077

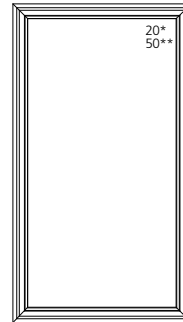

MPCB4277

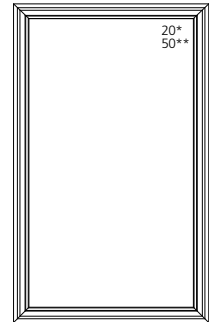

MPCB4677

80 3/4" (2051)
78" (1981)
77 1/2" (1969)
73 1/8" (1857)

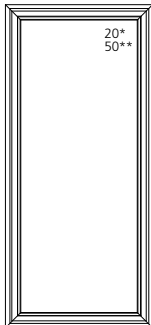

MPCB3478

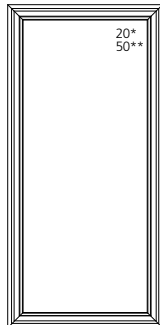

MPCB3678

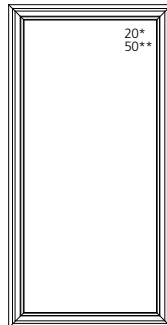

MPCB3878

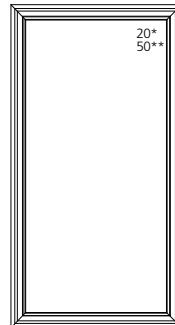

MPCB4078

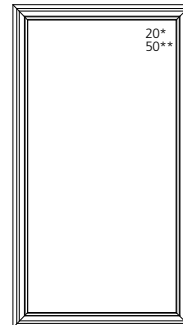

MPCB4278

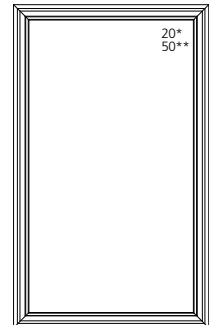

MPCB4678

86 3/4" (2203)
84" (2134)
83 1/2" (2121)
79 1/8" (2010)

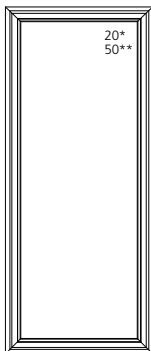

MPCB3484

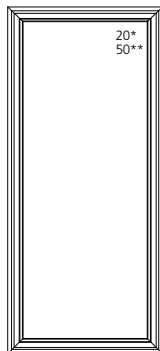

MPCB3684

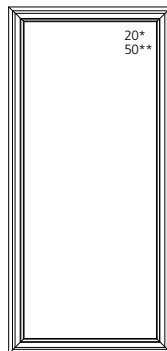

MPCB3884

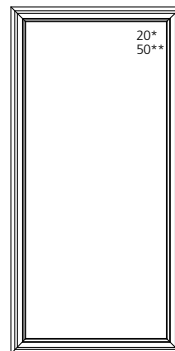

MPCB4084

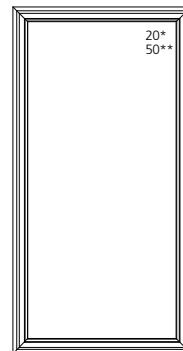

MPCB4284

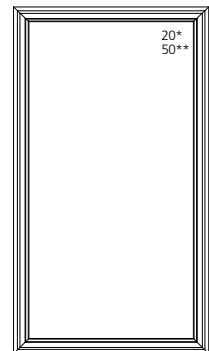

MPCB4684

ELEVATION SYMBOL LEGEND:

VALUES IN () ARE IN MILLIMETER CONVERSIONS
VALUES IN [] ARE NUMBER OF DAYLIGHT OPENINGS PER UNIT

NUMBER INDICATES DESIGN PRESSURE (DP) RATING WITH STANDARD GLAZING.

NUMBER INDICATES OPTIONAL DESIGN PRESSURE (DP) RATING.

Note: Elevations shown DO NOT have exterior trim. Subtract 1/2" (12.7) from M.O. (Masonry Opening) for Unit Sizes. Masonry Openings above include Sill Nose, see Trim Options page for Sill Nose specifications. For other Trim Options refer to the Unit Sizing, Rough Opening & Masonry Openings page.

SCALE: 1/4" = 1'

PICTURE UNITS

UNIT SIZE
ROUGH OPENING
FRAME SIZE
DAYLIGHT OPENING

36 3/4" (933)
34" (864)
33 1/2" (851)
29 1/8" (740)

92 3/4" (2356)
90" (2286)
89 1/2" (2273)
85 1/8" (2162)

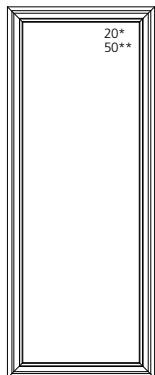

MPCB3490

38 3/4" (984)
36" (914)
35 1/2" (902)
31 1/8" (791)

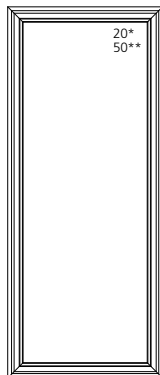

MPCB3690

40 3/4" (1035)
38" (965)
37 1/2" (953)
33 1/8" (841)

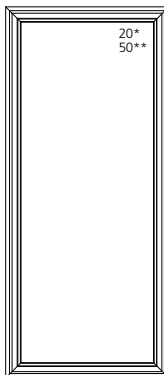

MPCB3890

42 3/4" (1086)
40" (1016)
39 1/2" (1003)
35 1/8" (892)

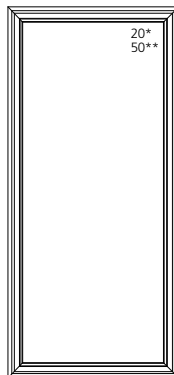

MPCB4090

44 3/4" (1137)
42" (1067)
41 1/2" (1054)
37 1/8" (943)

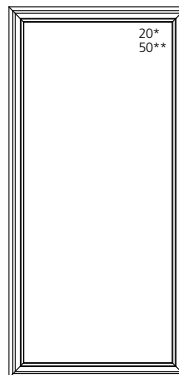

MPCB4290

48 3/4" (1238)
46" (1168)
45 1/2" (1156)
41 1/8" (1045)

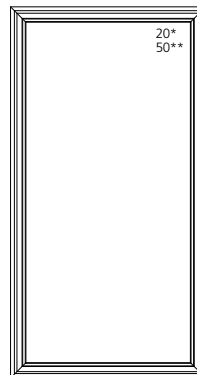

MPCB4690

98 3/4" (2508)
96" (2438)
95 1/2" (2426)
91 1/8" (2315)

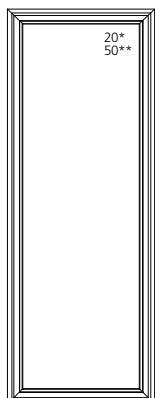

MPCB3496

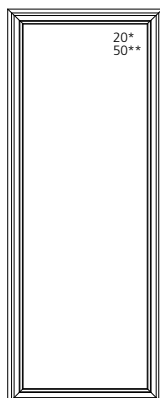

MPCB3696

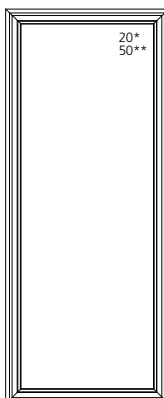

MPCB3896

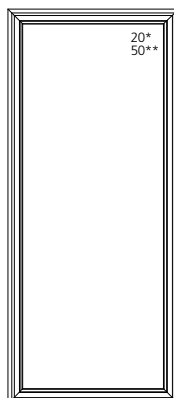

MPCB4096

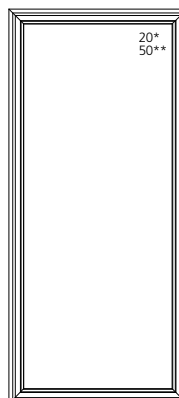

MPCB4296

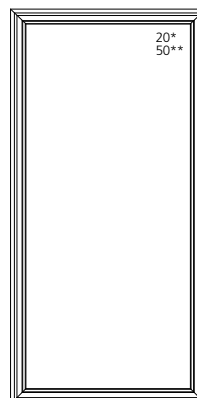

MPCB4696

ELEVATION SYMBOL LEGEND:

VALUES IN () ARE IN MILLIMETER CONVERSIONS
VALUES IN [] ARE NUMBER OF DAYLIGHT OPENINGS PER UNIT

NUMBER INDICATES DESIGN PRESSURE (DP) RATING WITH STANDARD GLAZING.























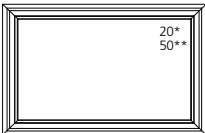

NUMBER INDICATES OPTIONAL DESIGN PRESSURE (DP) RATING.

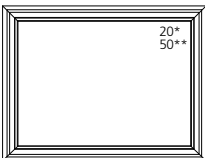
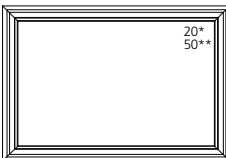
Note: Elevations shown DO NOT have exterior trim. Subtract 1/2" (12.7) from M.O. (Masonry Opening) for Unit Sizes. Masonry Openings above include Sill Nose, see Trim Options page for Sill Nose specifications. For other Trim Options refer to the Unit Sizing, Rough Opening & Masonry Openings page.

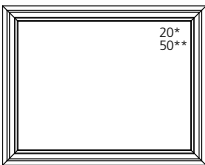
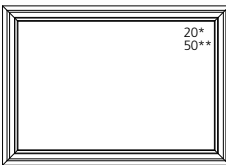
SCALE: 1/4" = 1'

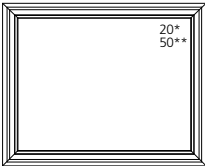
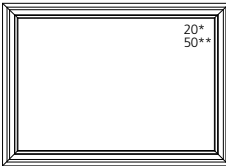
PICTURE UNITS

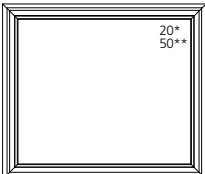
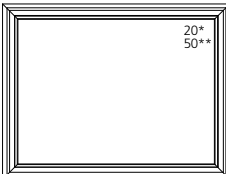
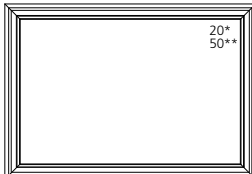
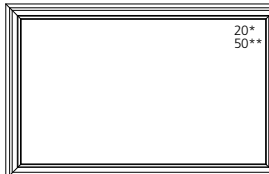
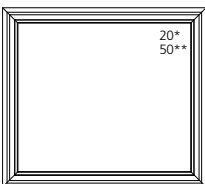
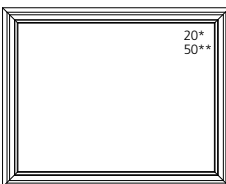
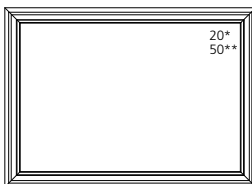
UNIT SIZE
ROUGH OPENING
FRAME SIZE
DAYLIGHT OPENING

	50 3/4" (1289) 48" (1219) 47 1/2" (1207) 43 1/8" (1095)	56 3/4" (1441) 54" (1372) 53 1/2" (1359) 49 1/8" (1248)	62 3/4" (1594) 60" (1524) 59 1/2" (1511) 55 1/8" (1400)	68 3/4" (1746) 66" (1676) 65 1/2" (1664) 61 1/8" (1553)
14 3/4" (375) 12" (305) 11 1/2" (292) 7 1/8" (181)	 MPCB4812	 MPCB5412	 MPCB6012	 MPCB6612
20 3/4" (527) 18" (457) 17 1/2" (445) 13 1/8" (333)	 MPCB4818	 MPCB5418	 MPCB6018	 MPCB6618
26 3/4" (679) 24" (610) 23 1/2" (597) 19 1/8" (486)	 MPCB4824	 MPCB5424	 MPCB6024	 MPCB6624
32 3/4" (832) 30" (762) 29 1/2" (749) 25 1/8" (638)	 MPCB4830	 MPCB5430	 MPCB6030	 MPCB6630
38 3/4" (984) 36" (914) 35 1/2" (902) 31 1/8" (791)	 MPCB4836	 MPCB5436	 MPCB6036	 MPCB6636
39 3/4" (1010) 37" (941) 36 1/2" (927) 32 1/8" (816)	 MPCB4837	 MPCB5437	 MPCB6037	 MPCB6637
40 3/4" (1035) 38" (966) 37 1/2" (953) 33 1/8" (841)	 MPCB4838	 MPCB5438	 MPCB6038	 MPCB6638
43 3/4" (1111) 41" (1042) 40 1/2" (1029) 36 1/8" (918)	 MPCB4841	 MPCB5441	 MPCB6041	 MPCB6641
44 3/4" (1137) 42" (1067) 41 1/2" (1054) 37 1/8" (943)	 MPCB4842	 MPCB5442	 MPCB6042	 MPCB6642

ELEVATION SYMBOL LEGEND:

VALUES IN () ARE IN MILLIMETER CONVERSIONS

VALUES IN [] ARE NUMBER OF DAYLIGHT OPENINGS PER UNIT

NUMBER INDICATES DESIGN PRESSURE (DP) RATING WITH STANDARD GLAZING.

NUMBER INDICATES OPTIONAL DESIGN PRESSURE (DP) RATING.

Note: Elevations shown DO NOT have exterior trim. Subtract 1/2" (12.7) from M.O. (Masonry Opening) for Unit Sizes. Masonry Openings above include Sill Nose, see Trim Options page for Sill Nose specifications. For other Trim Options refer to the Unit Sizing, Rough Opening & Masonry Openings page.

SCALE: 1/4" = 1'

PICTURE UNITS

UNIT SIZE
ROUGH OPENING
FRAME SIZE
DAYLIGHT OPENING

50 3/4" (1289) 48" (1219) 47 1/2" (1207) 43 1/8" (1095)	56 3/4" (1441) 54" (1372) 53 1/2" (1359) 49 1/8" (1248)	62 3/4" (1594) 60" (1524) 59 1/2" (1511) 55 1/8" (1400)	68 3/4" (1746) 66" (1676) 65 1/2" (1664) 61 1/8" (1553)
20* 50**	20* 50**	20* 50**	20* 50**
MPCB4848	MPCB5448	MPCB6048	MPCB6648
51 3/4" (1314) 49" (1245) 48 1/2" (1232) 44 1/8" (1121)			
20* 50**	20* 50**	20* 50**	20* 50**
MPCB4849	MPCB5449	MPCB6049	MPCB6649
55 3/4" (1416) 53" (1347) 52 1/2" (1334) 48 1/8" (1222)			
20* 50**	20* 50**	20* 50**	20* 50**
MPCB4853	MPCB5453	MPCB6053	MPCB6653
56 3/4" (1441) 54" (1372) 53 1/2" (1359) 49 1/8" (1248)			
20* 50**	20* 50**	20* 50**	20* 50**
MPCB4854	MPCB5454	MPCB6054	MPCB6654
59 3/4" (1518) 57" (1449) 56 1/2" (1435) 52 1/8" (1324)			
20* 50**	20* 50**	20* 50**	20* 50**
MPCB4857	MPCB5457	MPCB6057	MPCB6657
62 3/4" (1594) 60" (1524) 59 1/2" (1511) 55 1/8" (1400)			
20* 50**	20* 50**	20* 50**	20* 50**
MPCB4860	MPCB5460	MPCB6060	MPCB6660

ELEVATION SYMBOL LEGEND:

VALUES IN () ARE IN MILLIMETER CONVERSIONS

VALUES IN [] ARE NUMBER OF DAYLIGHT OPENINGS PER UNIT

NUMBER INDICATES DESIGN PRESSURE (DP) RATING WITH STANDARD GLAZING.

###* NUMBER INDICATES OPTIONAL DESIGN PRESSURE (DP) RATING.

Note: Elevations shown DO NOT have exterior trim. Subtract 1/2" (12.7) from M.O. (Masonry Opening) for Unit Sizes. Masonry Openings above include Sill Nose, see Trim Options page for Sill Nose specifications. For other Trim Options refer to the Unit Sizing, Rough Opening & Masonry Openings page.

SCALE: 1/4" = 1'

PICTURE UNITS

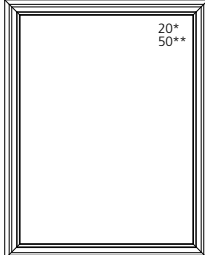
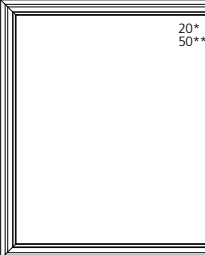
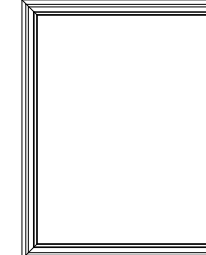
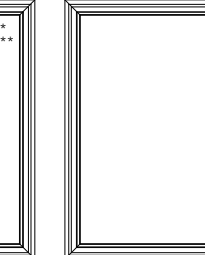
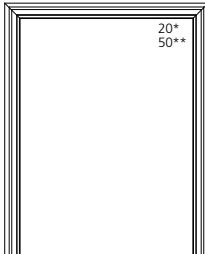
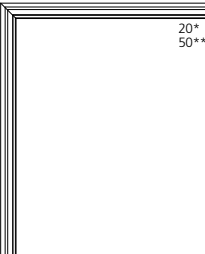
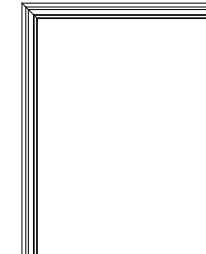
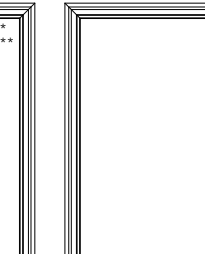
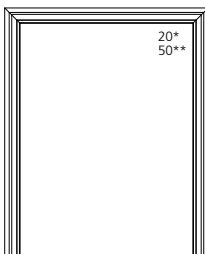
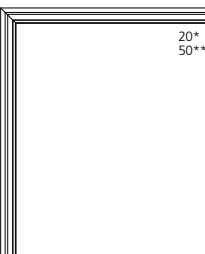
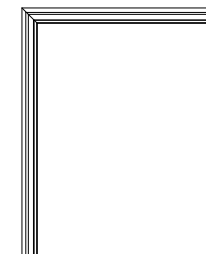
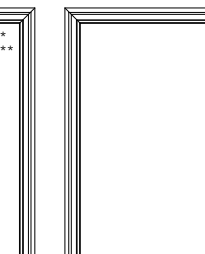
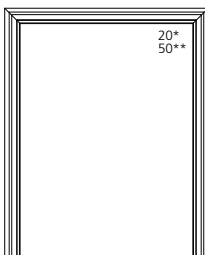
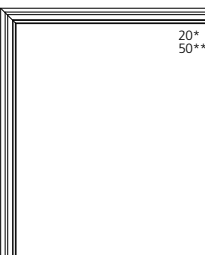
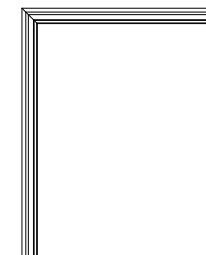
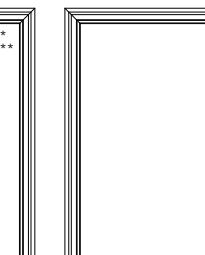
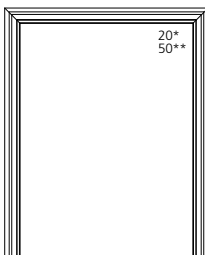
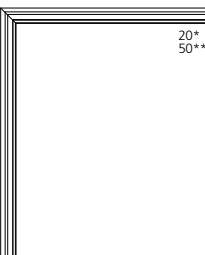
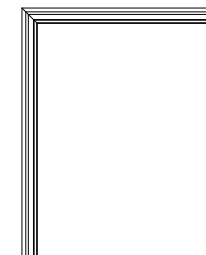
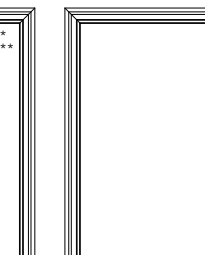
UNIT SIZE	50 3/4"(1289)	56 3/4"(1441)	62 3/4"(1594)	68 3/4"(1746)
ROUGH OPENING	48"(1219)	54"(1372)	60"(1524)	66"(1676)
FRAME SIZE	47 1/2"(1207)	53 1/2"(1359)	59 1/2"(1511)	65 1/2"(1664)
DAYLIGHT OPENING	43 1/8"(1095)	49 1/8"(1248)	55 1/8"(1400)	61 1/8"(1553)
64 3/4"(1645) 62"(1576) 61 1/2"(1562) 57 1/8"(1451)	 MPCB4862	 MPCB5462	 MPCB6062	 MPCB6662
67 3/4"(1721) 65"(1652) 64 1/2"(1638) 60 1/8"(1527)	 MPCB4865	 MPCB5465	 MPCB6065	 MPCB6665
68 3/4"(1746) 66"(1676) 65 1/2"(1664) 61 1/8"(1553)	 MPCB4866	 MPCB5466	 MPCB6066	 MPCB6666
71 3/4"(1822) 69"(1753) 68 1/2"(1740) 64 1/8"(1629)	 MPCB4869	 MPCB5469	 MPCB6069	 MPCB6669
74 3/4"(1899) 72"(1829) 71 1/2"(1861) 67 1/8"(1705)	 MPCB4872	 MPCB5472	 MPCB6072	 MPCB6672

ELEVATION SYMBOL LEGEND:

VALUES IN () ARE IN MILLIMETER CONVERSIONS
VALUES IN [] ARE NUMBER OF DAYLIGHT OPENINGS PER UNIT

NUMBER INDICATES DESIGN PRESSURE (DP) RATING WITH STANDARD GLAZING.

NUMBER INDICATES OPTIONAL DESIGN PRESSURE (DP) RATING.

Note: Elevations shown DO NOT have exterior trim. Subtract 1/2" (12.7) from M.O. (Masonry Opening) for Unit Sizes. Masonry Openings above include Sill Nose, see Trim Options page for Sill Nose specifications. For other Trim Options refer to the Unit Sizing, Rough Opening & Masonry Openings page.

SCALE: 1/4" = 1'

PICTURE UNITS

UNIT SIZE
ROUGH OPENING
FRAME SIZE
DAYLIGHT OPENING

50 3/4" (1289)
48" (1219)
47 1/2" (1207)
43 1/8" (1095)

56 3/4" (1441)
54" (1372)
53 1/2" (1359)
49 1/8" (1248)

62 3/4" (1594)
60" (1524)
59 1/2" (1511)
55 1/8" (1400)

68 3/4" (1746)
66" (1676)
65 1/2" (1664)
61 1/8" (1553)

76 3/4" (1949)
74" (1880)
73 1/2" (1867)
69 1/8" (1756)

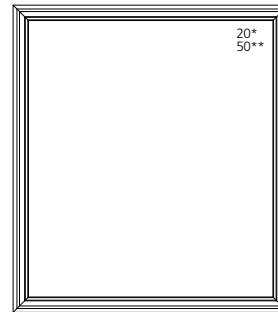
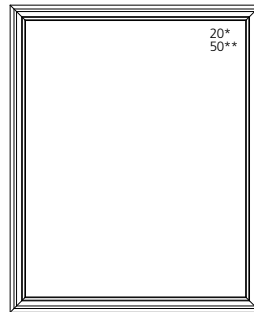
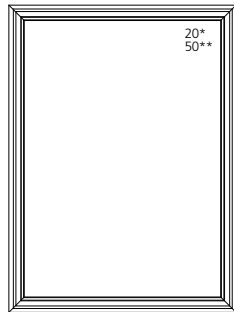
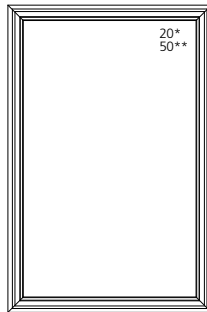

79 3/4" (2026)
77" (1957)
76 1/2" (1943)
72 1/8" (1832)

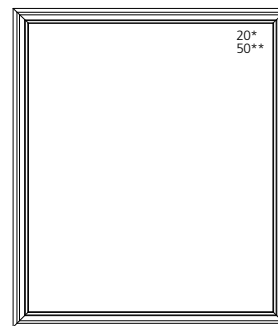
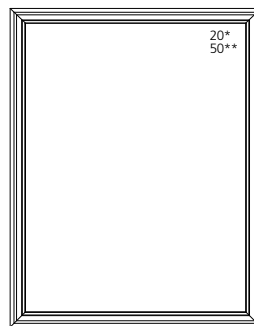
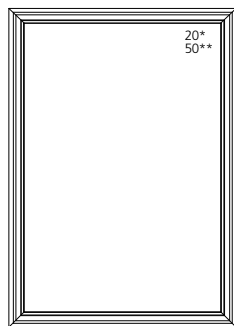
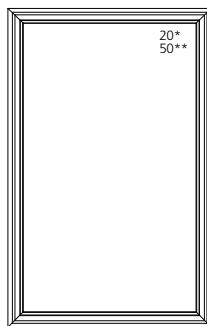

80 3/4" (2051)
78" (1981)
77 1/2" (1969)
73 1/8" (1857)

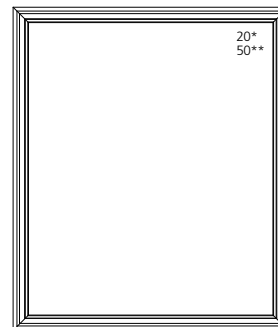
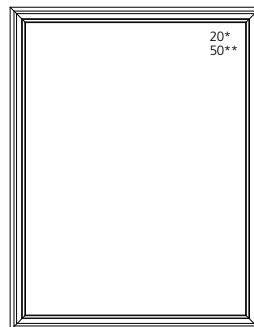
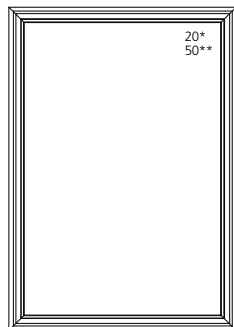
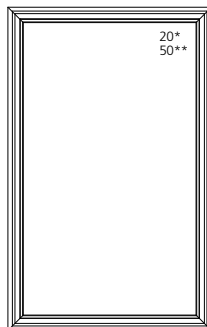

86 3/4" (2203)
84" (2130)
83 1/2" (2117)
79 1/8" (2010)

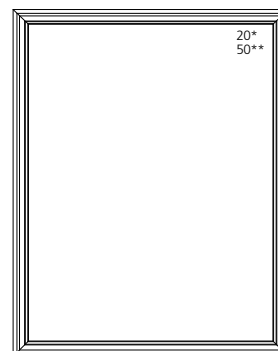
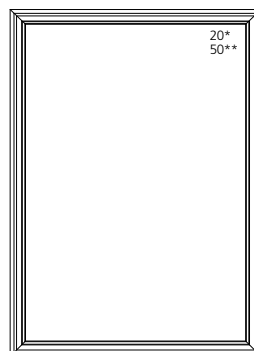
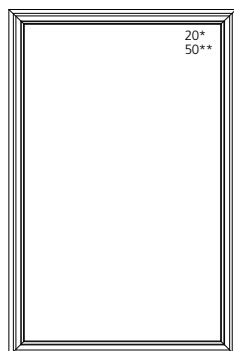
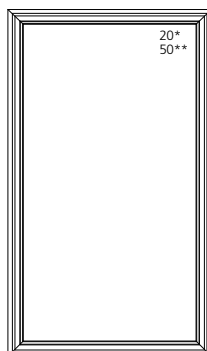

ELEVATION SYMBOL LEGEND:

VALUES IN () ARE IN MILLIMETER CONVERSIONS
VALUES IN [] ARE NUMBER OF DAYLIGHT OPENINGS PER UNIT

NUMBER INDICATES DESIGN PRESSURE (DP) RATING WITH STANDARD GLAZING.

NUMBER INDICATES OPTIONAL DESIGN PRESSURE (DP) RATING.

Note: Elevations shown DO NOT have exterior trim. Subtract 1/2" (12.7) from M.O. (Masonry Opening) for Unit Sizes. Masonry Openings above include Sill Nose, see Trim Options page for Sill Nose specifications. For other Trim Options refer to the Unit Sizing, Rough Opening & Masonry Openings page.

SCALE: 1/4" = 1'

PICTURE UNITS

UNIT SIZE
ROUGH OPENING
FRAME SIZE
DAYLIGHT OPENING

50 3/4"(1289)
48"(1219)
47 1/2"(1207)
43 1/8"(1095)

56 3/4"(1441)
54"(1372)
53 1/2"(1359)
49 1/8"(1248)

62 3/4"(1594)
60"(1524)
59 1/2"(1511)
55 1/8"(1400)

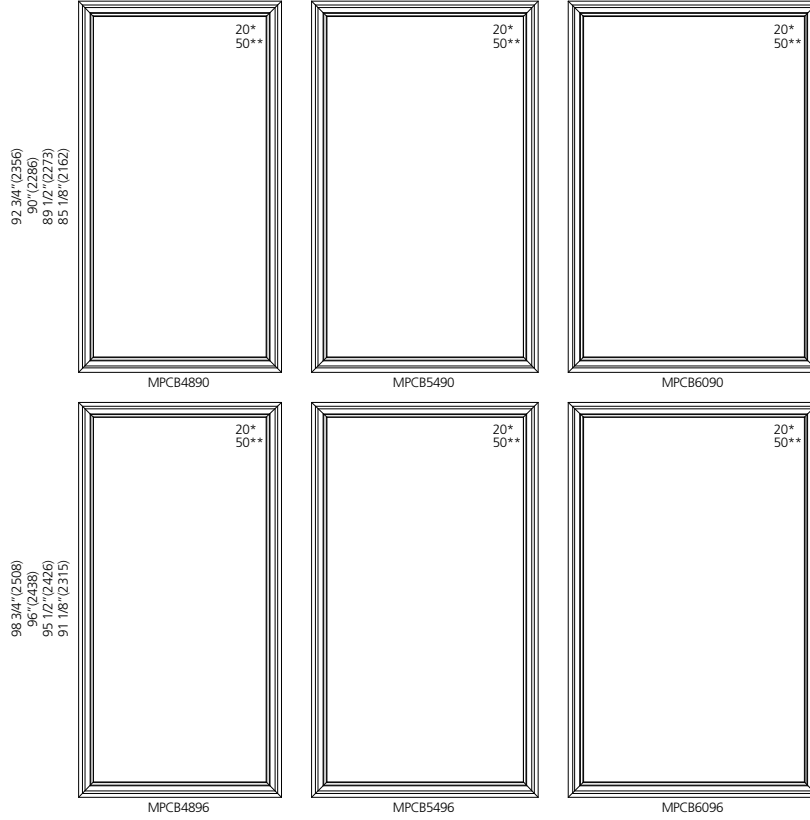

ELEVATION SYMBOL LEGEND:

VALUES IN () ARE IN MILLIMETER CONVERSIONS
VALUES IN [] ARE NUMBER OF DAYLIGHT OPENINGS PER UNIT



























NUMBER INDICATES DESIGN PRESSURE (DP) RATING WITH STANDARD GLAZING.

NUMBER INDICATES OPTIONAL DESIGN PRESSURE (DP) RATING.

Note: Elevations shown DO NOT have exterior trim. Subtract 1/2" (12.7) from M.O. (Masonry Opening) for Unit Sizes. Masonry Openings above include Sill Nose, see Trim Options page for Sill Nose specifications. For other Trim Options refer to the Unit Sizing, Rough Opening & Masonry Openings page.

SCALE: 1/4" = 1'

PICTURE UNITS

UNIT SIZE ROUGH OPENING FRAME SIZE DAYLIGHT OPENING	74 3/4" (1899) 72" (1829) 71 1/2" (1861) 67 1/8" (1705)	80 3/4" (2051) 78" (1981) 77 1/2" (1969) 73 1/8" (1857)	86 3/4" (2203) 84" (2134) 83 1/2" (2121) 79 1/8" (2010)
14 3/4" (375) 12" (305) 11 1/2" (292) 7 1/8" (181)	 MPCB7212	 MPCB7812	 MPCB8412
20 3/4" (527) 18" (457) 17 1/2" (445) 13 1/8" (333)	 MPCB7218	 MPCB7818	 MPCB8418
26 3/4" (679) 24" (610) 23 1/2" (597) 19 1/8" (486)	 MPCB7224	 MPCB7824	 MPCB8424
32 3/4" (832) 30" (762) 29 1/2" (749) 25 1/8" (638)	 MPCB7230	 MPCB7830	 MPCB8430
38 3/4" (984) 36" (914) 35 1/2" (902) 31 1/8" (791)	 MPCB7236	 MPCB7836	 MPCB8436
39 3/4" (1010) 37" (941) 36 1/2" (927) 32 1/8" (816)	 MPCB7237	 MPCB7837	 MPCB8437
40 3/4" (1035) 38" (966) 37 1/2" (953) 33 1/8" (841)	 MPCB7238	 MPCB7838	 MPCB8438
43 3/4" (1111) 41" (1042) 40 1/2" (1029) 36 1/8" (918)	 MPCB7241	 MPCB7841	 MPCB8441
44 3/4" (1137) 42" (1067) 41 1/2" (1054) 37 1/8" (943)	 MPCB7242	 MPCB7842	 MPCB8442

ELEVATION SYMBOL LEGEND:

VALUES IN () ARE IN MILLIMETER CONVERSIONS

VALUES IN [] ARE NUMBER OF DAYLIGHT OPENINGS PER UNIT

NUMBER INDICATES DESIGN PRESSURE (DP) RATING WITH STANDARD GLAZING.

NUMBER INDICATES OPTIONAL DESIGN PRESSURE (DP) RATING.

Note: Elevations shown DO NOT have exterior trim. Subtract 1/2" (12.7) from M.O. (Masonry Opening) for Unit Sizes. Masonry Openings above include Sill Nose, see Trim Options page for Sill Nose specifications. For other Trim Options refer to the Unit Sizing, Rough Opening & Masonry Openings page.

SCALE: 1/4" = 1'

PICTURE UNITS

UNIT SIZE
ROUGH OPENING
FRAME SIZE
DAYLIGHT OPENING

74 3/4" (1899)
72" (1829)
71 1/2" (1861)
67 1/8" (1705)

80 3/4" (2051)
78" (1981)
77 1/2" (1969)
73 1/8" (1857)

86 3/4" (2203)
84" (2134)
83 1/2" (2121)
79 1/8" (2010)

50 3/4" (1289)
48" (1219)
47 1/2" (1207)
43 1/8" (1095)



MPCB7248



MPCB7848



MPCB8448

51 3/4" (1314)
49" (1245)
48 1/2" (1232)
44 1/8" (1121)

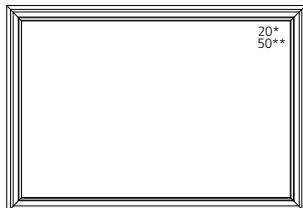

MPCB7249

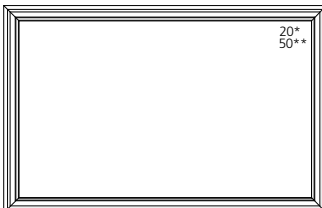

MPCB7849

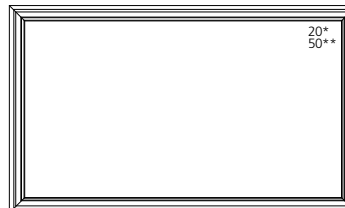

MPCB8449

55 3/4" (1416)
53" (1347)
52 1/2" (1334)
48 1/8" (1222)

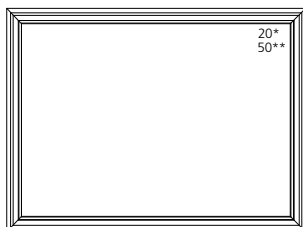

MPCB7253

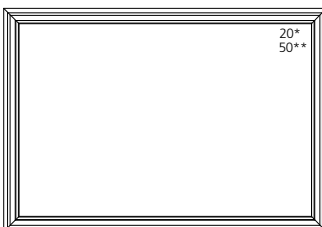

MPCB7853

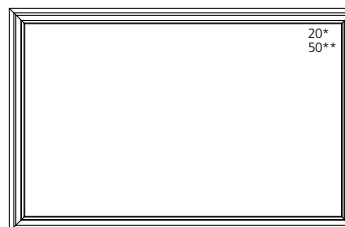

MPCB8453

56 3/4" (1441)
54" (1372)
53 1/2" (1359)
49 1/8" (1246)

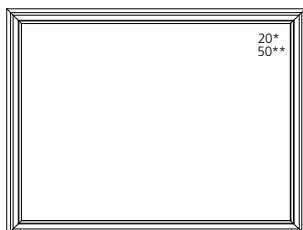

MPCB7254



MPCB7854



MPCB8454

59 3/4" (1518)
57" (1449)
56 1/2" (1435)
52 1/8" (1324)

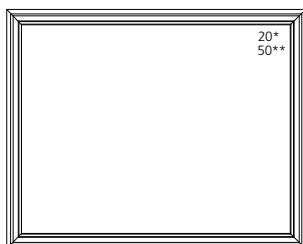

MPCB7257

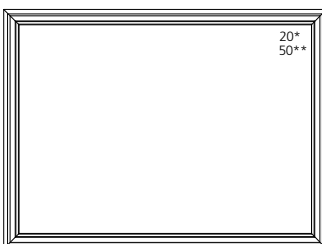

MPCB7857

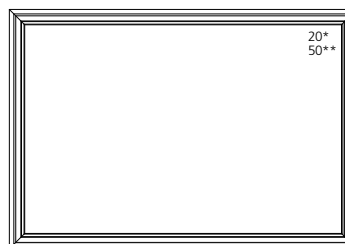

MPCB8457

62 3/4" (1594)
60" (1524)
59 1/2" (1511)
55 1/8" (1400)

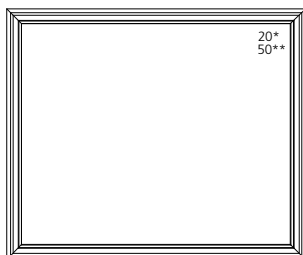

MPCB7260

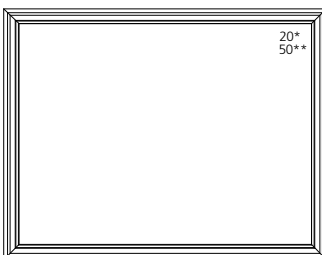

MPCB7860

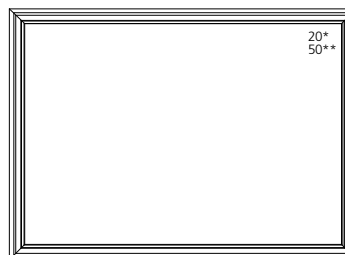

MPCB8460

ELEVATION SYMBOL LEGEND:

VALUES IN () ARE IN MILLIMETER CONVERSIONS

VALUES IN [] ARE NUMBER OF DAYLIGHT OPENINGS PER UNIT

NUMBER INDICATES DESIGN PRESSURE (DP) RATING WITH STANDARD GLAZING.

NUMBER INDICATES OPTIONAL DESIGN PRESSURE (DP) RATING.

Note: Elevations shown DO NOT have exterior trim. Subtract 1/2" (12.7) from M.O. (Masonry Opening) for Unit Sizes. Masonry Openings above include Sill Nose, see Trim Options page for Sill Nose specifications. For other Trim Options refer to the Unit Sizing, Rough Opening & Masonry Openings page.

SCALE: 1/4" = 1'

PICTURE UNITS

UNIT SIZE
ROUGH OPENING
FRAME SIZE
DAYLIGHT OPENING

74 3/4"(1899)
72"(1829)
71 1/2"(1861)
67 1/8"(1705)

80 3/4"(2051)
78"(1981)
77 1/2"(1969)
73 1/8"(1857)

86 3/4"(2203)
84"(2134)
83 1/2"(2121)
79 1/8"(2010)

64 3/4"(1645)
62"(1576)
61 1/2"(1562)
57 1/8"(1451)

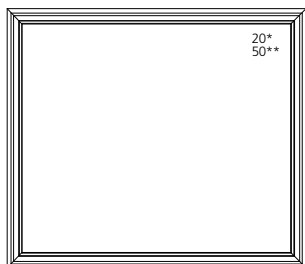

MPCB7262

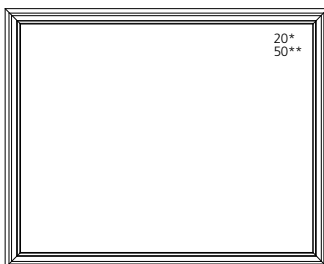

MPCB7862

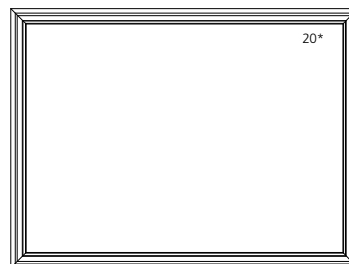

MPCB8462

67 3/4"(1721)
65"(1652)
64 1/2"(1638)
60 1/8"(1527)

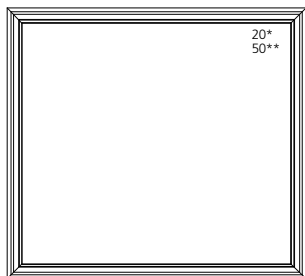

MPCB7265

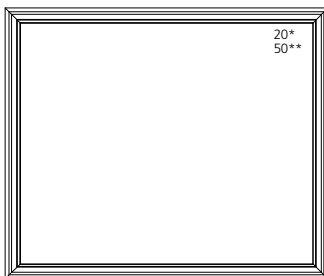

MPCB7865

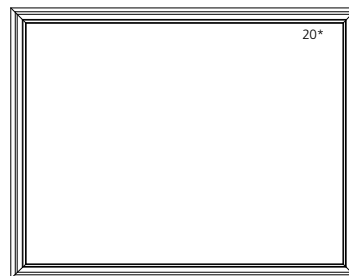

MPCB8465

68 3/4"(1746)
66"(1676)
65 1/2"(1664)
61 1/8"(1553)

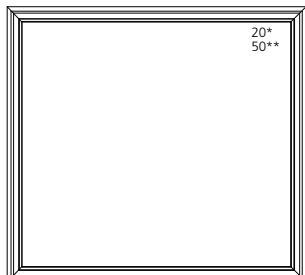

MPCB7266

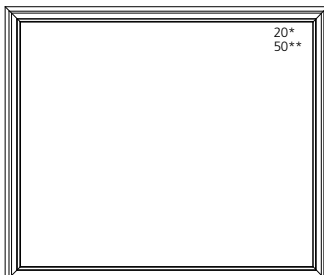

MPCB7866

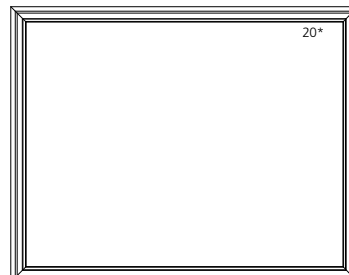

MPCB8466

71 3/4"(1822)
69"(1753)
68 1/2"(1740)
64 1/8"(1629)

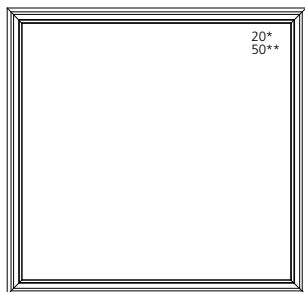

MPCB7269

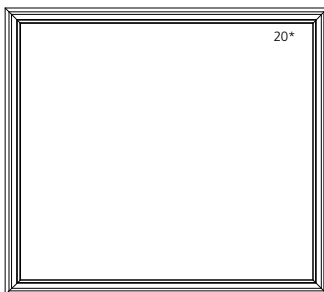

MPCB7869



MPCB8469

74 3/4"(1899)
72"(1829)
71 1/2"(1861)
67 1/8"(1705)

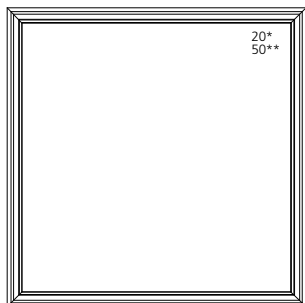

MPCB7272

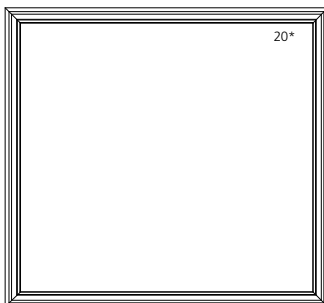

MPCB7872

ELEVATION SYMBOL LEGEND:

VALUES IN () ARE IN MILLIMETER CONVERSIONS

VALUES IN [] ARE NUMBER OF DAYLIGHT OPENINGS PER UNIT

NUMBER INDICATES DESIGN PRESSURE (DP) RATING WITH STANDARD GLAZING.

NUMBER INDICATES OPTIONAL DESIGN PRESSURE (DP) RATING.

Note: Elevations shown DO NOT have exterior trim. Subtract 1/2" (12.7) from M.O. (Masonry Opening) for Unit Sizes. Masonry Openings above include Sill Nose, see Trim Options page for Sill Nose specifications. For other Trim Options refer to the Unit Sizing, Rough Opening & Masonry Openings page.

SCALE: 1/4" = 1'

PICTURE UNITS

UNIT SIZE
ROUGH OPENING
FRAME SIZE
DAYLIGHT OPENING

74 3/4" (1899)
72" (1829)
71 1/2" (1861)
67 1/8" (1705)

80 3/4" (2051)
78" (1981)
77 1/2" (1969)
73 1/8" (1857)

76 3/4" (1949)
74" (1880)
73 1/2" (1867)
69 1/8" (1756)

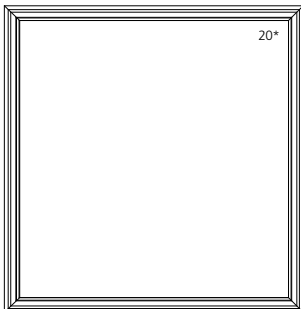

MPCB7274

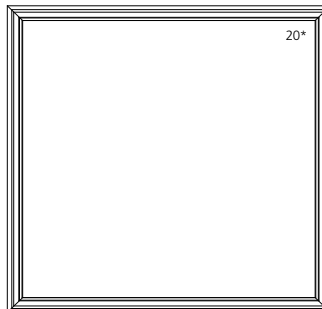

MPCB7874

79 3/4" (2026)
77" (1957)
76 1/2" (1943)
72 1/8" (1832)

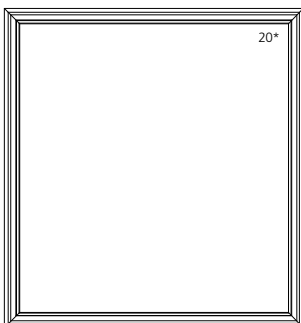

MPCB7277

80 3/4" (2051)
78" (1981)
77 1/2" (1969)
73 1/8" (1857)

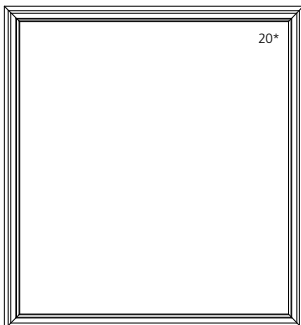

MPCB7278

ELEVATION SYMBOL LEGEND:

VALUES IN () ARE IN MILLIMETER CONVERSIONS
VALUES IN [] ARE NUMBER OF DAYLIGHT OPENINGS PER UNIT



















NUMBER INDICATES DESIGN PRESSURE (DP) RATING WITH STANDARD GLAZING.

NUMBER INDICATES OPTIONAL DESIGN PRESSURE (DP) RATING.

Note: Elevations shown DO NOT have exterior trim. Subtract 1/2" (12.7) from M.O. (Masonry Opening) for Unit Sizes. Masonry Openings above include Sill Nose, see Trim Options page for Sill Nose specifications. For other Trim Options refer to the Unit Sizing, Rough Opening & Masonry Openings page.

SCALE: 1/4" = 1'

PICTURE UNITS

UNIT SIZE ROUGH OPENING FRAME SIZE DAYLIGHT OPENING	92 3/4" (2356) 90" (2286) 89 1/2" (2273) 85 1/8" (2162)	98 3/4" (2508) 96" (2438) 95 1/2" (2426) 91 1/8" (2315)
14 3/4" (375) 12" (305) 11 1/2" (292) 7 1/8" (181)	 MPCB9012	 MPCB9612
20 3/4" (527) 18" (457) 17 1/2" (445) 13 1/8" (333)	 MPCB9018	 MPCB9618
26 3/4" (679) 24" (610) 23 1/2" (597) 19 1/8" (486)	 MPCB9024	 MPCB9624
32 3/4" (832) 30" (762) 29 1/2" (749) 25 1/8" (638)	 MPCB9030	 MPCB9630
38 3/4" (984) 36" (914) 35 1/2" (902) 31 1/8" (791)	 MPCB9036	 MPCB9636
39 3/4" (1010) 37" (941) 36 1/2" (927) 32 1/8" (816)	 MPCB9037	 MPCB9637
40 3/4" (1035) 38" (966) 37 1/2" (953) 33 1/8" (841)	 MPCB9038	 MPCB9638
43 3/4" (1111) 41" (1042) 40 1/2" (1029) 36 1/8" (918)	 MPCB9041	 MPCB9641
44 3/4" (1137) 42" (1067) 41 1/2" (1054) 37 1/8" (943)	 MPCB9042	 MPCB9642

ELEVATION SYMBOL LEGEND:

VALUES IN () ARE IN MILLIMETER CONVERSIONS
VALUES IN [] ARE NUMBER OF DAYLIGHT OPENINGS PER UNIT

NUMBER INDICATES DESIGN PRESSURE (DP) RATING WITH STANDARD GLAZING.

NUMBER INDICATES OPTIONAL DESIGN PRESSURE (DP) RATING.

Note: Elevations shown DO NOT have exterior trim. Subtract 1/2" (12.7) from M.O. (Masonry Opening) for Unit Sizes. Masonry Openings above include Sill Nose, see Trim Options page for Sill Nose specifications. For other Trim Options refer to the Unit Sizing, Rough Opening & Masonry Openings page.

SCALE: 1/4" = 1'

PICTURE UNITS

UNIT SIZE
ROUGH OPENING
FRAME SIZE
DAYLIGHT OPENING

92 3/4" (2356)
90" (2286)
89 1/2" (2273)
85 1/8" (2162)

98 3/4" (2508)
96" (2438)
95 1/2" (2426)
91 1/8" (2315)

50 3/4" (1289)
48" (1219)
47 1/2" (1207)
43 1/8" (1095)

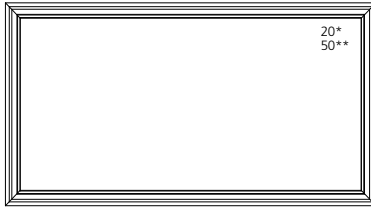

MPCB9048

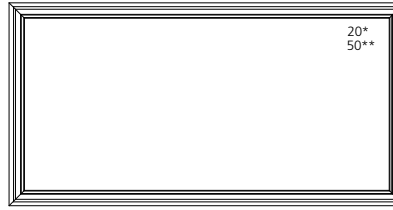

MPCB9648

51 3/4" (1314)
49" (1245)
48 1/2" (1232)
44 1/8" (1121)

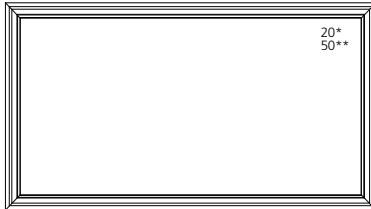

MPCB9049

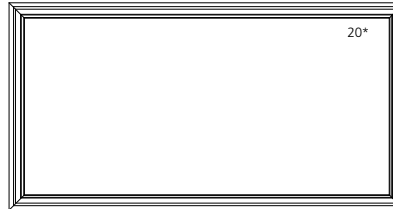

MPCB949

55 3/4" (1416)
53" (1347)
52 1/2" (1334)
48 1/8" (1222)

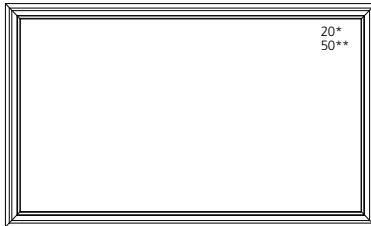

MPCB9053

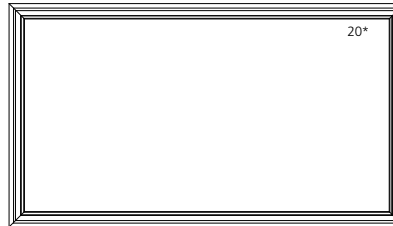

MPCB9653

56 3/4" (1441)
54" (1372)
53 1/2" (1359)
49 1/8" (1248)



MPCB9054



MPCB9654

59 3/4" (1518)
57" (1449)
56 1/2" (1435)
52 1/8" (1324)



MPCB9057



MPCB9657

62 3/4" (1594)
60" (1524)
59 1/2" (1511)
55 1/8" (1400)

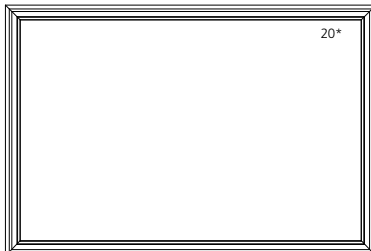

MPCB9060

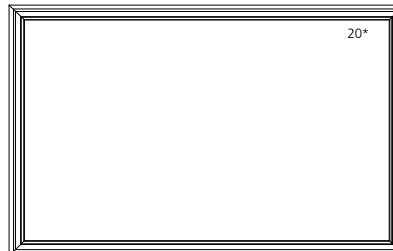

MPCB9660

ELEVATION SYMBOL LEGEND:

VALUES IN () ARE IN MILLIMETER CONVERSIONS
VALUES IN [] ARE NUMBER OF DAYLIGHT OPENINGS PER UNIT

NUMBER INDICATES DESIGN PRESSURE (DP) RATING WITH STANDARD GLAZING.

NUMBER INDICATES OPTIONAL DESIGN PRESSURE (DP) RATING.

Note: Elevations shown DO NOT have exterior trim. Subtract 1/2" (12.7) from M.O. (Masonry Opening) for Unit Sizes. Masonry Openings above include Sill Nose, see Trim Options page for Sill Nose specifications. For other Trim Options refer to the Unit Sizing, Rough Opening & Masonry Openings page.

SCALE: 1/4" = 1'

PICTURE UNITS

UNIT SIZE
ROUGH OPENING
FRAME SIZE
DAYLIGHT OPENING

92 3/4" (2356)
90" (2286)
89 1/2" (2273)
85 1/8" (2162)

64 3/4" (1645)
62" (1576)
61 1/2" (1562)
57 1/8" (1451)

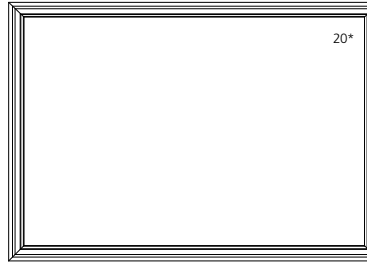

ELEVATION SYMBOL LEGEND:

VALUES IN () ARE IN MILLIMETER CONVERSIONS
VALUES IN [] ARE NUMBER OF DAYLIGHT OPENINGS PER UNIT

NUMBER INDICATES DESIGN PRESSURE (DP) RATING WITH STANDARD GLAZING.
NUMBER INDICATES OPTIONAL DESIGN PRESSURE (DP) RATING.

Note: Elevations shown DO NOT have exterior trim. Subtract 1/2" (12.7) from M.O. (Masonry Opening) for Unit Sizes. Masonry Openings above include Sill Nose, see Trim Options page for Sill Nose specifications. For other Trim Options refer to the Unit Sizing, Rough Opening & Masonry Openings page.

SCALE: 1/4" = 1'

2-WIDE PICTURE UNITS

UNIT SIZE	26 3/4" (679)	38 3/4" (984)	50 3/4" (1289)	62 3/4" (1594)	74 3/4" (1899)	86 3/4" (2203)	98 3/4" (2508)
ROUGH OPENING	24" (610)	36" (914)	48" (1219)	60" (1524)	72" (1829)	84" (2134)	96" (2438)
FRAME SIZE	23 1/2" (597)	35 1/2" (902)	47 1/2" (1207)	59 1/2" (1511)	71 1/2" (1861)	83 1/2" (2121)	95 1/2" (2426)
DAYLIGHT OPENING	6 5/8" (169)[2]	12 5/8" (321)[2]	18 5/8" (473)[2]	24 5/8" (625)[2]	30 5/8" (778)[2]	36 5/8" (930)[2]	42 5/8" (1083)[2]
14 3/4" (375) 12" (305) 11 1/2" (292) 7 1/8" (181)	MPCB2412-2	MPCB3612-2	MPCB4812-2	MPCB6012-2	MPCB7212-2	MPCB8412-2	MPCB9612-2
20 3/4" (527) 18" (457) 17 1/2" (445) 13 1/8" (333)	MPCB2418-2	MPCB3618-2	MPCB4818-2	MPCB6018-2	MPCB7218-2	MPCB8418-2	MPCB9618-2
26 3/4" (679) 24" (610) 23 1/2" (597) 19 1/8" (486)	MPCB2424-2	MPCB3624-2	MPCB4824-2	MPCB6024-2	MPCB7224-2	MPCB8424-2	MPCB9624-2
32 3/4" (832) 30" (762) 29 1/2" (749) 25 1/8" (638)	MPCB2430-2	MPCB3630-2	MPCB4830-2	MPCB6030-2	MPCB7230-2	MPCB8430-2	MPCB9630-2
38 3/4" (984) 36" (914) 35 1/2" (902) 31 1/8" (791)	MPCB2436-2	MPCB3636-2	MPCB4836-2	MPCB6036-2	MPCB7236-2	MPCB8436-2	MPCB9636-2
44 3/4" (1137) 42" (1067) 41 1/2" (1054) 37 1/8" (943)	MPCB2442-2	MPCB3642-2	MPCB4842-2	MPCB6042-2	MPCB7242-2	MPCB8442-2	MPCB9642-2
50 3/4" (1289) 48" (1219) 47 1/2" (1207) 43 1/8" (1095)	MPCB2448-2	MPCB3648-2	MPCB4848-2	MPCB6048-2	MPCB7248-2	MPCB8448-2	MPCB9648-2
56 3/4" (1441) 54" (1372) 53 1/2" (1359) 49 1/8" (1248)	MPCB2454-2	MPCB3654-2	MPCB4854-2	MPCB6054-2	MPCB7254-2	MPCB8454-2	MPCB9654-2
62 3/4" (1594) 60" (1524) 59 1/2" (1511) 55 1/8" (1400)	MPCB2460-2	MPCB3660-2	MPCB4860-2	MPCB6060-2	MPCB7260-2	MPCB8460-2	MPCB9660-2
68 3/4" (1746) 66" (1676) 65 1/2" (1664) 61 1/8" (1553)	MPCB2466-2	MPCB3666-2	MPCB4866-2	MPCB6066-2	MPCB7266-2	MPCB8466-2	MPCB9666-2
74 3/4" (1899) 72" (1829) 71 1/2" (1861) 67 1/8" (1705)	MPCB2472-2	MPCB3672-2	MPCB4872-2	MPCB6072-2	MPCB7272-2	MPCB8472-2	MPCB9672-2

ELEVATION SYMBOL LEGEND:











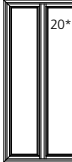





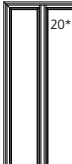





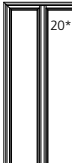

VALUES IN () ARE IN MILLIMETER CONVERSIONS
VALUES IN [] ARE NUMBER OF DAYLIGHT OPENINGS PER UNIT

NUMBER INDICATES DESIGN PRESSURE (DP) RATING WITH STANDARD GLAZING.

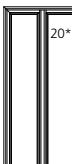
Note: Elevations shown DO NOT have exterior trim. Subtract 1/2" (12.7) from M.O. (Masonry Opening) for Unit Sizes. Masonry Openings above include Sill Nose, see Trim Options page for Sill Nose specifications. For other Trim Options refer to the Unit Sizing, Rough Opening & Masonry Openings page.

SCALE: 1/8" = 1'

2-WIDE PICTURE UNITS

UNIT SIZE	26 3/4" (679)	38 3/4" (984)	50 3/4" (1289)	62 3/4" (1594)	74 3/4" (1899)	86 3/4" (2203)	98 3/4" (2508)
ROUGH OPENING	24" (610)	36" (914)	48" (1219)	60" (1524)	72" (1829)	84" (2134)	96" (2438)
FRAME SIZE	23 1/2" (597)	35 1/2" (902)	47 1/2" (1207)	59 1/2" (1511)	71 1/2" (1861)	83 1/2" (2121)	95 1/2" (2426)
DAYLIGHT OPENING	6 5/8" (168)[2]	12 5/8" (321)[2]	18 5/8" (473)[2]	24 5/8" (625)[2]	30 5/8" (778)[2]	36 5/8" (930)[2]	42 5/8" (1083)[2]
80 3/4" (2051) 78" (1981) 77 1/2" (1969) 73 1/8" (1857)	 20*	 20*	 20*	 20*	 20*	 20*	 20*
MPCB2478-2	MPCB3678-2	MPCB4878-2	MPCB6078-2	MPCB7278-2	MPCB8478-2	MPCB9678-2	
86 3/4" (2203) 84" (2134) 83 1/2" (2121) 79 1/8" (2010)	 20*	 20*	 20*	 20*	 20*	 20*	 20*
MPCB2484-2	MPCB3684-2	MPCB4884-2	MPCB6084-2	MPCB7284-2	MPCB8484-2	MPCB9684-2	
92 3/4" (2356) 90" (2286) 89 1/2" (2273) 85 1/8" (2162)	 20*	 20*	 20*	 20*	 20*	 20*	 20*
MPCB2490-2	MPCB3690-2	MPCB4890-2	MPCB6090-2	MPCB7290-2	MPCB8490-2	MPCB9690-2	
98 3/4" (2508) 96" (2438) 95 1/2" (2426) 91 1/8" (2315)	 20*	 20*	 20*	 20*	 20*	 20*	 20*
MPCB2496-2	MPCB3696-2	MPCB4896-2	MPCB6096-2	MPCB7296-2	MPCB8496-2	MPCB9696-2	

ELEVATION SYMBOL LEGEND:























VALUES IN () ARE IN MILLIMETER CONVERSIONS
VALUES IN [] ARE NUMBER OF DAYLIGHT OPENINGS PER UNIT

NUMBER INDICATES DESIGN PRESSURE (DP) RATING WITH STANDARD GLAZING.

Note: Elevations shown DO NOT have exterior trim. Subtract 1/2" (12.7) from M.O. (Masonry Opening) for Unit Sizes. Masonry Openings above include Sill Nose, see Trim Options page for Sill Nose specifications. For other Trim Options refer to the Unit Sizing, Rough Opening & Masonry Openings page.

SCALE: 1/8" = 1'

2-WIDE PICTURE UNITS

UNIT SIZE ROUGH OPENING FRAME SIZE DAYLIGHT OPENING	110 3/4" (2813) 108" (2743) 107 1/2" (2731) 48 5/8" (1235)[2]	122 3/4" (3118) 120" (3048) 119 1/2" (3035) 54 5/8" (1387)[2]
14 3/4" (375) 12" (305) 11 1/2" (292) 7 1/8" (181)	 MPCB10812-2	 MPCB12012-2
20 3/4" (527) 18" (457) 17 1/2" (445) 13 1/8" (333)	 MPCB10818-2	 MPCB12018-2
26 3/4" (679) 24" (610) 23 1/2" (597) 19 1/8" (486)	 MPCB10824-2	 MPCB12024-2
32 3/4" (832) 30" (762) 29 1/2" (749) 25 1/8" (638)	 MPCB10830-2	 MPCB12030-2
38 3/4" (984) 36" (914) 35 1/2" (902) 31 1/8" (791)	 MPCB10836-2	 MPCB12036-2
44 3/4" (1137) 42" (1067) 41 1/2" (1054) 37 1/8" (943)	 MPCB10842-2	 MPCB12042-2
50 3/4" (1289) 48" (1219) 47 1/2" (1207) 43 1/8" (1095)	 MPCB10848-2	 MPCB12048-2
56 3/4" (1441) 54" (1372) 53 1/2" (1359) 49 1/8" (1248)	 MPCB10854-2	 MPCB12054-2
62 3/4" (1594) 60" (1524) 59 1/2" (1511) 55 1/8" (1400)	 MPCB10860-2	 MPCB12060-2
68 3/4" (1746) 66" (1676) 65 1/2" (1664) 61 1/8" (1553)	 MPCB10866-2	 MPCB12066-2
74 3/4" (1899) 72" (1829) 71 1/2" (1816) 67 1/8" (1705)	 MPCB10872-2	 MPCB12072-2

ELEVATION SYMBOL LEGEND:

VALUES IN () ARE IN MILLIMETER CONVERSIONS
VALUES IN [] ARE NUMBER OF DAYLIGHT OPENINGS PER UNIT

NUMBER INDICATES DESIGN PRESSURE (DP) RATING WITH STANDARD GLAZING.

Note: Elevations shown DO NOT have exterior trim. Subtract 1/2" (12.7) from M.O. (Masonry Opening) for Unit Sizes. Masonry Openings above include Sill Nose, see Trim Options page for Sill Nose specifications. For other Trim Options refer to the Unit Sizing, Rough Opening & Masonry Openings page.

SCALE: 1/8" = 1'

2-WIDE PICTURE UNITS

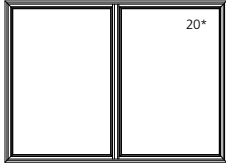
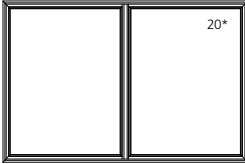
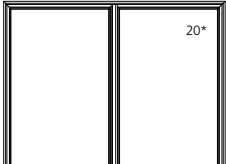
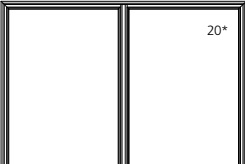
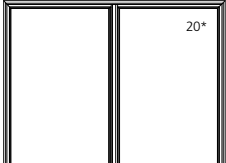
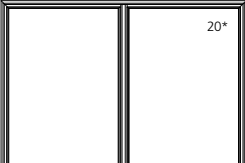
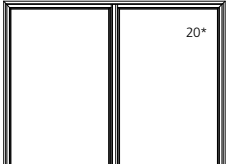
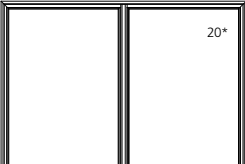
UNIT SIZE	110 3/4" (2813)	122 3/4" (3118)
ROUGH OPENING	108" (2743)	120" (3048)
FRAME SIZE	107 1/2" (2731)	119 1/2" (3035)
DAYLIGHT OPENING	48 5/8" (1235)[2]	54 5/8" (1387)[2]
80 3/4" (2051) 78" (1981) 77 1/2" (1969) 73 1/8" (1857)		
	MPCB10878-2	MPCB12078-2
86 3/4" (2203) 84" (2134) 83 1/2" (2121) 79 1/8" (2010)		
	MPCB10884-2	MPCB12084-2
92 3/4" (2356) 90" (2286) 89 1/2" (2273) 85 1/8" (2162)		
	MPCB10890-2	MPCB12090-2
98 3/4" (2508) 96" (2438) 95 1/2" (2426) 91 1/8" (2315)		
	MPCB10896-2	MPCB12096-2

ELEVATION SYMBOL LEGEND:

VALUES IN () ARE IN MILLIMETER CONVERSIONS
VALUES IN [] ARE NUMBER OF DAYLIGHT OPENINGS PER UNIT

NUMBER INDICATES DESIGN PRESSURE (DP) RATING WITH STANDARD GLAZING.

Note: Elevations shown DO NOT have exterior trim. Subtract 1/2" (12.7) from M.O. (Masonry Opening) for Unit Sizes. Masonry Openings above include Sill Nose, see Trim Options page for Sill Nose specifications. For other Trim Options refer to the Unit Sizing, Rough Opening & Masonry Openings page.

SCALE: 1/8" = 1'

3-WIDE PICTURE UNITS

UNIT SIZE
ROUGH OPENING
FRAME SIZE
DAYLIGHT OPENING























































38 3/4" (984)
36" (914)
35 1/2" (902)
6 3/4" (171)[3]

56 3/4" (1441)
54" (1372)
53 1/2" (1359)
12 3/4" (324)[3]

74 3/4" (1899)
72" (1829)
71 1/2" (1861)
18 3/4" (476)[3]

92 3/4" (2356)
90" (2286)
89 1/2" (2273)
24 3/4" (629)[3]

110 3/4" (2813)
108" (2743)
107 1/2" (2731)
30 3/4" (781)[3]

14 3/4" (375) 12" (305) 11 1/2" (292) 7 1/8" (181)	 20*	 20*	 20*	 20*	 20*
20 3/4" (527) 18" (457) 17 1/2" (445) 13 1/8" (333)	 20*	 20*	 20*	 20*	 20*
26 3/4" (679) 24" (610) 23 1/2" (597) 19 1/8" (486)	 20*	 20*	 20*	 20*	 20*
32 3/4" (832) 30" (762) 29 1/2" (749) 25 1/8" (638)	 20*	 20*	 20*	 20*	 20*
38 3/4" (984) 36" (914) 35 1/2" (902) 31 1/8" (791)	 20*	 20*	 20*	 20*	 20*
44 3/4" (1137) 42" (1067) 41 1/2" (1054) 37 1/8" (943)	 20*	 20*	 20*	 20*	 20*
50 3/4" (1289) 48" (1219) 47 1/2" (1207) 43 1/8" (1095)	 20*	 20*	 20*	 20*	 20*
56 3/4" (1441) 54" (1372) 53 1/2" (1359) 49 1/8" (1248)	 20*	 20*	 20*	 20*	 20*
62 3/4" (1594) 60" (1524) 59 1/2" (1511) 55 1/8" (1400)	 20*	 20*	 20*	 20*	 20*
68 3/4" (1746) 66" (1676) 65 1/2" (1664) 61 1/8" (1553)	 20*	 20*	 20*	 20*	 20*
74 3/4" (1899) 72" (1829) 71 1/2" (1861) 67 1/8" (1705)	 20*	 20*	 20*	 20*	 20*

ELEVATION SYMBOL LEGEND:

VALUES IN () ARE IN MILLIMETER CONVERSIONS
VALUES IN [] ARE NUMBER OF DAYLIGHT OPENINGS PER UNIT

NUMBER INDICATES DESIGN PRESSURE (DP) RATING WITH STANDARD GLAZING.

NUMBER INDICATES OPTIONAL DESIGN PRESSURE (DP) RATING.

Note: Elevations shown DO NOT have exterior trim. Subtract 1/2" (12.7) from M.O. (Masonry Opening) for Unit Sizes. Masonry Openings above include Sill Nose, see Trim Options page for Sill Nose specifications. For other Trim Options refer to the Unit Sizing, Rough Opening & Masonry Openings page.

SCALE: 1/8" = 1'

3-WIDE PICTURE UNITS

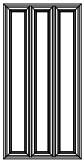
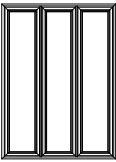
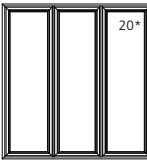
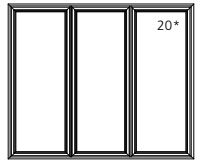
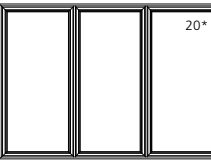
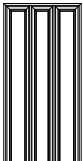
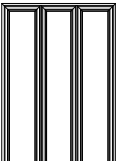
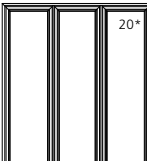
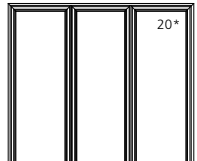
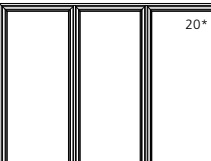
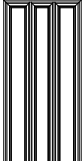
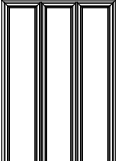
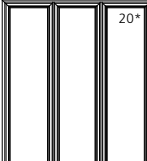
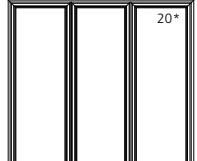
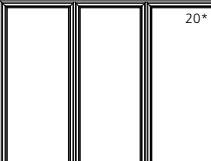
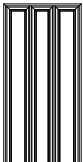
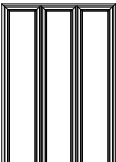
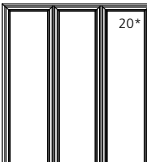
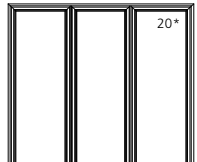
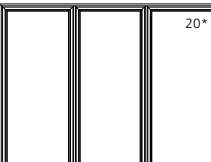
UNIT SIZE	38 3/4" (984)	56 3/4" (1441)	74 3/4" (1899)	92 3/4" (2356)	110 3/4" (2813)
ROUGH OPENING	36" (914)	54" (1372)	72" (1829)	90" (2286)	108" (2743)
FRAME SIZE	35 1/2" (902)	53 1/2" (1359)	71 1/2" (1861)	89 1/2" (2273)	107 1/2" (2731)
DAYLIGHT OPENING	6 3/4" (171)[3]	12 3/4" (324)[3]	18 3/4" (476)[3]	24 3/4" (629)[3]	30 3/4" (781)[3]
80 3/4" (2051) 78" (1981) 77 1/2" (1969) 73 1/8" (1857)	 20*	 20*	 20*	 20*	 20*
MPCB3678-3	MPCB5478-3	MPCB7278-3	MPCB9078-3	MPCB10878-3	
86 3/4" (2203) 84" (2134) 83 1/2" (2121) 79 1/8" (2010)	 20*	 20*	 20*	 20*	 20*
MPCB3684-3	MPCB5484-3	MPCB7284-3	MPCB9084-3	MPCB10884-3	
92 3/4" (2356) 90" (2286) 89 1/2" (2273) 85 1/8" (2162)	 20*	 20*	 20*	 20*	 20*
MPCB3690-3	MPCB5490-3	MPCB7290-3	MPCB9090-3	MPCB10890-3	
98 3/4" (2508) 96" (2438) 95 1/2" (2426) 91 1/8" (2315)	 20*	 20*	 20*	 20*	 20*
MPCB3696-3	MPCB5496-3	MPCB7296-3	MPCB9096-3	MPCB10896-3	

ELEVATION SYMBOL LEGEND:

VALUES IN () ARE IN MILLIMETER CONVERSIONS

VALUES IN [] ARE NUMBER OF DAYLIGHT OPENINGS PER UNIT

NUMBER INDICATES DESIGN PRESSURE (DP) RATING WITH STANDARD GLAZING.

NUMBER INDICATES OPTIONAL DESIGN PRESSURE (DP) RATING.

Note: Elevations shown DO NOT have exterior trim. Subtract 1/2" (12.7) from M.O. (Masonry Opening) for Unit Sizes. Masonry Openings above include Sill Nose, see Trim Options page for Sill Nose specifications. For other Trim Options refer to the Unit Sizing, Rough Opening & Masonry Openings page.

SCALE: 1/8" = 1'

QUARTER ROUND

UNIT SIZE
ROUGH OPENING
FRAME SIZE
DAYLIGHT OPENING

20 3/4" (527)
18" (457)
17 1/2" (445)
13 1/8" (333)

20 3/4" (527)
18" (457)
17 1/2" (445)
13 1/8" (333)



MQRB1818

22 3/4" (578)
20" (508)
19 1/2" (495)
15 1/8" (384)

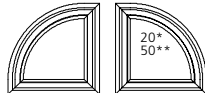

MQRB2020

24 3/4" (629)
22" (559)
21 1/2" (546)
17 1/8" (435)



MQRB2222

26 3/4" (679)
24" (610)
23 1/2" (597)
19 1/8" (486)

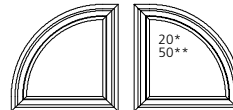

MQRB2424

UNIT SIZE
ROUGH OPENING
FRAME SIZE
DAYLIGHT OPENING

28 3/4" (730)
26" (660)
25 1/2" (648)
21 1/8" (537)

28 3/4" (730)
26" (660)
25 1/2" (648)
21 1/8" (537)

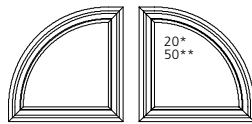

MQRB2626

30 3/4" (781)
28" (711)
27 1/2" (699)
23 1/8" (587)

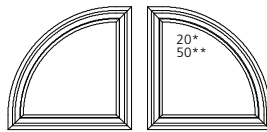

MQRB2828

32 3/4" (832)
30" (762)
29 1/2" (749)
25 1/8" (638)

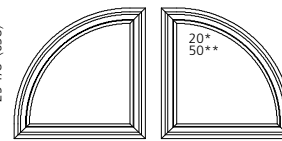

MQRB3030

UNIT SIZE
ROUGH OPENING
FRAME SIZE
DAYLIGHT OPENING

34 3/4" (883)
32" (813)
31 1/2" (800)
27 1/8" (689)

34 3/4" (883)
32" (813)
31 1/2" (800)
27 1/8" (689)

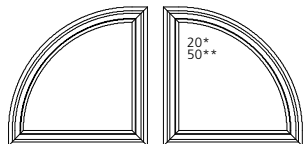

MQRB3232

36 3/4" (933)
34" (864)
33 1/2" (851)
29 1/8" (740)

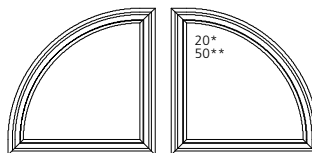

MQRB3434

38 3/4" (984)
36" (914)
35 1/2" (902)
31 1/8" (791)

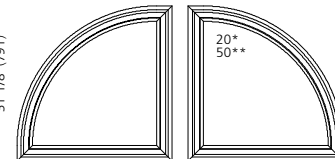

MQRB3636

UNIT SIZE
ROUGH OPENING
FRAME SIZE
DAYLIGHT OPENING

40 3/4" (1035)
38" (965)
37 1/2" (953)
33 1/8" (841)

40 3/4" (1035)
38" (965)
37 1/2" (953)
33 1/8" (841)

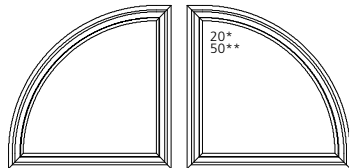

MQRB3838

42 3/4" (1086)
40" (1016)
39 1/2" (1003)
35 1/8" (892)

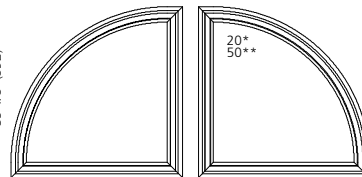

MQRB4040

UNIT SIZE
ROUGH OPENING
FRAME SIZE
DAYLIGHT OPENING

44 3/4" (1137)
42" (1067)
41 1/2" (1054)
37 1/8" (943)

44 3/4" (1137)
42" (1067)
41 1/2" (1054)
37 1/8" (943)

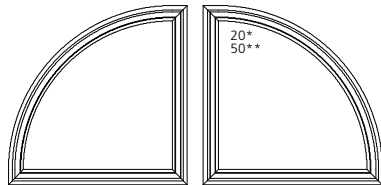

MQRB4242

46 3/4" (1187)
44" (1118)
43 1/2" (1105)
39 1/8" (994)

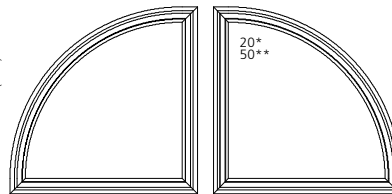

MQRB4444

ELEVATION SYMBOL LEGEND:

VALUES IN () ARE IN MILLIMETER CONVERSIONS

VALUES IN [] ARE NUMBER OF DAYLIGHT OPENINGS PER UNIT

NUMBER INDICATES DESIGN PRESSURE (DP) RATING WITH STANDARD GLAZING.

NUMBER INDICATES OPTIONAL DESIGN PRESSURE (DP) RATING.

Note: Elevations shown DO NOT have exterior trim. Subtract 1/2" (12.7) from M.O. (Masonry Opening) for Unit Sizes. Masonry Openings above include Sill Nose, see Trim Options page for Sill Nose specifications. For other Trim Options refer to the Unit Sizing, Rough Opening & Masonry Openings page.

SCALE: 1/4" = 1'

QUARTER ROUND

UNIT SIZE
ROUGH OPENING
FRAME SIZE
DAYLIGHT OPENING

48 3/4" (1238)
46" (1168)
45 1/2" (1156)
41 1/8" (1045)

48 3/4" (1238)
46" (1168)
45 1/2" (1156)
41 1/8" (1045)

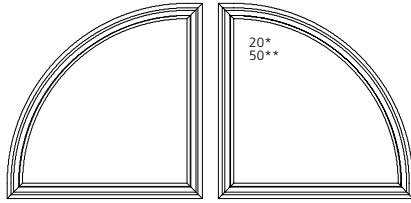

MQRB4646

50 3/4" (1289)
48" (1219)
47 1/2" (1207)
43 1/8" (1095)

50 3/4" (1289)
48" (1219)
47 1/2" (1207)
43 1/8" (1095)

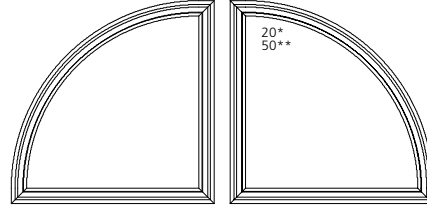

MQRB4848

UNIT SIZE
ROUGH OPENING
FRAME SIZE
DAYLIGHT OPENING

54 3/4" (1391)
52" (1321)
51 1/2" (1308)
47 1/8" (1197)

54 3/4" (1391)
52" (1321)
51 1/2" (1308)
47 1/8" (1197)

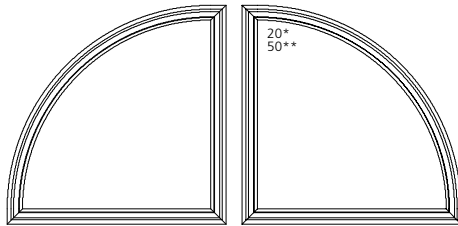

MQRB5252

56 3/4" (1441)
54" (1372)
53 1/2" (1359)
49 1/8" (1248)

56 3/4" (1441)
54" (1372)
53 1/2" (1359)
49 1/8" (1248)

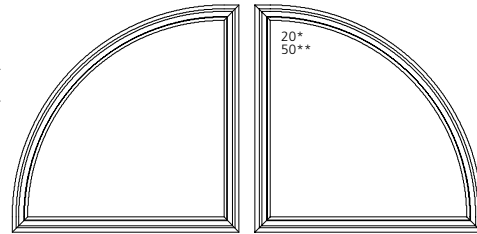

MQRB5454

UNIT SIZE
ROUGH OPENING
FRAME SIZE
DAYLIGHT OPENING

58 3/4" (1492)
56" (1422)
55 1/2" (1410)
51 1/8" (1299)

58 3/4" (1492)
56" (1422)
55 1/2" (1410)
51 1/8" (1299)

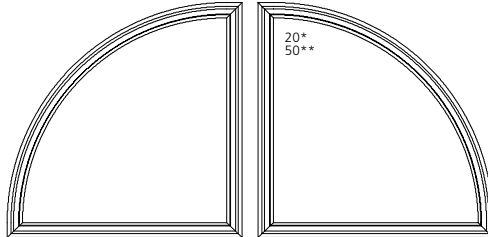

MQRB5656

62 3/4" (1594)
60" (1524)
59 1/2" (1511)
55 1/8" (1400)

62 3/4" (1594)
60" (1524)
59 1/2" (1511)
55 1/8" (1400)

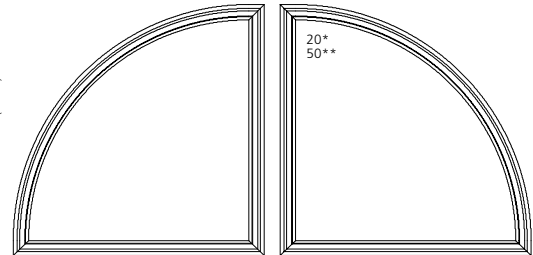

MQRB6060

UNIT SIZE
ROUGH OPENING
FRAME SIZE
DAYLIGHT OPENING

66 3/4" (1695)
64" (1626)
63 1/2" (1613)
59 1/8" (1502)

66 3/4" (1695)
64" (1626)
63 1/2" (1613)
59 1/8" (1502)

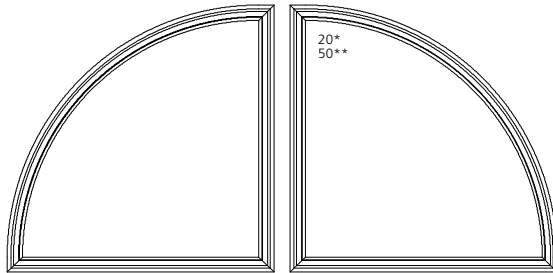

MQRB6464

ELEVATION SYMBOL LEGEND:

VALUES IN () ARE IN MILLIMETER CONVERSIONS
VALUES IN [] ARE NUMBER OF DAYLIGHT OPENINGS PER UNIT

NUMBER INDICATES DESIGN PRESSURE (DP) RATING WITH STANDARD GLAZING.

###* NUMBER INDICATES OPTIONAL DESIGN PRESSURE (DP) RATING.

Note: Elevations shown DO NOT have exterior trim. Subtract 1/2" (12.7) from M.O. (Masonry Opening) for Unit Sizes. Masonry Openings above include Sill Nose, see Trim Options page for Sill Nose specifications. For other Trim Options refer to the Unit Sizing, Rough Opening & Masonry Openings page.

SCALE: 1/4" = 1'

QUARTER ROUND

UNIT SIZE
ROUGH OPENING
FRAME SIZE
DAYLIGHT OPENING

68 3/4" (1746)
66" (1676)
65 1/2" (1664)
61 1/8" (1553)

68 3/4" (1746)
66" (1676)
65 1/2" (1664)
61 1/8" (1553)

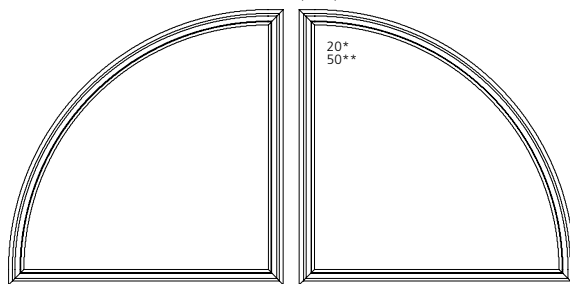

MQRB6666

UNIT SIZE
ROUGH OPENING
FRAME SIZE
DAYLIGHT OPENING

70 3/4" (1797)
68" (1727)
67 1/2" (1715)
63 1/8" (1603)

70 3/4" (1797)
68" (1727)
67 1/2" (1715)
63 1/8" (1603)

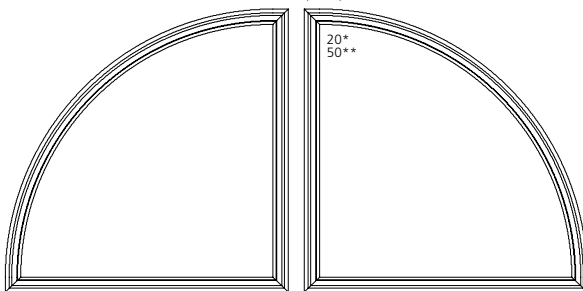

MQRB6868

UNIT SIZE
ROUGH OPENING
FRAME SIZE
DAYLIGHT OPENING

74 3/4" (1899)
72" (1829)
71 1/2" (1861)
67 1/8" (1705)

74 3/4" (1899)
72" (1829)
71 1/2" (1861)
67 1/8" (1705)

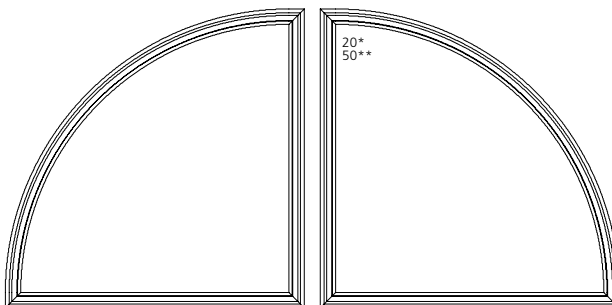

MQRB7272

ELEVATION SYMBOL LEGEND:

VALUES IN () ARE IN MILLIMETER CONVERSIONS
VALUES IN [] ARE NUMBER OF DAYLIGHT OPENINGS PER UNIT

NUMBER INDICATES DESIGN PRESSURE (DP) RATING WITH STANDARD GLAZING.

NUMBER INDICATES OPTIONAL DESIGN PRESSURE (DP) RATING.

Note: Elevations shown DO NOT have exterior trim. Subtract 1/2" (12.7) from M.O. (Masonry Opening) for Unit Sizes. Masonry Openings above include Sill Nose, see Trim Options page for Sill Nose specifications. For other Trim Options refer to the Unit Sizing, Rough Opening & Masonry Openings page.

SCALE: 1/4" = 1'

HALF ROUND

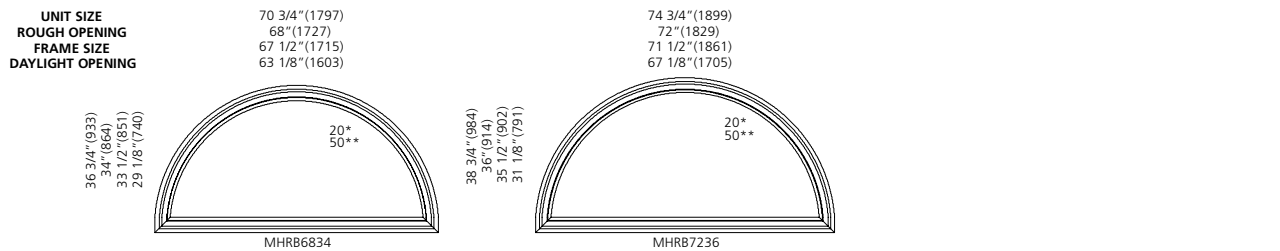
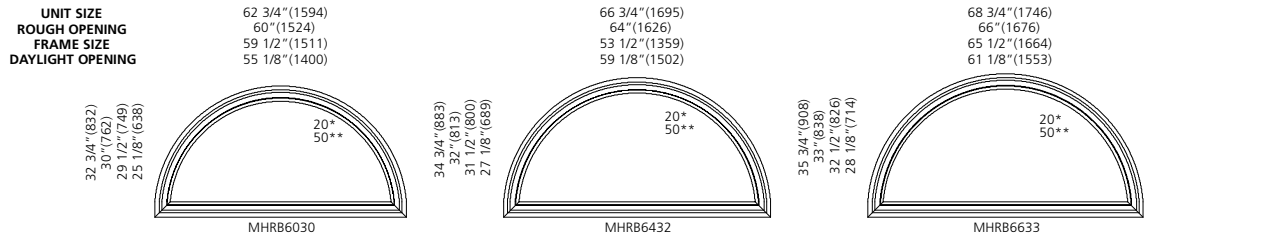
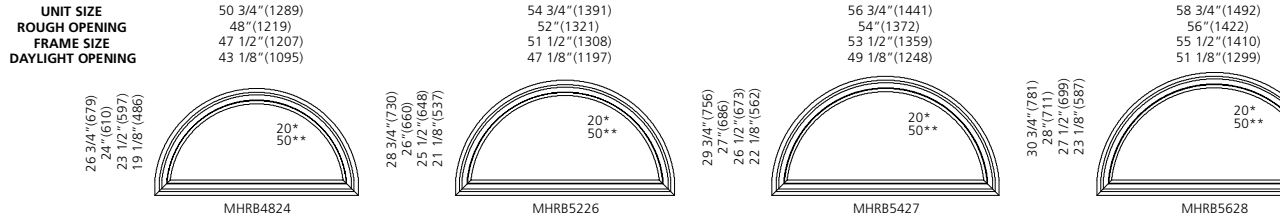
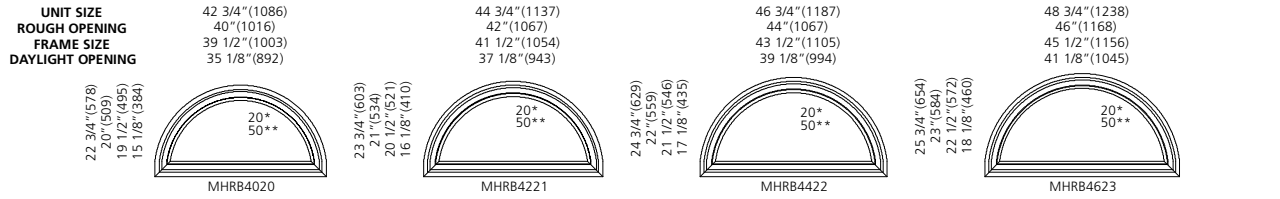
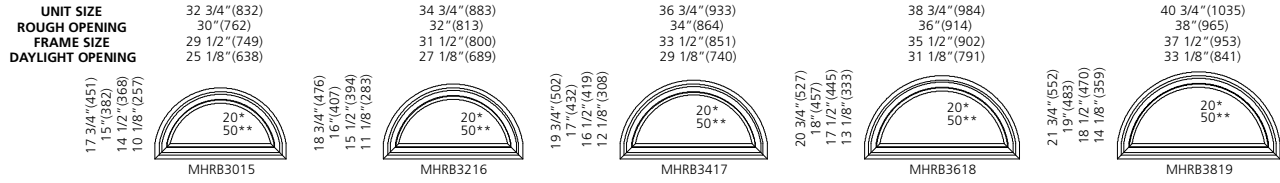

ELEVATION SYMBOL LEGEND:

VALUES IN () ARE IN MILLIMETER CONVERSIONS
VALUES IN [] ARE NUMBER OF DAYLIGHT OPENINGS PER UNIT

NUMBER INDICATES DESIGN PRESSURE (DP) RATING WITH STANDARD GLAZING.

NUMBER INDICATES OPTIONAL DESIGN PRESSURE (DP) RATING.

Note: Elevations shown DO NOT have exterior trim. Subtract 1/2" (12.7) from M.O. (Masonry Opening) for Unit Sizes. Masonry Openings above include Sill Nose, see Trim Options page for Sill Nose specifications. For other Trim Options refer to the Unit Sizing, Rough Opening & Masonry Openings page.

SCALE: 1/4" = 1'

FULL ROUND

UNIT SIZE
ROUGH OPENING
FRAME SIZE
DAYLIGHT OPENING

32 3/4" (832)
30" (762)
29 1/2" (749)
25 1/8" (638)

32 3/4" (832)
30" (762)
29 1/2" (749)
25 1/8" (638)

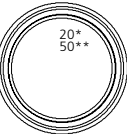

MFRB30

36 3/4" (933)
34" (864)
33 1/2" (851)
29 1/8" (740)

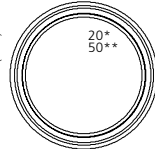

MFRB34

38 3/4" (984)
36" (914)
35 1/2" (902)
31 1/8" (791)

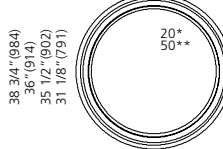

MFRB36

40 3/4" (1035)
38" (965)
37 1/2" (953)
33 1/8" (841)

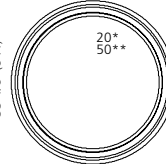

MFRB38

44 3/4" (1137)
42" (1067)
41 1/2" (1054)
37 1/8" (943)

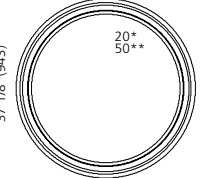

MFRB42

UNIT SIZE
ROUGH OPENING
FRAME SIZE
DAYLIGHT OPENING

50 3/4" (1289)
48" (1219)
47 1/2" (1207)
43 1/8" (1095)

50 3/4" (1289)
48" (1219)
47 1/2" (1207)
43 1/8" (1095)

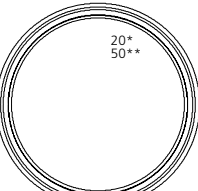

MFRB48

56 3/4" (1441)
54" (1372)
53 1/2" (1359)
49 1/8" (1248)

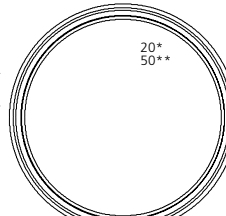

MFRB54

62 3/4" (1594)
60" (1524)
59 1/2" (1511)
55 1/8" (1400)

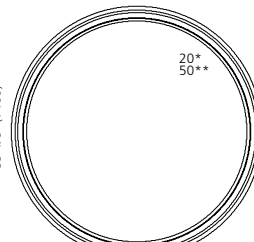

MFRB60

UNIT SIZE
ROUGH OPENING
FRAME SIZE
DAYLIGHT OPENING

68 3/4" (1746)
66" (1676)
65 1/2" (1664)
61 1/8" (1553)

68 3/4" (1746)
66" (1676)
65 1/2" (1664)
61 1/8" (1553)

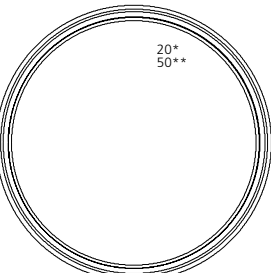

MFRB66

74 3/4" (1899)
72" (1829)
71 1/2" (1861)
67 1/8" (1705)

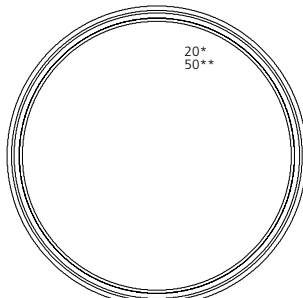

MFRB72

ELEVATION SYMBOL LEGEND:

VALUES IN () ARE IN MILLIMETER CONVERSIONS
VALUES IN [] ARE NUMBER OF DAYLIGHT OPENINGS PER UNIT

NUMBER INDICATES DESIGN PRESSURE (DP) RATING WITH STANDARD GLAZING.

NUMBER INDICATES OPTIONAL DESIGN PRESSURE (DP) RATING.

Note: Elevations shown DO NOT have exterior trim. Subtract 1/2" (12.7) from M.O. (Masonry Opening) for Unit Sizes. Masonry Openings above include Sill Nose, see Trim Options page for Sill Nose specifications. For other Trim Options refer to the Unit Sizing, Rough Opening & Masonry Openings page.

SCALE: 1/4" = 1'

OVAL

UNIT SIZE 26 3/4" (679)
ROUGH OPENING 24" (610)
FRAME SIZE 23 1/2" (597)
DAYLIGHT OPENING 19 1/8" (486)

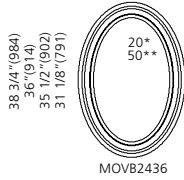

UNIT SIZE 32 3/4" (832)
ROUGH OPENING 30" (762)
FRAME SIZE 29 1/2" (749)
DAYLIGHT OPENING 25 1/8" (638)

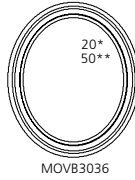

50 3/4" (1289)
48" (1219)
47 1/2" (1207)
43 1/8" (1095)

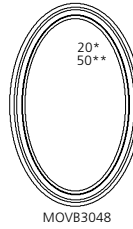

44 3/4" (1137)
42" (1067)
41 1/2" (1054)
37 1/8" (943)

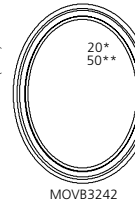

50 3/4" (1289)
48" (1219)
47 1/2" (1207)
43 1/8" (1095)

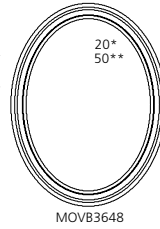

UNIT SIZE 38 3/4" (984)
ROUGH OPENING 36" (914)
FRAME SIZE 35 1/2" (902)
DAYLIGHT OPENING 31 1/8" (791)

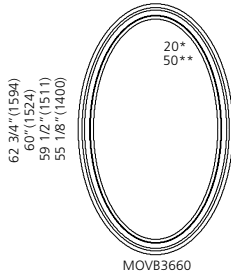

ELEVATION SYMBOL LEGEND:

VALUES IN () ARE IN MILLIMETER CONVERSIONS
VALUES IN [] ARE NUMBER OF DAYLIGHT OPENINGS PER UNIT

NUMBER INDICATES DESIGN PRESSURE (DP) RATING WITH STANDARD GLAZING.

NUMBER INDICATES OPTIONAL DESIGN PRESSURE (DP) RATING.

Note: Elevations shown DO NOT have exterior trim. Subtract 1/2" (12.7) from M.O. (Masonry Opening) for Unit Sizes. Masonry Openings above include Sill Nose, see Trim Options page for Sill Nose specifications. For other Trim Options refer to the Unit Sizing, Rough Opening & Masonry Openings page.

SCALE: 1/4" = 1'

QUARTER CIRCLE SEGMENT

UNIT SIZE
ROUGH OPENING
FRAME SIZE
DAYLIGHT OPENING

32 3/4" (832)
30" (762)
29 1/2" (749)
25 1/8" (638)

26 3/4" (679)
24" (610)
23 1/2" (597)
19 1/8" (486)

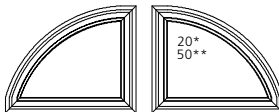

MQEB3024

32 3/4" (832)
30" (762)
29 1/2" (749)
25 1/8" (638)

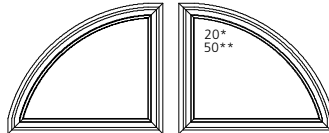

MQEB3630

38 3/4" (984)
36" (914)
35 1/2" (902)
31 1/8" (791)

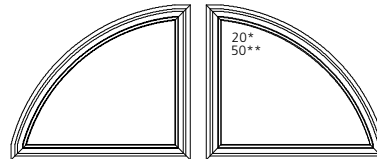

MQEB4236

UNIT SIZE
ROUGH OPENING
FRAME SIZE
DAYLIGHT OPENING

50 3/4" (1289)
48" (1219)
47 1/2" (1207)
43 1/8" (1095)

44 3/4" (1137)
42" (1067)
41 1/2" (1054)
37 1/8" (943)

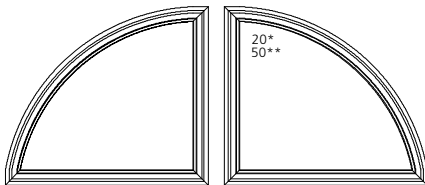

MQEB4842

50 3/4" (1289)
48" (1219)
47 1/2" (1207)
43 1/8" (1095)

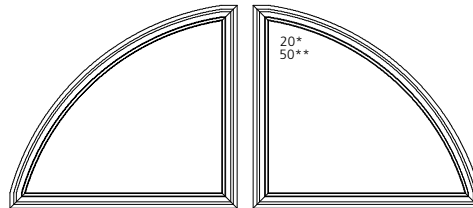

MQEB5448

UNIT SIZE
ROUGH OPENING
FRAME SIZE
DAYLIGHT OPENING

62 3/4" (1594)
60" (1524)
59 1/2" (1511)
55 1/8" (1400)

56 3/4" (1441)
54" (1372)
53 1/2" (1359)
49 1/8" (1248)

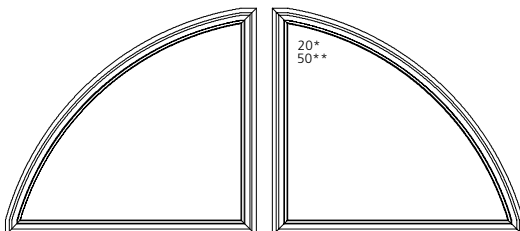

MQEB6054

62 3/4" (1594)
60" (1524)
59 1/2" (1511)
55 1/8" (1400)

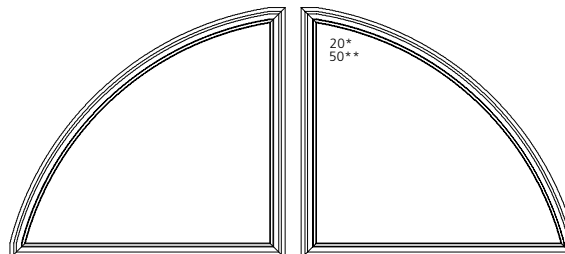

MQEB6660

UNIT SIZE
ROUGH OPENING
FRAME SIZE
DAYLIGHT OPENING

74 3/4" (1899)
72" (1829)
71 1/2" (1816)
67 1/8" (1705)

68 3/4" (1746)
66" (1676)
65 1/2" (1664)
61 1/8" (1553)

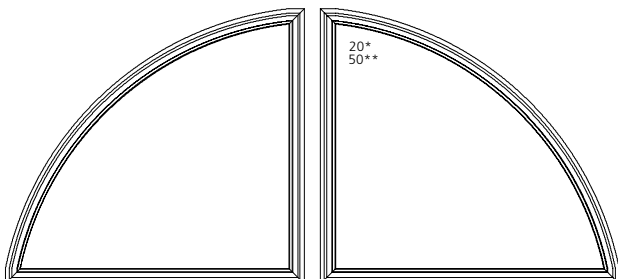

MQEB7266

ELEVATION SYMBOL LEGEND:

VALUES IN () ARE IN MILLIMETER CONVERSIONS

VALUES IN [] ARE NUMBER OF DAYLIGHT OPENINGS PER UNIT

NUMBER INDICATES DESIGN PRESSURE (DP) RATING WITH STANDARD GLAZING.

NUMBER INDICATES OPTIONAL DESIGN PRESSURE (DP) RATING.

Note: Elevations shown DO NOT have exterior trim. Subtract 1/2" (12.7) from M.O. (Masonry Opening) for Unit Sizes. Masonry Openings above include Sill Nose, see Trim Options page for Sill Nose specifications. For other Trim Options refer to the Unit Sizing, Rough Opening & Masonry Openings page.

SCALE: 1/4" = 1'

CIRCLE SEGMENT

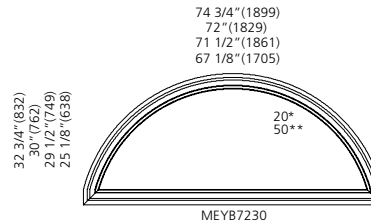
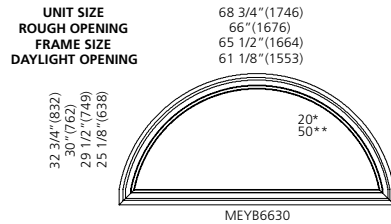
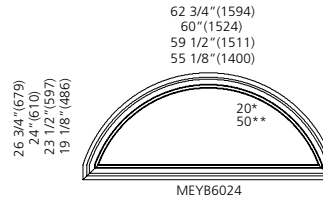
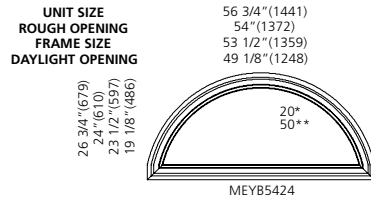
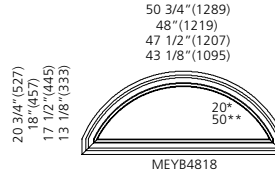
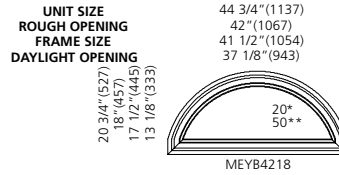
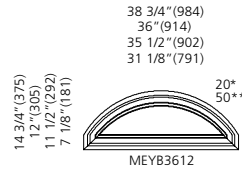
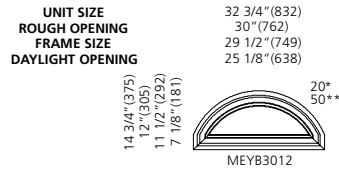

ELEVATION SYMBOL LEGEND:

VALUES IN () ARE IN MILLIMETER CONVERSIONS
 VALUES IN [] ARE NUMBER OF DAYLIGHT OPENINGS PER UNIT

NUMBER INDICATES DESIGN PRESSURE (DP) RATING WITH STANDARD GLAZING.

NUMBER INDICATES OPTIONAL DESIGN PRESSURE (DP) RATING.

Note: Elevations shown DO NOT have exterior trim. Subtract 1/2" (12.7) from M.O. (Masonry Opening) for Unit Sizes. Masonry Openings above include Sill Nose, see Trim Options page for Sill Nose specifications. For other Trim Options refer to the Unit Sizing, Rough Opening & Masonry Openings page.

SCALE: 1/4" = 1'

EXTENDED QUARTER ROUND

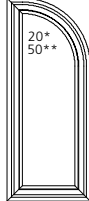
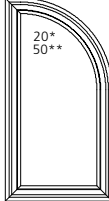
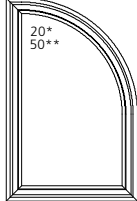
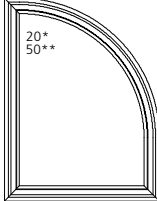
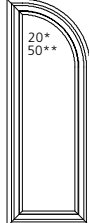
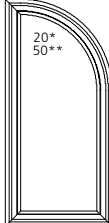
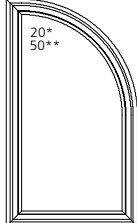
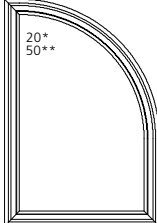
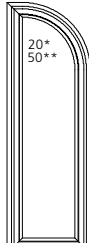
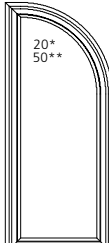
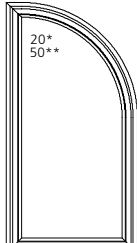
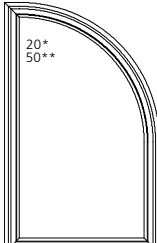
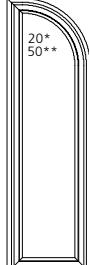
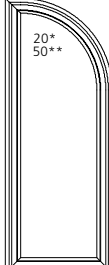
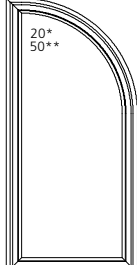
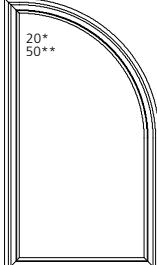
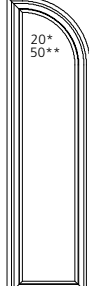
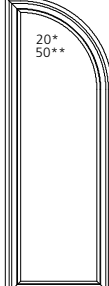
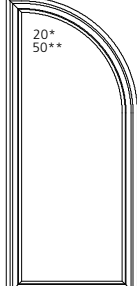
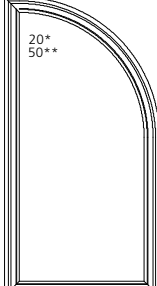
UNIT SIZE	20 3/4" (527)	26 3/4" (679)	32 3/4" (832)	38 3/4" (984)
ROUGH OPENING	18" (457)	24" (610)	30" (762)	36" (914)
FRAME SIZE	17 1/2" (445)	23 1/2" (597)	29 1/2" (749)	35 1/2" (902)
DAYLIGHT OPENING	13 1/8" (333)	19 1/8" (486)	25 1/8" (638)	31 1/8" (791)
50 3/4" (1289) 48" (1219) 47 1/2" (1207) 45 1/8" (1099)	 MQTB1848	 MQTB2448	 MQTB3048	 MQTB3648
56 3/4" (1441) 54" (1372) 53 1/2" (1359) 49 1/8" (1248)	 MQTB1854	 MQTB2454	 MQTB3054	 MQTB3654
62 3/4" (1594) 60" (1524) 59 1/2" (1511) 55 1/8" (1400)	 MQTB1860	 MQTB2460	 MQTB3060	 MQTB3660
68 3/4" (1746) 66" (1676) 65 1/2" (1664) 61 1/8" (1553)	 MQTB1866	 MQTB2466	 MQTB3066	 MQTB3666
74 3/4" (1899) 72" (1829) 71 1/2" (1861) 67 1/8" (1705)	 MQTB1872	 MQTB2472	 MQTB3072	 MQTB3672

ELEVATION SYMBOL LEGEND:

VALUES IN () ARE IN MILLIMETER CONVERSIONS

VALUES IN [] ARE NUMBER OF DAYLIGHT OPENINGS PER UNIT

NUMBER INDICATES DESIGN PRESSURE (DP) RATING WITH STANDARD GLAZING.

NUMBER INDICATES OPTIONAL DESIGN PRESSURE (DP) RATING.

Note: Elevations shown DO NOT have exterior trim. Subtract 1/2" (12.7) from M.O. (Masonry Opening) for Unit Sizes. Masonry Openings above include Sill Nose, see Trim Options page for Sill Nose specifications. For other Trim Options refer to the Unit Sizing, Rough Opening & Masonry Openings page.

SCALE: 1/4" = 1'

EXTENDED HALF ROUND

UNIT SIZE	26 3/4" (679)	32 3/4" (832)	38 3/4" (984)	44 3/4" (1137)	50 3/4" (1289)
ROUGH OPENING	24" (610)	30" (762)	36" (914)	42" (1067)	48" (1219)
FRAME SIZE	23 1/2" (597)	29 1/2" (749)	35 1/2" (902)	41 1/2" (1054)	47 1/2" (1207)
DAYLIGHT OPENING	19 1/8" (486)	25 1/8" (638)	31 1/8" (791)	37 1/8" (943)	43 1/8" (1095)
38 3/4" (984) 36" (914) 35 1/2" (902) 31 1/8" (791)					
MSLB2436	MSLB3036	MSLB3636	MSLB4236	MSLB4836	
50 3/4" (1289) 48" (1219) 47 1/2" (1207) 43 1/8" (1095)					
MSLB2448	MSLB3048	MSLB3648	MSLB4248	MSLB4848	
55 3/4" (1441) 54" (1372) 53 1/2" (1369) 49 1/8" (1248)					
MSLB2454	MSLB3054	MSLB3654	MSLB4254	MSLB4854	
62 3/4" (1594) 60" (1524) 59 1/2" (1511) 55 1/8" (1400)					
MSLB2460	MSLB3060	MSLB3660	MSLB4260	MSLB4860	
68 3/4" (1746) 66" (1676) 65 1/2" (1664) 61 1/8" (1553)					
MSLB2466	MSLB3066	MSLB3666	MSLB4266	MSLB4866	
74 3/4" (1899) 72" (1829) 71 1/2" (1816) 67 1/8" (1705)					
MSLB2472	MSLB3072	MSLB3672	MSLB4272	MSLB4872	

ELEVATION SYMBOL LEGEND:

VALUES IN () ARE IN MILLIMETER CONVERSIONS
VALUES IN [] ARE NUMBER OF DAYLIGHT OPENINGS PER UNIT

NUMBER INDICATES DESIGN PRESSURE (DP) RATING WITH STANDARD GLAZING.

NUMBER INDICATES OPTIONAL DESIGN PRESSURE (DP) RATING.

Note: Elevations shown DO NOT have exterior trim. Subtract 1/2" (12.7) from M.O. (Masonry Opening) for Unit Sizes. Masonry Openings above include Sill Nose, see Trim Options page for Sill Nose specifications. For other Trim Options refer to the Unit Sizing, Rough Opening & Masonry Openings page.

SCALE: 1/4" = 1'

EXTENDED QUARTER SEGMENT

UNIT SIZE ROUGH OPENING FRAME SIZE DAYLIGHT OPENING	26 3/4" (679) 24" (610) 23 1/2" (597) 19 1/8" (486)	32 3/4" (832) 30" (762) 29 1/2" (749) 25 1/8" (638)	38 3/4" (984) 36" (914) 35 1/2" (902) 31 1/8" (791)	44 3/4" (1137) 42" (1067) 41 1/2" (1054) 37 1/8" (943)	50 3/4" (1289) 48" (1219) 47 1/2" (1207) 43 1/8" (1095)	56 3/4" (1441) 54" (1372) 53 1/2" (1359) 49 1/8" (1248)
26 3/4" (679) 24" (610) 23 1/2" (597) 19 1/8" (486)						
	MQPB2424	MQPB3024	MQPB3624	MQPB4224	MQPB4824	MQPB5424
32 3/4" (832) 30" (762) 29 1/2" (749) 25 1/8" (638)						
	MQPB2430	MQPB3030	MQPB3630	MQPB4230	MQPB4830	MQPB5430
38 3/4" (984) 36" (914) 35 1/2" (902) 31 1/8" (791)						
	MQPB2436	MQPB3036	MQPB3636	MQPB4236	MQPB4836	MQPB5436
44 3/4" (1137) 42" (1067) 41 1/2" (1054) 37 1/8" (943)						
	MQPB2442	MQPB3042	MQPB3642	MQPB4242	MQPB4842	MQPB5442
50 3/4" (1289) 48" (1219) 47 1/2" (1207) 43 1/8" (1095)						
	MQPB2448	MQPB3048	MQPB3648	MQPB4248	MQPB4848	MQPB5448
56 3/4" (1441) 54" (1372) 53 1/2" (1359) 49 1/8" (1248)						
	MQPB2454	MQPB3054	MQPB3654	MQPB4254	MQPB4854	MQPB5454
62 3/4" (1594) 60" (1524) 59 1/2" (1511) 55 1/8" (1400)						
	MQPB2460	MQPB3060	MQPB3660	MQPB4260	MQPB4860	MQPB5460

ELEVATION SYMBOL LEGEND:

VALUES IN () ARE IN MILLIMETER CONVERSIONS

VALUES IN [] ARE NUMBER OF DAYLIGHT OPENINGS PER UNIT

NUMBER INDICATES DESIGN PRESSURE (DP) RATING WITH STANDARD GLAZING.

NUMBER INDICATES OPTIONAL DESIGN PRESSURE (DP) RATING.

Note: Elevations shown DO NOT have exterior trim. Subtract 1/2" (12.7) from M.O. (Masonry Opening) for Unit Sizes. Masonry Openings above include Sill Nose, see Trim Options page for Sill Nose specifications. For other Trim Options refer to the Unit Sizing, Rough Opening & Masonry Openings page.

SCALE: 1/4" = 1'

EXTENDED QUARTER SEGMENT

	26 3/4" (679)	32 3/4" (832)	38 3/4" (984)	44 3/4" (1137)	50 3/4" (1289)	56 3/4" (1441)
UNIT SIZE	24" (610)	30" (762)	36" (914)	42" (1067)	48" (1219)	54" (1372)
ROUGH OPENING	23 1/2" (597)	29 1/2" (749)	35 1/2" (902)	41 1/2" (1054)	47 1/2" (1207)	53 1/2" (1359)
FRAME SIZE	19 1/8" (486)	25 1/8" (638)	31 1/8" (791)	37 1/8" (943)	43 1/8" (1095)	49 1/8" (1248)
DAYLIGHT OPENING						
	68 3/4" (1746)	66" (1676)	65 1/2" (1664)	61 1/8" (1553)		
	20°	20°	20°	20°	20°	20°
	50**	50**	50**	50**	50**	50**
	MQPB2466	MQPB3066	MQPB3666	MQPB4266	MQPB4866	MQPB5466
	74 3/4" (1899)	72" (1829)	71 1/2" (1861)	67 1/8" (1705)		
	20°	20°	20°	20°	20°	20°
	50**	50**	50**	50**	50**	50**
	MQPB2472	MQPB3072	MQPB3672	MQPB4272	MQPB4872	MQPB5472

ELEVATION SYMBOL LEGEND:

VALUES IN () ARE IN MILLIMETER CONVERSIONS
 VALUES IN [] ARE NUMBER OF DAYLIGHT OPENINGS PER UNIT

NUMBER INDICATES DESIGN PRESSURE (DP) RATING WITH STANDARD GLAZING.

NUMBER INDICATES OPTIONAL DESIGN PRESSURE (DP) RATING.

Note: Elevations shown DO NOT have exterior trim. Subtract 1/2" (12.7) from M.O. (Masonry Opening) for Unit Sizes. Masonry Openings above include Sill Nose, see Trim Options page for Sill Nose specifications. For other Trim Options refer to the Unit Sizing, Rough Opening & Masonry Openings page.

SCALE: 1/4" = 1'

EXTENDED QUARTER SEGMENT

UNIT SIZE
ROUGH OPENING
FRAME SIZE
DAYLIGHT OPENING

26 3/4" (679)
24" (610)
23 1/2" (597)
19 1/8" (486)

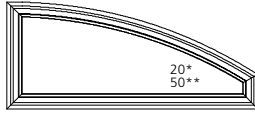

MQPB6024

62 3/4" (1594)
60" (1524)
59 1/2" (1511)
55 1/8" (1400)

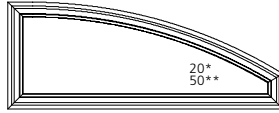

MQPB6624

74 3/4" (1899)
72" (1829)
71 1/2" (1861)
67 1/8" (1705)

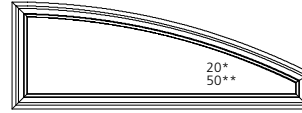

MQPB7224

32 3/4" (832)
30" (762)
29 1/2" (749)
25 1/8" (638)

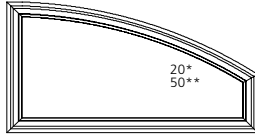

MQPB6030

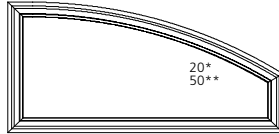

MQPB6630

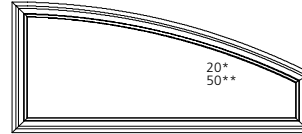

MQPB7230

38 3/4" (984)
36" (914)
35 1/2" (902)
31 1/8" (791)

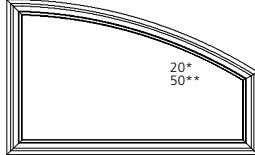

MQPB6036

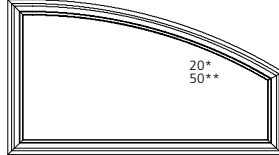

MQPB6636

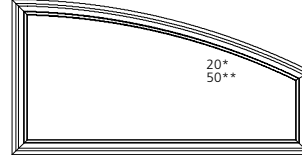

MQPB7236

44 3/4" (1137)
42" (1067)
41 1/2" (1054)
37 1/8" (943)

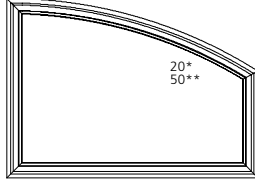

MQPB6042

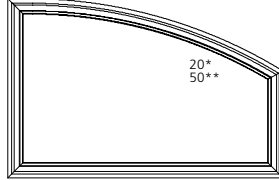

MQPB6642

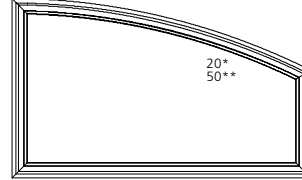

MQPB7242

50 3/4" (1289)
48" (1219)
47 1/2" (1207)
43 1/8" (1095)

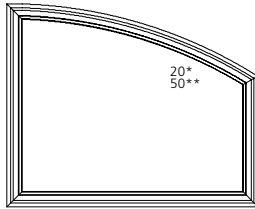

MQPB6048

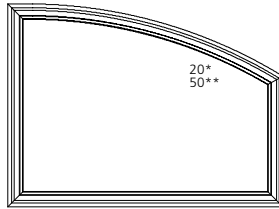

MQPB6648

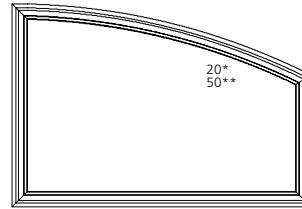

MQPB7248

56 3/4" (1441)
54" (1372)
53 1/2" (1359)
49 1/8" (1248)

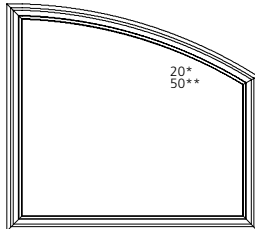

MQPB6054

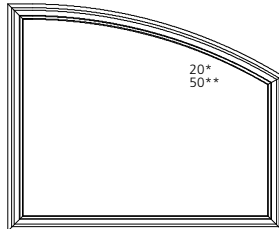

MQPB6654

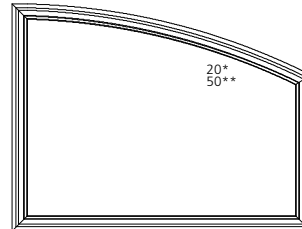

MQPB7254

62 3/4" (1594)
60" (1524)
59 1/2" (1511)
55 1/8" (1400)

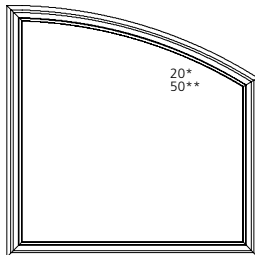

MQPB6060

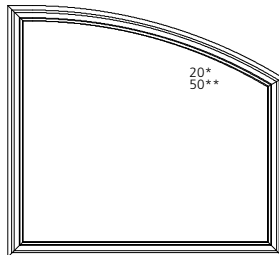

MQPB6660

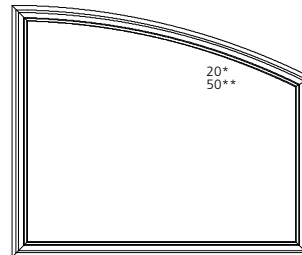

MQPB7260

ELEVATION SYMBOL LEGEND:

VALUES IN () ARE IN MILLIMETER CONVERSIONS
VALUES IN [] ARE NUMBER OF DAYLIGHT OPENINGS PER UNIT

NUMBER INDICATES DESIGN PRESSURE (DP) RATING WITH STANDARD GLAZING.

NUMBER INDICATES OPTIONAL DESIGN PRESSURE (DP) RATING.

Note: Elevations shown DO NOT have exterior trim. Subtract 1/2" (12.7) from M.O. (Masonry Opening) for Unit Sizes. Masonry Openings above include Sill Nose, see Trim Options page for Sill Nose specifications. For other Trim Options refer to the Unit Sizing, Rough Opening & Masonry Openings page.

SCALE: 1/4" = 1'

EXTENDED QUARTER SEGMENT

UNIT SIZE
ROUGH OPENING
FRAME SIZE
DAYLIGHT OPENING

62 3/4" (1594)
60" (1524)
59 1/2" (1511)
55 1/8" (1400)

68 3/4" (1746)
66" (1676)
65 1/2" (1664)
61 1/8" (1553)

74 3/4" (1899)
72" (1829)
71 1/2" (1861)
67 1/8" (1705)

68 3/4" (1746)
66" (1676)
65 1/2" (1664)
61 1/8" (1553)

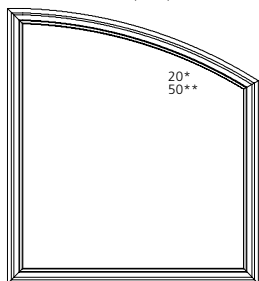

MQPB6066

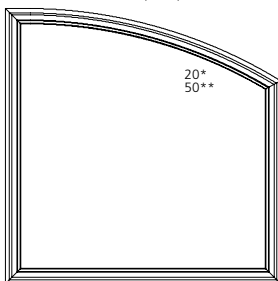

MQPB6666

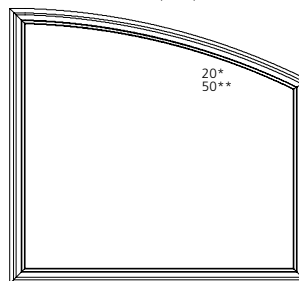

MQPB7266

74 3/4" (1899)
72" (1829)
71 1/2" (1861)
67 1/8" (1705)

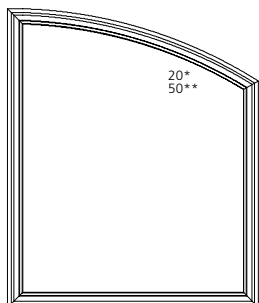

MQPB6072

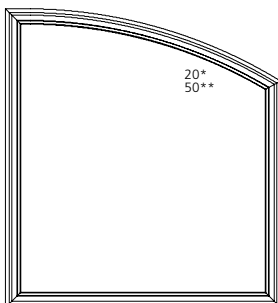

MQPB6672

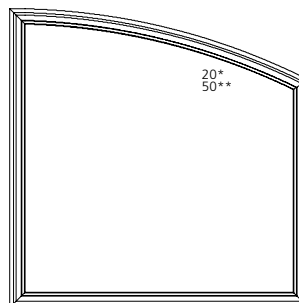

MQPB7272

ELEVATION SYMBOL LEGEND:

VALUES IN () ARE IN MILLIMETER CONVERSIONS
VALUES IN [] ARE NUMBER OF DAYLIGHT OPENINGS PER UNIT

NUMBER INDICATES DESIGN PRESSURE (DP) RATING WITH STANDARD GLAZING.

NUMBER INDICATES OPTIONAL DESIGN PRESSURE (DP) RATING.

Note: Elevations shown DO NOT have exterior trim. Subtract 1/2" (12.7) from M.O. (Masonry Opening) for Unit Sizes. Masonry Openings above include Sill Nose, see Trim Options page for Sill Nose specifications. For other Trim Options refer to the Unit Sizing, Rough Opening & Masonry Openings page.

SCALE: 1/4" = 1'

EXTENDED CIRCLE SEGMENT

UNIT SIZE
ROUGH OPENING
FRAME SIZE
DAYLIGHT OPENING

26 3/4" (679)
24" (610)
23 1/2" (597)
19 1/8" (486)

32 3/4" (832)
30" (762)
29 1/2" (749)
25 1/8" (638)

38 3/4" (984)
36" (914)
35 1/2" (902)
31 1/8" (791)

44 3/4" (1137)
42" (1067)
41 1/2" (1054)
37 1/8" (943)

50 3/4" (1289)
48" (1219)
47 1/2" (1207)
43 1/8" (1095)

56 3/4" (1441)
54" (1372)
53 1/2" (1359)
49 1/8" (1248)

26 3/4" (679)
24" (610)
23 1/2" (597)
19 1/8" (486)

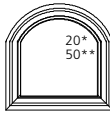

20*
50**

MLPB2424

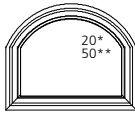

20*
50**

MLPB3024

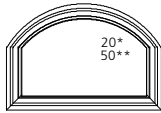

20*
50**

MLPB3624

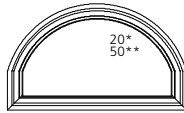

20*
50**

MLPB4224

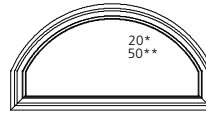

20*
50**

MLPB4824

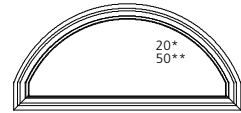

20*
50**

MLPB5424

32 3/4" (832)
30" (762)
29 1/2" (749)
25 1/8" (638)

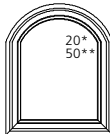

20*
50**

MLPB2430

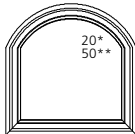

20*
50**

MLPB3030

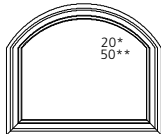

20*
50**

MLPB3630

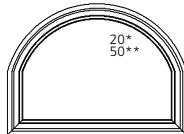

20*
50**

MLPB4230

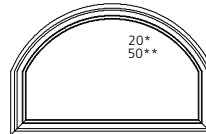

20*
50**

MLPB4830

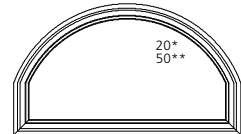

20*
50**

MLPB5430

38 3/4" (984)
36" (914)
35 1/2" (902)
31 1/8" (791)



20*
50**

MLPB2436

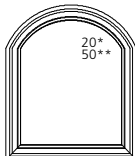

20*
50**

MLPB3036

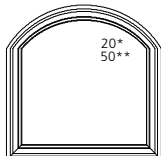

20*
50**

MLPB3636

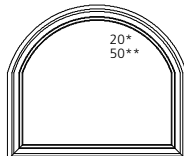

20*
50**

MLPB4236

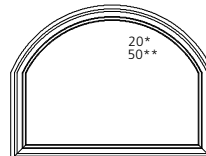

20*
50**

MLPB4836

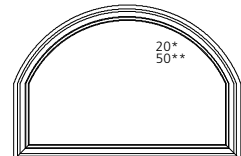

20*
50**

MLPB5436

44 3/4" (1137)
42" (1067)
41 1/2" (1054)
37 1/8" (943)

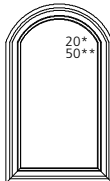

20*
50**

MLPB2442

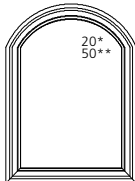

20*
50**

MLPB3042

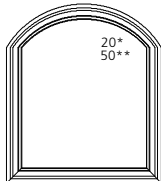

20*
50**

MLPB3642

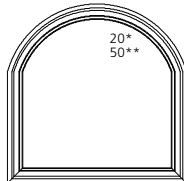

20*
50**

MLPB4242

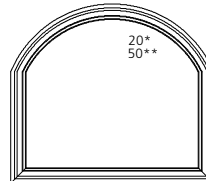

20*
50**

MLPB4842

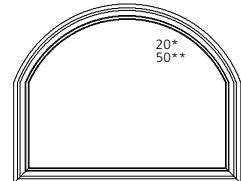

20*
50**

MLPB5442

50 3/4" (1289)
48" (1219)
47 1/2" (1207)
43 1/8" (1095)

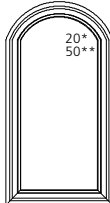

20*
50**

MLPB2448

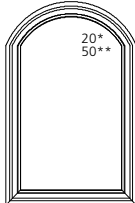

20*
50**

MLPB3048

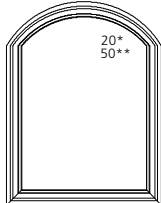

20*
50**

MLPB3648

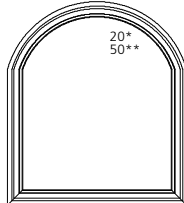

20*
50**

MLPB4248

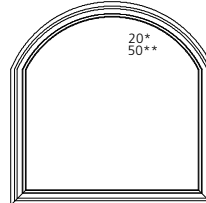

20*
50**

MLPB4848

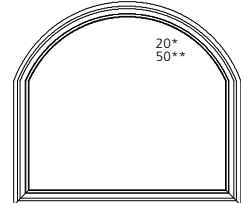

20*
50**

MLPB5448

56 3/4" (1441)
54" (1372)
53 1/2" (1359)
49 1/8" (1248)

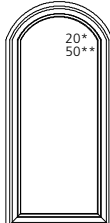

20*
50**

MLPB2454

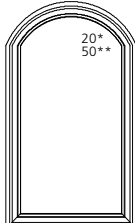

20*
50**

MLPB3054

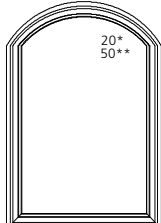

20*
50**

MLPB3654

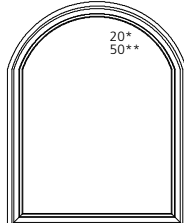

20*
50**

MLPB4254

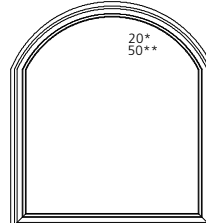

20*
50**

MLPB4854

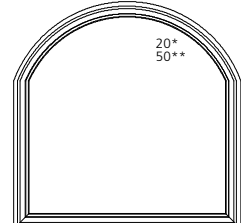

20*
50**

MLPB5454

62 3/4" (1594)
60" (1524)
59 1/2" (1511)
55 1/8" (1400)

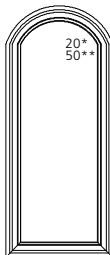

20*
50**

MLPB2460

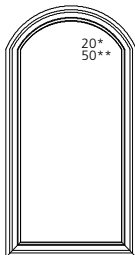

20*
50**

MLPB3060

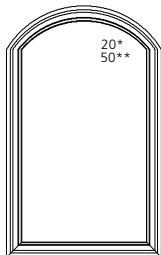

20*
50**

MLPB3660

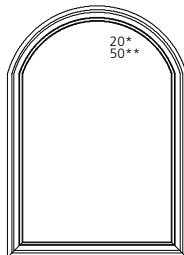

20*
50**

MLPB4260

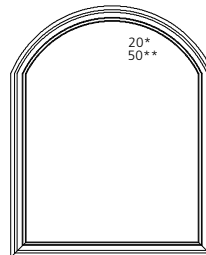

20*
50**

MLPB4860

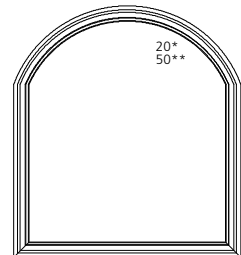

20*
50**

MLPB5460

ELEVATION SYMBOL LEGEND:

VALUES IN () ARE IN MILLIMETER CONVERSIONS

VALUES IN [] ARE NUMBER OF DAYLIGHT OPENINGS PER UNIT

*** NUMBER INDICATES DESIGN PRESSURE (DP) RATING WITH STANDARD GLAZING.

**** NUMBER INDICATES OPTIONAL DESIGN PRESSURE (DP) RATING.

Note: Elevations shown DO NOT have exterior trim. Subtract 1/2" (12.7) from M.O. (Masonry Opening) for Unit Sizes. Masonry Openings above include Sill Nose, see Trim Options page for Sill Nose specifications. For other Trim Options refer to the Unit Sizing, Rough Opening & Masonry Openings page.

SCALE: 1/4" = 1'

EXTENDED CIRCLE SEGMENT

UNIT SIZE	26 3/4"(679)	32 3/4"(832)	38 3/4"(984)	44 3/4"(1137)	50 3/4"(1289)	56 3/4"(1441)
ROUGH OPENING	24"(610)	30"(762)	36"(914)	42"(1067)	48"(1219)	54"(1372)
FRAME SIZE	23 1/2"(597)	29 1/2"(749)	35 1/2"(902)	41 1/2"(1054)	47 1/2"(1207)	53 1/2"(1359)
DAYLIGHT OPENING	19 1/8"(486)	25 1/8"(638)	31 1/8"(791)	37 1/8"(943)	43 1/8"(1095)	49 1/8"(1248)

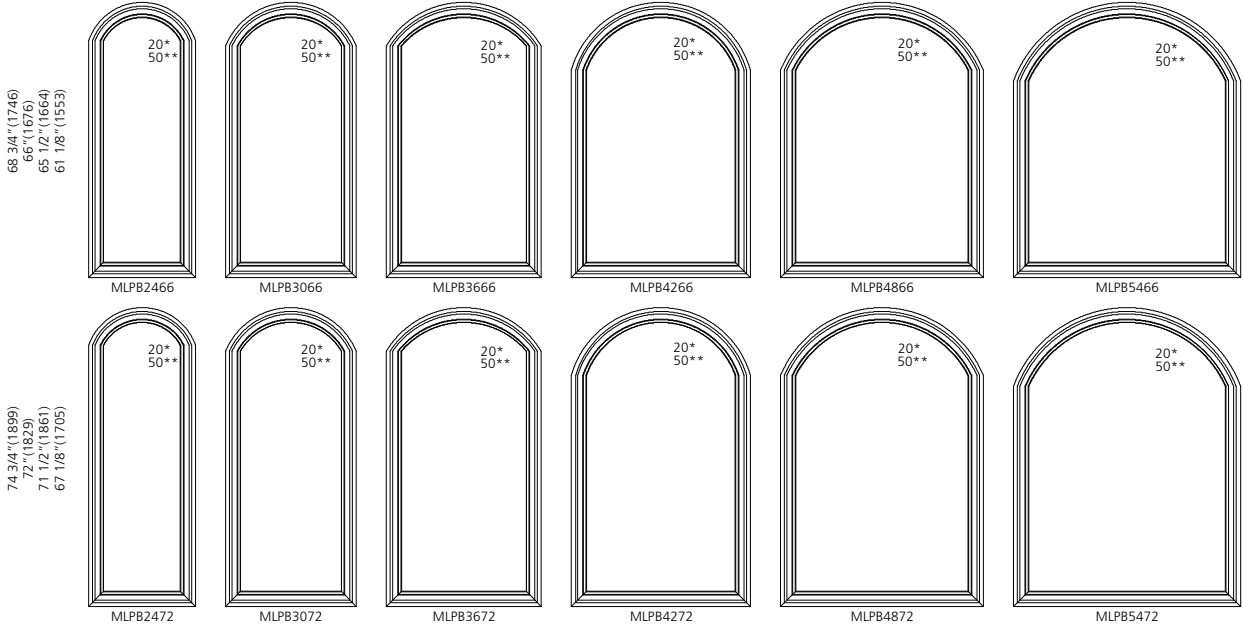

ELEVATION SYMBOL LEGEND:

VALUES IN () ARE IN MILLIMETER CONVERSIONS
VALUES IN [] ARE NUMBER OF DAYLIGHT OPENINGS PER UNIT

NUMBER INDICATES DESIGN PRESSURE (DP) RATING WITH STANDARD GLAZING.

NUMBER INDICATES OPTIONAL DESIGN PRESSURE (DP) RATING.

Note: Elevations shown DO NOT have exterior trim. Subtract 1/2" (12.7) from M.O. (Masonry Opening) for Unit Sizes. Masonry Openings above include Sill Nose, see Trim Options page for Sill Nose specifications. For other Trim Options refer to the Unit Sizing, Rough Opening & Masonry Openings page.

SCALE: 1/4" = 1'

EXTENDED CIRCLE SEGMENT

UNIT SIZE
ROUGH OPENING
FRAME SIZE
DAYLIGHT OPENING

62 3/4" (1594)
60" (1524)
59 1/2" (1511)
55 1/8" (1400)

68 3/4" (1746)
66" (1676)
65 1/2" (1664)
61 1/8" (1553)

74 3/4" (1899)
72" (1829)
71 1/2" (1861)
67 1/8" (1705)

26 3/4" (679)
24" (610)
23 1/2" (597)
19 1/8" (486)

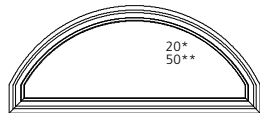

MLPB6024

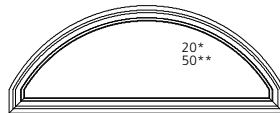

MLPB6624

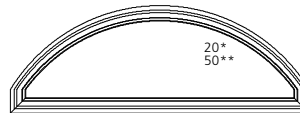

MLPB7224

32 3/4" (832)
30" (762)
29 1/2" (749)
25 1/8" (638)

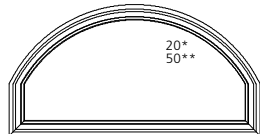

MLPB6030

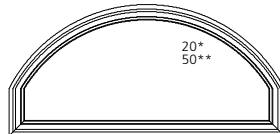

MLPB6630

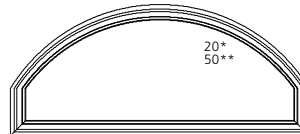

MLPB7230

38 3/4" (984)
36" (914)
35 1/2" (902)
31 1/8" (791)

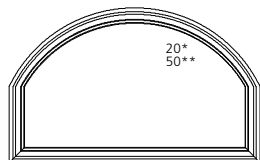

MLPB6036

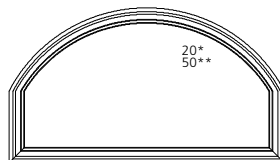

MLPB6636

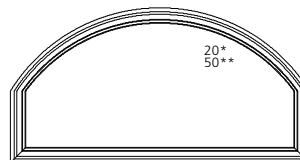

MLPB7236

44 3/4" (1137)
42" (1067)
41 1/2" (1054)
37 1/8" (943)

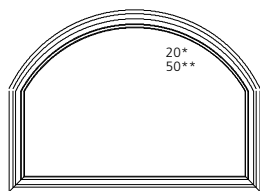

MLPB6042

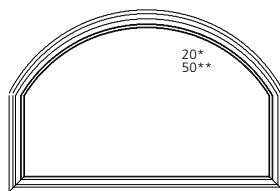

MLPB6642

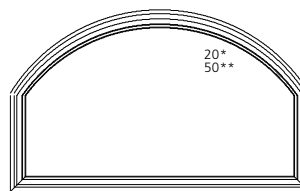

MLPB7242

50 3/4" (1289)
48" (1219)
47 1/2" (1207)
43 1/8" (1095)

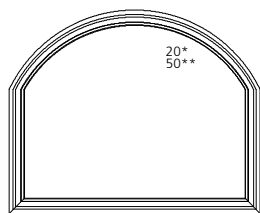

MLPB6048

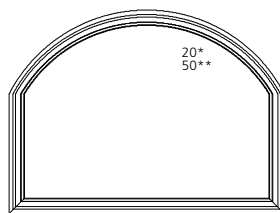

MLPB6648

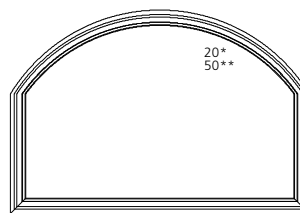

MLPB7248

56 3/4" (1441)
54" (1372)
53 1/2" (1359)
49 1/8" (1248)

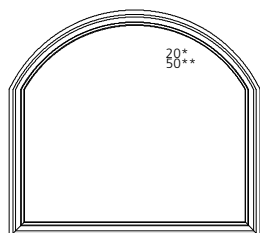

MLPB6054

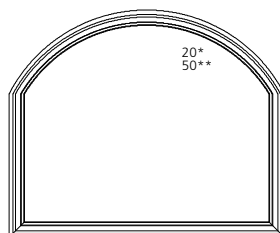

MLPB6654

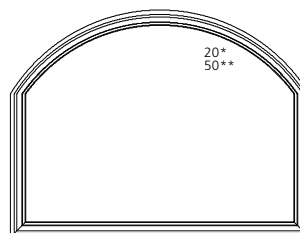

MLPB7254

62 3/4" (1594)
60" (1524)
59 1/2" (1511)
55 1/8" (1400)

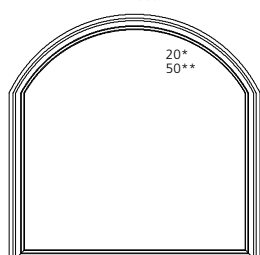

MLPB6060

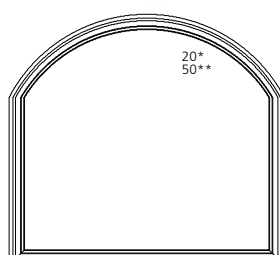

MLPB6660

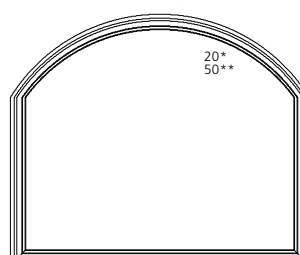

MLPB7260

ELEVATION SYMBOL LEGEND:

VALUES IN () ARE IN MILLIMETER CONVERSIONS

VALUES IN [] ARE NUMBER OF DAYLIGHT OPENINGS PER UNIT

NUMBER INDICATES DESIGN PRESSURE (DP) RATING WITH STANDARD GLAZING.

NUMBER INDICATES OPTIONAL DESIGN PRESSURE (DP) RATING.

Note: Elevations shown DO NOT have exterior trim. Subtract 1/2" (12.7) from M.O. (Masonry Opening) for Unit Sizes. Masonry Openings above include Sill Nose, see Trim Options page for Sill Nose specifications. For other Trim Options refer to the Unit Sizing, Rough Opening & Masonry Openings page.

SCALE: 1/4" = 1'

EXTENDED CIRCLE SEGMENT

UNIT SIZE
ROUGH OPENING
FRAME SIZE
DAYLIGHT OPENING

62 3/4" (1594)
60" (1524)
59 1/2" (1511)
55 1/8" (1400)

68 3/4" (1746)
66" (1676)
65 1/2" (1664)
61 1/8" (1553)

74 3/4" (1899)
72" (1829)
71 1/2" (1861)
67 1/8" (1705)

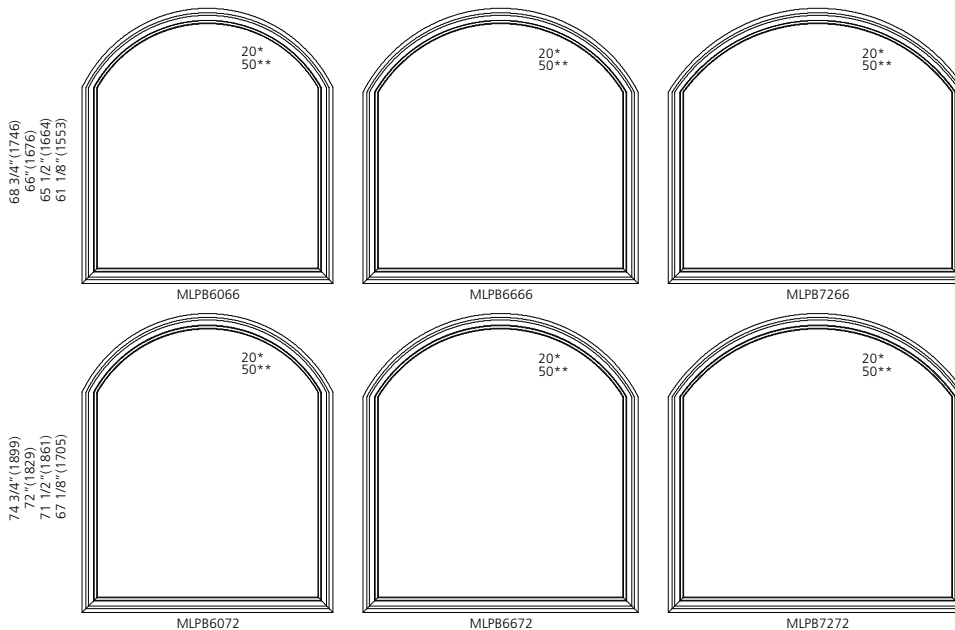

ELEVATION SYMBOL LEGEND:

VALUES IN () ARE IN MILLIMETER CONVERSIONS
VALUES IN [] ARE NUMBER OF DAYLIGHT OPENINGS PER UNIT

NUMBER INDICATES DESIGN PRESSURE (DP) RATING WITH STANDARD GLAZING.

NUMBER INDICATES OPTIONAL DESIGN PRESSURE (DP) RATING.

Note: Elevations shown DO NOT have exterior trim. Subtract 1/2" (12.7) from M.O. (Masonry Opening) for Unit Sizes. Masonry Openings above include Sill Nose, see Trim Options page for Sill Nose specifications. For other Trim Options refer to the Unit Sizing, Rough Opening & Masonry Openings page.

SCALE: 1/4" = 1'

GLAZING OPTIONS

EXTERIOR GLAZED

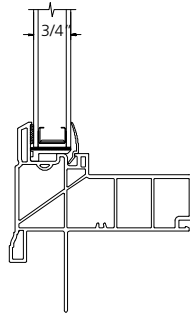

STANDARD 3/4" GLASS

GRILLE PATTERNS

QUARTER ROUND

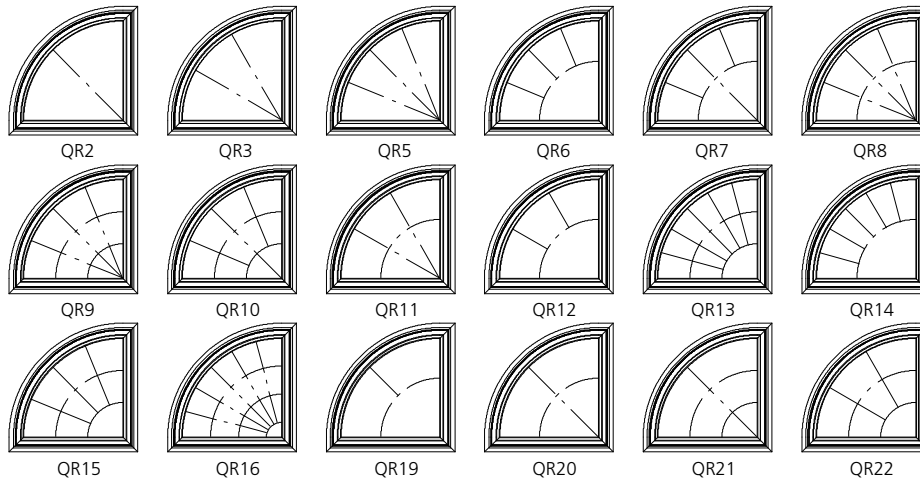

HALF ROUND

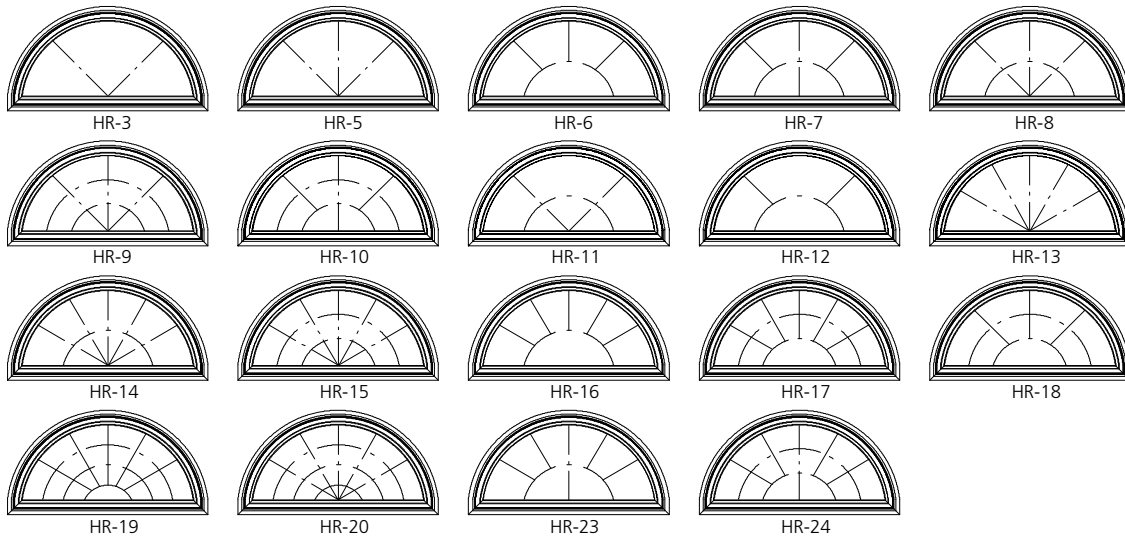

FULL ROUND

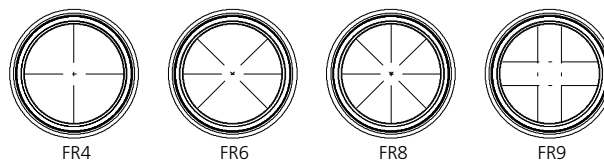

GRILLE PATTERNS

**EXTENDED
QUARTER ROUND**

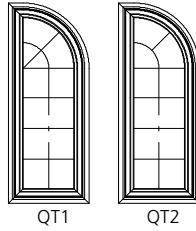

**EXTENDED
HALF ROUND**

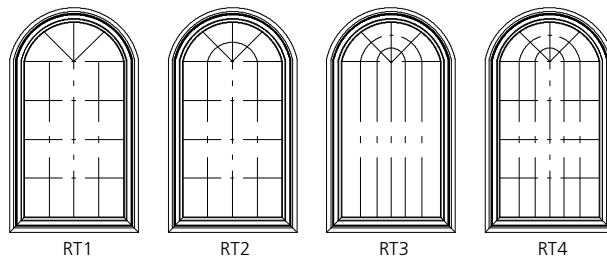

**EXTENDED
CIRCLE SEGMENT**

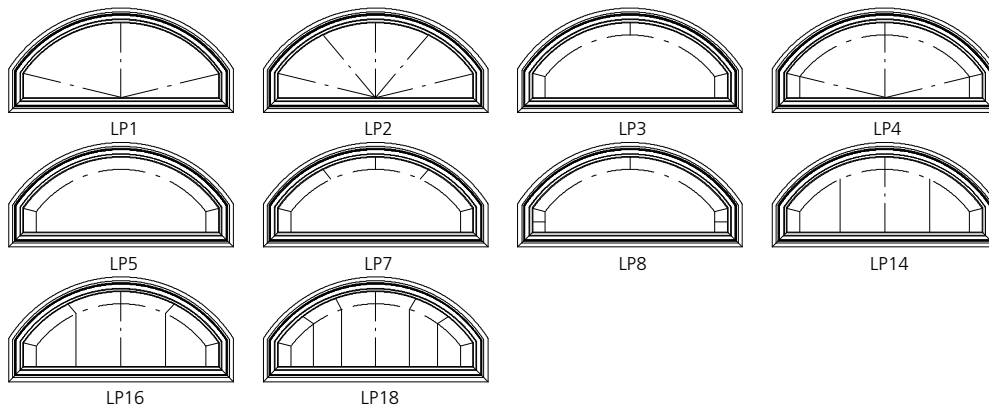

PICTURE UNIT

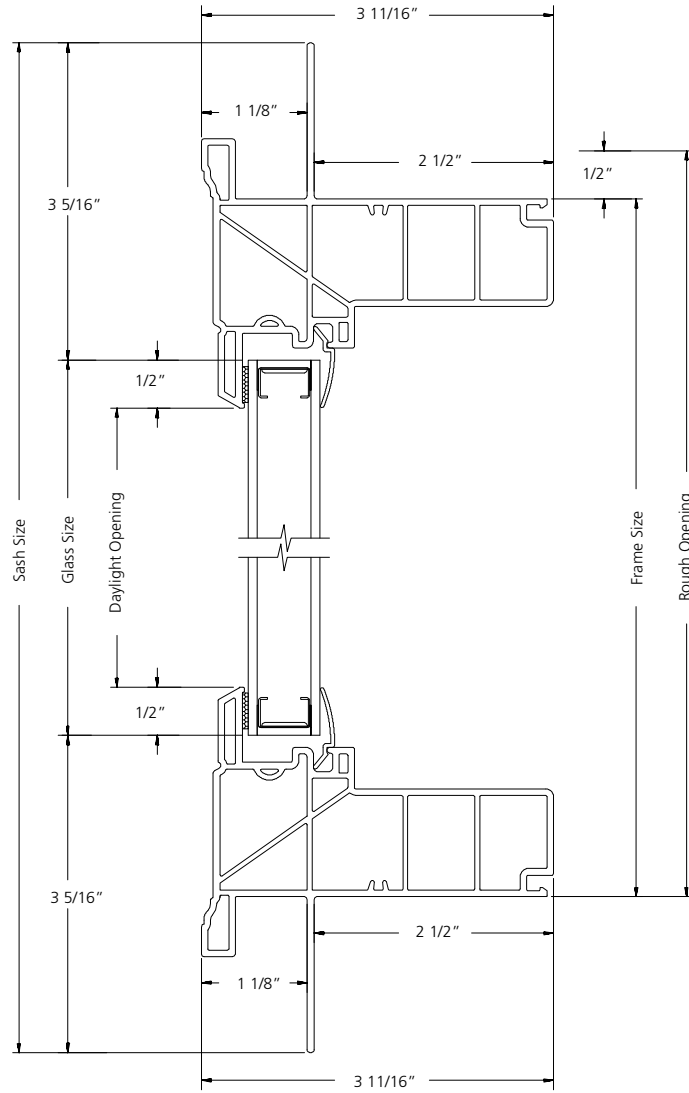

VERTICAL SECTION

SCALE: 6" = 1'

PICTURE UNIT

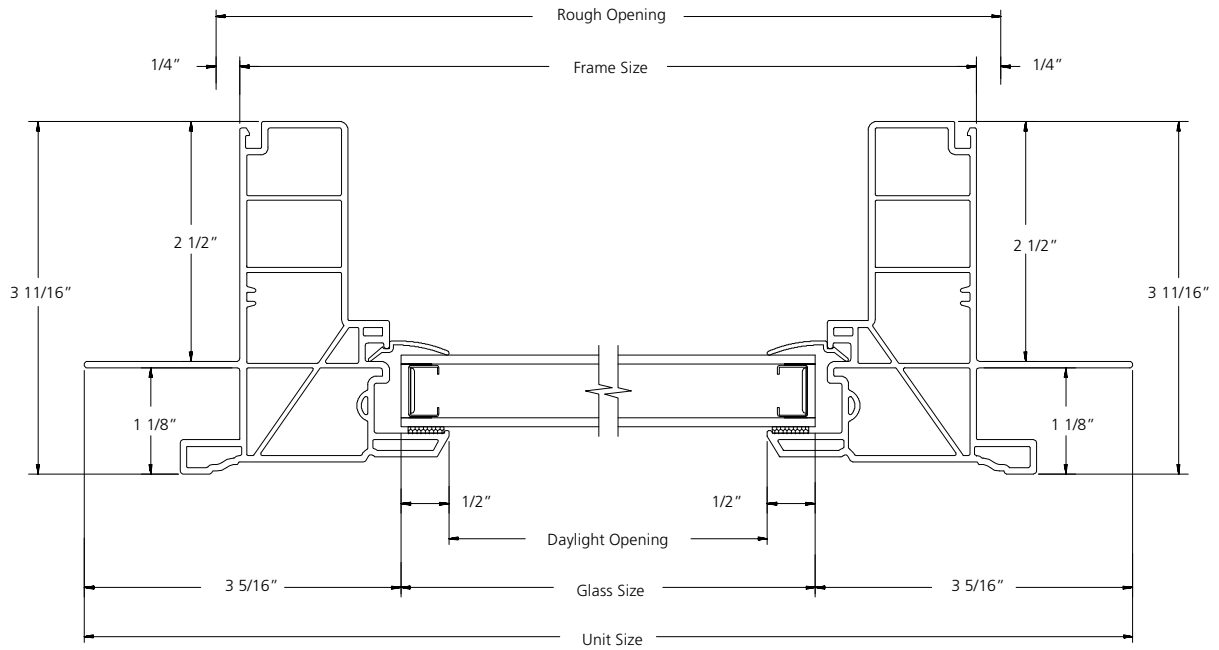

HORIZONTAL SECTION

SCALE: 6" = 1'

2-WIDE PICTURE UNIT

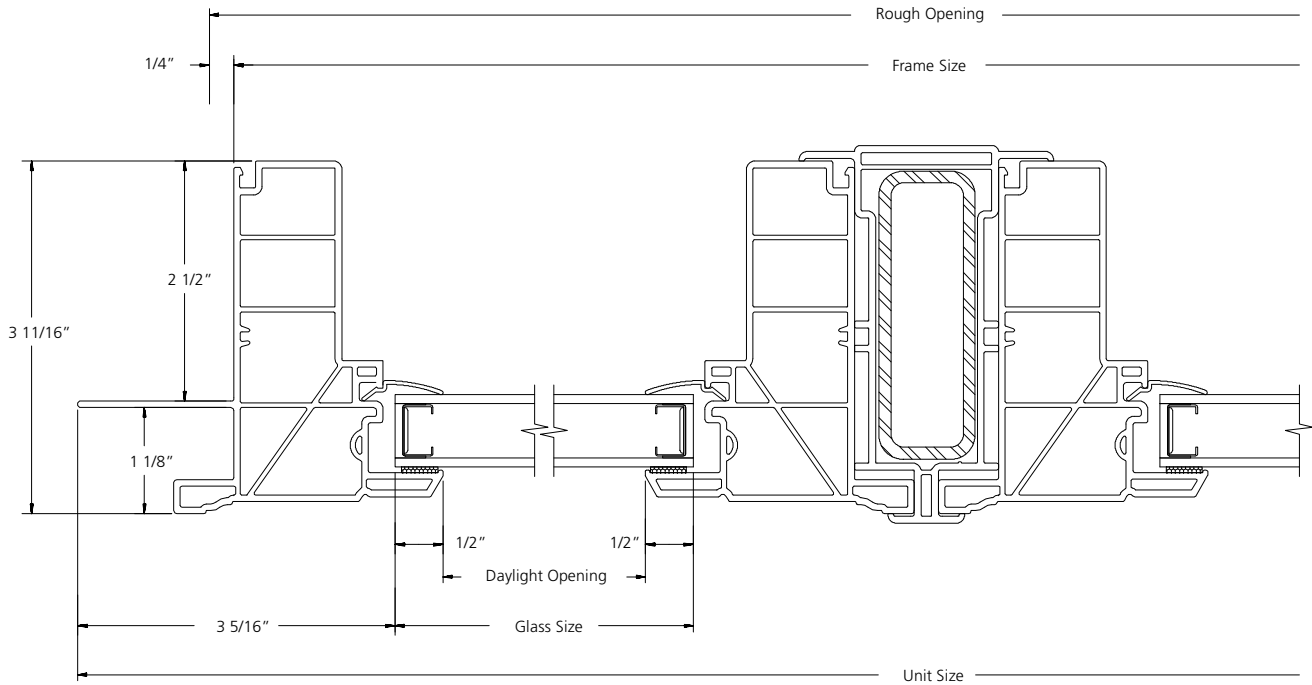

HORIZONTAL SECTION

SCALE: 6" = 1'

3-WIDE PICTURE UNIT

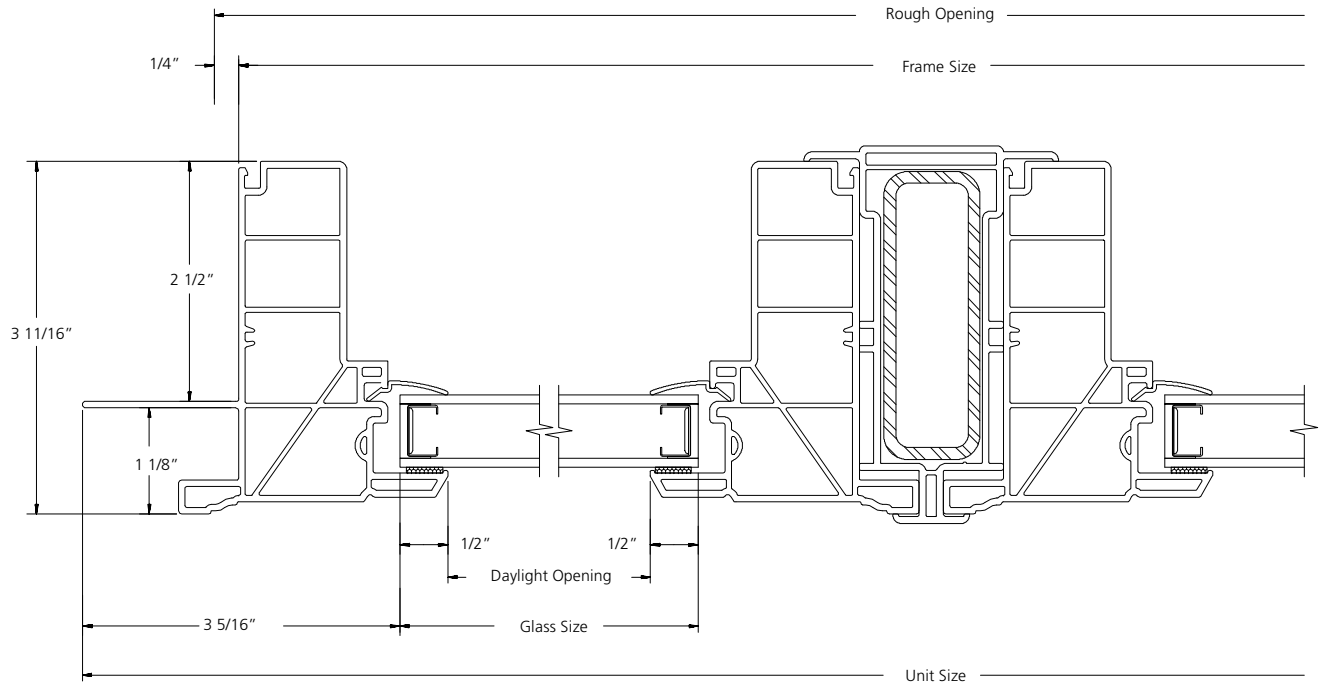

HORIZONTAL SECTION

SCALE: 6" = 1'