TABLE OF CONTENTS

Specifications	5-2
Quick Spec Guide	5-3
Elevations/Sizes: 1/4" Scale	
Single-Hung Tilt	5-4
2-Wide Single-Hung Tilt	5-12
3-Wide Single-Hung Tilt with Center Picture	5-17
Single-Hung Units with Half Round	5-21
2-Wide Single-Hung Tilt with Half Round	5-36
Glazing Options: 3" Scale	5-50
Grille Patterns	5-51
Section Details: 6" Scale	5-52

PRODUCT SPECIFICATIONS

MATERIALS

Extruded vinyl profiles comply with the performance requirements of AAMA 303. The colors extend through the profile of the extrusion with White and Desert Sand colors available.

FRAME

All frames and sash are assembled utilizing fusion-welded technology for added strength and durability. The frame jamb width is 3-1/16" (77.79mm), and the nominal extrusion exterior wall thickness is 0.060". The wall depth of the single-hung product is 1-29/32". The frame incorporates a traditional brickmould profile with an integral j-channel and nailing fin. Weep holes are included on the frame to ensure standing water is directed to the exterior plane of the unit. An interior accessory groove is standard to accommodate various frame accessory and assembly options on the product.

SASH

The tilt sash is 1-3/8" (35.18mm) nominal thickness and is assembled using fusion-welding technology for added strength and durability. The sash also uses a steel reinforcement bar in the horizontal meeting rails for additional strength. The fixed upper glass is direct set into the unit frame.

GLAZING

3/4" (19mm) insulating glass consists of two lites of glass sealed around a spacer. The glass is mounted into the sash using a silicone-glazing compound. The insulating glass units comply with the performance requirements of the IGCC in accordance with either ASTM E774 or E2190. All units except the brickmould product are exterior glazed.

GLAZING OPTIONS

3/4" (19mm) insulated glass is available in clear, Low-E or Low-E 366, tinted, obscure, or other specialty insulating glass as specified. Many glass options are available in tempered glazing. A single use reglazable drywall unit option is available, allowing the user to remove the upper glass and meeting rail.

WEATHER-STRIPPING

A fin-pile weather-strip is applied along dual perimeters of the operating sash. The meeting rails utilize an integral extruded interlock to provide exceptional performance.

HARDWARE

The exclusive WEN-Lock™ with visible latch indicator or a single action cam style lock is available on all windows. Block and tackle balance systems are utilized to support the vertical operation of the sash. Low profile thumb latches (sash retainers) and pivot pins are equipped for utilization of the "tilt" function.

INSECT SCREENS

The optional fiberglass charcoal color insect screen is set in an aluminum frame to match the color of the unit. The screen is secured to the window using a pin and spring loaded plunger system. Insect screens are intended to allow air and light in and to keep insects out. They are not intended to keep anyone or anything from falling through an open door or window. For safety screens or other security devices contact your local building supply retailer.

GRILLES

GBG (Grilles between the Glass) - 5/8" (16mm) and 7/8" (22.2mm) flat or 1" (26mm) contour grilles mounted between the glass panes suspended within the air cavity and color matched to the extrusion color.

SDL (Simulated Divided Lite) - 7/8" (22.2mm) color-matched contour muntins surface mounted on the exterior surfaces of the insulated glass unit to provide a true divided lite appearance.

EXTENSION JAMBS

Extension jambs are regionally available for JELD-WEN Vinyl products. The 4-9/16" and 6-9/16" extension jambs are available in pine clear vinyl wrapped, primed wood, red oak and maple finishes and can be specified on three or four sides of the product.

ADDITIONAL ACCESSORIES

Additional accessories are available for JELD-WEN Vinyl products. Please contact your local building supply retailer for a complete listing of the additional accessories.

INSTALLATION

Installation per JELD-WEN Installation Method for Vinyl Windows JII001, JII010 or JII011. See www.jeld-wen.com/resources for instructions.

PERFORMANCE

NFRC Certified - (rated and labeled in accordance with NFRC)

AAMA/WDMA/CSA 101/I.S.2/A440

R20-DP rated

Optional DP-35 and DP-50 ratings are available

QUICK SPEC GUIDE

SPECIFICATION	STANDARD FEATURES	OPTIONAL FEATURES <i>Some options may require additional lead times. Consult your JELD-WEN Sales Representative.</i>
COLOR	<ul style="list-style-type: none"> • White 	<ul style="list-style-type: none"> • Desert Sand
SIZE	<ul style="list-style-type: none"> • Width: 11-1/2" to 47-1/2" net • Height: 23-1/2" to 83-1/2" net 	
FRAME	<ul style="list-style-type: none"> • Integral Brickmould J-channel 	
GLAZING	<ul style="list-style-type: none"> • Insulating Low-E 	<ul style="list-style-type: none"> • Clear • Low-E 366 • Obscure • Bronze • Gray • Gluechip • Rain • Azurlite • Laminated • All glass available tempered <p><i>regional glass availabilities may differ</i></p>
HARDWARE	<ul style="list-style-type: none"> • Block and Tackle Balance System • Tilt Latches • WEN-Lock™ 	<ul style="list-style-type: none"> • Cam Lock
HARDWARE COLOR	<ul style="list-style-type: none"> • White 	<ul style="list-style-type: none"> • Desert Sand
SCREENS	<ul style="list-style-type: none"> • Fiberglass 	
SCREEN FRAME COLOR	<ul style="list-style-type: none"> • White 	<ul style="list-style-type: none"> • Almond • Desert Sand
GRILLES		<ul style="list-style-type: none"> • 5/8", 1" Contour GBG (grilles between the glass) • 5/8", 7/8" Flat GBG (grilles between the glass) • 7/8" SDL (simulated divided lite) profiles
JAMB DEPTH	<ul style="list-style-type: none"> • 2-29/32" 	<ul style="list-style-type: none"> • Integral J-channel • 4-9/16" Extension Jambs Applied (East only) • 6-9/16" Extension Jambs Applied (East only)
ACCESSORIES		<ul style="list-style-type: none"> • Extension Jamb Retainer • Drip Cap • Drywall Retainer

VINYL BRICKMOULD

SINGLE HUNG ELEVATIONS

• Scale: 1/4" = 10"

UNIT SIZE	20 1/8"(511)	22 1/8"(562)	24 1/8"(613)	26 1/8"(664)	28 1/8"(714)	30 1/8"(765)	32 1/8"(816)	34 1/8"(864)
BRICKMOLD OPENING	18 1/8"(460)	20 1/8"(511)	22 1/8"(562)	24 1/8"(613)	26 1/8"(664)	28 1/8"(714)	30 1/8"(765)	32 1/8"(816)
ROUGH OPENING	18"(457)	20"(508)	22"(559)	24"(610)	26"(660)	28"(711)	30"(762)	32"(813)
FRAME SIZE	17 1/2"(445)	19 1/2"(495)	21 1/2"(546)	23 1/2"(597)	25 1/2"(648)	27 1/2"(699)	29 1/2"(749)	31 1/2"(800)
DAYLIGHT OPENING	11"(279)	13"(330)	15"(381)	17"(432)	19"(483)	21"(533)	23"(584)	25"(635)
	11 3/16"(300)	13 13/16"(351)	15 13/16"(402)	17 13/16"(452)	19 13/16"(503)	21 13/16"(554)	23 13/16"(605)	25 13/16"(656)
32 1/8"(816) 30 1/8"(765) 30"(762) 29 1/2"(749) 10 5/16"(262) 11 3/16"(284)								
BBMVST1830	BBMVST2030	BBMVST2230	BBMVST2430	BBMVST2630	BBMVST2830	BBMVST3030	BBMVST3230	BBMVST3430
36 1/8"(918) 34 1/8"(867) 34"(864) 33 1/2"(851) 12 5/16"(313) 13 3/16"(335)								
BBMVST2034	BBMVST2434	BBMVST2834	BBMVST3234					
38 1/8"(968) 36 1/8"(918) 36"(914) 35 1/2"(902) 13 5/16"(338) 14 3/16"(360)								
BBMVST1836	BBMVST2036	BBMVST2236	BBMVST2436	BBMVST2636	BBMVST2836	BBMVST3036	BBMVST3236	BBMVST3436
39 1/8"(994) 37 1/8"(943) 37"(940) 36 1/2"(927) 13 13/16"(351) 14 1/16"(373)								
BBMVST1837	BBMVST2037	BBMVST2237	BBMVST2437	BBMVST2637	BBMVST2837	BBMVST3037	BBMVST3237	BBMVST3437
40 1/8"(1019) 38 1/8"(968) 38"(965) 37 1/2"(953) 14 5/16"(364) 15 3/16"(386)								
BBMVST2038	BBMVST2438	BBMVST2838	BBMVST3238					
43 1/8"(1095) 41 1/8"(1045) 41 1/4"(1041) 40 1/2"(1029) 15 13/16"(402) 16 1/16"(424)								
BBMVST1841	BBMVST2041	BBMVST2241	BBMVST2441	BBMVST2641	BBMVST2841	BBMVST3041	BBMVST3241	BBMVST3441
44 1/8"(1070) 42 1/8"(1070) 42 1/4"(1067) 41 1/2"(1054) 16 5/16"(414) 17 3/16"(437)								
BBMVST1842	BBMVST2042	BBMVST2242	BBMVST2442	BBMVST2642	BBMVST2842	BBMVST3042	BBMVST3242	BBMVST3442
48 1/8"(1222) 46 1/8"(1172) 46 1/4"(1168) 45 1/2"(1156) 18 5/16"(465) 19 3/16"(487)								
BBMVST2046	BBMVST2446	BBMVST2846	BBMVST3246					

ELEVATION SYMBOL LEGEND:

VALUES IN () ARE IN MILLIMETER CONVERSIONS.

■ BASIC UNIT CLEAR OPENING EXCEEDS 20" IN WIDTH, 24" IN HEIGHT & A MINIMUM OF 5.7 SQ. FT.

NUMBER INDICATES DESIGN PRESSURE (DP) RATING WITH STANDARD GLAZING

Note: Elevations shown DO NOT have exterior trim. Subtract 1/2"(12.7) from M.O. (Masonry Opening) for Unit Sizes. Masonry openings above include Sill Nose, see Trim Options page for Sill Nose specifications. For other Trim Options refer to the Unit Sizing, Rough Opening & Masonry Openings page.

VINYL BRICKMOULD

SINGLE HUNG ELEVATIONS

• Scale: 1/4" = 10"

UNIT SIZE	20 1/8"(511)	22 1/8"(562)	24 1/8"(613)	26 1/8"(664)	28 1/8"(714)	30 1/8"(765)	32 1/8"(816)	34 1/8"(864)
BRICKMOLD OPENING	18 1/8"(460)	20 1/8"(511)	22 1/8"(562)	24 1/8"(613)	26 1/8"(664)	28 1/8"(714)	30 1/8"(765)	32 1/8"(816)
ROUGH OPENING	18"(457)	20"(508)	22"(559)	24"(610)	26"(660)	28"(711)	30"(762)	32"(813)
FRAME SIZE	17 1/2"(445)	19 1/2"(495)	21 1/2"(546)	23 1/2"(597)	25 1/2"(648)	27 1/2"(699)	29 1/2"(749)	31 1/2"(800)
DAYLIGHT OPENING	11"(279)	13"(330)	15"(381)	17"(432)	19"(483)	21"(533)	23"(584)	25"(635)
	11 13/16"(300)	13 13/16"(351)	15 13/16"(402)	17 13/16"(452)	19 13/16"(503)	21 13/16"(554)	23 13/16"(605)	25 13/16"(656)

50 1/8"(1273)
48 1/8"(1222)
48 1/8"(1216)
47 1/2"(1207)
19 5/16"(481)
20 3/16"(513)

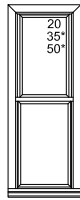

BBMVS11848



BBMVS2048



BBMVS2248



BBMVS2448

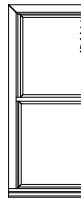

BBMVS2648



BBMVS2848

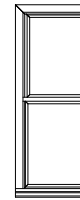

BBMVS3048

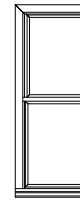

BBMVS3248

51 1/8"(1298)
49 1/8"(1248)
48 1/2"(1245)
48 1/2"(1232)
19 13/16"(503)
20 11/16"(526)

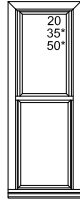

BBMVS11849

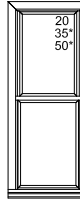

BBMVS2049

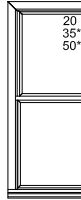

BBMVS2249



BBMVS2449

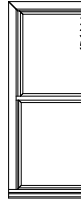

BBMVS2649



BBMVS2849

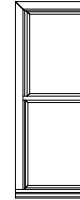

BBMVS3049

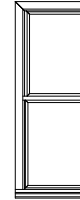

BBMVS3249

52 1/8"(1324)
50 1/8"(1273)
50 1/2"(1270)
49 1/2"(1257)
20 5/16"(516)
21 3/16"(538)

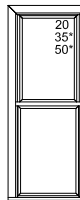

BBMVS2050

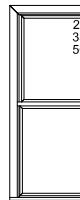

BBMVS2450

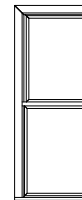

BBMVS2850

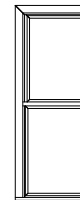

BBMVS3250

54 1/8"(1375)
52 1/8"(1324)
52 1/2"(1321)
51 1/2"(1308)
21 5/16"(541)
22 3/16"(564)



BBMVS2052

55 1/8"(1400)
53 1/8"(1349)
53 1/2"(1346)
52 1/2"(1334)
21 13/16"(554)
22 11/16"(576)

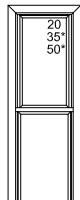

BBMVS11853

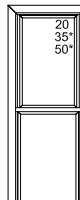

BBMVS2053

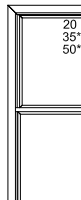

BBMVS2253



BBMVS2453

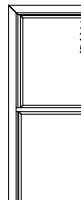

BBMVS2653

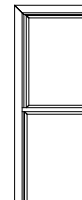

BBMVS2853

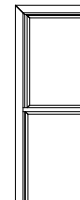

BBMVS3053

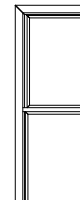

BBMVS3253

56 1/8"(1426)
54 1/8"(1375)
54 1/2"(1372)
53 1/2"(1359)
22 5/16"(567)
23 3/16"(589)

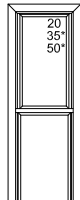

BBMVS11854

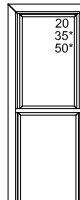

BBMVS2054

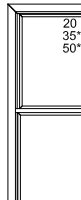

BBMVS2254



BBMVS2454

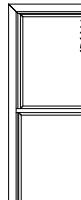

BBMVS2654

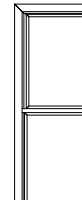

BBMVS2854

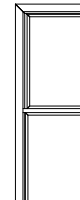

BBMVS3054

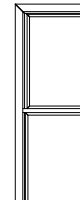

BBMVS3254

VINYL BRICKMOULD SINGLE HUNG ELEVATIONS

• Scale: 1/4" = 10"

UNIT SIZE	20 1/8"(511)	22 1/8"(562)	24 1/8"(613)	26 1/8"(664)	28 1/8"(714)	30 1/8"(765)	32 1/8"(816)	34 1/8"(864)
BRICKMOLD OPENING	18 1/8"(460)	20 1/8"(511)	22 1/8"(562)	24 1/8"(613)	26 1/8"(664)	28 1/8"(714)	30 1/8"(765)	32 1/8"(816)
ROUGH OPENING	18"(457)	20"(508)	22"(559)	24"(610)	26"(660)	28"(711)	30"(762)	32"(813)
FRAME SIZE	17 1/2"(445)	19 1/2"(495)	21 1/2"(546)	23 1/2"(597)	25 1/2"(648)	27 1/2"(699)	29 1/2"(749)	31 1/2"(800)
DAYLIGHT OPENING	11"(279)	13"(330)	15"(381)	17"(432)	19"(483)	21"(533)	23"(584)	25"(635)
	11 13/16"(300)	13 13/16"(351)	15 13/16"(402)	17 13/16"(452)	19 13/16"(503)	21 13/16"(554)	23 13/16"(605)	25 13/16"(656)

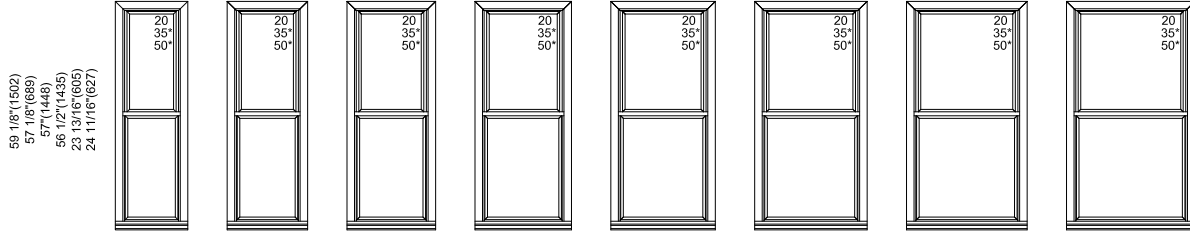

BBMVST1857 BBMVST2057 BBMVST2257 BBMVST2457 BBMVST2657 BBMVST2857 BBMVST3057 BBMVST3257

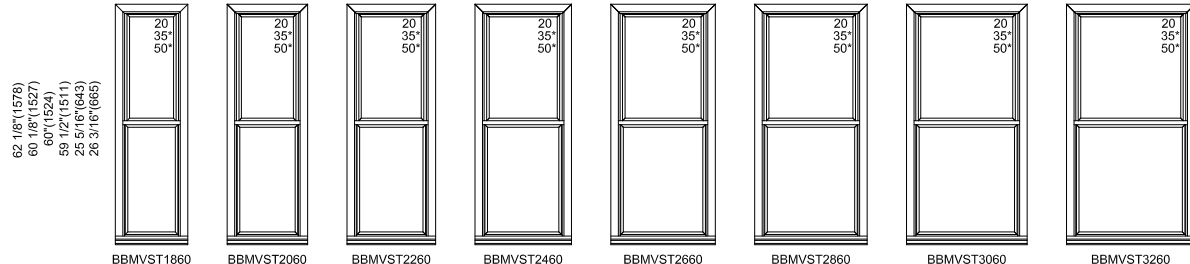

BBMVST1860 BBMVST2060 BBMVST2260 BBMVST2460 BBMVST2660 BBMVST2860 BBMVST3060 BBMVST3260

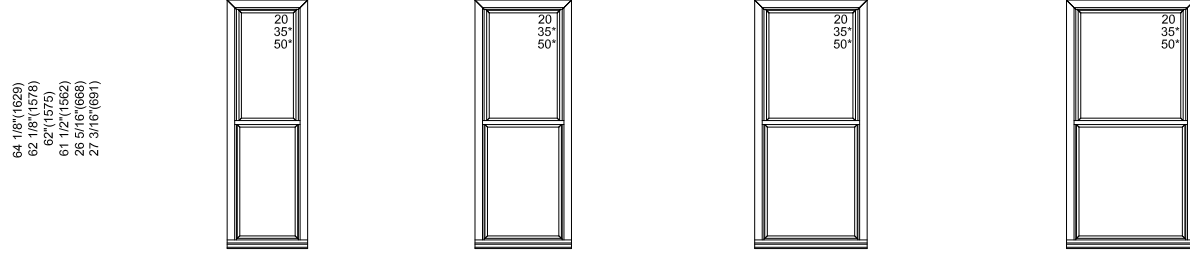

BBMVST2062 BBMVST2462 BBMVST2862 BBMVST3262

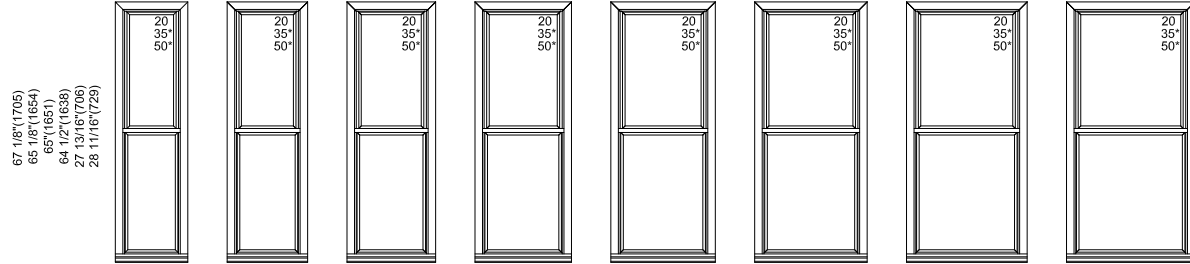

BBMVST1865 BBMVST2065 BBMVST2265 BBMVST2465 BBMVST2665 BBMVST2865 BBMVST3065 BBMVST3265

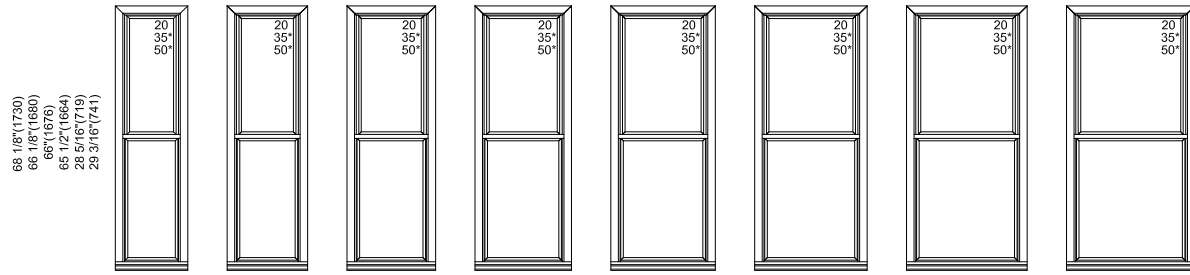

BBMVST1866 BBMVST2066 BBMVST2266 BBMVST2466 BBMVST2666 BBMVST2866 BBMVST3066 BBMVST3266

VINYL BRICKMOULD SINGLE HUNG ELEVATIONS

• Scale: 1/4" = 10"

UNIT SIZE
BRICKMOLD OPENING
ROUGH OPENING
FRAME SIZE
DAYLIGHT OPENING

20 1/8"(511)
18 1/8"(460)
18"(457)
17 1/2"(445)
11"(279)
11 13/16"(300)

22 1/8"(562)
20 1/8"(511)
20"(508)
19 1/2"(495)
13"(330)
13 13/16"(351)

24 1/8"(613)
22 1/8"(562)
22"(559)
21 1/2"(546)
15"(381)
15 13/16"(402)

26 1/8"(664)
24 1/8"(613)
24"(610)
23 1/2"(597)
17"(432)
17 13/16"(452)

28 1/8"(714)
26 1/8"(664)
26"(660)
25 1/2"(648)
19"(483)
19 13/16"(503)

30 1/8"(765)
28 1/8"(714)
28"(711)
27 1/2"(699)
21"(533)
21 13/16"(554)

32 1/8"(816)
30 1/8"(765)
30"(762)
29 1/2"(749)
23"(584)
23 13/16"(605)

34 1/8"(864)
32 1/8"(816)
32"(813)
31 1/2"(800)
25"(635)
25 13/16"(656)

71 1/8"(1807)
69 1/8"(1756)
68"(1753)
68 1/2"(1740)
29 13/16"(757)
30 11/16"(760)

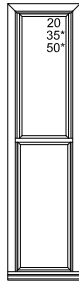

BBMVS11869

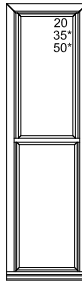

BBMVS2069

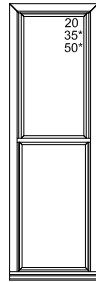

BBMVS2269

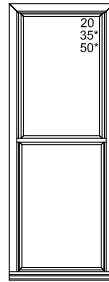

BBMVS2669

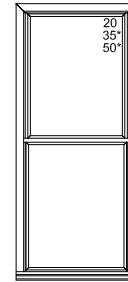

BBMVS3069

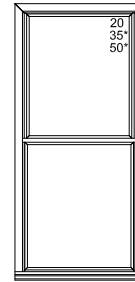

BBMVS3269

74 1/8"(1882)
72 1/8"(1832)
72"(1829)
71 1/2"(1816)
31 5/16"(795)
32 3/16"(818)

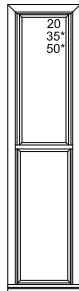

BBMVS11872

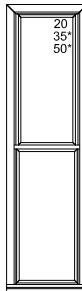

BBMVS2072

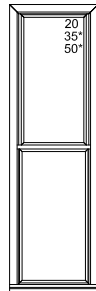

BBMVS2272

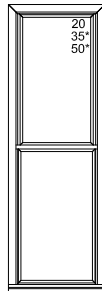

BBMVS2472

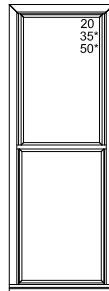

BBMVS2672

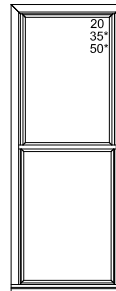

BBMVS2872

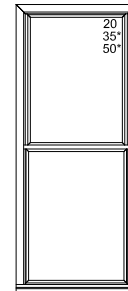

BBMVS3072

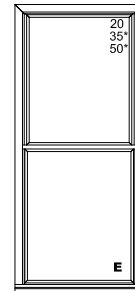

BBMVS3272

76 1/8"(1924)
74 1/8"(1883)
74"(1880)
73 1/2"(1867)
32 5/16"(821)
31 3/16"(792)

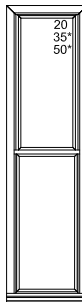

BBMVS2074

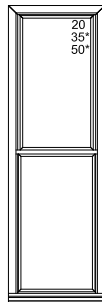

BBMVS2474

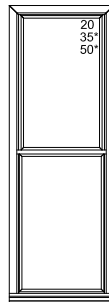

BBMVS2674

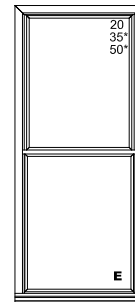

BBMVS3274

78 1/8"(2010)
77 1/8"(1959)
77"(1956)
76 1/2"(1943)
33 13/16"(859)
34 11/16"(881)

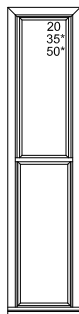

BBMVS1877

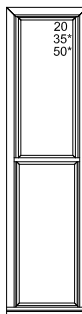

BBMVS2077

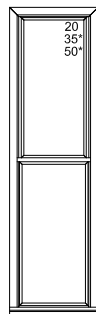

BBMVS2277

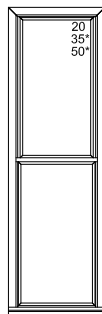

BBMVS2477

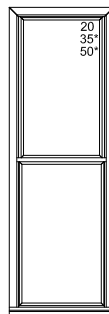

BBMVS2677

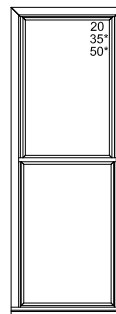

BBMVS2877

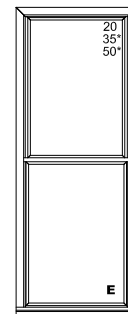

BBMVS3077

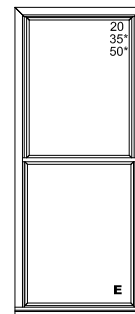

BBMVS3277

VINYL BRICKMOULD SINGLE HUNG ELEVATIONS

• Scale: 1/4" = 10"

UNIT SIZE
BRICKMOLD OPENING
ROUGH OPENING
FRAME SIZE
DAYLIGHT OPENING

20 1/8"(511)
18 1/8"(460)
18"(457)
17 1/2"(445)
11"(279)
11 13/16"(300)

22 1/8"(562)
20 1/8"(511)
20"(508)
19 1/2"(495)
13"(330)
13 13/16"(351)

24 1/8"(613)
22 1/8"(562)
22"(559)
21 1/2"(546)
15"(381)
15 13/16"(402)

26 1/8"(664)
24 1/8"(613)
24"(610)
23 1/2"(597)
17"(432)
17 13/16"(452)

28 1/8"(714)
26 1/8"(664)
26"(660)
25 1/2"(648)
19"(483)
19 13/16"(503)

30 1/8"(765)
28 1/8"(714)
28"(711)
27 1/2"(699)
21"(533)
21 13/16"(554)

32 1/8"(816)
30 1/8"(765)
30"(762)
29 1/2"(749)
23"(584)
23 13/16"(605)

34 1/8"(864)
32 1/8"(816)
32"(813)
31 1/2"(800)
25"(635)
25 13/16"(656)

80 1/8"(2035)
78 1/8"(1984)
78"(1981)
77 1/2"(1969)
34 5/16"(872)
35 3/16"(894)

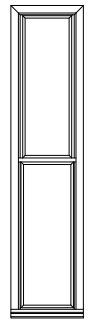

BBMVST1878

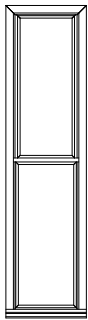

BBMVST2078

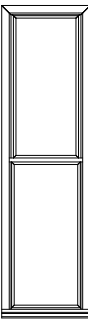

BBMVST2278

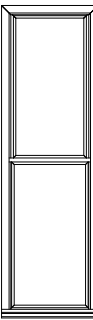

BBMVST2478

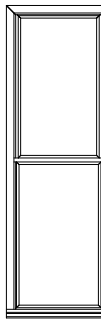

BBMVST2678



BBMVST2878

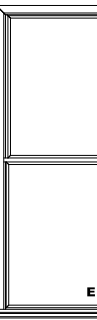

BBMVST3078



BBMVST3278

86 1/8"(2188)
84 1/8"(2137)
84"(2134)
83 1/2"(2121)
37 5/16"(948)
38 3/16"(970)

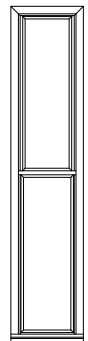

BBMVST1884

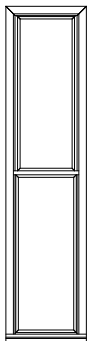

BBMVST2084

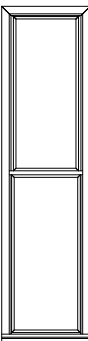

BBMVST2284

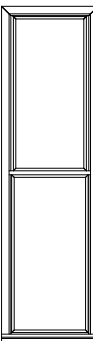

BBMVST2484

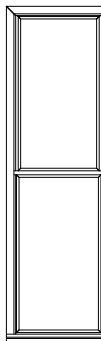

BBMVST2684



BBMVST2884

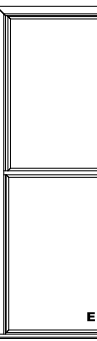

BBMVST3084



BBMVST3284

92 1/8"(2340)
90 1/8"(2289)
90"(2286)
89 1/2"(2273)
40 5/16"(1024)
41 3/16"(1046)

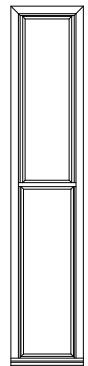

BBMVST1890

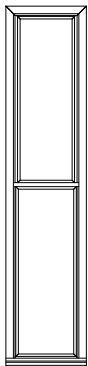

BBMVST2090

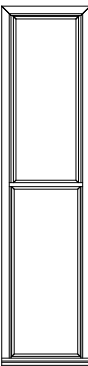

BBMVST2290

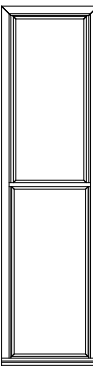

BBMVST2490

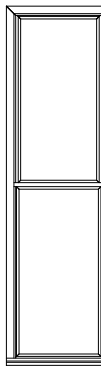

BBMVST2690



BBMVST2890

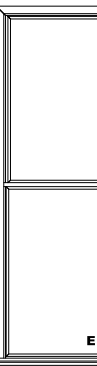

BBMVST3090



BBMVST3290

98 1/8"(2492)
96 1/8"(2442)
96"(2438)
95 1/2"(2426)
43 5/16"(1100)
44 3/16"(1122)

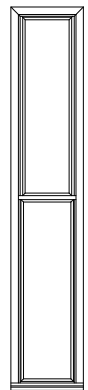

BBMVST1896

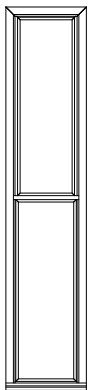

BBMVST2096

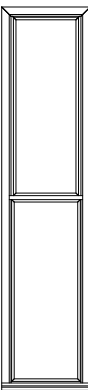

BBMVST2296

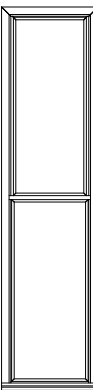

BBMVST2496

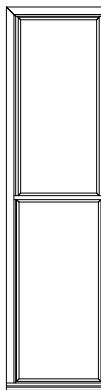

BBMVST2696



BBMVST2896

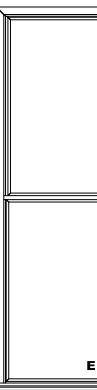

BBMVST3096



BBMVST3296

VINYL BRICKMOULD SINGLE HUNG ELEVATIONS

• Scale: 1/4" = 10"

UNIT SIZE
BRICKMOLD OPENING
ROUGH OPENING
FRAME SIZE
DAYLIGHT OPENING

36 1/8"(918)
34 1/8"(867)
34"(864)
33 1/2"(851)
27"(686)
27 13/16"(706)

38 1/8"(968)
36 1/8"(918)
36"(914)
35 1/2"(902)
29"(737)
29 13/16"(757)

40 1/8"(1019)
38 1/8"(968)
38"(965)
37 1/2"(953)
31"(787)
31 13/16"(808)

42 1/8"(1070)
40 1/8"(1019)
40"(1016)
39 1/2"(1003)
33"(858)
33 13/16"(859)

44 1/8"(1121)
42 1/8"(1070)
42"(1067)
41 1/2"(1054)
35"(889)
35 13/16"(910)

46 1/8"(1172)
44 1/8"(1121)
44"(1118)
43 1/2"(1105)
37"(940)
37 13/16"(960)

32 1/8"(816)
30 1/8"(765)
30"(762)
28 1/2"(749)
19 5/8"(492)
11 3/16"(284)

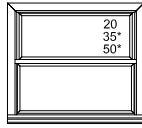

BBMVST3430

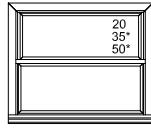

BBMVST3630

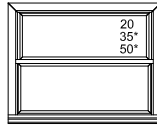

BBMVST3830

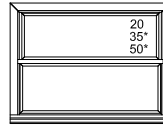

BBMVST4030

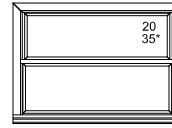

BBMVST4230

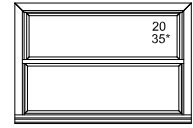

BBMVST4430

36 1/8"(918)
34 1/8"(867)
34"(864)
33 1/2"(851)
13 3/16"(335)

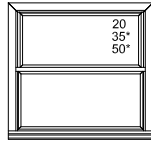

BBMVST3634

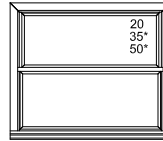

BBMVST4034

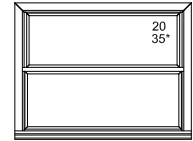

BBMVST4434

38 1/8"(968)
36 1/8"(918)
36"(914)
35 1/2"(902)
14 3/16"(380)

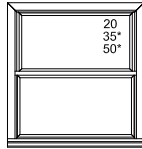

BBMVST3436

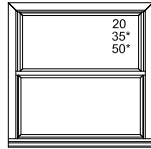

BBMVST3636

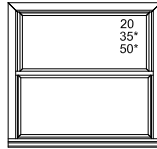

BBMVST3836

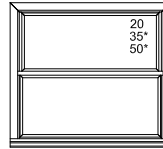

BBMVST4036

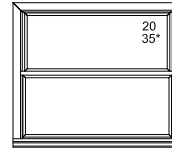

BBMVST4236

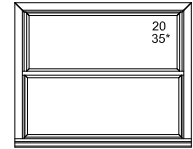

BBMVST4436

39 1/8"(994)
37 1/8"(943)
37"(940)
36 1/2"(927)
13 3/16"(335)
14 11/16"(372)

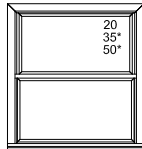

BBMVST3437

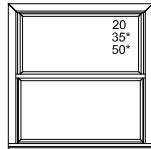

BBMVST3637

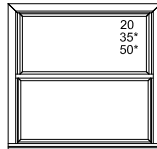

BBMVST3837

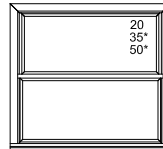

BBMVST4037

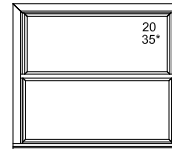

BBMVST4237

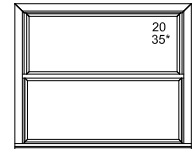

BBMVST4437

40 1/8"(1019)
38 1/8"(968)
38"(965)
37 1/2"(953)
15 3/16"(388)

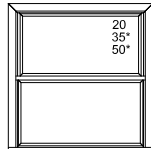

BBMVST3638

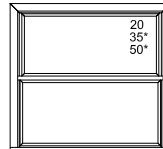

BBMVST4038

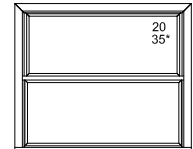

BBMVST4438

43 1/8"(1095)
41 1/8"(1045)
41"(1041)
40 1/2"(1029)
15 3/16"(388)
16 11/16"(424)

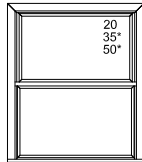

BBMVST3441

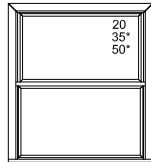

BBMVST3641

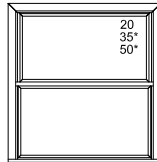

BBMVST3841

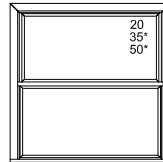

BBMVST4041

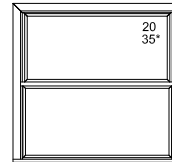

BBMVST4241

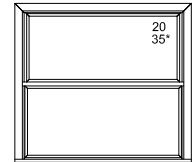

BBMVST4441

44 1/8"(1070)
42 1/8"(1020)
42"(1016)
41 1/2"(1003)
17 3/16"(437)

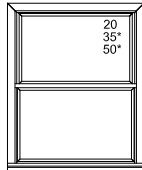

BBMVST3442

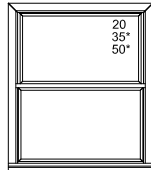

BBMVST3642

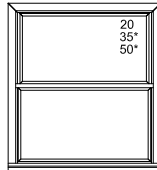

BBMVST3842

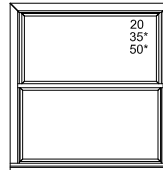

BBMVST4042

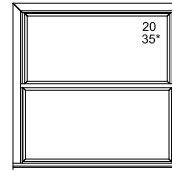

BBMVST4242

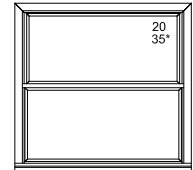

BBMVST4442

48 1/8"(1222)
46 1/8"(1172)
46"(1168)
45 1/2"(1156)
19 3/16"(487)

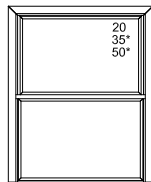

BBMVST3646

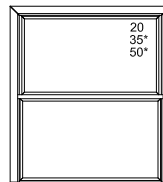

BBMVST4046

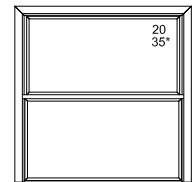

BBMVST4446

VINYL BRICKMOULD SINGLE HUNG ELEVATIONS

• Scale: 1/4" = 10"

UNIT SIZE
BRICKMOLD OPENING
ROUGH OPENING
FRAME SIZE
DAYLIGHT OPENING

36 1/8"(918)
34 1/8"(867)
34"(864)
33 1/2"(851)
27"(686)
27 13/16"(706)

38 1/8"(968)
36 1/8"(918)
36"(914)
35 1/2"(902)
29"(737)
29 13/16"(757)

40 1/8"(1019)
38 1/8"(968)
38"(965)
37 1/2"(953)
31"(787)
31 13/16"(808)

42 1/8"(1070)
40 1/8"(1019)
40"(1016)
39 1/2"(1003)
33"(838)
33 13/16"(859)

44 1/8"(1121)
42 1/8"(1070)
42"(1067)
41 1/2"(1054)
35"(889)
35 13/16"(910)

46 1/8"(1172)
44 1/8"(1121)
44"(1118)
43 1/2"(1105)
37"(940)
37 13/16"(960)

50 1/8"(1273)
48 1/8"(1222)
48"(1219)
47 1/2"(1207)
19 5/16"(491)
20 3/16"(513)

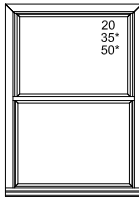

BBMVST3448

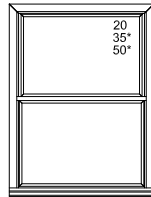

BBMVST3648

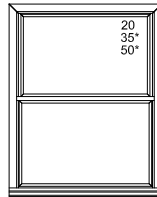

BBMVST3848

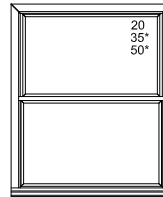

BBMVST4048

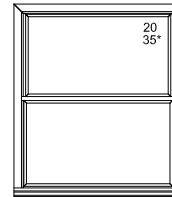

BBMVST4248

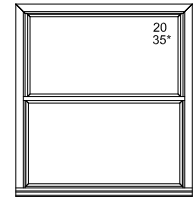

BBMVST4448

51 1/8"(1299)
49 1/8"(1248)
49"(1245)
48 1/2"(1232)
19 13/16"(503)
20 1/16"(526)

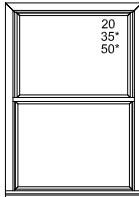

BBMVST3449

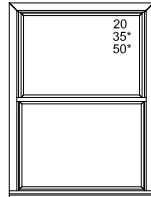

BBMVST3649

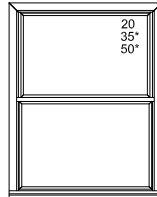

BBMVST3849

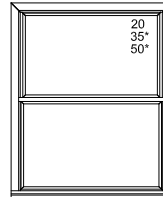

BBMVST4049

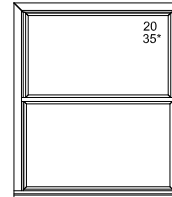

BBMVST4249

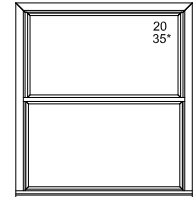

BBMVST4449

52 1/8"(1324)
50 1/8"(1273)
50"(1270)
48 1/2"(1257)
20 5/16"(516)
21 3/16"(538)

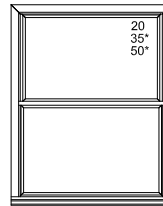

BBMVST4050

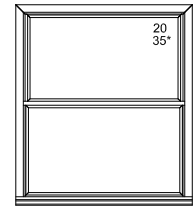

BBMVST4450

55 1/8"(1400)
53 1/8"(1348)
53"(1346)
52 1/2"(1334)
21 13/16"(554)
22 11/16"(576)

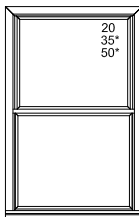

BBMVST3453

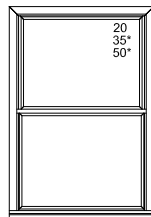

BBMVST3653

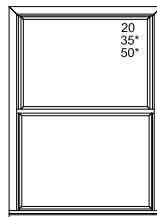

BBMVST3853

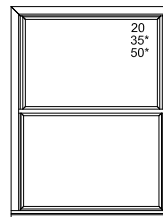

BBMVST4053

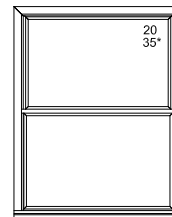

BBMVST4253

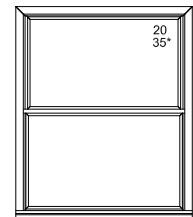

BBMVST4453

56 1/8"(1426)
54 1/8"(1375)
54"(1372)
53 1/2"(1363)
22 5/16"(567)
23 3/16"(589)

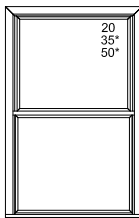

BBMVST3454

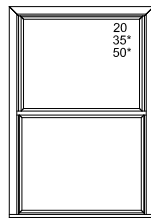

BBMVST3654

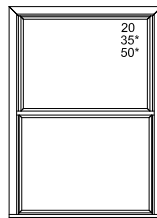

BBMVST3854

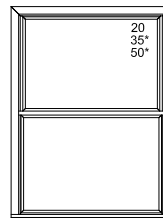

BBMVST4054

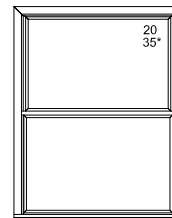

BBMVST4254

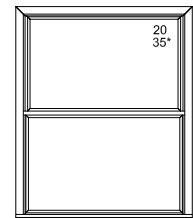

BBMVST4454

59 1/8"(1502)
57 1/8"(1450)
57"(1448)
56 1/2"(1435)
23 13/16"(603)
24 11/16"(627)

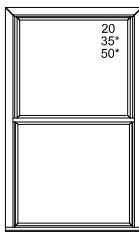

BBMVST3457

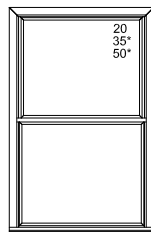

BBMVST3657

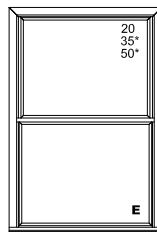

BBMVST3857

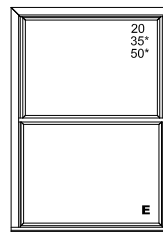

BBMVST4057

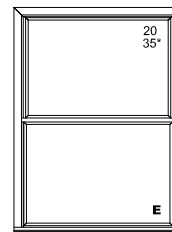

BBMVST4257

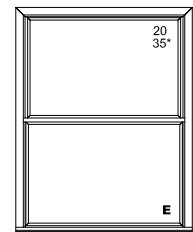

BBMVST4457

VINYL BRICKMOULD SINGLE HUNG ELEVATIONS

• Scale: 1/4" = 10"

UNIT SIZE
BRICKMOLD OPENING
ROUGH OPENING
FRAME SIZE
DAYLIGHT OPENING

36 1/8"(918)
34 1/8"(867)
34"(864)
33 1/2"(851)
27"(686)
27 13/16"(706)

62 1/8"(1578)
60 1/8"(1527)
60 1/2"(1538)
59 1/2"(1511)
26 5/16"(643)
26 3/16"(665)

64 1/8"(1629)
62 1/8"(1578)
62 1/2"(1589)
61 1/2"(1562)
26 5/16"(668)
27 3/16"(691)

67 1/8"(1705)
65 1/8"(1654)
65 1/2"(1665)
64 1/2"(1638)
27 13/16"(706)
28 11/16"(729)

68 1/8"(1730)
66 1/8"(1680)
66 1/2"(1691)
65 1/2"(1664)
28 5/16"(719)
29 3/16"(741)

71 1/8"(1807)
69 1/8"(1756)
69 1/2"(1767)
68 1/2"(1740)
29 13/16"(757)
30 11/16"(780)

38 1/8"(968)
36 1/8"(918)
36"(914)
35 1/2"(902)
29"(737)
29 13/16"(757)

40 1/8"(1019)
38 1/8"(968)
38"(965)
37 1/2"(953)
31"(787)
31 13/16"(808)

42 1/8"(1070)
40 1/8"(1019)
40"(1016)
39 1/2"(1003)
33"(838)
33 13/16"(859)

44 1/8"(1121)
42 1/8"(1070)
42"(1067)
41 1/2"(1054)
35"(889)
35 13/16"(910)

46 1/8"(1172)
44 1/8"(1121)
44"(1118)
43 1/2"(1105)
37"(940)
37 13/16"(960)

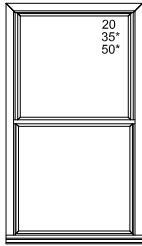

BBMVS3460

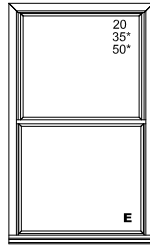

BBMVST3660

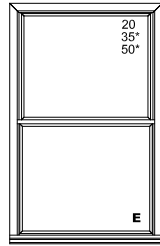

BBMVST3860

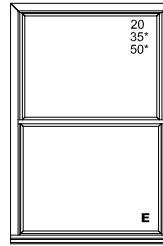

BBMVST4060

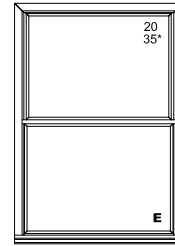

BBMVST4260

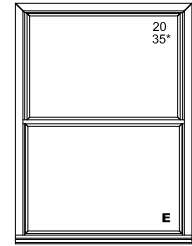

BBMVST4460

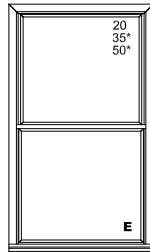

BBMVST3662

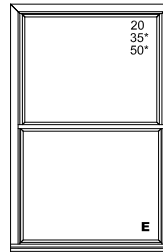

BBMVST4062

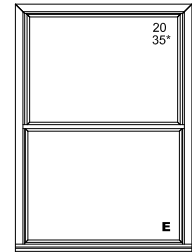

BBMVST4462

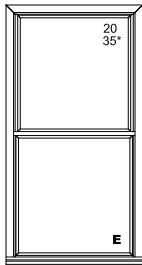

BBMVS3465

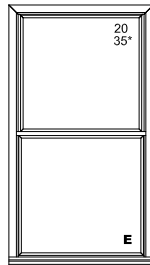

BBMVST3665

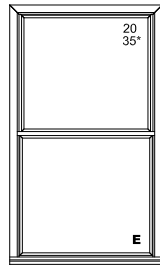

BBMVST3865

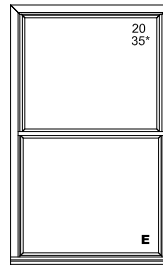

BBMVST4065

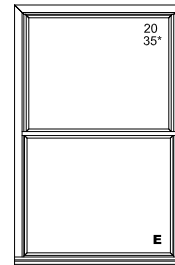

BBMVST4265

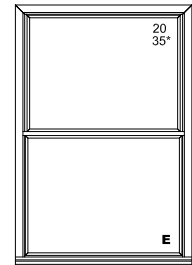

BBMVST4465

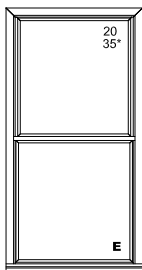

BBMVS3466

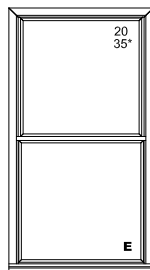

BBMVST3666

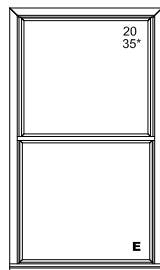

BBMVST3866

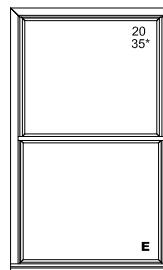

BBMVST4066

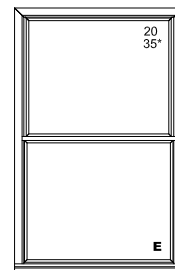

BBMVST4266

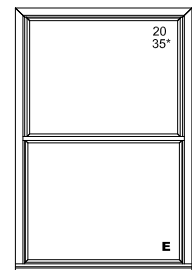

BBMVST4466

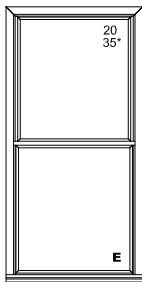

BBMVS3469

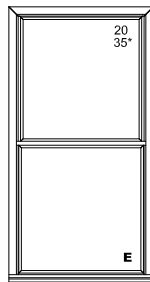

BBMVST3669

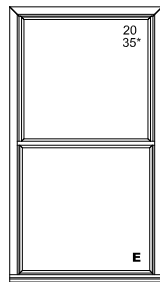

BBMVST3869

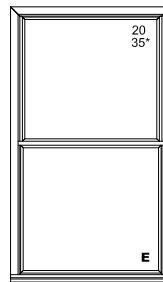

BBMVST4069

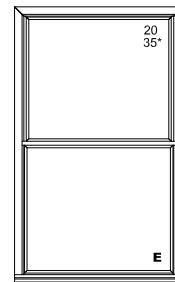

BBMVST4269

VINYL BRICKMOULD SINGLE HUNG ELEVATIONS

• Scale: 1/4" = 10"

UNIT SIZE
BRICKMOLD OPENING
ROUGH OPENING
FRAME SIZE
DAYLIGHT OPENING

36 1/8"(918)
34 1/8"(867)
34"(864)
33 1/2"(851)
27 13/16"(706)

38 1/8"(968)
36 1/8"(918)
36"(914)
35 1/2"(902)
29"(737)

40 1/8"(1019)
38 1/8"(968)
38"(965)
37 1/2"(953)
31"(787)

42 1/8"(1070)
40 1/8"(1019)
40"(1016)
39 1/2"(1003)
33"(838)

44 1/8"(1121)
42 1/8"(1070)
42"(1067)
41 1/2"(1054)
35"(889)

46 1/8"(1172)
44 1/8"(1121)
44"(1118)
43 1/2"(1105)
37"(940)

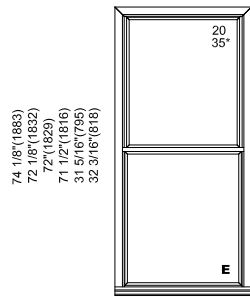

74 1/8"(1832)
72 1/8"(1832)
72"(1829)
71 1/2"(1816)
31 5/16"(795)
32 3/16"(818)

BBMVST3472

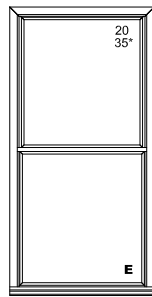

BBMVST3672

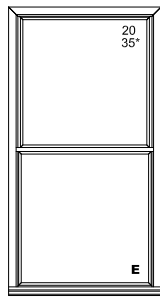

BBMVST3872

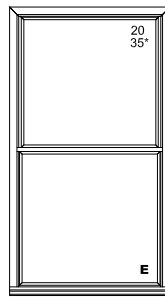

BBMVST4072

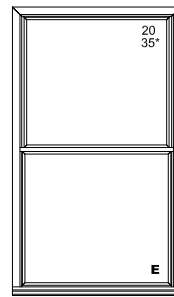

BBMVST4272

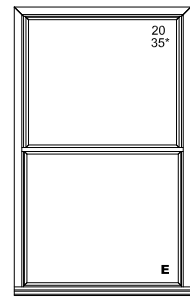

BBMVST4472

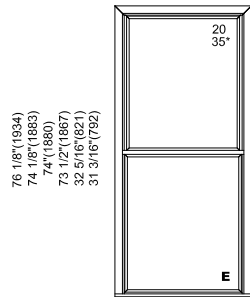

76 1/8"(1934)
74 1/8"(1893)
74"(1890)
73 1/2"(1867)
32 5/16"(821)
31 3/16"(792)

BBMVST3474

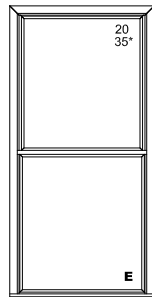

BBMVST3674

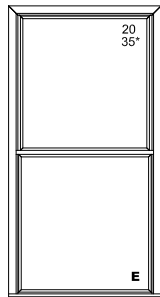

BBMVST3874

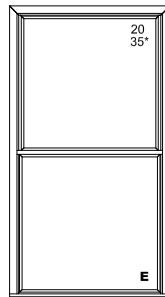

BBMVST4074

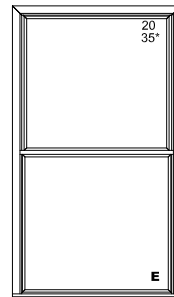

BBMVST4274

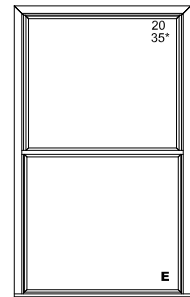

BBMVST4474

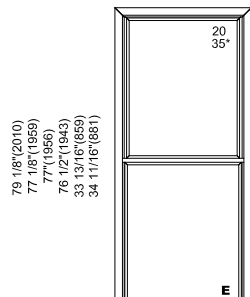

78 1/8"(2010)
77 1/8"(1969)
77"(1966)
76 1/2"(1943)
33 13/16"(859)
34 1/16"(881)

BBMVST3477

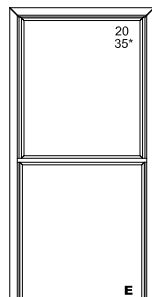

BBMVST3677

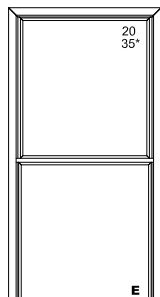

BBMVST3877

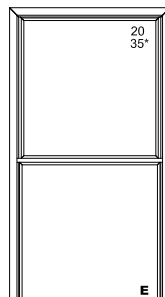

BBMVST4077

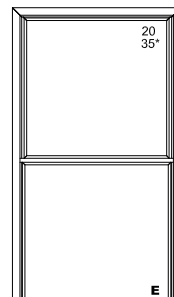

BBMVST4277

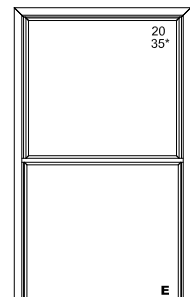

BBMVST4477

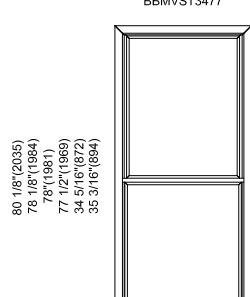

80 1/8"(2035)
78 1/8"(1994)
78"(1991)
77 1/2"(1969)
34 5/16"(872)
35 3/16"(894)

BBMVST3478

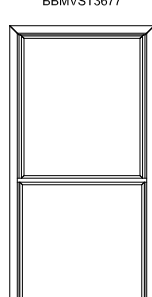

BBMVST3678

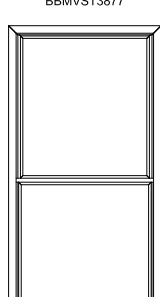

BBMVST3878

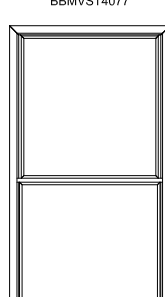

BBMVST4078

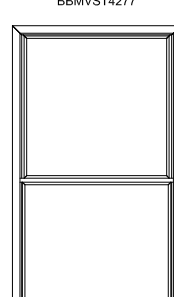

BBMVST4278

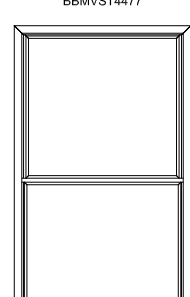

BBMVST4478

VINYL BRICKMOULD SINGLE HUNG ELEVATIONS

• Scale: 1/4" = 10"

UNIT SIZE
BRICKMOLD OPENING
ROUGH OPENING
FRAME SIZE
DAYLIGHT OPENING

36 1/8"(918)
34 1/8"(867)
34"(864)
33 1/2"(851)
27"(686)
27 13/16"(706)

38 1/8"(968)
36 1/8"(918)
36"(914)
35 1/2"(902)
29"(737)
29 13/16"(757)

40 1/8"(1019)
38 1/8"(968)
38"(965)
37 1/2"(953)
31"(787)
31 13/16"(808)

42 1/8"(1070)
40 1/8"(1019)
40"(1016)
39 1/2"(1003)
33"(838)
33 13/16"(859)

44 1/8"(1121)
42 1/8"(1070)
42"(1067)
41 1/2"(1054)
35"(889)
35 13/16"(910)

46 1/8"(1172)
44 1/8"(1121)
44"(1118)
43 1/2"(1105)
37"(940)
37 13/16"(960)

86 1/8"(2188)
84 1/8"(2137)
84"(2134)
83 1/2"(2121)
37 5/16"(946)
38 3/16"(970)

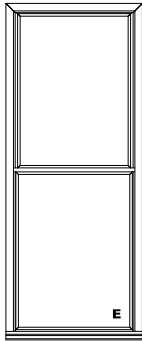

BBMVST3484

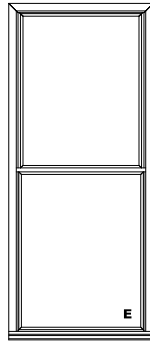

BBMVST3684

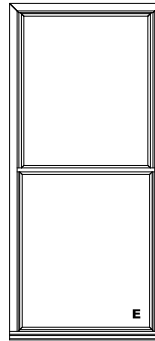

BBMVST3884

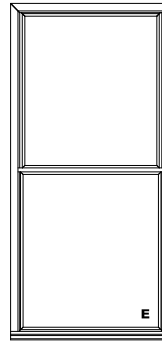

BBMVST4084

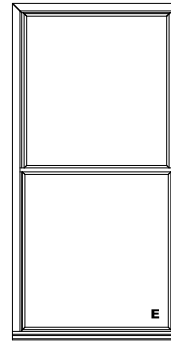

BBMVST4284

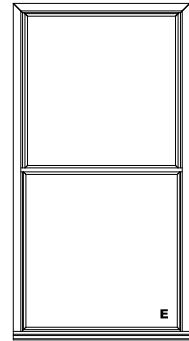

BBMVST4484

92 1/8"(2340)
90 1/8"(2289)
90"(2286)
89 1/2"(2273)
40 5/16"(1024)
41 3/16"(1046)

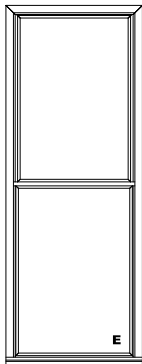

BBMVST3490

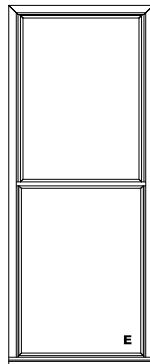

BBMVST3690

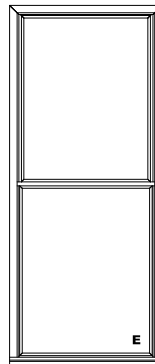

BBMVST3890

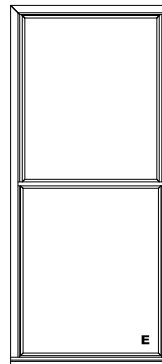

BBMVST4090

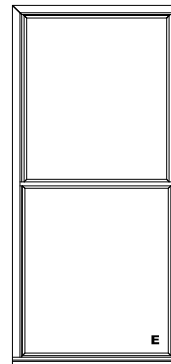

BBMVST4290

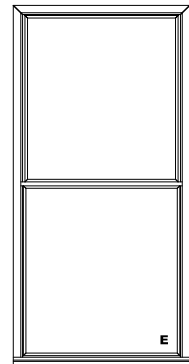

BBMVST4490

98 1/8"(2492)
96 1/8"(2442)
96"(2438)
95 1/2"(2426)
43 5/16"(1100)
44 3/16"(1122)

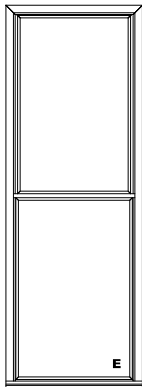

BBMVST3496

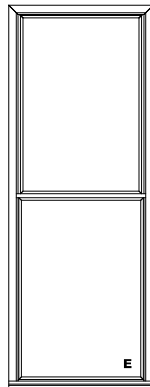

BBMVST3696

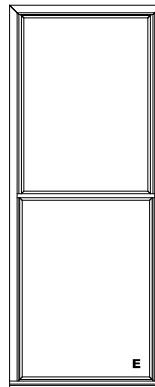

BBMVST3896

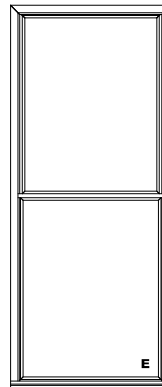

BBMVST4096

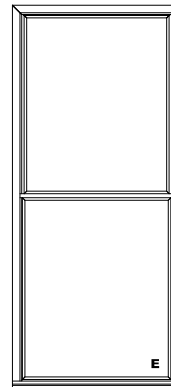

BBMVST4296

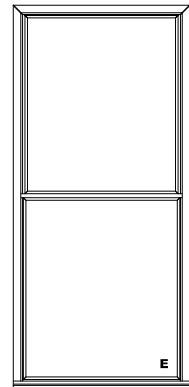

BBMVST4496

VINYL BRICKMOULD SINGLE HUNG ELEVATIONS

• Scale: 1/4" = 10"

UNIT SIZE
BRICKMOLD OPENING
ROUGH OPENING
FRAME SIZE
DAYLIGHT OPENING

48 1/8"(1222)
46 1/8"(1172)
46"(1168)
45 1/2"(1156)
39"(991)
39 13/16"(1011)

50 1/8"(1273)
48 1/8"(1222)
48"(1219)
47 1/2"(1207)
41"(1041)
41 13/16"(1062)

52 1/8"(1324)
50 1/8"(1273)
50"(1270)
49 1/2"(1257)
43"(1092)
43 13/16"(1113)

56 1/8"(1426)
54 1/8"(1375)
54"(1372)
53 1/2"(1359)
47"(1194)
47 13/16"(1214)

26 1/8"(664)
24 1/8"(613)
24"(610)
23 1/2"(597)
15 3/16"(386)
8 3/16"(206)



BBMVST5024

28 1/8"(714)
26 1/8"(664)
26"(660)
25 1/2"(646)
15 3/16"(391)
9 3/16"(233)



BBMVST5026

30 1/8"(765)
28 1/8"(714)
28"(711)
27 1/2"(699)
15 3/16"(391)
10 3/16"(265)

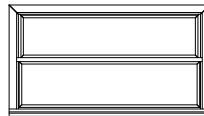

BBMVST5028

32 1/8"(816)
30 1/8"(765)
30"(762)
29 1/2"(749)
10 5/16"(262)
11 3/16"(284)

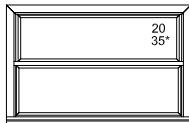

BBMVST4630

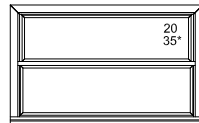

BBMVST4830

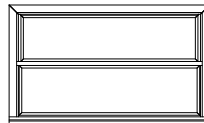

BBMVST5030

33 1/8"(841)
32 1/8"(816)
32"(813)
31 1/2"(800)
15 3/16"(391)
12 3/16"(310)



BBMVST5032

36 1/8"(918)
34 1/8"(867)
34"(864)
33 1/2"(851)
12 5/16"(313)
13 3/16"(335)

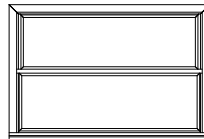

BBMVST5034

38 1/8"(968)
36 1/8"(918)
36"(914)
35 1/2"(902)
13 5/16"(338)
14 3/16"(360)

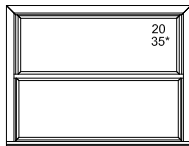

BBMVST4636

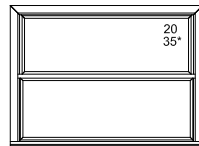

BBMVST4836

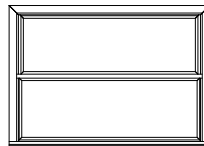

BBMVST5036

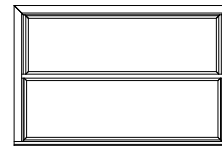

BBMVST5436

39 1/8"(994)
37 1/8"(943)
37"(940)
36 1/2"(927)
13 13/16"(351)
14 11/16"(373)

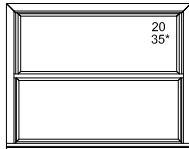

BBMVST4637

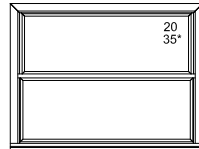

BBMVST4837



BBMVST5037

40 1/8"(1019)
38 1/8"(968)
38"(965)
37 1/2"(953)
14 5/16"(364)
15 3/16"(386)

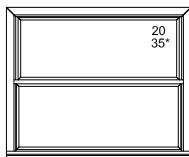

BBMVST4638



BBMVST5038

VINYL BRICKMOULD SINGLE HUNG ELEVATIONS

• Scale: 1/4" = 10"

UNIT SIZE
BRICKMOLD OPENING
ROUGH OPENING
FRAME SIZE
DAYLIGHT OPENING

48 1/8"(1222)
46 1/8"(1172)
46"(1168)
45 1/2"(1156)
39"(991)
39 13/16"(1011)

50 1/8"(1273)
48 1/8"(1222)
48"(1219)
47 1/2"(1207)
41"(1041)
41 13/16"(1062)

52 1/8"(1324)
50 1/8"(1273)
50"(1270)
49 1/2"(1257)
43"(1092)
43 13/16"(1113)

56 1/8"(1426)
54 1/8"(1375)
54"(1372)
53 1/2"(1359)
47"(1194)
47 13/16"(1214)

42 1/8"(1070)
40 1/8"(1019)
40"(1016)
38 1/2"(983)
18 5/16"(462)
18 3/16"(441)

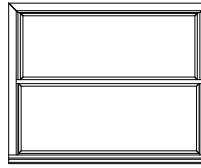

BBMVS5040

43 1/8"(1085)
41 1/8"(1045)
41"(1041)
40 1/2"(1030)
15 13/16"(422)
16 11/16"(424)

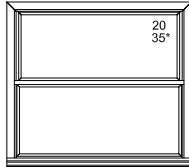

BBMVS4641

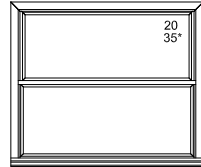

BBMVS4841

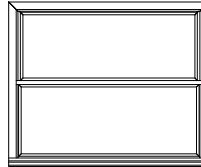

BBMVS5041

44 1/8"(1070)
42 1/8"(1070)
42"(1067)
41 1/2"(1054)
16 5/16"(432)
17 3/16"(437)

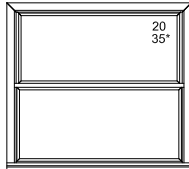

BBMVS4642

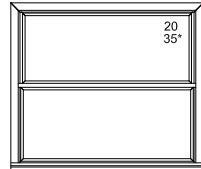

BBMVS4842

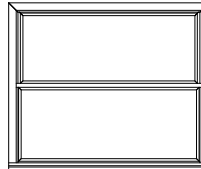

BBMVS5042

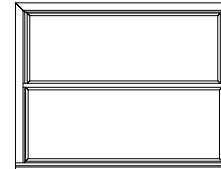

BBMVS5442

46 1/8"(1172)
44 1/8"(1121)
44"(1116)
43 1/2"(1104)
17 5/16"(446)
18 3/16"(457)

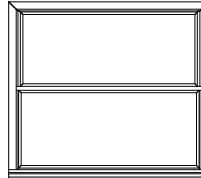

BBMVS5044

48 1/8"(1222)
46 1/8"(1172)
46"(1169)
45 1/2"(1156)
18 5/16"(462)
19 3/16"(487)

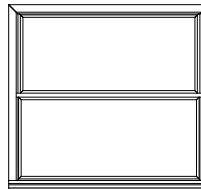

BBMVS5046

50 1/8"(1273)
48 1/8"(1222)
48"(1219)
47 1/2"(1207)
19 5/16"(513)
20 3/16"(513)

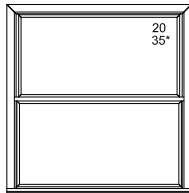

BBMVS4648

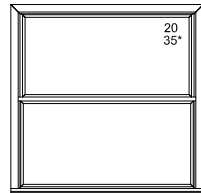

BBMVS4848

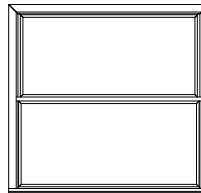

BBMVS5048

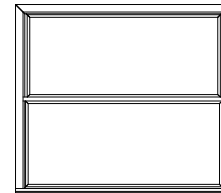

BBMVS5448

51 1/8"(1299)
49 1/8"(1246)
49"(1243)
48 1/2"(1232)
19 13/16"(528)
20 11/16"(528)

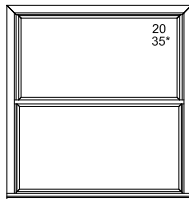

BBMVS4649

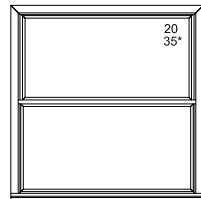

BBMVS4849

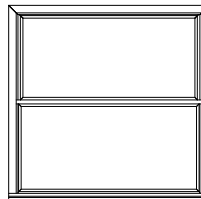

BBMVS5049

VINYL BRICKMOULD SINGLE HUNG ELEVATIONS

• Scale: 1/4" = 10"

UNIT SIZE 48 1/8"(1222)
BRICKMOLD OPENING 46 1/8"(1172)
ROUGH OPENING 46"(1168)
FRAME SIZE 45 1/2"(1156)
DAYLIGHT OPENING 39"(991)
21 3/16"(1011)

50 1/8"(1273)
48 1/8"(1222)
48"(1219)
47 1/2"(1207)
41"(1041)
41 13/16"(1062)

52 1/8"(1324)
50 1/8"(1273)
50"(1270)
49 1/2"(1257)
43"(1092)
43 13/16"(1113)

56 1/8"(1426)
54 1/8"(1375)
54"(1372)
53 1/2"(1359)
47"(1194)
47 13/16"(1214)

52 1/8"(1324)
50 1/8"(1273)
50"(1270)
49 1/2"(1257)
20 5/16"(516)
21 3/16"(538)

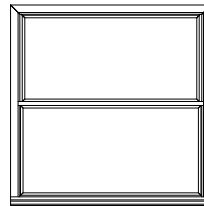

BBMST5050

54 1/8"(1375)
52 1/8"(1324)
52"(1321)
51 1/2"(1308)
21 5/16"(541)
22 3/16"(564)

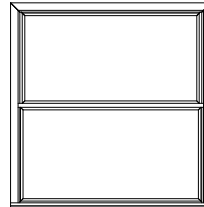

BBMST5052

55 1/8"(1400)
53 1/8"(1349)
53"(1346)
52 1/2"(1334)
21 13/16"(564)
22 11/16"(576)

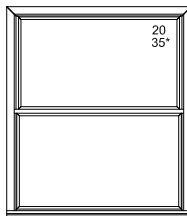

BBMST4653

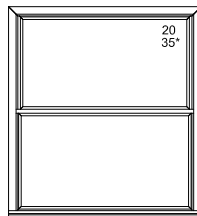

BBMST4853

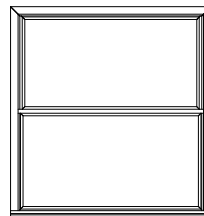

BBMST5053

56 1/8"(1426)
54 1/8"(1375)
54"(1372)
53 1/2"(1359)
22 5/16"(567)
23 3/16"(589)

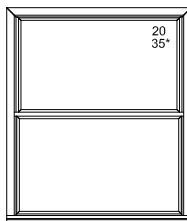

BBMST4654

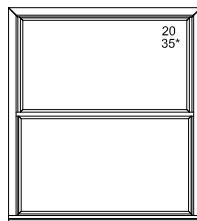

BBMST4854

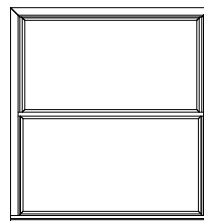

BBMST5054

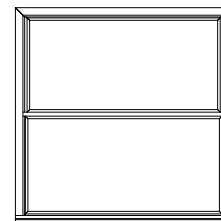

BBMST5454

58 1/8"(1476)
56 1/8"(1426)
56"(1422)
55 1/2"(1410)
23 5/16"(592)
24 3/16"(618)

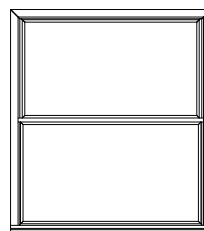

BBMST5056

59 1/8"(1502)
57 1/8"(689)
57"(1448)
56 1/2"(1435)
23 13/16"(605)
24 11/16"(627)

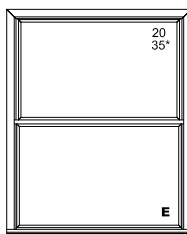

BBMST4657

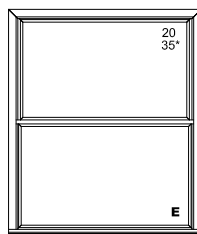

BBMST4857

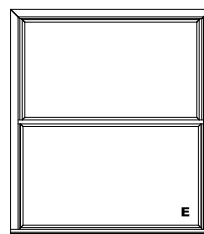

BBMST5057

VINYL BRICKMOULD SINGLE HUNG ELEVATIONS

• Scale: 1/4" = 1'0"

UNIT SIZE
BRICKMOLD OPENING
ROUGH OPENING
FRAME SIZE
DAYLIGHT OPENING

48 1/8"(1222)
46 1/8"(1172)
46"(1168)
45 1/2"(1156)
39"(991)
39 13/16"(1011)

50 1/8"(1273)
48 1/8"(1222)
48"(1219)
47 1/2"(1207)
41"(1041)
41 13/16"(1062)

52 1/8"(1324)
50 1/8"(1273)
50"(1270)
49 1/2"(1257)
43"(1092)
43 13/16"(1113)

56 1/8"(1426)
54 1/8"(1375)
54"(1372)
53 1/2"(1359)
47"(1194)
47 13/16"(1214)

60 1/8"(1527)
58 1/8"(1476)
58"(1473)
57 1/2"(1461)
24 5/16"(618)
25 3/16"(640)

62 1/8"(1578)
60 1/8"(1527)
60"(1524)
59 1/2"(1511)
25 5/16"(643)
26 3/16"(665)

64 1/8"(1629)
62 1/8"(1578)
62"(1575)
61 1/2"(1562)
26 5/16"(668)
27 3/16"(691)

66 1/8"(1680)
64 1/8"(1629)
64"(1626)
63 1/2"(1613)
27 5/16"(694)
28 3/16"(716)

67 1/8"(1705)
65 1/8"(1654)
65"(1651)
64 1/2"(1638)
27 13/16"(706)
28 11/16"(729)

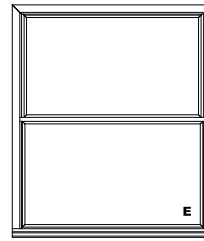

BBMST5058

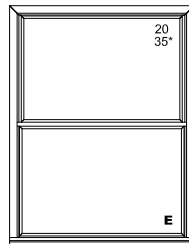

BBMST4660

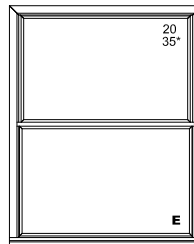

BBMST4860

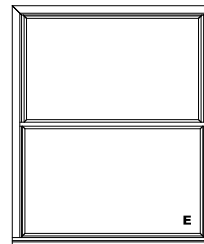

BBMST5060

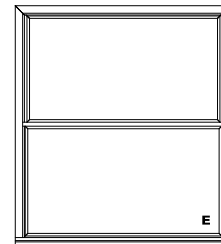

BBMST5460

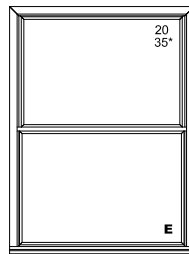

BBMST4662

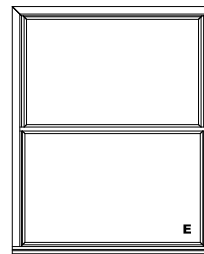

BBMST5062

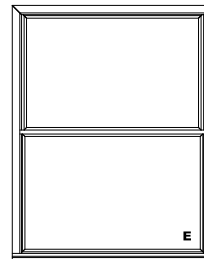

BBMST5064

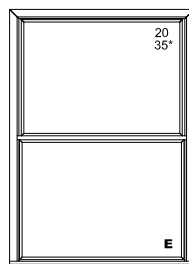

BBMST4665

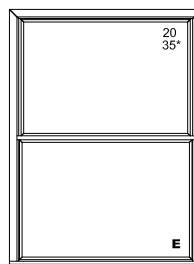

BBMST4865

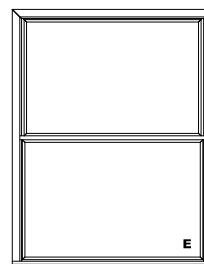

BBMST5065

VINYL BRICKMOULD SINGLE HUNG ELEVATIONS

• Scale: 1/4" = 10"

UNIT SIZE
BRICKMOLD OPENING
ROUGH OPENING
FRAME SIZE
DAYLIGHT OPENING

48 1/8"(1222)
46 1/8"(1172)
46"(1168)
45 1/2"(1156)
39"(991)
39 13/16"(1011)

50 1/8"(1273)
48 1/8"(1222)
48"(1219)
47 1/2"(1207)
41"(1041)
41 13/16"(1062)

52 1/8"(1324)
50 1/8"(1273)
50"(1270)
49 1/2"(1257)
43"(1092)
43 13/16"(1113)

56 1/8"(1426)
54 1/8"(1375)
54"(1372)
53 1/2"(1359)
47"(1194)
47 13/16"(1214)

68 1/8"(1730)
66 1/8"(1680)
65"(1676)
64 1/2"(1664)
59 3/16"(1441)

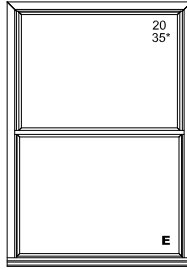

BBMST4666

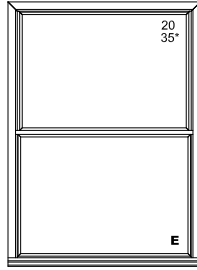

BBMST4866

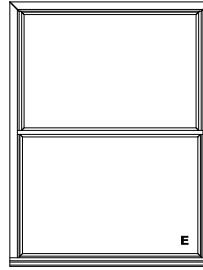

BBMST5066

70 1/8"(1781)
68 1/8"(1730)
65"(1727)
64 1/2"(1715)
59 3/16"(1441)
59 3/16"(1441)

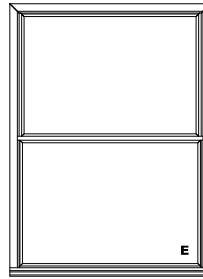

BBMST5068

71 1/8"(1807)
68 1/8"(1756)
65"(1753)
64 1/2"(1741)
59 3/16"(1441)
59 3/16"(1441)

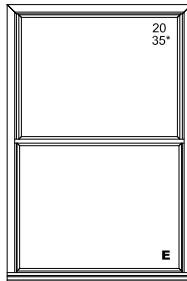

BBMST4669

72 1/8"(1832)
70 1/8"(1781)
70"(1778)
68 1/2"(1765)
59 3/16"(1441)
59 3/16"(1441)

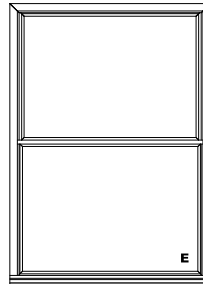

BBMST5070

74 1/8"(1883)
72 1/8"(1832)
72"(1829)
71 1/2"(1816)
59 3/16"(1441)
59 3/16"(1441)

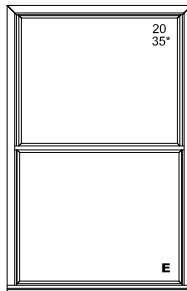

BBMST4672

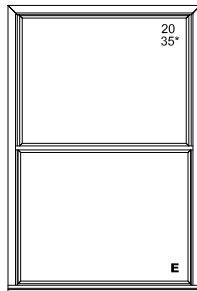

BBMST4872

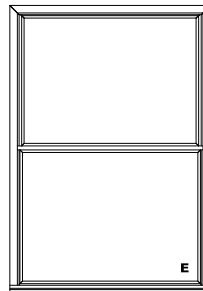

BBMST5072

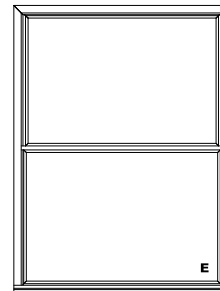

BBMST5472

VINYL BRICKMOULD SINGLE HUNG ELEVATIONS

• Scale: 1/4" = 10"

UNIT SIZE
BRICKMOLD OPENING
ROUGH OPENING
FRAME SIZE
DAYLIGHT OPENING

48 1/8"(1222)
46 1/8"(1172)
46"(1168)
45 1/2"(1156)
39"(991)
39 13/16"(1011)

50 1/8"(1273)
48 1/8"(1222)
48"(1219)
47 1/2"(1207)
41"(1041)
41 13/16"(1062)

52 1/8"(1324)
50 1/8"(1273)
50"(1270)
49 1/2"(1257)
43"(1092)
43 13/16"(1113)

56 1/8"(1426)
54 1/8"(1375)
54"(1372)
53 1/2"(1359)
47"(1194)
47 13/16"(1214)

76 1/8"(1934)
74 1/8"(1883)
74"(1880)
73 1/2"(1867)
32 5/16"(821)
31 3/16"(792)

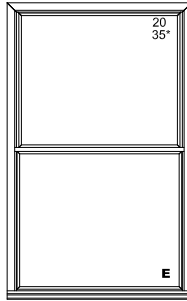

BBMVST4674

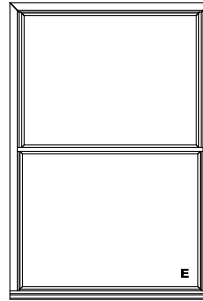

BBMVST5074

78 1/8"(1984)
76 1/8"(1934)
76"(1930)
75 1/2"(1918)
33 5/16"(846)
34 3/16"(868)

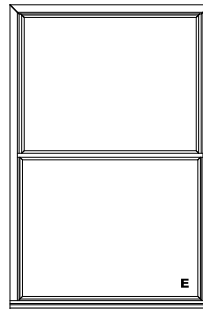

BBMVST5076

79 1/8"(2010)
77 1/8"(1959)
77"(1956)
76 1/2"(1943)
33 13/16"(859)
34 11/16"(881)

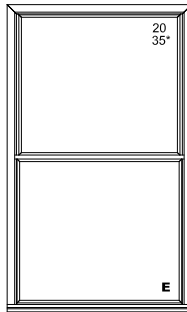

BBMVST4677

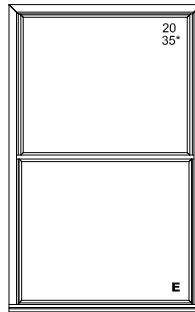

BBMVST4877

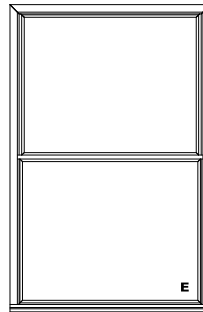

BBMVST5077

80 1/8"(2035)
78 1/8"(1984)
78"(1981)
77 1/2"(1969)
34 5/16"(872)
35 3/16"(894)

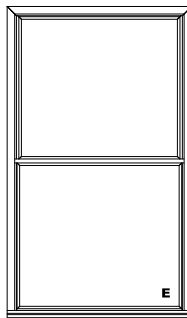

BBMVST4678

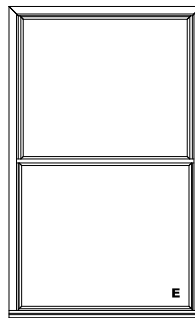

BBMVST4878

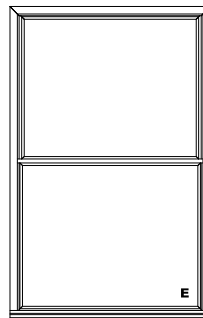

BBMVST5078

VINYL BRICKMOULD SINGLE HUNG ELEVATIONS

• Scale: 1/4" = 10"

UNIT SIZE 48 1/8"(1222)
BRICKMOLD OPENING 46 1/8"(1172)
ROUGH OPENING 46"(1168)
FRAME SIZE 45 1/2"(1156)
DAYLIGHT OPENING 39"(991)
39 13/16"(1011)

50 1/8"(1273)
48 1/8"(1222)
48"(1219)
47 1/2"(1207)
41"(1041)
41 13/16"(1062)

52 1/8"(1324)
50 1/8"(1273)
50"(1270)
49 1/2"(1257)
43"(1092)
43 13/16"(1113)

56 1/8"(1426)
54 1/8"(1375)
54"(1372)
53 1/2"(1359)
47"(1194)
47 13/16"(1214)

82 1/8"(2066)
80 1/8"(2035)
80"(2032)
79 1/2"(2019)
39 1/2"(991)
38 3/16"(979)

84 1/8"(2137)
82 1/8"(2086)
82"(2083)
81 1/2"(2070)
38 1/2"(982)
37 3/16"(945)

86 1/8"(2188)
84 1/8"(2137)
84"(2134)
83 1/2"(2121)
38 1/2"(982)
38 3/16"(970)

88 1/8"(2238)
86 1/8"(2188)
86"(2184)
85 1/2"(2172)
39 1/2"(991)
38 3/16"(985)

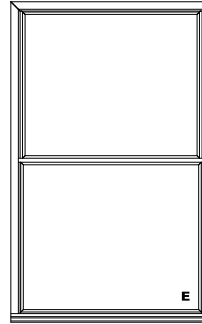

BBMST5080

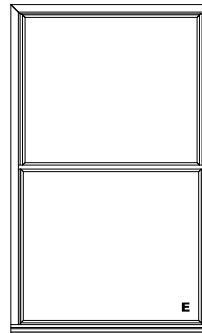

BBMST5082

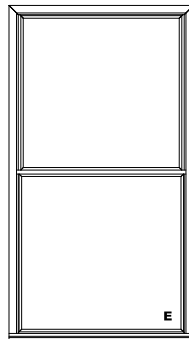

BBMST4684

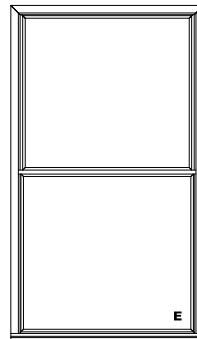

BBMST4884

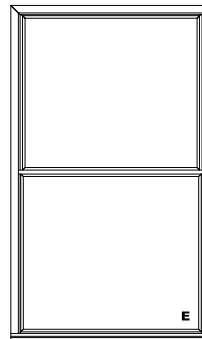

BBMST5084

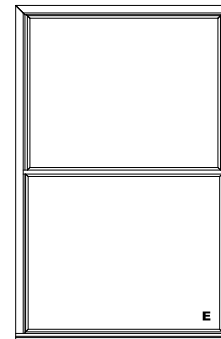

BBMST5484

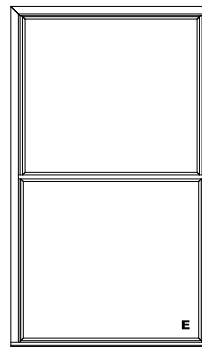

BBMST5086

VINYL BRICKMOULD SINGLE HUNG ELEVATIONS

• Scale: 1/4" = 10"

UNIT SIZE
BRICKMOLD OPENING
ROUGH OPENING
FRAME SIZE
DAYLIGHT OPENING

48 1/8"(1222)
46 1/8"(1172)
46"(1168)
45 1/2"(1156)
39"(991)
39 13/16"(1011)

50 1/8"(1273)
48 1/8"(1222)
48"(1219)
47 1/2"(1207)
41"(1041)
41 13/16"(1062)

52 1/8"(1324)
50 1/8"(1273)
50"(1270)
49 1/2"(1257)
43"(1092)
43 13/16"(1113)

56 1/8"(1426)
54 1/8"(1375)
54"(1372)
53 1/2"(1359)
47"(1194)
47 13/16"(1214)

90 1/8"(2289)
88 1/8"(2238)
88"(2235)
87 1/2"(2223)
39 5/16"(999)
40 3/16"(1021)

92 1/8"(2340)
90 1/8"(2289)
90"(2286)
89 1/2"(2273)
40 5/16"(1024)
41 3/16"(1046)

94 1/8"(2391)
92 1/8"(2340)
92"(2337)
91 1/2"(2324)
41 5/16"(1049)
42 3/16"(1072)

96 1/8"(2442)
94 1/8"(2391)
94"(2388)
93 1/2"(2375)
42 5/16"(1075)
43 3/16"(1097)

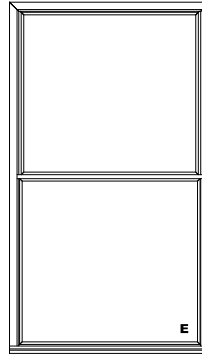

BBMVST5088

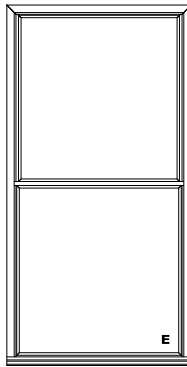

BBMVST4690

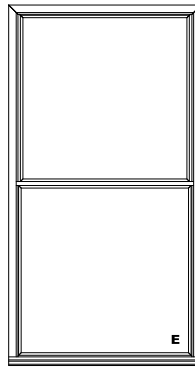

BBMVST4890

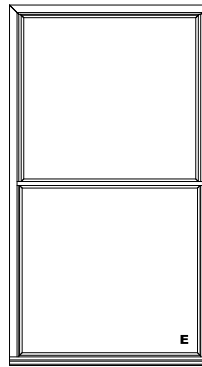

BBMVST5090

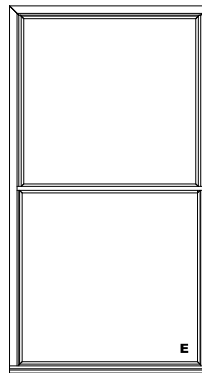

BBMVST5092

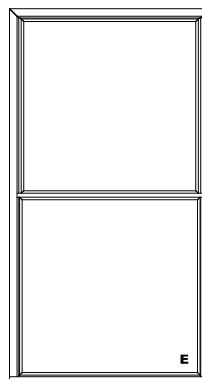

BBMVST5094

VINYL BRICKMOULD SINGLE HUNG ELEVATIONS

• Scale: 1/4" = 10"

UNIT SIZE
BRICKMOLD OPENING
ROUGH OPENING
FRAME SIZE
DAYLIGHT OPENING

48 1/8"(1222)
46 1/8"(1172)
46"(1168)
45 1/2"(1156)
39"(991)
39 13/16"(1011)

50 1/8"(1273)
48 1/8"(1222)
48"(1219)
47 1/2"(1207)
41"(1041)
41 13/16"(1062)

52 1/8"(1324)
50 1/8"(1273)
50"(1270)
49 1/2"(1257)
43"(1092)
43 13/16"(1113)

56 1/8"(1426)
54 1/8"(1375)
54"(1372)
53 1/2"(1359)
47"(1194)
47 13/16"(1214)

96 1/8"(2492)
96 1/8"(2442)
96"(2438)
95 1/2"(2426)
43 5/16"(1100)
44 3/16"(1122)

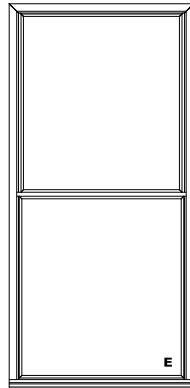

BBMVST4696

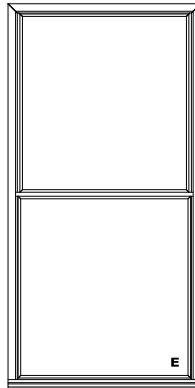

BBMVST4896

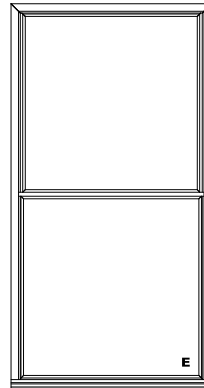

BBMVST5096

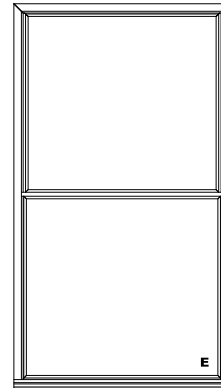

BBMVST5496

100 1/8"(2543)
98 1/8"(2492)
98"(2489)
97 1/2"(2477)
44 5/16"(1126)
45 3/16"(1148)

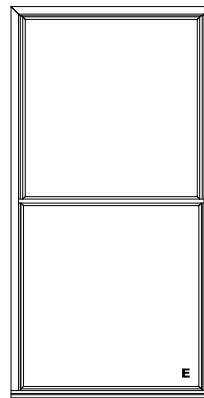

BBMVST5098

2-WIDE SINGLE-HUNG TILT

UNIT SIZE	38 1/8" (968)	42 1/8" (1070)	46 1/8" (1172)	50 1/8" (1273)	54 1/8" (1375)	58 1/8" (1476)	62 1/8" (1578)	66 1/8" (1680)
ROUGH OPENING	36" (914)	40" (1016)	44" (1118)	48" (1219)	52" (1321)	56" (1422)	60" (1524)	64" (1626)
FRAME SIZE	35 1/2" (902)	39 1/2" (1003)	43 1/2" (1105)	47 1/2" (1207)	51 1/2" (1308)	55 1/2" (1410)	59 1/2" (1511)	63 1/2" (1613)
DAYLIGHT OPENING	12 3/4" (324)[2] 11 7/16" (291)[2]	14 3/4" (375)[2] 13 7/16" (341)[2]	16 3/4" (425)[2] 15 7/16" (392)[2]	18 3/4" (476)[2] 17 7/16" (443)[2]	20 3/4" (527)[2] 19 7/16" (494)[2]	22 3/4" (578)[2] 21 7/16" (545)[2]	24 3/4" (629)[2] 23 7/16" (595)[2]	26 3/4" (679)[2] 25 7/16" (646)[2]
32 1/8" (816) 30" (762) 29 1/2" (749) 11 7/16" (291) 10 1/4" (260)								
38 1/8" (968) 35" (914) 35 1/2" (902) 14 7/16" (367) 13 1/4" (337)								
39 1/8" (994) 37" (940) 36 1/2" (927) 14 7/16" (379) 13 1/4" (349)								
40 1/8" (1019) 38" (965) 37 1/2" (953) 15 7/16" (392) 14 1/4" (362)								
43 1/8" (1095) 41" (1041) 40 1/2" (1029) 16 7/16" (430) 15 1/4" (400)								
44 1/8" (1121) 42" (1067) 41 1/2" (1054) 17 7/16" (443) 16 1/4" (413)								
50 1/8" (1273) 48" (1219) 47 1/2" (1207) 20 7/16" (519) 19 1/4" (489)								
51 1/8" (1299) 49" (1245) 48 1/2" (1232) 20 15/16" (532) 19 3/4" (502)								
55 1/8" (1400) 53" (1346) 52 1/2" (1334) 22 7/16" (583) 21 1/4" (552)								
56 1/8" (1426) 54" (1372) 53 1/2" (1359) 23 7/16" (595) 22 1/4" (565)								
59 1/8" (1502) 57" (1448) 56 1/2" (1435) 24 7/16" (633) 23 1/4" (603)								

ELEVATION SYMBOL LEGEND:
VALUES IN () ARE IN MILLIMETER CONVERSIONS
VALUES IN [] ARE NUMBER OF DAYLIGHT OPENINGS PER UNIT

Note: Elevations shown DO NOT have exterior trim. Subtract 1/2" (12.7) from M.O. (Masonry Opening) for Unit Sizes. Masonry Openings above include Sill Nose, see Trim Options page for Sill Nose specifications. For other Trim Options refer to the Unit Sizing, Rough Opening & Masonry Openings page.

SCALE: 1/8" = 1'

2-WIDE SINGLE-HUNG TILT

UNIT SIZE ROUGH OPENING FRAME SIZE DAYLIGHT OPENING	38 1/8" (968) 36" (914) 35 1/2" (902) 12 3/4" (324) 2 11 7/16" (291) 2	42 1/8" (1070) 40" (1016) 39 1/2" (1003) 14 3/4" (375) 2 13 7/16" (341) 2	46 1/8" (1172) 44" (1118) 43 1/2" (1105) 16 3/4" (425) 2 15 7/16" (392) 2	50 1/8" (1273) 48" (1219) 47 1/2" (1207) 18 3/4" (476) 2 17 7/16" (443) 2	54 1/8" (1375) 52" (1321) 51 1/2" (1308) 20 3/4" (527) 2 19 7/16" (494) 2	58 1/8" (1476) 56" (1422) 55 1/2" (1410) 22 3/4" (578) 2 21 7/16" (545) 2	62 1/8" (1578) 60" (1524) 59 1/2" (1511) 24 3/4" (629) 2 23 7/16" (595) 2	66 1/8" (1680) 64" (1626) 63 1/2" (1613) 26 3/4" (679) 2 25 7/16" (646) 2
62 1/8" (1578) 60" (1524) 59 1/2" (1511) 26 7/16" (672) 25 1/4" (641)								
64 1/8" (1629) 62" (1575) 61 1/2" (1562) 27 7/16" (697) 26 1/4" (667)								
67 1/8" (1705) 65" (1651) 64 1/2" (1638) 28 15/16" (735) 27 3/4" (705)								
68 1/8" (1730) 66" (1676) 65 1/2" (1664) 29 7/16" (748) 28 1/4" (718)								
71 1/8" (1807) 69" (1753) 68 1/2" (1740) 30 15/16" (786) 29 3/4" (756)								
74 1/8" (1883) 72" (1829) 71 1/2" (1861) 32 7/16" (824) 31 1/4" (794)								
76 1/8" (1934) 74" (1880) 73 1/2" (1867) 33 7/16" (849) 32 1/4" (819)								
79 1/8" (2010) 77" (1956) 76 1/2" (1943) 34 15/16" (887) 33 3/4" (857)								

























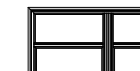





































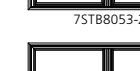

ELEVATION SYMBOL LEGEND:
 VALUES IN () ARE IN MILLIMETER CONVERSIONS
 VALUES IN [] ARE NUMBER OF DAYLIGHT OPENINGS PER UNIT

E BASIC UNIT CLEAR OPENING EXCEEDS 20" IN WIDTH, 24" IN HEIGHT & A MINIMUM OF 5.7 SQ. FT.

Note: Elevations shown DO NOT have exterior trim. Subtract 1/2" (12.7) from M.O. (Masonry Opening) for Unit Sizes. Masonry Openings above include Sill Nose, see Trim Options page for Sill Nose specifications. For other Trim Options refer to the Unit Sizing, Rough Opening & Masonry Openings page.

SCALE: 1/8" = 1'

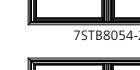
2-WIDE SINGLE-HUNG TILT

UNIT SIZE ROUGH OPENING FRAME SIZE DAYLIGHT OPENING	70 1/8" (xxxx) 68" (1727) 67 1/2" (1715) 28 3/4" (730)[2] 27 7/16" (697)[2]	74 1/8" (1883) 72" (1829) 71 1/2" (1861) 30 3/4" (781)[2] 29 7/16" (748)[2]	78 1/8" (1984) 76" (1930) 75 1/2" (1918) 32 3/4" (832)[2] 31 7/16" (799)[2]	82 1/8" (2088) 80" (2032) 79 1/2" (2019) 34 3/4" (883)[2] 33 7/16" (849)[2]	86 1/8" (2188) 84" (2134) 83 1/2" (2121) 36 3/4" (933)[2] 35 7/16" (900)[2]	94 1/8" (2391) 92" (2337) 91 1/2" (2324) 40 3/4" (1035)[2] 39 7/16" (1002)[2]
32 1/8" (816) 30 1/2" (778) 29 1/2" (754) 11 7/16" (293) 10 1/4" (260)	 7STB6830-2	 7STB7230-2	 7STB7630-2	 7STB8030-2	 7STB8430-2	 7STB9230-2
38 1/8" (968) 36 1/4" (925) 35 1/2" (902) 14 7/16" (367) 13 1/4" (337)	 7STB6836-2	 7STB7236-2	 7STB7636-2	 7STB8036-2	 7STB8436-2	 7STB9236-2
39 1/8" (994) 37 1/4" (941) 36 1/2" (918) 14 7/16" (379) 13 1/4" (349)	 7STB6837-2	 7STB7237-2	 7STB7637-2	 7STB8037-2	 7STB8437-2	 7STB9237-2
40 1/8" (1019) 38 1/4" (966) 37 1/2" (943) 15 7/16" (392) 14 1/4" (362)	 7STB6838-2	 7STB7238-2	 7STB7638-2	 7STB8038-2	 7STB8438-2	 7STB9238-2
43 1/8" (1095) 41 1/4" (1042) 40 1/2" (1019) 16 7/16" (430) 15 1/4" (400)	 7STB6841-2	 7STB7241-2	 7STB7641-2	 7STB8041-2	 7STB8441-2	 7STB9241-2
44 1/8" (1121) 42 1/4" (1068) 41 1/2" (1045) 17 7/16" (443) 16 1/4" (413)	 7STB6842-2	 7STB7242-2	 7STB7642-2	 7STB8042-2	 7STB8442-2	 7STB9042-2
50 1/8" (1273) 48 1/4" (1220) 47 1/2" (1197) 20 7/16" (519) 19 1/4" (489)	 7STB6848-2	 7STB7248-2	 7STB7648-2	 7STB8048-2	 7STB8448-2	 7STB9248-2
51 1/8" (1299) 49 1/4" (1246) 48 1/2" (1223) 20 15/16" (532) 19 3/4" (502)	 7STB6849-2	 7STB7249-2	 7STB7649-2	 7STB8049-2	 7STB8449-2	 7STB9249-2
55 1/8" (1400) 53 1/4" (1347) 52 1/2" (1324) 22 7/16" (583) 21 1/4" (552)	 7STB6853-2	 7STB7253-2	 7STB7653-2	 7STB8053-2	 7STB8453-2	 7STB9253-2
56 1/8" (1426) 54 1/4" (1373) 53 1/2" (1350) 23 7/16" (595) 22 1/4" (565)	 7STB6854-2	 7STB7254-2	 7STB7654-2	 7STB8054-2	 7STB8454-2	 7STB9254-2
59 1/8" (1502) 57 1/4" (1449) 56 1/2" (1426) 24 7/16" (633) 23 1/4" (603)	 7STB6857-2	 7STB7257-2	 7STB7657-2	 7STB8057-2	 7STB8457-2	 7STB9257-2

ELEVATION SYMBOL LEGEND:
VALUES IN () ARE IN MILLIMETER CONVERSIONS
VALUES IN [] ARE NUMBER OF DAYLIGHT OPENINGS PER UNIT

E BASIC UNIT CLEAR OPENING EXCEEDS 20" IN WIDTH, 24" IN HEIGHT & A MINIMUM OF 5.7 SQ. FT.

Note: Elevations shown DO NOT have exterior trim. Subtract 1/2" (12.7) from M.O. (Masonry Opening) for Unit Sizes. Masonry Openings above include Sill Nose, see Trim Options page for Sill Nose specifications. For other Trim Options refer to the Unit Sizing, Rough Opening & Masonry Openings page.

SCALE: 1/8" = 1'

2-WIDE SINGLE-HUNG TILT

UNIT SIZE
ROUGH OPENING
FRAME SIZE
DAYLIGHT OPENING

70 1/8" (xxxx)
68" (1727)
67 1/2" (1715)
28 3/4" (730)[2]
27 7/16" (697)[2]

74 1/8" (1883)
72" (1829)
71 1/2" (1861)
30 3/4" (781)[2]
29 7/16" (748)[2]

78 1/8" (1984)
76" (1930)
75 1/2" (1918)
32 3/4" (832)[2]
31 7/16" (799)[2]

82 1/8" (2088)
80" (2032)
79 1/2" (2019)
34 3/4" (883)[2]
33 7/16" (849)[2]

86 1/8" (2188)
84" (2134)
83 1/2" (2121)
36 3/4" (933)[2]
35 7/16" (900)[2]

94 1/8" (2391)
92" (2337)
91 1/2" (2324)
40 3/4" (1035)[2]
39 7/16" (1002)[2]

62 1/8" (1578)
60" (1524)
59 7/16" (1511)
26 7/16" (672)
25 1/4" (641)

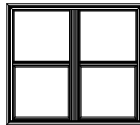

75TB6860-2



75TB7260-2

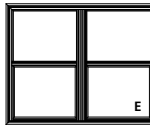

75TB7660-2

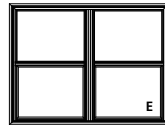

75TB8060-2

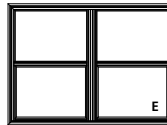

75TB8460-2

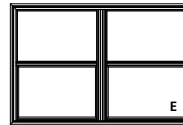

75TB9260-2

64 1/8" (1629)
62" (1575)
61 7/16" (1562)
27 7/16" (697)
26 1/4" (667)

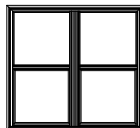

75TB6862-2



75TB7262-2



75TB7662-2



75TB8062-2



75TB8462-2



75TB9262-2

67 1/8" (1705)
65" (1651)
64 15/16" (1638)
28 15/16" (735)
27 3/4" (705)

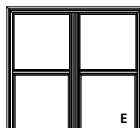

75TB6865-2

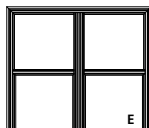

75TB7265-2



75TB7665-2

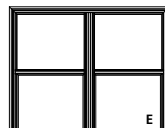

75TB8065-2

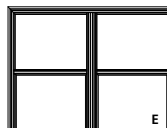

75TB8465-2

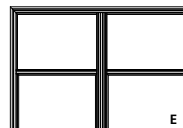

75TB9265-2

68 1/8" (1730)
66" (1676)
65 11/16" (1663)
29 7/16" (748)
28 1/4" (718)

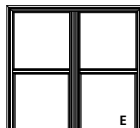

75TB6866-2



75TB7266-2



75TB7666-2

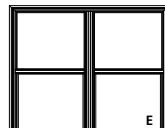

75TB8066-2

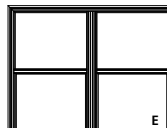

75TB8466-2

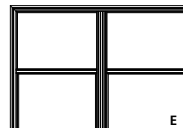

75TB9266-2

71 1/8" (1807)
69" (1753)
68 11/16" (1740)
30 15/16" (786)
29 3/4" (756)



75TB6869-2



75TB7269-2



75TB7669-2



75TB8069-2

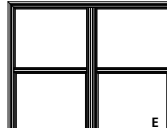

75TB8469-2

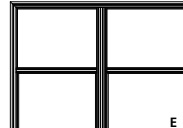

75TB9269-2

74 1/8" (1883)
72" (1829)
71 7/16" (1816)
32 7/16" (824)
31 1/4" (794)

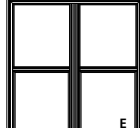

75TB6872-2



75TB7272-2

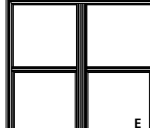

75TB7672-2



75TB8072-2

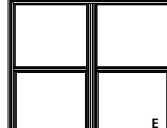

75TB8472-2



75TB9272-2

76 1/8" (1934)
74" (1880)
73 11/16" (1867)
33 7/16" (849)
32 1/4" (819)

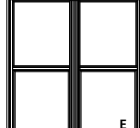

75TB6874-2



75TB7274-2



75TB7674-2



75TB8074-2



75TB8474-2



75TB9274-2

79 1/8" (2010)
77" (1956)
76 11/16" (1943)
34 15/16" (887)
33 3/4" (857)



75TB6877-2



75TB7277-2



75TB7677-2

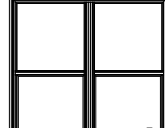

75TB8077-2

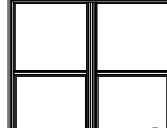

75TB8477-2

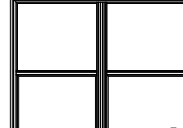

75TB9277-2

ELEVATION SYMBOL LEGEND:
VALUES IN () ARE IN MILLIMETER CONVERSIONS
VALUES IN [] ARE NUMBER OF DAYLIGHT OPENINGS PER UNIT

E BASIC UNIT CLEAR OPENING EXCEEDS 20" IN WIDTH, 24" IN HEIGHT & A MINIMUM OF 5.7 SQ. FT.

Note: Elevations shown DO NOT have exterior trim. Subtract 1/2" (12.7) from M.O. (Masonry Opening) for Unit Sizes. Masonry Openings above include Sill Nose, see Trim Options page for Sill Nose specifications. For other Trim Options refer to the Unit Sizing, Rough Opening & Masonry Openings page.

SCALE: 1/8" = 1'

2-WIDE SINGLE-HUNG TILT

UNIT SIZE
ROUGH OPENING
FRAME SIZE
DAYLIGHT OPENING

98 1/8" (2492)
96" (2438)
95 1/2" (2426)
42 3/4" (1086)(2)
41 7/16" (1053)(2)

32 1/8" (816)
30 7/8" (779)
29 1/2" (753)
11 7/16" (291)
10 1/4" (260)



7STB9630-2

38 1/8" (968)
36 9/16" (914)
35 1/2" (902)
14 7/16" (367)
13 1/4" (337)



7STB9636-2

39 1/8" (994)
37 9/16" (940)
36 1/2" (927)
14 7/16" (379)
13 1/4" (349)



7STB9637-2

40 1/8" (1019)
38 5/8" (965)
37 1/2" (953)
15 7/16" (392)
14 1/4" (362)



7STB9638-2

43 1/8" (1095)
41 1/4" (1039)
40 1/2" (1029)
16 7/16" (430)
15 1/4" (400)



7STB9641-2

44 1/8" (1121)
42 7/8" (1065)
41 1/2" (1054)
17 7/16" (443)
16 1/4" (413)



7STB9642-2

50 1/8" (1273)
48 1/4" (1217)
47 1/2" (1207)
20 7/16" (519)
19 1/4" (489)



7STB9648-2

51 1/8" (1299)
49 1/4" (1243)
48 1/2" (1232)
20 15/16" (532)
19 3/4" (502)



7STB9649-2

55 1/8" (1400)
53 1/4" (1344)
52 1/2" (1334)
22 7/16" (583)
21 1/4" (552)



7STB9653-2

56 1/8" (1426)
54 1/4" (1370)
53 1/2" (1359)
23 7/16" (595)
22 1/4" (565)



7STB9654-2

59 1/8" (1502)
57 1/4" (1446)
56 1/2" (1435)
24 7/16" (633)
23 1/4" (603)



7STB9657-2

UNIT SIZE
ROUGH OPENING
FRAME SIZE
DAYLIGHT OPENING

98 1/8" (2492)
96" (2438)
95 1/2" (2426)
42 3/4" (1086)(2)
41 7/16" (1053)(2)

62 1/8" (1578)
60" (1524)
59 1/2" (1511)
26 7/16" (672)
25 1/4" (641)

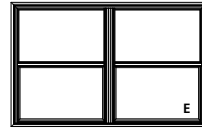

7STB9660-2

64 1/8" (1629)
62" (1575)
61 1/2" (1562)
27 7/16" (697)
26 1/4" (667)



7STB9662-2

67 1/8" (1705)
65" (1651)
64 1/2" (1638)
28 15/16" (735)
27 3/4" (705)

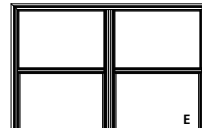

7STB9665-2

68 1/8" (1730)
66" (1676)
65 1/2" (1664)
29 7/16" (748)
28 1/4" (718)



7STB9666-2

71 1/8" (1807)
69" (1753)
68 1/2" (1740)
30 15/16" (786)
29 3/4" (756)

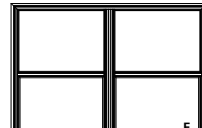

7STB9669-2

74 1/8" (1883)
72" (1829)
71 1/2" (1816)
32 7/16" (824)
31 1/4" (794)



7STB9672-2

76 1/8" (1934)
74" (1880)
73 1/2" (1867)
33 7/16" (849)
32 1/4" (819)



7STB9674-2

79 1/8" (2010)
77" (1956)
76 1/2" (1943)
34 15/16" (887)
33 3/4" (857)



7STB9677-2

ELEVATION SYMBOL LEGEND:
VALUES IN () ARE IN MILLIMETER CONVERSIONS
VALUES IN [] ARE NUMBER OF DAYLIGHT OPENINGS PER UNIT

E BASIC UNIT CLEAR OPENING EXCEEDS 20" IN WIDTH, 24" IN HEIGHT & A MINIMUM OF 5.7 SQ. FT.

Note: Elevations shown DO NOT have exterior trim. Subtract 1/2" (12.7) from M.O. (Masonry Opening) for Unit Sizes. Masonry Openings above include Sill Nose, see Trim Options page for Sill Nose specifications. For other Trim Options refer to the Unit Sizing, Rough Opening & Masonry Openings page.

SCALE: 1/8" = 1'

3-WIDE SINGLE-HUNG TILT WITH CENTER PICTURE WITH 24" FLANKER

UNIT SIZE ROUGH OPENING FRAME SIZE DAYLIGHT OPENING	86 1/8" (2188) 84" (2134) 83 1/2" (xxxx) 30 3/4" (781) 18 3/4" (476) [2] 17 7/16" (443) [2]	98 1/8" (2492) 96" (2438) 95 1/2" (xxxx) 42 3/4" (1086) 18 3/4" (476) [2] 17 7/16" (443) [2]	110 1/8" (2797) 108" (2743) 107 1/2" (xxxx) 54 3/4" (1391) 18 3/4" (476) [2] 17 7/16" (443) [2]	122 1/8" (3102) 120" (3048) 119 1/2" (3035) 66 3/4" (1695) 18 3/4" (476) [2] 17 7/16" (443) [2]
32 1/8" (816) 30" (762) 29 1/2" (749) 30 3/4" (781) 11 7/16" (291) 10 1/4" (260)				
38 1/8" (968) 36" (914) 35 1/2" (902) 30 3/4" (781) 14 7/16" (367) 13 1/4" (337)				
44 1/8" (1121) 42" (1067) 41 1/2" (1054) 36 3/4" (933) 17 7/16" (443) 16 1/4" (413)				
50 1/8" (1273) 48" (1219) 47 1/2" (1207) 42 3/4" (1086) 20 7/16" (519) 19 1/4" (489)				
56 1/8" (1426) 54" (1372) 53 1/2" (1359) 48 3/4" (1238) 23 7/16" (595) 22 1/4" (565)				
62 1/8" (1578) 60" (1524) 59 1/2" (1511) 54 3/4" (1391) 26 7/16" (672) 25 1/4" (641)				
68 1/8" (1730) 66" (1676) 65 1/2" (1664) 60 3/4" (1543) 29 7/16" (748) 28 1/4" (718)				
74 1/8" (1883) 72" (1829) 71 1/2" (1861) 66 3/4" (1695) 32 7/16" (824) 31 1/4" (794)				

ELEVATION SYMBOL LEGEND:
VALUES IN () ARE IN MILLIMETER CONVERSIONS
VALUES IN [] ARE NUMBER OF DAYLIGHT OPENINGS PER UNIT

Note: Elevations shown DO NOT have exterior trim. Subtract 1/2" (12.7) from M.O. (Masonry Opening) for Unit Sizes. Masonry Openings above include Sill Nose, see Trim Options page for Sill Nose specifications. For other Trim Options refer to the Unit Sizing, Rough Opening & Masonry Openings page.

SCALE: 1/8" = 1'

3-WIDE SINGLE-HUNG TILT WITH CENTER PICTURE WITH 24" FLANKER

UNIT SIZE	146 1/8" (3712)
ROUGH OPENING	144" (3658)
FRAME SIZE	143 1/2" (3645)
DAYLIGHT OPENING	90 3/4" (2305)
	18 3/4" (476)[2]
	17 7/16" (443)[2]

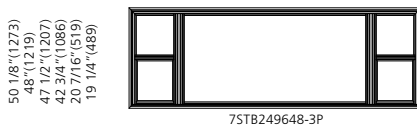
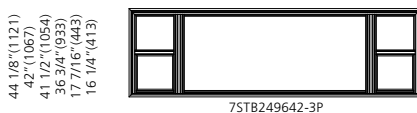
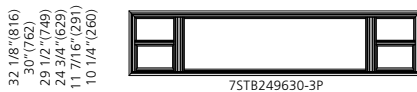

ELEVATION SYMBOL LEGEND:
VALUES IN () ARE IN MILLIMETER CONVERSIONS
VALUES IN [] ARE NUMBER OF DAYLIGHT OPENINGS PER UNIT

Note: Elevations shown DO NOT have exterior trim. Subtract 1/2" (12.7) from M.O. (Masonry Opening) for Unit Sizes. Masonry Openings above include Sill Nose, see Trim Options page for Sill Nose specifications. For other Trim Options refer to the Unit Sizing, Rough Opening & Masonry Openings page.

SCALE: 1/8" = 1'

3-WIDE SINGLE-HUNG TILT WITH CENTER PICTURE WITH 30" FLANKER

UNIT SIZE
ROUGH OPENING
FRAME SIZE
DAYLIGHT OPENING

98 1/8" (2492)
96" (2438)
95 1/2" (xxxx)
30 3/4" (781)
24 3/4" (629)[2]
23 7/16" (595)[2]

110 1/8" (2797)
108" (2743)
107 1/2" (xxxx)
42 3/4" (1086)
24 3/4" (629)[2]
23 7/16" (595)[2]

122 1/8" (3102)
120" (3048)
119 1/2" (3035)
54 3/4" (1391)
24 3/4" (629)[2]
23 7/16" (595)[2]

134 1/8" (3407)
132" (3353)
131 1/2" (3340)
66 3/4" (1695)
24 3/4" (629)[2]
23 7/16" (595)[2]

32 1/8" (816)
30" (762)
29 1/2" (749)
24 3/4" (629)
11 7/16" (291)
10 1/4" (260)

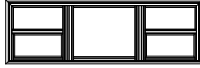

75TB303630-3P



75TB304830-3P



75TB306030-3P



75TB307230-3P

38 1/8" (968)
36" (914)
35 1/2" (902)
30 3/4" (781)
14 7/16" (367)
13 1/4" (337)



75TB303636-3P



75TB304836-3P



75TB306036-3P



75TB307236-3P

44 1/8" (1121)
42" (1067)
41 1/2" (1054)
36 3/4" (933)
17 7/16" (443)
16 1/4" (413)



75TB303642-3P



75TB304842-3P



75TB306042-3P



75TB307242-3P

50 1/8" (1273)
48" (1219)
47 1/2" (1207)
42 3/4" (1086)
20 7/16" (519)
19 1/4" (489)



75TB303648-3P



75TB304848-3P



75TB306048-3P



75TB307248-3P

56 1/8" (1426)
54" (1372)
53 1/2" (1359)
48 3/4" (1238)
23 7/16" (595)
22 1/4" (565)



75TB303654-3P



75TB304854-3P



75TB306054-3P

62 1/8" (1578)
60" (1524)
59 1/2" (1511)
54 3/4" (1391)
26 7/16" (672)
25 1/4" (641)



75TB303660-3P



75TB304860-3P

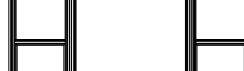

75TB306060-3P

68 1/8" (1730)
66" (1676)
65 1/2" (1664)
60 3/4" (1543)
29 7/16" (748)
28 1/4" (718)



75TB303666-3P



75TB304866-3P

74 1/8" (1883)
72" (1829)
71 1/2" (1861)
66 3/4" (1695)
32 7/16" (824)
31 1/4" (794)



75TB303672-3P

E

ELEVATION SYMBOL LEGEND:
VALUES IN () ARE IN MILLIMETER CONVERSIONS
VALUES IN [] ARE NUMBER OF DAYLIGHT OPENINGS PER UNIT

Note: Elevations shown DO NOT have exterior trim. Subtract 1/2" (12.7) from M.O. (Masonry Opening) for Unit Sizes. Masonry Openings above include Sill Nose, see Trim Options page for Sill Nose specifications. For other Trim Options refer to the Unit Sizing, Rough Opening & Masonry Openings page.

SCALE: 1/8" = 1'

**3-WIDE SINGLE-HUNG TILT WITH CENTER PICTURE
WITH 36" FLANKER**

UNIT SIZE
ROUGH OPENING
FRAME SIZE
DAYLIGHT OPENING

	110 1/8" (2797) 108" (2743) 107 1/2" (xxxx) 30 3/4" (781) 29 7/16" (748)[2]	122 1/8" (3102) 120" (3048) 119 1/2" (3035) 42 3/4" (1086) 30 3/4" (781)[2] 29 7/16" (748)[2]	134 1/8" (3407) 132" (3353) 131 1/2" (3340) 54 3/4" (1391) 30 3/4" (781)[2] 29 7/16" (748)[2]
32 1/8" (816) 30" (762) 29 1/2" (749) 24 3/4" (629) 11 7/16" (291) 10 1/4" (260)			
38 1/8" (968) 36" (914) 35 1/2" (902) 30 3/4" (781) 14 7/16" (367) 13 1/4" (337)			
44 1/8" (1121) 42" (1067) 41 1/2" (1054) 36 3/4" (933) 17 7/16" (443) 16 1/4" (413)			
50 1/8" (1273) 48" (1219) 47 1/2" (1207) 42 3/4" (1086) 20 7/16" (519) 19 1/4" (489)			
56 1/8" (1426) 54" (1372) 53 1/2" (1359) 48 3/4" (1238) 23 7/16" (595) 22 1/4" (565)			
62 1/8" (1578) 60" (1524) 59 1/2" (1511) 54 3/4" (1391) 26 7/16" (672) 25 1/4" (641)			
68 1/8" (1730) 66" (1676) 65 1/2" (1664) 60 3/4" (1543) 29 7/16" (748) 28 1/4" (718)			

ELEVATION SYMBOL LEGEND:
VALUES IN () ARE IN MILLIMETER CONVERSIONS
VALUES IN [] ARE NUMBER OF DAYLIGHT OPENINGS PER UNIT

E BASIC UNIT CLEAR OPENING EXCEEDS 20" IN WIDTH, 24" IN HEIGHT & A MINIMUM OF 5.7 SQ. FT.

Note: Elevations shown DO NOT have exterior trim. Subtract 1/2" (12.7) from M.O. (Masonry Opening) for Unit Sizes. Masonry Openings above include Sill Nose, see Trim Options page for Sill Nose specifications. For other Trim Options refer to the Unit Sizing, Rough Opening & Masonry Openings page.

SCALE: 1/8" = 1'

SINGLE-HUNG UNITS WITH HALF ROUND

UNIT SIZE
ROUGH OPENING
FRAME SIZE
DAYLIGHT OPENING

32 1/8" (816)
30" (762)
29 1/2" (749)
24 3/4" (629)
23 7/16" (595)
25 1/8" (638)

53 1/2" (1359)
51 3/8" (1305)
50 7/8" (1292)
49 1/4" (1257)
48 1/8" (1237)

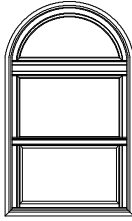

75TB3036-R

32 1/8" (816)
30" (762)
29 1/2" (749)
24 3/4" (629)
23 7/16" (595)
25 1/8" (638)

54 1/2" (1384)
52 3/8" (1330)
51 7/8" (1318)
50 1/4" (1283)
49 1/8" (1263)

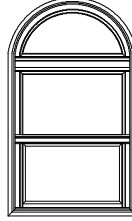

75TB3037-R

32 1/8" (816)
30" (762)
29 1/2" (749)
24 3/4" (629)
23 7/16" (595)
25 1/8" (638)

57 1/2" (1460)
55 3/8" (1407)
54 7/8" (1394)
53 1/4" (1359)
52 1/8" (1339)

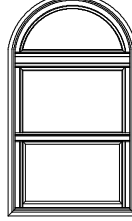

75TB3038-R

32 1/8" (816)
30" (762)
29 1/2" (749)
24 3/4" (629)
23 7/16" (595)
25 1/8" (638)

58 1/2" (1486)
56 3/8" (1432)
55 7/8" (1419)
54 1/4" (1384)
53 1/8" (1364)

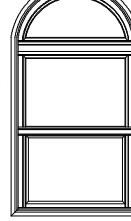

75TB3041-R

32 1/8" (816)
30" (762)
29 1/2" (749)
24 3/4" (629)
23 7/16" (595)
25 1/8" (638)

59 1/2" (1511)
57 3/8" (1457)
56 7/8" (1445)
55 1/4" (1410)
54 1/8" (1390)

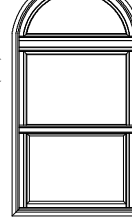

75TB3042-R

UNIT SIZE
ROUGH OPENING
FRAME SIZE
DAYLIGHT OPENING

32 1/8" (816)
30" (762)
29 1/2" (749)
24 3/4" (629)
23 7/16" (595)
25 1/8" (638)

65 1/2" (1664)
63 3/8" (1610)
62 7/8" (1597)
61 1/4" (1562)
60 1/8" (1542)

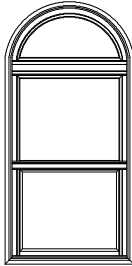

75TB3048-R

32 1/8" (816)
30" (762)
29 1/2" (749)
24 3/4" (629)
23 7/16" (595)
25 1/8" (638)

66 1/2" (1689)
64 3/8" (1635)
63 7/8" (1622)
62 1/4" (1587)
61 1/8" (1567)

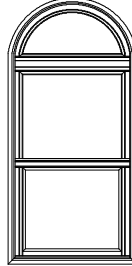

75TB3049-R

32 1/8" (816)
30" (762)
29 1/2" (749)
24 3/4" (629)
23 7/16" (595)
25 1/8" (638)

70 1/2" (1791)
68 3/8" (1737)
67 7/8" (1724)
66 1/4" (1689)
65 1/8" (1669)

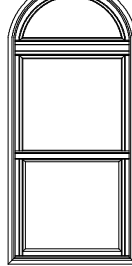

75TB3053-R

32 1/8" (816)
30" (762)
29 1/2" (749)
24 3/4" (629)
23 7/16" (595)
25 1/8" (638)

71 1/2" (1861)
69 3/8" (1762)
68 7/8" (1749)
67 1/4" (1714)
66 1/8" (1694)

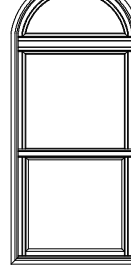

75TB3054-R

32 1/8" (816)
30" (762)
29 1/2" (749)
24 3/4" (629)
23 7/16" (595)
25 1/8" (638)

74 1/2" (1892)
72 3/8" (1838)
71 7/8" (1825)
70 1/4" (1790)
69 1/8" (1770)

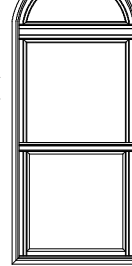

75TB3057-R

UNIT SIZE
ROUGH OPENING
FRAME SIZE
DAYLIGHT OPENING

32 1/8" (816)
30" (762)
29 1/2" (749)
24 3/4" (629)
23 7/16" (595)
25 1/8" (638)

77 1/2" (1969)
75 3/8" (1915)
74 7/8" (1902)
73 1/4" (1867)
72 1/8" (1847)

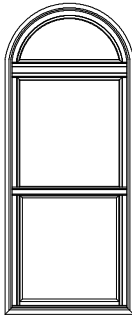

75TB3060-R

32 1/8" (816)
30" (762)
29 1/2" (749)
24 3/4" (629)
23 7/16" (595)
25 1/8" (638)

79 1/2" (2019)
77 3/8" (1965)
76 7/8" (1953)
75 1/4" (1918)
74 1/8" (1898)

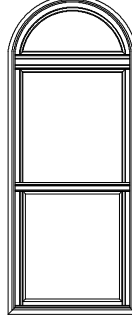

75TB3062-R

32 1/8" (816)
30" (762)
29 1/2" (749)
24 3/4" (629)
23 7/16" (595)
25 1/8" (638)

82 1/2" (2063)
80 3/8" (2009)
79 7/8" (2029)
78 1/4" (1994)
77 1/8" (1974)

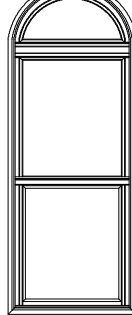

75TB3065-R

32 1/8" (816)
30" (762)
29 1/2" (749)
24 3/4" (629)
23 7/16" (595)
25 1/8" (638)

83 1/2" (2121)
81 3/8" (2067)
80 7/8" (2054)
79 1/4" (2019)
78 1/8" (1999)

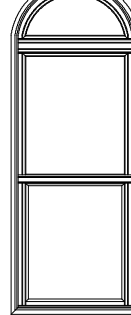

75TB3066-R

32 1/8" (816)
30" (762)
29 1/2" (749)
24 3/4" (629)
23 7/16" (595)
25 1/8" (638)

86 1/2" (2197)
84 3/8" (2143)
83 7/8" (2130)
82 1/4" (2095)
81 1/8" (2075)

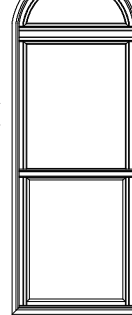

75TB3069-R

ELEVATION SYMBOL LEGEND:
VALUES IN () ARE IN MILLIMETER CONVERSIONS
VALUES IN [] ARE NUMBER OF DAYLIGHT OPENINGS PER UNIT

Note: Elevations shown DO NOT have exterior trim. Subtract 1/2" (12.7) from M.O. (Masonry Opening) for Unit Sizes. Masonry Openings above include Sill Nose, see Trim Options page for Sill Nose specifications. For other Trim Options refer to the Unit Sizing, Rough Opening & Masonry Openings page.

SCALE: 1/4" = 1'

SINGLE-HUNG UNITS WITH HALF ROUND

UNIT SIZE
ROUGH OPENING
FRAME SIZE
DAYLIGHT OPENING

32 1/8" (816)
30" (762)
29 1/2" (749)
24 3/4" (629)
23 7/16" (595)
25 1/8" (638)

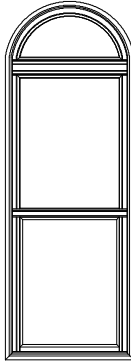

75TB3072-R

89 1/2" (2273)
87 3/8" (2219)
86 7/8" (2207)
32 7/16" (824)
13 1/2" (343)
10 1/8" (257)

32 1/8" (816)
30" (762)
29 1/2" (749)
24 3/4" (629)
23 7/16" (595)
25 1/8" (638)

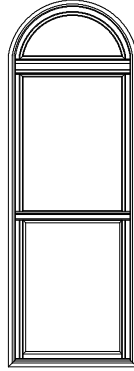

75TB3074-R

91 1/2" (2324)
89 3/8" (2270)
88 7/8" (2257)
33 7/16" (849)
14 1/2" (368)
10 1/8" (257)

32 1/8" (816)
30" (762)
29 1/2" (749)
24 3/4" (629)
23 7/16" (595)
25 1/8" (638)

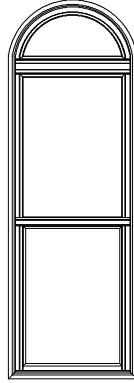

75TB3077-R

94 1/2" (2400)
92 3/8" (2346)
91 7/8" (2334)
34 15/16" (887)
33 3/4" (857)
10 1/8" (257)

UNIT SIZE
ROUGH OPENING
FRAME SIZE
DAYLIGHT OPENING

34 1/8" (867)
32" (813)
31 1/2" (800)
26 3/4" (679)
25 7/16" (646)
27 1/8" (689)

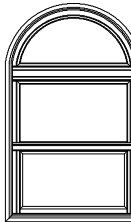

75TB3236-R

54 1/2" (1384)
52 3/8" (1330)
51 7/8" (1318)
14 7/16" (367)
13 1/2" (343)
11 1/8" (283)

34 1/8" (867)
32" (813)
31 1/2" (800)
26 3/4" (679)
25 7/16" (646)
27 1/8" (689)

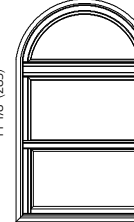

75TB3237-R

55 1/2" (1410)
53 3/8" (1356)
52 7/8" (1343)
14 15/16" (379)
13 3/4" (349)
11 1/8" (283)

34 1/8" (867)
32" (813)
31 1/2" (800)
26 3/4" (679)
25 7/16" (646)
27 1/8" (689)

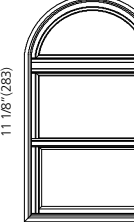

75TB3238-R

56 1/2" (1435)
54 3/8" (1381)
53 7/8" (1368)
15 7/16" (392)
14 1/2" (368)
11 1/8" (283)

34 1/8" (867)
32" (813)
31 1/2" (800)
26 3/4" (679)
25 7/16" (646)
27 1/8" (689)

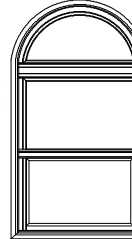

75TB3241-R

59 1/2" (1511)
57 3/8" (1457)
56 7/8" (1445)
16 15/16" (430)
15 3/4" (400)
11 1/8" (283)

34 1/8" (867)
32" (813)
31 1/2" (800)
26 3/4" (679)
25 7/16" (646)
27 1/8" (689)

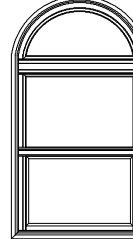

75TB3242-R

60 1/2" (1537)
58 3/8" (1483)
57 7/8" (1470)
17 7/16" (443)
16 1/2" (419)
11 1/8" (283)

UNIT SIZE
ROUGH OPENING
FRAME SIZE
DAYLIGHT OPENING

34 1/8" (867)
32" (813)
31 1/2" (800)
26 3/4" (679)
25 7/16" (646)
27 1/8" (689)

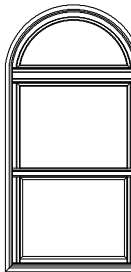

75TB3248-R

66 1/2" (1689)
64 3/8" (1635)
63 7/8" (1622)
20 7/16" (519)
19 1/2" (495)
11 1/8" (283)

34 1/8" (867)
32" (813)
31 1/2" (800)
26 3/4" (679)
25 7/16" (646)
27 1/8" (689)



75TB3249-R

67 1/2" (1715)
65 3/8" (1660)
64 7/8" (1648)
20 15/16" (532)
19 3/4" (502)
11 1/8" (283)

34 1/8" (867)
32" (813)
31 1/2" (800)
26 3/4" (679)
25 7/16" (646)
27 1/8" (689)

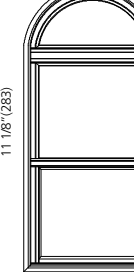

75TB3253-R

71 1/2" (1861)
69 3/8" (1762)
68 7/8" (1749)
22 15/16" (583)
21 3/4" (557)
11 1/8" (283)

34 1/8" (867)
32" (813)
31 1/2" (800)
26 3/4" (679)
25 7/16" (646)
27 1/8" (689)

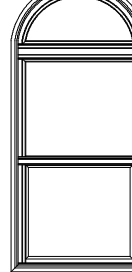

75TB3254-R

72 1/2" (1842)
70 3/8" (1788)
69 7/8" (1775)
23 7/16" (595)
22 1/4" (565)
11 1/8" (283)

34 1/8" (867)
32" (813)
31 1/2" (800)
26 3/4" (679)
25 7/16" (646)
27 1/8" (689)

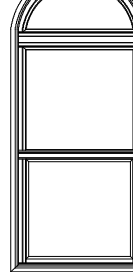

75TB3257-R

75 1/2" (1918)
73 3/8" (1864)
72 7/8" (1851)
24 15/16" (633)
23 3/4" (603)
11 1/8" (283)

ELEVATION SYMBOL LEGEND:
VALUES IN () ARE IN MILLIMETER CONVERSIONS
VALUES IN [] ARE NUMBER OF DAYLIGHT OPENINGS PER UNIT

Note: Elevations shown DO NOT have exterior trim. Subtract 1/2" (12.7) from M.O. (Masonry Opening) for Unit Sizes. Masonry Openings above include Sill Nose, see Trim Options page for Sill Nose specifications. For other Trim Options refer to the Unit Sizing, Rough Opening & Masonry Openings page.

SCALE: 1/4" = 1'

SINGLE-HUNG UNITS WITH HALF ROUND

UNIT SIZE
ROUGH OPENING
FRAME SIZE
DAYLIGHT OPENING

34 1/8" (867)
32" (813)
31 1/2" (800)
26 3/4" (679)
25 7/16" (646)
27 1/8" (689)

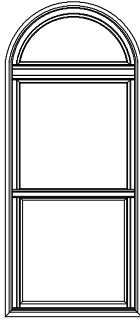

75TB3260-R

78 1/2" (1994)
76 3/8" (1940)
75 7/8" (1927)
26 7/16" (672)
25 1/4" (641)
11 1/8" (283)

34 1/8" (867)
32" (813)
31 1/2" (800)
26 3/4" (679)
25 7/16" (646)
27 1/8" (689)

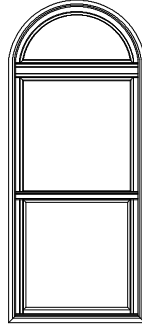

75TB3262-R

80 1/2" (2045)
78 3/8" (1991)
77 7/8" (1978)
27 7/16" (697)
26 1/4" (667)
11 1/8" (283)

34 1/8" (867)
32" (813)
31 1/2" (800)
26 3/4" (679)
25 7/16" (646)
27 1/8" (689)

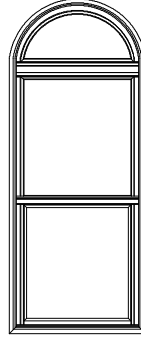

75TB3265-R

83 1/2" (2121)
81 3/8" (2067)
80 7/8" (2054)
28 15/16" (735)
27 3/4" (705)
11 1/8" (283)

34 1/8" (867)
32" (813)
31 1/2" (800)
26 3/4" (679)
25 7/16" (646)
27 1/8" (689)

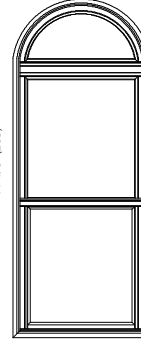

75TB3266-R

84 1/2" (2146)
82 3/8" (2092)
81 7/8" (2080)
29 7/16" (748)
28 1/4" (718)
11 1/8" (283)

34 1/8" (867)
32" (813)
31 1/2" (800)
26 3/4" (679)
25 7/16" (646)
27 1/8" (689)

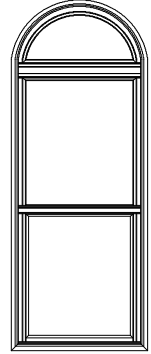

75TB3269-R

87 1/2" (2223)
85 3/8" (2169)
84 7/8" (2155)
30 15/16" (786)
29 3/4" (756)
11 1/8" (283)

UNIT SIZE
ROUGH OPENING
FRAME SIZE
DAYLIGHT OPENING

34 1/8" (867)
32" (813)
31 1/2" (800)
26 3/4" (679)
25 7/16" (646)
27 1/8" (689)

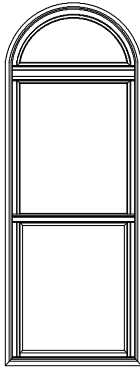

75TB3272-R

90 1/2" (2299)
88 3/8" (2245)
87 7/8" (2232)
32 7/16" (824)
31 1/4" (794)
11 1/8" (283)

34 1/8" (867)
32" (813)
31 1/2" (800)
26 3/4" (679)
25 7/16" (646)
27 1/8" (689)

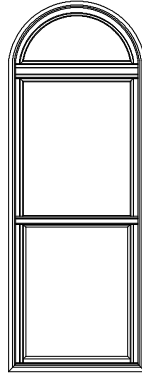

75TB3274-R

92 1/2" (2350)
90 3/8" (2296)
89 7/8" (2283)
32 7/16" (849)
32 1/4" (819)
11 1/8" (283)

34 1/8" (867)
32" (813)
31 1/2" (800)
26 3/4" (679)
25 7/16" (646)
27 1/8" (689)

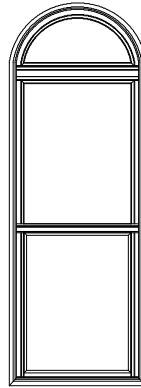

75TB3277-R

95 1/2" (2426)
93 3/8" (2372)
92 7/8" (2359)
34 15/16" (887)
33 3/4" (857)
11 1/8" (283)

UNIT SIZE
ROUGH OPENING
FRAME SIZE
DAYLIGHT OPENING

36 1/8" (918)
34" (864)
33 1/2" (851)
28 3/4" (730)
27 7/16" (697)
29 1/8" (740)

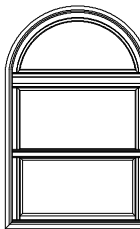

75TB3436-R

55 1/2" (1410)
53 3/8" (1356)
52 7/8" (1343)
14 7/16" (367)
13 1/4" (337)
12 1/8" (308)

36 1/8" (918)
34" (864)
33 1/2" (851)
28 3/4" (730)
27 7/16" (697)
29 1/8" (740)

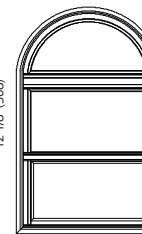

75TB3437-R

56 1/2" (1435)
54 3/8" (1381)
53 7/8" (1368)
14 15/16" (379)
13 3/4" (349)
12 1/8" (308)

36 1/8" (918)
34" (864)
33 1/2" (851)
28 3/4" (730)
27 7/16" (697)
29 1/8" (740)

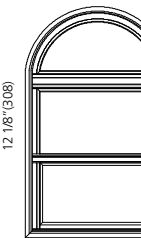

75TB3438-R

57 1/2" (1460)
55 3/8" (1407)
54 7/8" (1394)
15 7/16" (392)
14 1/4" (362)
12 1/8" (308)

36 1/8" (918)
34" (864)
33 1/2" (851)
28 3/4" (730)
27 7/16" (697)
29 1/8" (740)

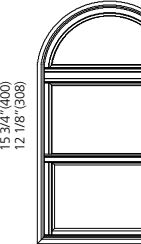

75TB3441-R

58 1/2" (1486)
56 3/8" (1432)
55 7/8" (1419)
16 15/16" (430)
15 3/4" (400)
12 1/8" (308)

ELEVATION SYMBOL LEGEND:

VALUES IN () ARE IN MILLIMETER CONVERSIONS
VALUES IN [] ARE NUMBER OF DAYLIGHT OPENINGS PER UNIT

Note: Elevations shown DO NOT have exterior trim. Subtract 1/2" (12.7) from M.O. (Masonry Opening) for Unit Sizes. Masonry Openings above include Sill Nose, see Trim Options page for Sill Nose specifications. For other Trim Options refer to the Unit Sizing, Rough Opening & Masonry Openings page.

SCALE: 1/4" = 1'

SINGLE-HUNG UNITS WITH HALF ROUND

UNIT SIZE 36 1/8"(918)
ROUGH OPENING 34"(864)
FRAME SIZE 33 1/2"(851)
DAYLIGHT OPENING 28 3/4"(730)
27 7/16"(697)
29 1/8"(740)

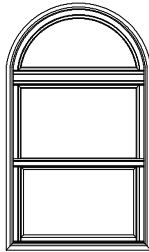

75TB3442-R

61 1/2"(1562)
59 3/8"(1508)
58 7/8"(1495)
17 7/16"(443)
16 1/4"(413)
12 1/8"(308)

UNIT SIZE 36 1/8"(918)
ROUGH OPENING 34"(864)
FRAME SIZE 33 1/2"(851)
DAYLIGHT OPENING 28 3/4"(730)
27 7/16"(697)
29 1/8"(740)

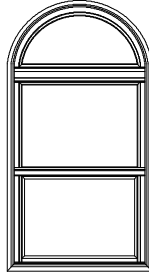

75TB3448-R

67 1/2"(1715)
65 3/8"(1660)
64 7/8"(1648)
20 7/16"(519)
19 1/4"(489)
12 1/8"(308)

UNIT SIZE 36 1/8"(918)
ROUGH OPENING 34"(864)
FRAME SIZE 33 1/2"(851)
DAYLIGHT OPENING 28 3/4"(730)
27 7/16"(697)
29 1/8"(740)

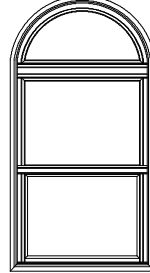

75TB3449-R

68 1/2"(1740)
66 3/8"(1676)
65 7/8"(1673)
20 15/16"(532)
19 3/4"(502)
12 1/8"(308)

UNIT SIZE 36 1/8"(918)
ROUGH OPENING 34"(864)
FRAME SIZE 33 1/2"(851)
DAYLIGHT OPENING 28 3/4"(730)
27 7/16"(697)
29 1/8"(740)

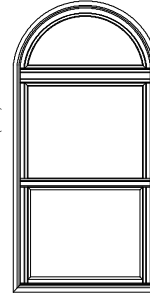

75TB3453-R

72 1/2"(1842)
70 3/8"(1788)
69 7/8"(1775)
22 15/16"(583)
21 3/4"(552)
12 1/8"(308)

UNIT SIZE 36 1/8"(918)
ROUGH OPENING 34"(864)
FRAME SIZE 33 1/2"(851)
DAYLIGHT OPENING 28 3/4"(730)
27 7/16"(697)
29 1/8"(740)

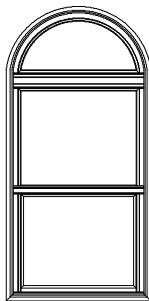

75TB3454-R

73 1/2"(1867)
71 3/8"(1813)
80 7/8"(1800)
23 7/16"(595)
22 1/4"(565)
12 1/8"(308)

UNIT SIZE 36 1/8"(918)
ROUGH OPENING 34"(864)
FRAME SIZE 33 1/2"(851)
DAYLIGHT OPENING 28 3/4"(730)
27 7/16"(697)
29 1/8"(740)

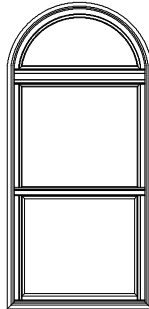

75TB3457-R

76 1/2"(1943)
74 3/8"(1889)
73 7/8"(1876)
24 15/16"(633)
23 3/4"(603)
12 1/8"(308)

UNIT SIZE 36 1/8"(918)
ROUGH OPENING 34"(864)
FRAME SIZE 33 1/2"(851)
DAYLIGHT OPENING 28 3/4"(730)
27 7/16"(697)
29 1/8"(740)

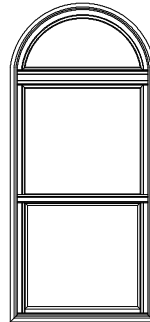

75TB3460-R

79 1/2"(2019)
77 3/8"(1965)
76 7/8"(1953)
26 7/16"(672)
25 1/4"(641)
12 1/8"(308)

UNIT SIZE 36 1/8"(918)
ROUGH OPENING 34"(864)
FRAME SIZE 33 1/2"(851)
DAYLIGHT OPENING 28 3/4"(730)
27 7/16"(697)
29 1/8"(740)

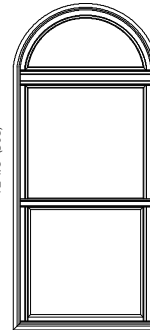

75TB3462-R

81 1/2"(2070)
79 3/8"(2016)
78 7/8"(2003)
27 7/16"(697)
26 1/4"(667)
12 1/8"(308)

UNIT SIZE 36 1/8"(918)
ROUGH OPENING 34"(864)
FRAME SIZE 33 1/2"(851)
DAYLIGHT OPENING 28 3/4"(730)
27 7/16"(697)
29 1/8"(740)

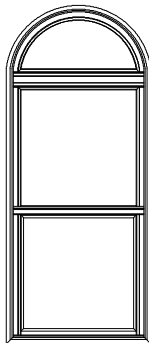

75TB3465-R

84 1/2"(2146)
82 3/8"(2092)
81 7/8"(2080)
28 15/16"(735)
27 3/4"(705)
12 1/8"(308)

UNIT SIZE 36 1/8"(918)
ROUGH OPENING 34"(864)
FRAME SIZE 33 1/2"(851)
DAYLIGHT OPENING 28 3/4"(730)
27 7/16"(697)
29 1/8"(740)

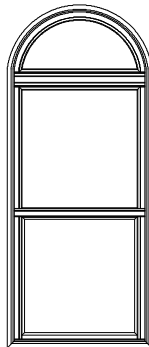

75TB3466-R

85 1/2"(2172)
83 3/8"(2118)
82 7/8"(2105)
29 7/16"(748)
28 1/4"(718)
12 1/8"(308)

UNIT SIZE 36 1/8"(918)
ROUGH OPENING 34"(864)
FRAME SIZE 33 1/2"(851)
DAYLIGHT OPENING 28 3/4"(730)
27 7/16"(697)
29 1/8"(740)

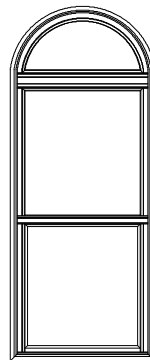

75TB3469-R

88 1/2"(2248)
86 3/8"(2194)
85 7/8"(2181)
30 15/16"(786)
29 3/4"(756)
12 1/8"(308)

UNIT SIZE 36 1/8"(918)
ROUGH OPENING 34"(864)
FRAME SIZE 33 1/2"(851)
DAYLIGHT OPENING 28 3/4"(730)
27 7/16"(697)
29 1/8"(740)

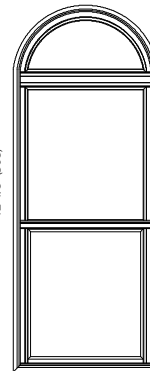

75TB3472-R

91 1/2"(2324)
89 3/8"(2270)
88 7/8"(2257)
32 7/16"(824)
31 1/4"(794)
12 1/8"(308)

ELEVATION SYMBOL LEGEND:
VALUES IN () ARE IN MILLIMETER CONVERSIONS
VALUES IN [] ARE NUMBER OF DAYLIGHT OPENINGS PER UNIT

Note: Elevations shown DO NOT have exterior trim. Subtract 1/2" (12.7) from M.O. (Masonry Opening) for Unit Sizes. Masonry Openings above include Sill Nose, see Trim Options page for Sill Nose specifications. For other Trim Options refer to the Unit Sizing, Rough Opening & Masonry Openings page.

SCALE: 1/4" = 1'

SINGLE-HUNG UNITS WITH HALF ROUND

UNIT SIZE 36 1/8" (918)
ROUGH OPENING 34" (864)
FRAME SIZE 33 1/2" (851)
DAYLIGHT OPENING 28 3/4" (730)
27 7/16" (697)
29 1/8" (740)

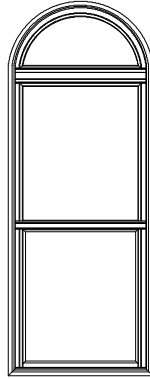

7STB3474-R

93 1/2" (2380)
91 3/8" (2321)
90 7/8" (2308)
33 7/16" (849)
32 1/4" (819)
12 1/8" (308)

UNIT SIZE 36 1/8" (918)
ROUGH OPENING 34" (864)
FRAME SIZE 33 1/2" (851)
DAYLIGHT OPENING 28 3/4" (730)
27 7/16" (697)
29 1/8" (740)

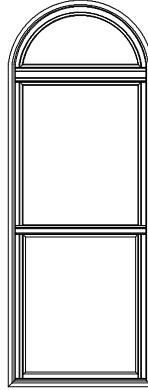

7STB3477-R

96 1/2" (2451)
94 3/8" (2397)
93 7/8" (2384)
34 15/16" (887)
33 3/4" (857)
12 1/8" (308)

UNIT SIZE 38 1/8" (968)
ROUGH OPENING 36" (914)
FRAME SIZE 35 1/2" (902)
DAYLIGHT OPENING 30 3/4" (781)
29 7/16" (748)
31 1/8" (791)

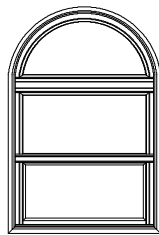

7STB3636-R

56 1/2" (1435)
54 3/8" (1381)
53 7/8" (1368)
14 7/16" (367)
13 1/4" (337)
13 1/8" (333)

UNIT SIZE 38 1/8" (968)
ROUGH OPENING 36" (914)
FRAME SIZE 35 1/2" (902)
DAYLIGHT OPENING 30 3/4" (781)
29 7/16" (748)
31 1/8" (791)

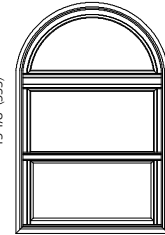

7STB3637-R

57 1/2" (1460)
55 3/8" (1407)
54 7/8" (1394)
14 15/16" (379)
13 3/4" (349)
13 1/8" (333)

UNIT SIZE 38 1/8" (968)
ROUGH OPENING 36" (914)
FRAME SIZE 35 1/2" (902)
DAYLIGHT OPENING 30 3/4" (781)
29 7/16" (748)
31 1/8" (791)

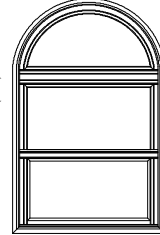

7STB3638-R

58 1/2" (1486)
56 3/8" (1432)
55 7/8" (1419)
15 7/16" (392)
14 1/4" (362)
13 1/8" (333)

UNIT SIZE 38 1/8" (968)
ROUGH OPENING 36" (914)
FRAME SIZE 35 1/2" (902)
DAYLIGHT OPENING 30 3/4" (781)
29 7/16" (748)
31 1/8" (791)

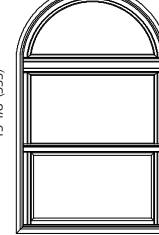

7STB3641-R

61 1/2" (1562)
59 3/8" (1508)
58 7/8" (1495)
16 15/16" (430)
15 3/4" (400)
13 1/8" (333)

UNIT SIZE 38 1/8" (968)
ROUGH OPENING 36" (914)
FRAME SIZE 35 1/2" (902)
DAYLIGHT OPENING 30 3/4" (781)
29 7/16" (748)
31 1/8" (791)

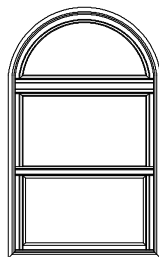

7STB3642-R

62 1/2" (1588)
60 3/8" (1534)
59 7/8" (1521)
17 7/16" (443)
16 1/4" (413)
13 1/8" (333)

UNIT SIZE 38 1/8" (968)
ROUGH OPENING 36" (914)
FRAME SIZE 35 1/2" (902)
DAYLIGHT OPENING 30 3/4" (781)
29 7/16" (748)
31 1/8" (791)

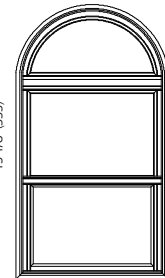

7STB3648-R

68 1/2" (1740)
66 3/8" (1676)
65 7/8" (1673)
20 7/16" (519)
19 1/4" (489)
13 1/8" (333)

UNIT SIZE 38 1/8" (968)
ROUGH OPENING 36" (914)
FRAME SIZE 35 1/2" (902)
DAYLIGHT OPENING 30 3/4" (781)
29 7/16" (748)
31 1/8" (791)

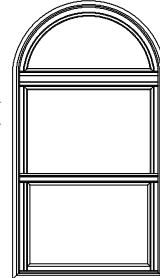

7STB3649-R

69 1/2" (1765)
67 3/8" (1711)
66 7/8" (1699)
20 15/16" (532)
19 3/4" (502)
13 1/8" (333)

UNIT SIZE 38 1/8" (968)
ROUGH OPENING 36" (914)
FRAME SIZE 35 1/2" (902)
DAYLIGHT OPENING 30 3/4" (781)
29 7/16" (748)
31 1/8" (791)

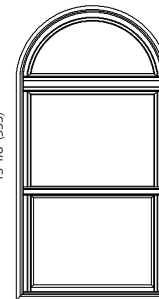

7STB3653-R

73 1/2" (1867)
71 3/8" (1813)
80 7/8" (1800)
22 15/16" (583)
21 3/4" (552)
13 1/8" (333)

ELEVATION SYMBOL LEGEND:
VALUES IN () ARE IN MILLIMETER CONVERSIONS
VALUES IN [] ARE NUMBER OF DAYLIGHT OPENINGS PER UNIT

Note: Elevations shown DO NOT have exterior trim. Subtract 1/2" (12.7) from M.O. (Masonry Opening) for Unit Sizes. Masonry Openings above include Sill Nose, see Trim Options page for Sill Nose specifications. For other Trim Options refer to the Unit Sizing, Rough Opening & Masonry Openings page.

SCALE: 1/4" = 1'

SINGLE-HUNG UNITS WITH HALF ROUND

UNIT SIZE
ROUGH OPENING
FRAME SIZE
DAYLIGHT OPENING

38 1/8" (968)
36" (914)
35 1/2" (902)
30 3/4" (781)
29 7/16" (748)
31 1/8" (791)

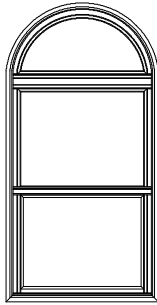

74 1/2" (1892)
72 3/8" (1838)
71 7/8" (1826)
23 7/16" (595)
22 1/4" (565)
13 1/8" (333)

75TB3654-R

38 1/8" (968)
36" (914)
35 1/2" (902)
30 3/4" (781)
29 7/16" (748)
31 1/8" (791)

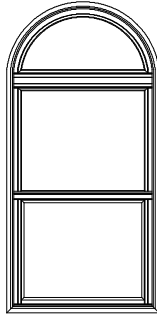

77 1/2" (1969)
75 3/8" (1915)
74 7/8" (1902)
24 1/2" (613)
23 1/4" (583)
13 1/8" (333)

75TB3657-R

38 1/8" (968)
36" (914)
35 1/2" (902)
30 3/4" (781)
29 7/16" (748)
31 1/8" (791)

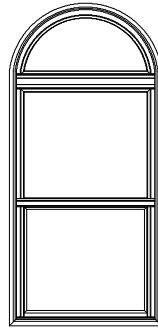

80 1/2" (2045)
78 3/8" (1991)
77 7/8" (1978)
26 7/16" (672)
25 1/4" (641)
13 1/8" (333)

75TB3660-R

38 1/8" (968)
36" (914)
35 1/2" (902)
30 3/4" (781)
29 7/16" (748)
31 1/8" (791)

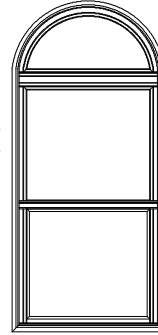

82 1/2" (2063)
80 3/8" (2042)
79 7/8" (2029)
26 1/4" (667)
25 1/8" (637)
13 1/8" (333)

75TB3662-R

UNIT SIZE
ROUGH OPENING
FRAME SIZE
DAYLIGHT OPENING

38 1/8" (968)
36" (914)
35 1/2" (902)
30 3/4" (781)
29 7/16" (748)
31 1/8" (791)

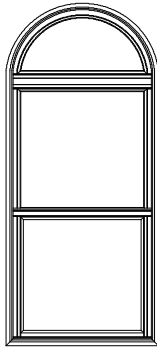

85 1/2" (2172)
83 3/8" (2118)
82 7/8" (2105)
28 15/16" (735)
27 3/4" (705)
13 1/8" (333)

75TB3665-R

38 1/8" (968)
36" (914)
35 1/2" (902)
30 3/4" (781)
29 7/16" (748)
31 1/8" (791)

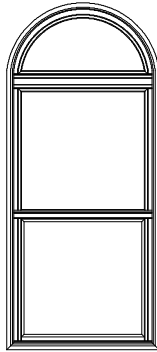

86 1/2" (2197)
84 3/8" (2143)
83 7/8" (2130)
29 7/16" (748)
28 1/2" (713)
13 1/8" (333)

75TB3666-R

38 1/8" (968)
36" (914)
35 1/2" (902)
30 3/4" (781)
29 7/16" (748)
31 1/8" (791)

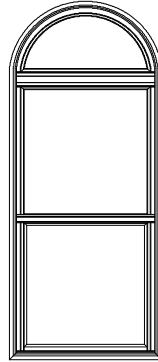

89 1/2" (2273)
87 3/8" (2219)
86 7/8" (2207)
30 15/16" (786)
29 3/4" (756)
13 1/8" (333)

75TB3669-R

38 1/8" (968)
36" (914)
35 1/2" (902)
30 3/4" (781)
29 7/16" (748)
31 1/8" (791)

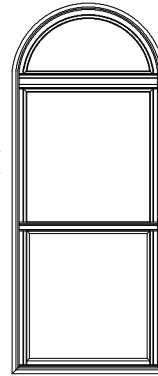

92 1/2" (2350)
90 3/8" (2296)
89 7/8" (2283)
32 1/4" (824)
31 1/8" (791)
13 1/8" (333)

75TB3672-R

UNIT SIZE
ROUGH OPENING
FRAME SIZE
DAYLIGHT OPENING

38 1/8" (968)
36" (914)
35 1/2" (902)
30 3/4" (781)
29 7/16" (748)
31 1/8" (791)

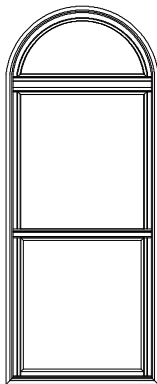

94 1/2" (2400)
92 3/8" (2346)
91 7/8" (2334)
33 7/16" (849)
32 1/4" (819)
13 1/8" (333)

75TB3674-R

38 1/8" (968)
36" (914)
35 1/2" (902)
30 3/4" (781)
29 7/16" (748)
31 1/8" (791)

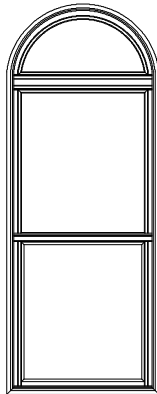

97 1/2" (2477)
95 3/8" (2423)
94 7/8" (2410)
34 1/2" (887)
33 1/4" (857)
13 1/8" (333)

75TB3677-R

ELEVATION SYMBOL LEGEND:

VALUES IN () ARE IN MILLIMETER CONVERSIONS
VALUES IN [] ARE NUMBER OF DAYLIGHT OPENINGS PER UNIT

Note: Elevations shown DO NOT have exterior trim. Subtract 1/2" (12.7) from M.O. (Masonry Opening) for Unit Sizes. Masonry Openings above include Sill Nose, see Trim Options page for Sill Nose specifications. For other Trim Options refer to the Unit Sizing, Rough Opening & Masonry Openings page.

SCALE: 1/4" = 1'

SINGLE-HUNG UNITS WITH HALF ROUND

UNIT SIZE
ROUGH OPENING
FRAME SIZE
DAYLIGHT OPENING

40 1/8" (1019)
38" (965)
37 1/2" (953)
32 3/4" (832)
31 7/16" (799)
33 1/8" (841)

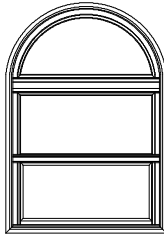

75TB3836-R

57 1/2" (1460)
55 3/8" (1407)
54 7/8" (1394)
51 1/8" (1300)
51 1/4" (1307)
13 1/4" (337)
14 1/8" (359)

58 1/2" (1486)
56 3/8" (1432)
55 7/8" (1425)
51 1/8" (1300)
51 1/4" (1307)
13 3/4" (349)
14 1/8" (359)

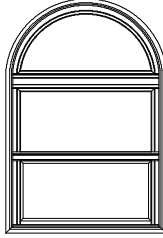

75TB3837-R

59 1/2" (1511)
57 3/8" (1457)
56 7/8" (1445)
51 1/8" (1300)
51 1/4" (1307)
14 1/4" (362)
14 1/8" (359)

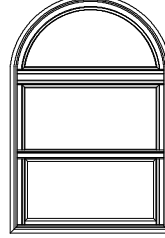

75TB3838-R

63 1/2" (1588)
60 3/8" (1534)
59 7/8" (1521)
55 1/8" (1394)
55 1/4" (1400)
15 3/4" (400)
14 1/8" (359)

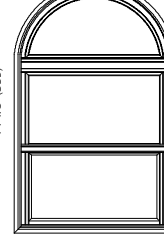

75TB3841-R

UNIT SIZE
ROUGH OPENING
FRAME SIZE
DAYLIGHT OPENING

40 1/8" (1019)
38" (965)
37 1/2" (953)
32 3/4" (832)
31 7/16" (799)
33 1/8" (841)

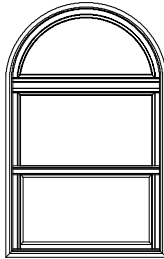

75TB3842-R

63 1/2" (1613)
61 3/8" (1559)
60 7/8" (1546)
57 1/8" (1443)
56 1/4" (1430)
16 1/4" (413)
14 1/8" (359)

69 1/2" (1765)
67 3/8" (1711)
66 7/8" (1698)
60 7/8" (1546)
60 1/4" (1539)
19 1/4" (489)
14 1/8" (359)

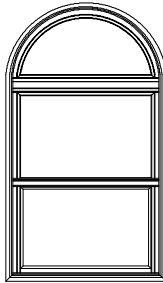

75TB3848-R

70 1/2" (1781)
68 3/8" (1727)
67 7/8" (1720)
60 7/8" (1546)
60 1/4" (1539)
19 3/4" (502)
14 1/8" (359)

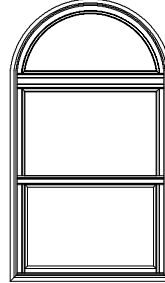

75TB3849-R

74 1/2" (1892)
72 3/8" (1838)
71 7/8" (1825)
66 7/8" (1698)
66 1/4" (1691)
21 3/4" (552)
14 1/8" (359)

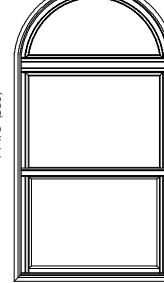

75TB3853-R

UNIT SIZE
ROUGH OPENING
FRAME SIZE
DAYLIGHT OPENING

40 1/8" (1019)
38" (965)
37 1/2" (953)
32 3/4" (832)
31 7/16" (799)
33 1/8" (841)

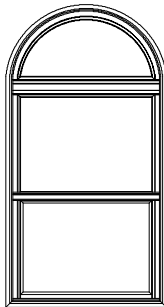

75TB3854-R

75 1/2" (1918)
73 3/8" (1864)
72 7/8" (1851)
67 7/8" (1720)
67 1/4" (1713)
22 1/4" (565)
14 1/8" (359)

78 1/2" (1994)
76 3/8" (1940)
75 7/8" (1927)
71 1/8" (1800)
71 1/4" (1807)
23 3/4" (603)
14 1/8" (359)

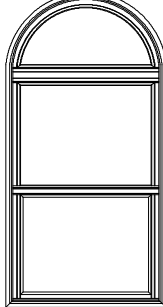

75TB3857-R

81 1/2" (2070)
79 3/8" (2016)
78 7/8" (2003)
76 7/8" (1957)
76 1/4" (1944)
25 1/4" (641)
14 1/8" (359)

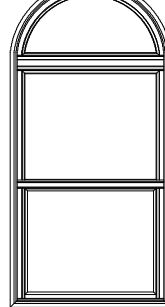

75TB3860-R

83 1/2" (2121)
81 3/8" (2067)
80 7/8" (2054)
77 1/8" (1957)
76 1/4" (1944)
26 1/4" (667)
14 1/8" (359)

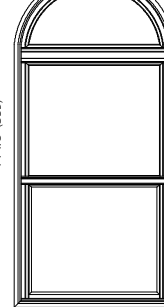

75TB3862-R

ELEVATION SYMBOL LEGEND:
VALUES IN () ARE IN MILLIMETER CONVERSIONS
VALUES IN [] ARE NUMBER OF DAYLIGHT OPENINGS PER UNIT

Note: Elevations shown DO NOT have exterior trim. Subtract 1/2" (12.7) from M.O. (Masonry Opening) for Unit Sizes. Masonry Openings above include Sill Nose, see Trim Options page for Sill Nose specifications. For other Trim Options refer to the Unit Sizing, Rough Opening & Masonry Openings page.

SCALE: 1/4" = 1'

SINGLE-HUNG UNITS WITH HALF ROUND

UNIT SIZE
ROUGH OPENING
FRAME SIZE
DAYLIGHT OPENING

40 1/8" (1019)
38" (965)
37 1/2" (953)
32 3/4" (832)
31 7/16" (799)
33 1/8" (841)

86 1/2" (2197)
84 3/8" (2143)
83 7/8" (2130)
28 15/16" (735)
27 3/4" (705)
14 1/8" (359)

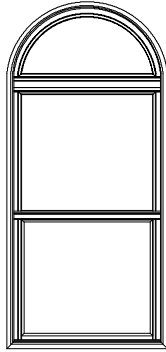

75TB3865-R

40 1/8" (1019)
38" (965)
37 1/2" (953)
32 3/4" (832)
31 7/16" (799)
33 1/8" (841)

87 1/2" (2223)
85 3/8" (2169)
84 7/8" (2155)
29 7/16" (748)
28 1/4" (718)
14 1/8" (359)

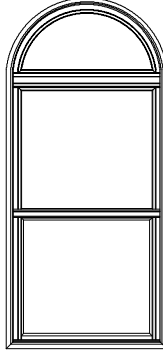

75TB3866-R

40 1/8" (1019)
38" (965)
37 1/2" (953)
32 3/4" (832)
31 7/16" (799)
33 1/8" (841)

90 1/2" (2299)
88 3/8" (2245)
87 7/8" (2232)
30 15/16" (786)
29 3/4" (756)
14 1/8" (359)

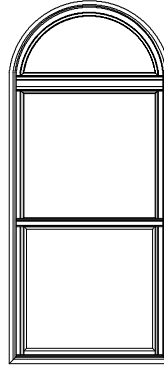

75TB3869-R

40 1/8" (1019)
38" (965)
37 1/2" (953)
32 3/4" (832)
31 7/16" (799)
33 1/8" (841)

93 1/2" (2380)
91 3/8" (2321)
90 7/8" (2308)
32 7/16" (824)
31 1/4" (794)
14 1/8" (359)

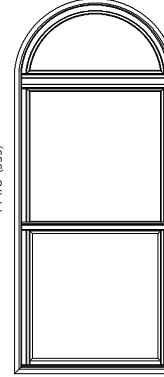

75TB3872-R

UNIT SIZE
ROUGH OPENING
FRAME SIZE
DAYLIGHT OPENING

40 1/8" (1019)
38" (965)
37 1/2" (953)
32 3/4" (832)
31 7/16" (799)
33 1/8" (841)

95 1/2" (2426)
93 3/8" (2372)
92 7/8" (2359)
33 7/16" (849)
32 1/4" (819)
14 1/8" (359)

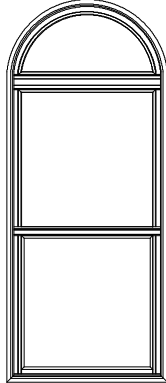

75TB3874-R

40 1/8" (1019)
38" (965)
37 1/2" (953)
32 3/4" (832)
31 7/16" (799)
33 1/8" (841)

98 1/2" (2502)
96 3/8" (2448)
95 7/8" (2435)
34 15/16" (887)
33 3/4" (857)
14 1/8" (359)

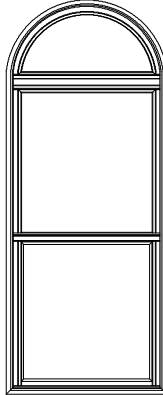

75TB3877-R

UNIT SIZE
ROUGH OPENING
FRAME SIZE
DAYLIGHT OPENING

42 1/8" (1070)
40" (1016)
39 1/2" (1003)
34 3/4" (883)
33 7/16" (849)
35 1/8" (892)

58 1/2" (1486)
56 3/8" (1432)
55 7/8" (1419)
14 7/16" (367)
13 1/4" (337)
15 1/8" (384)

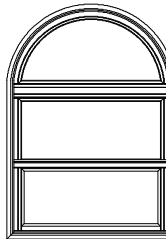

75TB4036-R

42 1/8" (1070)
40" (1016)
39 1/2" (1003)
34 3/4" (883)
33 7/16" (849)
35 1/8" (892)

59 1/2" (1511)
57 3/8" (1457)
56 7/8" (1445)
14 15/16" (379)
13 3/4" (349)
15 1/8" (384)

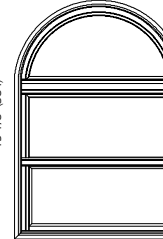

75TB4037-R

42 1/8" (1070)
40" (1016)
39 1/2" (1003)
34 3/4" (883)
33 7/16" (849)
35 1/8" (892)

60 1/2" (1537)
58 3/8" (1483)
57 7/8" (1470)
15 7/16" (392)
14 1/4" (362)
15 1/8" (384)

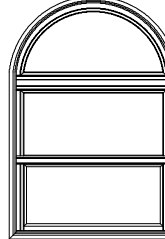

75TB4038-R

42 1/8" (1070)
40" (1016)
39 1/2" (1003)
34 3/4" (883)
33 7/16" (849)
35 1/8" (892)

63 1/2" (1613)
61 3/8" (1559)
60 7/8" (1546)
16 15/16" (430)
15 3/4" (400)
15 1/8" (384)

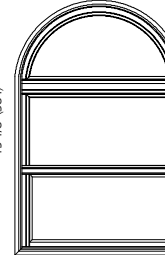

75TB4041-R

ELEVATION SYMBOL LEGEND:

VALUES IN () ARE IN MILLIMETER CONVERSIONS
VALUES IN [] ARE NUMBER OF DAYLIGHT OPENINGS PER UNIT

Note: Elevations shown DO NOT have exterior trim. Subtract 1/2" (12.7) from M.O. (Masonry Opening) for Unit Sizes. Masonry Openings above include Sill Nose, see Trim Options page for Sill Nose specifications. For other Trim Options refer to the Unit Sizing, Rough Opening & Masonry Openings page.

SCALE: 1/4" = 1'

SINGLE-HUNG UNITS WITH HALF ROUND

UNIT SIZE
ROUGH OPENING
FRAME SIZE
DAYLIGHT OPENING

42 1/8" (1070)
40" (1016)
39 1/2" (1003)
34 3/4" (883)
33 7/16" (849)
35 1/8" (892)

64 1/2" (1639)
64 3/8" (1632)
67 7/8" (1577)
17 7/16" (443)
16 1/4" (413)
15 1/8" (384)

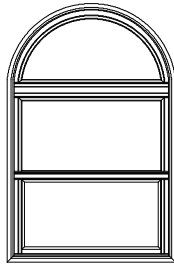

75TB4042-R

42 1/8" (1070)
40" (1016)
39 1/2" (1003)
34 3/4" (883)
33 7/16" (849)
35 1/8" (892)

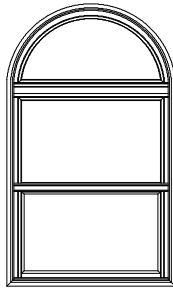

75TB4048-R

42 1/8" (1070)
40" (1016)
39 1/2" (1003)
34 3/4" (883)
33 7/16" (849)
35 1/8" (892)

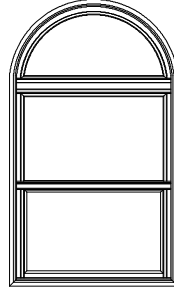

75TB4049-R

42 1/8" (1070)
40" (1016)
39 1/2" (1003)
34 3/4" (883)
33 7/16" (849)
35 1/8" (892)

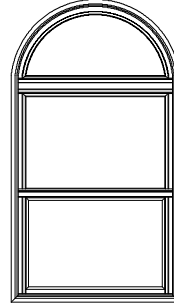

75TB4053-R

UNIT SIZE
ROUGH OPENING
FRAME SIZE
DAYLIGHT OPENING

42 1/8" (1070)
40" (1016)
39 1/2" (1003)
34 3/4" (883)
33 7/16" (849)
35 1/8" (892)

76 1/2" (1943)
76 3/8" (1898)
73 7/8" (1876)
23 7/16" (595)
22 1/4" (565)
15 1/8" (384)

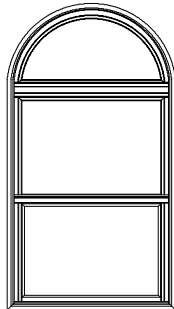

75TB4054-R

42 1/8" (1070)
40" (1016)
39 1/2" (1003)
34 3/4" (883)
33 7/16" (849)
35 1/8" (892)

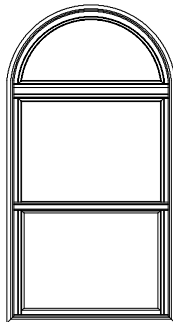

75TB4057-R

42 1/8" (1070)
40" (1016)
39 1/2" (1003)
34 3/4" (883)
33 7/16" (849)
35 1/8" (892)

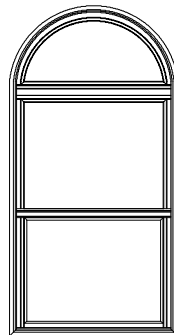

75TB4060-R

42 1/8" (1070)
40" (1016)
39 1/2" (1003)
34 3/4" (883)
33 7/16" (849)
35 1/8" (892)

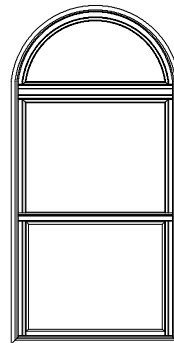

75TB4062-R

UNIT SIZE
ROUGH OPENING
FRAME SIZE
DAYLIGHT OPENING

42 1/8" (1070)
40" (1016)
39 1/2" (1003)
34 3/4" (883)
33 7/16" (849)
35 1/8" (892)

87 1/2" (2223)
86 3/8" (2163)
84 7/8" (2155)
28 15/16" (735)
27 3/4" (705)
15 1/8" (384)

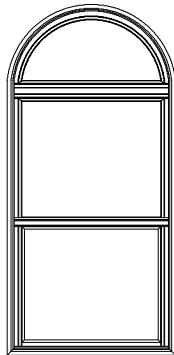

75TB4065-R

42 1/8" (1070)
40" (1016)
39 1/2" (1003)
34 3/4" (883)
33 7/16" (849)
35 1/8" (892)

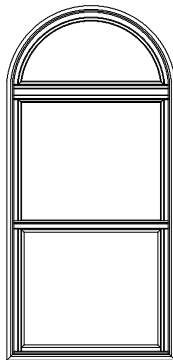

75TB4066-R

42 1/8" (1070)
40" (1016)
39 1/2" (1003)
34 3/4" (883)
33 7/16" (849)
35 1/8" (892)

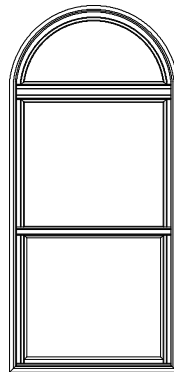

75TB4069-R

42 1/8" (1070)
40" (1016)
39 1/2" (1003)
34 3/4" (883)
33 7/16" (849)
35 1/8" (892)

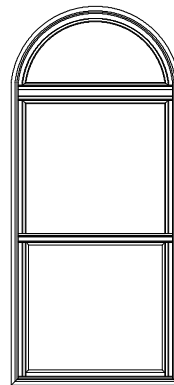

75TB4072-R

ELEVATION SYMBOL LEGEND:

VALUES IN () ARE IN MILLIMETER CONVERSIONS
VALUES IN [] ARE NUMBER OF DAYLIGHT OPENINGS PER UNIT

Note: Elevations shown DO NOT have exterior trim. Subtract 1/2" (12.7) from M.O. (Masonry Opening) for Unit Sizes. Masonry Openings above include Sill Nose, see Trim Options page for Sill Nose specifications. For other Trim Options refer to the Unit Sizing, Rough Opening & Masonry Openings page.

SCALE: 1/4" = 1'

SINGLE-HUNG UNITS WITH HALF ROUND

UNIT SIZE
ROUGH OPENING
FRAME SIZE
DAYLIGHT OPENING

42 1/8" (1070)
40" (1016)
39 1/2" (1003)
34 3/4" (883)
33 7/16" (849)
35 1/8" (892)

96 1/2" (2451)
94 3/8" (2397)
93 7/8" (2384)
93 7/16" (849)
92 1/2" (811)
15 1/8" (384)

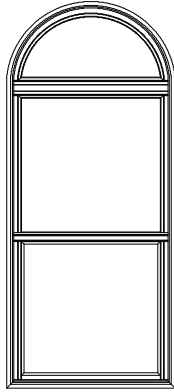

75TB4074-R

42 1/8" (1070)
40" (1016)
39 1/2" (1003)
34 3/4" (883)
33 7/16" (849)
35 1/8" (892)

99 1/2" (2527)
97 3/8" (2473)
96 7/8" (2461)
34 15/16" (887)
33 3/4" (857)
15 1/8" (384)

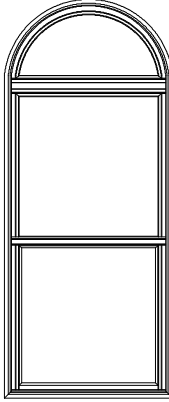

75TB4077-R

UNIT SIZE
ROUGH OPENING
FRAME SIZE
DAYLIGHT OPENING

44 1/8" (1121)
42" (1067)
41 1/2" (1054)
36 3/4" (933)
35 7/16" (900)
37 1/8" (943)

59 1/2" (1511)
57 3/8" (1457)
56 7/8" (1445)
14 7/16" (357)
13 1/2" (337)
16 1/8" (410)

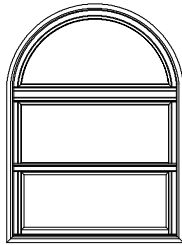

75TB4236-R

44 1/8" (1121)
42" (1067)
41 1/2" (1054)
36 3/4" (933)
35 7/16" (900)
37 1/8" (943)

60 1/2" (1537)
58 3/8" (1483)
57 7/8" (1470)
14 3/4" (375)
13 3/4" (346)
16 1/8" (410)

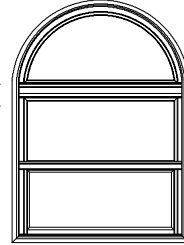

75TB4237-R

44 1/8" (1121)
42" (1067)
41 1/2" (1054)
36 3/4" (933)
35 7/16" (900)
37 1/8" (943)

61 1/2" (1562)
59 3/8" (1508)
58 7/8" (1495)
15 1/8" (382)
14 1/8" (352)
16 1/8" (410)

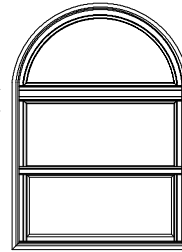

75TB4238-R

44 1/8" (1121)
42" (1067)
41 1/2" (1054)
36 3/4" (933)
35 7/16" (900)
37 1/8" (943)

64 1/2" (1638)
62 3/8" (1584)
61 7/8" (1572)
15 3/4" (400)
15 3/4" (400)
16 1/8" (410)

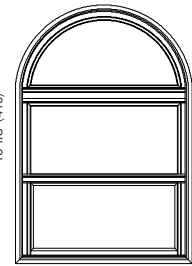

75TB4241-R

UNIT SIZE
ROUGH OPENING
FRAME SIZE
DAYLIGHT OPENING

44 1/8" (1121)
42" (1067)
41 1/2" (1054)
36 3/4" (933)
35 7/16" (900)
37 1/8" (943)

65 1/2" (1664)
63 3/8" (1609)
62 7/8" (1597)
17 7/16" (443)
16 1/2" (413)
16 1/8" (410)

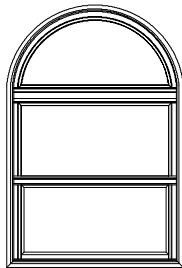

75TB4242-R

44 1/8" (1121)
42" (1067)
41 1/2" (1054)
36 3/4" (933)
35 7/16" (900)
37 1/8" (943)

71 1/2" (1861)
69 3/8" (1762)
68 7/8" (1749)
20 7/16" (539)
19 3/4" (493)
16 1/8" (410)

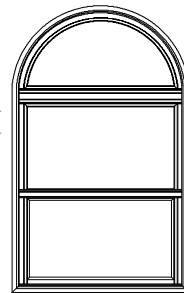

75TB4248-R

44 1/8" (1121)
42" (1067)
41 1/2" (1054)
36 3/4" (933)
35 7/16" (900)
37 1/8" (943)

72 1/2" (1842)
70 3/8" (1788)
69 7/8" (1775)
20 3/4" (532)
19 3/4" (502)
16 1/8" (410)

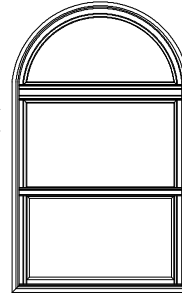

75TB4249-R

44 1/8" (1121)
42" (1067)
41 1/2" (1054)
36 3/4" (933)
35 7/16" (900)
37 1/8" (943)

76 1/2" (1943)
74 3/8" (1889)
73 7/8" (1876)
21 3/4" (553)
21 3/4" (553)
16 1/8" (410)

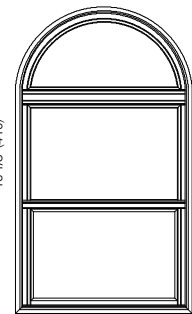

75TB4253-R

ELEVATION SYMBOL LEGEND:

VALUES IN () ARE IN MILLIMETER CONVERSIONS
VALUES IN [] ARE NUMBER OF DAYLIGHT OPENINGS PER UNIT

Note: Elevations shown DO NOT have exterior trim. Subtract 1/2" (12.7) from M.O. (Masonry Opening) for Unit Sizes. Masonry Openings above include Sill Nose, see Trim Options page for Sill Nose specifications. For other Trim Options refer to the Unit Sizing, Rough Opening & Masonry Openings page.

SCALE: 1/4" = 1'

SINGLE-HUNG UNITS WITH HALF ROUND

UNIT SIZE
ROUGH OPENING
FRAME SIZE
DAYLIGHT OPENING

44 1/8" (1121)
42" (1067)
41 1/2" (1054)
36 3/4" (933)
35 7/16" (900)
37 1/8" (943)

77 1/2" (1969)
75 3/8" (1915)
74 7/8" (1902)
73 7/16" (1855)
72 1/4" (1825)
71 1/8" (1800)

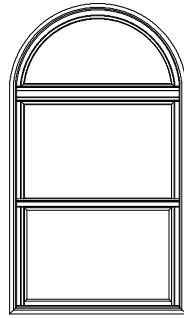

75TB4254-R

44 1/8" (1121)
42" (1067)
41 1/2" (1054)
36 3/4" (933)
35 7/16" (900)
37 1/8" (943)

80 1/2" (2045)
78 3/8" (1991)
77 7/8" (1978)
74 15/16" (1933)
73 3/4" (1903)
72 1/8" (1857)

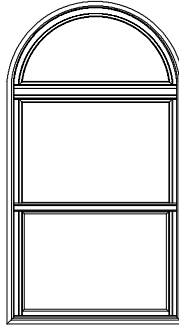

75TB4257-R

44 1/8" (1121)
42" (1067)
41 1/2" (1054)
36 3/4" (933)
35 7/16" (900)
37 1/8" (943)

83 1/2" (2121)
81 3/8" (2067)
80 7/8" (2054)
76 7/16" (1972)
75 1/4" (1941)
74 1/8" (1916)

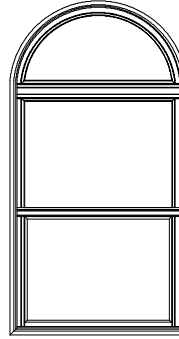

75TB4260-R

44 1/8" (1121)
42" (1067)
41 1/2" (1054)
36 3/4" (933)
35 7/16" (900)
37 1/8" (943)

85 1/2" (2172)
83 3/8" (2118)
82 7/8" (2105)
77 7/16" (1997)
76 1/4" (1967)
75 1/8" (1942)

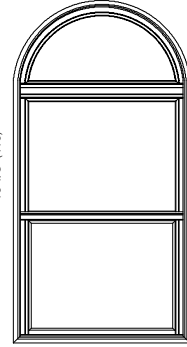

75TB4262-R

UNIT SIZE
ROUGH OPENING
FRAME SIZE
DAYLIGHT OPENING

44 1/8" (1121)
42" (1067)
41 1/2" (1054)
36 3/4" (933)
35 7/16" (900)
37 1/8" (943)

88 1/2" (2248)
86 3/8" (2194)
85 7/8" (2181)
82 7/16" (2105)
81 1/4" (2075)
80 1/8" (2050)

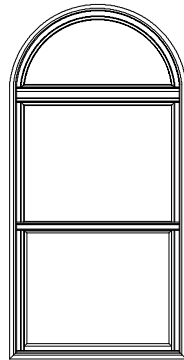

75TB4265-R

44 1/8" (1121)
42" (1067)
41 1/2" (1054)
36 3/4" (933)
35 7/16" (900)
37 1/8" (943)

89 1/2" (2273)
87 3/8" (2219)
86 7/8" (2207)
82 7/16" (2131)
81 1/4" (2101)
80 1/8" (2076)

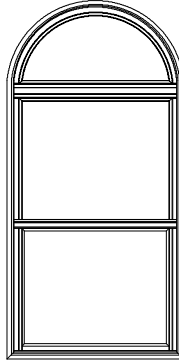

75TB4266-R

44 1/8" (1121)
42" (1067)
41 1/2" (1054)
36 3/4" (933)
35 7/16" (900)
37 1/8" (943)

92 1/2" (2350)
90 3/8" (2296)
89 7/8" (2283)
85 15/16" (2199)
84 3/4" (2169)
84 1/8" (2144)

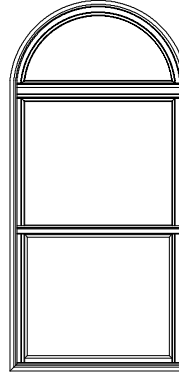

75TB4269-R

44 1/8" (1121)
42" (1067)
41 1/2" (1054)
36 3/4" (933)
35 7/16" (900)
37 1/8" (943)

95 1/2" (2426)
93 3/8" (2372)
92 7/8" (2359)
87 7/16" (2241)
86 1/4" (2211)
85 1/8" (2186)

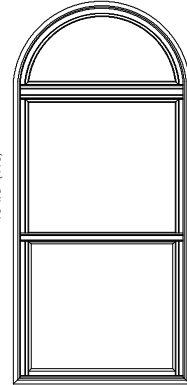

75TB4272-R

UNIT SIZE
ROUGH OPENING
FRAME SIZE
DAYLIGHT OPENING

44 1/8" (1121)
42" (1067)
41 1/2" (1054)
36 3/4" (933)
35 7/16" (900)
37 1/8" (943)

97 1/2" (2477)
95 3/8" (2423)
94 7/8" (2410)
91 7/16" (2334)
90 1/4" (2304)
89 1/8" (2279)

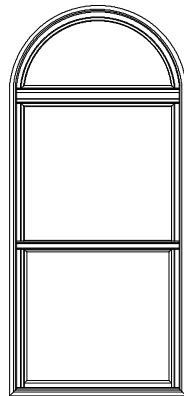

75TB4274-R

44 1/8" (1121)
42" (1067)
41 1/2" (1054)
36 3/4" (933)
35 7/16" (900)
37 1/8" (943)

100 1/2" (2553)
98 3/8" (2499)
97 7/8" (2486)
94 15/16" (2402)
93 3/4" (2372)
92 1/8" (2347)

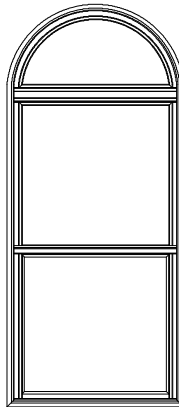

75TB4277-R

ELEVATION SYMBOL LEGEND:

VALUES IN () ARE IN MILLIMETER CONVERSIONS
VALUES IN [] ARE NUMBER OF DAYLIGHT OPENINGS PER UNIT

Note: Elevations shown DO NOT have exterior trim. Subtract 1/2" (12.7) from M.O. (Masonry Opening) for Unit Sizes. Masonry Openings above include Sill Nose, see Trim Options page for Sill Nose specifications. For other Trim Options refer to the Unit Sizing, Rough Opening & Masonry Openings page.

SCALE: 1/4" = 1'

SINGLE-HUNG UNITS WITH HALF ROUND

UNIT SIZE
ROUGH OPENING
FRAME SIZE
DAYLIGHT OPENING

48 1/8" (1222)
46" (1168)
45 1/2" (1156)
40 3/4" (1035)
39 7/16" (1002)
41 1/8" (1045)

61 1/2" (1562)
59 3/8" (1508)
58 7/8" (1495)
14 7/16" (367)
13 1/4" (337)
18 1/8" (460)

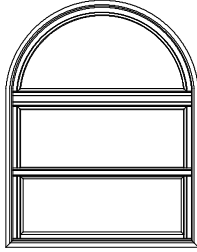

75TB4636-R

48 1/8" (1222)
46" (1168)
45 1/2" (1156)
40 3/4" (1035)
39 7/16" (1002)
41 1/8" (1045)

62 1/2" (1588)
60 3/8" (1534)
59 7/8" (1581)
14 15/16" (379)
13 3/4" (349)
18 1/8" (460)

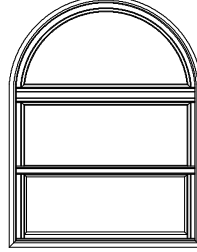

75TB4637-R

48 1/8" (1222)
46" (1168)
45 1/2" (1156)
40 3/4" (1035)
39 7/16" (1002)
41 1/8" (1045)

63 1/2" (1613)
61 3/8" (1559)
60 7/8" (1546)
15 7/16" (392)
14 1/4" (362)
18 1/8" (460)

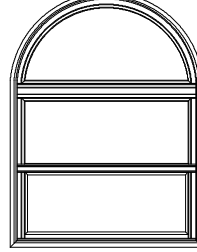

75TB4638-R

48 1/8" (1222)
46" (1168)
45 1/2" (1156)
40 3/4" (1035)
39 7/16" (1002)
41 1/8" (1045)

66 1/2" (1689)
64 3/8" (1635)
63 7/8" (1622)
16 15/16" (430)
15 3/4" (400)
18 1/8" (460)

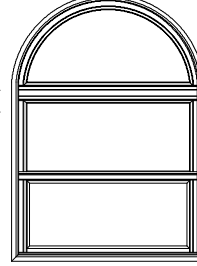

75TB4641-R

UNIT SIZE
ROUGH OPENING
FRAME SIZE
DAYLIGHT OPENING

48 1/8" (1222)
46" (1168)
45 1/2" (1156)
40 3/4" (1035)
39 7/16" (1002)
41 1/8" (1045)

67 1/2" (1715)
65 3/8" (1660)
64 7/8" (1648)
17 7/16" (443)
16 1/4" (413)
18 1/8" (460)

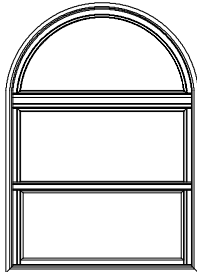

75TB4642-R

48 1/8" (1222)
46" (1168)
45 1/2" (1156)
40 3/4" (1035)
39 7/16" (1002)
41 1/8" (1045)

73 1/2" (1867)
71 3/8" (1813)
80 7/8" (1800)
20 7/16" (519)
19 1/4" (489)
18 1/8" (460)

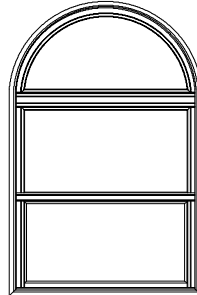

75TB4648-R

48 1/8" (1222)
46" (1168)
45 1/2" (1156)
40 3/4" (1035)
39 7/16" (1002)
41 1/8" (1045)

74 1/2" (1892)
72 3/8" (1838)
71 7/8" (1826)
20 15/16" (532)
19 3/4" (502)
18 1/8" (460)

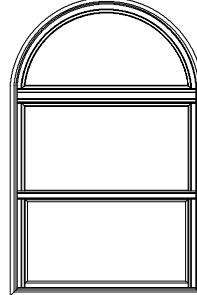

75TB4649-R

48 1/8" (1222)
46" (1168)
45 1/2" (1156)
40 3/4" (1035)
39 7/16" (1002)
41 1/8" (1045)

78 1/2" (1994)
76 3/8" (1940)
75 7/8" (1927)
22 15/16" (583)
21 3/4" (552)
18 1/8" (460)

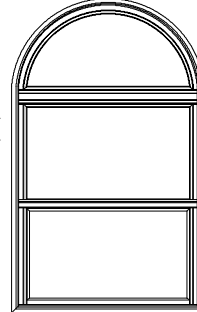

75TB4653-R

UNIT SIZE
ROUGH OPENING
FRAME SIZE
DAYLIGHT OPENING

48 1/8" (1222)
46" (1168)
45 1/2" (1156)
40 3/4" (1035)
39 7/16" (1002)
41 1/8" (1045)

79 1/2" (2019)
77 3/8" (1965)
76 7/8" (1953)
23 7/16" (595)
22 1/4" (565)
18 1/8" (460)

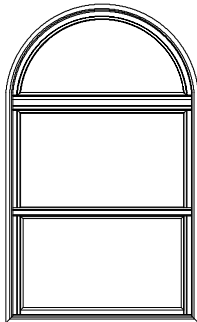

75TB4654-R

48 1/8" (1222)
46" (1168)
45 1/2" (1156)
40 3/4" (1035)
39 7/16" (1002)
41 1/8" (1045)

82 1/2" (2063)
80 3/8" (2042)
79 7/8" (2029)
24 15/16" (633)
23 3/4" (603)
18 1/8" (460)

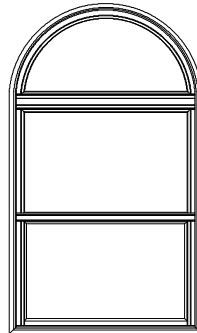

75TB4657-R

48 1/8" (1222)
46" (1168)
45 1/2" (1156)
40 3/4" (1035)
39 7/16" (1002)
41 1/8" (1045)

85 1/2" (2172)
83 3/8" (2118)
82 7/8" (2105)
26 7/16" (672)
25 1/4" (641)
18 1/8" (460)

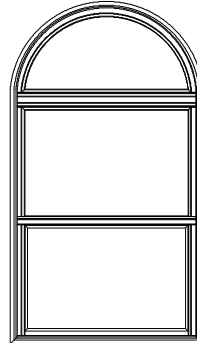

75TB4660-R

48 1/8" (1222)
46" (1168)
45 1/2" (1156)
40 3/4" (1035)
39 7/16" (1002)
41 1/8" (1045)

87 1/2" (2223)
85 3/8" (2169)
84 7/8" (2155)
27 7/16" (697)
26 1/4" (667)
18 1/8" (460)

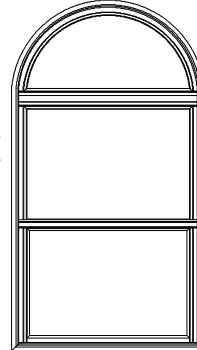

75TB4662-R

ELEVATION SYMBOL LEGEND:

VALUES IN () ARE IN MILLIMETER CONVERSIONS
VALUES IN [] ARE NUMBER OF DAYLIGHT OPENINGS PER UNIT

Note: Elevations shown DO NOT have exterior trim. Subtract 1/2" (12.7) from M.O. (Masonry Opening) for Unit Sizes. Masonry Openings above include Sill Nose, see Trim Options page for Sill Nose specifications. For other Trim Options refer to the Unit Sizing, Rough Opening & Masonry Openings page.

SCALE: 1/4" = 1'

SINGLE-HUNG UNITS WITH HALF ROUND

UNIT SIZE
ROUGH OPENING
FRAME SIZE
DAYLIGHT OPENING

48 1/8" (1222)
46" (1168)
45 1/2" (1156)
40 3/4" (1035)
39 7/16" (1002)
41 1/8" (1045)

90 1/2" (2299)
88 3/8" (2245)
87 7/8" (2232)
28 15/16" (735)
27 3/4" (705)
18 1/8" (460)

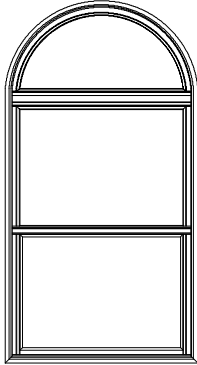

75TB4665-R

48 1/8" (1222)
46" (1168)
45 1/2" (1156)
40 3/4" (1035)
39 7/16" (1002)
41 1/8" (1045)

91 1/2" (2324)
89 3/8" (2270)
88 7/8" (2257)
29 7/16" (748)
28 1/4" (718)
18 1/8" (460)

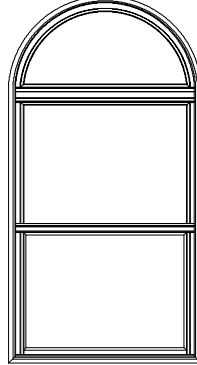

75TB4666-R

48 1/8" (1222)
46" (1168)
45 1/2" (1156)
40 3/4" (1035)
39 7/16" (1002)
41 1/8" (1045)

94 1/2" (2400)
92 3/8" (2346)
91 7/8" (2334)
30 15/16" (786)
29 3/4" (756)
18 1/8" (460)

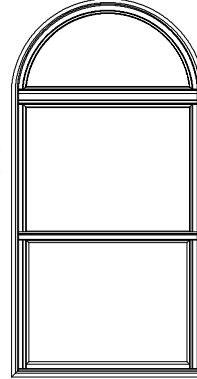

75TB4669-R

48 1/8" (1222)
46" (1168)
45 1/2" (1156)
40 3/4" (1035)
39 7/16" (1002)
41 1/8" (1045)

97 1/2" (2477)
95 3/8" (2423)
94 7/8" (2410)
32 7/16" (824)
31 1/4" (794)
18 1/8" (460)

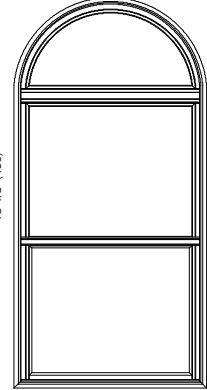

75TB4672-R

UNIT SIZE
ROUGH OPENING
FRAME SIZE
DAYLIGHT OPENING

48 1/8" (1222)
46" (1168)
45 1/2" (1156)
40 3/4" (1035)
39 7/16" (1002)
41 1/8" (1045)

99 1/2" (2527)
97 3/8" (2473)
96 7/8" (2461)
33 7/16" (849)
32 1/4" (819)
18 1/8" (460)

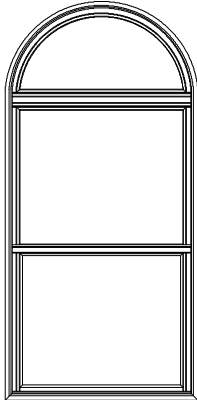

75TB4674-R

48 1/8" (1222)
46" (1168)
45 1/2" (1156)
40 3/4" (1035)
39 7/16" (1002)
41 1/8" (1045)

102 1/2" (2604)
100 3/8" (2550)
99 7/8" (2537)
34 15/16" (887)
33 3/4" (857)
18 1/8" (460)

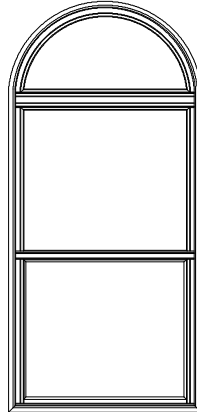

75TB4677-R

UNIT SIZE
ROUGH OPENING
FRAME SIZE
DAYLIGHT OPENING

50 1/8" (1273)
48" (1219)
47 1/2" (1207)
42 3/4" (1086)
41 7/16" (1053)
43 1/8" (1095)

63 1/2" (1613)
61 3/8" (1559)
60 7/8" (1546)
14 7/16" (367)
13 1/4" (337)
19 1/8" (486)

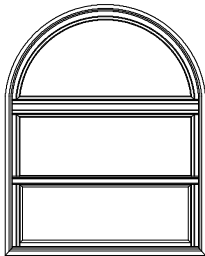

75TB4836-R

50 1/8" (1273)
48" (1219)
47 1/2" (1207)
42 3/4" (1086)
41 7/16" (1053)
43 1/8" (1095)

64 1/2" (1638)
62 3/8" (1584)
61 7/8" (1572)
14 15/16" (379)
13 3/4" (349)
19 1/8" (486)

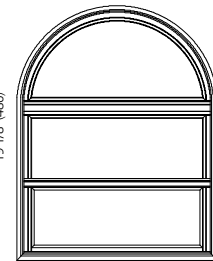

75TB4837-R

50 1/8" (1273)
48" (1219)
47 1/2" (1207)
42 3/4" (1086)
41 7/16" (1053)
43 1/8" (1095)

65 1/2" (1664)
63 3/8" (1609)
62 7/8" (1597)
15 7/16" (392)
14 1/4" (362)
19 1/8" (486)

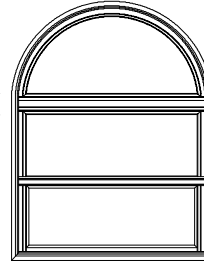

75TB4838-R

50 1/8" (1273)
48" (1219)
47 1/2" (1207)
42 3/4" (1086)
41 7/16" (1053)
43 1/8" (1095)

67 1/2" (1715)
65 3/8" (1660)
64 7/8" (1648)
16 15/16" (430)
15 3/4" (400)
19 1/8" (486)

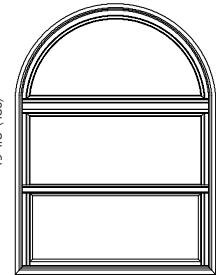

75TB4841-R

ELEVATION SYMBOL LEGEND:

VALUES IN () ARE IN MILLIMETER CONVERSIONS
VALUES IN [] ARE NUMBER OF DAYLIGHT OPENINGS PER UNIT

Note: Elevations shown DO NOT have exterior trim. Subtract 1/2" (12.7) from M.O. (Masonry Opening) for Unit Sizes. Masonry Openings above include Sill Nose, see Trim Options page for Sill Nose specifications. For other Trim Options refer to the Unit Sizing, Rough Opening & Masonry Openings page.

SCALE: 1/4" = 1'

SINGLE-HUNG UNITS WITH HALF ROUND

UNIT SIZE
ROUGH OPENING
FRAME SIZE
DAYLIGHT OPENING

50 1/8" (1273)
48" (1219)
47 1/2" (1207)
42 3/4" (1086)
41 7/16" (1053)
43 1/8" (1095)

68 1/2" (1740)
66 3/8" (1676)
65 7/8" (1673)
17 7/16" (443)
16 1/4" (413)
19 1/8" (486)

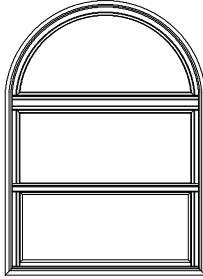

7STB4842-R

50 1/8" (1273)
48" (1219)
47 1/2" (1207)
42 3/4" (1086)
41 7/16" (1053)
43 1/8" (1095)

74 1/2" (1892)
72 3/8" (1838)
71 7/8" (1826)
20 7/16" (519)
19 1/4" (489)
19 1/8" (486)

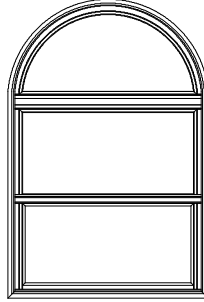

7STB4848-R

50 1/8" (1273)
48" (1219)
47 1/2" (1207)
42 3/4" (1086)
41 7/16" (1053)
43 1/8" (1095)

75 1/2" (1918)
73 3/8" (1864)
72 7/8" (1851)
20 15/16" (532)
19 3/4" (502)
19 1/8" (486)

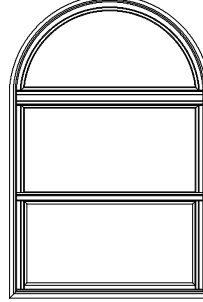

7STB4849-R

50 1/8" (1273)
48" (1219)
47 1/2" (1207)
42 3/4" (1086)
41 7/16" (1053)
43 1/8" (1095)

79 1/2" (2019)
77 3/8" (1965)
76 7/8" (1953)
22 15/16" (583)
21 3/4" (552)
19 1/8" (486)

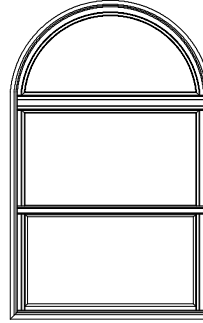

7STB4853-R

UNIT SIZE
ROUGH OPENING
FRAME SIZE
DAYLIGHT OPENING

50 1/8" (1273)
48" (1219)
47 1/2" (1207)
42 3/4" (1086)
41 7/16" (1053)
43 1/8" (1095)

80 1/2" (2045)
78 3/8" (1991)
77 7/8" (1978)
23 7/16" (595)
22 1/4" (565)
19 1/8" (486)

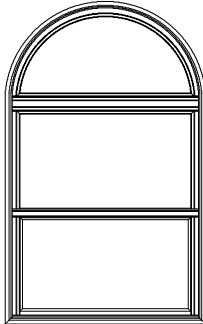

7STB4854-R

50 1/8" (1273)
48" (1219)
47 1/2" (1207)
42 3/4" (1086)
41 7/16" (1053)
43 1/8" (1095)

83 1/2" (2121)
81 3/8" (2067)
80 7/8" (2054)
24 15/16" (633)
23 3/4" (603)
19 1/8" (486)

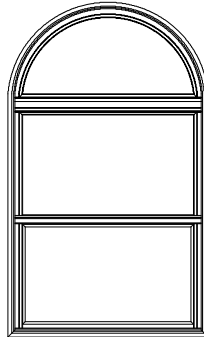

7STB4857-R

50 1/8" (1273)
48" (1219)
47 1/2" (1207)
42 3/4" (1086)
41 7/16" (1053)
43 1/8" (1095)

86 1/2" (2197)
84 3/8" (2143)
83 7/8" (2130)
26 7/16" (672)
25 1/4" (641)
19 1/8" (486)

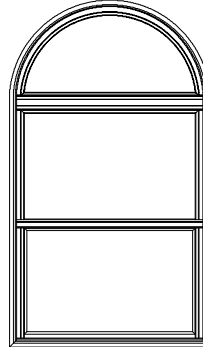

7STB4860-R

50 1/8" (1273)
48" (1219)
47 1/2" (1207)
42 3/4" (1086)
41 7/16" (1053)
43 1/8" (1095)

88 1/2" (2248)
86 3/8" (2194)
85 7/8" (2181)
27 7/16" (697)
26 1/4" (667)
19 1/8" (486)

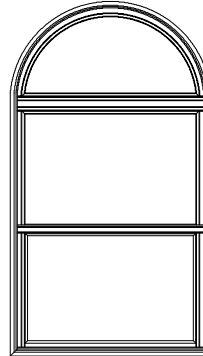

7STB4862-R

UNIT SIZE
ROUGH OPENING
FRAME SIZE
DAYLIGHT OPENING

50 1/8" (1273)
48" (1219)
47 1/2" (1207)
42 3/4" (1086)
41 7/16" (1053)
43 1/8" (1095)

91 1/2" (2324)
89 3/8" (2270)
88 7/8" (2257)
28 15/16" (735)
27 3/4" (705)
19 1/8" (486)

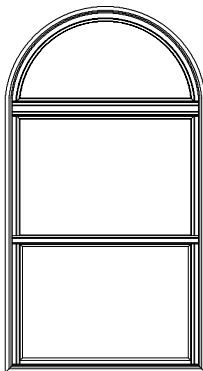

7STB4865-R

50 1/8" (1273)
48" (1219)
47 1/2" (1207)
42 3/4" (1086)
41 7/16" (1053)
43 1/8" (1095)

92 1/2" (2350)
90 3/8" (2296)
89 7/8" (2283)
29 7/16" (748)
28 1/4" (718)
19 1/8" (486)

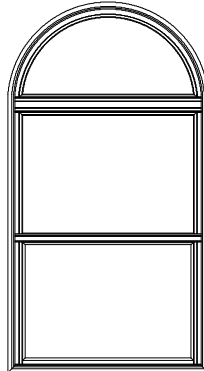

7STB4866-R

50 1/8" (1273)
48" (1219)
47 1/2" (1207)
42 3/4" (1086)
41 7/16" (1053)
43 1/8" (1095)

95 1/2" (2426)
93 3/8" (2372)
92 7/8" (2359)
30 15/16" (786)
29 3/4" (756)
19 1/8" (486)

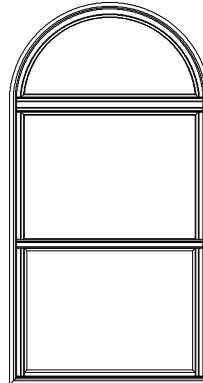

7STB4869-R

50 1/8" (1273)
48" (1219)
47 1/2" (1207)
42 3/4" (1086)
41 7/16" (1053)
43 1/8" (1095)

98 1/2" (2502)
96 3/8" (2448)
95 7/8" (2435)
32 7/16" (824)
31 1/4" (794)
19 1/8" (486)

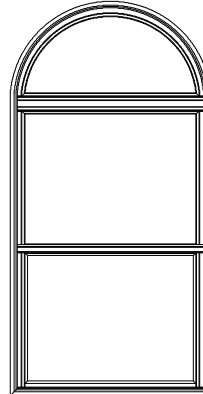

7STB4872-R

ELEVATION SYMBOL LEGEND:

VALUES IN () ARE IN MILLIMETER CONVERSIONS
VALUES IN [] ARE NUMBER OF DAYLIGHT OPENINGS PER UNIT

Note: Elevations shown DO NOT have exterior trim. Subtract 1/2" (12.7) from M.O. (Masonry Opening) for Unit Sizes. Masonry Openings above include Sill Nose, see Trim Options page for Sill Nose specifications. For other Trim Options refer to the Unit Sizing, Rough Opening & Masonry Openings page.

SCALE: 1/4" = 1'

SINGLE-HUNG UNITS WITH HALF ROUND

UNIT SIZE
ROUGH OPENING
FRAME SIZE
DAYLIGHT OPENING

50 1/8" (1273)
48" (1219)
47 1/2" (1207)
42 3/4" (1086)
41 7/16" (1053)
43 1/8" (1095)

50 1/8" (1273)
48" (1219)
47 1/2" (1207)
42 3/4" (1086)
41 7/16" (1053)
43 1/8" (1095)

100 1/2" (2553)
98 3/8" (2499)
97 7/8" (2486)
33 7/16" (849)
32 1/4" (819)
19 1/8" (486)

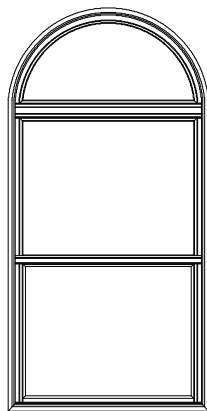

7STB4874-R

103 1/2" (2629)
101 3/8" (2575)
100 7/8" (2562)
34 15/16" (887)
33 3/4" (857)
19 1/8" (486)

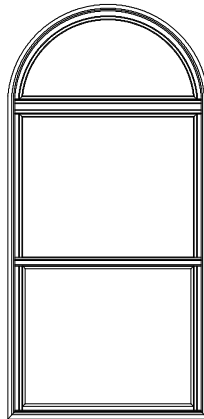

7STB4877-R











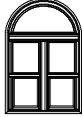





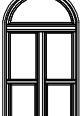



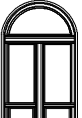
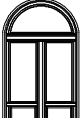

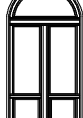

ELEVATION SYMBOL LEGEND:

VALUES IN () ARE IN MILLIMETER CONVERSIONS
VALUES IN [] ARE NUMBER OF DAYLIGHT OPENINGS PER UNIT

Note: Elevations shown DO NOT have exterior trim. Subtract 1/2" (12.7) from M.O. (Masonry Opening) for Unit Sizes. Masonry Openings above include Sill Nose, see Trim Options page for Sill Nose specifications. For other Trim Options refer to the Unit Sizing, Rough Opening & Masonry Openings page.

SCALE: 1/4" = 1'

2-WIDE SINGLE HUNG TILT WITH HALF ROUND

UNIT SIZE ROUGH OPENING FRAME SIZE DAYLIGHT OPENING	38 1/8" (968) 36" (914) 35 1/2" (902) 31 1/8" (791) 12 3/4" (324)[2] 11 7/16" (291)[2]	38 1/8" (968) 36" (914) 35 1/2" (902) 31 1/8" (791) 12 3/4" (324)[2] 11 7/16" (291)[2]	38 1/8" (968) 36" (914) 35 1/2" (902) 31 1/8" (791) 12 3/4" (324)[2] 11 7/16" (291)[2]	38 1/8" (968) 36" (914) 35 1/2" (902) 31 1/8" (791) 12 3/4" (324)[2] 11 7/16" (291)[2]	38 1/8" (968) 36" (914) 35 1/2" (902) 31 1/8" (791) 12 3/4" (324)[2] 11 7/16" (291)[2]	38 1/8" (968) 36" (914) 35 1/2" (902) 31 1/8" (791) 12 3/4" (324)[2] 11 7/16" (291)[2]	38 1/8" (968) 36" (914) 35 1/2" (902) 31 1/8" (791) 12 3/4" (324)[2] 11 7/16" (291)[2]				
56 1/2" (1435) 54 3/8" (1361) 53 7/8" (1368) 14 7/16" (367) 13 1/4" (337) 13 1/8" (333)	 75TB3636-2	57 1/2" (1460) 55 3/8" (1407) 54 7/8" (1394) 14 7/16" (379) 13 1/4" (349) 13 1/8" (333)	 75TB3637-2	58 1/2" (1486) 56 3/8" (1432) 55 7/8" (1419) 15 7/16" (392) 14 1/4" (362) 13 1/8" (333)	 75TB3638-2	61 1/2" (1562) 59 3/8" (1492) 58 7/8" (1485) 16 7/16" (430) 15 1/4" (400) 13 1/8" (333)	 75TB3641-2	62 1/2" (1588) 60 3/8" (1534) 59 7/8" (1531) 17 7/16" (443) 16 1/4" (413) 13 1/8" (333)	 75TB3642-2	68 1/2" (1740) 66 3/8" (1676) 65 7/8" (1673) 20 7/16" (519) 19 1/4" (489) 13 1/8" (333)	 75TB3648-2
UNIT SIZE ROUGH OPENING FRAME SIZE DAYLIGHT OPENING	38 1/8" (968) 36" (914) 35 1/2" (902) 31 1/8" (791) 12 3/4" (324)[2] 11 7/16" (291)[2]	38 1/8" (968) 36" (914) 35 1/2" (902) 31 1/8" (791) 12 3/4" (324)[2] 11 7/16" (291)[2]	38 1/8" (968) 36" (914) 35 1/2" (902) 31 1/8" (791) 12 3/4" (324)[2] 11 7/16" (291)[2]	38 1/8" (968) 36" (914) 35 1/2" (902) 31 1/8" (791) 12 3/4" (324)[2] 11 7/16" (291)[2]	38 1/8" (968) 36" (914) 35 1/2" (902) 31 1/8" (791) 12 3/4" (324)[2] 11 7/16" (291)[2]	38 1/8" (968) 36" (914) 35 1/2" (902) 31 1/8" (791) 12 3/4" (324)[2] 11 7/16" (291)[2]	38 1/8" (968) 36" (914) 35 1/2" (902) 31 1/8" (791) 12 3/4" (324)[2] 11 7/16" (291)[2]	38 1/8" (968) 36" (914) 35 1/2" (902) 31 1/8" (791) 12 3/4" (324)[2] 11 7/16" (291)[2]			
69 1/2" (1765) 67 3/8" (1711) 66 7/8" (1699) 20 15/16" (532) 19 3/4" (502) 13 1/8" (333)	 75TB3649-2	73 1/2" (1867) 71 3/8" (1813) 70 7/8" (1800) 22 7/16" (583) 21 1/4" (552) 13 1/8" (333)	 75TB3653-2	74 1/2" (1892) 72 3/8" (1838) 71 7/8" (1826) 23 7/16" (595) 22 1/4" (565) 13 1/8" (333)	 75TB3654-2	77 1/2" (1969) 75 3/8" (1915) 74 7/8" (1902) 24 7/16" (633) 23 1/4" (603) 13 1/8" (333)	 75TB3657-2	80 1/2" (2045) 78 3/8" (1991) 77 7/8" (1978) 26 7/16" (672) 25 1/4" (641) 13 1/8" (333)	 75TB3660-2	88 1/2" (2263) 86 3/8" (2209) 79 7/8" (2029) 27 7/16" (697) 26 1/4" (667) 13 1/8" (333)	 75TB3662-2
UNIT SIZE ROUGH OPENING FRAME SIZE DAYLIGHT OPENING	38 1/8" (968) 36" (914) 35 1/2" (902) 31 1/8" (791) 12 3/4" (324)[2] 11 7/16" (291)[2]	38 1/8" (968) 36" (914) 35 1/2" (902) 31 1/8" (791) 12 3/4" (324)[2] 11 7/16" (291)[2]	38 1/8" (968) 36" (914) 35 1/2" (902) 31 1/8" (791) 12 3/4" (324)[2] 11 7/16" (291)[2]	38 1/8" (968) 36" (914) 35 1/2" (902) 31 1/8" (791) 12 3/4" (324)[2] 11 7/16" (291)[2]	38 1/8" (968) 36" (914) 35 1/2" (902) 31 1/8" (791) 12 3/4" (324)[2] 11 7/16" (291)[2]	38 1/8" (968) 36" (914) 35 1/2" (902) 31 1/8" (791) 12 3/4" (324)[2] 11 7/16" (291)[2]	38 1/8" (968) 36" (914) 35 1/2" (902) 31 1/8" (791) 12 3/4" (324)[2] 11 7/16" (291)[2]	38 1/8" (968) 36" (914) 35 1/2" (902) 31 1/8" (791) 12 3/4" (324)[2] 11 7/16" (291)[2]			
85 1/2" (2172) 83 3/8" (2118) 82 7/8" (2105) 28 15/16" (735) 27 3/4" (705) 13 1/8" (333)	 75TB3665-2	86 1/2" (2197) 84 3/8" (2143) 83 7/8" (2130) 29 7/16" (748) 28 1/4" (718) 13 1/8" (333)	 75TB3666-2	89 1/2" (2273) 87 3/8" (2219) 86 7/8" (2207) 30 15/16" (786) 29 3/4" (756) 13 1/8" (333)	 75TB3669-2	93 1/2" (2350) 91 3/8" (2296) 89 7/8" (2283) 32 7/16" (824) 31 1/4" (794) 13 1/8" (333)	 75TB3672-2	94 1/2" (2400) 92 3/8" (2346) 91 7/8" (2334) 33 7/16" (849) 32 1/4" (819) 13 1/8" (333)	 75TB3674-2	97 1/2" (2477) 95 3/8" (2423) 94 7/8" (2410) 34 15/16" (887) 33 3/4" (857) 13 1/8" (333)	 75TB3677-2
UNIT SIZE ROUGH OPENING FRAME SIZE DAYLIGHT OPENING	42 1/8" (1070) 40" (1016) 39 1/2" (1003) 35 1/8" (892) 14 3/4" (375)[2] 13 7/16" (341)[2]	42 1/8" (1070) 40" (1016) 39 1/2" (1003) 35 1/8" (892) 14 3/4" (375)[2] 13 7/16" (341)[2]	42 1/8" (1070) 40" (1016) 39 1/2" (1003) 35 1/8" (892) 14 3/4" (375)[2] 13 7/16" (341)[2]	42 1/8" (1070) 40" (1016) 39 1/2" (1003) 35 1/8" (892) 14 3/4" (375)[2] 13 7/16" (341)[2]	42 1/8" (1070) 40" (1016) 39 1/2" (1003) 35 1/8" (892) 14 3/4" (375)[2] 13 7/16" (341)[2]	42 1/8" (1070) 40" (1016) 39 1/2" (1003) 35 1/8" (892) 14 3/4" (375)[2] 13 7/16" (341)[2]	42 1/8" (1070) 40" (1016) 39 1/2" (1003) 35 1/8" (892) 14 3/4" (375)[2] 13 7/16" (341)[2]	42 1/8" (1070) 40" (1016) 39 1/2" (1003) 35 1/8" (892) 14 3/4" (375)[2] 13 7/16" (341)[2]			
58 1/2" (1486) 56 3/8" (1432) 55 7/8" (1419) 14 7/16" (367) 13 1/4" (337) 15 1/8" (384)	 75TB4036-2	59 1/2" (1511) 57 3/8" (1457) 56 7/8" (1445) 14 7/16" (379) 13 1/4" (349) 15 1/8" (384)	 75TB4037-2	60 1/2" (1537) 58 3/8" (1483) 57 7/8" (1470) 15 7/16" (392) 14 1/4" (362) 15 1/8" (384)	 75TB4038-2	63 1/2" (1613) 61 3/8" (1559) 60 7/8" (1546) 16 7/16" (430) 15 1/4" (400) 15 1/8" (384)	 75TB4041-2	64 1/2" (1638) 62 3/8" (1584) 61 7/8" (1572) 17 7/16" (443) 16 1/4" (413) 15 1/8" (384)	 75TB4042-2		
UNIT SIZE ROUGH OPENING FRAME SIZE DAYLIGHT OPENING	42 1/8" (1070) 40" (1016) 39 1/2" (1003) 35 1/8" (892) 14 3/4" (375)[2] 13 7/16" (341)[2]	42 1/8" (1070) 40" (1016) 39 1/2" (1003) 35 1/8" (892) 14 3/4" (375)[2] 13 7/16" (341)[2]	42 1/8" (1070) 40" (1016) 39 1/2" (1003) 35 1/8" (892) 14 3/4" (375)[2] 13 7/16" (341)[2]	42 1/8" (1070) 40" (1016) 39 1/2" (1003) 35 1/8" (892) 14 3/4" (375)[2] 13 7/16" (341)[2]	42 1/8" (1070) 40" (1016) 39 1/2" (1003) 35 1/8" (892) 14 3/4" (375)[2] 13 7/16" (341)[2]	42 1/8" (1070) 40" (1016) 39 1/2" (1003) 35 1/8" (892) 14 3/4" (375)[2] 13 7/16" (341)[2]	42 1/8" (1070) 40" (1016) 39 1/2" (1003) 35 1/8" (892) 14 3/4" (375)[2] 13 7/16" (341)[2]	42 1/8" (1070) 40" (1016) 39 1/2" (1003) 35 1/8" (892) 14 3/4" (375)[2] 13 7/16" (341)[2]			
70 1/2" (1791) 68 3/8" (1737) 67 7/8" (1724) 20 7/16" (519) 19 1/4" (489) 15 1/8" (384)	 75TB4048-2	71 1/2" (1816) 69 3/8" (1762) 68 7/8" (1749) 20 15/16" (532) 19 3/4" (502) 15 1/8" (384)	 75TB4049-2	75 1/2" (1943) 73 3/8" (1889) 72 7/8" (1876) 22 7/16" (583) 21 1/4" (552) 15 1/8" (384)	 75TB4053-2	76 1/2" (1943) 74 3/8" (1889) 73 7/8" (1876) 23 7/16" (595) 22 1/4" (565) 15 1/8" (384)	 75TB4054-2	79 1/2" (2019) 77 3/8" (1965) 76 7/8" (1953) 24 7/16" (633) 23 1/4" (603) 15 1/8" (384)	 75TB4057-2		

ELEVATION SYMBOL LEGEND:
 VALUES IN () ARE IN MILLIMETER CONVERSIONS
 VALUES IN [] ARE NUMBER OF DAYLIGHT OPENINGS PER UNIT

Note: Elevations shown DO NOT have exterior trim. Subtract 1/2" (12.7) from M.O. (Masonry Opening) for Unit Sizes. Masonry Openings above include Sill Nose, see Trim Options page for Sill Nose specifications. For other Trim Options refer to the Unit Sizing, Rough Opening & Masonry Openings page.

SCALE: 1/8" = 1'

2-WIDE SINGLE HUNG TILT WITH HALF ROUND

UNIT SIZE 42 1/8"(1070)
ROUGH OPENING 40"(1016)
FRAME SIZE 39 1/2"(1003)
DAYLIGHT OPENING 35 1/8"(892)
14 3/4"(375)[2]
13 7/16"(341)[2]

82 1/2"(2063)
80 3/8"(2042)
79 7/8"(2029)
26 7/16"(672)
25 1/4"(641)
15 1/8"(384)

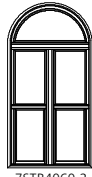

75TB4060-2

UNIT SIZE 42 1/8"(1070)
ROUGH OPENING 40"(1016)
FRAME SIZE 39 1/2"(1003)
DAYLIGHT OPENING 35 1/8"(892)
14 3/4"(375)[2]
13 7/16"(341)[2]

87 1/2"(2223)
85 3/8"(2169)
84 7/8"(2155)
28 15/16"(735)
27 3/4"(705)
15 1/8"(384)



75TB4062-2

UNIT SIZE 42 1/8"(1070)
ROUGH OPENING 40"(1016)
FRAME SIZE 39 1/2"(1003)
DAYLIGHT OPENING 35 1/8"(892)
14 3/4"(375)[2]
13 7/16"(341)[2]

88 1/2"(2248)
86 3/8"(2194)
85 7/8"(2181)
29 7/16"(748)
28 1/4"(718)
15 1/8"(384)



75TB4065-2

UNIT SIZE 42 1/8"(1070)
ROUGH OPENING 40"(1016)
FRAME SIZE 39 1/2"(1003)
DAYLIGHT OPENING 35 1/8"(892)
14 3/4"(375)[2]
13 7/16"(341)[2]

91 1/2"(2324)
89 3/8"(2270)
88 7/8"(2257)
30 15/16"(786)
29 3/4"(756)
15 1/8"(384)



75TB4066-2

UNIT SIZE 42 1/8"(1070)
ROUGH OPENING 40"(1016)
FRAME SIZE 39 1/2"(1003)
DAYLIGHT OPENING 35 1/8"(892)
14 3/4"(375)[2]
13 7/16"(341)[2]



75TB4069-2

UNIT SIZE 42 1/8"(1070)
ROUGH OPENING 40"(1016)
FRAME SIZE 39 1/2"(1003)
DAYLIGHT OPENING 35 1/8"(892)
14 3/4"(375)[2]
13 7/16"(341)[2]

94 1/2"(2400)
92 3/8"(2346)
91 7/8"(2334)
32 7/16"(824)
31 1/4"(794)
15 1/8"(384)

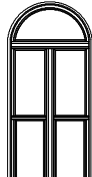

75TB4072-2

UNIT SIZE 42 1/8"(1070)
ROUGH OPENING 40"(1016)
FRAME SIZE 39 1/2"(1003)
DAYLIGHT OPENING 35 1/8"(892)
14 3/4"(375)[2]
13 7/16"(341)[2]

96 1/2"(2451)
94 3/8"(2397)
93 7/8"(2384)
33 7/16"(849)
32 1/4"(819)
15 1/8"(384)



75TB4074-2

UNIT SIZE 42 1/8"(1070)
ROUGH OPENING 40"(1016)
FRAME SIZE 39 1/2"(1003)
DAYLIGHT OPENING 35 1/8"(892)
14 3/4"(375)[2]
13 7/16"(341)[2]

99 1/2"(2527)
97 3/8"(2473)
96 7/8"(2461)
34 15/16"(887)
33 3/4"(857)
15 1/8"(384)



75TB4077-2

UNIT SIZE 46 1/8"(1172)
ROUGH OPENING 44"(1118)
FRAME SIZE 43 1/2"(1105)
DAYLIGHT OPENING 39 1/8"(994)
16 3/4"(425)[2]
15 7/16"(392)[2]

60 1/2"(1537)
58 3/8"(1483)
57 7/8"(1470)
14 7/16"(367)
13 1/4"(337)
17 1/8"(435)



75TB4436-2

UNIT SIZE 46 1/8"(1172)
ROUGH OPENING 44"(1118)
FRAME SIZE 43 1/2"(1105)
DAYLIGHT OPENING 39 1/8"(994)
16 3/4"(425)[2]
15 7/16"(392)[2]

62 1/2"(1588)
60 3/8"(1534)
59 7/8"(1521)
15 7/16"(392)
14 1/4"(362)
17 1/8"(435)



75TB4437-2

UNIT SIZE 46 1/8"(1172)
ROUGH OPENING 44"(1118)
FRAME SIZE 43 1/2"(1105)
DAYLIGHT OPENING 39 1/8"(994)
16 3/4"(425)[2]
15 7/16"(392)[2]

65 1/2"(1664)
63 3/8"(1610)
62 7/8"(1597)
16 7/16"(400)
15 1/4"(370)
17 1/8"(435)



75TB4438-2

UNIT SIZE 46 1/8"(1172)
ROUGH OPENING 44"(1118)
FRAME SIZE 43 1/2"(1105)
DAYLIGHT OPENING 39 1/8"(994)
16 3/4"(425)[2]
15 7/16"(392)[2]

66 1/2"(1689)
64 3/8"(1635)
63 7/8"(1622)
17 7/16"(443)
16 1/4"(413)
17 1/8"(435)



75TB4441-2

UNIT SIZE 46 1/8"(1172)
ROUGH OPENING 44"(1118)
FRAME SIZE 43 1/2"(1105)
DAYLIGHT OPENING 39 1/8"(994)
16 3/4"(425)[2]
15 7/16"(392)[2]

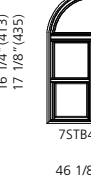

75TB4442-2

UNIT SIZE 46 1/8"(1172)
ROUGH OPENING 44"(1118)
FRAME SIZE 43 1/2"(1105)
DAYLIGHT OPENING 39 1/8"(994)
16 3/4"(425)[2]
15 7/16"(392)[2]

72 1/2"(1842)
70 3/8"(1788)
69 7/8"(1775)
20 7/16"(519)
19 1/4"(489)
17 1/8"(435)



75TB4448-2

UNIT SIZE 46 1/8"(1172)
ROUGH OPENING 44"(1118)
FRAME SIZE 43 1/2"(1105)
DAYLIGHT OPENING 39 1/8"(994)
16 3/4"(425)[2]
15 7/16"(392)[2]

73 1/2"(1867)
71 3/8"(1813)
70 7/8"(1800)
20 15/16"(532)
19 3/4"(502)
17 1/8"(435)



75TB4449-2

UNIT SIZE 46 1/8"(1172)
ROUGH OPENING 44"(1118)
FRAME SIZE 43 1/2"(1105)
DAYLIGHT OPENING 39 1/8"(994)
16 3/4"(425)[2]
15 7/16"(392)[2]

77 1/2"(1969)
75 3/8"(1915)
74 7/8"(1902)
22 7/16"(583)
21 1/4"(552)
17 1/8"(435)



75TB4453-2

UNIT SIZE 46 1/8"(1172)
ROUGH OPENING 44"(1118)
FRAME SIZE 43 1/2"(1105)
DAYLIGHT OPENING 39 1/8"(994)
16 3/4"(425)[2]
15 7/16"(392)[2]

78 1/2"(1994)
76 3/8"(1940)
75 7/8"(1927)
23 7/16"(595)
22 1/4"(565)
17 1/8"(435)



75TB4454-2

UNIT SIZE 46 1/8"(1172)
ROUGH OPENING 44"(1118)
FRAME SIZE 43 1/2"(1105)
DAYLIGHT OPENING 39 1/8"(994)
16 3/4"(425)[2]
15 7/16"(392)[2]

81 1/2"(2070)
79 3/8"(2016)
78 7/8"(2003)
24 7/16"(633)
23 1/4"(603)
17 1/8"(435)



75TB4457-2

UNIT SIZE 46 1/8"(1172)
ROUGH OPENING 44"(1118)
FRAME SIZE 43 1/2"(1105)
DAYLIGHT OPENING 39 1/8"(994)
16 3/4"(425)[2]
15 7/16"(392)[2]

84 1/2"(2146)
82 3/8"(2118)
81 7/8"(2080)
26 7/16"(672)
25 1/4"(641)
17 1/8"(435)

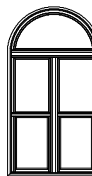

75TB4460-2

UNIT SIZE 46 1/8"(1172)
ROUGH OPENING 44"(1118)
FRAME SIZE 43 1/2"(1105)
DAYLIGHT OPENING 39 1/8"(994)
16 3/4"(425)[2]
15 7/16"(392)[2]

86 1/2"(2197)
84 3/8"(2143)
83 7/8"(2130)
27 7/16"(697)
26 1/4"(667)
17 1/8"(435)

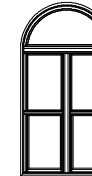

75TB4462-2

UNIT SIZE 46 1/8"(1172)
ROUGH OPENING 44"(1118)
FRAME SIZE 43 1/2"(1105)
DAYLIGHT OPENING 39 1/8"(994)
16 3/4"(425)[2]
15 7/16"(392)[2]

89 1/2"(2273)
87 3/8"(2219)
86 7/8"(2207)
28 15/16"(735)
27 3/4"(705)
17 1/8"(435)



75TB4465-2

UNIT SIZE 46 1/8"(1172)
ROUGH OPENING 44"(1118)
FRAME SIZE 43 1/2"(1105)
DAYLIGHT OPENING 39 1/8"(994)
16 3/4"(425)[2]
15 7/16"(392)[2]

90 1/2"(2299)
88 3/8"(2245)
87 7/8"(2232)
29 7/16"(748)
28 1/4"(718)
17 1/8"(435)



75TB4466-2

UNIT SIZE 46 1/8"(1172)
ROUGH OPENING 44"(1118)
FRAME SIZE 43 1/2"(1105)
DAYLIGHT OPENING 39 1/8"(994)
16 3/4"(425)[2]
15 7/16"(392)[2]

93 1/2"(2380)
91 3/8"(2321)
90 7/8"(2308)
30 15/16"(786)
29 3/4"(756)
17 1/8"(435)



75TB4469-2

ELEVATION SYMBOL LEGEND:
VALUES IN () ARE IN MILLIMETER CONVERSIONS
VALUES IN [] ARE NUMBER OF DAYLIGHT OPENINGS PER UNIT

Note: Elevations shown DO NOT have exterior trim. Subtract 1/2" (12.7) from M.O. (Masonry Opening) for Unit Sizes. Masonry Openings above include Sill Nose, see Trim Options page for Sill Nose specifications. For other Trim Options refer to the Unit Sizing, Rough Opening & Masonry Openings page.

SCALE: 1/8" = 1'

2-WIDE SINGLE HUNG TILT WITH HALF ROUND

UNIT SIZE 46 1/8"(1172)
ROUGH OPENING 44"(1118)
FRAME SIZE 43 1/2"(1105)
DAYLIGHT OPENING 39 1/8"(994)
16 3/4"(425)[2]
15 7/16"(392)[2]

96 1/2"(2451)
94 3/8"(2397)
93 7/8"(2384)
32 7/16"(824)
31 1/4"(794)
17 1/8"(435)



75TB4472-2

46 1/8"(1172)
44"(1118)
43 1/2"(1105)
39 1/8"(994)
16 3/4"(425)[2]
15 7/16"(392)[2]

98 1/2"(2502)
96 3/8"(2448)
95 7/8"(2435)
33 7/16"(849)
32 1/4"(819)
17 1/8"(435)



75TB4474-2

46 1/8"(1172)
44"(1118)
43 1/2"(1105)
39 1/8"(994)
16 3/4"(425)[2]
15 7/16"(392)[2]

101 1/2"(2578)
99 3/8"(2524)
98 7/8"(2511)
34 15/16"(887)
33 3/4"(857)
17 1/8"(435)



75TB4477-2

UNIT SIZE 50 1/8"(1273)
ROUGH OPENING 48"(1219)
FRAME SIZE 47 1/2"(1207)
DAYLIGHT OPENING 43 1/8"(1095)
18 3/4"(476)[2]
17 7/16"(443)[2]

62 1/2"(1588)
60 3/8"(1534)
59 7/8"(1521)
14 7/16"(367)
13 1/4"(337)
19 1/8"(486)



75TB4836-2

50 1/8"(1273)
48"(1219)
47 1/2"(1207)
43 1/8"(1095)
18 3/4"(476)[2]
17 7/16"(443)[2]

64 1/2"(1638)
62 3/8"(1584)
61 7/8"(1572)
15 7/16"(392)
14 1/4"(362)
19 1/8"(486)



75TB4837-2

50 1/8"(1273)
48"(1219)
47 1/2"(1207)
43 1/8"(1095)
18 3/4"(476)[2]
17 7/16"(443)[2]

67 1/2"(1715)
65 3/8"(1660)
64 7/8"(1648)
16 7/16"(430)
15 1/4"(400)
19 1/8"(486)



75TB4838-2

50 1/8"(1273)
48"(1219)
47 1/2"(1207)
43 1/8"(1095)
18 3/4"(476)[2]
17 7/16"(443)[2]

68 1/2"(1740)
66 3/8"(1676)
65 7/8"(1673)
17 7/16"(443)
16 1/4"(413)
19 1/8"(486)



75TB4841-2

50 1/8"(1273)
48"(1219)
47 1/2"(1207)
43 1/8"(1095)
18 3/4"(476)[2]
17 7/16"(443)[2]



75TB4842-2

UNIT SIZE 50 1/8"(1273)
ROUGH OPENING 48"(1219)
FRAME SIZE 47 1/2"(1207)
DAYLIGHT OPENING 43 1/8"(1095)
18 3/4"(476)[2]
17 7/16"(443)[2]

74 1/2"(1892)
72 3/8"(1838)
71 7/8"(1826)
20 7/16"(519)
19 1/4"(489)
19 1/8"(486)



75TB4848-2

50 1/8"(1273)
48"(1219)
47 1/2"(1207)
43 1/8"(1095)
18 3/4"(476)[2]
17 7/16"(443)[2]

75 1/2"(1918)
73 3/8"(1864)
72 7/8"(1851)
20 15/16"(532)
19 3/4"(502)
19 1/8"(486)



75TB4849-2

50 1/8"(1273)
48"(1219)
47 1/2"(1207)
43 1/8"(1095)
18 3/4"(476)[2]
17 7/16"(443)[2]

79 1/2"(2019)
77 3/8"(1965)
76 7/8"(1953)
22 7/16"(583)
21 3/4"(552)
19 1/8"(486)



75TB4853-2

50 1/8"(1273)
48"(1219)
47 1/2"(1207)
43 1/8"(1095)
18 3/4"(476)[2]
17 7/16"(443)[2]

80 1/2"(2045)
78 3/8"(1991)
77 7/8"(1978)
23 7/16"(595)
22 1/4"(565)
19 1/8"(486)



75TB4854-2

50 1/8"(1273)
48"(1219)
47 1/2"(1207)
43 1/8"(1095)
18 3/4"(476)[2]
17 7/16"(443)[2]

83 1/2"(2121)
81 3/8"(2067)
80 7/8"(2054)
24 7/16"(633)
23 1/4"(603)
19 1/8"(486)



75TB4857-2

UNIT SIZE 50 1/8"(1273)
ROUGH OPENING 48"(1219)
FRAME SIZE 47 1/2"(1207)
DAYLIGHT OPENING 43 1/8"(1095)
18 3/4"(476)[2]
17 7/16"(443)[2]

86 1/2"(2197)
84 3/8"(2143)
83 7/8"(2130)
26 7/16"(672)
25 1/4"(641)
19 1/8"(486)



75TB4860-2

50 1/8"(1273)
48"(1219)
47 1/2"(1207)
43 1/8"(1095)
18 3/4"(476)[2]
17 7/16"(443)[2]

88 1/2"(2248)
86 3/8"(2194)
85 7/8"(2181)
27 7/16"(697)
26 1/4"(667)
19 1/8"(486)

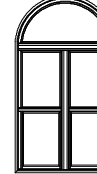

75TB4862-2

50 1/8"(1273)
48"(1219)
47 1/2"(1207)
43 1/8"(1095)
18 3/4"(476)[2]
17 7/16"(443)[2]

91 1/2"(2324)
89 3/8"(2270)
88 7/8"(2257)
28 15/16"(735)
27 3/4"(705)
19 1/8"(486)



75TB4865-2

50 1/8"(1273)
48"(1219)
47 1/2"(1207)
43 1/8"(1095)
18 3/4"(476)[2]
17 7/16"(443)[2]

92 1/2"(2350)
90 3/8"(2296)
89 7/8"(2283)
29 7/16"(748)
28 1/4"(718)
19 1/8"(486)



75TB4866-2

50 1/8"(1273)
48"(1219)
47 1/2"(1207)
43 1/8"(1095)
18 3/4"(476)[2]
17 7/16"(443)[2]

95 1/2"(2426)
93 3/8"(2372)
92 7/8"(2359)
30 15/16"(786)
29 3/4"(756)
19 1/8"(486)



75TB4869-2

UNIT SIZE 50 1/8"(1273)
ROUGH OPENING 48"(1219)
FRAME SIZE 47 1/2"(1207)
DAYLIGHT OPENING 43 1/8"(1095)
18 3/4"(476)[2]
17 7/16"(443)[2]

98 1/2"(2502)
96 3/8"(2448)
95 7/8"(2435)
32 7/16"(824)
31 1/4"(794)
19 1/8"(486)



75TB4872-2

50 1/8"(1273)
48"(1219)
47 1/2"(1207)
43 1/8"(1095)
18 3/4"(476)[2]
17 7/16"(443)[2]

100 1/2"(2553)
98 3/8"(2499)
97 7/8"(2486)
33 7/16"(849)
32 1/4"(819)



75TB4874-2

50 1/8"(1273)
48"(1219)
47 1/2"(1207)
43 1/8"(1095)
18 3/4"(476)[2]
17 7/16"(443)[2]

103 1/2"(2629)
101 3/8"(2575)
100 7/8"(2562)
34 15/16"(887)
33 3/4"(857)



75TB4877-2

ELEVATION SYMBOL LEGEND:
VALUES IN () ARE IN MILLIMETER CONVERSIONS
VALUES IN [] ARE NUMBER OF DAYLIGHT OPENINGS PER UNIT

Note: Elevations shown DO NOT have exterior trim. Subtract 1/2" (12.7) from M.O. (Masonry Opening) for Unit Sizes. Masonry Openings above include Sill Nose, see Trim Options page for Sill Nose specifications. For other Trim Options refer to the Unit Sizing, Rough Opening & Masonry Openings page.

SCALE: 1/8" = 1'

2-WIDE SINGLE HUNG TILT WITH HALF ROUND

UNIT SIZE
ROUGH OPENING
FRAME SIZE
DAYLIGHT OPENING

54 1/8" (1375)
52" (1321)
51 1/2" (1308)
47 1/8" (1197)
20 3/4" (527)[2]
19 7/16" (494)[2]

64 1/2" (1638)
62 3/8" (1584)
61 7/8" (1572)
14 7/16" (367)
13 1/4" (337)
21 1/8" (537)

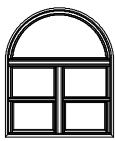

75TB5236-2

65 1/2" (1664)
63 3/8" (1609)
62 7/8" (1597)
14 7/16" (379)
13 1/4" (349)
21 1/8" (537)

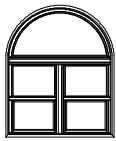

75TB5237-2

54 1/8" (1375)
52" (1321)
51 1/2" (1308)
47 1/8" (1197)
20 3/4" (527)[2]
19 7/16" (494)[2]

66 1/2" (1689)
64 3/8" (1635)
63 7/8" (1622)
15 7/16" (392)
14 1/4" (362)
21 1/8" (537)

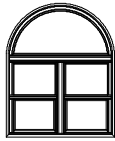

75TB5238-2

54 1/8" (1375)
52" (1321)
51 1/2" (1308)
47 1/8" (1197)
20 3/4" (527)[2]
19 7/16" (494)[2]

69 1/2" (1765)
67 3/8" (1711)
66 7/8" (1699)
16 7/16" (430)
15 1/4" (400)
21 1/8" (537)

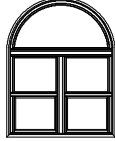

75TB5241-2

54 1/8" (1375)
52" (1321)
51 1/2" (1308)
47 1/8" (1197)
20 3/4" (527)[2]
19 7/16" (494)[2]

70 1/2" (1791)
68 3/8" (1737)
67 7/8" (1724)
17 7/16" (443)
16 1/4" (413)
21 1/8" (537)

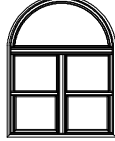

75TB5242-2

54 1/8" (1375)
52" (1321)
51 1/2" (1308)
47 1/8" (1197)
20 3/4" (527)[2]
19 7/16" (494)[2]

UNIT SIZE
ROUGH OPENING
FRAME SIZE
DAYLIGHT OPENING

54 1/8" (1375)
52" (1321)
51 1/2" (1308)
47 1/8" (1197)
20 3/4" (527)[2]
19 7/16" (494)[2]

76 1/2" (1943)
74 3/8" (1889)
73 7/8" (1876)
20 7/16" (519)
19 1/4" (489)
21 1/8" (537)

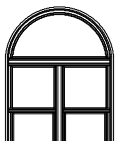

75TB5248-2

77 1/2" (1969)
75 3/8" (1915)
74 7/8" (1902)
20 15/16" (532)
19 3/4" (502)
21 1/8" (537)



75TB5249-2

54 1/8" (1375)
52" (1321)
51 1/2" (1308)
47 1/8" (1197)
20 3/4" (527)[2]
19 7/16" (494)[2]

81 1/2" (2070)
79 3/8" (2016)
78 7/8" (2003)
22 7/16" (583)
21 1/4" (552)
21 1/8" (537)

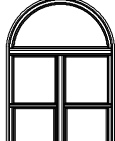

75TB5253-2

54 1/8" (1375)
52" (1321)
51 1/2" (1308)
47 1/8" (1197)
20 3/4" (527)[2]
19 7/16" (494)[2]

82 1/2" (2063)
80 3/8" (2009)
79 7/8" (2029)
23 7/16" (595)
22 1/4" (565)
21 1/8" (537)

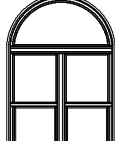

75TB5254-2

54 1/8" (1375)
52" (1321)
51 1/2" (1308)
47 1/8" (1197)
20 3/4" (527)[2]
19 7/16" (494)[2]

85 1/2" (2172)
83 3/8" (2118)
82 7/8" (2105)
24 7/16" (633)
23 1/4" (603)
21 1/8" (537)

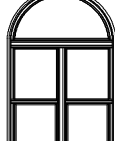

75TB5257-2

54 1/8" (1375)
52" (1321)
51 1/2" (1308)
47 1/8" (1197)
20 3/4" (527)[2]
19 7/16" (494)[2]

UNIT SIZE
ROUGH OPENING
FRAME SIZE
DAYLIGHT OPENING

54 1/8" (1375)
52" (1321)
51 1/2" (1308)
47 1/8" (1197)
20 3/4" (527)[2]
19 7/16" (494)[2]

88 1/2" (2248)
86 3/8" (2194)
85 7/8" (2181)
26 7/16" (672)
25 1/4" (641)
21 1/8" (537)

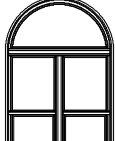

75TB5260-2

90 1/2" (2299)
88 3/8" (2245)
87 7/8" (2232)
27 7/16" (697)
26 1/4" (667)
21 1/8" (537)

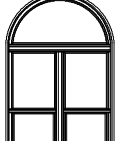

75TB5262-2

54 1/8" (1375)
52" (1321)
51 1/2" (1308)
47 1/8" (1197)
20 3/4" (527)[2]
19 7/16" (494)[2]

93 1/2" (2380)
91 3/8" (2326)
90 7/8" (2308)
28 15/16" (735)
27 3/4" (705)
21 1/8" (537)

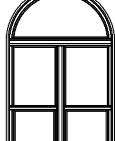

75TB5265-2

54 1/8" (1375)
52" (1321)
51 1/2" (1308)
47 1/8" (1197)
20 3/4" (527)[2]
19 7/16" (494)[2]

94 1/2" (2400)
92 3/8" (2346)
91 7/8" (2334)
29 7/16" (748)
28 1/4" (718)
21 1/8" (537)

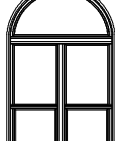

75TB5266-2

54 1/8" (1375)
52" (1321)
51 1/2" (1308)
47 1/8" (1197)
20 3/4" (527)[2]
19 7/16" (494)[2]

97 1/2" (2477)
95 3/8" (2423)
94 7/8" (2410)
30 15/16" (786)
29 3/4" (756)
21 1/8" (537)

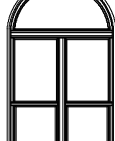

75TB5269-2

54 1/8" (1375)
52" (1321)
51 1/2" (1308)
47 1/8" (1197)
20 3/4" (527)[2]
19 7/16" (494)[2]

UNIT SIZE
ROUGH OPENING
FRAME SIZE
DAYLIGHT OPENING

54 1/8" (1375)
52" (1321)
51 1/2" (1308)
47 1/8" (1197)
20 3/4" (527)[2]
19 7/16" (494)[2]

100 1/2" (2553)
98 3/8" (2499)
97 7/8" (2486)
32 7/16" (824)
31 1/4" (794)
21 1/8" (537)

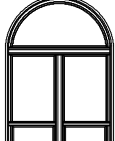

75TB5272-2

102 1/2" (2604)
100 3/8" (2550)
99 7/8" (2537)
33 7/16" (849)
32 1/4" (819)
21 1/8" (537)

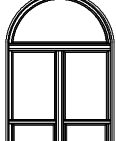

75TB5274-2

54 1/8" (1375)
52" (1321)
51 1/2" (1308)
47 1/8" (1197)
20 3/4" (527)[2]
19 7/16" (494)[2]

105 1/2" (2680)
103 3/8" (2626)
102 7/8" (2613)
34 15/16" (887)
33 3/4" (857)
21 1/8" (537)

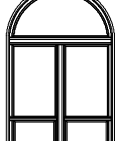

75TB5277-2

54 1/8" (1375)
52" (1321)
51 1/2" (1308)
47 1/8" (1197)
20 3/4" (527)[2]
19 7/16" (494)[2]

108 1/2" (2753)
106 3/8" (2699)
105 7/8" (2686)
35 7/16" (900)
34 1/4" (870)
21 1/8" (537)



75TB5280-2

54 1/8" (1375)
52" (1321)
51 1/2" (1308)
47 1/8" (1197)
20 3/4" (527)[2]
19 7/16" (494)[2]

110 1/2" (2814)
108 3/8" (2760)
107 7/8" (2747)
36 7/16" (921)
35 1/4" (891)
21 1/8" (537)



75TB5283-2

54 1/8" (1375)
52" (1321)
51 1/2" (1308)
47 1/8" (1197)
20 3/4" (527)[2]
19 7/16" (494)[2]

UNIT SIZE
ROUGH OPENING
FRAME SIZE
DAYLIGHT OPENING

58 1/8" (1476)
56" (1422)
55 1/2" (1410)
51 1/8" (1299)
22 3/4" (578)[2]
21 7/16" (545)[2]

66 1/2" (1689)
64 3/8" (1635)
63 7/8" (1622)
14 7/16" (367)
13 1/4" (337)
23 1/8" (587)



75TB5636-2

67 1/2" (1715)
65 3/8" (1660)
64 7/8" (1648)
14 7/16" (379)
13 1/4" (349)
23 1/8" (587)



75TB5637-2

58 1/8" (1476)
56" (1422)
55 1/2" (1410)
51 1/8" (1299)
22 3/4" (578)[2]
21 7/16" (545)[2]

68 1/2" (1740)
66 3/8" (1686)
65 7/8" (1673)
15 7/16" (392)
14 1/4" (362)
23 1/8" (587)



75TB5638-2

58 1/8" (1476)
56" (1422)
55 1/2" (1410)
51 1/8" (1299)
22 3/4" (578)[2]
21 7/16" (545)[2]

71 1/2" (1861)
69 3/8" (1762)
68 7/8" (1749)
16 7/16" (430)
15 1/4" (400)
23 1/8" (587)



75TB5641-2

58 1/8" (1476)
56" (1422)
55 1/2" (1410)
51 1/8" (1299)
22 3/4" (578)[2]
21 7/16" (545)[2]

72 1/2" (1842)
70 3/8" (1788)
69 7/8" (1775)
17 7/16" (443)
16 1/4" (413)
23 1/8" (587)

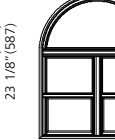

75TB5642-2

58 1/8" (1476)
56" (1422)
55 1/2" (1410)
51 1/8" (1299)
22 3/4" (578)[2]
21 7/16" (545)[2]

ELEVATION SYMBOL LEGEND:
VALUES IN () ARE IN MILLIMETER CONVERSIONS
VALUES IN [] ARE NUMBER OF DAYLIGHT OPENINGS PER UNIT

Note: Elevations shown DO NOT have exterior trim. Subtract 1/2" (12.7) from M.O. (Masonry Opening) for Unit Sizes. Masonry Openings above include Sill Nose, see Trim Options page for Sill Nose specifications. For other Trim Options refer to the Unit Sizing, Rough Opening & Masonry Openings page.

SCALE: 1/8" = 1'

2-WIDE SINGLE HUNG TILT WITH HALF ROUND

UNIT SIZE
ROUGH OPENING
FRAME SIZE
DAYLIGHT OPENING

58 1/8" (1476)
56" (1422)
55 1/2" (1410)
51 1/8" (1299)
22 3/4" (578)[2]
21 7/16" (545)[2]

78 1/2" (1994)
76 3/8" (1940)
75 7/8" (1927)
70 7/16" (1819)
69 1/4" (1765)
23 1/8" (587)



75TB5648-2

58 1/8" (1476)
56" (1422)
55 1/2" (1410)
51 1/8" (1299)
22 3/4" (578)[2]
21 7/16" (545)[2]

82 1/2" (2063)
80 3/8" (2042)
79 7/8" (2029)
72 7/16" (583)
21 1/4" (552)
23 1/8" (587)



75TB5649-2

58 1/8" (1476)
56" (1422)
55 1/2" (1410)
51 1/8" (1299)
22 3/4" (578)[2]
21 7/16" (545)[2]

83 1/2" (2121)
81 3/8" (2067)
80 7/8" (2054)
73 7/16" (595)
22 1/4" (565)
23 1/8" (587)



75TB5653-2

58 1/8" (1476)
56" (1422)
55 1/2" (1410)
51 1/8" (1299)
22 3/4" (578)[2]
21 7/16" (545)[2]

86 1/2" (2197)
84 3/8" (2143)
83 7/8" (2130)
74 7/16" (633)
23 1/4" (603)
23 1/8" (587)

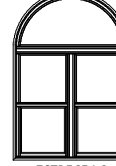

75TB5654-2

58 1/8" (1476)
56" (1422)
55 1/2" (1410)
51 1/8" (1299)
22 3/4" (578)[2]
21 7/16" (545)[2]

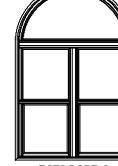

75TB5657-2

UNIT SIZE
ROUGH OPENING
FRAME SIZE
DAYLIGHT OPENING

58 1/8" (1476)
56" (1422)
55 1/2" (1410)
51 1/8" (1299)
22 3/4" (578)[2]
21 7/16" (545)[2]

89 1/2" (2273)
87 3/8" (2219)
86 7/8" (2207)
26 1/16" (672)
23 1/4" (603)
23 1/8" (587)



75TB5660-2

58 1/8" (1476)
56" (1422)
55 1/2" (1410)
51 1/8" (1299)
22 3/4" (578)[2]
21 7/16" (545)[2]

94 1/2" (2406)
92 3/8" (2346)
91 7/8" (2334)
28 15/16" (735)
27 3/4" (705)
23 1/8" (587)



75TB5662-2

58 1/8" (1476)
56" (1422)
55 1/2" (1410)
51 1/8" (1299)
22 3/4" (578)[2]
21 7/16" (545)[2]

95 1/2" (2426)
93 3/8" (2372)
92 7/8" (2359)
29 7/16" (748)
28 1/4" (718)
23 1/8" (587)



75TB5665-2

58 1/8" (1476)
56" (1422)
55 1/2" (1410)
51 1/8" (1299)
22 3/4" (578)[2]
21 7/16" (545)[2]

98 1/2" (2502)
96 3/8" (2448)
95 7/8" (2435)
30 15/16" (786)
29 3/4" (756)
23 1/8" (587)

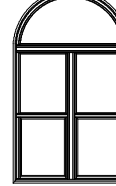

75TB5666-2

58 1/8" (1476)
56" (1422)
55 1/2" (1410)
51 1/8" (1299)
22 3/4" (578)[2]
21 7/16" (545)[2]

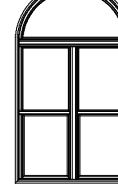

75TB5669-2

UNIT SIZE
ROUGH OPENING
FRAME SIZE
DAYLIGHT OPENING

58 1/8" (1476)
56" (1422)
55 1/2" (1410)
51 1/8" (1299)
22 3/4" (578)[2]
21 7/16" (545)[2]

102 1/2" (2604)
100 3/8" (2550)
99 7/8" (2537)
32 7/16" (824)
31 1/4" (794)
23 1/8" (587)

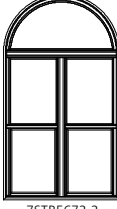

75TB5672-2

58 1/8" (1476)
56" (1422)
55 1/2" (1410)
51 1/8" (1299)
22 3/4" (578)[2]
21 7/16" (545)[2]

104 1/2" (2654)
102 3/8" (2600)
101 7/8" (2588)
33 7/16" (849)
32 1/4" (819)
23 1/8" (587)



75TB5674-2

58 1/8" (1476)
56" (1422)
55 1/2" (1410)
51 1/8" (1299)
22 3/4" (578)[2]
21 7/16" (545)[2]

107 1/2" (2731)
105 3/8" (2677)
104 7/8" (2664)
34 15/16" (887)
33 3/4" (857)
23 1/8" (587)

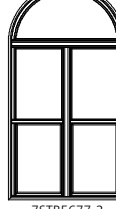

75TB5677-2

62 1/8" (1578)
60" (1524)
59 1/2" (1511)
55 1/8" (1400)
24 3/4" (629)[2]
23 7/16" (595)[2]

62 1/8" (1578)
60" (1524)
59 1/2" (1511)
55 1/8" (1400)
24 3/4" (629)[2]
23 7/16" (595)[2]



75TB6036-2

62 1/8" (1578)
60" (1524)
59 1/2" (1511)
55 1/8" (1400)
24 3/4" (629)[2]
23 7/16" (595)[2]



75TB6037-2

UNIT SIZE
ROUGH OPENING
FRAME SIZE
DAYLIGHT OPENING

62 1/8" (1578)
60" (1524)
59 1/2" (1511)
55 1/8" (1400)
24 3/4" (629)[2]
23 7/16" (595)[2]

68 1/2" (1740)
66 3/8" (1676)
65 7/8" (1673)
14 7/16" (367)
13 1/4" (333)
25 1/8" (638)



75TB6038-2

62 1/8" (1578)
60" (1524)
59 1/2" (1511)
55 1/8" (1400)
24 3/4" (629)[2]
23 7/16" (595)[2]

70 1/2" (1791)
68 3/8" (1737)
67 7/8" (1724)
15 7/16" (392)
14 1/4" (362)
25 1/8" (638)



75TB6041-2

62 1/8" (1578)
60" (1524)
59 1/2" (1511)
55 1/8" (1400)
24 3/4" (629)[2]
23 7/16" (595)[2]

73 1/2" (1867)
71 3/8" (1813)
70 7/8" (1800)
16 7/16" (430)
15 1/4" (400)
25 1/8" (638)



75TB6042-2

62 1/8" (1578)
60" (1524)
59 1/2" (1511)
55 1/8" (1400)
24 3/4" (629)[2]
23 7/16" (595)[2]

80 1/2" (2045)
78 3/8" (1991)
77 7/8" (1978)
20 7/16" (519)
19 1/4" (489)
25 1/8" (638)



75TB6043-2

62 1/8" (1578)
60" (1524)
59 1/2" (1511)
55 1/8" (1400)
24 3/4" (629)[2]
23 7/16" (595)[2]



75TB6044-2

UNIT SIZE
ROUGH OPENING
FRAME SIZE
DAYLIGHT OPENING

62 1/8" (1578)
60" (1524)
59 1/2" (1511)
55 1/8" (1400)
24 3/4" (629)[2]
23 7/16" (595)[2]

74 1/2" (1892)
72 3/8" (1838)
71 7/8" (1826)
17 7/16" (445)
16 1/4" (415)
25 1/8" (638)



75TB6048-2

62 1/8" (1578)
60" (1524)
59 1/2" (1511)
55 1/8" (1400)
24 3/4" (629)[2]
23 7/16" (595)[2]

81 1/2" (2070)
79 3/8" (2016)
78 7/8" (2003)
20 15/16" (532)
19 3/4" (502)
25 1/8" (638)



75TB6049-2

62 1/8" (1578)
60" (1524)
59 1/2" (1511)
55 1/8" (1400)
24 3/4" (629)[2]
23 7/16" (595)[2]

85 1/2" (2172)
83 3/8" (2118)
82 7/8" (2105)
22 7/16" (583)
21 1/4" (552)
25 1/8" (638)



75TB6053-2

62 1/8" (1578)
60" (1524)
59 1/2" (1511)
55 1/8" (1400)
24 3/4" (629)[2]
23 7/16" (595)[2]

85 1/2" (2172)
83 3/8" (2118)
82 7/8" (2105)
22 7/16" (583)
21 1/4" (552)
25 1/8" (638)

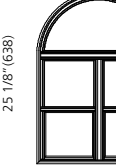

75TB6054-2

62 1/8" (1578)
60" (1524)
59 1/2" (1511)
55 1/8" (1400)
24 3/4" (629)[2]
23 7/16" (595)[2]



75TB6055-2

ELEVATION SYMBOL LEGEND:

VALUES IN () ARE IN MILLIMETER CONVERSIONS
VALUES IN [] ARE NUMBER OF DAYLIGHT OPENINGS PER UNIT

Note: Elevations shown DO NOT have exterior trim. Subtract 1/2" (12.7) from M.O. (Masonry Opening) for Unit Sizes. Masonry Openings above include Sill Nose, see Trim Options page for Sill Nose specifications. For other Trim Options refer to the Unit Sizing, Rough Opening & Masonry Openings page.

SCALE: 1/8" = 1'

2-WIDE SINGLE HUNG TILT WITH HALF ROUND

UNIT SIZE 62 1/8" (1578)
ROUGH OPENING 60" (1524)
FRAME SIZE 59 1/2" (1511)
DAYLIGHT OPENING 55 1/8" (1400)
24 3/4" (629)[2]
23 7/16" (595)[2]

86 1/2" (2197)
84 3/8" (2143)
83 7/8" (2130)
23 7/16" (595)
22 1/4" (565)
25 1/8" (638)



7STB6054-2

UNIT SIZE 62 1/8" (1578)
ROUGH OPENING 60" (1524)
FRAME SIZE 59 1/2" (1511)
DAYLIGHT OPENING 55 1/8" (1400)
24 3/4" (629)[2]
23 7/16" (595)[2]

89 1/2" (2273)
87 3/8" (2219)
86 7/8" (2207)
24 7/16" (633)
23 1/4" (603)
25 1/8" (638)

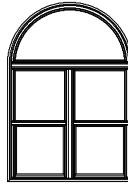

7STB6057-2

UNIT SIZE 62 1/8" (1578)
ROUGH OPENING 60" (1524)
FRAME SIZE 59 1/2" (1511)
DAYLIGHT OPENING 55 1/8" (1400)
24 3/4" (629)[2]
23 7/16" (595)[2]

92 1/2" (2350)
90 3/8" (2296)
89 7/8" (2283)
26 7/16" (672)
25 1/4" (641)
25 1/8" (638)

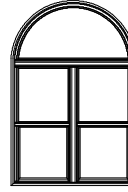

7STB6060-2

UNIT SIZE 62 1/8" (1578)
ROUGH OPENING 60" (1524)
FRAME SIZE 59 1/2" (1511)
DAYLIGHT OPENING 55 1/8" (1400)
24 3/4" (629)[2]
23 7/16" (595)[2]

94 1/2" (2400)
92 3/8" (2346)
91 7/8" (2334)
27 7/16" (697)
26 1/4" (667)
25 1/8" (638)

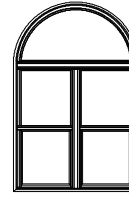

7STB6062-2

UNIT SIZE 62 1/8" (1578)
ROUGH OPENING 60" (1524)
FRAME SIZE 59 1/2" (1511)
DAYLIGHT OPENING 55 1/8" (1400)
24 3/4" (629)[2]
23 7/16" (595)[2]

97 1/2" (2477)
95 3/8" (2423)
94 7/8" (2410)
28 15/16" (735)
27 3/4" (705)
25 1/8" (638)

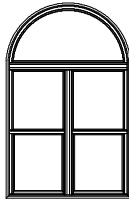

7STB6065-2

UNIT SIZE 62 1/8" (1578)
ROUGH OPENING 60" (1524)
FRAME SIZE 59 1/2" (1511)
DAYLIGHT OPENING 55 1/8" (1400)
24 3/4" (629)[2]
23 7/16" (595)[2]

98 1/2" (2502)
96 3/8" (2448)
95 7/8" (2435)
29 7/16" (748)
28 1/4" (718)
25 1/8" (638)

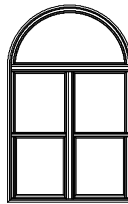

7STB6066-2

UNIT SIZE 62 1/8" (1578)
ROUGH OPENING 60" (1524)
FRAME SIZE 59 1/2" (1511)
DAYLIGHT OPENING 55 1/8" (1400)
24 3/4" (629)[2]
23 7/16" (595)[2]

101 1/2" (2578)
99 3/8" (2524)
98 7/8" (2511)
30 15/16" (786)
29 3/4" (756)
25 1/8" (638)

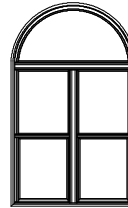

7STB6069-2

UNIT SIZE 62 1/8" (1578)
ROUGH OPENING 60" (1524)
FRAME SIZE 59 1/2" (1511)
DAYLIGHT OPENING 55 1/8" (1400)
24 3/4" (629)[2]
23 7/16" (595)[2]

104 1/2" (2654)
102 3/8" (2600)
101 7/8" (2588)
32 7/16" (824)
31 1/4" (794)
25 1/8" (638)

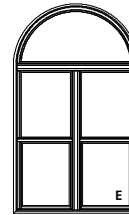

7STB6072-2

UNIT SIZE 62 1/8" (1578)
ROUGH OPENING 60" (1524)
FRAME SIZE 59 1/2" (1511)
DAYLIGHT OPENING 55 1/8" (1400)
24 3/4" (629)[2]
23 7/16" (595)[2]

106 1/2" (2705)
104 3/8" (2651)
103 7/8" (2638)
33 7/16" (849)
32 1/4" (819)
25 1/8" (638)

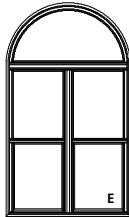

7STB6074-2

UNIT SIZE 62 1/8" (1578)
ROUGH OPENING 60" (1524)
FRAME SIZE 59 1/2" (1511)
DAYLIGHT OPENING 55 1/8" (1400)
24 3/4" (629)[2]
23 7/16" (595)[2]

109 1/2" (2781)
107 3/8" (2727)
106 7/8" (2715)
34 15/16" (887)
33 3/4" (857)
25 1/8" (638)

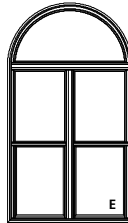

7STB6077-2

UNIT SIZE 66 1/8" (1680)
ROUGH OPENING 64" (1626)
FRAME SIZE 63 1/2" (1613)
DAYLIGHT OPENING 59 1/8" (1502)
26 3/4" (679)[2]
25 7/16" (646)[2]

70 1/2" (1791)
68 3/8" (1737)
67 7/8" (1724)
14 7/16" (367)
13 1/4" (337)
27 1/8" (689)

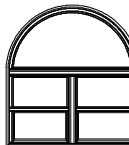

7STB6436-2

UNIT SIZE 66 1/8" (1680)
ROUGH OPENING 64" (1626)
FRAME SIZE 63 1/2" (1613)
DAYLIGHT OPENING 59 1/8" (1502)
26 3/4" (679)[2]
25 7/16" (646)[2]

71 1/2" (1861)
69 3/8" (1762)
68 7/8" (1749)
15 7/16" (375)
14 1/4" (345)
27 1/8" (689)

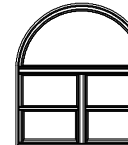

7STB6437-2

UNIT SIZE 66 1/8" (1680)
ROUGH OPENING 64" (1626)
FRAME SIZE 63 1/2" (1613)
DAYLIGHT OPENING 59 1/8" (1502)
26 3/4" (679)[2]
25 7/16" (646)[2]

72 1/2" (1842)
70 3/8" (1788)
69 7/8" (1775)
15 7/16" (392)
14 1/4" (362)
27 1/8" (689)



7STB6438-2

UNIT SIZE 66 1/8" (1680)
ROUGH OPENING 64" (1626)
FRAME SIZE 63 1/2" (1613)
DAYLIGHT OPENING 59 1/8" (1502)
26 3/4" (679)[2]
25 7/16" (646)[2]

75 1/2" (1918)
73 3/8" (1864)
72 7/8" (1851)
16 7/16" (430)
15 1/4" (400)
27 1/8" (689)



7STB6441-2

UNIT SIZE 66 1/8" (1680)
ROUGH OPENING 64" (1626)
FRAME SIZE 63 1/2" (1613)
DAYLIGHT OPENING 59 1/8" (1502)
26 3/4" (679)[2]
25 7/16" (646)[2]

76 1/2" (1943)
74 3/8" (1889)
73 7/8" (1876)
17 7/16" (443)
16 1/4" (413)
27 1/8" (689)

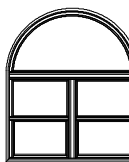

7STB6442-2

UNIT SIZE 66 1/8" (1680)
ROUGH OPENING 64" (1626)
FRAME SIZE 63 1/2" (1613)
DAYLIGHT OPENING 59 1/8" (1502)
26 3/4" (679)[2]
25 7/16" (646)[2]

82 1/2" (2063)
80 3/8" (2042)
79 7/8" (2029)
20 7/16" (525)
19 1/4" (489)
27 1/8" (689)



7STB6448-2

UNIT SIZE 66 1/8" (1680)
ROUGH OPENING 64" (1626)
FRAME SIZE 63 1/2" (1613)
DAYLIGHT OPENING 59 1/8" (1502)
26 3/4" (679)[2]
25 7/16" (646)[2]

83 1/2" (2121)
81 3/8" (2067)
80 7/8" (2054)
20 15/16" (532)
19 3/4" (502)
27 1/8" (689)



7STB6449-2

UNIT SIZE 66 1/8" (1680)
ROUGH OPENING 64" (1626)
FRAME SIZE 63 1/2" (1613)
DAYLIGHT OPENING 59 1/8" (1502)
26 3/4" (679)[2]
25 7/16" (646)[2]

87 1/2" (2223)
85 3/8" (2169)
84 7/8" (2155)
22 7/16" (583)
21 1/4" (552)
27 1/8" (689)



7STB6453-2

ELEVATION SYMBOL LEGEND:
VALUES IN () ARE IN MILLIMETER CONVERSIONS
VALUES IN [] ARE NUMBER OF DAYLIGHT OPENINGS PER UNIT

E BASIC UNIT CLEAR OPENING EXCEEDS 20" IN WIDTH, 24" IN HEIGHT & A MINIMUM OF 5.7 SQ. FT.

Note: Elevations shown DO NOT have exterior trim. Subtract 1/2" (12.7) from M.O. (Masonry Opening) for Unit Sizes. Masonry Openings above include Sill Nose, see Trim Options page for Sill Nose specifications. For other Trim Options refer to the Unit Sizing, Rough Opening & Masonry Openings page.

SCALE: 1/8" = 1'

2-WIDE SINGLE HUNG TILT WITH HALF ROUND

UNIT SIZE
ROUGH OPENING
FRAME SIZE
DAYLIGHT OPENING

66 1/8" (1680)
64" (1626)
63 1/2" (1613)
59 1/8" (1502)
26 3/4" (679)[2]
25 7/16" (646)[2]

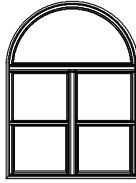

75TB6454-2

88 1/2" (2248)
86 3/8" (2194)
85 7/8" (2181)
23 7/16" (595)
22 1/4" (565)
27 1/8" (689)

91 1/2" (2324)
89 3/8" (2270)
88 7/8" (2257)
24 7/16" (623)
23 1/4" (603)
27 1/8" (689)

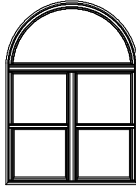

75TB6457-2

66 1/8" (1680)
64" (1626)
63 1/2" (1613)
59 1/8" (1502)
26 3/4" (679)[2]
25 7/16" (646)[2]

66 1/8" (1680)
64" (1626)
63 1/2" (1613)
59 1/8" (1502)
26 3/4" (679)[2]
25 7/16" (646)[2]

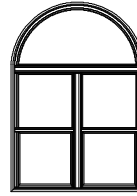

75TB6460-2

94 1/2" (2400)
92 3/8" (2346)
91 7/8" (2334)
26 7/16" (672)
25 1/4" (641)
27 1/8" (689)

66 1/8" (1680)
64" (1626)
63 1/2" (1613)
59 1/8" (1502)
26 3/4" (679)[2]
25 7/16" (646)[2]

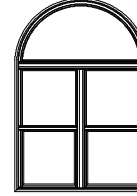

75TB6462-2

96 1/2" (2451)
94 3/8" (2397)
93 7/8" (2384)
27 7/16" (697)
26 1/4" (667)
27 1/8" (689)

UNIT SIZE
ROUGH OPENING
FRAME SIZE
DAYLIGHT OPENING

66 1/8" (1680)
64" (1626)
63 1/2" (1613)
59 1/8" (1502)
26 3/4" (679)[2]
25 7/16" (646)[2]

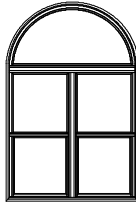

75TB6465-2

99 1/2" (2527)
97 3/8" (2473)
96 7/8" (2461)
28 15/16" (735)
27 3/4" (705)
27 1/8" (689)

100 1/2" (2553)
98 3/8" (2499)
97 7/8" (2486)
29 7/16" (748)
28 1/4" (718)
27 1/8" (689)

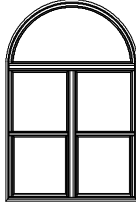

75TB6466-2

66 1/8" (1680)
64" (1626)
63 1/2" (1613)
59 1/8" (1502)
26 3/4" (679)[2]
25 7/16" (646)[2]

66 1/8" (1680)
64" (1626)
63 1/2" (1613)
59 1/8" (1502)
26 3/4" (679)[2]
25 7/16" (646)[2]

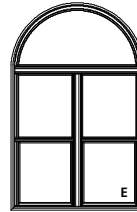

75TB6469-2

103 1/2" (2629)
101 3/8" (2575)
100 7/8" (2562)
30 15/16" (786)
29 3/4" (756)
27 1/8" (689)

66 1/8" (1680)
64" (1626)
63 1/2" (1613)
59 1/8" (1502)
26 3/4" (679)[2]
25 7/16" (646)[2]

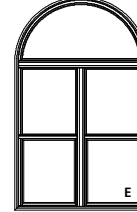

75TB6472-2

106 1/2" (2705)
104 3/8" (2651)
103 7/8" (2638)
32 7/16" (824)
31 1/4" (794)
27 1/8" (689)

UNIT SIZE
ROUGH OPENING
FRAME SIZE
DAYLIGHT OPENING

66 1/8" (1680)
64" (1626)
63 1/2" (1613)
59 1/8" (1502)
26 3/4" (679)[2]
25 7/16" (646)[2]

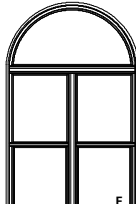

75TB6474-2

108 1/2" (2756)
106 3/8" (2702)
105 7/8" (2689)
33 7/16" (849)
32 1/4" (819)
27 1/8" (689)

111 1/2" (2832)
109 3/8" (2778)
108 7/8" (2765)
34 7/16" (887)
33 3/4" (857)
27 1/8" (689)

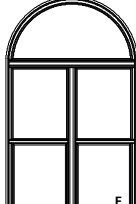

75TB6477-2

66 1/8" (1680)
64" (1626)
63 1/2" (1613)
59 1/8" (1502)
26 3/4" (679)[2]
25 7/16" (646)[2]

66 1/8" (1680)
64" (1626)
63 1/2" (1613)
59 1/8" (1502)
26 3/4" (679)[2]
25 7/16" (646)[2]

UNIT SIZE
ROUGH OPENING
FRAME SIZE
DAYLIGHT OPENING

70 1/8" (1781)
68" (1727)
67 1/2" (1715)
63 1/8" (1603)
28 3/4" (730)[2]
27 7/16" (697)[2]

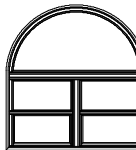

75TB6836-2

72 1/2" (1842)
70 3/8" (1788)
69 7/8" (1775)
14 7/16" (367)
13 1/4" (337)
29 1/8" (740)

73 1/2" (1867)
71 3/8" (1813)
70 7/8" (1800)
14 7/16" (379)
13 1/4" (349)
29 1/8" (740)

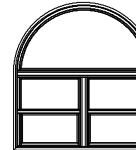

75TB6837-2

70 1/8" (1781)
68" (1727)
67 1/2" (1715)
63 1/8" (1603)
28 3/4" (730)[2]
27 7/16" (697)[2]

70 1/8" (1781)
68" (1727)
67 1/2" (1715)
63 1/8" (1603)
28 3/4" (730)[2]
27 7/16" (697)[2]



75TB6838-2

74 1/2" (1892)
72 3/8" (1838)
71 7/8" (1826)
15 7/16" (392)
14 1/4" (362)
29 1/8" (740)

70 1/8" (1781)
68" (1727)
67 1/2" (1715)
63 1/8" (1603)
28 3/4" (730)[2]
27 7/16" (697)[2]



75TB6841-2

77 1/2" (1969)
75 3/8" (1915)
74 7/8" (1902)
16 7/16" (430)
15 1/4" (400)
29 1/8" (740)

ELEVATION SYMBOL LEGEND:
VALUES IN () ARE IN MILLIMETER CONVERSIONS
VALUES IN [] ARE NUMBER OF DAYLIGHT OPENINGS PER UNIT

E BASIC UNIT CLEAR OPENING EXCEEDS 20" IN WIDTH, 24" IN HEIGHT & A MINIMUM OF 5.7 SQ. FT.

Note: Elevations shown DO NOT have exterior trim. Subtract 1/2" (12.7) from M.O. (Masonry Opening) for Unit Sizes. Masonry Openings above include Sill Nose, see Trim Options page for Sill Nose specifications. For other Trim Options refer to the Unit Sizing, Rough Opening & Masonry Openings page.

SCALE: 1/8" = 1'

2-WIDE SINGLE HUNG TILT WITH HALF ROUND

UNIT SIZE
ROUGH OPENING
FRAME SIZE
DAYLIGHT OPENING

70 1/8" (1781)
68" (1727)
67 1/2" (1715)
63 1/8" (1603)
28 3/4" (730)[2]
27 7/16" (697)[2]

78 1/2" (1994)
76 3/8" (1940)
75 7/8" (1927)
71 7/16" (443)
16 1/4" (413)
29 1/8" (740)

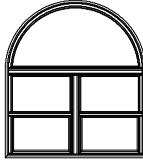

75TB6842-2

70 1/8" (1781)
68" (1727)
67 1/2" (1715)
63 1/8" (1603)
28 3/4" (730)[2]
27 7/16" (697)[2]

84 1/2" (2146)
82 3/8" (2118)
81 7/8" (2080)
20 7/16" (519)
19 1/4" (489)
29 1/8" (740)

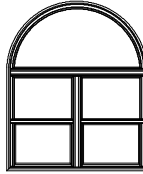

75TB6848-2

70 1/8" (1781)
68" (1727)
67 1/2" (1715)
63 1/8" (1603)
28 3/4" (730)[2]
27 7/16" (697)[2]

85 1/2" (2172)
83 3/8" (2118)
82 7/8" (2105)
20 15/16" (532)
19 3/4" (502)
29 1/8" (740)

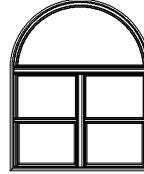

75TB6849-2

70 1/8" (1781)
68" (1727)
67 1/2" (1715)
63 1/8" (1603)
28 3/4" (730)[2]
27 7/16" (697)[2]

88 1/2" (2273)
87 3/8" (2218)
86 7/8" (2207)
29 7/16" (583)
21 1/4" (552)
29 1/8" (740)

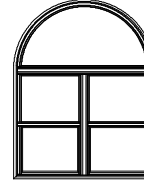

75TB6853-2

UNIT SIZE
ROUGH OPENING
FRAME SIZE
DAYLIGHT OPENING

70 1/8" (1781)
68" (1727)
67 1/2" (1715)
63 1/8" (1603)
28 3/4" (730)[2]
27 7/16" (697)[2]

90 1/2" (2299)
88 3/8" (2245)
87 7/8" (2232)
23 7/16" (595)
22 1/4" (565)
29 1/8" (740)

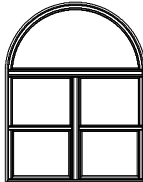

75TB6854-2

70 1/8" (1781)
68" (1727)
67 1/2" (1715)
63 1/8" (1603)
28 3/4" (730)[2]
27 7/16" (697)[2]

93 1/2" (2380)
91 3/8" (2321)
90 7/8" (2308)
24 7/16" (633)
23 1/4" (603)
29 1/8" (740)

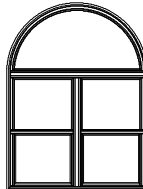

75TB6857-2

70 1/8" (1781)
68" (1727)
67 1/2" (1715)
63 1/8" (1603)
28 3/4" (730)[2]
27 7/16" (697)[2]

96 1/2" (2451)
94 3/8" (2397)
93 7/8" (2384)
26 7/16" (672)
25 1/4" (641)
29 1/8" (740)

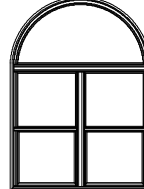

75TB6860-2

70 1/8" (1781)
68" (1727)
67 1/2" (1715)
63 1/8" (1603)
28 3/4" (730)[2]
27 7/16" (697)[2]

98 1/2" (2502)
96 3/8" (2448)
95 7/8" (2438)
27 7/16" (697)
26 1/4" (667)
29 1/8" (740)

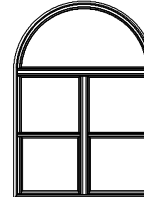

75TB6862-2

UNIT SIZE
ROUGH OPENING
FRAME SIZE
DAYLIGHT OPENING

70 1/8" (1781)
68" (1727)
67 1/2" (1715)
63 1/8" (1603)
28 3/4" (730)[2]
27 7/16" (697)[2]

101 1/2" (2578)
99 3/8" (2524)
98 7/8" (2511)
28 15/16" (735)
27 3/4" (705)
29 1/8" (740)

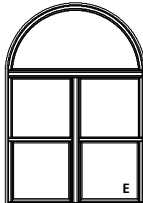

75TB6865-2

70 1/8" (1781)
68" (1727)
67 1/2" (1715)
63 1/8" (1603)
28 3/4" (730)[2]
27 7/16" (697)[2]

102 1/2" (2604)
100 3/8" (2550)
99 7/8" (2537)
29 7/16" (748)
28 1/4" (718)
29 1/8" (740)

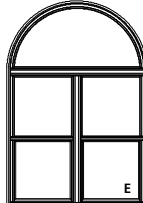

75TB6866-2

70 1/8" (1781)
68" (1727)
67 1/2" (1715)
63 1/8" (1603)
28 3/4" (730)[2]
27 7/16" (697)[2]

105 1/2" (2680)
103 3/8" (2626)
102 7/8" (2613)
30 15/16" (786)
29 3/4" (756)
29 1/8" (740)

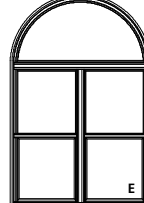

75TB6869-2

70 1/8" (1781)
68" (1727)
67 1/2" (1715)
63 1/8" (1603)
28 3/4" (730)[2]
27 7/16" (697)[2]

108 1/2" (2756)
106 3/8" (2702)
105 7/8" (2689)
32 7/16" (824)
31 1/4" (794)
29 1/8" (740)

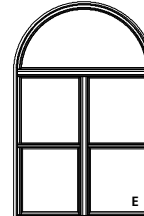

75TB6872-2

UNIT SIZE
ROUGH OPENING
FRAME SIZE
DAYLIGHT OPENING

70 1/8" (1781)
68" (1727)
67 1/2" (1715)
63 1/8" (1603)
28 3/4" (730)[2]
27 7/16" (697)[2]

110 1/2" (2807)
108 3/8" (2753)
107 7/8" (2740)
33 7/16" (849)
32 1/4" (819)
29 1/8" (740)

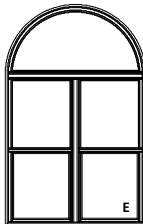

75TB6874-2

70 1/8" (1781)
68" (1727)
67 1/2" (1715)
63 1/8" (1603)
28 3/4" (730)[2]
27 7/16" (697)[2]

113 1/2" (2883)
111 3/8" (2829)
110 7/8" (2816)
34 15/16" (887)
33 3/4" (857)
29 1/8" (740)

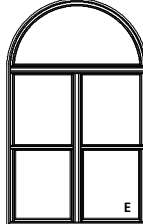

75TB6877-2

ELEVATION SYMBOL LEGEND:
VALUES IN () ARE IN MILLIMETER CONVERSIONS
VALUES IN [] ARE NUMBER OF DAYLIGHT OPENINGS PER UNIT

E BASIC UNIT CLEAR OPENING EXCEEDS 20" IN WIDTH, 24" IN HEIGHT & A MINIMUM OF 5.7 SQ. FT.

Note: Elevations shown DO NOT have exterior trim. Subtract 1/2" (12.7) from M.O. (Masonry Opening) for Unit Sizes. Masonry Openings above include Sill Nose, see Trim Options page for Sill Nose specifications. For other Trim Options refer to the Unit Sizing, Rough Opening & Masonry Openings page.

SCALE: 1/8" = 1'

2-WIDE SINGLE HUNG TILT WITH HALF ROUND

UNIT SIZE
ROUGH OPENING
FRAME SIZE
DAYLIGHT OPENING

74 1/8" (1883)
72" (1829)
71 1/2" (1861)
67 1/8" (1705)
30 3/4" (781)[2]
29 7/16" (748)[2]

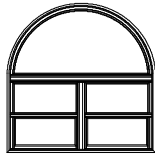

75TB7236-2

74 1/2" (1943)
73 3/8" (1889)
72 3/8" (1861)
71 7/8" (1876)
14 7/16" (379)
13 1/4" (349)
31 1/8" (791)

75 1/2" (1918)
73 3/8" (1864)
72 7/8" (1851)
14 7/16" (379)
13 1/4" (349)
31 1/8" (791)

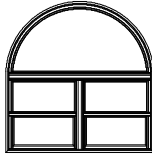

75TB7237-2

76 1/2" (1943)
74 3/8" (1889)
73 7/8" (1876)
15 7/16" (392)
14 1/4" (362)
31 1/8" (791)

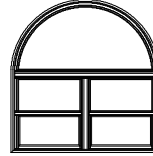

75TB7238-2

79 1/2" (2019)
77 3/8" (1965)
76 7/8" (1953)
16 7/16" (430)
15 1/4" (400)
31 1/8" (791)

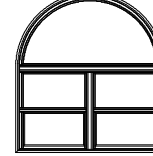

75TB7241-2

UNIT SIZE
ROUGH OPENING
FRAME SIZE
DAYLIGHT OPENING

74 1/8" (1883)
72" (1829)
71 1/2" (1861)
67 1/8" (1705)
30 3/4" (781)[2]
29 7/16" (748)[2]

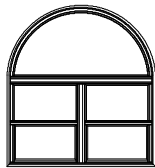

75TB7242-2

80 1/2" (2045)
78 3/8" (1991)
77 7/8" (1978)
17 7/16" (443)
16 1/4" (413)
31 1/8" (791)

86 1/2" (2197)
84 3/8" (2143)
83 7/8" (2130)
20 7/16" (519)
19 1/4" (489)
31 1/8" (791)

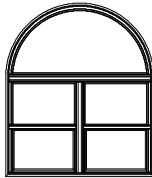

75TB7248-2

87 1/2" (2223)
85 3/8" (2169)
84 7/8" (2155)
20 15/16" (532)
19 3/4" (502)
31 1/8" (791)

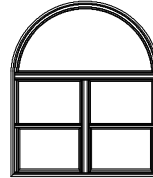

75TB7249-2

91 1/2" (2324)
89 3/8" (2270)
88 7/8" (2257)
22 7/16" (583)
21 1/4" (552)
31 1/8" (791)

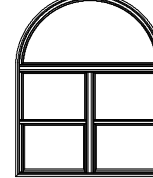

75TB7253-2

UNIT SIZE
ROUGH OPENING
FRAME SIZE
DAYLIGHT OPENING

74 1/8" (1883)
72" (1829)
71 1/2" (1861)
67 1/8" (1705)
30 3/4" (781)[2]
29 7/16" (748)[2]

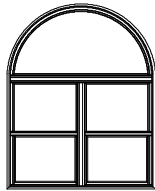

75TB7254-2

92 1/2" (2350)
90 3/8" (2296)
89 7/8" (2283)
23 7/16" (595)
22 1/4" (565)
31 1/8" (791)

95 1/2" (2426)
93 3/8" (2372)
92 7/8" (2359)
24 7/16" (635)
23 1/4" (605)
31 1/8" (791)

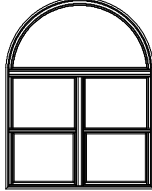

75TB7257-2

98 1/2" (2502)
96 3/8" (2448)
95 7/8" (2435)
26 7/16" (672)
25 1/4" (641)
31 1/8" (791)

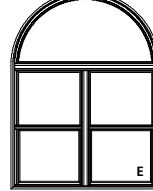

75TB7260-2

100 1/2" (2553)
98 3/8" (2499)
97 7/8" (2486)
27 7/16" (697)
26 1/4" (667)
31 1/8" (791)

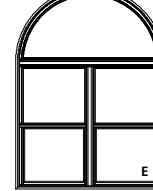

75TB7262-2

UNIT SIZE
ROUGH OPENING
FRAME SIZE
DAYLIGHT OPENING

74 1/8" (1883)
72" (1829)
71 1/2" (1861)
67 1/8" (1705)
30 3/4" (781)[2]
29 7/16" (748)[2]

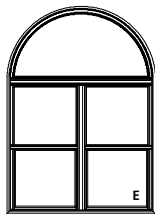

75TB7265-2

103 1/2" (2629)
101 3/8" (2575)
100 7/8" (2562)
28 15/16" (735)
27 3/4" (705)
31 1/8" (791)

104 1/2" (2654)
102 3/8" (2600)
101 7/8" (2588)
29 7/16" (748)
28 1/4" (718)
31 1/8" (791)

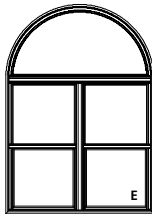

75TB7266-2

107 1/2" (2731)
105 3/8" (2677)
104 7/8" (2664)
30 15/16" (786)
29 3/4" (756)
31 1/8" (791)

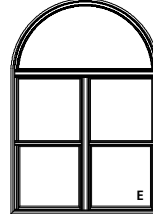

75TB7269-2

110 1/2" (2807)
108 3/8" (2753)
107 7/8" (2740)
32 7/16" (824)
31 1/4" (794)
31 1/8" (791)

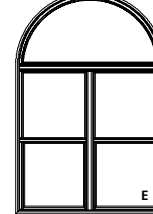

75TB7272-2

ELEVATION SYMBOL LEGEND:
VALUES IN () ARE IN MILLIMETER CONVERSIONS
VALUES IN [] ARE NUMBER OF DAYLIGHT OPENINGS PER UNIT

E BASIC UNIT CLEAR OPENING EXCEEDS 20" IN WIDTH, 24" IN HEIGHT & A MINIMUM OF 5.7 SQ. FT.

Note: Elevations shown DO NOT have exterior trim. Subtract 1/2" (12.7) from M.O. (Masonry Opening) for Unit Sizes. Masonry Openings above include Sill Nose, see Trim Options page for Sill Nose specifications. For other Trim Options refer to the Unit Sizing, Rough Opening & Masonry Openings page.

SCALE: 1/8" = 1'

2-WIDE SINGLE HUNG TILT WITH HALF ROUND

UNIT SIZE
ROUGH OPENING
FRAME SIZE
DAYLIGHT OPENING

74 1/8" (1883)
72" (1829)
71 1/2" (1861)
67 1/8" (1705)
30 3/4" (781)[2]
29 7/16" (748)[2]

74 1/8" (1883)
72" (1829)
71 1/2" (1861)
67 1/8" (1705)
30 3/4" (781)[2]
29 7/16" (748)[2]

112 1/2" (2858)
110 3/8" (2800)
109 7/8" (2791)
33 7/16" (849)
32 1/4" (819)
31 1/8" (791)

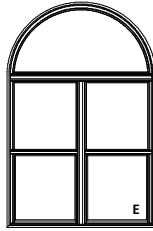

75TB7274-2

115 1/2" (2934)
113 3/8" (2880)
112 7/8" (2867)
34 15/16" (887)
33 3/4" (857)
31 1/8" (791)

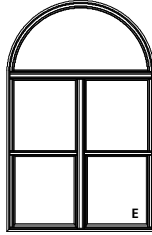

75TB7277-2

UNIT SIZE
ROUGH OPENING
FRAME SIZE
DAYLIGHT OPENING

78 1/8" (1984)
76" (1930)
75 1/2" (1918)
71 1/8" (1807)
32 3/4" (832)[2]
31 7/16" (799)[2]

78 1/8" (1984)
76" (1930)
75 1/2" (1918)
71 1/8" (1807)
32 3/4" (832)[2]
31 7/16" (799)[2]

78 1/8" (1984)
76" (1930)
75 1/2" (1918)
71 1/8" (1807)
32 3/4" (832)[2]
31 7/16" (799)[2]

78 1/8" (1984)
76" (1930)
75 1/2" (1918)
71 1/8" (1807)
32 3/4" (832)[2]
31 7/16" (799)[2]

76 1/2" (1943)
74 3/8" (1889)
73 7/8" (1876)
14 7/16" (367)
13 1/4" (337)
33 1/8" (841)

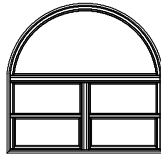

75TB7636-2

77 1/2" (1969)
75 3/8" (1915)
74 7/8" (1902)
14 7/16" (379)
13 1/4" (349)
33 1/8" (841)

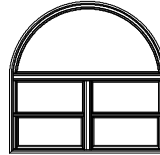

75TB7637-2

78 1/2" (1994)
76 3/8" (1940)
75 7/8" (1927)
15 7/16" (392)
14 1/4" (362)
33 1/8" (841)

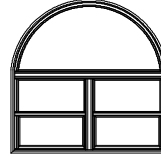

75TB7638-2

81 1/2" (2070)
79 3/8" (2016)
78 7/8" (2003)
16 7/16" (430)
15 1/4" (400)
33 1/8" (841)

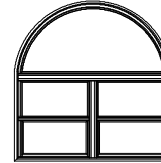

75TB7641-2

UNIT SIZE
ROUGH OPENING
FRAME SIZE
DAYLIGHT OPENING

78 1/8" (1984)
76" (1930)
75 1/2" (1918)
71 1/8" (1807)
32 3/4" (832)[2]
31 7/16" (799)[2]

78 1/8" (1984)
76" (1930)
75 1/2" (1918)
71 1/8" (1807)
32 3/4" (832)[2]
31 7/16" (799)[2]

78 1/8" (1984)
76" (1930)
75 1/2" (1918)
71 1/8" (1807)
32 3/4" (832)[2]
31 7/16" (799)[2]

78 1/8" (1984)
76" (1930)
75 1/2" (1918)
71 1/8" (1807)
32 3/4" (832)[2]
31 7/16" (799)[2]

82 1/2" (2063)
80 3/8" (2042)
79 7/8" (2029)
17 1/16" (443)
16 1/4" (413)
33 1/8" (841)

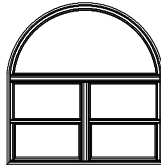

75TB7642-2

88 1/2" (2248)
86 3/8" (2194)
85 7/8" (2181)
20 7/16" (519)
19 1/4" (489)
33 1/8" (841)

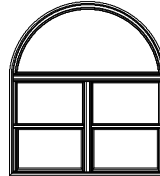

75TB7648-2

89 1/2" (2273)
87 3/8" (2219)
86 7/8" (2207)
20 15/16" (532)
19 3/4" (502)
33 1/8" (841)

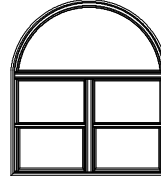

75TB7649-2

93 1/2" (2380)
91 3/8" (2321)
90 7/8" (2308)
22 7/16" (583)
21 1/4" (552)
33 1/8" (841)

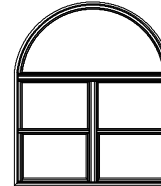

75TB7653-2

UNIT SIZE
ROUGH OPENING
FRAME SIZE
DAYLIGHT OPENING

78 1/8" (1984)
76" (1930)
75 1/2" (1918)
71 1/8" (1807)
32 3/4" (832)[2]
31 7/16" (799)[2]

78 1/8" (1984)
76" (1930)
75 1/2" (1918)
71 1/8" (1807)
32 3/4" (832)[2]
31 7/16" (799)[2]

78 1/8" (1984)
76" (1930)
75 1/2" (1918)
71 1/8" (1807)
32 3/4" (832)[2]
31 7/16" (799)[2]

78 1/8" (1984)
76" (1930)
75 1/2" (1918)
71 1/8" (1807)
32 3/4" (832)[2]
31 7/16" (799)[2]

94 1/2" (2400)
92 3/8" (2346)
91 7/8" (2334)
23 7/16" (595)
22 1/4" (565)
33 1/8" (841)

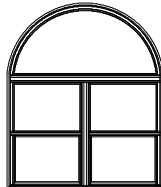

75TB7654-2

97 1/2" (2477)
95 3/8" (2423)
94 7/8" (2410)
24 7/16" (633)
23 1/4" (603)
33 1/8" (841)

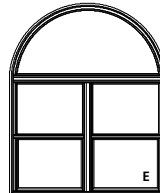

75TB7657-2

100 1/2" (2553)
98 3/8" (2499)
97 7/8" (2486)
26 7/16" (672)
25 1/4" (641)
33 1/8" (841)

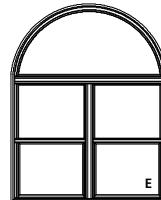

75TB7660-2

102 1/2" (2604)
100 3/8" (2550)
99 7/8" (2537)
27 7/16" (697)
26 1/4" (667)
33 1/8" (841)

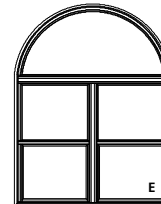

75TB7662-2

ELEVATION SYMBOL LEGEND:
VALUES IN () ARE IN MILLIMETER CONVERSIONS
VALUES IN [] ARE NUMBER OF DAYLIGHT OPENINGS PER UNIT

E BASIC UNIT CLEAR OPENING EXCEEDS 20" IN WIDTH, 24" IN HEIGHT & A MINIMUM OF 5.7 SQ. FT.

Note: Elevations shown DO NOT have exterior trim. Subtract 1/2" (12.7) from M.O. (Masonry Opening) for Unit Sizes. Masonry Openings above include Sill Nose, see Trim Options page for Sill Nose specifications. For other Trim Options refer to the Unit Sizing, Rough Opening & Masonry Openings page.

SCALE: 1/8" = 1'

2-WIDE SINGLE HUNG TILT WITH HALF ROUND

UNIT SIZE
ROUGH OPENING
FRAME SIZE
DAYLIGHT OPENING

78 1/8" (1984)
76" (1930)
75 1/2" (1918)
71 1/8" (1807)
32 3/4" (832)|2|
31 7/16" (799)|2|

105 1/2" (2680)
103 3/8" (2626)
102 7/8" (2613)
28 15/16" (735)
27 3/4" (705)
33 1/8" (841)

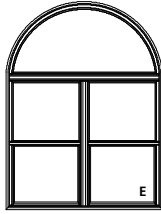

75TB7665-2

78 1/8" (1984)
76" (1930)
75 1/2" (1918)
71 1/8" (1807)
32 3/4" (832)|2|
31 7/16" (799)|2|

106 1/2" (2705)
104 3/8" (2651)
103 7/8" (2638)
29 7/16" (748)
28 1/2" (718)
33 1/8" (841)

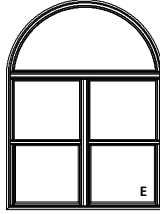

75TB7666-2

78 1/8" (1984)
76" (1930)
75 1/2" (1918)
71 1/8" (1807)
32 3/4" (832)|2|
31 7/16" (799)|2|

109 1/2" (2781)
107 3/8" (2727)
106 7/8" (2715)
30 15/16" (786)
29 3/4" (756)
33 1/8" (841)

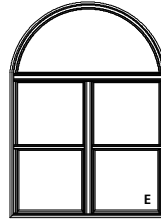

75TB7669-2

78 1/8" (1984)
76" (1930)
75 1/2" (1918)
71 1/8" (1807)
32 3/4" (832)|2|
31 7/16" (799)|2|

112 1/2" (2858)
110 3/8" (2804)
109 7/8" (2791)
32 7/16" (824)
31 1/4" (794)
33 1/8" (841)

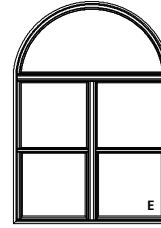

75TB7672-2

UNIT SIZE
ROUGH OPENING
FRAME SIZE
DAYLIGHT OPENING

78 1/8" (1984)
76" (1930)
75 1/2" (1918)
71 1/8" (1807)
32 3/4" (832)|2|
31 7/16" (799)|2|

114 1/2" (2908)
112 3/8" (2854)
111 7/8" (2842)
33 7/16" (849)
32 1/4" (819)
33 1/8" (841)

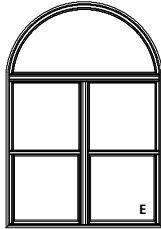

75TB7674-2

78 1/8" (1984)
76" (1930)
75 1/2" (1918)
71 1/8" (1807)
32 3/4" (832)|2|
31 7/16" (799)|2|

117 1/2" (2985)
115 3/8" (2931)
114 7/8" (2918)
33 15/16" (867)
33 3/4" (837)
33 1/8" (841)

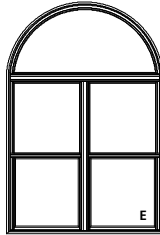

75TB7677-2

UNIT SIZE
ROUGH OPENING
FRAME SIZE
DAYLIGHT OPENING

86 1/8" (2188)
84" (2134)
83 1/2" (2121)
79 1/8" (2010)
36 3/4" (933)|2|
35 7/16" (900)|2|

80 1/2" (2045)
78 3/8" (1991)
77 7/8" (1978)
14 7/16" (367)
13 1/4" (337)
37 1/8" (943)

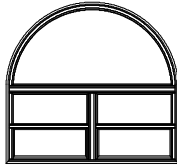

75TB8436-2

86 1/8" (2188)
84" (2134)
83 1/2" (2121)
79 1/8" (2010)
36 3/4" (933)|2|
35 7/16" (900)|2|

81 1/2" (2070)
79 3/8" (2016)
78 7/8" (2003)
14 7/16" (379)
13 1/4" (349)
37 1/8" (943)

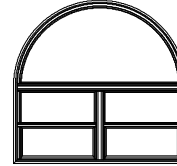

75TB8437-2

86 1/8" (2188)
84" (2134)
83 1/2" (2121)
79 1/8" (2010)
36 3/4" (933)|2|
35 7/16" (900)|2|

82 1/2" (2063)
80 3/8" (2009)
79 7/8" (2009)
15 7/16" (392)
14 1/4" (362)
37 1/8" (943)

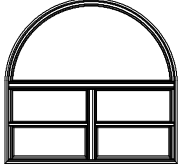

75TB8438-2

86 1/8" (2188)
84" (2134)
83 1/2" (2121)
79 1/8" (2010)
36 3/4" (933)|2|
35 7/16" (900)|2|

85 1/2" (2172)
83 3/8" (2118)
82 7/8" (2105)
16 7/16" (430)
15 1/4" (400)
37 1/8" (943)

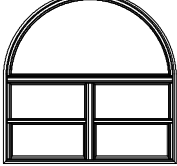

75TB8441-2

UNIT SIZE
ROUGH OPENING
FRAME SIZE
DAYLIGHT OPENING

86 1/8" (2188)
84" (2134)
83 1/2" (2121)
79 1/8" (2010)
36 3/4" (933)|2|
35 7/16" (900)|2|

86 1/2" (2197)
84 3/8" (2143)
83 7/8" (2130)
17 7/16" (443)
16 1/4" (413)
37 1/8" (943)

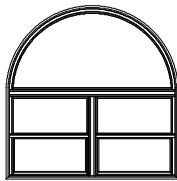

75TB8442-2

86 1/8" (2188)
84" (2134)
83 1/2" (2121)
79 1/8" (2010)
36 3/4" (933)|2|
35 7/16" (900)|2|

92 1/2" (2350)
90 3/8" (2296)
89 7/8" (2283)
20 7/16" (515)
19 1/2" (489)
37 1/8" (943)

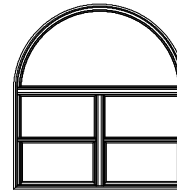

75TB8448-2

86 1/8" (2188)
84" (2134)
83 1/2" (2121)
79 1/8" (2010)
36 3/4" (933)|2|
35 7/16" (900)|2|

93 1/2" (2380)
91 3/8" (2326)
90 7/8" (2308)
20 15/16" (532)
19 3/4" (502)
37 1/8" (943)

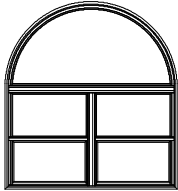

75TB8449-2

86 1/8" (2188)
84" (2134)
83 1/2" (2121)
79 1/8" (2010)
36 3/4" (933)|2|
35 7/16" (900)|2|

97 1/2" (2477)
95 3/8" (2423)
94 7/8" (2410)
22 7/16" (583)
21 1/4" (552)
37 1/8" (943)

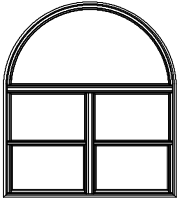

75TB8453-2

ELEVATION SYMBOL LEGEND:
VALUES IN () ARE IN MILLIMETER CONVERSIONS
VALUES IN [] ARE NUMBER OF DAYLIGHT OPENINGS PER UNIT

E BASIC UNIT CLEAR OPENING EXCEEDS 20" IN WIDTH, 24" IN HEIGHT & A MINIMUM OF 5.7 SQ. FT.

Note: Elevations shown DO NOT have exterior trim. Subtract 1/2" (12.7) from M.O. (Masonry Opening) for Unit Sizes. Masonry Openings above include Sill Nose, see Trim Options page for Sill Nose specifications. For other Trim Options refer to the Unit Sizing, Rough Opening & Masonry Openings page.

SCALE: 1/8" = 1'

2-WIDE SINGLE HUNG TILT WITH HALF ROUND

UNIT SIZE
ROUGH OPENING
FRAME SIZE
DAYLIGHT OPENING

86 1/8" (2188)
84" (2134)
83 1/2" (2121)
79 1/8" (2010)
36 3/4" (933)[2]
35 7/16" (900)[2]

98 1/2" (2502)
96 3/8" (2448)
95 7/8" (2435)
23 7/16" (595)
22 1/4" (565)
37 1/8" (943)

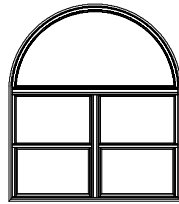

75TB8454-2

86 1/8" (2188)
84" (2134)
83 1/2" (2121)
79 1/8" (2010)
36 3/4" (933)[2]
35 7/16" (900)[2]

101 1/2" (2578)
99 3/8" (2524)
98 7/8" (2511)
24 7/16" (633)
23 1/4" (603)
37 1/8" (943)

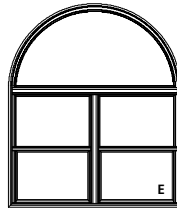

75TB8457-2

86 1/8" (2188)
84" (2134)
83 1/2" (2121)
79 1/8" (2010)
36 3/4" (933)[2]
35 7/16" (900)[2]

104 1/2" (2654)
102 3/8" (2600)
101 7/8" (2588)
26 7/16" (672)
25 1/4" (641)
37 1/8" (943)

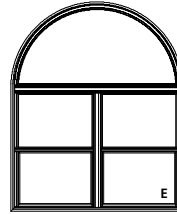

75TB8460-2

86 1/8" (2188)
84" (2134)
83 1/2" (2121)
79 1/8" (2010)
36 3/4" (933)[2]
35 7/16" (900)[2]

106 1/2" (2705)
104 3/8" (2651)
103 7/8" (2638)
27 7/16" (697)
26 1/4" (667)
37 1/8" (943)

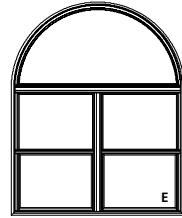

75TB8462-2

UNIT SIZE
ROUGH OPENING
FRAME SIZE
DAYLIGHT OPENING

86 1/8" (2188)
84" (2134)
83 1/2" (2121)
79 1/8" (2010)
36 3/4" (933)[2]
35 7/16" (900)[2]

109 1/2" (2781)
107 3/8" (2727)
106 7/8" (2715)
28 15/16" (735)
27 3/4" (705)
37 1/8" (943)

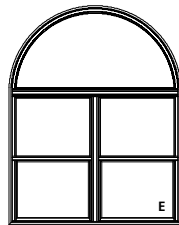

75TB8465-2

86 1/8" (2188)
84" (2134)
83 1/2" (2121)
79 1/8" (2010)
36 3/4" (933)[2]
35 7/16" (900)[2]

110 1/2" (2807)
108 3/8" (2753)
107 7/8" (2740)
29 7/16" (748)
28 1/4" (718)
37 1/8" (943)

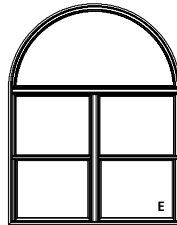

75TB8466-2

86 1/8" (2188)
84" (2134)
83 1/2" (2121)
79 1/8" (2010)
36 3/4" (933)[2]
35 7/16" (900)[2]

113 1/2" (2883)
111 3/8" (2829)
110 7/8" (2816)
30 15/16" (786)
29 3/4" (756)
37 1/8" (943)

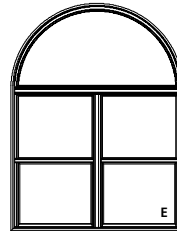

75TB8469-2

86 1/8" (2188)
84" (2134)
83 1/2" (2121)
79 1/8" (2010)
36 3/4" (933)[2]
35 7/16" (900)[2]

116 1/2" (2959)
114 3/8" (2905)
113 7/8" (2892)
32 7/16" (824)
31 1/4" (794)
37 1/8" (943)

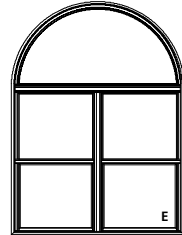

75TB8472-2

UNIT SIZE
ROUGH OPENING
FRAME SIZE
DAYLIGHT OPENING

86 1/8" (2188)
84" (2134)
83 1/2" (2121)
79 1/8" (2010)
36 3/4" (933)[2]
35 7/16" (900)[2]

118 1/2" (3010)
116 3/8" (2956)
115 7/8" (2943)
33 7/16" (849)
32 1/4" (819)
37 1/8" (943)

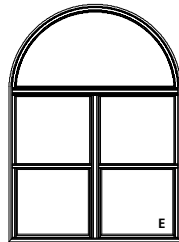

75TB8474-2

86 1/8" (2188)
84" (2134)
83 1/2" (2121)
79 1/8" (2010)
36 3/4" (933)[2]
35 7/16" (900)[2]

121 1/2" (3086)
119 3/8" (3032)
118 7/8" (3019)
34 15/16" (887)
33 3/4" (857)
37 1/8" (943)

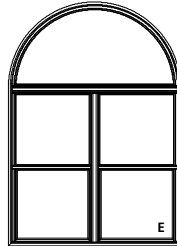

75TB8477-2

UNIT SIZE
ROUGH OPENING
FRAME SIZE
DAYLIGHT OPENING

98 1/8" (2492)
96" (2438)
95 1/2" (2426)
91 1/8" (2315)
42 3/4" (1086)[2]
41 7/16" (1053)[2]

86 1/2" (2187)
84 3/8" (2133)
83 7/8" (2120)
14 7/16" (367)
13 1/4" (337)
43 1/8" (1095)

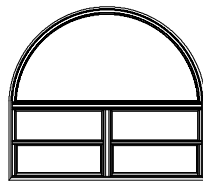

75TB9636-2

98 1/8" (2492)
96" (2438)
95 1/2" (2426)
91 1/8" (2315)
42 3/4" (1086)[2]
41 7/16" (1053)[2]

87 1/2" (2223)
85 3/8" (2169)
84 7/8" (2155)
14 7/16" (379)
13 1/4" (349)
43 1/8" (1095)

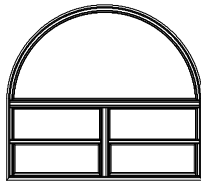

75TB9637-2

98 1/8" (2492)
96" (2438)
95 1/2" (2426)
91 1/8" (2315)
42 3/4" (1086)[2]
41 7/16" (1053)[2]

88 1/2" (2248)
86 3/8" (2194)
85 7/8" (2181)
15 7/16" (392)
14 1/4" (362)
43 1/8" (1095)

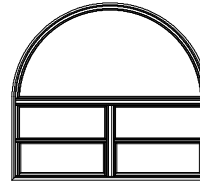

75TB9638-2

ELEVATION SYMBOL LEGEND:
VALUES IN () ARE IN MILLIMETER CONVERSIONS
VALUES IN [] ARE NUMBER OF DAYLIGHT OPENINGS PER UNIT

E BASIC UNIT CLEAR OPENING EXCEEDS 20" IN WIDTH, 24" IN HEIGHT & A MINIMUM OF 5.7 SQ. FT.

Note: Elevations shown DO NOT have exterior trim. Subtract 1/2" (12.7) from M.O. (Masonry Opening) for Unit Sizes. Masonry Openings above include Sill Nose, see Trim Options page for Sill Nose specifications. For other Trim Options refer to the Unit Sizing, Rough Opening & Masonry Openings page.

SCALE: 1/8" = 1'

2-WIDE SINGLE HUNG TILT WITH HALF ROUND

UNIT SIZE
ROUGH OPENING
FRAME SIZE
DAYLIGHT OPENING

98 1/8" (2492)
96" (2438)
95 1/2" (2426)
91 1/8" (2315)
42 3/4" (1086)[2]
41 7/16" (1053)[2]

98 1/8" (2492)
96" (2438)
95 1/2" (2426)
91 1/8" (2315)
42 3/4" (1086)[2]
41 7/16" (1053)[2]

98 1/8" (2492)
96" (2438)
95 1/2" (2426)
91 1/8" (2315)
42 3/4" (1086)[2]
41 7/16" (1053)[2]

91 1/2" (2324)
89 3/8" (2270)
88 7/8" (2257)
16 7/16" (430)
15 1/4" (400)
43 1/8" (1095)

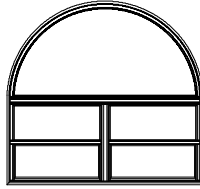

75TB9641-2

92 1/2" (2350)
90 3/8" (2296)
89 7/8" (2283)
17 7/16" (443)
16 1/4" (413)
43 1/8" (1095)

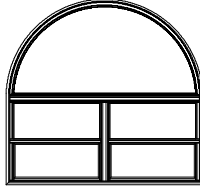

75TB9642-2

98 1/2" (2502)
96 3/8" (2448)
95 7/8" (2435)
35 7/16" (913)
19 1/4" (488)
43 1/8" (1095)

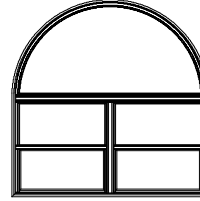

75TB9648-2

UNIT SIZE
ROUGH OPENING
FRAME SIZE
DAYLIGHT OPENING

98 1/8" (2492)
96" (2438)
95 1/2" (2426)
91 1/8" (2315)
42 3/4" (1086)[2]
41 7/16" (1053)[2]

98 1/8" (2492)
96" (2438)
95 1/2" (2426)
91 1/8" (2315)
42 3/4" (1086)[2]
41 7/16" (1053)[2]

98 1/8" (2492)
96" (2438)
95 1/2" (2426)
91 1/8" (2315)
42 3/4" (1086)[2]
41 7/16" (1053)[2]

99 1/2" (2527)
97 3/8" (2473)
96 7/8" (2461)
20 15/16" (532)
19 3/4" (502)
43 1/8" (1095)

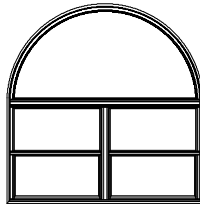

75TB9649-2

103 1/2" (2629)
101 3/8" (2575)
100 7/8" (2562)
22 7/16" (583)
21 1/4" (552)
43 1/8" (1095)

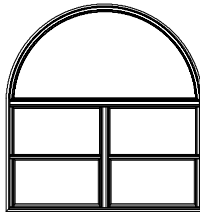

75TB9653-2

104 1/2" (2654)
102 3/8" (2600)
101 7/8" (2588)
32 7/16" (835)
22 1/4" (565)
43 1/8" (1095)

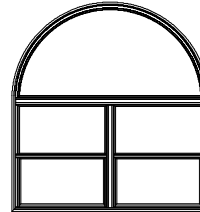

75TB9654-2

UNIT SIZE
ROUGH OPENING
FRAME SIZE
DAYLIGHT OPENING

98 1/8" (2492)
96" (2438)
95 1/2" (2426)
91 1/8" (2315)
42 3/4" (1086)[2]
41 7/16" (1053)[2]

98 1/8" (2492)
96" (2438)
95 1/2" (2426)
91 1/8" (2315)
42 3/4" (1086)[2]
41 7/16" (1053)[2]

98 1/8" (2492)
96" (2438)
95 1/2" (2426)
91 1/8" (2315)
42 3/4" (1086)[2]
41 7/16" (1053)[2]

107 1/2" (2731)
105 3/8" (2677)
104 7/8" (2664)
24 7/16" (633)
23 1/4" (603)
43 1/8" (1095)

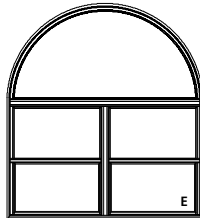

75TB9657-2

110 1/2" (2807)
108 3/8" (2753)
107 7/8" (2740)
26 7/16" (672)
25 1/4" (641)
43 1/8" (1095)

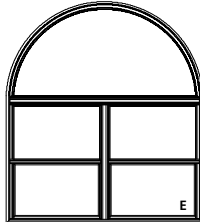

75TB9660-2

112 1/2" (2858)
110 3/8" (2804)
109 7/8" (2791)
31 7/16" (807)
26 1/4" (667)
43 1/8" (1095)

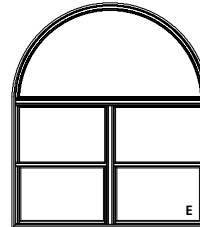

75TB9662-2

UNIT SIZE
ROUGH OPENING
FRAME SIZE
DAYLIGHT OPENING

98 1/8" (2492)
96" (2438)
95 1/2" (2426)
91 1/8" (2315)
42 3/4" (1086)[2]
41 7/16" (1053)[2]

98 1/8" (2492)
96" (2438)
95 1/2" (2426)
91 1/8" (2315)
42 3/4" (1086)[2]
41 7/16" (1053)[2]

98 1/8" (2492)
96" (2438)
95 1/2" (2426)
91 1/8" (2315)
42 3/4" (1086)[2]
41 7/16" (1053)[2]

115 1/2" (2934)
113 3/8" (2880)
112 7/8" (2867)
28 15/16" (735)
27 3/4" (705)
43 1/8" (1095)

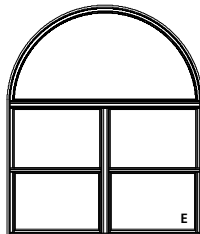

75TB9665-2

116 1/2" (2959)
114 3/8" (2905)
113 7/8" (2892)
29 7/16" (748)
28 1/4" (718)
43 1/8" (1095)

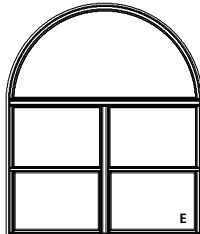

75TB9666-2

119 1/2" (3035)
117 3/8" (2981)
116 7/8" (2969)
30 7/16" (780)
29 3/4" (750)
43 1/8" (1095)

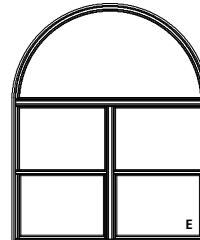

75TB9669-2

ELEVATION SYMBOL LEGEND:
VALUES IN () ARE IN MILLIMETER CONVERSIONS
VALUES IN [] ARE NUMBER OF DAYLIGHT OPENINGS PER UNIT

E BASIC UNIT CLEAR OPENING EXCEEDS 20" IN WIDTH, 24" IN HEIGHT & A MINIMUM OF 5.7 SQ. FT.

Note: Elevations shown DO NOT have exterior trim. Subtract 1/2" (12.7) from M.O. (Masonry Opening) for Unit Sizes. Masonry Openings above include Sill Nose, see Trim Options page for Sill Nose specifications. For other Trim Options refer to the Unit Sizing, Rough Opening & Masonry Openings page.

SCALE: 1/8" = 1'

2-WIDE SINGLE HUNG TILT WITH HALF ROUND

UNIT SIZE	98 1/8" (2492)
ROUGH OPENING	96" (2438)
FRAME SIZE	95 1/2" (2426)
DAYLIGHT OPENING	91 1/8" (2315)
	42 3/4" (1086)(2)
	41 7/16" (1053)(2)

122 1/2" (3112)
120 3/8" (3058)
119 7/8" (3045)
32 7/16" (824)
31 1/4" (794)
43 1/8" (1095)

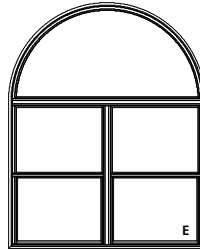

ELEVATION SYMBOL LEGEND:
VALUES IN () ARE IN MILLIMETER CONVERSIONS
VALUES IN [] ARE NUMBER OF DAYLIGHT OPENINGS PER UNIT

E BASIC UNIT CLEAR OPENING EXCEEDS 20" IN WIDTH, 24" IN HEIGHT & A MINIMUM OF 5.7 SQ. FT.

Note: Elevations shown DO NOT have exterior trim. Subtract 1/2" (12.7) from M.O. (Masonry Opening) for Unit Sizes. Masonry Openings above include Sill Nose, see Trim Options page for Sill Nose specifications. For other Trim Options refer to the Unit Sizing, Rough Opening & Masonry Openings page.

SCALE: 1/8" = 1'

GLAZING OPTIONS

EXTERIOR GLAZED

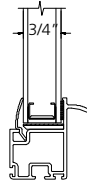

STANDARD 3/4" GLASS

GRILLE PATTERNS

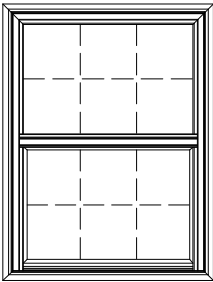

STANDARD

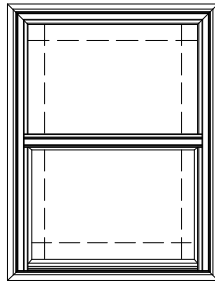

PRAIRIE

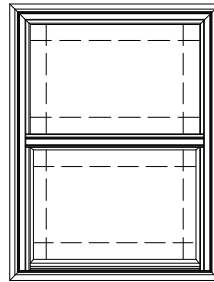

PRAIRIE SASH

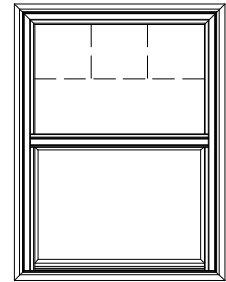

COLONIAL TOP SASH
1/2 LITE

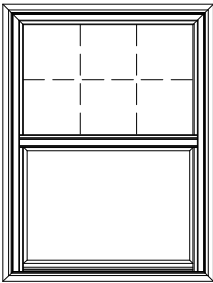

COLONIAL TOP SASH

**SINGLE-HUNG TILT
DP20**

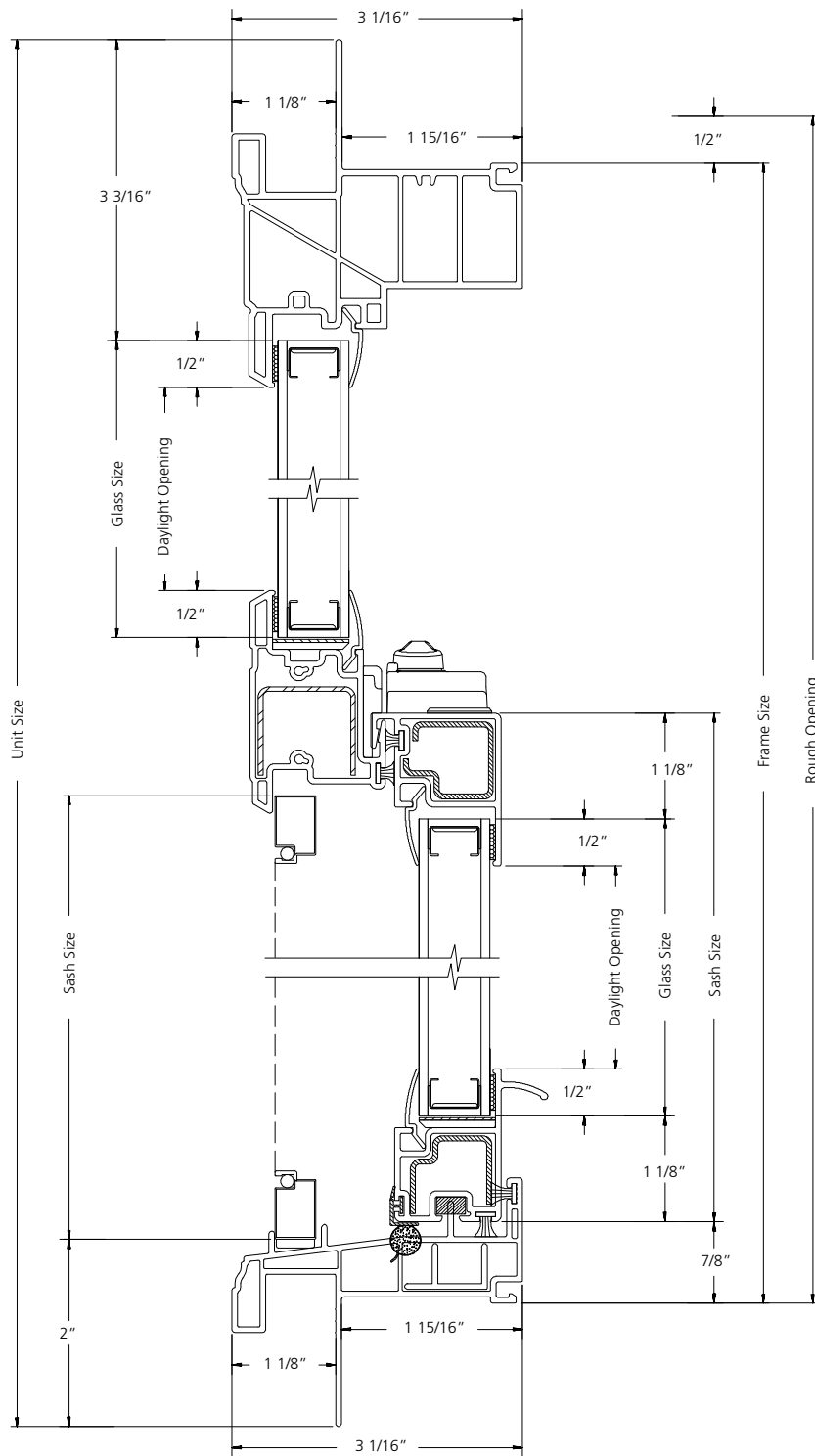

VERTICAL SECTION

SCALE: 6" = 1'

**2-WIDE SINGLE-HUNG TILT
DP50**

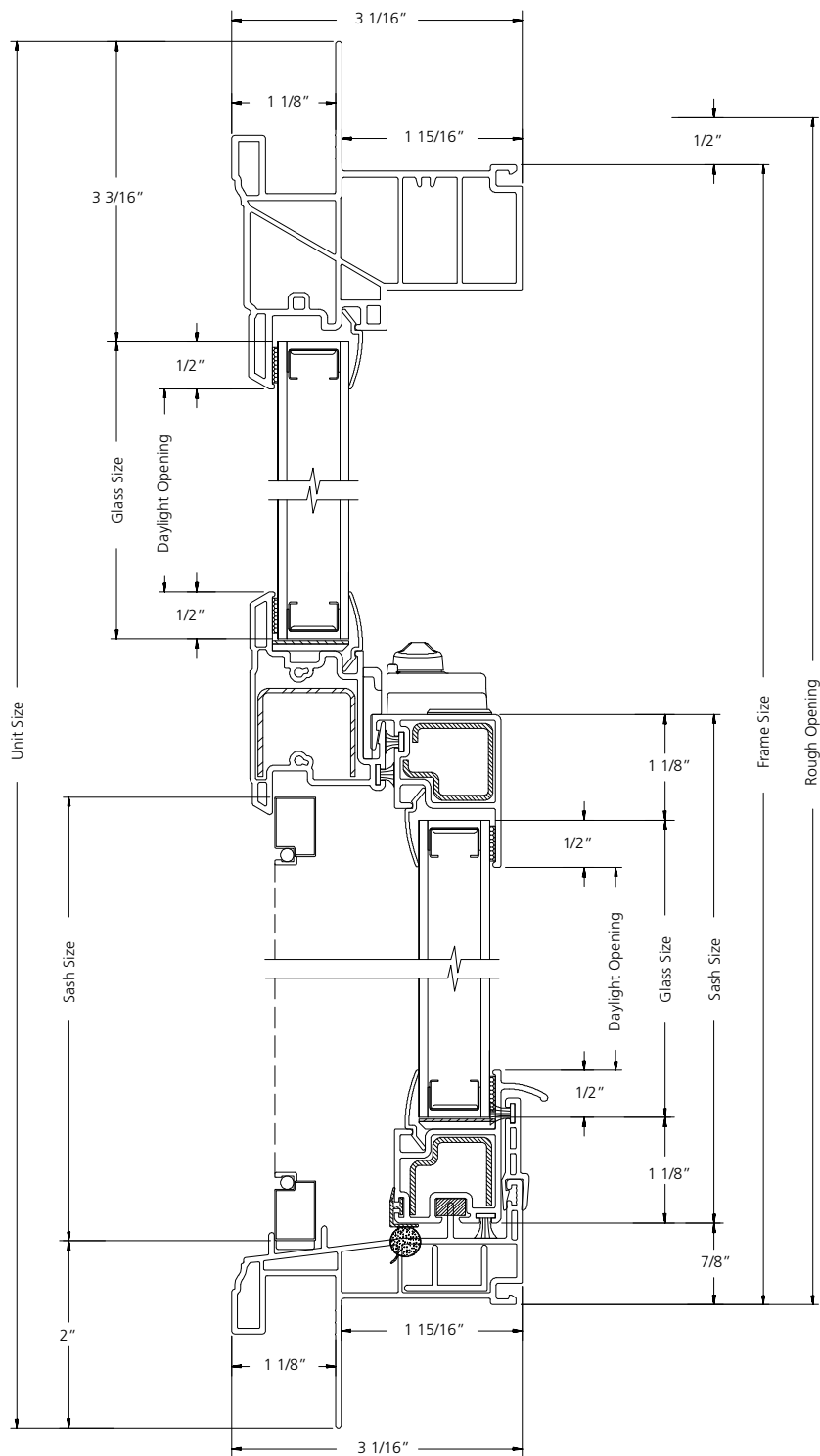

VERTICAL SECTION

SCALE: 6" = 1'

SINGLE-HUNG TILT

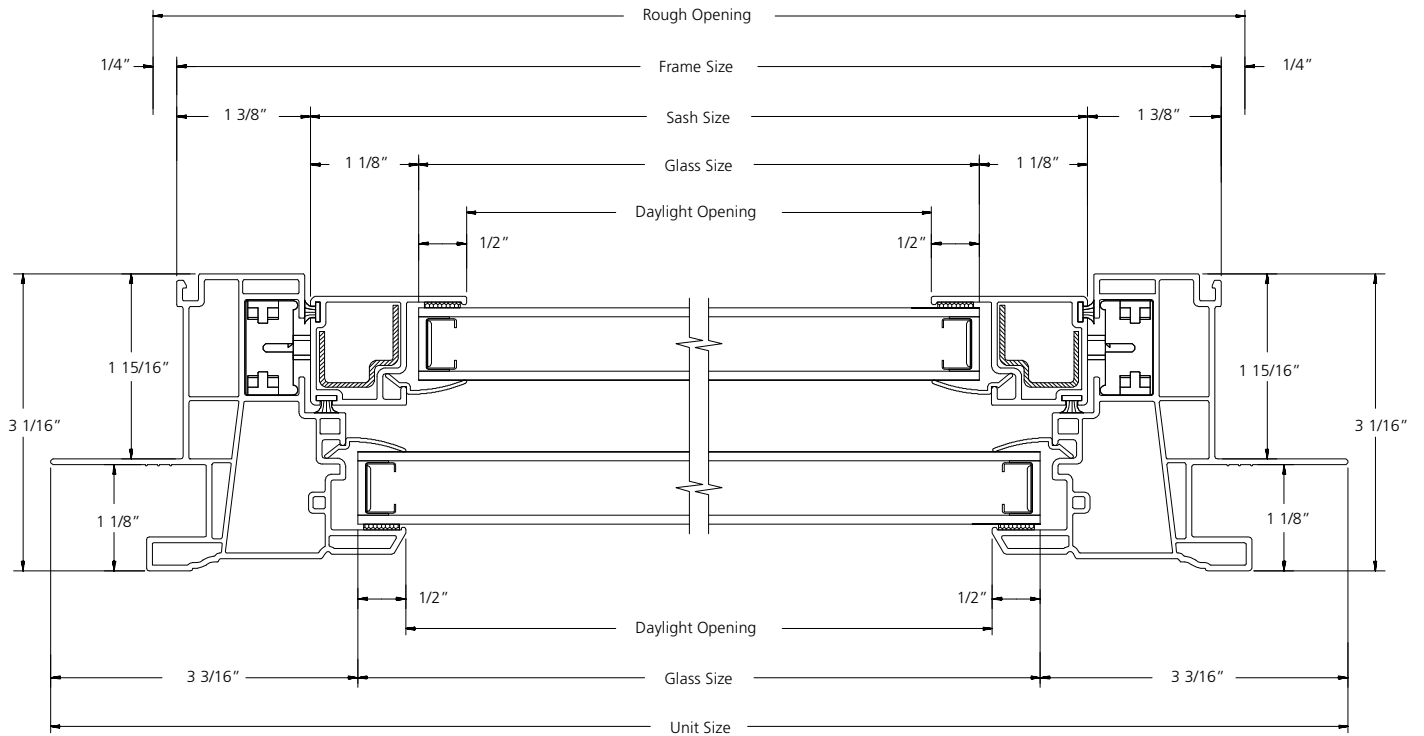

HORIZONTAL SECTION

SCALE: 6" = 1'

2-WIDE SINGLE-HUNG TILT

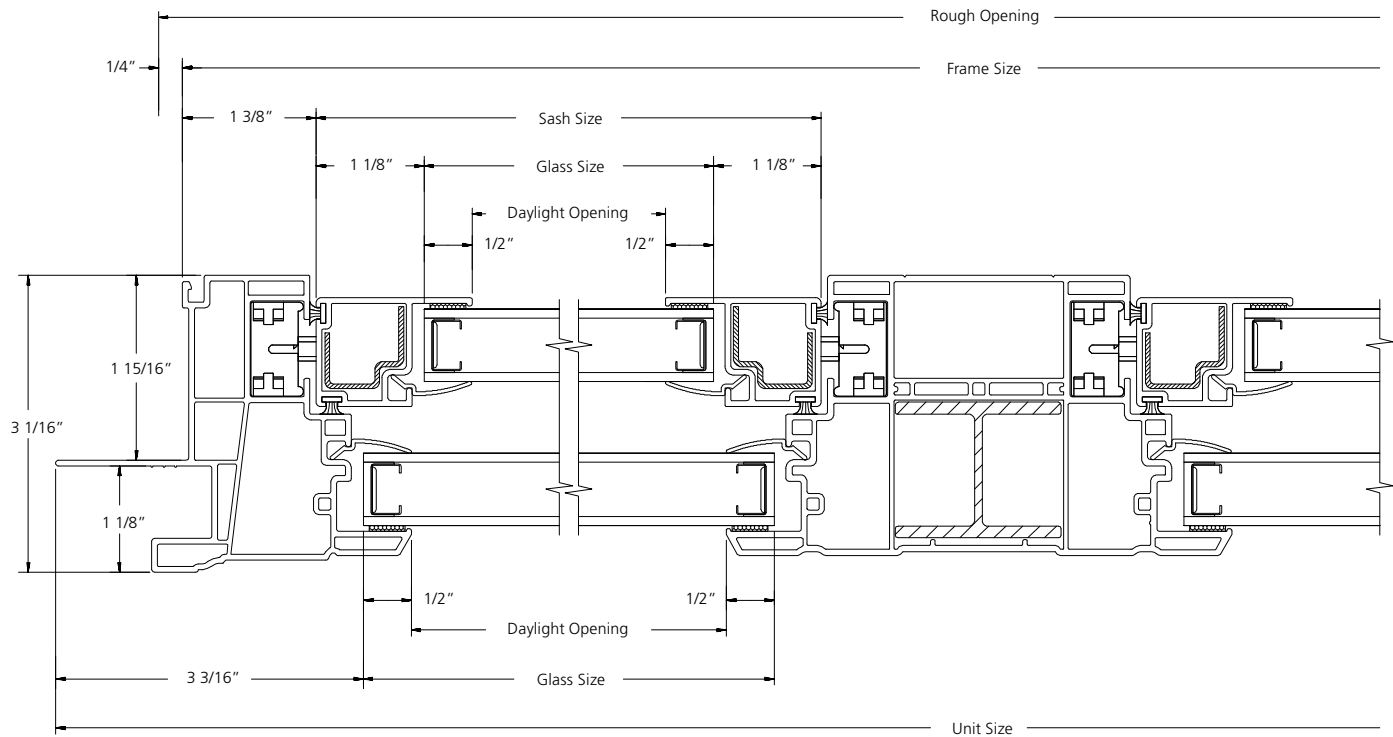

HORIZONTAL SECTION

SCALE: 6" = 1'

3-WIDE SINGLE-HUNG TILT

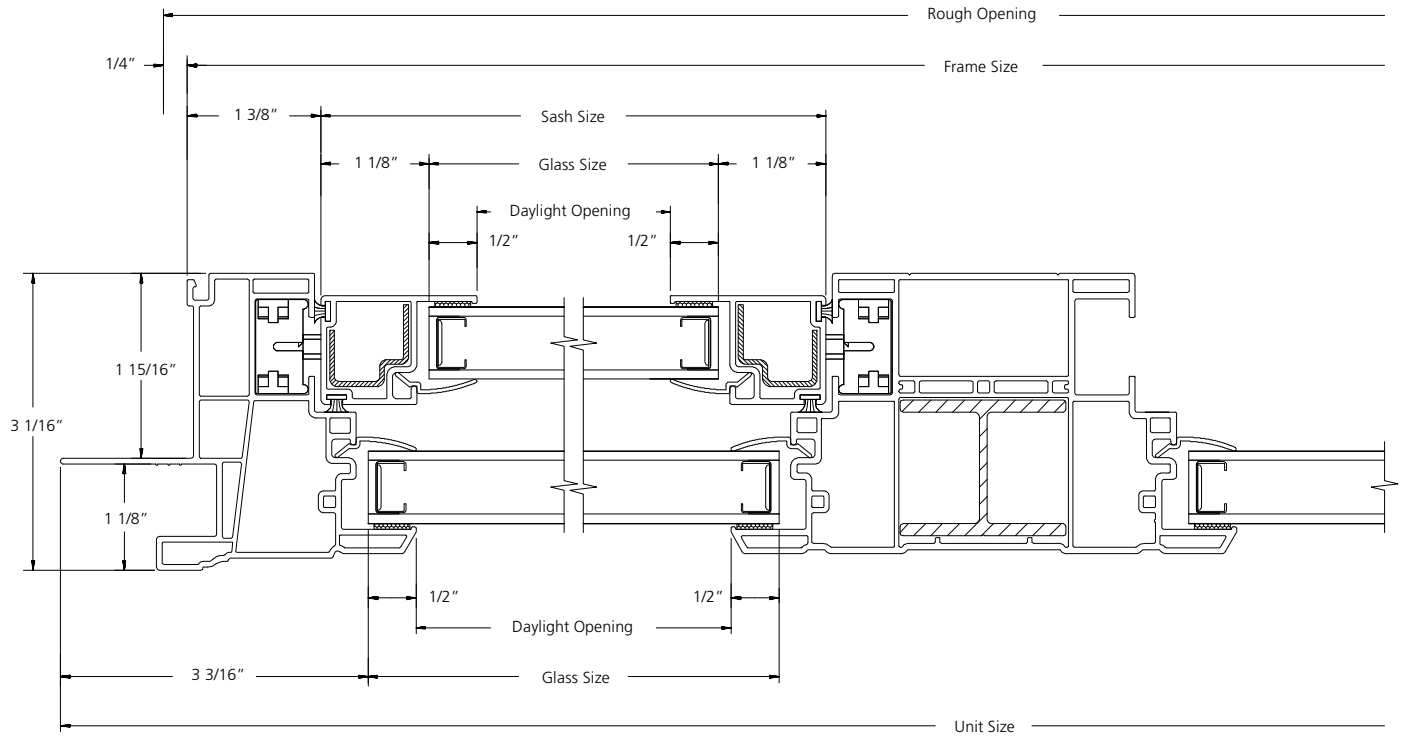

HORIZONTAL SECTION

SCALE: 6" = 1'

SINGLE-HUNG TILT WITH TRANSOM

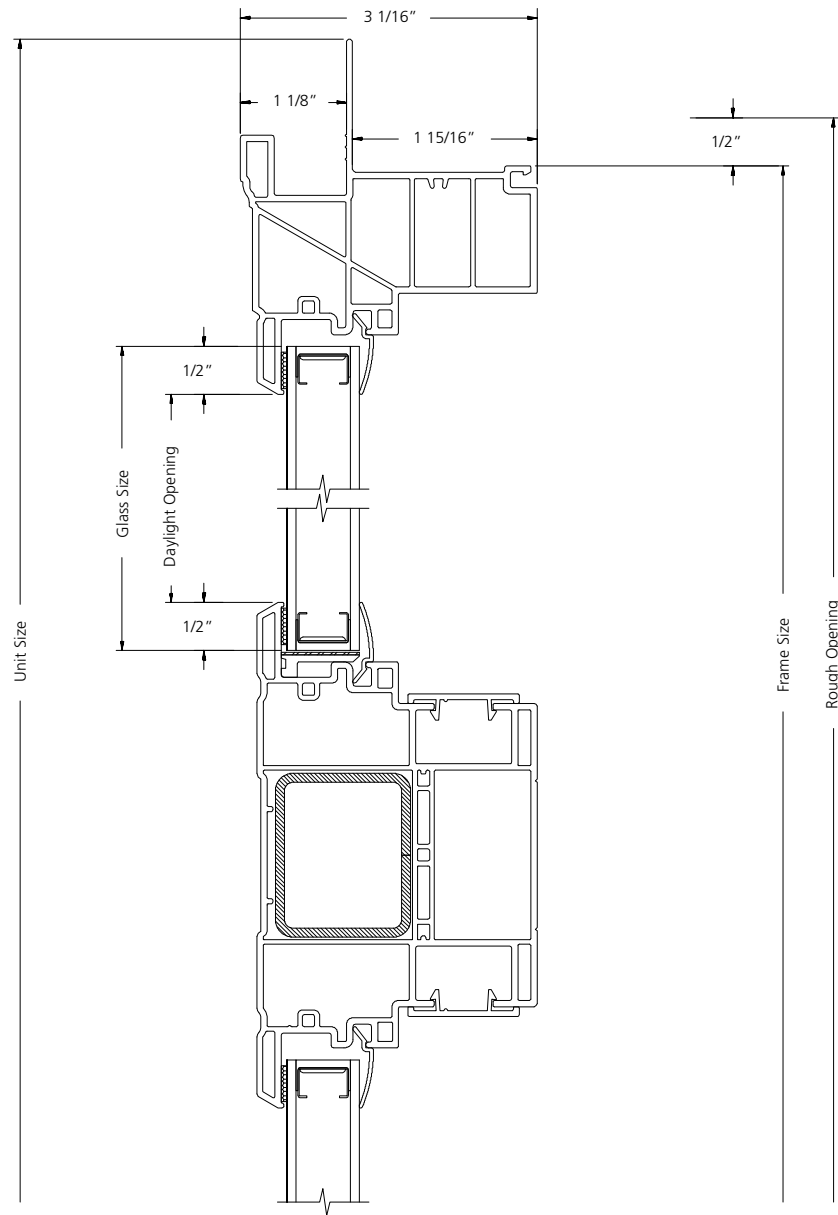

VERTICAL SECTION

SCALE: 6" = 1'