



Molded Interior Door Cambridge

Product Detail Sheets

Table of Contents

Construction Details..... 3

6' - 8" Standard Doors



2-Panel

1' - 0" thru 1' - 8"

.....pg. 4



2-Panel

1' - 10" thru 3' - 0"

.....pg. 5

6' - 8" Bi-Fold Doors



2-Panel Bi-Fold

1' - 0" thru 1' - 6"

.....pg. 6

7' - 0" Standard Doors



2-Panel

1' - 0" thru 1' - 8"

.....pg. 7

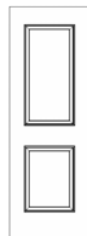

2-Panel

1' - 10" thru 3' - 0"

.....pg. 8



Molded Interior Door Cambridge

Product Detail Sheets Table of Contents

7' - 0" Bi-Fold Doors



2-Panel Bi-Fold

1' - 0" thru 1' - 6"

.....pg. 9

8' - 0" Standard Doors



2-Panel

1' - 0" thru 1' - 8"

.....pg. 10



2-Panel

1' - 10" thru 3' - 0"

.....pg. 11

8' - 0" Bi-Fold Doors



2-Panel Bi-Fold

1' - 0" thru 1' - 6"

.....pg. 12

© 2011 JELD-WEN, inc. ALL RIGHTS RESERVED.
 NO DUPLICATION OR DISTRIBUTION PERMITTED.
 JELD-WEN, inc. CONFIDENTIAL AND PROPRIETARY.

**SOLID PARTICLEBOARD CORE -
 COMBINATION WOOD / MDF OR
 ALL-WOOD FRAME**

1 3/8" DOOR
 1 3/4" DOOR

20-MINUTE FIRE RATING AVAILABLE
 OR 1 3/4" UP TO 3'-0" x 8'-0"

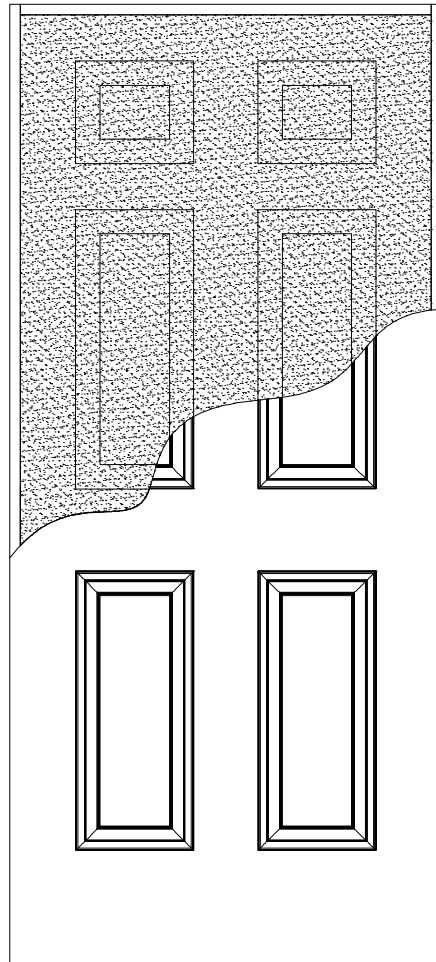

**WIDE STILE WITH SOLID
 PARTICLEBOARD CORE -
 WOOD FRAME**

1 3/4" DOOR

20-MINUTE FIRE RATING

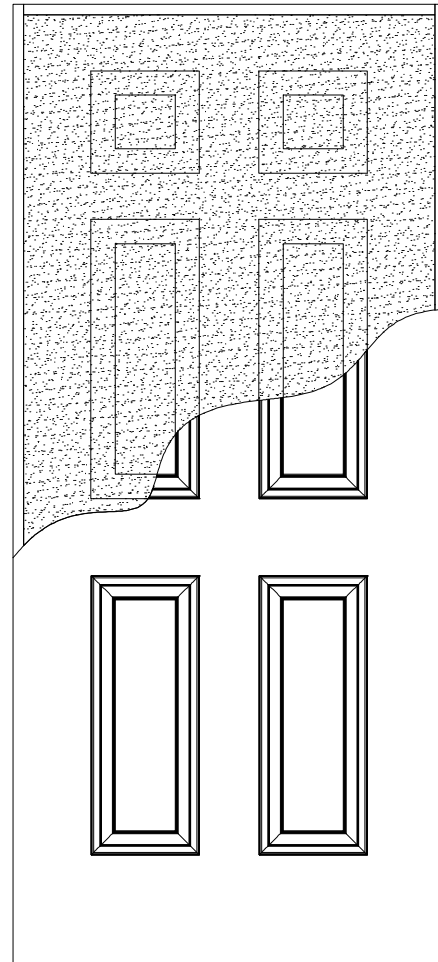

**SOLID MINERAL CORE -
 ALL-WOOD FRAME**

1 3/4" DOOR

45- OR 60- MINUTE FIRE RATINGS UP TO 3'-0" x 8'-0",
 MANUFACTURED TO THE CURRENT
 GEORGIA-PACIFIC OR MARSHFIELD DOOR SYSTEMS
 SPECIFICATIONS

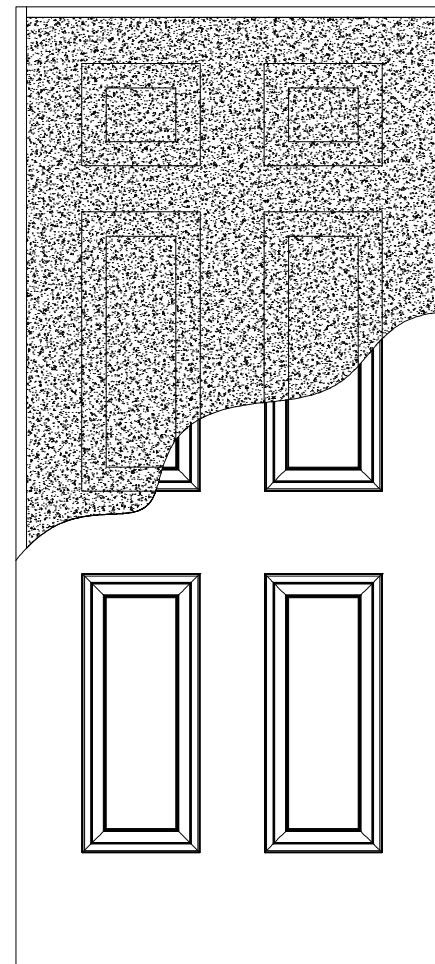

**HOLLOW CORE -
 MDF FRAME**

1 3/8" DOOR

BLOCKING BEHIND PANELS FOR SUPPORT*

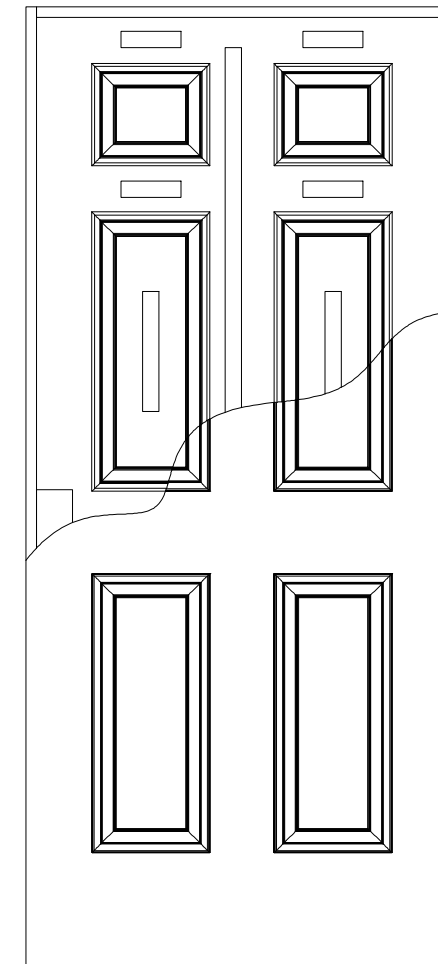

* HOLLOW CORE CONSTRUCTION MAY VARY BY REGION.

CREATION DATE: 10/31/2011		3737 Lakeport Blvd. Klamath Falls, OR 97601 Phone: (800) 441-3884 www.jeld-wen.com
REV. DATE:		
TITLE: MOLDED DOOR CONSTRUCTION DETAILS		
DESCRIPTION: CORE OPTIONS		

© 2012 JELD-WEN, inc. ALL RIGHTS RESERVED.
NO DUPLICATION OR DISTRIBUTION PERMITTED.
JELD-WEN, inc. CONFIDENTIAL AND PROPRIETARY.

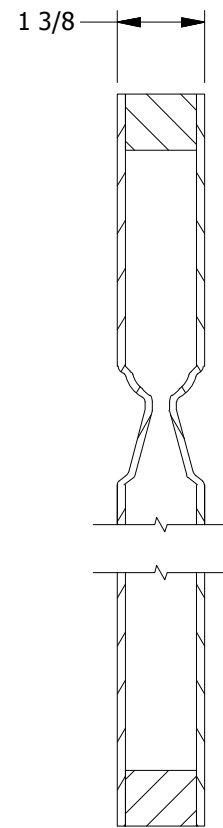
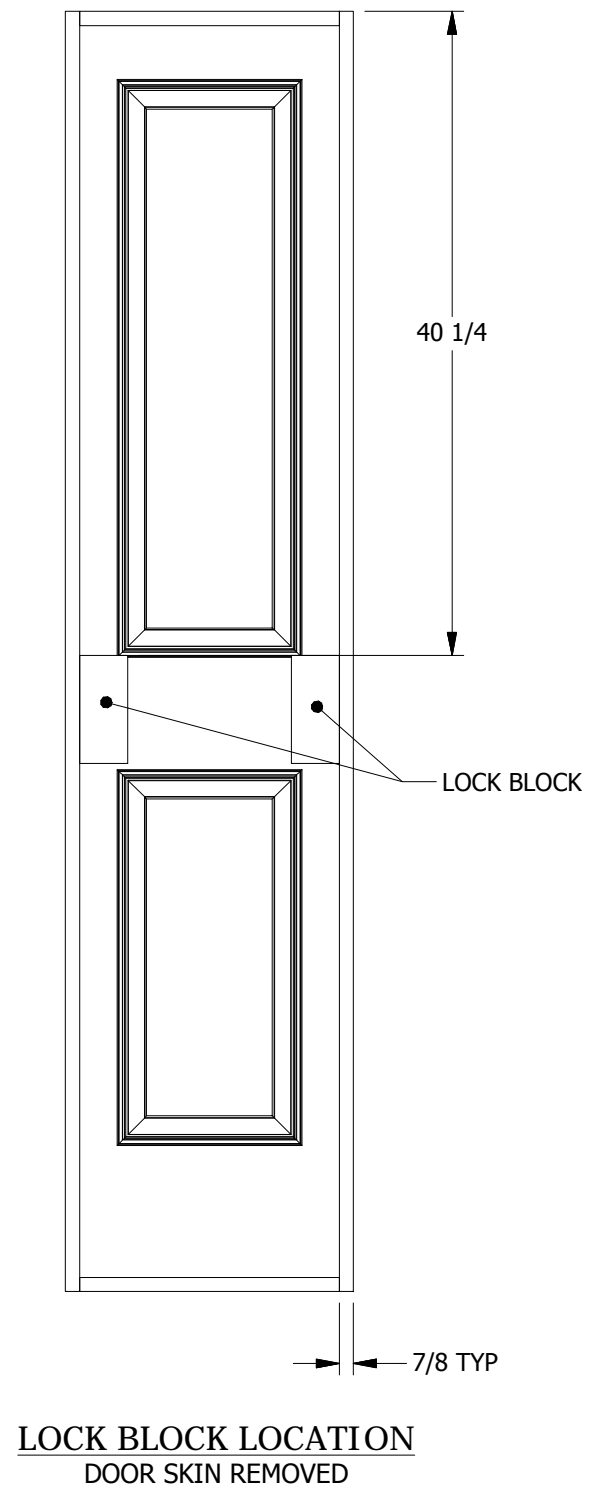
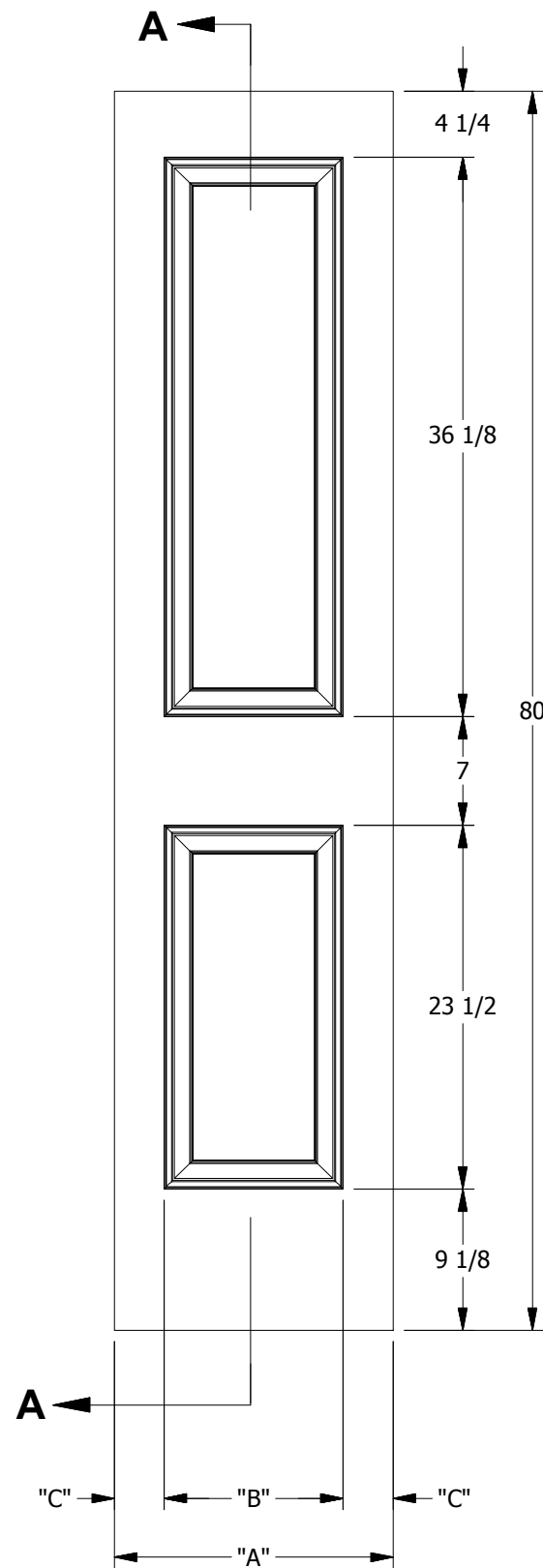

SECTION A-A

DIMENSION TABLE			
DOOR SIZE	"A"	"B"	"C"
1'-0" x 6'-8"	12"	5 9/16"	3 7/32"
1'-2" x 6'-8"	14"	7 9/16"	3 7/32"
1'-3" x 6'-8"	15"	8 9/16"	3 7/32"
1'-4" x 6'-8"	16"	9 9/16"	3 7/32"
1'-6" x 6'-8"	18"	11 9/16"	3 7/32"
1'-8" x 6'-8"	20"	11 9/16"	4 7/32"

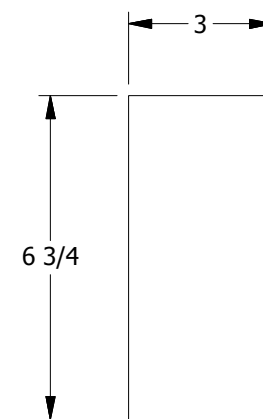

LOCK BLOCK
DETAIL

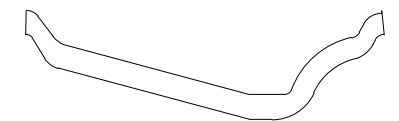

PANEL PROFILE : OVOLO STICKING

CREATION DATE: 2/6/2012		3737 Lakeport Blvd. Klamath Falls, OR 97601 Phone: (800) 441-3884 www.jeld-wen.com
REV. DATE:		
TITLE: MOLDED INTERIOR DOOR		
DESCRIPTION: CAMBRIDGE SMOOTH 6'-8" 1'-0", 1'-2", 1'-3", 1'-4", 1'-6", 1'-8"		

© 2012 JELD-WEN, inc. ALL RIGHTS RESERVED.
NO DUPLICATION OR DISTRIBUTION PERMITTED.
JELD-WEN, inc. CONFIDENTIAL AND PROPRIETARY.

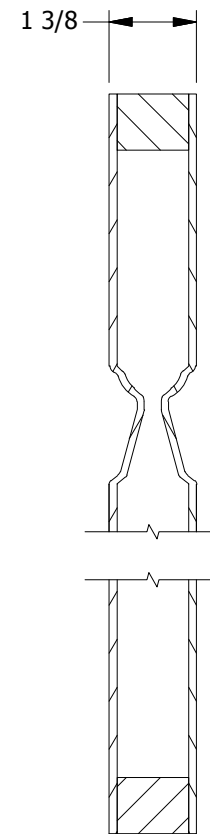
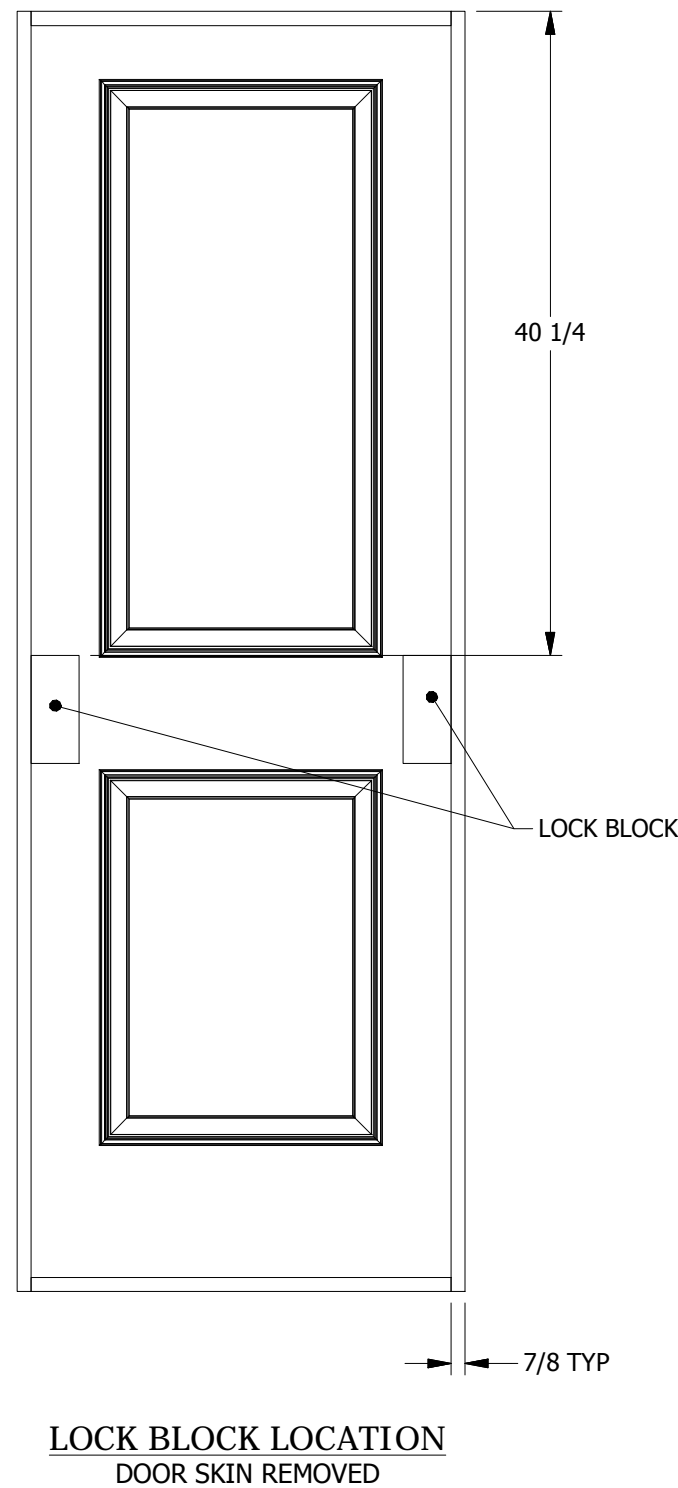
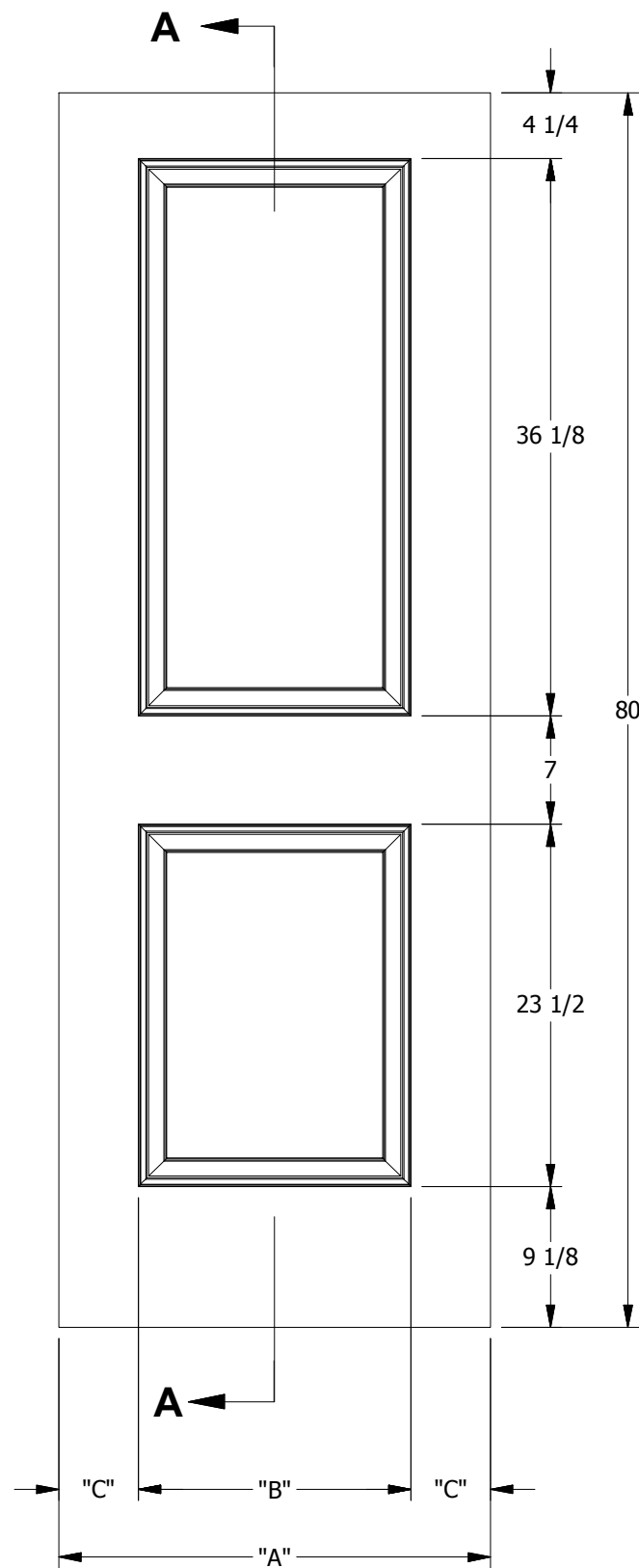

SECTION A-A

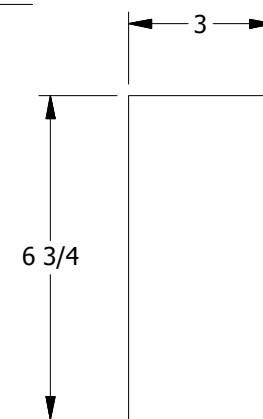

LOCK BLOCK
DETAIL

DIMENSION TABLE			
DOOR SIZE	"A"	"B"	"C"
1'-10" x 6'-8"	22"	13 11/16"	4 5/32"
2'-0" x 6'-8"	24"	13 11/16"	5 5/32"
2'-2" x 6'-8"	26"	17 11/16"	4 5/32"
2'-4" x 6'-8"	28"	17 11/16"	5 5/32"
2'-6" x 6'-8"	30"	19 11/16"	5 5/32"
2'-8" x 6'-8"	32"	21 11/16"	5 5/32"
2'-10" x 6'-8"	34"	23 3/4"	5 1/8"
3'-0" x 6'-8"	36"	23 3/4"	6 1/8"

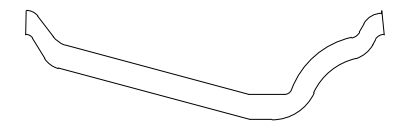

PANEL PROFILE : OVOLO STICKING

CREATION DATE: 2/6/2012		3737 Lakeport Blvd. Klamath Falls, OR 97601 Phone: (800) 441-3884 www.jeld-wen.com
REV. DATE:		
TITLE:	MOLDED INTERIOR DOOR	
DESCRIPTION:	CAMBRIDGE SMOOTH 6'-8" 1'-10", 2'-0", 2'-2", 2'-4", 2'-6", 2'-8", 2'-10", 3'-0"	

© 2012 JELD-WEN, inc. ALL RIGHTS RESERVED.
 NO DUPLICATION OR DISTRIBUTION PERMITTED.
 JELD-WEN, inc. CONFIDENTIAL AND PROPRIETARY.

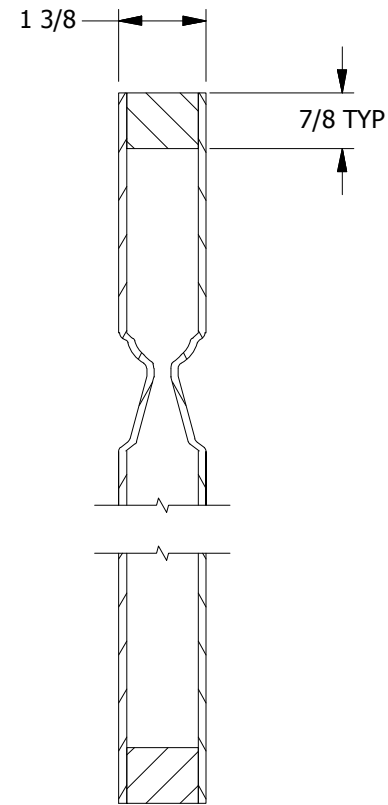
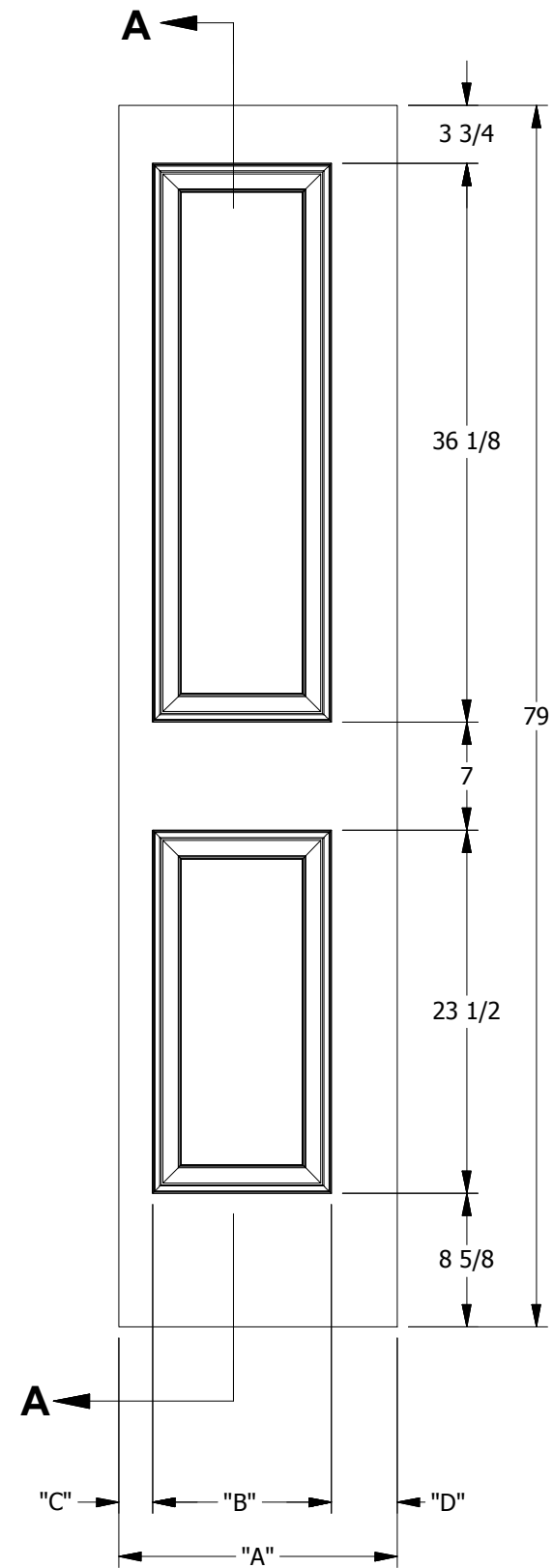

SECTION A-A

DIMENSION TABLE				
DOOR SIZE	"A"	"B"	"C"	"D"
1'-0" x 6'-8"	12"	5 9/16"	2 3/16"	4 1/4"
1'-2" x 6'-8"	14"	7 9/16"	2 3/16"	4 1/4"
1'-3" x 6'-8"	15"	8 9/16"	2 3/16"	4 1/4"
1'-4" x 6'-8"	16"	9 9/16"	2 3/16"	4 1/4"
1'-6" x 6'-8"	18"	11 9/16"	2 3/16"	4 1/4"

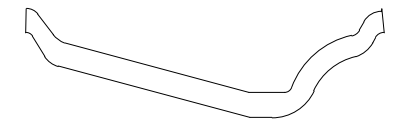

PANEL PROFILE : OVOLO STICKING

CREATION DATE: 2/6/2012		3737 Lakeport Blvd. Klamath Falls, OR 97601 Phone: (800) 441-3884 www.jeld-wen.com
REV. DATE:		
TITLE: MOLDED INTERIOR DOOR		
DESCRIPTION: CAMBRIDGE BI-FOLD SMOOTH 6'-8" 1'-0", 1'-2", 1'-3", 1'-4", 1'-6"		

© 2012 JELD-WEN, inc. ALL RIGHTS RESERVED.
NO DUPLICATION OR DISTRIBUTION PERMITTED.
JELD-WEN, inc. CONFIDENTIAL AND PROPRIETARY.

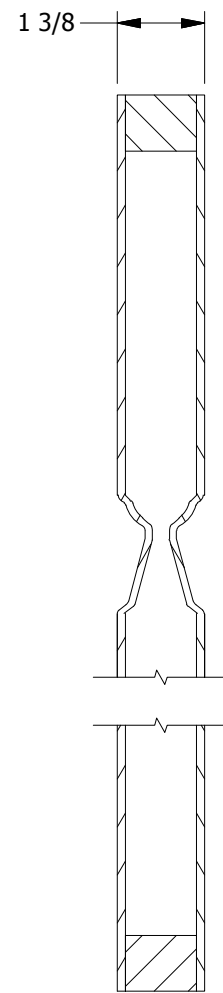
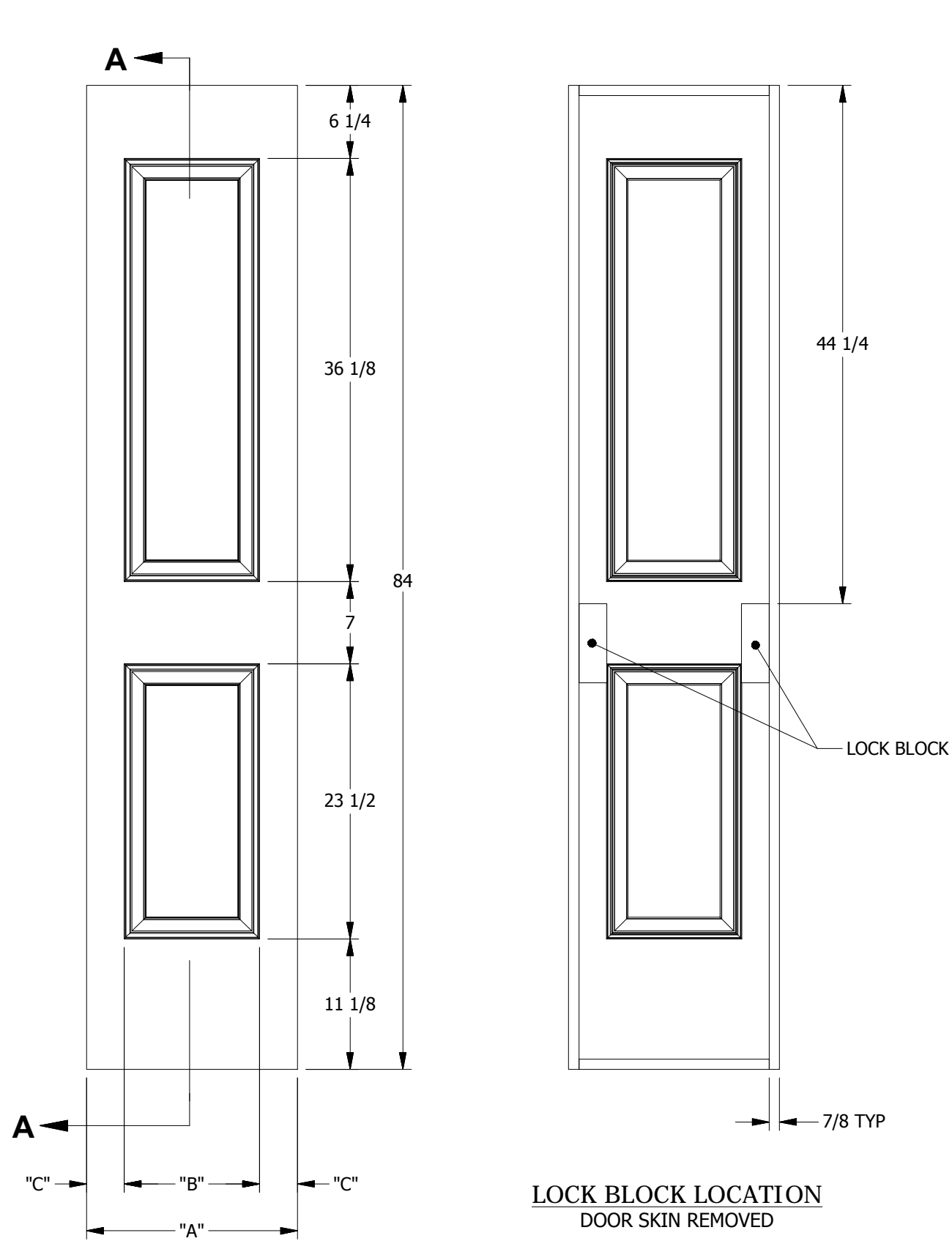

SECTION A-A

DIMENSION TABLE				
DOOR SIZE	"A"	"B"	"C"	"D"
1'-0" x 7'-0"	12"	5 9/16"	3 7/32"	2 3/8"
1'-2" x 7'-0"	14"	7 9/16"	3 7/32"	2 3/8"
1'-3" x 7'-0"	15"	8 9/16"	3 7/32"	2 5/8"
1'-4" x 7'-0"	16"	9 9/16"	3 7/32"	2 5/8"
1'-6" x 7'-0"	18"	11 9/16"	3 7/32"	3"
1'-8" x 7'-0"	20"	11 9/16"	4 7/32"	3"

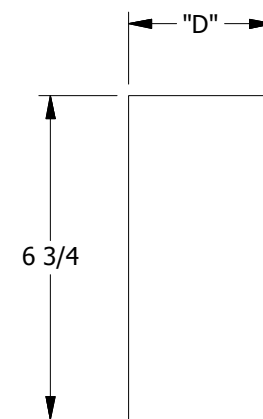

LOCK BLOCK
DETAIL

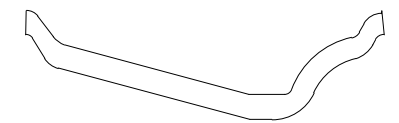

PANEL PROFILE : OVOLO STICKING

CREATION DATE: 2/6/2012		3737 Lakeport Blvd. Klamath Falls, OR 97601 Phone: (800) 441-3884 www.jeld-wen.com
REV. DATE:		
TITLE:	MOLDED INTERIOR DOOR	
DESCRIPTION:	CAMBRIDGE SMOOTH 7'-0" 1'-0", 1'-2", 1'-3", 1'-4", 1'-6", 1'-8"	

© 2012 JELD-WEN, inc. ALL RIGHTS RESERVED.
NO DUPLICATION OR DISTRIBUTION PERMITTED.
JELD-WEN, inc. CONFIDENTIAL AND PROPRIETARY.

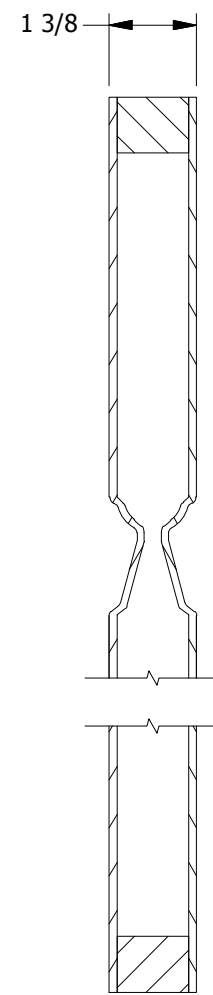
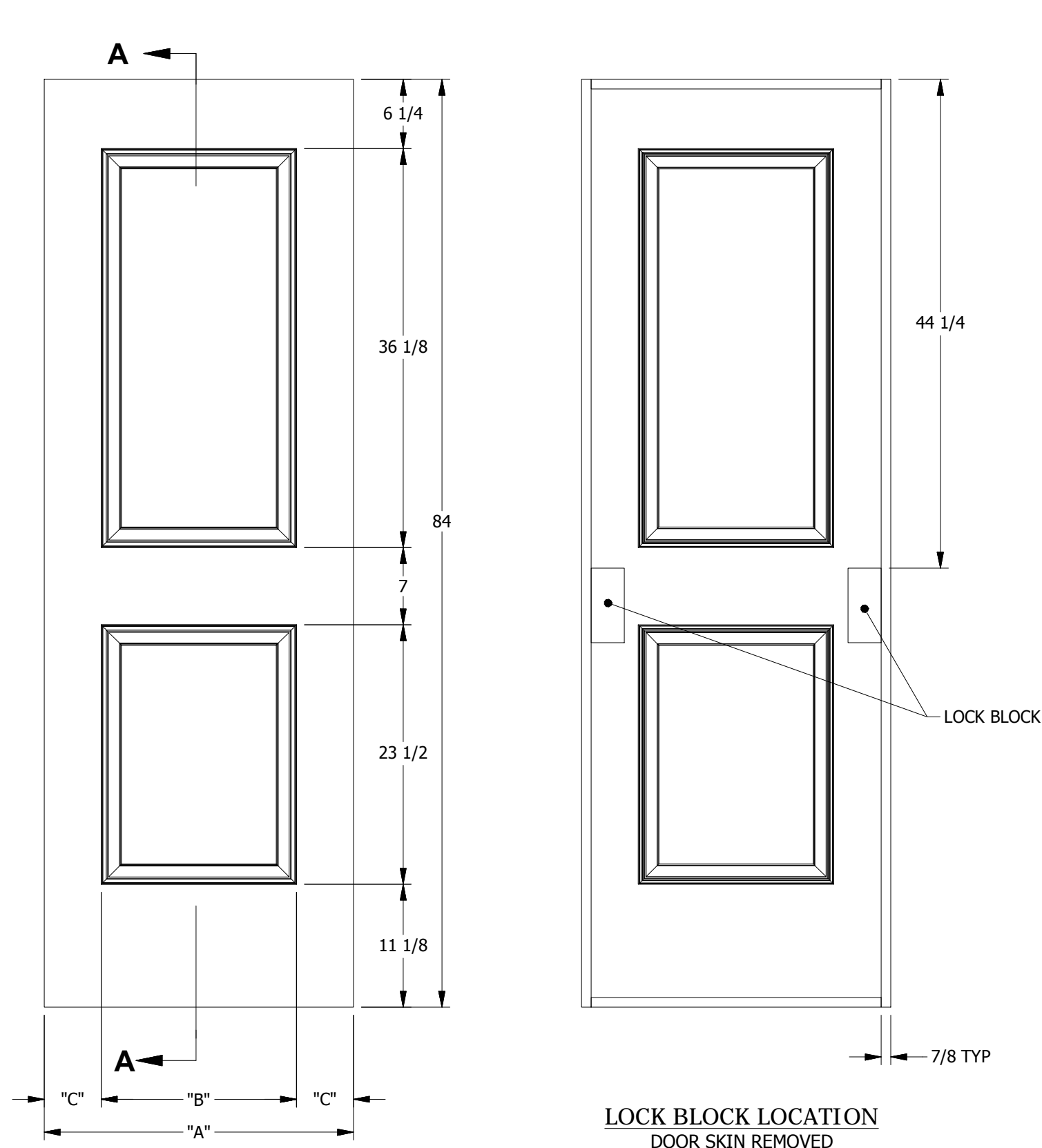

DIMENSION TABLE				
DOOR SIZE	"A"	"B"	"C"	"D"
1'-10" x 7'-0"	22"	13 11/16"	4 5/32"	2 5/8"
2'-0" x 7'-0"	24"	13 11/16"	5 5/32"	3"
2'-2" x 7'-0"	26"	17 11/16"	4 5/32"	2 5/8"
2'-4" x 7'-0"	28"	17 11/16"	5 5/32"	3"
2'-6" x 7'-0"	30"	19 11/16"	5 5/32"	3"
2'-8" x 7'-0"	32"	21 11/16"	5 5/32"	3"
2'-10" x 7'-0"	34"	23 3/4"	5 1/8"	3"
3'-0" x 7'-0"	36"	23 3/4"	6 1/8"	3"

SECTION A-A

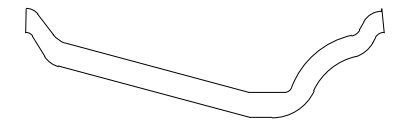
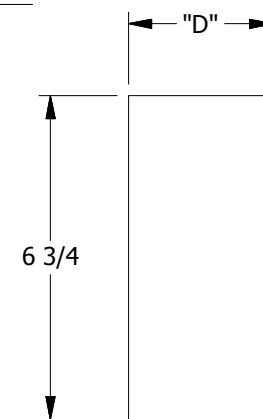

PANEL PROFILE : OVOLO STICKING

CREATION DATE: 2/6/2012		3737 Lakeport Blvd. Klamath Falls, OR 97601 Phone: (800) 441-3884 www.jeld-wen.com
REV. DATE:		
TITLE: MOLDED INTERIOR DOOR		
DESCRIPTION: CAMBRIDGE SMOOTH 7'-0" 1'-10", 2'-0", 2'-2", 2'-4", 2'-6", 2'-8", 2'-10", 3'-0"		

© 2012 JELD-WEN, inc. ALL RIGHTS RESERVED.
 NO DUPLICATION OR DISTRIBUTION PERMITTED.
 JELD-WEN, inc. CONFIDENTIAL AND PROPRIETARY.

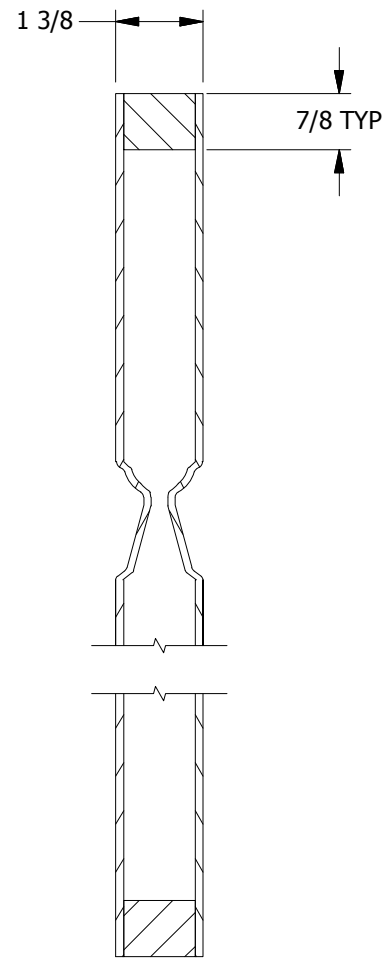
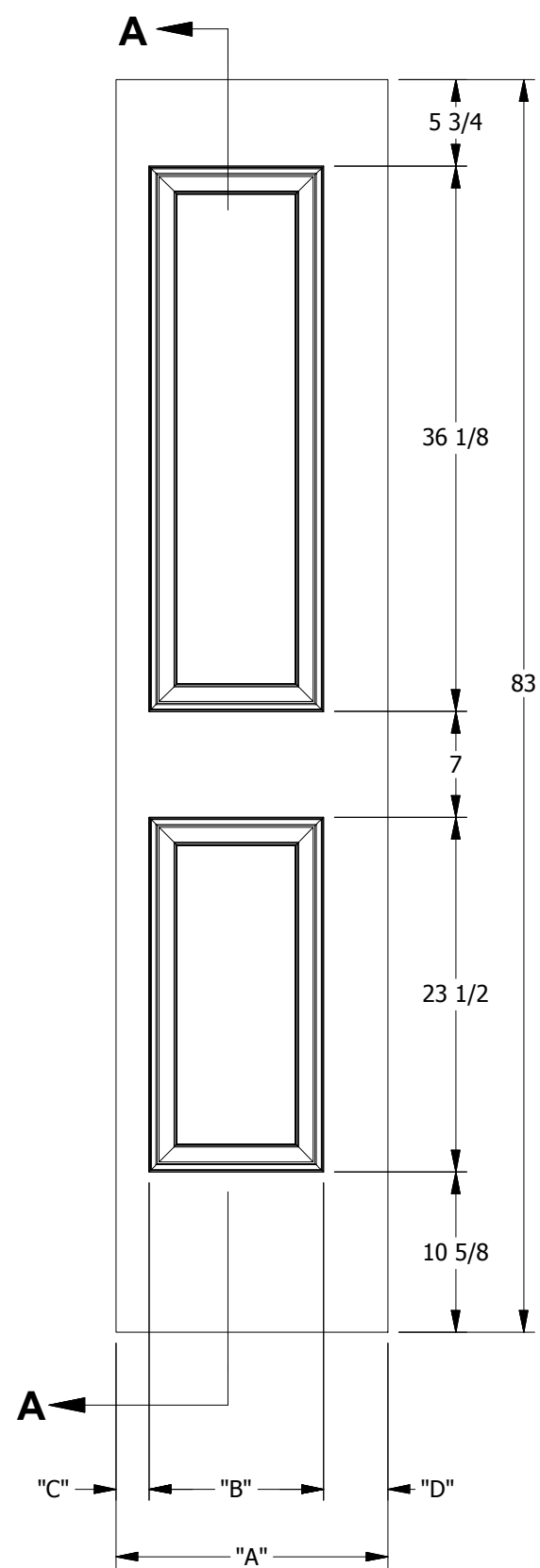

SECTION A-A

DIMENSION TABLE				
DOOR SIZE	"A"	"B"	"C"	"D"
1'-0" x 7'-0"	12"	5 9/16"	2 3/16"	4 1/4"
1'-2" x 7'-0"	14"	7 9/16"	2 3/16"	4 1/4"
1'-3" x 7'-0"	15"	8 9/16"	2 3/16"	4 1/4"
1'-4" x 7'-0"	16"	9 9/16"	2 3/16"	4 1/4"
1'-6" x 7'-0"	18"	11 9/16"	2 3/16"	4 1/4"

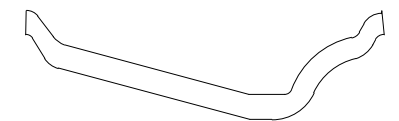

PANEL PROFILE : OVOLO STICKING

CREATION DATE: 2/6/2012		3737 Lakeport Blvd. Klamath Falls, OR 97601 Phone: (800) 441-3884 www.jeld-wen.com
REV. DATE:		
TITLE: MOLDED INTERIOR DOOR		
DESCRIPTION: CAMBRIDGE BI-FOLD SMOOTH 7'-0" 1'-0", 1'-2", 1'-3", 1'-4", 1'-6"		

© 2012 JELD-WEN, inc. ALL RIGHTS RESERVED.
NO DUPLICATION OR DISTRIBUTION PERMITTED.
JELD-WEN, inc. CONFIDENTIAL AND PROPRIETARY.

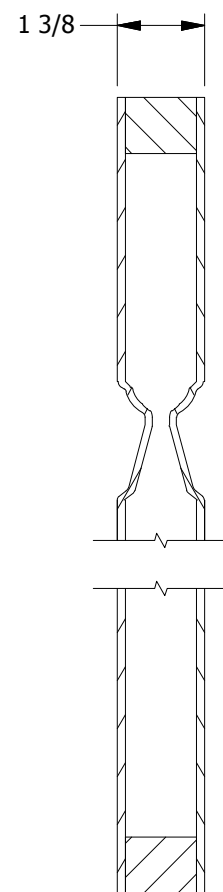
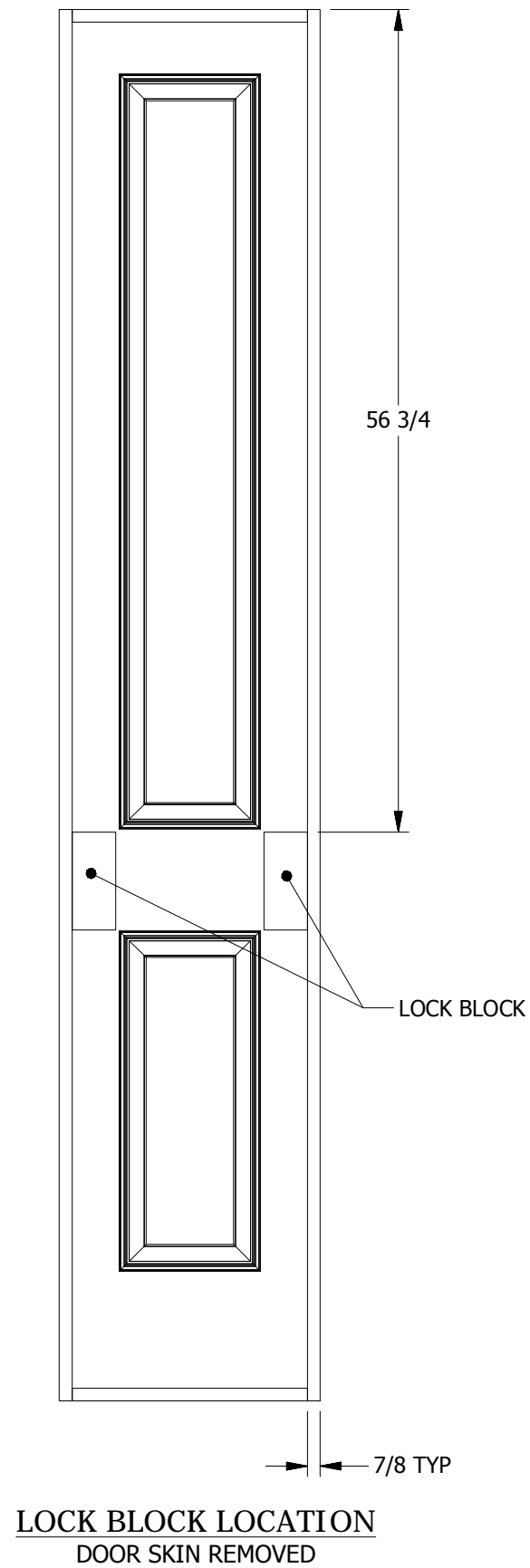
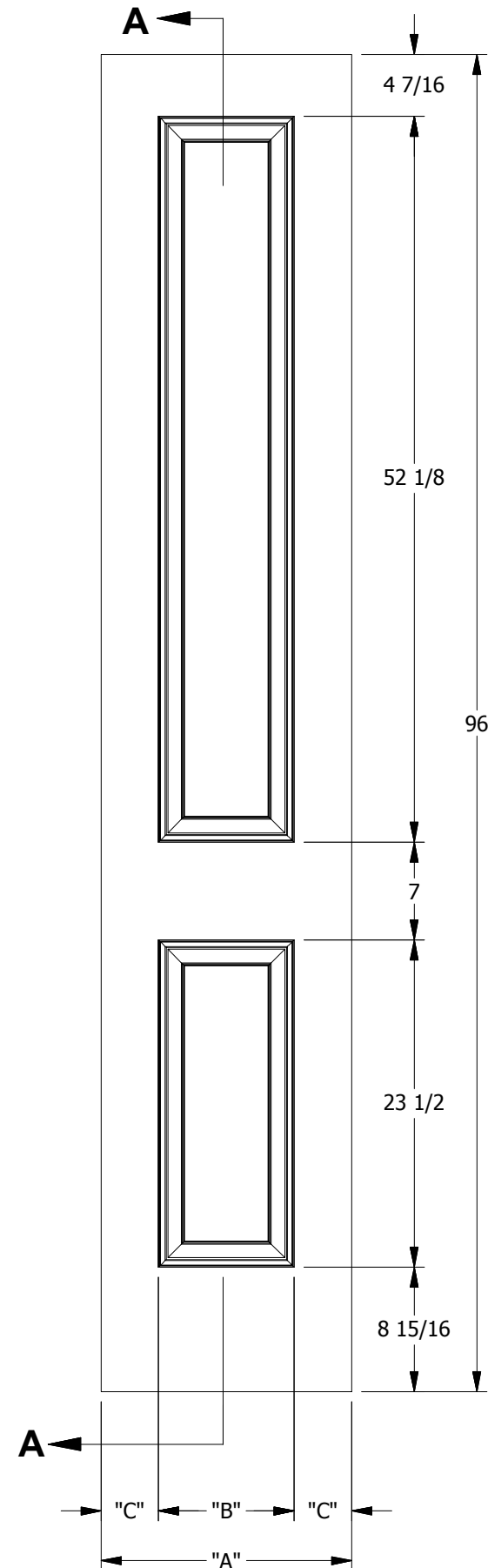

SECTION A-A

DIMENSION TABLE			
DOOR SIZE	"A"	"B"	"C"
1'-0" x 8'-0"	12"	7"	2 1/2"
1'-2" x 8'-0"	14"	7"	3 1/2"
1'-3" x 8'-0"	15"	7"	4"
1'-4" x 8'-0"	16"	7"	4 1/2"
1'-6" x 8'-0"	18"	9 3/4"	4 1/8"
1'-8" x 8'-0"	20"	9 3/4"	5 1/8"

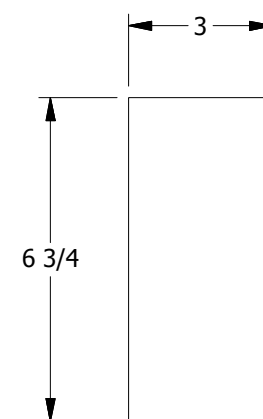

LOCK BLOCK
DETAIL

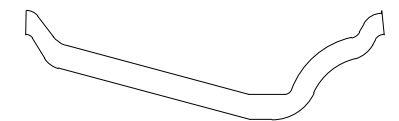

PANEL PROFILE : OVOLO STICKING

CREATION DATE: 2/6/2012		3737 Lakeport Blvd. Klamath Falls, OR 97601 Phone: (800) 441-3884 www.jeld-wen.com
REV. DATE:		
TITLE: MOLDED INTERIOR DOOR		
DESCRIPTION: CAMBRIDGE SMOOTH 8'-0" 1'-0", 1'-2", 1'-3", 1'-4", 1'-6", 1'-8"		

© 2012 JELD-WEN, inc. ALL RIGHTS RESERVED.
NO DUPLICATION OR DISTRIBUTION PERMITTED.
JELD-WEN, inc. CONFIDENTIAL AND PROPRIETARY.

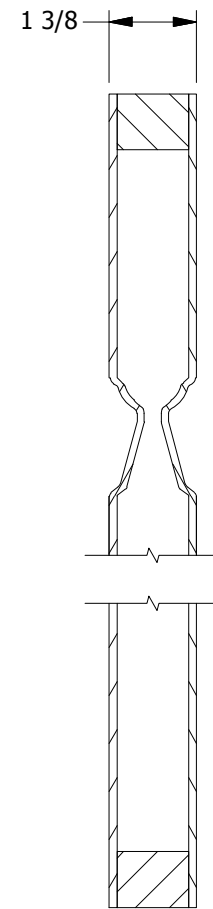
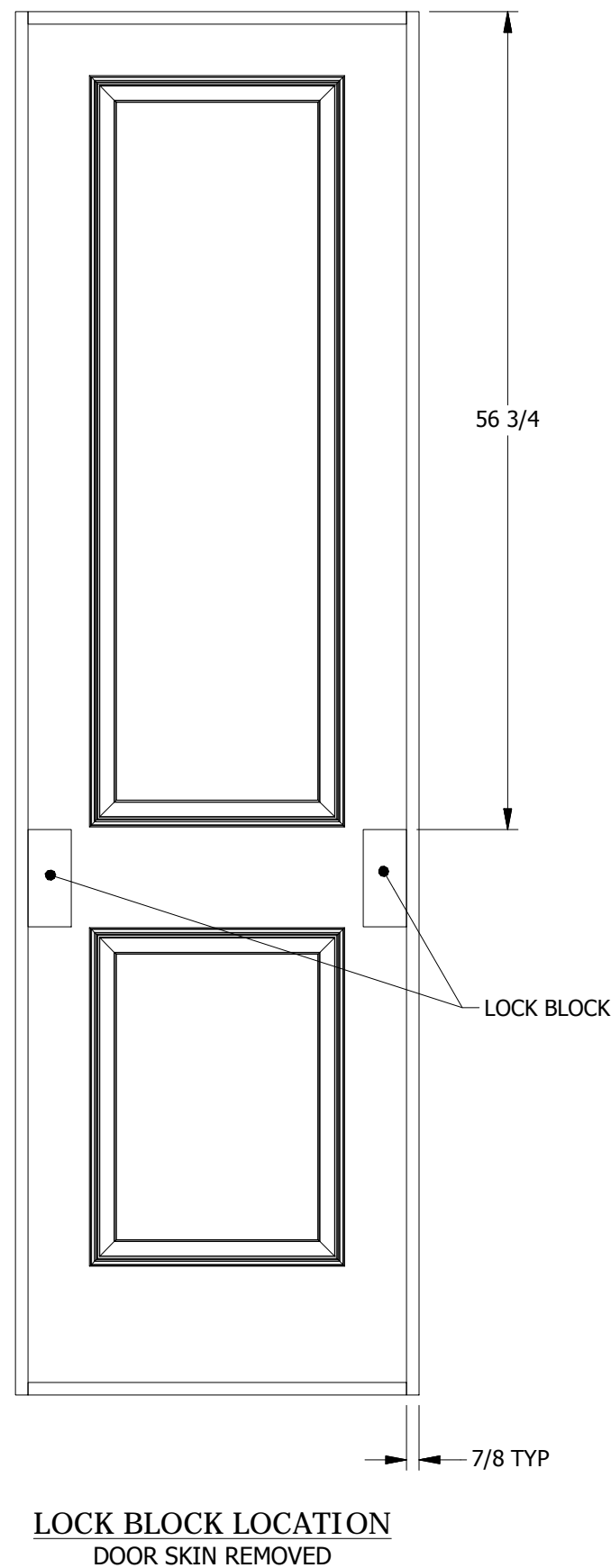
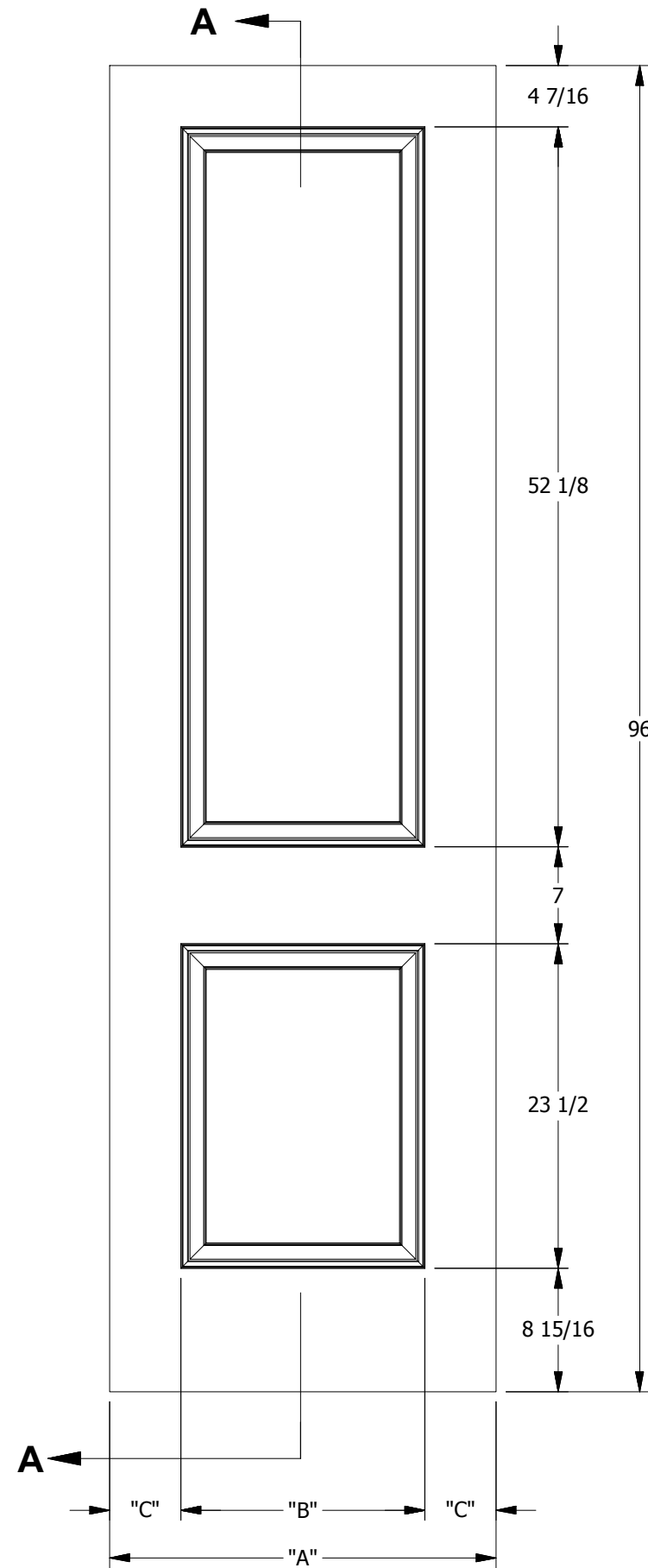

SECTION A-A

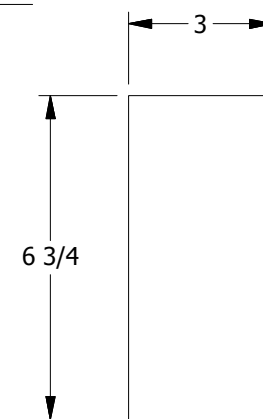

LOCK BLOCK
DETAIL

DIMENSION TABLE			
DOOR SIZE	"A"	"B"	"C"
1'-10" x 8'-0"	22"	13 11/16"	4 5/32"
2'-0" x 8'-0"	24"	13 11/16"	5 5/32"
2'-2" x 8'-0"	26"	17 11/16"	4 5/32"
2'-4" x 8'-0"	28"	17 11/16"	5 5/32"
2'-6" x 8'-0"	30"	19 11/16"	5 5/32"
2'-8" x 8'-0"	32"	21 11/16"	5 5/32"
2'-10" x 8'-0"	34"	23 11/16"	5 5/32"
3'-0" x 8'-0"	36"	23 11/16"	6 5/32"

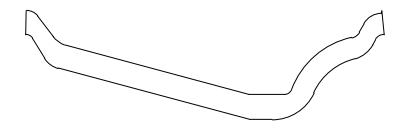

PANEL PROFILE : OVOLO STICKING

CREATION DATE: 2/6/2012		3737 Lakeport Blvd. Klamath Falls, OR 97601 Phone: (800) 441-3884 www.jeld-wen.com
REV. DATE:		
TITLE: MOLDED INTERIOR DOOR		
DESCRIPTION: CAMBRIDGE SMOOTH 8'-0" 1'-10", 2'-0", 2'-2", 2'-4", 2'-6", 2'-8", 2'-10", 3'-0"		

© 2012 JELD-WEN, inc. ALL RIGHTS RESERVED.
 NO DUPLICATION OR DISTRIBUTION PERMITTED.
 JELD-WEN, inc. CONFIDENTIAL AND PROPRIETARY.

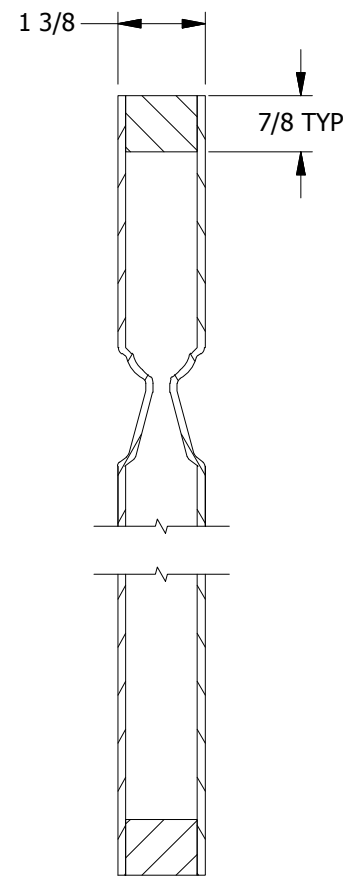
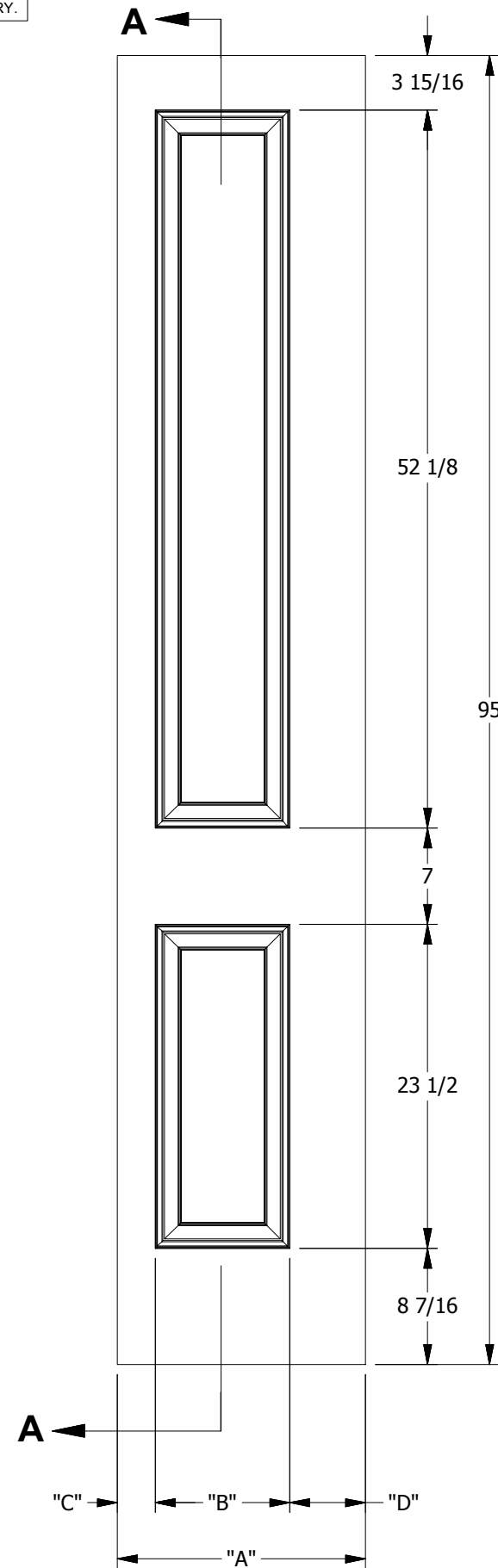

SECTION A-A

DIMENSION TABLE				
DOOR SIZE	"A"	"B"	"C"	"D"
1'-0" x 8'-0"	12"	7"	1 3/4"	3 1/4"
1'-2" x 8'-0"	14"	7"	2 3/4"	4 1/4"
1'-3" x 8'-0"	15"	7"	2 3/4"	5 1/4"
1'-4" x 8'-0"	16"	7"	2 3/4"	6 1/4"
1'-6" x 8'-0"	18"	9 3/4"	2 3/4"	5 1/2"

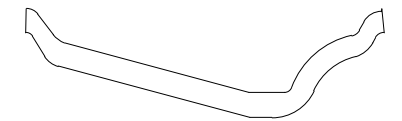

PANEL PROFILE : OVOLO STICKING

CREATION DATE: 2/6/2012		3737 Lakeport Blvd. Klamath Falls, OR 97601 Phone: (800) 441-3884 www.jeld-wen.com
REV. DATE:		
TITLE: MOLDED INTERIOR DOOR		
DESCRIPTION: CAMBRIDGE BI-FOLD SMOOTH 8'-0" 1'-0", 1'-2", 1'-3", 1'-4", 1'-6"		