



Molded Interior Door Colonial

Product Detail Sheets

Table of Contents

Construction Details..... 3

6' - 8" Standard Doors



3-Panel

1' - 0" thru 1' - 8"

.....pg. 4



6-Panel

1' - 10" thru 3' - 0"

.....pg. 5

6' - 8" Bi-Fold Doors



3-Panel Bi-Fold

1' - 0" thru 1' - 6"

.....pg. 6

7' - 0" Standard Doors



3-Panel

1' - 0" thru 1' - 8"

.....pg. 7



6-Panel

1' - 10" thru 3' - 0"

.....pg. 8



Molded Interior Door Colonial

Product Detail Sheets

Table of Contents

7' - 0" Bi-Fold Doors



3-Panel Bi-Fold

1' - 0" thru 1' - 6"

.....pg. 9

8' - 0" Standard Doors



3-Panel

1' - 6" thru 1' - 8"

.....pg. 10



6-Panel

1' - 10" thru 3' - 0"

.....pg. 11

8' - 0" Bi-Fold Doors



3-Panel Bi-Fold

1' - 0" thru 1' - 6"

.....pg. 12

© 2012JELD-WEN, inc. ALL RIGHTS RESERVED.
NO DUPLICATION OR DISTRIBUTION PERMITTED.
JELD-WEN, inc. CONFIDENTIAL AND PROPRIETARY.

**SOLID PARTICLEBOARD CORE -
COMBINATION WOOD / MDF OR
ALL-WOOD FRAME**

1 3/8" DOOR
1 3/4" DOOR

20-MINUTE FIRE RATING AVAILABLE FOR 1 3/4"
UP TO 3'-0" x 8'0"

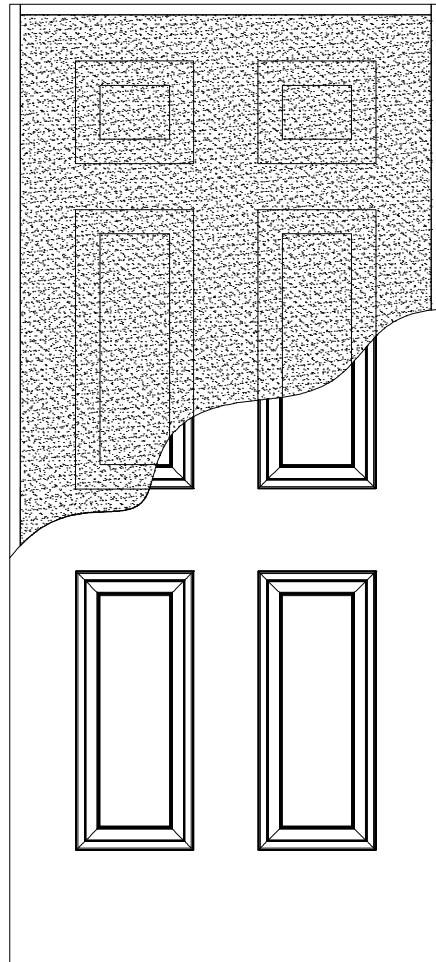

**WIDE STILE WITH SOLID
PARTICLEBOARD CORE -
WOOD FRAME**

1 3/4" DOOR

20-MINUTE FIRE RATING

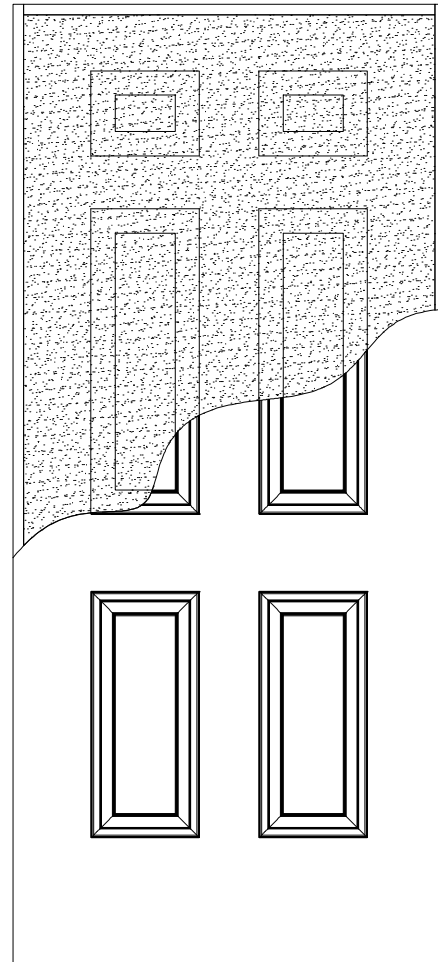

**SOLID MINERAL CORE -
ALL-WOOD FRAME**

1 3/4" DOOR

45- MINUTE FIRE RATINGS UP TO 3'-0" x 8'-0",
MANUFACTURED TO THE CURRENT
MARSHFIELD DOOR SYSTEMS SPECIFICATIONS
60- MINUTE FIRE RATINGS UP TO 3'-0" x 8'-0",
MANUFACTURED TO THE CURRENT
GEORGIA-PACIFIC OR MARSHFIELD DOOR SYSTEMS
SPECIFICATIONS

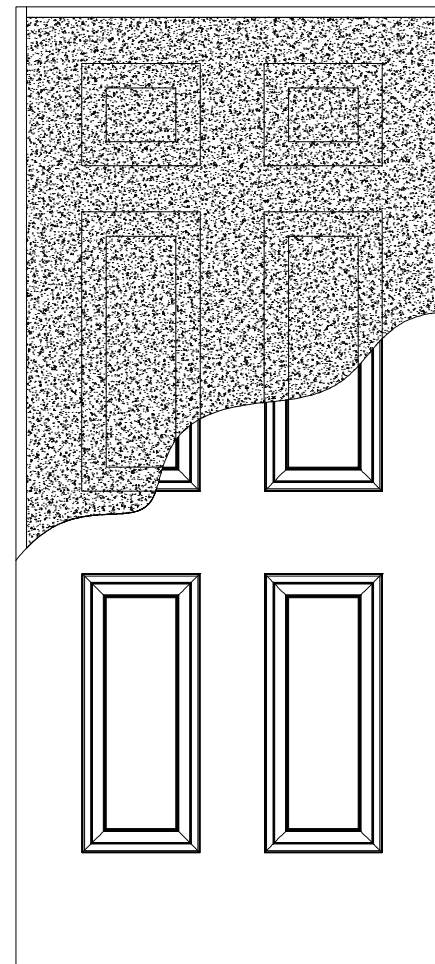

**HOLLOW CORE -
MDF FRAME**

1 3/8" DOOR

BLOCKING BEHIND PANELS FOR SUPPORT*

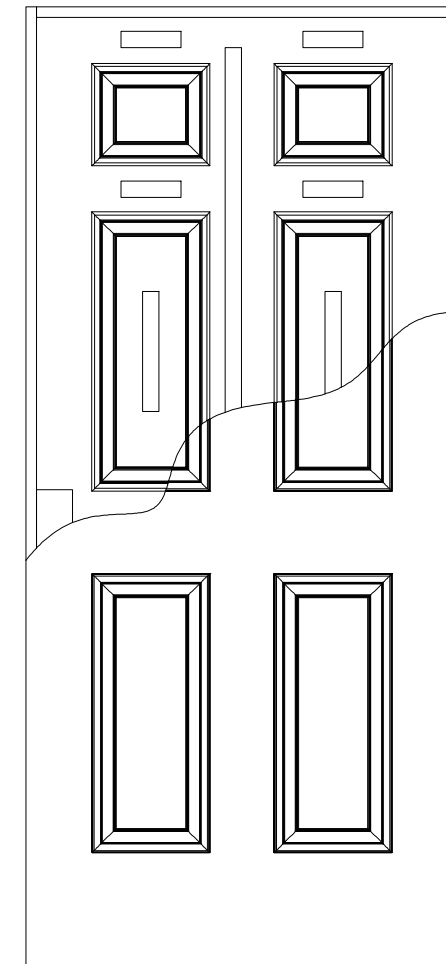

* HOLLOW CORE CONSTRUCTION MAY VARY BY REGION.

| | | |
|--|--|---|
| CREATION DATE: 1/6/2012 | | 3737 Lakeport Blvd. Klamath Falls, OR 97601 Phone: (800) 441-3884 www.jeld-wen.com |
| REV. DATE: | | |
| TITLE: MOLDED DOOR CONSTRUCTION DETAILS | | |
| DESCRIPTION: CORE OPTIONS | | |

© 2012 JELD-WEN, inc. ALL RIGHTS RESERVED.
NO DUPLICATION OR DISTRIBUTION PERMITTED.
JELD-WEN, inc. CONFIDENTIAL AND PROPRIETARY.

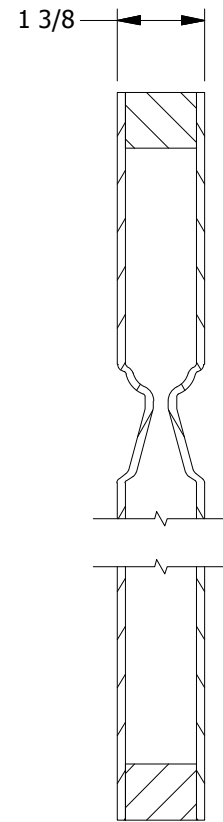
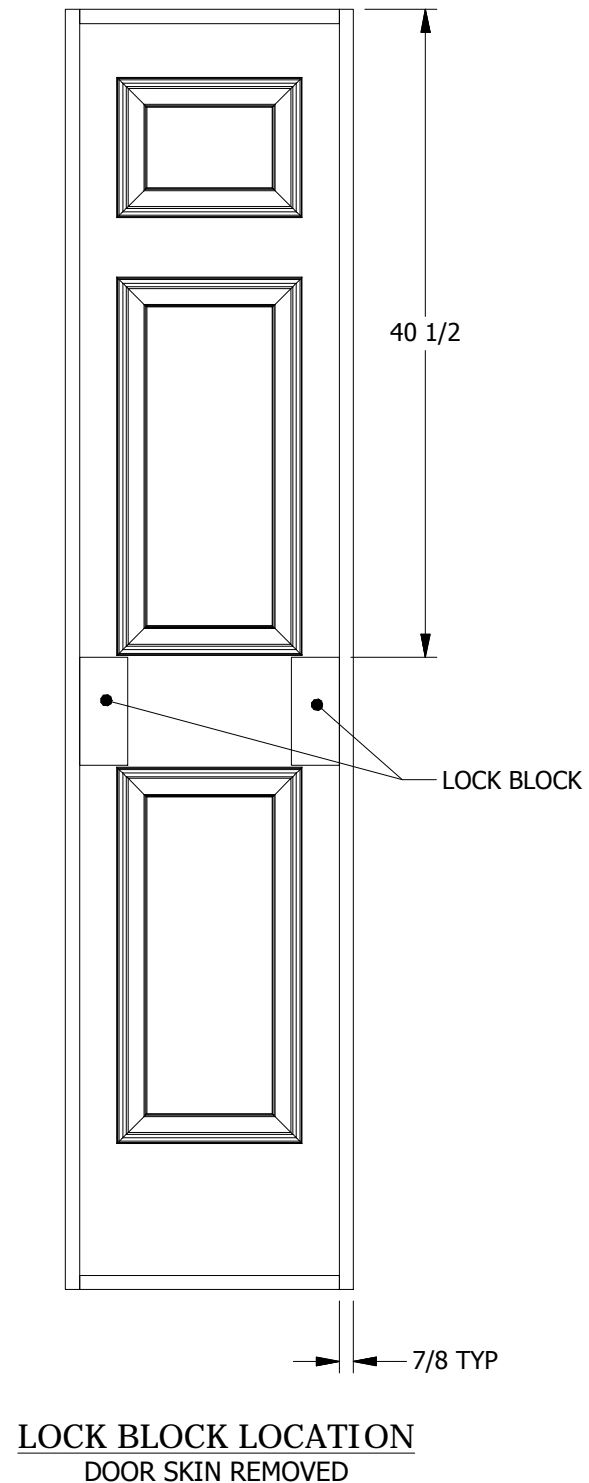
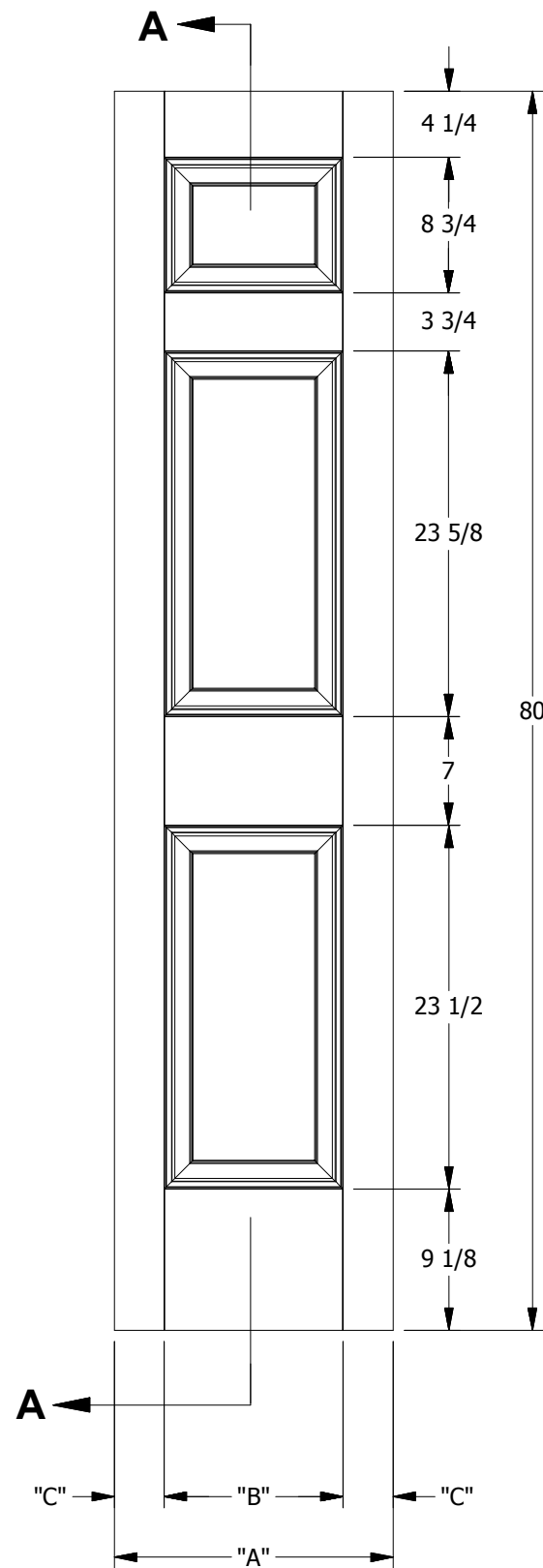

SECTION A-A

| DIMENSION TABLE | | | |
|-----------------|-----|----------|---------|
| DOOR SIZE | "A" | "B" | "C" |
| 1'-0" x 6'-8" | 12" | 7" | 2 1/2" |
| 1'-2" x 6'-8" | 14" | 7" | 3 1/2" |
| 1'-3" x 6'-8" | 15" | 7" | 4" |
| 1'-4" x 6'-8" | 16" | 7" | 4 1/2" |
| 1'-6" x 6'-8" | 18" | 11 9/16" | 3 7/32" |
| 1'-8" x 6'-8" | 20" | 11 9/16" | 4 7/32" |

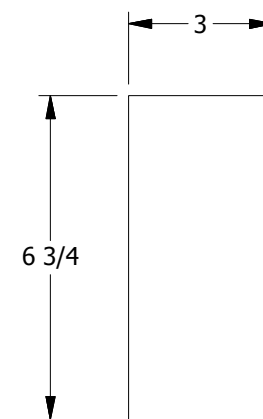

LOCK BLOCK
DETAIL



PANEL PROFILE : OVOLO STICKING

| | | |
|---|---|---|
| CREATION DATE: 2/6/2012 |  | 3737 Lakeport Blvd. Klamath Falls, OR 97601 Phone: (800) 441-3884 www.jeld-wen.com |
| REV. DATE: | | |
| TITLE: MOLDED INTERIOR DOOR | | |
| DESCRIPTION: COLONIAL PINE GRAIN 6'-8" 1'-0", 1'-2", 1'-3", 1'-4", 1'-6", 1'-8" | | |

© 2012 JELD-WEN, inc. ALL RIGHTS RESERVED.
NO DUPLICATION OR DISTRIBUTION PERMITTED.
JELD-WEN, inc. CONFIDENTIAL AND PROPRIETARY.

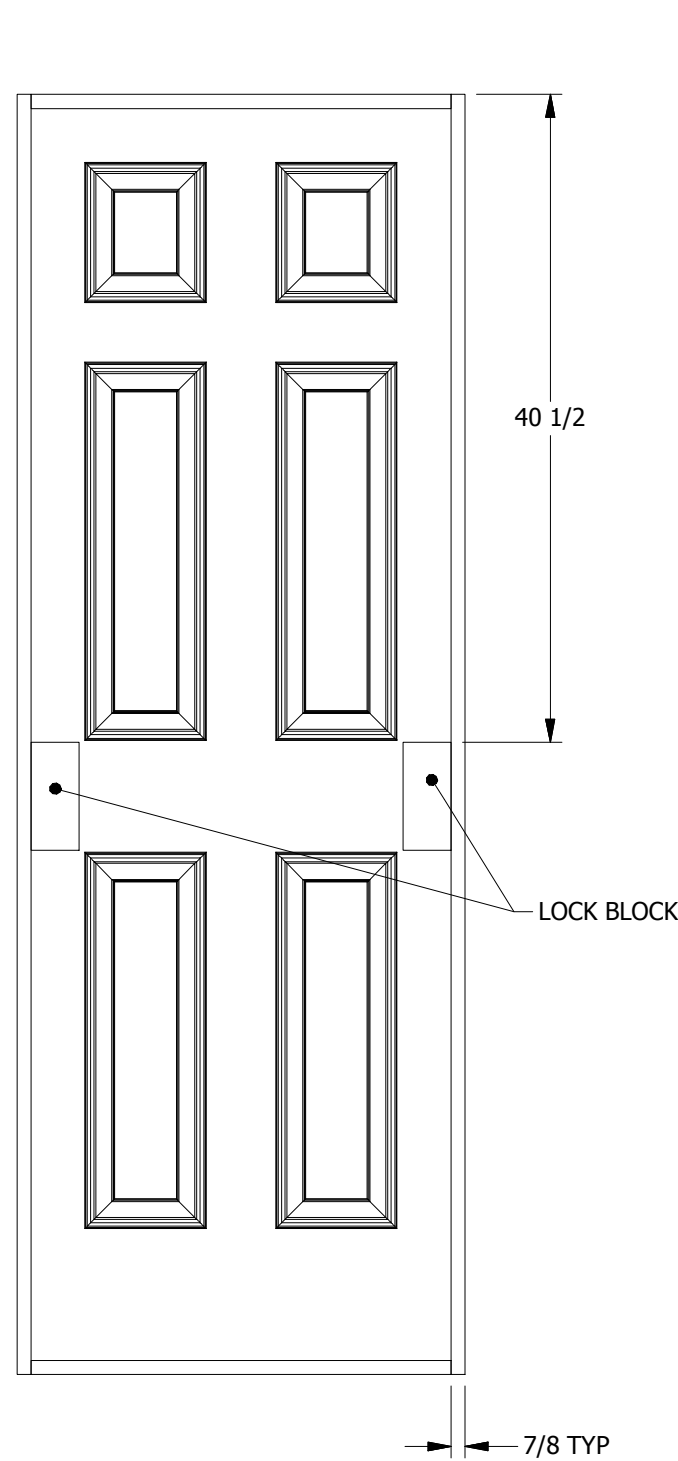
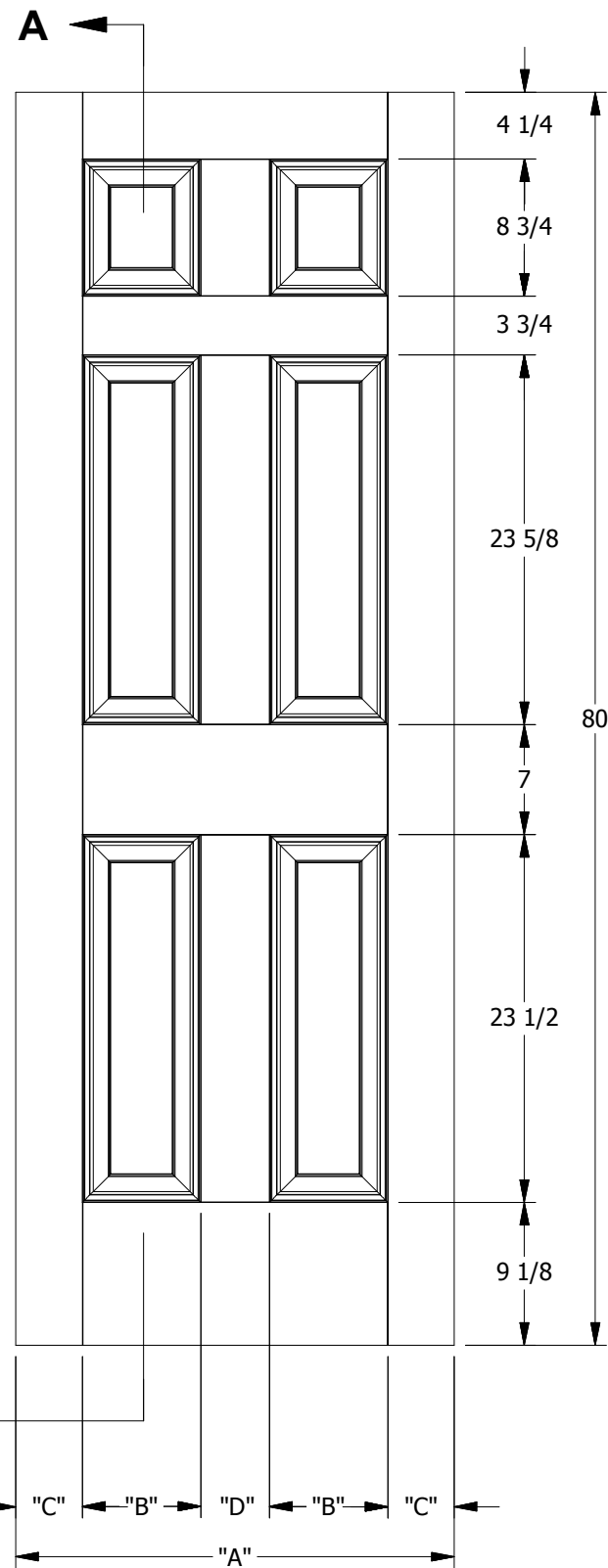

LOCK BLOCK LOCATION
DOOR SKIN REMOVED

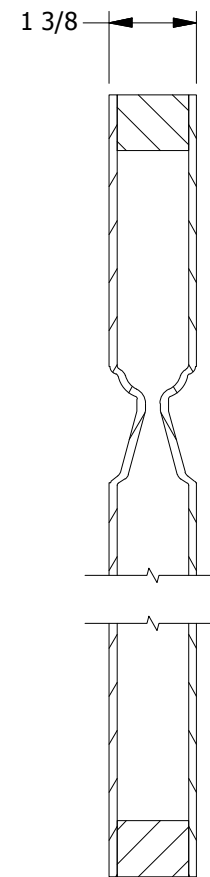

SECTION A-A

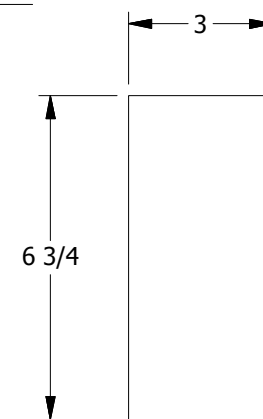

LOCK BLOCK
DETAIL

| DIMENSION TABLE | | | | |
|-----------------|-----|----------|--------|--------|
| DOOR SIZE | "A" | "B" | "C" | "D" |
| 1'-10" x 6'-8" | 22" | 5 9/16" | 3 1/4" | 4 3/8" |
| 2'-0" x 6'-8" | 24" | 5 9/16" | 4 1/4" | 4 3/8" |
| 2'-2" x 6'-8" | 26" | 7 9/16" | 3 1/4" | 4 3/8" |
| 2'-4" x 6'-8" | 28" | 7 9/16" | 4 1/4" | 4 3/8" |
| 2'-6" x 6'-8" | 30" | 8 9/16" | 4 1/4" | 4 3/8" |
| 2'-8" x 6'-8" | 32" | 9 9/16" | 4 1/4" | 4 3/8" |
| 2'-10" x 6'-8" | 34" | 10 9/16" | 4 1/4" | 4 3/8" |
| 3'-0" x 6'-8" | 36" | 11 9/16" | 4 1/4" | 4 3/8" |



PANEL PROFILE : OVOLO STICKING

| | | |
|----------------------------|--|---|
| CREATION DATE: 2/6/2012 | | 3737 Lakeport Blvd. Klamath Falls, OR 97601 Phone: (800) 441-3884 www.jeld-wen.com |
| REV. DATE: | | |
| TITLE: | MOLDED INTERIOR DOOR | |
| DESCRIPTION: | COLONIAL PINE GRAIN 6'-8" 1'-10", 2'-0", 2'-2", 2'-4", 2'-6", 2'-8", 2'-10", 3'-0" | |

© 2012 JELD-WEN, inc. ALL RIGHTS RESERVED.
 NO DUPLICATION OR DISTRIBUTION PERMITTED.
 JELD-WEN, inc. CONFIDENTIAL AND PROPRIETARY.

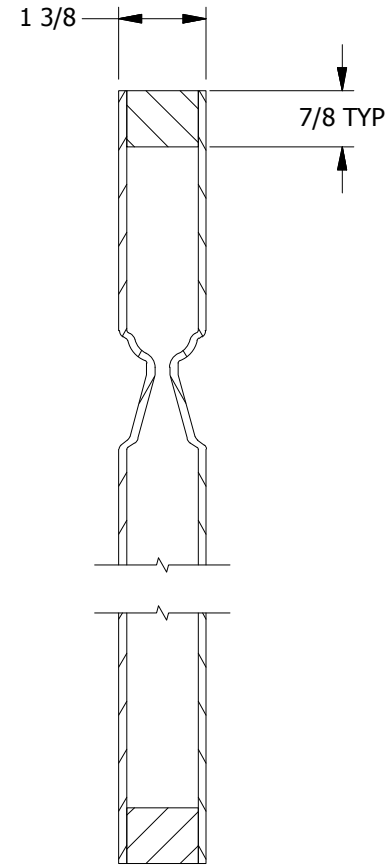
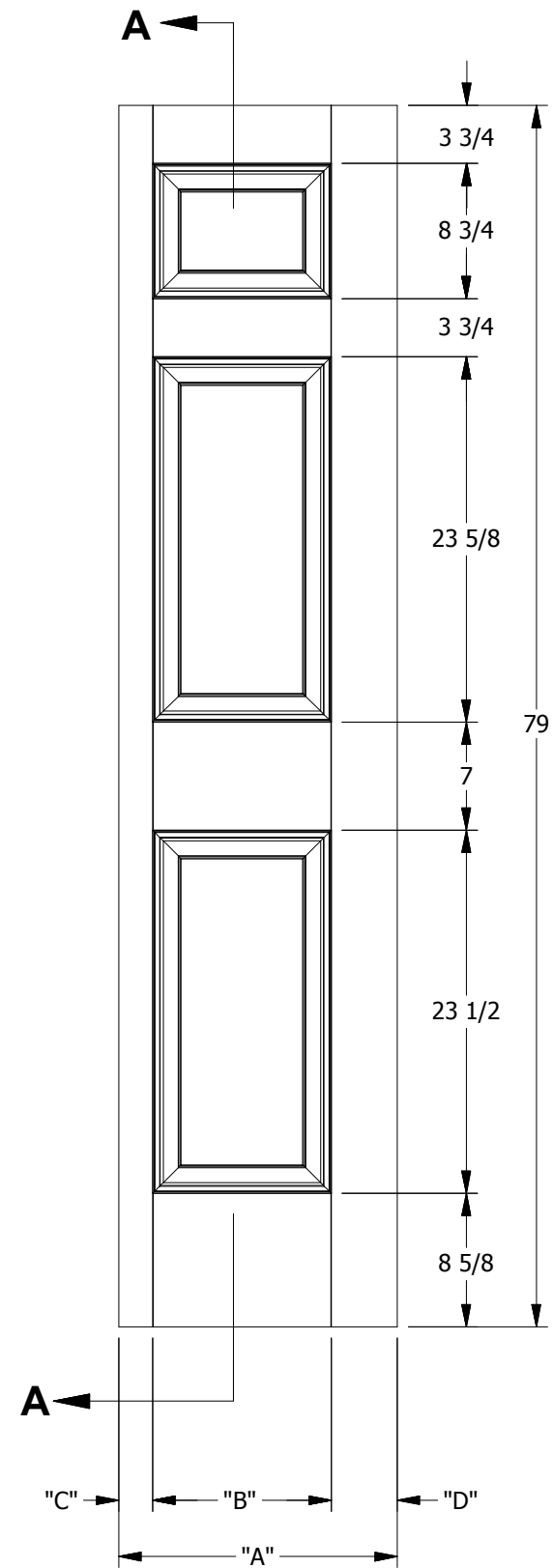

SECTION A-A

| DIMENSION TABLE | | | | |
|-----------------|-----|----------|---------|--------|
| DOOR SIZE | "A" | "B" | "C" | "D" |
| 1'-0" x 6'-8" | 12" | 5 9/16" | 2 3/16" | 4 1/4" |
| 1'-2" x 6'-8" | 14" | 7 9/16" | 2 3/16" | 4 1/4" |
| 1'-3" x 6'-8" | 15" | 8 9/16" | 2 3/16" | 4 1/4" |
| 1'-4" x 6'-8" | 16" | 9 9/16" | 2 3/16" | 4 1/4" |
| 1'-6" x 6'-8" | 18" | 11 9/16" | 2 3/16" | 4 1/4" |



PANEL PROFILE : OVOLO STICKING

| | | |
|---|---|---|
| CREATION DATE: 2/6/2012 |  | 3737 Lakeport Blvd. Klamath Falls, OR 97601 Phone: (800) 441-3884 www.jeld-wen.com |
| REV. DATE: | | |
| TITLE: MOLDED INTERIOR DOOR | | |
| DESCRIPTION: COLONIAL BI-FOLD PINE GRAIN 6' - 8" 1'-0", 1'-2", 1'-3", 1'-4", 1'-6" | | |

© 2012 JELD-WEN, inc. ALL RIGHTS RESERVED.
NO DUPLICATION OR DISTRIBUTION PERMITTED.
JELD-WEN, inc. CONFIDENTIAL AND PROPRIETARY.

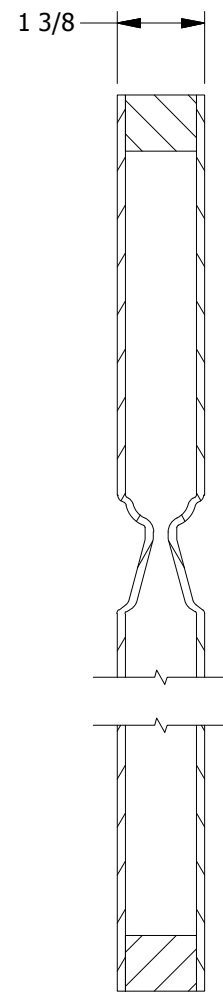
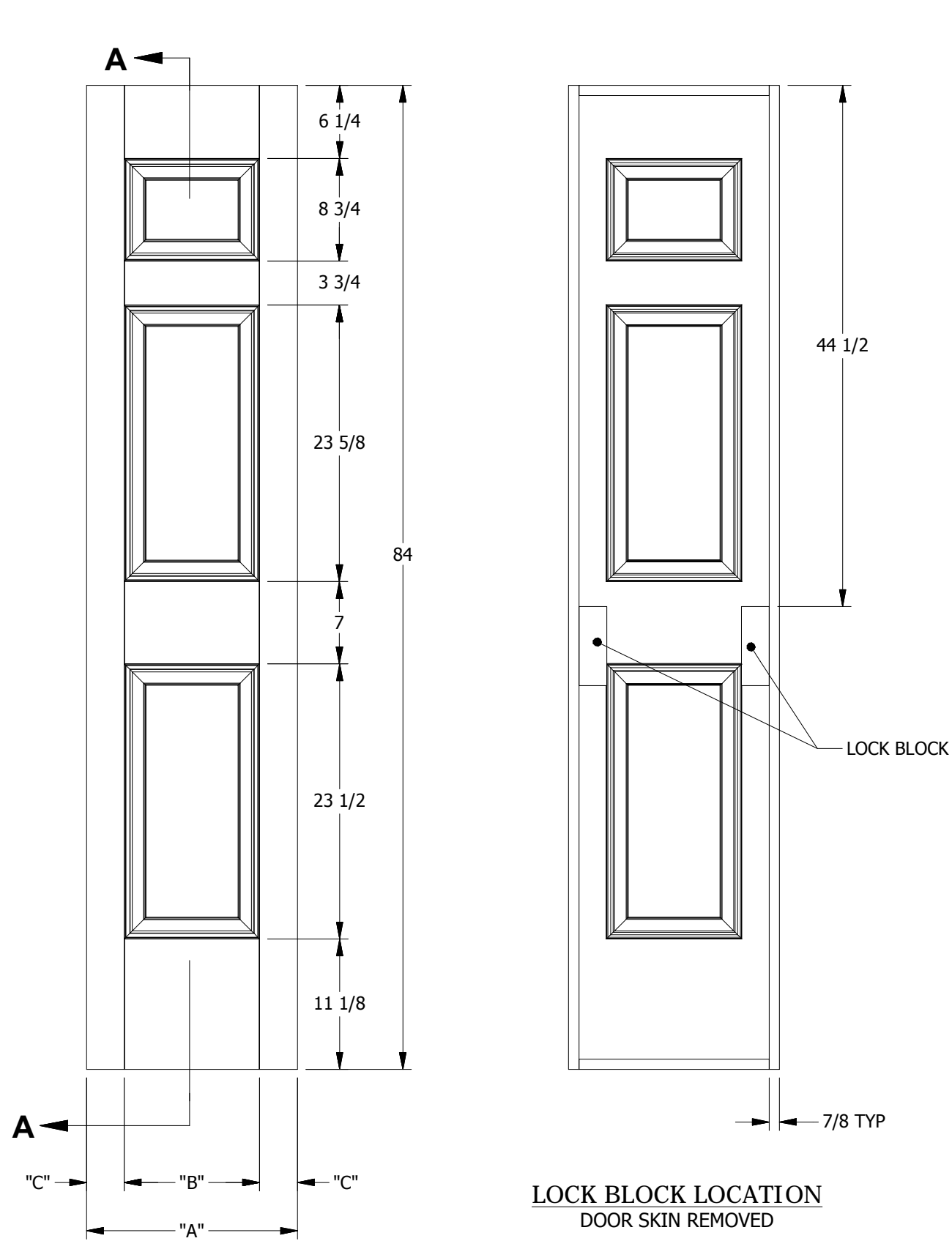

| DIMENSION TABLE | | | | |
|-----------------|-----|----------|---------|--------|
| DOOR SIZE | "A" | "B" | "C" | "D" |
| 1'-0" x 7'-0" | 12" | 7" | 2 1/2" | 1 5/8" |
| 1'-2" x 7'-0" | 14" | 7" | 3 1/2" | 2 5/8" |
| 1'-3" x 7'-0" | 15" | 7" | 4" | 3" |
| 1'-4" x 7'-0" | 16" | 7" | 4 1/2" | 3" |
| 1'-6" x 7'-0" | 18" | 11 9/16" | 3 7/32" | 2 3/8" |
| 1'-8" x 7'-0" | 20" | 11 9/16" | 4 7/32" | 3" |

SECTION A-A

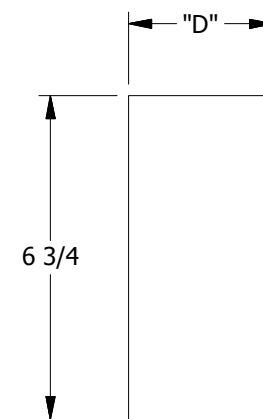

LOCK BLOCK
DETAIL



PANEL PROFILE : OVOLO STICKING

| | | |
|----------------------------|---|---|
| CREATION DATE: 2/6/2012 | | 3737 Lakeport Blvd. Klamath Falls, OR 97601 Phone: (800) 441-3884 www.jeld-wen.com |
| REV. DATE: | | |
| TITLE: | MOLDED INTERIOR DOOR | |
| DESCRIPTION: | COLONIAL PINE GRAIN 7'-0" 1'-0", 1'-2", 1'-3", 1'-4", 1'-6", 1'-8" | |

© 2012 JELD-WEN, inc. ALL RIGHTS RESERVED.
NO DUPLICATION OR DISTRIBUTION PERMITTED.
JELD-WEN, inc. CONFIDENTIAL AND PROPRIETARY.

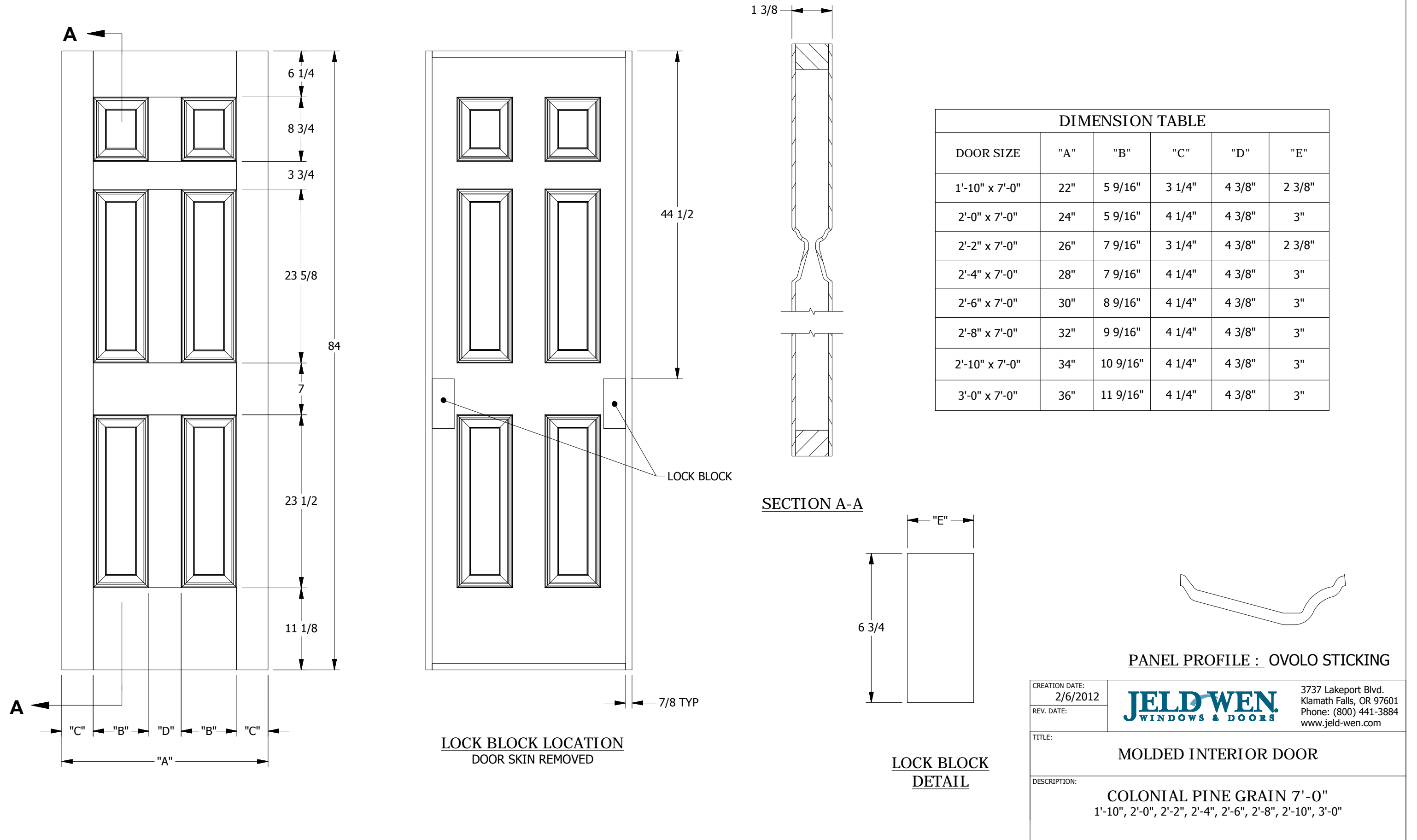

© 2012 JELD-WEN, inc. ALL RIGHTS RESERVED.
NO DUPLICATION OR DISTRIBUTION PERMITTED.
JELD-WEN, inc. CONFIDENTIAL AND PROPRIETARY.

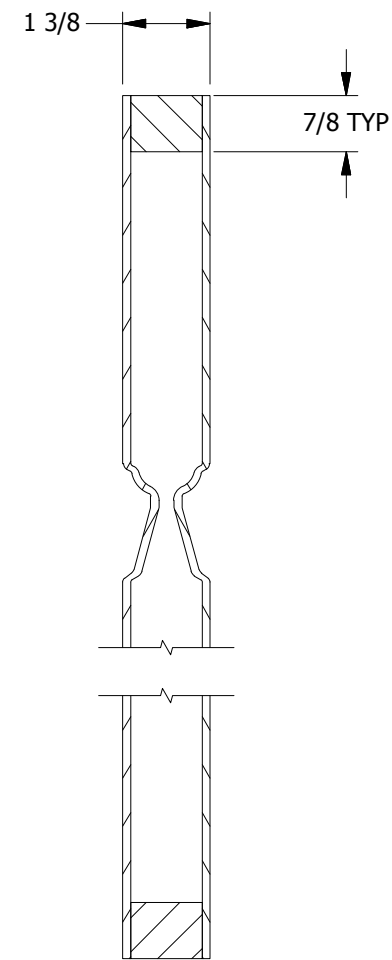
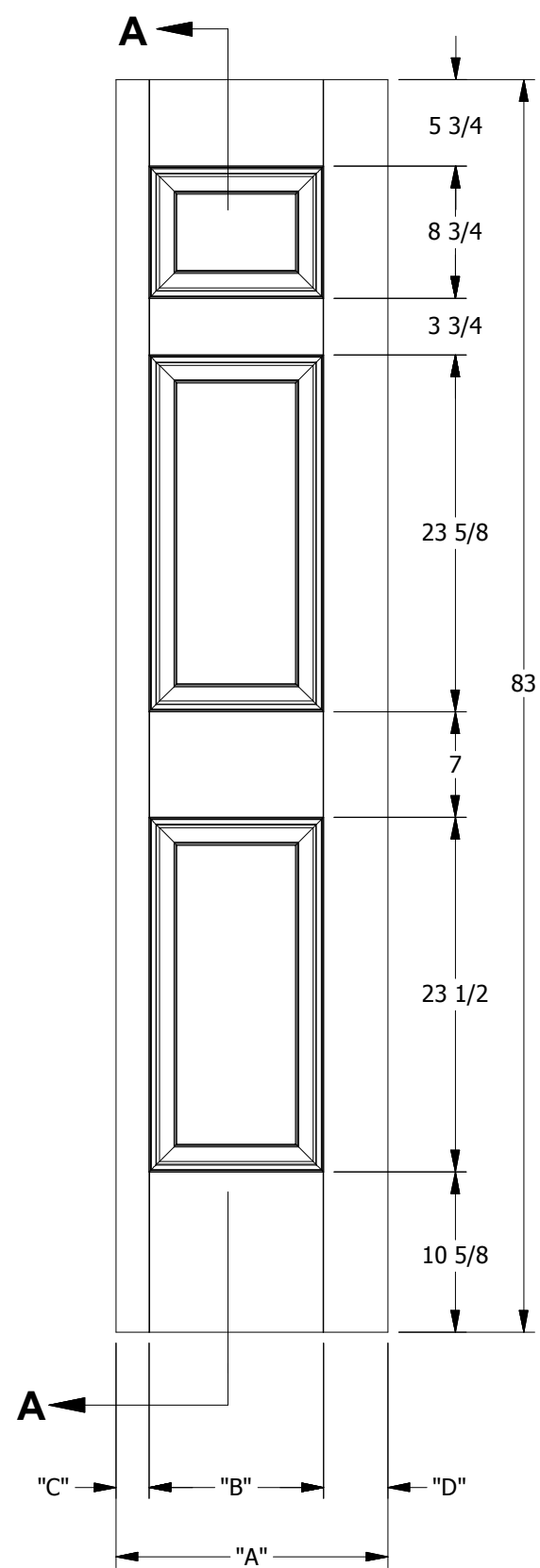

SECTION A-A

| DIMENSION TABLE | | | | |
|-----------------|-----|----------|---------|--------|
| DOOR SIZE | "A" | "B" | "C" | "D" |
| 1'-0" x 7'-0" | 12" | 5 9/16" | 2 3/16" | 4 1/4" |
| 1'-2" x 7'-0" | 14" | 7 9/16" | 2 3/16" | 4 1/4" |
| 1'-3" x 7'-0" | 15" | 8 9/16" | 2 3/16" | 4 1/4" |
| 1'-4" x 7'-0" | 16" | 9 9/16" | 2 3/16" | 4 1/4" |
| 1'-6" x 7'-0" | 18" | 11 9/16" | 2 3/16" | 4 1/4" |



PANEL PROFILE : OVOLO STICKING

| | | |
|---|--|---|
| CREATION DATE: 2/6/2012 | | 3737 Lakeport Blvd. Klamath Falls, OR 97601 Phone: (800) 441-3884 www.jeld-wen.com |
| REV. DATE: | | |
| TITLE: MOLDED INTERIOR DOOR | | |
| DESCRIPTION: COLONIAL BI-FOLD PINE GRAIN 7'-0" 1'-0", 1'-2", 1'-3", 1'-4", 1'-6" | | |

© 2012 JELD-WEN, inc. ALL RIGHTS RESERVED.
 NO DUPLICATION OR DISTRIBUTION PERMITTED.
 JELD-WEN, inc. CONFIDENTIAL AND PROPRIETARY.

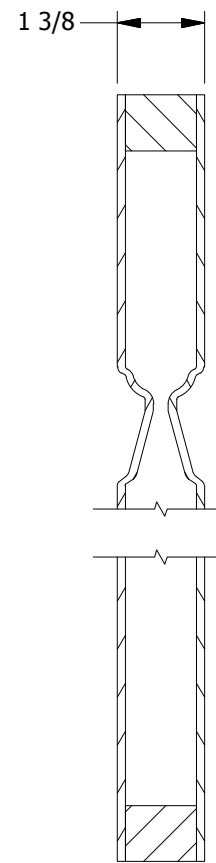
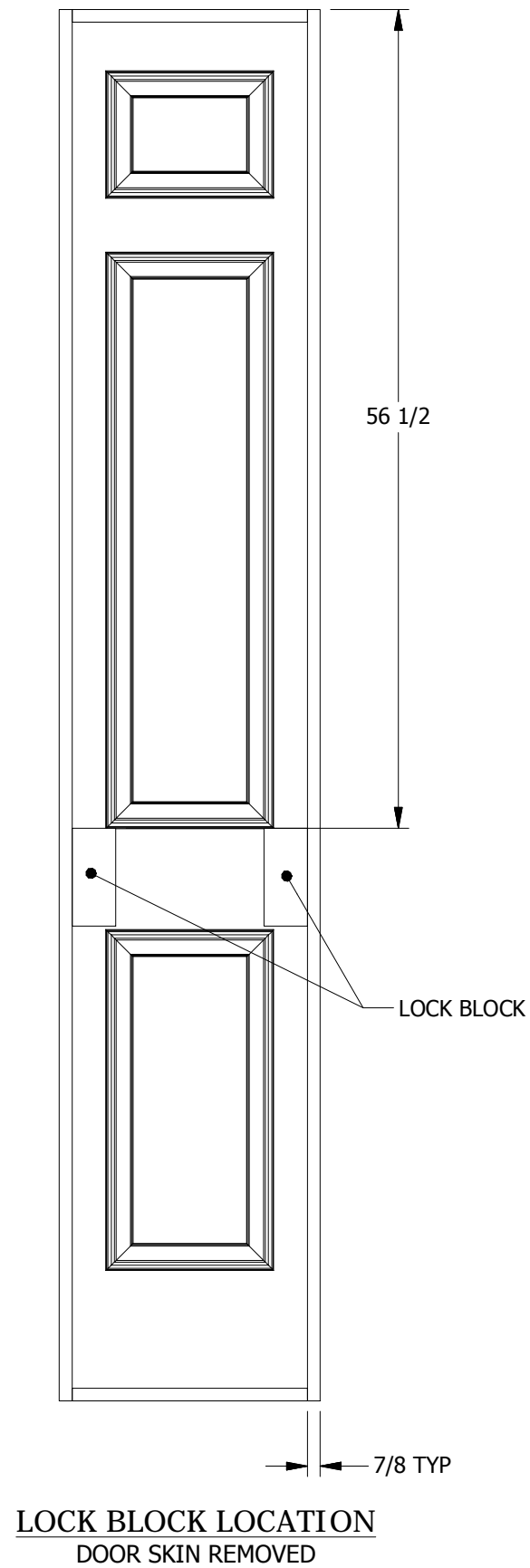
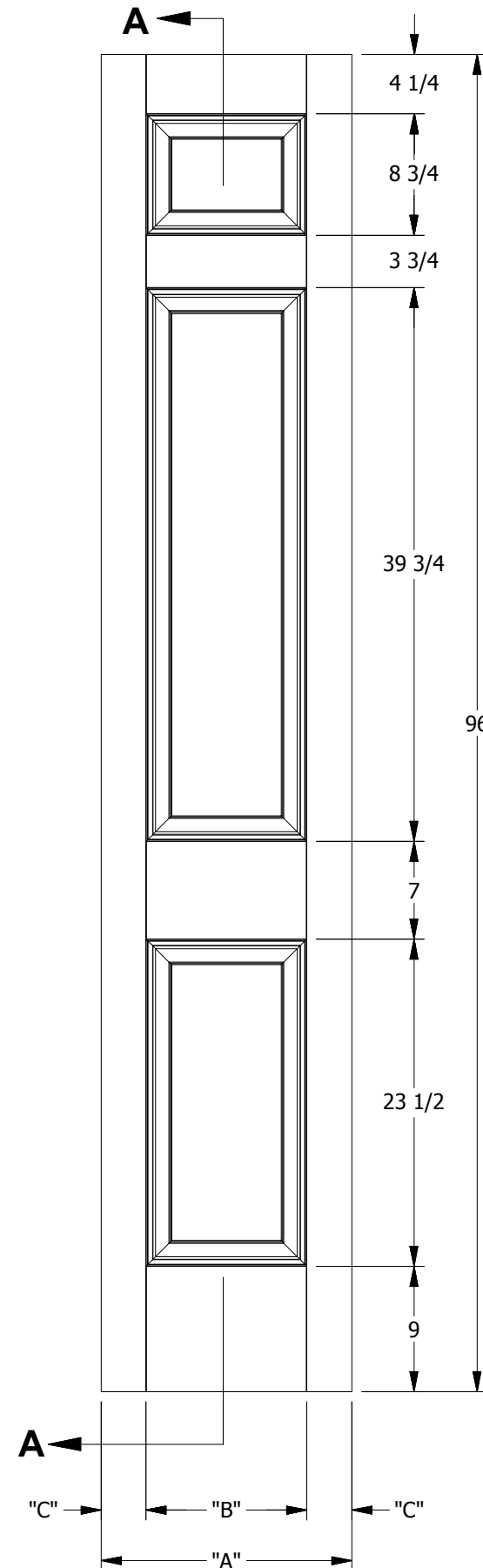

SECTION A-A

| DIMENSION TABLE | | | |
|-----------------|-----|----------|---------|
| DOOR SIZE | "A" | "B" | "C" |
| 1'-6" x 8'-0" | 18" | 9 9/16" | 4 7/32" |
| 1'-8" x 8'-0" | 20" | 11 9/16" | 4 7/32" |

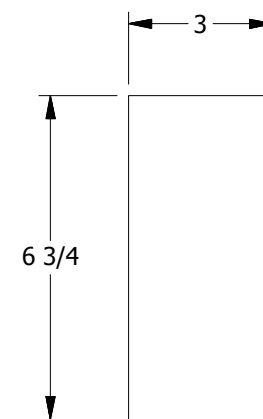

LOCK BLOCK
DETAIL



PANEL PROFILE : OVOLO STICKING

| | | |
|---|---|---|
| CREATION DATE: 2/6/2012 |  | 3737 Lakeport Blvd. Klamath Falls, OR 97601 Phone: (800) 441-3884 www.jeld-wen.com |
| REV. DATE: | | |
| TITLE: MOLDED INTERIOR DOOR | | |
| DESCRIPTION: COLONIAL PINE GRAIN 8'-0" 1'-6", 1'-8" | | |

© 2012 JELD-WEN, inc. ALL RIGHTS RESERVED.
NO DUPLICATION OR DISTRIBUTION PERMITTED.
JELD-WEN, inc. CONFIDENTIAL AND PROPRIETARY.

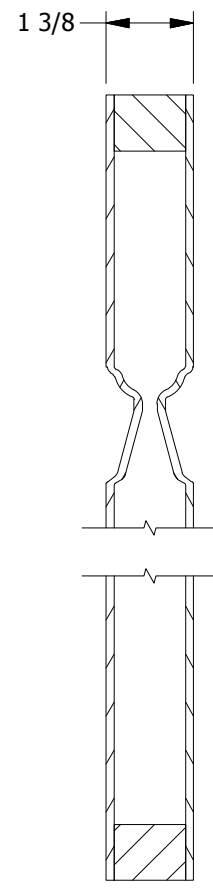
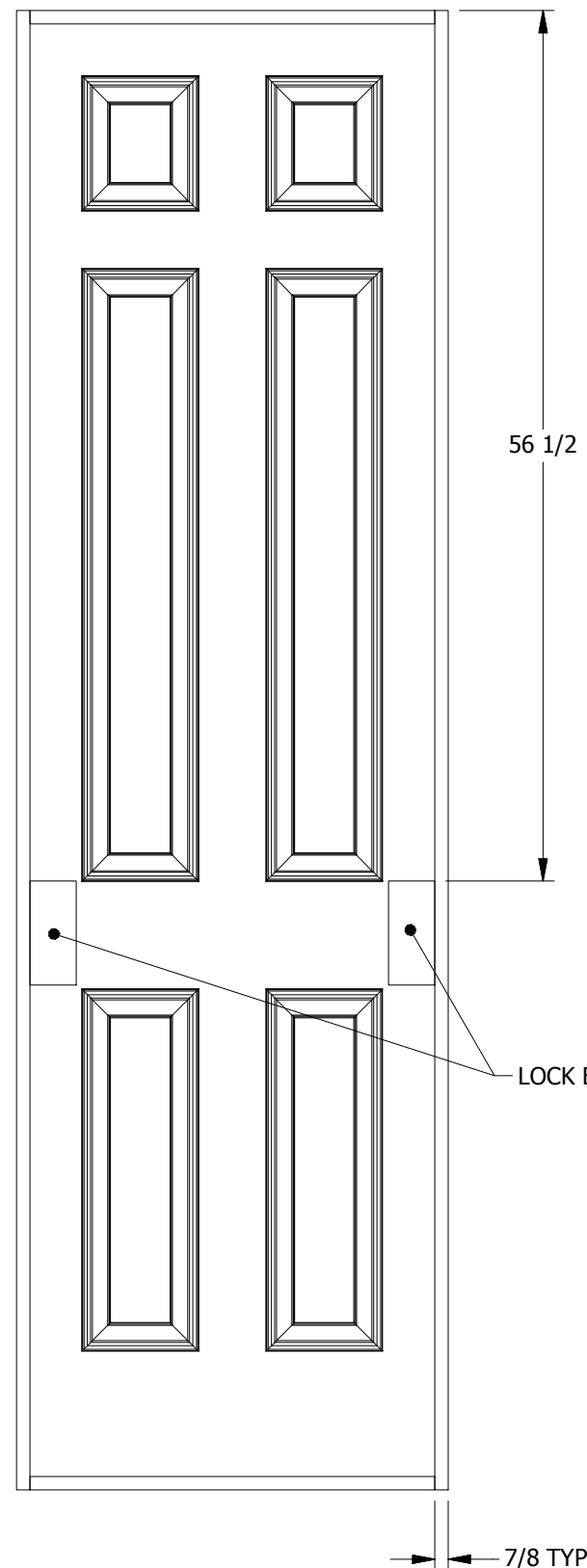
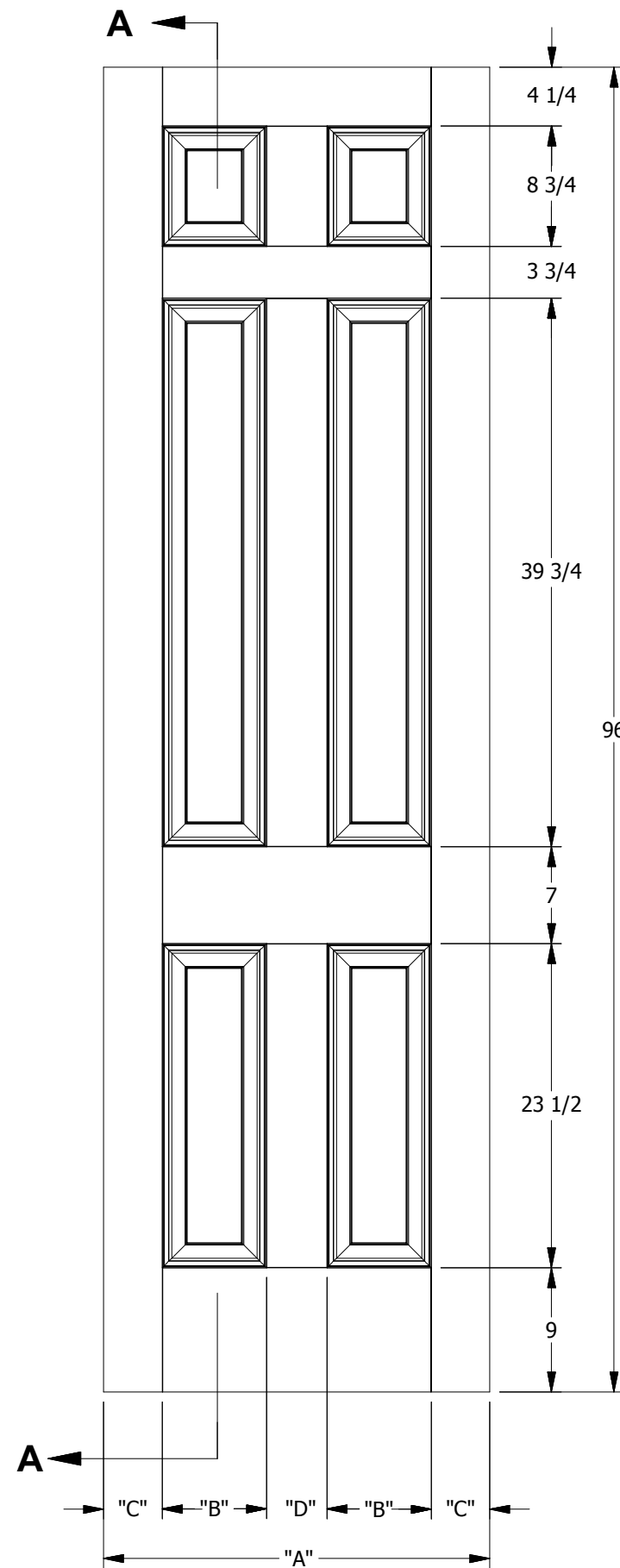

| DIMENSION TABLE | | | | |
|-----------------|-----|----------|--------|--------|
| DOOR SIZE | "A" | "B" | "C" | "D" |
| 1'-10" x 8'-0" | 22" | 5 9/16" | 3 1/4" | 4 3/8" |
| 2'-0" x 8'-0" | 24" | 5 9/16" | 4 1/4" | 4 3/8" |
| 2'-2" x 8'-0" | 26" | 7 9/16" | 3 1/4" | 4 3/8" |
| 2'-4" x 8'-0" | 28" | 7 9/16" | 4 1/4" | 4 3/8" |
| 2'-6" x 8'-0" | 30" | 8 9/16" | 4 1/4" | 4 3/8" |
| 2'-8" x 8'-0" | 32" | 9 9/16" | 4 1/4" | 4 3/8" |
| 3'-0" x 8'-0" | 36" | 11 9/16" | 4 1/4" | 4 3/8" |

SECTION A-A

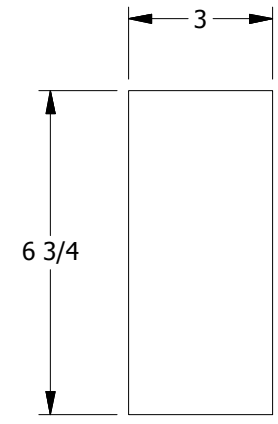

LOCK BLOCK

LOCK BLOCK LOCATION
DOOR SKIN REMOVED

LOCK BLOCK
DETAIL

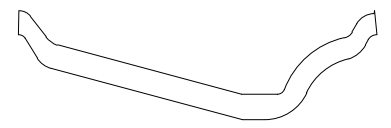

PANEL PROFILE : OVOLO STICKING

| | | |
|---|--|---|
| CREATION DATE: 2/6/2012 | | 3737 Lakeport Blvd. Klamath Falls, OR 97601 Phone: (800) 441-3884 www.jeld-wen.com |
| REV. DATE: | | |
| TITLE: MOLDED INTERIOR DOOR | | |
| DESCRIPTION: COLONIAL PINE GRAIN 8'-0" 1'-10", 2'-0", 2'-2", 2'-4", 2'-6", 2'-8", 2'-10", 3'-0" | | |

© 2012 JELD-WEN, inc. ALL RIGHTS RESERVED.
NO DUPLICATION OR DISTRIBUTION PERMITTED.
JELD-WEN, inc. CONFIDENTIAL AND PROPRIETARY.

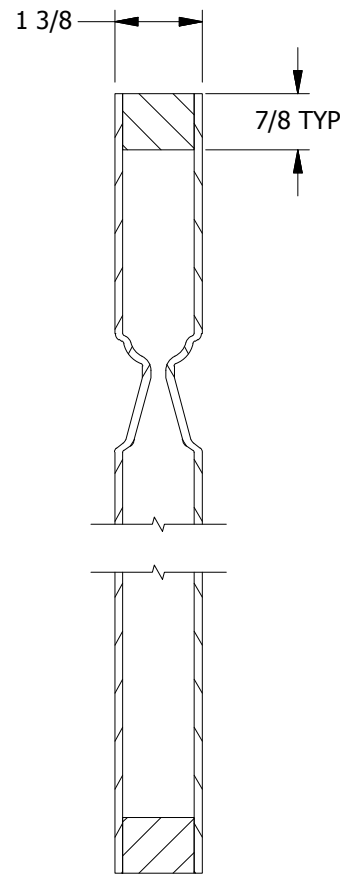
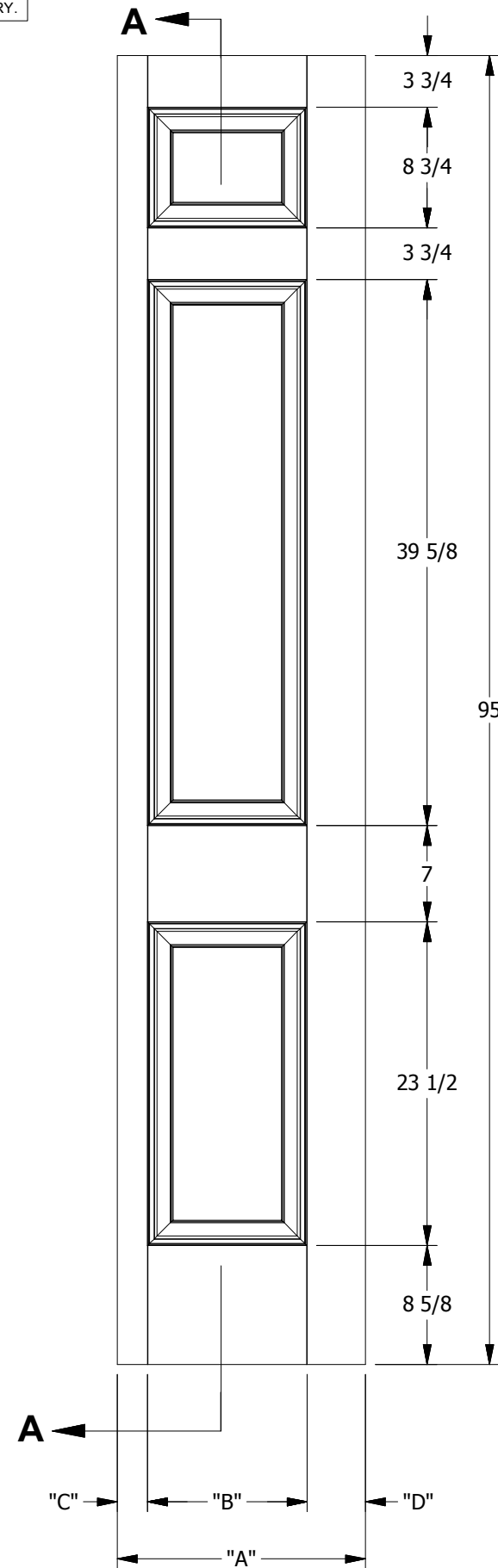

SECTION A-A

| DIMENSION TABLE | | | | |
|-----------------|-----|----------|---------|--------|
| DOOR SIZE | "A" | "B" | "C" | "D" |
| 1'-0" x 8'-0" | 12" | 5 9/16" | 2 3/16" | 4 1/4" |
| 1'-2" x 8'-0" | 14" | 7 9/16" | 2 3/16" | 4 1/4" |
| 1'-3" x 8'-0" | 15" | 8 9/16" | 2 3/16" | 4 1/4" |
| 1'-4" x 8'-0" | 16" | 9 9/16" | 2 3/16" | 4 1/4" |
| 1'-6" x 8'-0" | 18" | 11 9/16" | 2 3/16" | 4 1/4" |



PANEL PROFILE : OVOLO STICKING

| | | |
|---|--|---|
| CREATION DATE: 2/6/2012 | | 3737 Lakeport Blvd. Klamath Falls, OR 97601 Phone: (800) 441-3884 www.jeld-wen.com |
| REV. DATE: | | |
| TITLE: MOLDED INTERIOR DOOR | | |
| DESCRIPTION: COLONIAL BI-FOLD PINE GRAIN 8'-0" 1'-0", 1'-2", 1'-3", 1'-4", 1'-6" | | |