



Molded Interior Door
Santa Fe

Product Detail Sheets

Table of Contents

Construction Details..... 3

6' - 8" Standard Doors



2-Panel

1' - 0" thru 1' - 8"

.....pg. 4

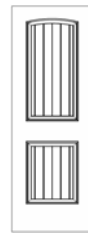

2-Panel

1' - 10" thru 3' - 0"

.....pg. 5

6' - 8" Bi-Fold Doors



2-Panel Bi-Fold

1' - 0" thru 1' - 6"

.....pg. 6

7' - 0" Standard Doors



2-Panel

1' - 0" thru 1' - 8"

.....pg. 7

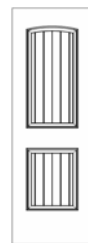

2-Panel

1' - 10" thru 3' - 0"

.....pg. 8



Molded Interior Door Santa Fe

Product Detail Sheets Table of Contents

7' - 0" Bi-Fold Doors



2-Panel Bi-Fold

1' - 0" thru 1' - 6"

.....pg. 9

8' - 0" Standard Doors



2-Panel

1' - 0" thru 1' - 8"

.....pg. 10

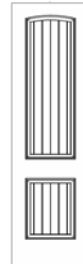

2-Panel

1' - 10" thru 3' - 0"

.....pg. 11

8' - 0" Bi-Fold Doors



2-Panel Bi-Fold

1' - 0" thru 1' - 6"

.....pg. 12

© 2012JELD-WEN, inc. ALL RIGHTS RESERVED.
NO DUPLICATION OR DISTRIBUTION PERMITTED.
JELD-WEN, inc. CONFIDENTIAL AND PROPRIETARY.

**SOLID PARTICLEBOARD CORE -
COMBINATION WOOD / MDF OR
ALL-WOOD FRAME**

1 3/8" DOOR
1 3/4" DOOR

20-MINUTE FIRE RATING AVAILABLE FOR 1 3/4"
UP TO 3'-0" x 8'0"

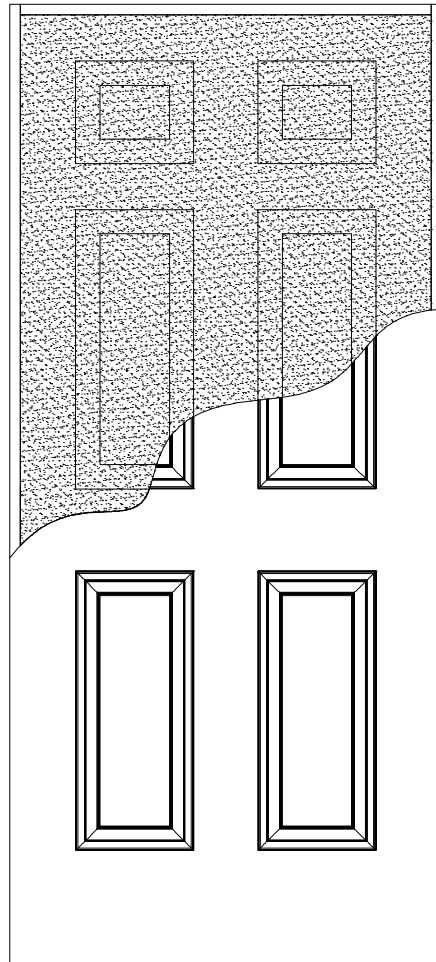

**WIDE STILE WITH SOLID
PARTICLEBOARD CORE -
WOOD FRAME**

1 3/4" DOOR

20-MINUTE FIRE RATING

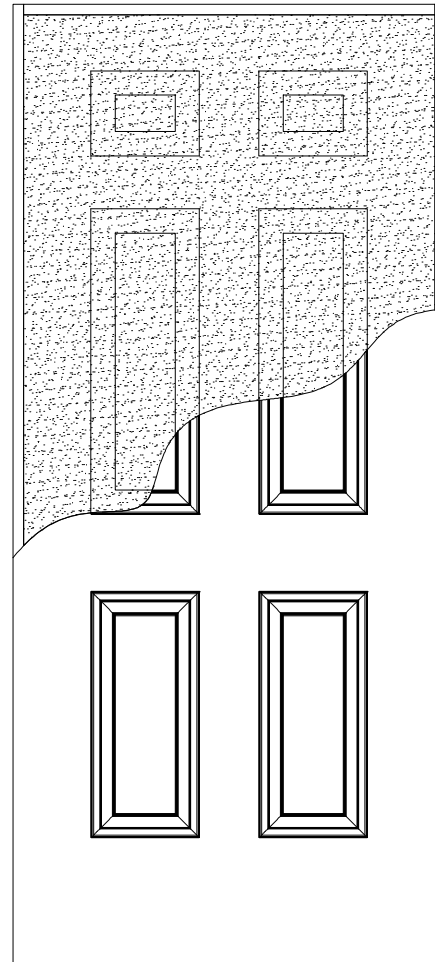

**SOLID MINERAL CORE -
ALL-WOOD FRAME**

1 3/4" DOOR

45- MINUTE FIRE RATINGS UP TO 3'-0" x 8'-0",
MANUFACTURED TO THE CURRENT
MARSHFIELD DOOR SYSTEMS SPECIFICATIONS
60- MINUTE FIRE RATINGS UP TO 3'-0" x 8'-0",
MANUFACTURED TO THE CURRENT
GEORGIA-PACIFIC OR MARSHFIELD DOOR SYSTEMS
SPECIFICATIONS

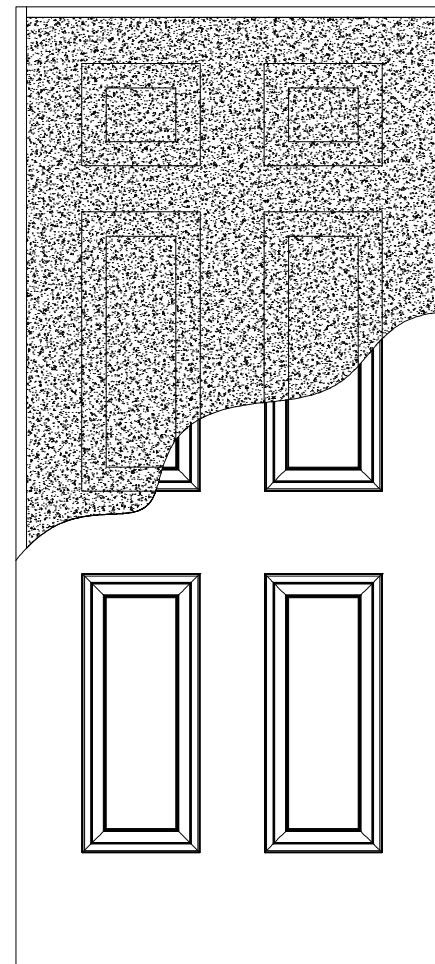

**HOLLOW CORE -
MDF FRAME**

1 3/8" DOOR

BLOCKING BEHIND PANELS FOR SUPPORT*

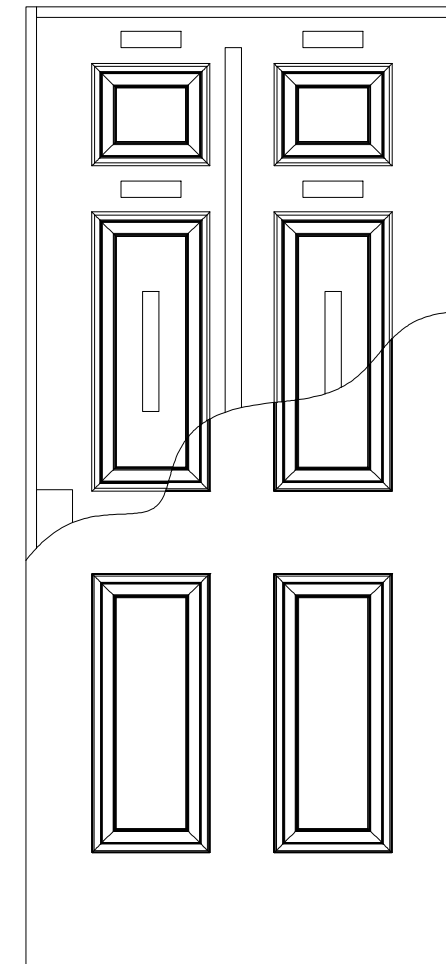

* HOLLOW CORE CONSTRUCTION MAY VARY BY REGION.

CREATION DATE: 1/6/2012		3737 Lakeport Blvd. Klamath Falls, OR 97601 Phone: (800) 441-3884 www.jeld-wen.com
REV. DATE:		
TITLE: MOLDED DOOR CONSTRUCTION DETAILS		
DESCRIPTION: CORE OPTIONS		

© 2012 JELD-WEN, inc. ALL RIGHTS RESERVED.
 NO DUPLICATION OR DISTRIBUTION PERMITTED.
 JELD-WEN, inc. CONFIDENTIAL AND PROPRIETARY.

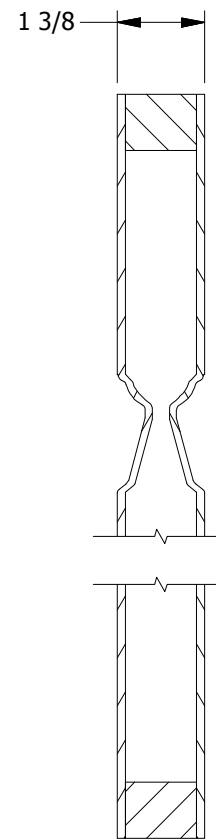
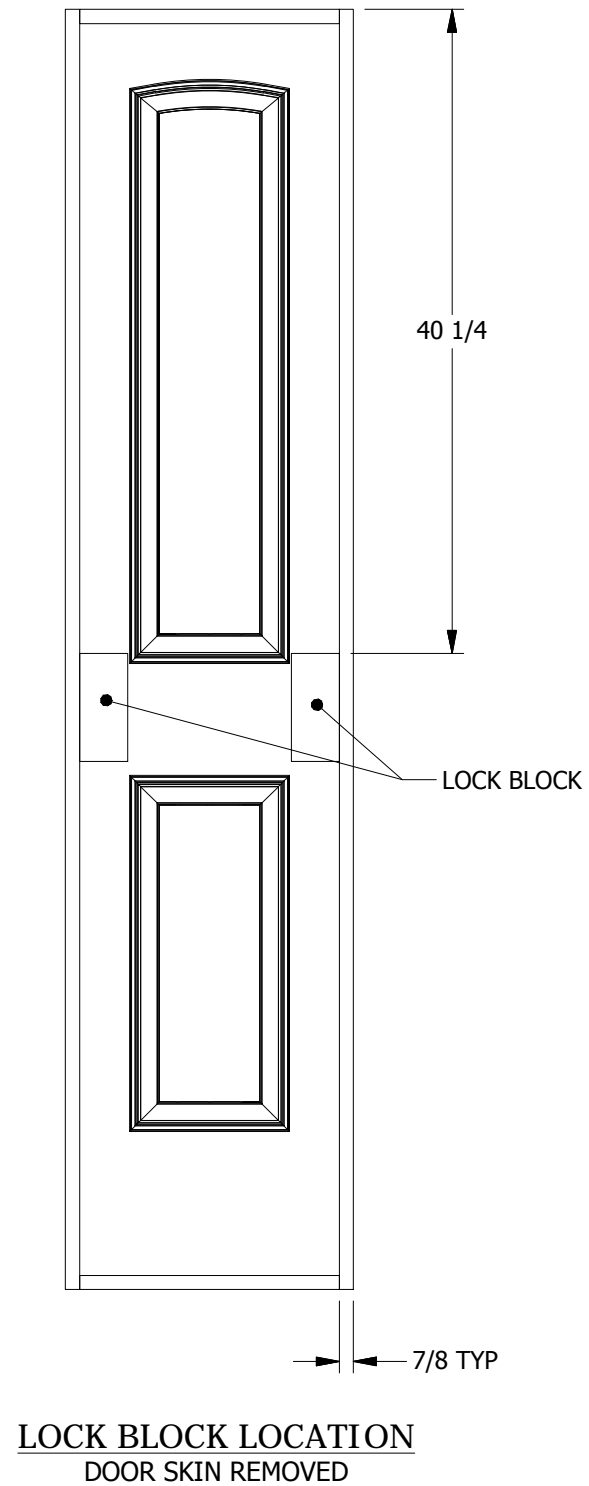
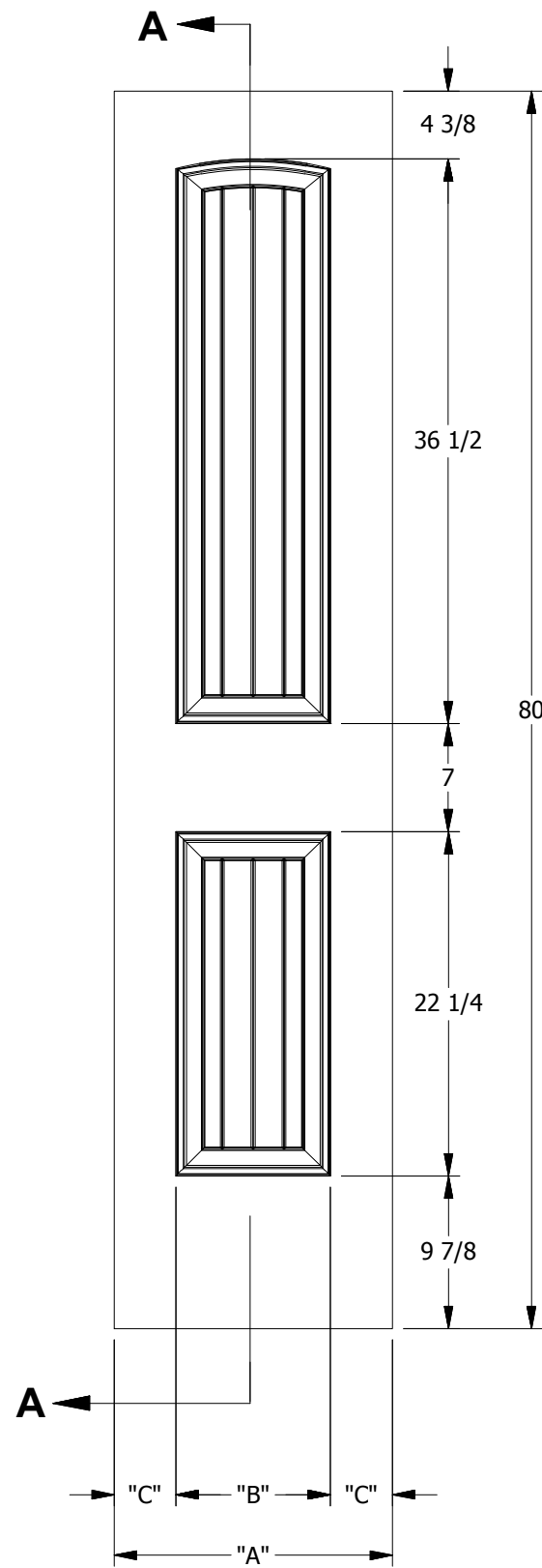

SECTION A-A

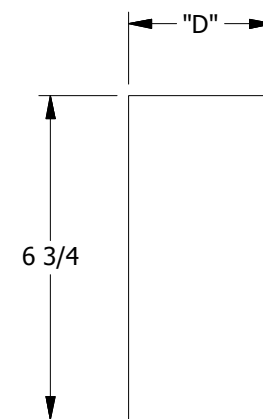

LOCK BLOCK
DETAIL

DIMENSION TABLE				
DOOR SIZE	"A"	"B"	"C"	"D"
1'-0" x 6'-8"	12"	7"	2 1/2"	1 5/8"
1'-2" x 6'-8"	14"	7"	3 1/2"	2 5/8"
1'-3" x 6'-8"	15"	7"	4"	3"
1'-4" x 6'-8"	16"	7"	4 1/2"	3"
1'-6" x 6'-8"	18"	10"	4"	3"
1'-8" x 6'-8"	20"	10"	5"	3"

PANEL PROFILE : OVOLO STICKING

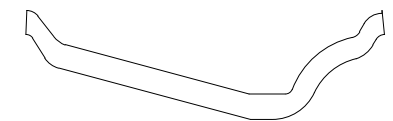

CREATION DATE: 2/6/2012		3737 Lakeport Blvd. Klamath Falls, OR 97601 Phone: (800) 441-3884 www.jeld-wen.com
REV. DATE:		
TITLE:	MOLDED INTERIOR DOOR	
DESCRIPTION:	SANTA FE SMOOTH 6'-8" 1'-0", 1'-2", 1'-3", 1'-4", 1'-6", 1'-8"	

© 2012 JELD-WEN, inc. ALL RIGHTS RESERVED.
NO DUPLICATION OR DISTRIBUTION PERMITTED.
JELD-WEN, inc. CONFIDENTIAL AND PROPRIETARY.

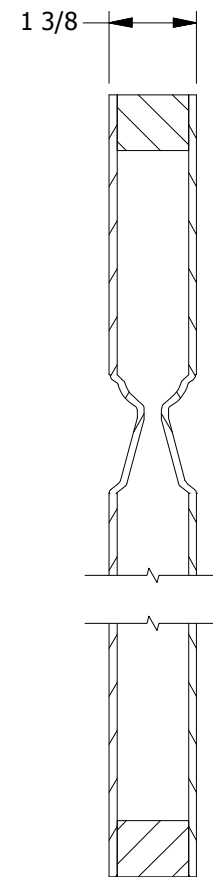
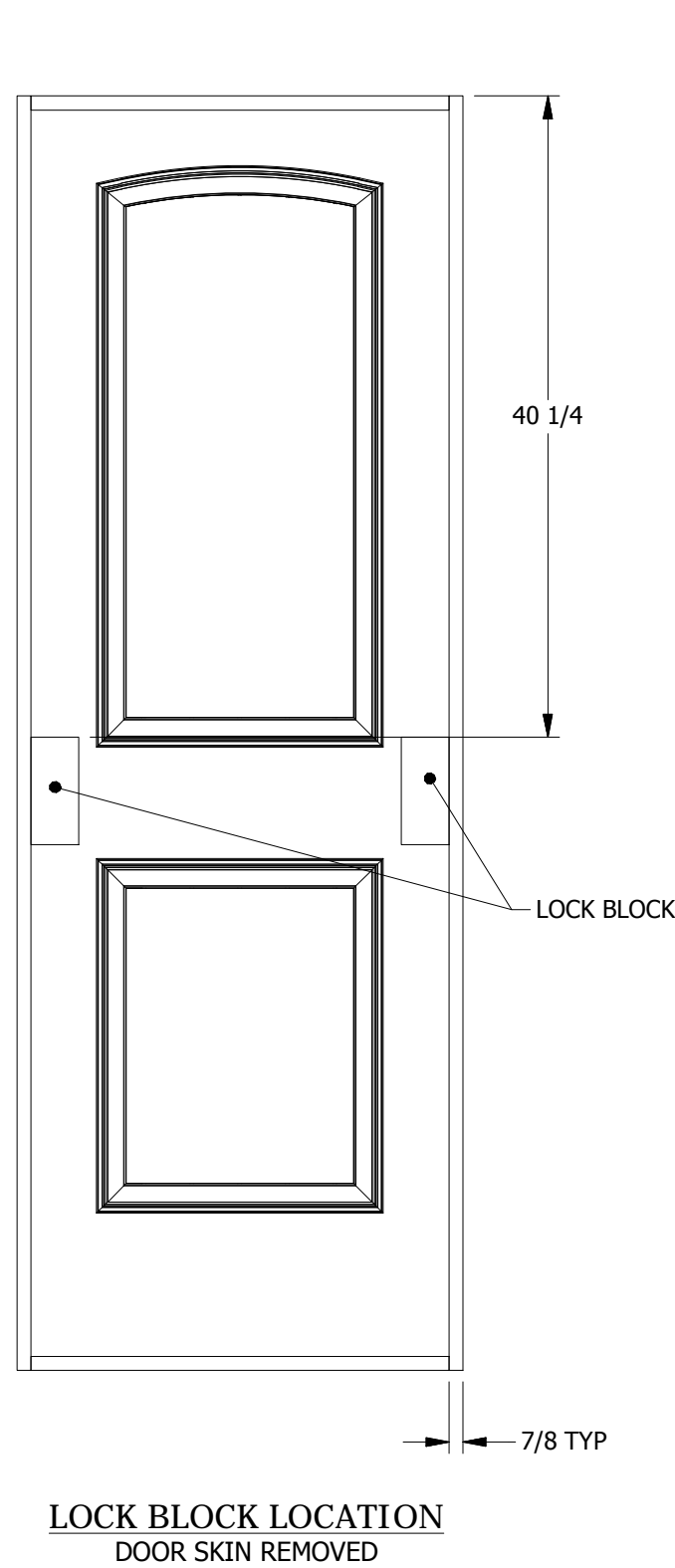
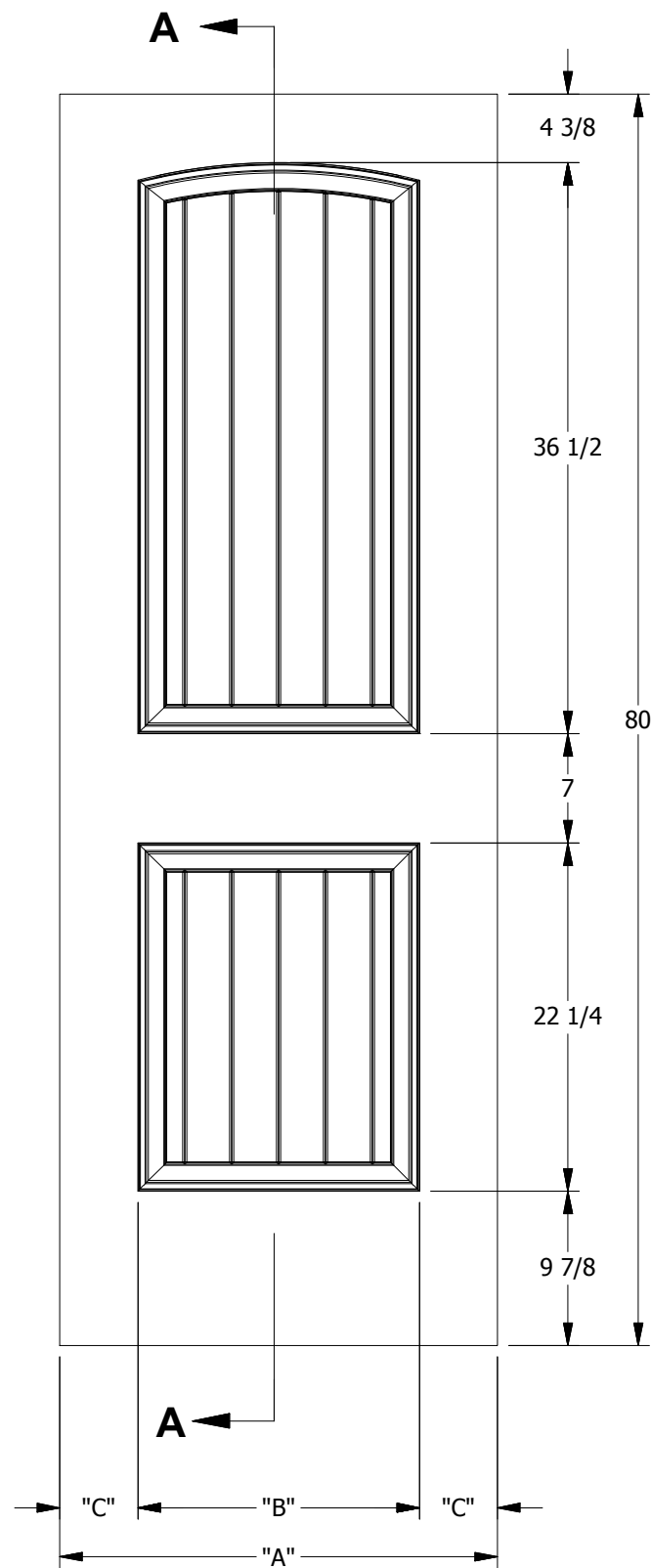

SECTION A-A

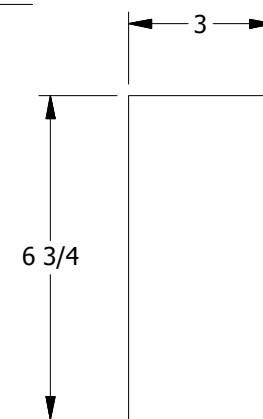

LOCK BLOCK
DETAIL

DIMENSION TABLE			
DOOR SIZE	"A"	"B"	"C"
1'-10" x 6'-8"	22"	14"	4"
2'-0" x 6'-8"	24"	14"	5"
2'-2" x 6'-8"	26"	18"	4"
2'-4" x 6'-8"	28"	18"	5"
2'-6" x 6'-8"	30"	21"	4 1/2"
2'-8" x 6'-8"	32"	23"	4 1/2"
2'-10" x 6'-8"	34"	24"	5"
3'-0" x 6'-8"	36"	24"	6"

PANEL PROFILE : OVOLO STICKING

CREATION DATE: 2/6/2012		3737 Lakeport Blvd. Klamath Falls, OR 97601 Phone: (800) 441-3884 www.jeld-wen.com
REV. DATE:		
TITLE:	MOLDED INTERIOR DOOR	
DESCRIPTION:	SANTA FE SMOOTH 6'-8" 1'-10", 2'-0", 2'-2", 2'-4", 2'-6", 2'-8", 2'-10", 3'-0"	

© 2012 JELD-WEN, inc. ALL RIGHTS RESERVED.
NO DUPLICATION OR DISTRIBUTION PERMITTED.
JELD-WEN, inc. CONFIDENTIAL AND PROPRIETARY.

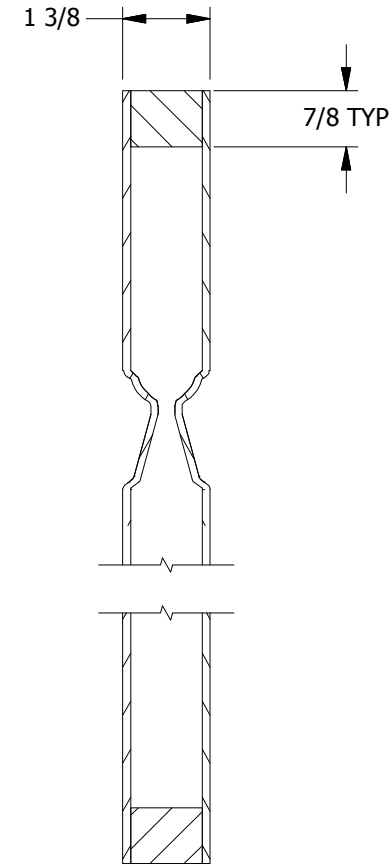
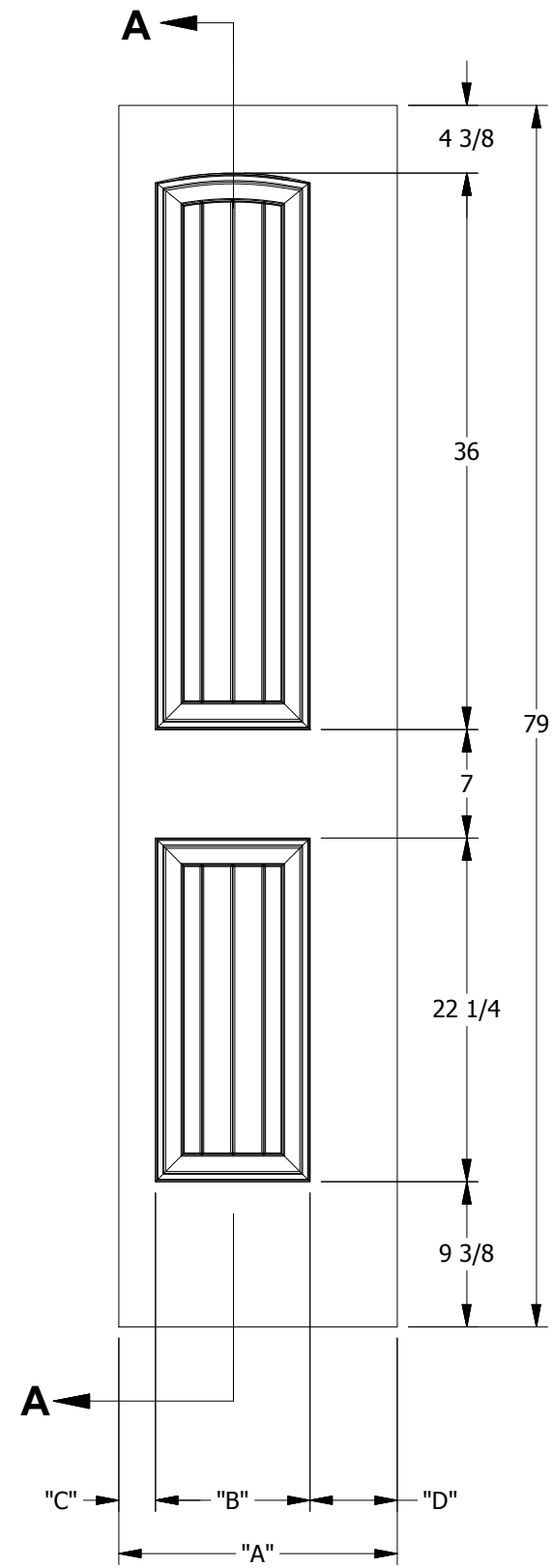

SECTION A-A

DIMENSION TABLE				
DOOR SIZE	"A"	"B"	"C"	"D"
1'-0" x 6'-8"	12"	7"	1 7/8"	3 1/8"
1'-2" x 6'-8"	14"	7"	2 3/8"	4 5/8"
1'-3" x 6'-8"	15"	7"	2 3/8"	5 5/8"
1'-4" x 6'-8"	16"	7"	2 3/8"	6 5/8"
1'-6" x 6'-8"	18"	10"	2 3/8"	5 5/8"

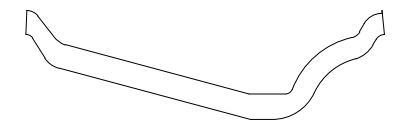

PANEL PROFILE : OVOLO STICKING

CREATION DATE: 2/6/2012		3737 Lakeport Blvd. Klamath Falls, OR 97601 Phone: (800) 441-3884 www.jeld-wen.com
REV. DATE:		
TITLE: MOLDED INTERIOR DOOR		
DESCRIPTION: SANTA FE BI-FOLDSMOOTH 6'-8" 1'-0", 1'-2", 1'-3", 1'-4", 1'-6"		

© 2012 JELD-WEN, inc. ALL RIGHTS RESERVED.
NO DUPLICATION OR DISTRIBUTION PERMITTED.
JELD-WEN, inc. CONFIDENTIAL AND PROPRIETARY.

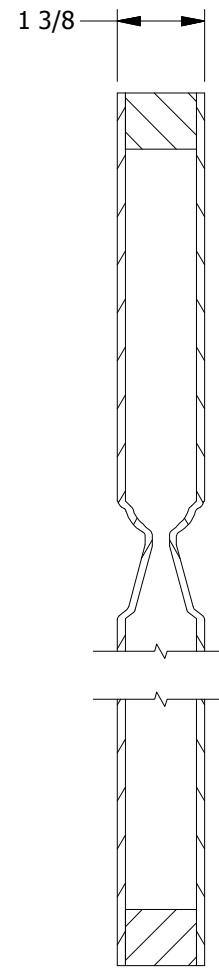
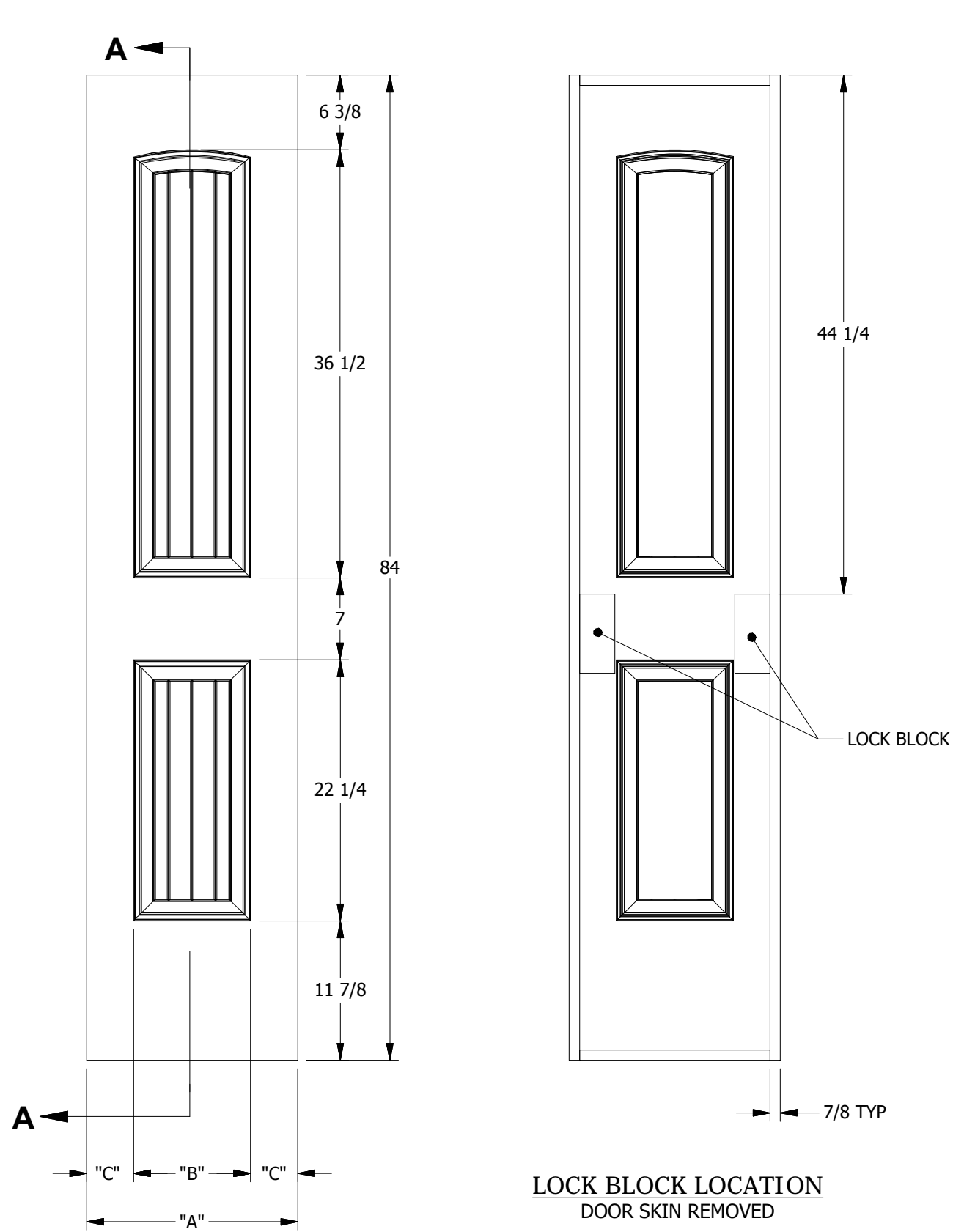

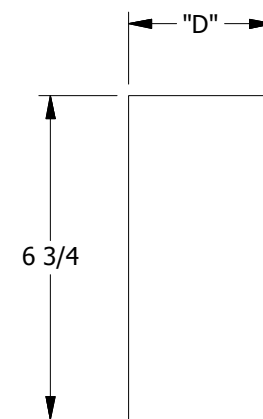

DIMENSION TABLE				
DOOR SIZE	"A"	"B"	"C"	"D"
1'-0" x 7'-0"	12"	7"	2 1/2"	1 5/8"
1'-2" x 7'-0"	14"	7"	3 1/2"	2 5/8"
1'-3" x 7'-0"	15"	7"	4"	3"
1'-4" x 7'-0"	16"	7"	4 1/2"	3"
1'-6" x 7'-0"	18"	10"	4"	3"
1'-8" x 7'-0"	20"	10"	5"	3"

SECTION A-A

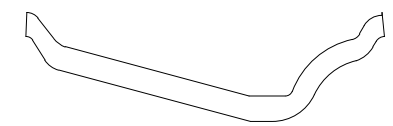

PANEL PROFILE : OVOLO STICKING



CREATION DATE: 2/6/2012		3737 Lakeport Blvd. Klamath Falls, OR 97601 Phone: (800) 441-3884 www.jeld-wen.com
REV. DATE:		
TITLE:	MOLDED INTERIOR DOOR	
DESCRIPTION:	SANTA FE SMOOTH 7'-0" 1'-0", 1'-2", 1'-3", 1'-4", 1'-6", 1'-8"	

© 2012 JELD-WEN, inc. ALL RIGHTS RESERVED.
NO DUPLICATION OR DISTRIBUTION PERMITTED.
JELD-WEN, inc. CONFIDENTIAL AND PROPRIETARY.

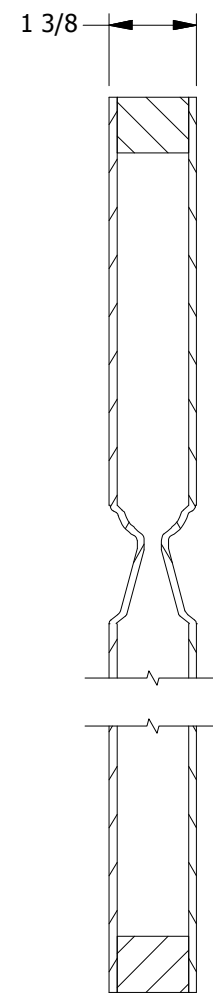
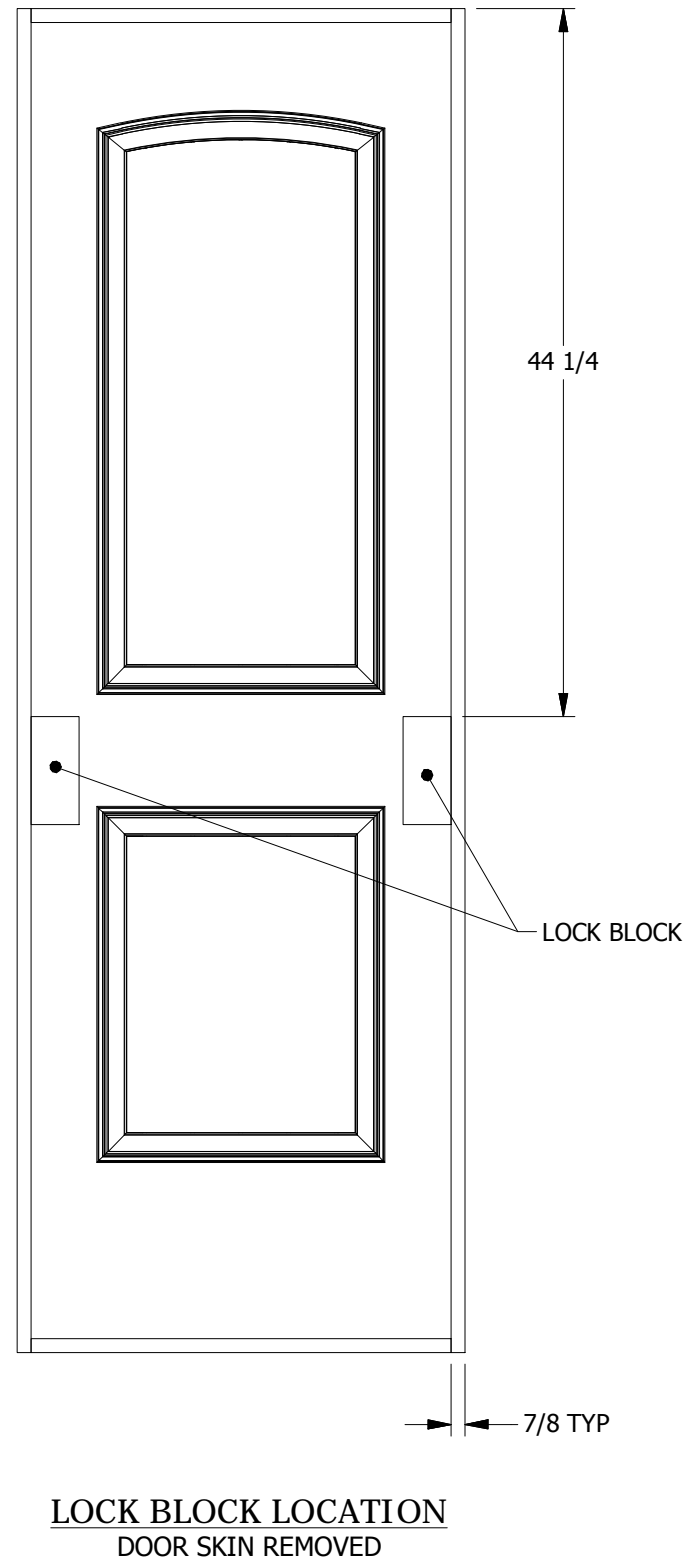
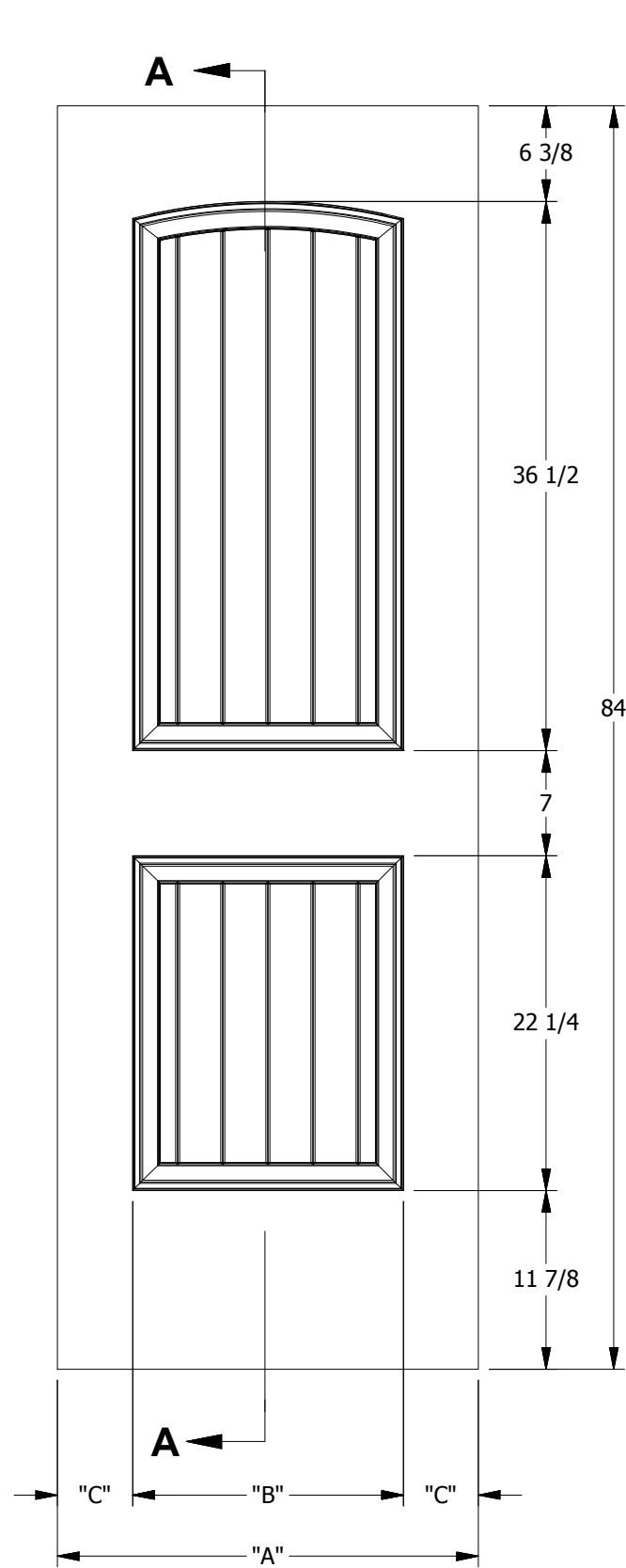

DIMENSION TABLE			
DOOR SIZE	"A"	"B"	"C"
1'-10" x 7'-0"	22"	14"	4"
2'-0" x 7'-0"	24"	14"	5"
2'-2" x 7'-0"	26"	18"	4"
2'-4" x 7'-0"	28"	18"	5"
2'-6" x 7'-0"	30"	21"	4 1/2"
2'-8" x 7'-0"	32"	23"	4 1/2"
2'-10" x 7'-0"	34"	24"	5"
3'-0" x 7'-0"	36"	24"	6"

SECTION A-A

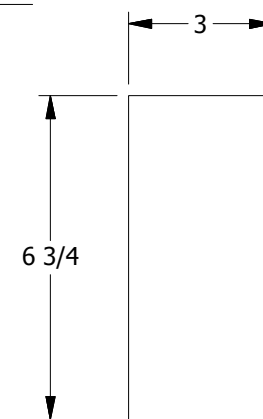

PANEL PROFILE : OVOLO STICKING

CREATION DATE: 2/6/2012		3737 Lakeport Blvd. Klamath Falls, OR 97601 Phone: (800) 441-3884 www.jeld-wen.com
REV. DATE:		
TITLE: MOLDED INTERIOR DOOR		
DESCRIPTION: SANTA FE SMOOTH 7'-0" 1'-10", 2'-0", 2'-2", 2'-4", 2'-6", 2'-8", 2'-10", 3'-0"		

© 2012 JELD-WEN, inc. ALL RIGHTS RESERVED.
 NO DUPLICATION OR DISTRIBUTION PERMITTED.
 JELD-WEN, inc. CONFIDENTIAL AND PROPRIETARY.

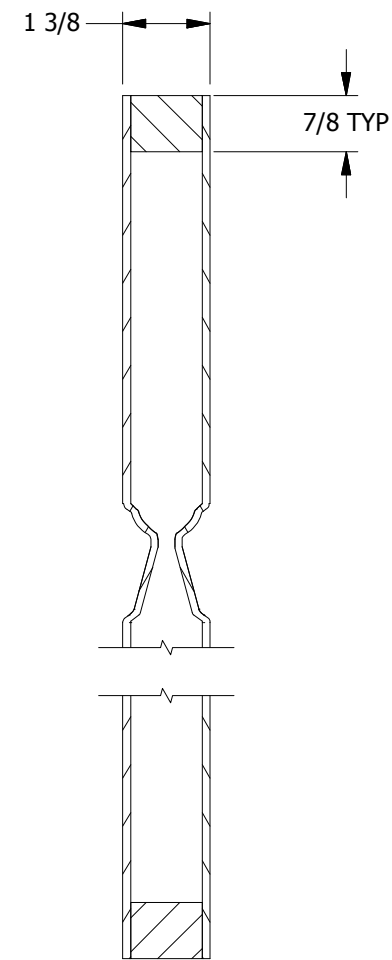
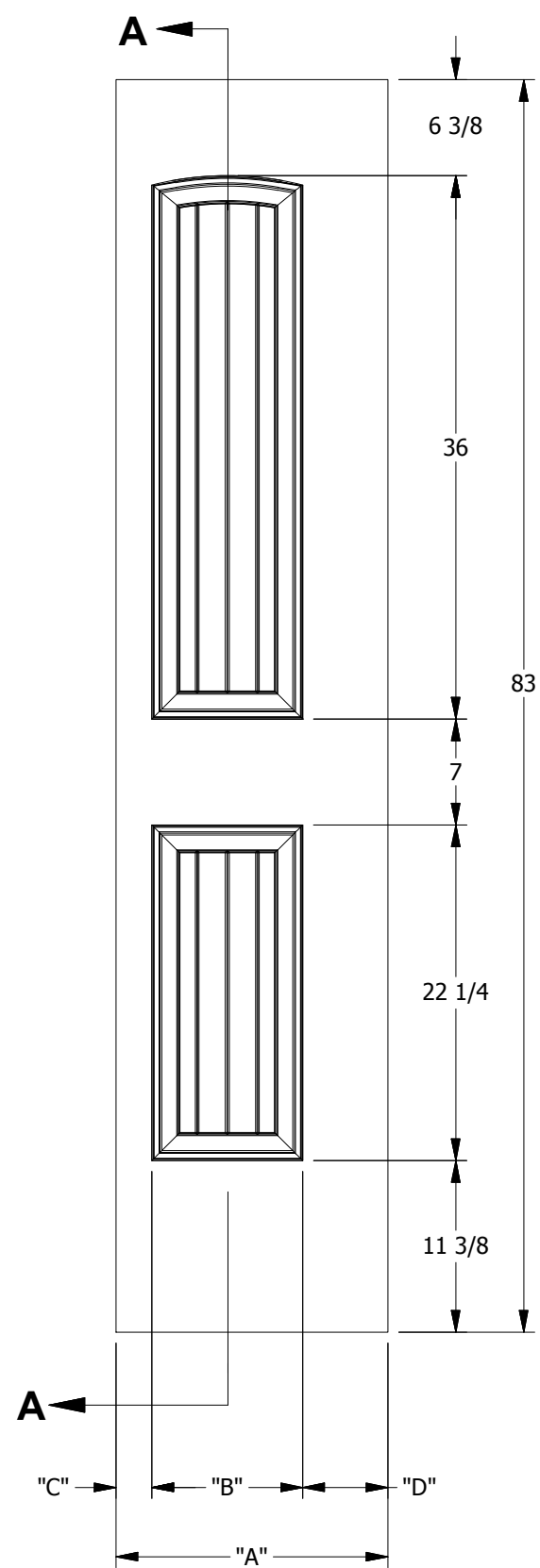

SECTION A-A

DIMENSION TABLE				
DOOR SIZE	"A"	"B"	"C"	"D"
1'-0" x 7'-0"	12"	7"	1 7/8"	3 1/8"
1'-2" x 7'-0"	14"	7"	2 3/8"	4 5/8"
1'-3" x 7'-0"	15"	7"	2 3/8"	5 5/8"
1'-4" x 7'-0"	16"	7"	2 3/8"	6 5/8"
1'-6" x 7'-0"	18"	10"	2 3/8"	5 5/8"

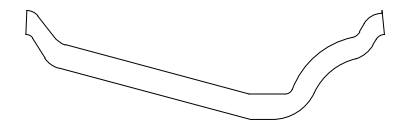

PANEL PROFILE : OVOLO STICKING

CREATION DATE: 2/6/2012		3737 Lakeport Blvd. Klamath Falls, OR 97601 Phone: (800) 441-3884 www.jeld-wen.com
REV. DATE:		
TITLE: MOLDED INTERIOR DOOR		
DESCRIPTION: SANTA FE BI-FOLD SMOOTH 7'-0" 1'-0", 1'-2", 1'-3", 1'-4", 1'-6"		

© 2012 JELD-WEN, inc. ALL RIGHTS RESERVED.
NO DUPLICATION OR DISTRIBUTION PERMITTED.
JELD-WEN, inc. CONFIDENTIAL AND PROPRIETARY.

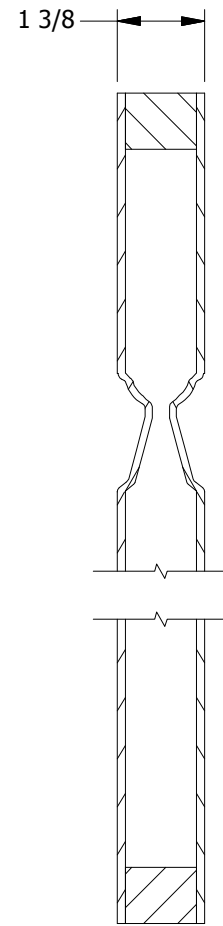
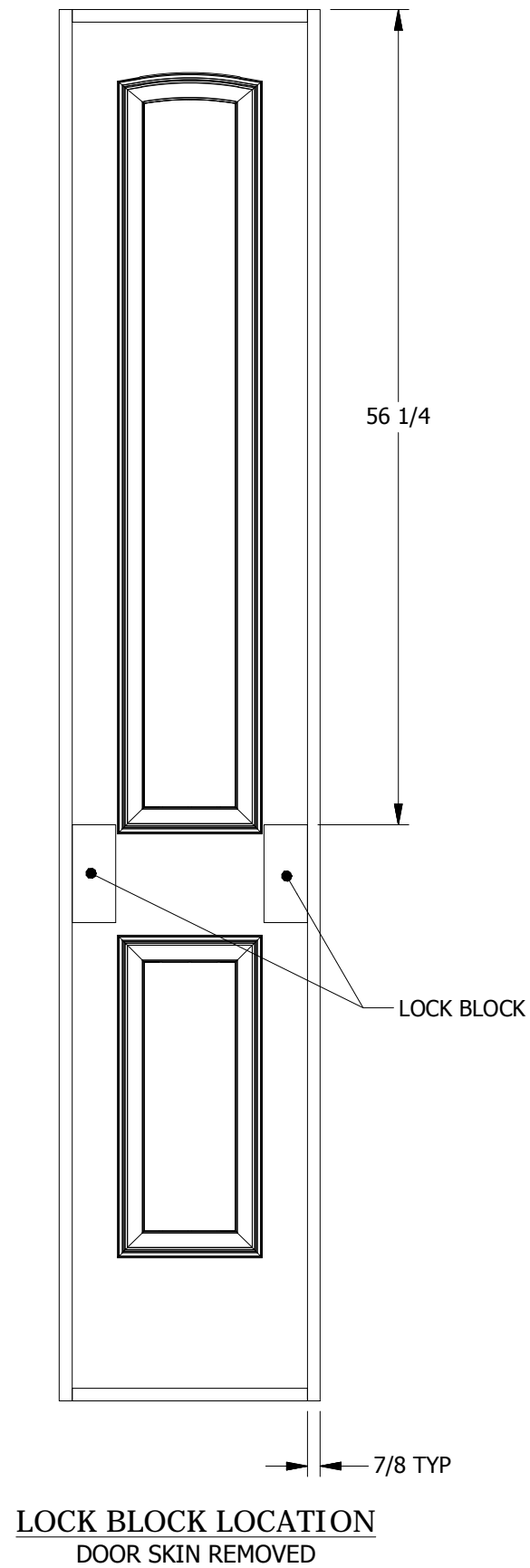
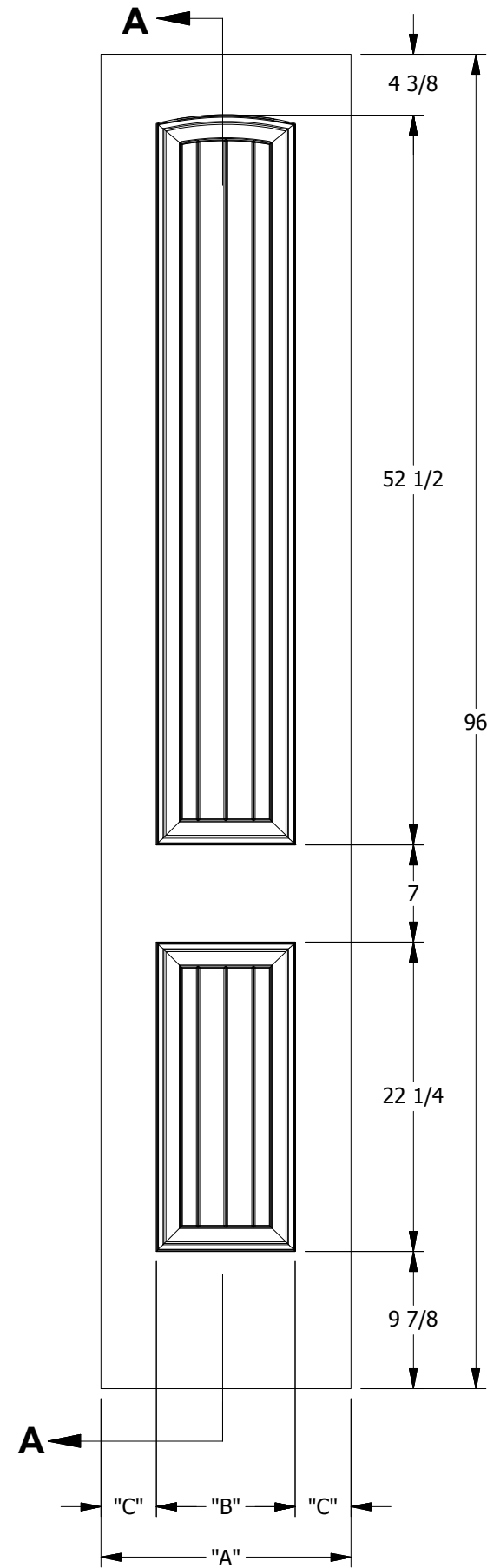

DIMENSION TABLE				
DOOR SIZE	"A"	"B"	"C"	"D"
1'-0" x 8'-0"	12"	7"	2 1/2"	1 5/8"
1'-2" x 8'-0"	14"	7"	3 1/2"	2 5/8"
1'-3" x 8'-0"	15"	7"	4"	3"
1'-4" x 8'-0"	16"	7"	4 1/2"	3"
1'-6" x 8'-0"	18"	10"	4"	3"
1'-8" x 8'-0"	20"	10"	5"	3"

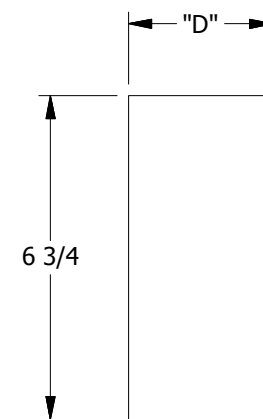

PANEL PROFILE : OVOLO STICKING

CREATION DATE: 2/6/2012		3737 Lakeport Blvd. Klamath Falls, OR 97601 Phone: (800) 441-3884 www.jeld-wen.com
REV. DATE:		
TITLE: MOLDED INTERIOR DOOR		
DESCRIPTION: SANTA FE SMOOTH 8'-0" 1'-0", 1'-2", 1'-3", 1'-4", 1'-6", 1'-8"		

© 2012 JELD-WEN, inc. ALL RIGHTS RESERVED.
NO DUPLICATION OR DISTRIBUTION PERMITTED.
JELD-WEN, inc. CONFIDENTIAL AND PROPRIETARY.

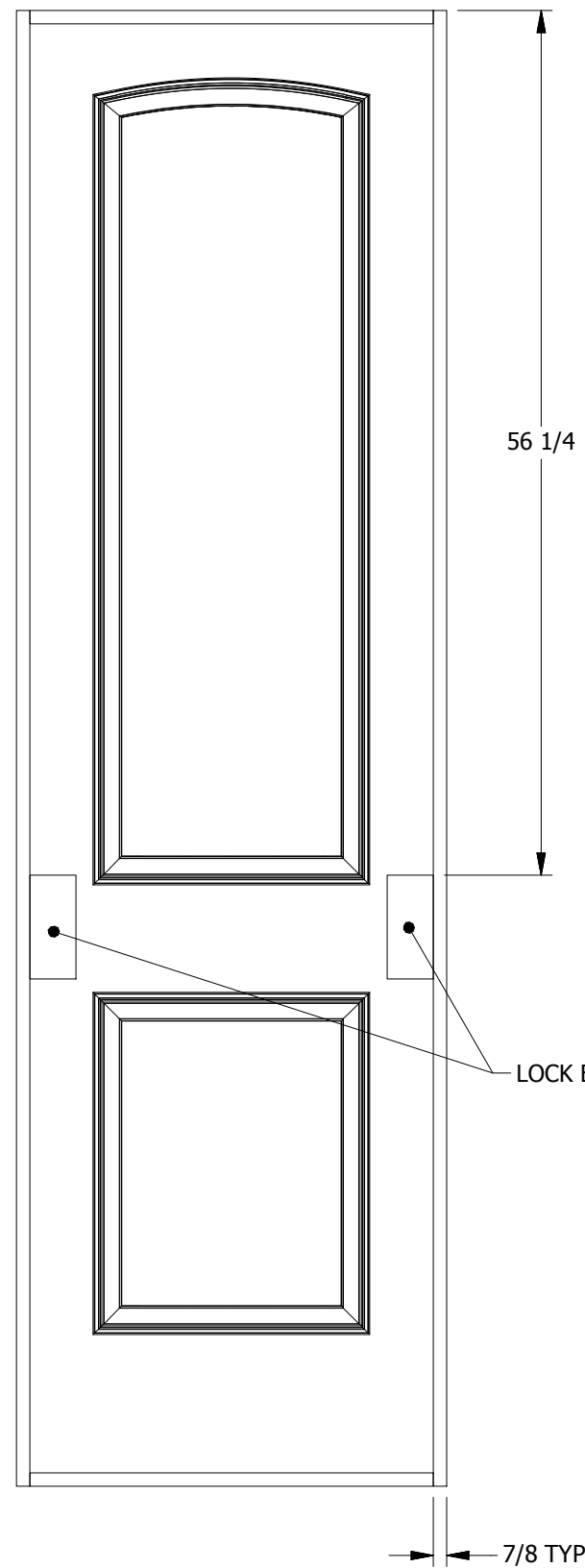
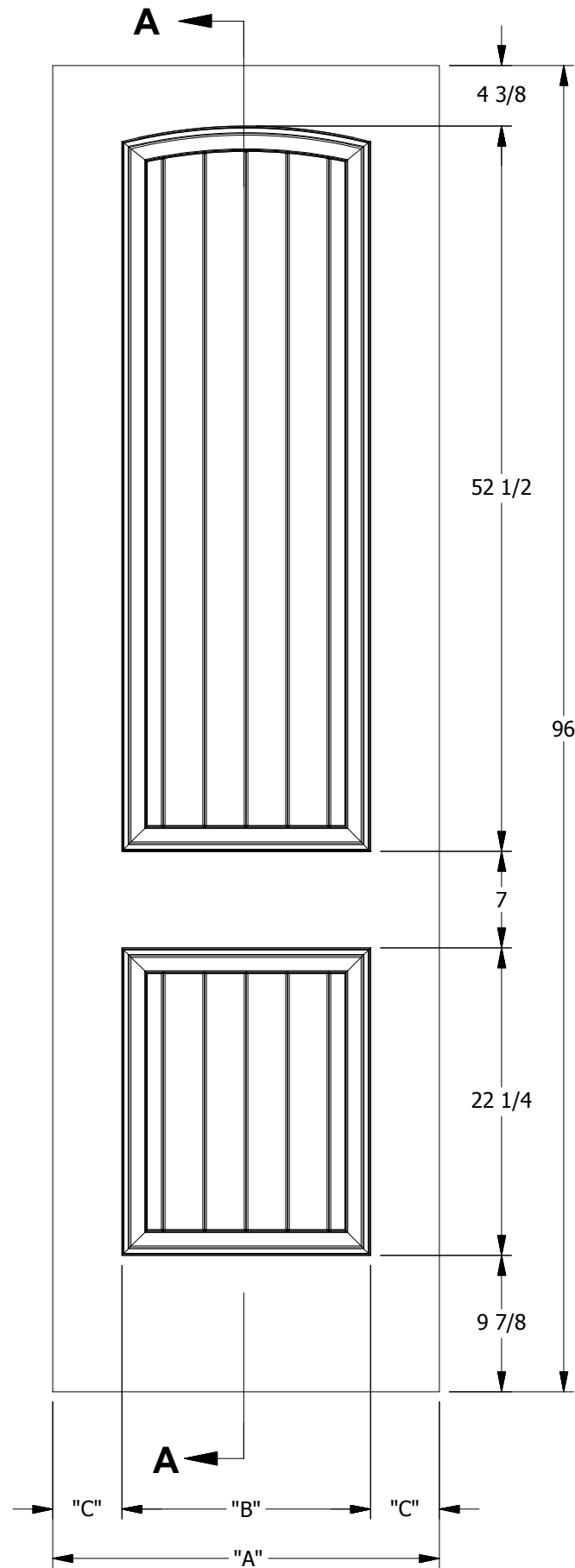

LOCK BLOCK LOCATION
DOOR SKIN REMOVED

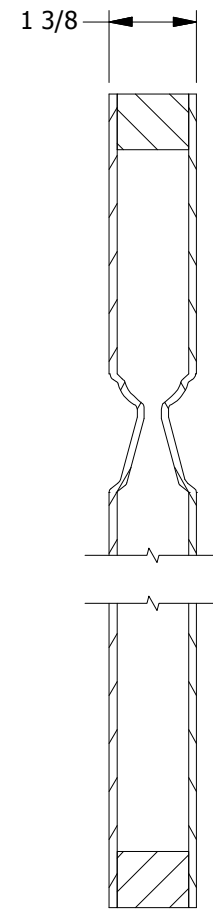

SECTION A-A

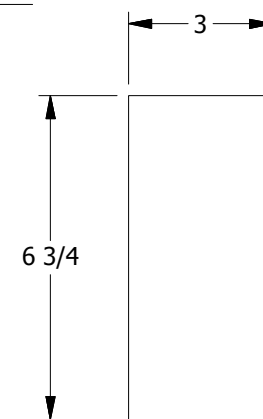

LOCK BLOCK
DETAIL

DIMENSION TABLE			
DOOR SIZE	"A"	"B"	"C"
1'-10" x 8'-0"	22"	14"	4"
2'-0" x 8'-0"	24"	14"	5"
2'-2" x 8'-0"	26"	18"	4"
2'-4" x 8'-0"	28"	18"	5"
2'-6" x 8'-0"	30"	21"	4 1/2"
2'-8" x 8'-0"	32"	23"	4 1/2"
2'-10" x 8'-0"	34"	24"	5"
3'-0" x 8'-0"	36"	24"	6"

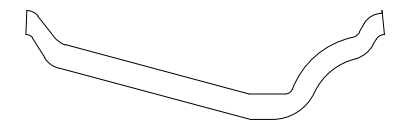

PANEL PROFILE : OVOLO STICKING

CREATION DATE: 2/6/2012		3737 Lakeport Blvd. Klamath Falls, OR 97601 Phone: (800) 441-3884 www.jeld-wen.com
REV. DATE:		
TITLE: MOLDED INTERIOR DOOR		
DESCRIPTION: SANTA FE SMOOTH 8'-0" 1'-10", 2'-0", 2'-2", 2'-4", 2'-6", 2'-8", 2'-10", 3'-0"		

© 2012 JELD-WEN, inc. ALL RIGHTS RESERVED.
NO DUPLICATION OR DISTRIBUTION PERMITTED.
JELD-WEN, inc. CONFIDENTIAL AND PROPRIETARY.

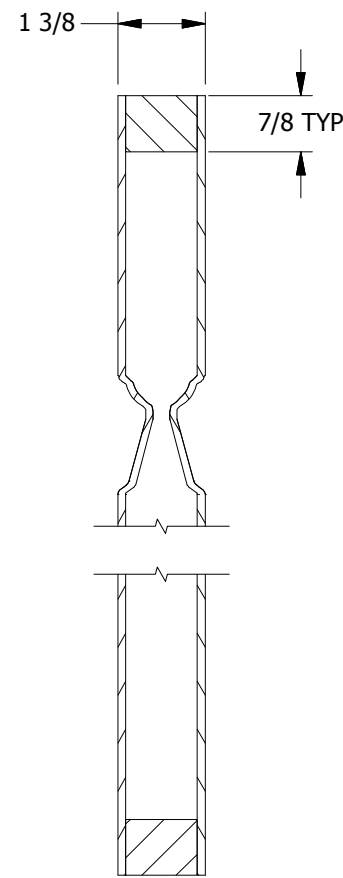
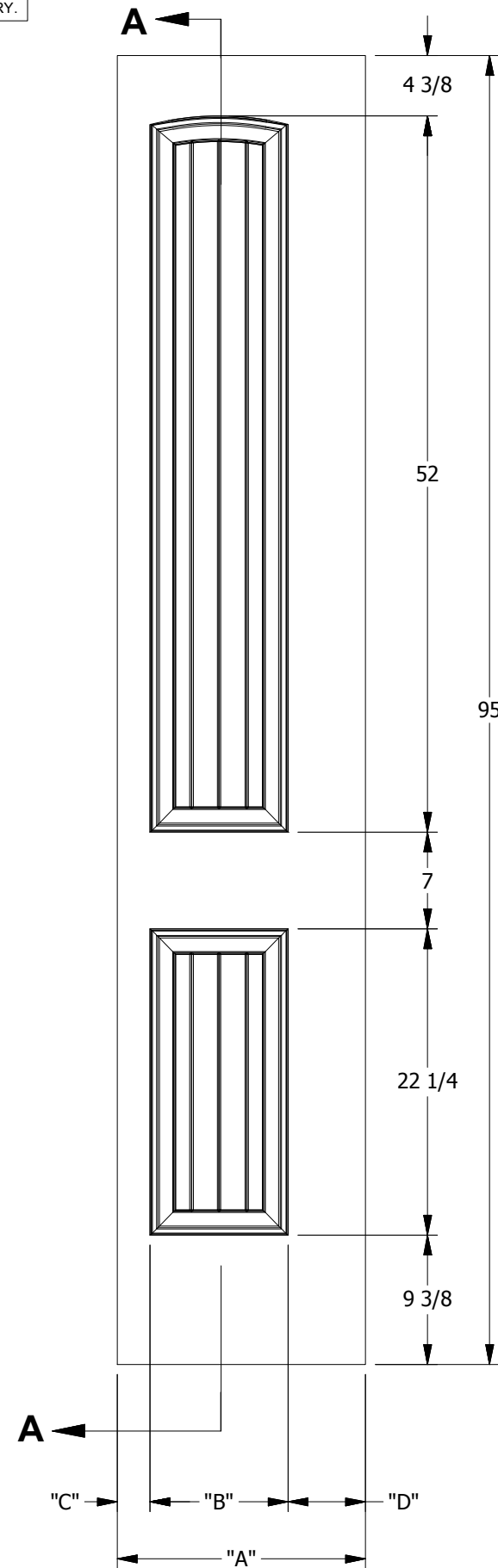

SECTION A-A

DIMENSION TABLE				
DOOR SIZE	"A"	"B"	"C"	"D"
1'-0" x 8'-0"	12"	7"	1 7/8"	3 1/8"
1'-2" x 8'-0"	14"	7"	2 3/8"	4 5/8"
1'-3" x 8'-0"	15"	7"	2 3/8"	5 5/8"
1'-4" x 8'-0"	16"	7"	2 3/8"	6 5/8"
1'-6" x 8'-0"	18"	10"	2 3/8"	5 5/8"

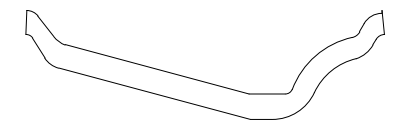

PANEL PROFILE : OVOLO STICKING

CREATION DATE: 2/6/2012		3737 Lakeport Blvd. Klamath Falls, OR 97601 Phone: (800) 441-3884 www.jeld-wen.com
REV. DATE:		
TITLE: MOLDED INTERIOR DOOR		
DESCRIPTION: SANTA FE BI-FOLD SMOOTH 8'-0" 1'-0", 1'-2", 1'-3", 1'-4", 1'-6"		