TABLE OF CONTENTS

| | |
|--|-------|
| Specifications | 21-2 |
| Quick Spec Guide | 21-4 |
| Elevations/Sizes: 1/8" Scale | 21-6 |
| Swinging Door Units | 21-8 |
| French Units | 21-11 |
| Single Door with Single Sidelite | 21-13 |
| Single Door with Two Sidelites | 21-14 |
| French Door with Two Sidelites | 21-15 |
| Transom Units | 21-19 |
| Sector Top Doors | 21-24 |
| French Sector Top Doors | 21-26 |
| French Sector Top Doors with Two Sidelites | 21-28 |
| Sector Top Transom Units | 21-32 |
| Glazing Options | 21-33 |
| Trim Options | 21-36 |
| Rail, Panel & Sill Options | 21-37 |
| Mullion Details | 21-41 |
| Grille & SDL Patterns | 21-42 |
| Unit Sizing, Rough Openings & Masonry Openings | 21-43 |
| Section Details: 3" Scale | 21-44 |

PRODUCT SPECIFICATIONS**EXTERIOR FINISH**

Exterior aluminum surfaces are finished with a fluoropolymer (70% Kynar 500®) multi-coat finish system to meet the performance standards required by AAMA specification #2605. 41 standard colors include Brilliant White, Chestnut Bronze, Desert Sand, French Vanilla, Hartford Green, Mesa Red, Black Licorice, Heirloom White, Hunter Green, Redwood, Sage Brown, Smoke and more. Custom Color Matching available. Three Copper finishes are available on door panels.

AURALAST® WOOD

AuraLast® wood is fundamentally different from wood treated in traditional millwork preservation processes in that it uses a proprietary vacuum/pressure process to provide protection throughout the wood parts used to make windows and doors. AuraLast® wood is distinguished from wood using traditional preservation methods by its unique ability to achieve greater penetration of the active ingredients into the wood parts, with a minimum treatment penetration of 92%.

INTERIOR FINISH

Interior surfaces are unfinished clear pine ready for on-site finishing. Optional prefinished pine interiors include four acrylic colors (Moderate White, Extra White, Natural Choice, Pure White), five stains (Wheat, Cherry, Fruitwood, Cordovan, Cider) and a clear lacquer topcoat. Primed interior is also available. Optional interior wood species include vertical grain Douglas Fir, Mahogany and Knotty Alder.

FRAME

Frame is assembled from select kiln-dried pine AuraLast® wood on all exterior parts. Exterior surface is covered with .050 gauge extruded aluminum cladding. Standard jamb width is 4-9/16". Radius frames are produced in only three different radii: 90-9/32", 37-19/16", and 31-19/32".

PANELS

1-23/32" thick select kiln-dried pine AuraLast® wood. Exterior surface is covered with .024 gauge roll formed aluminum cladding. The top and bottom rails are formed from solid Western Pine veneers laminated to a kiln dried edge-and-end-glued core, while the stiles have the same veneer laminated to a Timberstrand core. The standard layout is 4-5/8" top rail and stiles and a 6-5/8" bottom rail. Other door rail options include wide bottom rail, lock rail and raised panels.

GLAZING

Insulating glass is constructed from two panes of tempered glass, utilizing a continuous roll formed stainless steel spacer with dual seal sealant. A computer-controlled application of clear silicone is used to bed the exterior of the insulating glass into the panel. An acrylic sealant is used to bed the interior. All insulating glass units comply with the performance requirements of IGCC in accordance with either ASTM E774 or E2190.

GLAZING OPTIONS - TEMPERED

Tempered insulating glass available in Low-E with Argon, Low-E, Low-E 366, Clear, Neat Glass, Seedy Reamy, tinted, reflective, or obscure, or other specialty glass as specified. Preserve® film is a 0.003" thick polyethylene film with a low tack acrylic adhesive applied to the glass for protection during shipping and installation. Installations at 4,000 foot elevations and higher require a capillary tube to equalize environmental stress (otherwise known as High Altitude glazing). High altitude glazing does not allow the use of Argon as listed under glazing options.

WEATHER-STRIPPING

Engineered system with dual foam filled bulb seal compressed between the exterior of the panel and the frame in a continuous plane on all four sides.

SILL

The sill is a dark bronze anodized aluminum with interior trim and an adjustable composite threshold in combination with a vinyl fin-and-bulb bottom door sweep. An optional handicapped sill with a maximum height of 1/2" is available to meet the standards set forth by the ADA for handicapped access.

HARDWARE

The door panels are mounted into the frame utilizing 4" x 4" heavy gauge solid brass hinges with stainless steel pins. Three hinges are used on 6-8 and 7-0 heights, and four hinges on all larger heights. Optional adjustable hinges are also available providing both vertical and horizontal adjustment. The standard finish for all hinges is Polished Brass, with optional finishes available in Antique Brass, Polished Chrome, Brushed Chrome, Oil-Rubbed Bronze, White Powder Coat, Black Powder Coat, and Satin Nickel. The standard locking system is a single point mortise with lever handle, and thumb turn dead bolt, shipped separately for field installation. Matching dummy handle sets are included for French Door applications. Optional multipoint lock systems are factory installed securing the active panel at three points. The system is manually activated from the handle.

INSECT SCREENS

Optional exterior sliding screen is assembled with 18 x 16 fiberglass mesh screen cloth set in an extruded aluminum frame supplied with all necessary hardware. Standard colors are Brilliant White, Chestnut Bronze, Desert Sand, French Vanilla, Hartford Green, Mesa Red, Black Licorice, Heirloom White, Hunter Green, Redwood, Sage Brown, and Smoke. Screens not available for Single Swing, French or Radius doors. Insect screens are intended to allow air and light in and to keep insects out. They are not intended to keep anyone or anything from falling through an open window. For safety screens or other security devices contact your local building supply retailer.

GRILLES

SDL (Simulated Divided Lites) - extruded aluminum muntins permanently applied to the exterior of the insulating glass unit (not available on textured glass) in 5/8", 7/8", 1-1/8", or 1-3/8" widths. Profiles are bead stop in all widths, and a putty profile in 5/8", 7/8", and 1-1/8" widths only. SDL is standard with a light bronze internal shadow bar to give a true divided lite appearance. As an option, SDL may be ordered with a silver shadow bar. Clear wood interior muntin bars match the exterior muntin width and are permanently bonded to the interior of the glass. Also available is a 2-5/16" SDL bar, which simulates a double-hung checkrail.

Full-Surround Removable Wood Grilles - Rectangular, unfinished interior clear pine wood grilles in 7/8", 1-1/8", and 1-3/8" are available in patterns selected by the owner.

GBG (Grilles between the Glass) - 5/8" flat, 23/32" contour, or 1" contour grilles mounted between the glass panes suspended within the air cavity.

Continued on next page

PRODUCT SPECIFICATIONS

EXTERIOR TRIM

Nail flange and drip cap standard with optional extruded aluminum brickmould, 3-1/2" flat, 3-1/2" Adams and Heritage trims. Optional mull covers to accommodate 1" (spread only), 2", 3-1/2" and 6" spread and stud pocket mull.

EXTENSION JAMBS

Extension jambs are available for wall depths up to 6-11/16".

INSTALLATION

Installation per JELD-WEN Installation Method for Metal Clad Patio Doors. See www.jeld-wen.com/resources for instructions.

PERFORMANCE

NFRC Certified - (rated and labeled in accordance with NFRC 100 and 200 procedures)

ANSI/AAMA/NWWDA/101/I.S.2-97
AMMA/WDMA/CSA 101/I.S.2/A440-05
WDMA Hallmark Certified

See www.jeld-wen.com for architectural and performance information.

QUICK SPEC GUIDE

| SPECIFICATION | STANDARD FEATURES | OPTIONAL FEATURES <i>Some options may require additional lead times. Consult your JELD-WEN Sales Representative.</i> | |
|-------------------------------|--|---|---|
| EXTERIOR FINISH | <ul style="list-style-type: none"> • Brilliant White • Chestnut Bronze • Desert Sand • French Vanilla • Mesa Red • Hartford Green • Black Licorice • Heirloom White • Hunter Green • Redwood • Sage Brown • Smoke • Artic Silver • Dark Chocolate • Black Emerald • Bone White • Bronze • Buckskin • Cambridge White • Capri Blue • Cascade • Champagne • Clover Mist • Dark Buckskin • Dark Ivy • Deep Summer • Garnet • Haverstraw • Hudson Blue • Ivory • Ivy • Liberty Blue • Mocha Cream • Mosaic Green • Pueblo Tan • Rosewood • Scarlet Haze • Sea Foam • Teal • Wedgewood • White | <ul style="list-style-type: none"> • Custom Color Matching | <p>Panel Only:</p> <ul style="list-style-type: none"> • Bright Copper • Speckled Patina Copper • Hand Rubbed Patina Copper |
| EXTERIOR TRIM | <ul style="list-style-type: none"> • Drip Cap & Integral Nailing Fin | <ul style="list-style-type: none"> • Extruded Aluminum Brickmould • Adams Casing | <ul style="list-style-type: none"> • 3-1/2" Flat Casing • Heritage Casing • Folding Nailing Fin |
| INTERIOR WOOD | <ul style="list-style-type: none"> • Western Pine | <ul style="list-style-type: none"> • Knotty Alder • Vertical Grain Douglas Fir • Mahogany | |
| INTERIOR FINISH | <ul style="list-style-type: none"> • Natural | <ul style="list-style-type: none"> • Priming Available <p>Pre-finished Interior Options are:</p> <ul style="list-style-type: none"> • Paint - Pure White, Extra White, Natural Choice, Moderate White • Stain - Wheat, Fruitwood, Cherry, Cordovan, Cider • Clear Lacquer | |
| SIZE | <ul style="list-style-type: none"> • Width: 2-0, 2-6, 2-8, 3-0, 3-6, 4-0, 5-0, 5-4, 6-0, 7-6, 8-0, 9-0, 10-0, 12-0 • Height: 6-8, 7-0, 8-0, 9-0 | <ul style="list-style-type: none"> • Any Panel Width: 2-0 to 3-6 (Certain restrictions apply) • Any Panel Height: 4-0 to 10-0 (Certain restrictions apply) | |
| GLAZING (ALL TEMPERED) | <ul style="list-style-type: none"> • Low-E Tempered Insulating Glass (with Argon) • Low-E 366 • Preserve® Protective Film | <ul style="list-style-type: none"> • Clear • Obscure • Reflective • Tints: Bronze, Gray, Green • Glue Chip • Safety Laminate in Clear, Bronze or Gray | <ul style="list-style-type: none"> • Neat Glass • Seedy Reamy • Rain • Narrow Reed • Sandblasted • Tempered • Impact Resistant |
| | | <ul style="list-style-type: none"> • High Altitude (Breather Tube, no Argon) | |

Continued on next page

QUICK SPEC GUIDE

| SPECIFICATION | STANDARD FEATURES | OPTIONAL FEATURES <i>Some options may require additional lead times. Consult your JELD-WEN Sales Representative.</i> |
|---------------------------|---|--|
| GRILLES | | SDL Bead Profile: <ul style="list-style-type: none"> • 5/8", 7/8", 1-1/8", 1-3/8", 2-5/16" with Light Bronze Shadow Bar • 5/8", 7/8", 1-1/8", 1-3/8", 2-5/16" with Silver Shadow Bar SDL Putty Profile: <ul style="list-style-type: none"> • 5/8", 7/8" and 1-1/8" with Light Bronze Shadow Bar • 5/8", 7/8" and 1-1/8" with Silver Shadow Bar • 1" Copper SDL GBG (Grilles between the Glass): <ul style="list-style-type: none"> • 5/8" Flat, 23/32" Contour, 1" Contour Full-Surround: <ul style="list-style-type: none"> • 7/8", 1-1/8", 1-3/8" |
| HARDWARE | <ul style="list-style-type: none"> • 4 x 4 Heavy Gauge Hinges • Single Point Mortise Lock with Lever Handle | <ul style="list-style-type: none"> • Adjustable Hinges • Multipoint Manually Activated Lock |
| HARDWARE COLOR | <ul style="list-style-type: none"> • Polished Brass | <ul style="list-style-type: none"> • Antique Brass • Polished Chrome • Brushed Chrome • Oil-Rubbed Bronze • White Powder Coat • Black Powder Coat |
| JAMB | <ul style="list-style-type: none"> • Applied, 5/4 • 4-9/16" | <ul style="list-style-type: none"> • 4-11/16"* , 6-9/16" and 6-11/16"* <p><i>*Only available with Folding Nailing Flange option</i></p> |
| INSECT SCREENS | | <ul style="list-style-type: none"> • Fiberglass |
| SCREEN FRAME COLOR | <ul style="list-style-type: none"> • Brilliant White • Chestnut Bronze • Desert Sand • French Vanilla • Mesa Red • Hartford Green • Black Licorice • Heirloom White • Hunter Green • Redwood • Sage Brown • Smoke | <ul style="list-style-type: none"> • Black Emerald • Bone White • Bronze • Buckskin • Cambridge White • Capri Blue • Cascade • Champagne • Clover Mist • Dark Buckskin • Dark Ivy • Deep Summer • Garnet • Haverstraw • Hudson Blue • Ivory • Ivy • Liberty Blue • Mocha Cream • Mosaic Green • Pueblo Tan • Rosewood • Scarlet Haze • Sea Foam • Teal • Wedgewood • White • Clear Satin Anodized • Custom Color Matching |

GENERAL INFORMATION

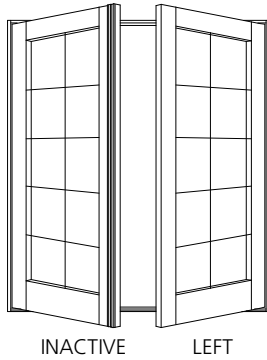

DIMENSIONAL DOORS

Clad in-swing patio doors may be specified as "dimensional" by adjusting the desired rough opening width or height in 1/4" increments from standard.

Clad in-swing patio doors are available in single, twin, triple, and quad panel doors. Transoms are available to match the variety of door sizes. The standard size range includes sizes specifically designed for replacement of older patio door models in existing structures, as well as a full range of "true size" products for architectural consistency.

OPERATION

Clad in-swing patio doors are available in a full range of operating styles. Single panel doors may be specified as stationary (non-venting) or can operate left or right. Center swing two- or three-panel doors are available with left or right operation. French doors feature two operating panels (one active, which opens first; and one inactive, which closes first), and are available in two-panel and four-panel styles. Configuration and handing is based on viewing the door from the interior.

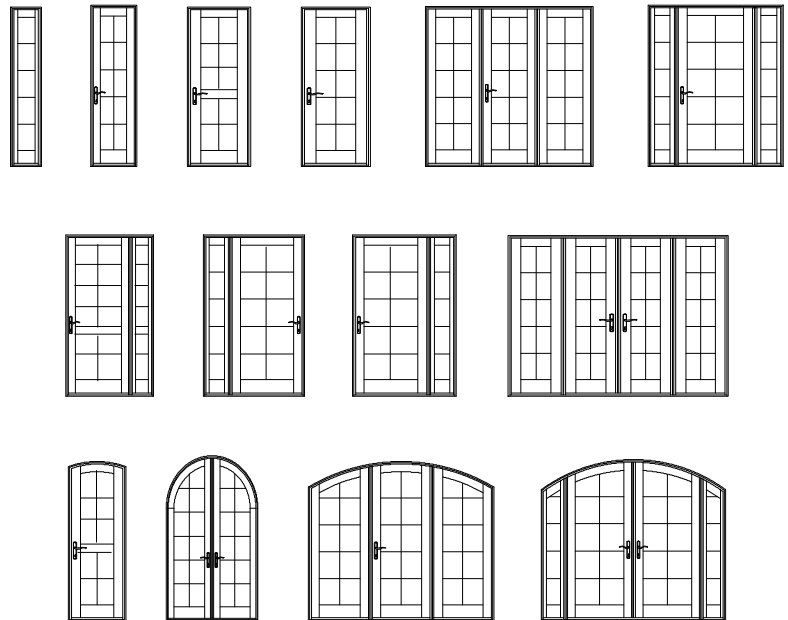

MULTIPLE ASSEMBLIES

Clad in-swing patio doors are available in a wide variety of multiple panel configurations from the factory, all of which are assembled with continuous sills. Clad in-swing patio doors may be mullered below or beside other wood door and wood window products. Factory assembled mulls are limited in height (100"), width (150"), and a total area (75 square feet).



ELEVATION NOTES

ELEVATION DRAWINGS UTILIZE A LIMITED NUMBER OF PROJECTED LINES TO PRODUCE A RUDIMENTARY DRAWING INTENDED TO BE USED IN A SMALL GRAPHICAL SCALE. ELEVATIONS ARE VIEWED PERPENDICULAR FROM THE EXTERIOR OF THE STRUCTURE. IF MORE DIMENSIONS ARE NEEDED, USE THE SECTION DRAWINGS FOR MORE COMPLETE DEPICTIONS.

| | | |
|------------------------|--------------------|--|
| M.O. Brickmould | 40 11/16" [1033] | |
| M.O. Adams/Flat Casing | 43 3/4" [1111] | |
| Rough Opening | 38 3/16" [970] | |
| Frame Size | 37 7/16" [951] | |
| Daylight Opening | 26 5/8" [676] | |

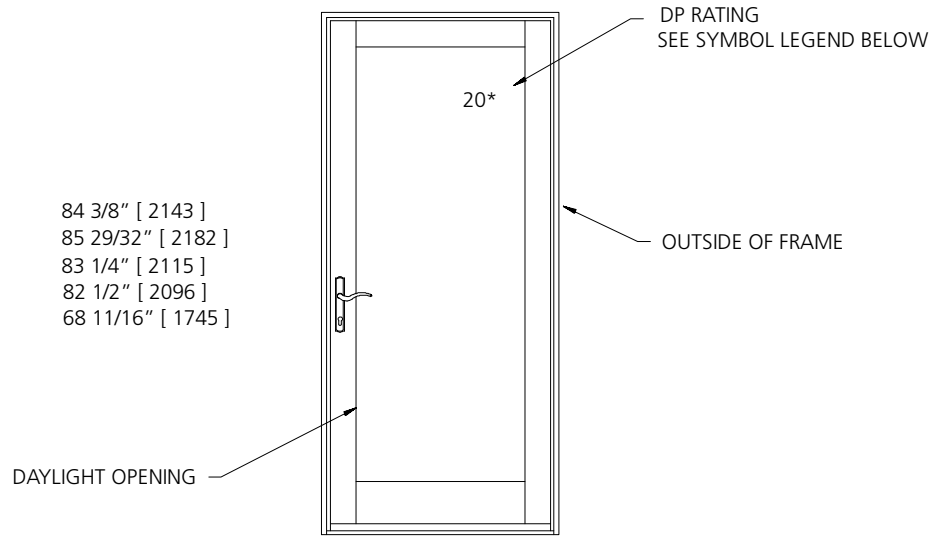

- 84 3/8" [2143]
- 85 29/32" [2182]
- 83 1/4" [2115]
- 82 1/2" [2096]
- 68 11/16" [1745]

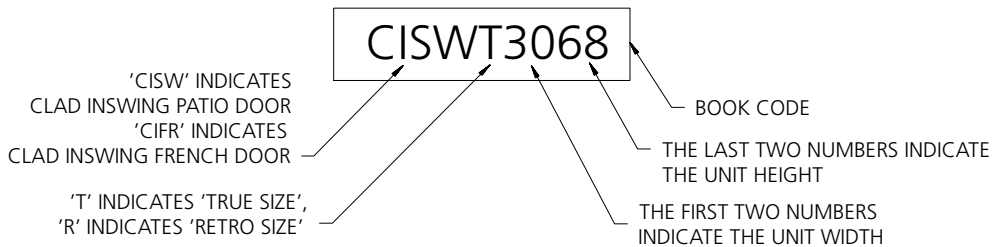

GENERAL SWINGING DOOR NOTES

1. CLAD IN-SWING PATIO DOOR (CISW / CIFR) UNITS ARE AVAILABLE AS OPERATING OR STATIONARY UNITS.
2. UNIT ELEVATIONS ARE SHOWN WITHOUT EXTERIOR TRIM. UNIT SIZES & MASONRY OPENING DIMENSIONS WILL CHANGE WITH THE ADDITION OF EXTERIOR TRIM. SEE THE 'UNIT SIZING, ROUGH OPENINGS & MASONRY OPENINGS' PAGE FOR EXTERIOR TRIM EFFECTS.
3. OPERATING UNITS ARE AVAILABLE AS LEFT OR RIGHT HAND OPERATION.
4. HANDICAP SILL, 10 1/4" BOTTOM RAILS, INTERMEDIATE LOCK RAILS AND RAISED PANELS ARE AVAILABLE FOR ALL UNITS.

ELEVATION SYMBOL LEGEND:

- ###** NUMBER INDICATES DESIGN PRESSURE (DP) RATING WITH STANDARD GLAZING. OPERATING UNITS UTILIZE MULTI-POINT LOCKING HARDWARE FOR DP RATINGS.
- S** PANEL IS AVAILABLE AS STATIONARY ONLY.

1-PANEL UNITS

M.O. BRICKMOULD
M.O. ADAMS/FLAT CASING
ROUGH OPENING
FRAME SIZE
DAYLIGHT OPENING

26 11/16" [678]
 29 3/4" [756]
 24 3/16" [614]
 23 7/16" [595]
 12 5/8" [321]

32 11/16" [830]
 35 3/4" [908]
 30 3/16" [767]
 29 7/16" [748]
 18 5/8" [473]

34 11/16" [881]
 37 3/4" [959]
 32 3/16" [818]
 31 7/16" [799]
 20 5/8" [524]

38 11/16" [983]
 41 3/4" [1060]
 36 3/16" [919]
 35 7/16" [900]
 24 5/8" [625]

81 3/8" [2067]
 82 7/8" [2105]
 80 1/4" [2038]
 79 1/2" [2019]
 65 11/16" [1668]



CISWR2068

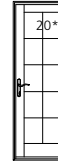

CISWR2668

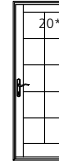

CISWR2868



CISWR3068

97 3/8" [2473]
 98 7/8" [2511]
 96 1/4" [2445]
 95 1/2" [2426]
 81 11/16" [2075]

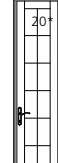

CISWR2080

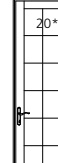

CISWR2680

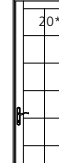

CISWR2880

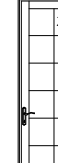

CISWR3080

109 3/8" [2778]
 110 7/8" [2816]
 108 1/4" [2750]
 107 1/2" [2731]
 93 11/16" [2380]

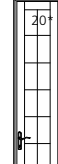

CISWR2090



CISWR2690

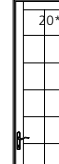

CISWR2890

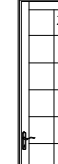

CISWR3090

ELEVATION SYMBOL LEGEND:

M.O. = MASONRY OPENING
 VALUES IN [] ARE IN MILLIMETER CONVERSIONS.
S PANEL IS AVAILABLE AS STATIONARY ONLY.
NUMBER INDICATES DESIGN PRESSURE (DP) RATING WITH STANDARD GLAZING. OPERATING UNITS UTILIZE MULTI-POINT LOCKING HARDWARE FOR DP RATINGS.

Note: Elevations shown DO NOT have exterior trim. Subtract 1/2" (12.7) from M.O. (Masonry Opening) for Unit Size. For other Trim Options refer to the Unit Sizing, Rough Opening & Masonry Openings page.

M.O. BRICKMOULD
M.O. ADAMS/FLAT CASING
ROUGH OPENING
FRAME SIZE
DAYLIGHT OPENING

16 13/16" [427]
 19 7/8" [505]
 14 5/16" [364]
 13 9/16" [344]
 7 1/2" [190]

18 13/16" [478]
 21 7/8" [556]
 16 5/16" [414]
 15 9/16" [395]
 9 1/2" [241]

20 13/16" [529]
 23 7/8" [606]
 18 5/16" [465]
 17 9/16" [446]
 11 1/2" [292]

28 11/16" [729]
 31 3/4" [806]
 26 3/16" [665]
 25 7/16" [646]
 14 5/8" [371]

34 11/16" [881]
 37 3/4" [959]
 32 3/16" [818]
 31 7/16" [799]
 20 5/8" [524]

36 11/16" [932]
 39 3/4" [1010]
 34 3/16" [868]
 33 7/16" [849]
 22 5/8" [575]

40 11/16" [1033]
 43 3/4" [1111]
 38 3/16" [970]
 37 7/16" [951]
 26 5/8" [676]

46 11/16" [1186]
 49 3/4" [1264]
 44 3/16" [1122]
 43 7/16" [1103]
 32 5/8" [829]

84 3/8" [2143]
 85 7/8" [2181]
 83 1/4" [2115]
 82 1/2" [2096]
 68 11/16" [1745]



CISWT1068



CISWT1268



CISWT1468

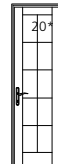

CISWT2068

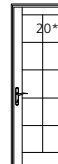

CISWT2668

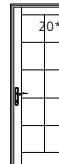

CISWT2868

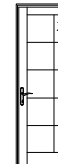

CISWT3068

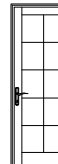

CISWT3668

88 3/8" [2245]
 89 7/8" [2283]
 87 1/4" [2216]
 86 1/2" [2197]
 72 11/16" [1846]

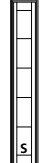

CISWT1070



CISWT1270



CISWT1470

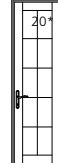

CISWT2070

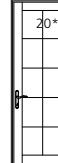

CISWT2670

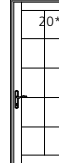

CISWT2870

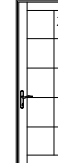

CISWT3070

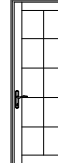

CISWT3670

100 3/8" [2550]
 101 7/8" [2588]
 99 1/4" [2521]
 98 1/2" [2502]
 84 11/16" [2151]

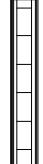

CISWT1080



CISWT1280



CISWT1480

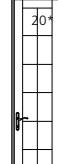

CISWT2080

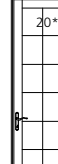

CISWT2680

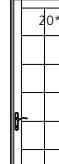

CISWT2880

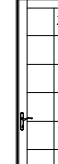

CISWT3080

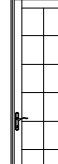

CISWT3680

112 3/8" [2854]
 113 7/8" [2892]
 111 1/4" [2826]
 110 1/2" [2807]
 96 11/16" [2456]



CISWT1090



CISWT1290



CISWT1490

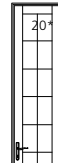

CISWT2090

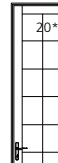

CISWT2690

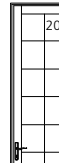

CISWT2890

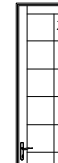

CISWT3090

SCALE: 1/8" = 1'

2-PANEL UNITS

**M.O. BRICKMOULD
M.O. ADAMS/FLAT CASING
ROUGH OPENING
FRAME SIZE
DAYLIGHT OPENING**

61 7/8" [1572]
64 15/16" [1649]
59 3/8" [1508]
58 5/8" [1489]
18 5/8" [473] (2)

65 7/8" [1673]
68 15/16" [1751]
63 3/8" [1610]
62 5/8" [1591]
20 5/8" [524] (2)

73 7/8" [1876]
76 15/16" [1954]
71 3/8" [1813]
70 5/8" [1794]
24 5/8" [625] (2)

81 3/8" [2067]
82 7/8" [2105]
80 1/4" [2038]
79 1/2" [2019]
65 11/16" [1668]

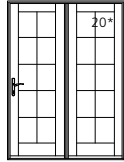

CISWR5068

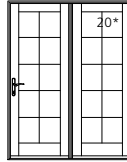

CISWR5468

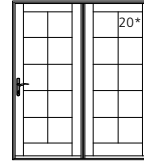

CISWR6068

97 3/8" [2473]
98 7/8" [2511]
96 1/4" [2445]
95 1/2" [2426]
81 11/16" [2075]

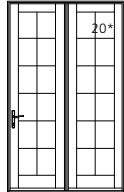

CISWR5080

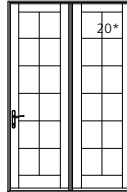

CISWR5480

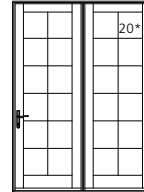

CISWR6080

109 3/8" [2778]
110 7/8" [2816]
108 1/4" [2750]
107 1/2" [2731]
93 11/16" [2380]

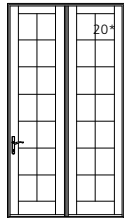

CISWR5090

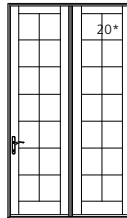

CISWR5490

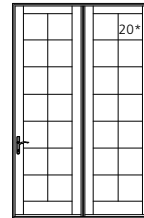

CISWR6090

**M.O. BRICKMOULD
M.O. ADAMS/FLAT CASING
ROUGH OPENING
FRAME SIZE
DAYLIGHT OPENING**

65 7/8" [1673]
68 15/16" [1751]
63 3/8" [1610]
62 5/8" [1591]
20 5/8" [524] (2)

69 7/8" [1775]
72 15/16" [1853]
67 3/8" [1711]
66 5/8" [1692]
22 5/8" [575] (2)

77 7/8" [1978]
80 15/16" [2056]
75 3/8" [1915]
74 5/8" [1895]
26 5/8" [676] (2)

89 7/8" [2283]
92 15/16" [2361]
87 3/8" [2219]
86 5/8" [2200]
32 5/8" [829] (2)

84 3/8" [2143]
85 7/8" [2181]
83 1/4" [2115]
82 1/2" [2096]
68 11/16" [1745]

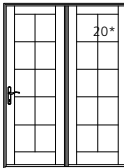

CISWT5068

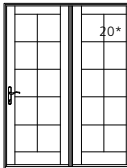

CISWT5468

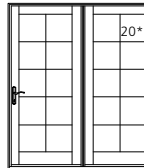

CISWT6068

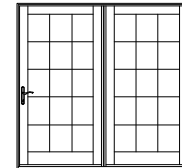

CISWT7068

88 3/8" [2245]
89 7/8" [2283]
87 1/4" [2216]
86 1/2" [2197]
72 11/16" [1846]

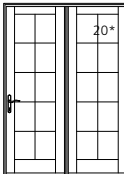

CISWT5070

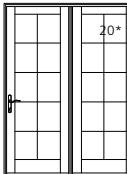

CISWT5470

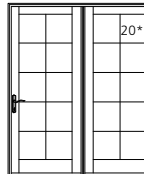

CISWT6070

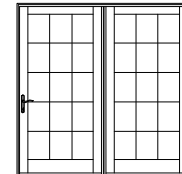

CISWT7070

100 3/8" [2550]
101 7/8" [2588]
99 1/4" [2521]
98 1/2" [2502]
84 11/16" [2151]

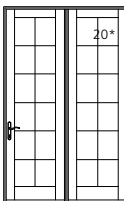

CISWT5080

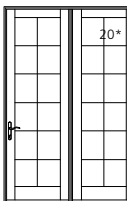

CISWT5480

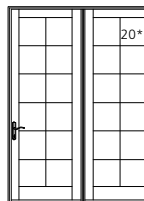

CISWT6080

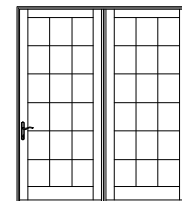

CISWT7080

112 3/8" [2854]
113 7/8" [2892]
111 1/4" [2826]
110 1/2" [2807]
96 11/16" [2456]

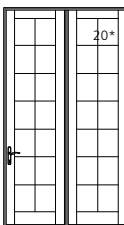

CISWT5090

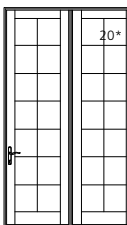

CISWT5490

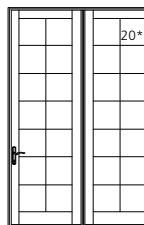

CISWT6090

ELEVATION SYMBOL LEGEND:

M.O. = MASONRY OPENING
VALUES IN () ARE IN MILLIMETER CONVERSIONS.
VALUES IN () ARE NUMBER OF DAYLIGHT OPENINGS PER UNIT.
NUMBER INDICATES DESIGN PRESSURE (DP) RATING WITH STANDARD GLAZING. OPERATING UNITS UTILIZE MULTI-POINT LOCKING HARDWARE FOR DP RATINGS.

Note: Elevations shown DO NOT have exterior trim. Subtract 1/2" (12.7) from M.O. (Masonry Opening) for Unit Size. For other Trim Options refer to the Unit Sizing, Rough Opening & Masonry Openings page.

SCALE: 1/8" = 1'

3-PANEL UNITS

M.O. BRICKMOULD
M.O. ADAMS/FLAT CASING
ROUGH OPENING
FRAME SIZE
DAYLIGHT OPENING

91 1/16" [2313]
94 1/8" [2391]
88 9/16" [2250]
87 13/16" [2230]
18 5/8" [473] (3)

97 1/16" [2465]
100 1/8" [2543]
94 9/16" [2402]
93 13/16" [2383]
20 5/8" [524] (3)

109 1/16" [2770]
112 1/8" [2848]
106 9/16" [2707]
105 13/16" [2688]
24 5/8" [625] (3)

81 3/8" [2067]
82 7/8" [2105]
80 1/4" [2038]
79 1/2" [2019]
65 11/16" [1668]

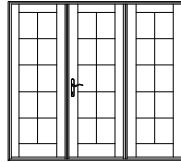

CISWR7668

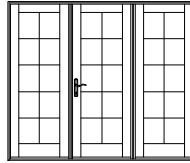

CISWR8068

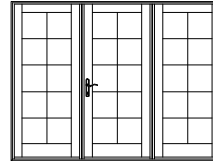

CISWR9068

97 3/8" [2473]
98 7/8" [2511]
96 1/4" [2445]
95 1/2" [2426]
81 11/16 [2075]

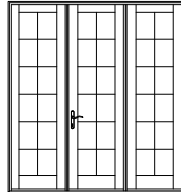

CISWR7680

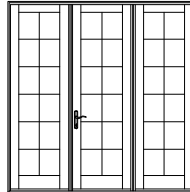

CISWR8080

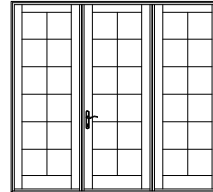

CISWR9080

109 3/8" [2778]
110 7/8" [2816]
108 1/4" [2750]
107 1/2" [2731]
93 11/16" [2380]

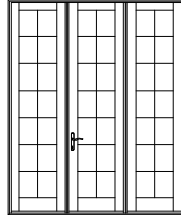

CISWR7690

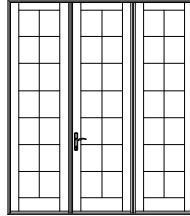

CISWR8090

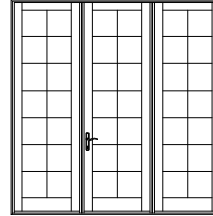

CISWR9090

M.O. BRICKMOULD
M.O. ADAMS/FLAT CASING
ROUGH OPENING
FRAME SIZE
DAYLIGHT OPENING

97 1/16" [2465]
100 1/8" [2543]
94 9/16" [2401]
93 13/16" [2383]
20 5/8" [524] (3)

103 1/16" [2618]
106 1/8" [2696]
100 9/16" [2554]
99 13/16" [2535]
22 5/8" [575] (3)

115 1/16" [2923]
118 1/8" [3000]
112 9/16" [2860]
111 13/16" [2840]
26 5/8" [676] (3)

84 3/8" [2143]
85 7/8" [2181]
83 1/4" [2115]
82 1/2" [2096]
68 11/16" [1745]

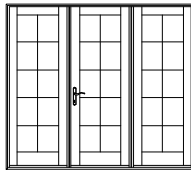

CISWT7668

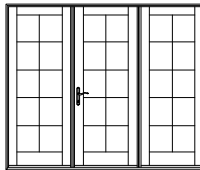

CISWT8068

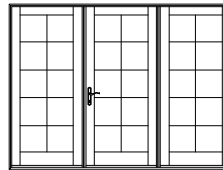

CISWT9068

88 3/8" [2245]
89 7/8" [2283]
87 1/4" [2216]
86 1/2" [2197]
72 11/16" [1846]

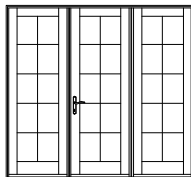

CISWT7670

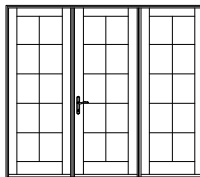

CISWT8070

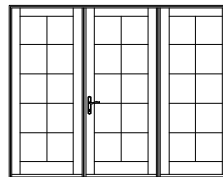

CISWT9070

100 3/8" [2550]
101 7/8" [2588]
99 1/4" [2521]
98 1/2" [2502]
84 11/16 [2151]

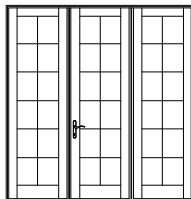

CISWT7680

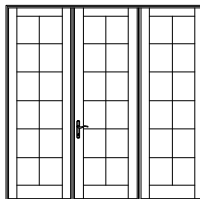

CISWT8080

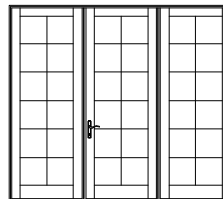

CISWT9080

112 3/8" [2854]
113 7/8" [2892]
111 1/4" [2826]
110 1/2" [2807]
96 11/16" [2455]

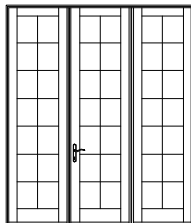

CISWT7690

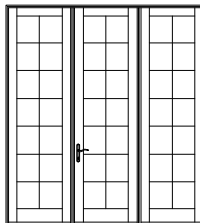

CISWT8090

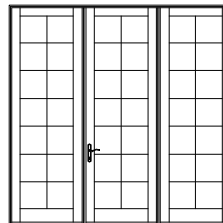

CISWT9090

ELEVATION SYMBOL LEGEND:
M.O. = MASONRY OPENING
VALUES IN [] ARE IN MILLIMETER CONVERSIONS.
VALUES IN () ARE NUMBER OF DAYLIGHT OPENINGS PER UNIT.

Note: Elevations shown DO NOT have exterior trim. Subtract 1/2" (12.7) from M.O. (Masonry Opening) for Unit Size. For other Trim Options refer to the Unit Sizing, Rough Opening & Masonry Openings page.

SCALE: 1/8" = 1'

2-PANEL FRENCH UNITS

M.O. BRICKMOULD
M.O. ADAMS/FLAT CASING
ROUGH OPENING
FRAME SIZE
DAYLIGHT OPENING

49 7/8" [1267]
52 15/16" [1345]
47 3/8" [1203]
46 5/8" [1184]
12 5/8" [321] (2)

61 7/8" [1572]
64 15/16" [1649]
59 3/8" [1508]
58 5/8" [1489]
18 5/8" [473] (2)

65 7/8" [1673]
68 15/16" [1751]
63 3/8" [1610]
62 5/8" [1591]
20 5/8" [524] (2)

73 7/8" [1876]
76 15/16" [1954]
71 3/8" [1813]
70 5/8" [1794]
24 5/8" [625] (2)

81 3/8" [2067]
82 7/8" [2105]
80 1/4" [2038]
79 1/2" [2019]
65 11/16" [1668]

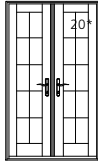

CIFRR4068

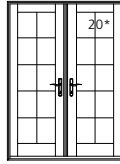

CIFRR5068

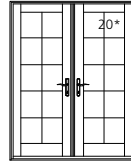

CIFRR5468

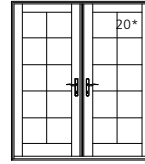

CIFRR6068

97 3/8" [2473]
98 7/8" [2511]
96 1/4" [2445]
95 1/2" [2426]
81 11/16" [2075]

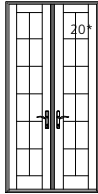

CIFRR4080

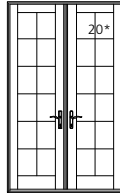

CIFRR5080

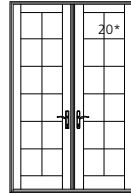

CIFRR5480

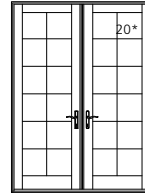

CIFRR6080

109 3/8" [2778]
110 7/8" [2816]
108 1/4" [2750]
107 1/2" [2731]
93 11/16" [2380]

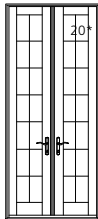

CIFRR4090

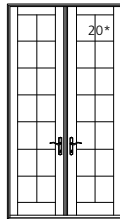

CIFRR5090

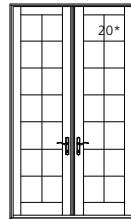

CIFRR5490

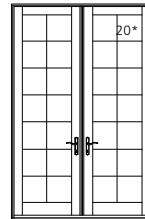

CIFRR6090

M.O. BRICKMOULD
M.O. ADAMS/FLAT CASING
ROUGH OPENING
FRAME SIZE
DAYLIGHT OPENING

53 7/8" [1368]
56 15/16" [1446]
51 3/8" [1305]
50 5/8" [1286]
14 5/8" [371] (2)

65 7/8" [1673]
68 15/16" [1751]
63 3/8" [1610]
62 5/8" [1591]
20 5/8" [524] (2)

69 7/8" [1775]
72 15/16" [1853]
67 3/8" [1711]
66 5/8" [1692]
22 5/8" [575] (2)

77 7/8" [1978]
80 15/16" [2056]
75 3/8" [1915]
74 5/8" [1895]
26 5/8" [676] (2)

89 7/8" [2283]
92 15/16" [2361]
87 3/8" [2219]
86 5/8" [2200]
32 5/8" [829] (2)

84 3/8" [2143]
85 7/8" [2181]
83 1/4" [2115]
82 1/2" [2096]
68 11/16" [1745]

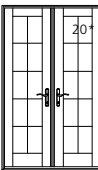

CIFRT4068

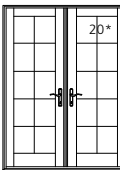

CIFRT5068

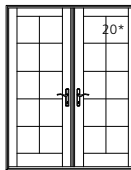

CIFRT5468

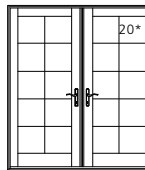

CIFRT6068

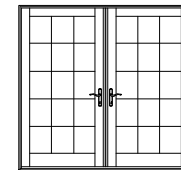

CIFRT7068

88 3/8" [2245]
89 7/8" [2283]
87 1/4" [2216]
86 1/2" [2197]
72 11/16 [1846]

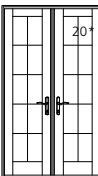

CIFRT4070

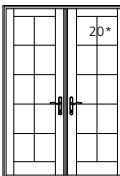

CIFRT5070

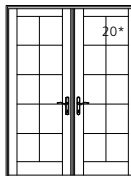

CIFRT5470

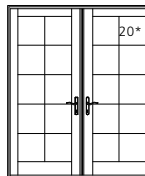

CIFRT6070

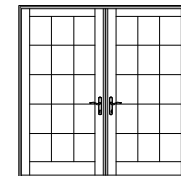

CIFRT7070

100 3/8" [2560]
101 7/8" [2598]
99 1/4" [2531]
98 1/2" [2502]
84 11/16" [2151]

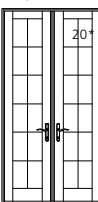

CIFRT4080

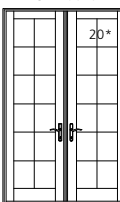

CIFRT5080

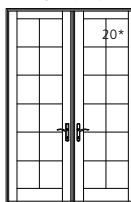

CIFRT5480

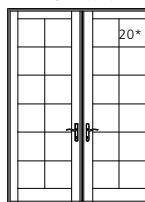

CIFRT6080

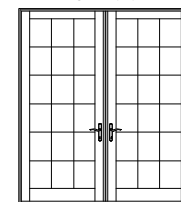

CIFRT7080

112 3/8" [2854]
113 7/8" [2892]
111 1/4" [2826]
110 1/2" [2807]
96 11/16" [2456]

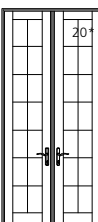

CIFRT4090

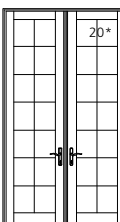

CIFRT5090

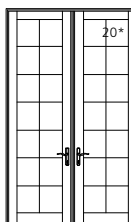

CIFRT5490

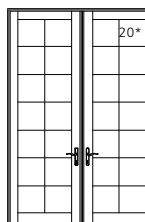

CIFRT6090

ELEVATION SYMBOL LEGEND:
M.O. = MASONRY OPENING
VALUES IN [] ARE IN MILLIMETER CONVERSIONS.
VALUES IN () ARE NUMBER OF DAYLIGHT OPENINGS PER UNIT.
##* NUMBER INDICATES DESIGN PRESSURE (DP) RATING WITH STANDARD GLAZING. OPERATING UNITS UTILIZE MULTI-POINT LOCKING HARDWARE FOR DP RATINGS.

Note: Elevations shown DO NOT have exterior trim. Subtract 1/2" (12.7) from M.O. (Masonry Opening) for Unit Size. For other Trim Options refer to the Unit Sizing, Rough Opening & Masonry Openings page.

SCALE: 1/8" = 1'

4-PANEL FRENCH UNITS

M.O. BRICKMOULD
M.O. ADAMS/FLAT CASING
ROUGH OPENING
FRAME SIZE
DAYLIGHT OPENING

96 1/4" [2445]
99 5/16" [2523]
93 3/4" [2381]
93" [2362]
12 5/8" [321] (4)

120 1/4" [3054]
123 5/16" [3132]
117 3/4" [2991]
117" [2972]
18 5/8" [473] (4)

144 1/4" [3664]
147 5/16" [3742]
141 3/4" [3600]
141" [3581]
24 5/8" [625] (4)

81 3/8" [2067]
82 7/8" [2105]
80 1/4" [2038]
79 1/2" [2019]
65 11/16" [1668]

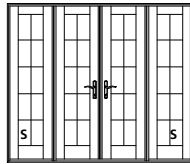

CIFRR8068

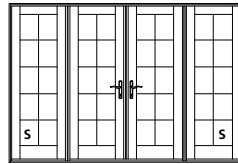

CIFRR10068

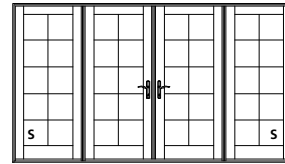

CIFRR12068

97 3/8" [2473]
98 7/8" [2511]
96 1/4" [2445]
95 1/2" [2426]
81 11/16" [2075]

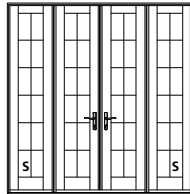

CIFRR8080

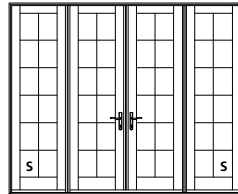

CIFRR10080

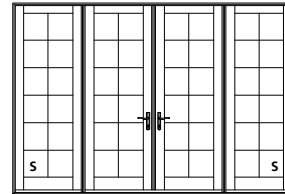

CIFRR12080

109 3/8" [2778]
110 7/8" [2816]
108 1/4" [2750]
107 1/2" [2731]
93 11/16" [2380]

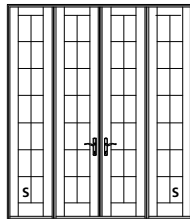

CIFRR8090

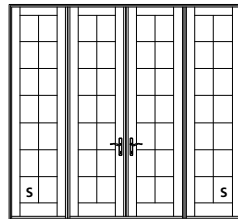

CIFRR10090

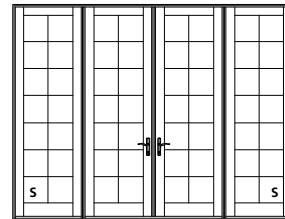

CIFRR12090

M.O. BRICKMOULD
M.O. ADAMS/FLAT CASING
ROUGH OPENING
FRAME SIZE
DAYLIGHT OPENING

104 1/4" [2648]
107 5/16" [2726]
101 3/4" [2584]
101" [2565]
14 5/8" [371] (4)

128 1/4" [3258]
131 5/16" [3335]
125 3/4" [3194]
125" [3175]
20 5/8" [524] (4)

152 1/4" [3867]
155 5/16" [3945]
149 3/4" [3804]
149" [3785]
26 5/8" [676] (4)

84 3/8" [2143]
85 7/8" [2181]
83 1/4" [2115]
82 1/2" [2096]
68 11/16" [1745]

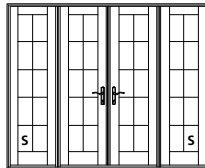

CIFRT8068

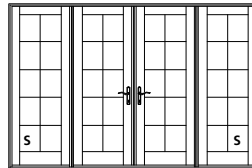

CIFRT10068

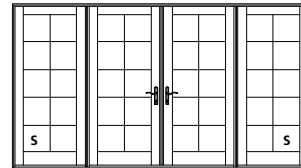

CIFRT12068

88 3/8" [2245]
89 7/8" [2283]
87 1/4" [2216]
86 1/2" [2197]
72 11/16" [1846]

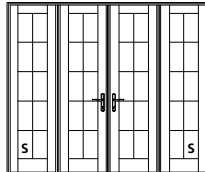

CIFRT8070

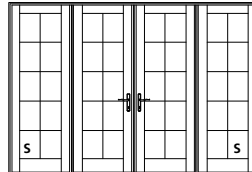

CIFRT10070

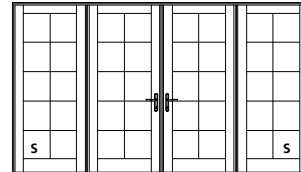

CIFRT12070

100 3/8" [2550]
101 7/8" [2588]
99 1/4" [2521]
98 1/2" [2502]
84 11/16" [2151]

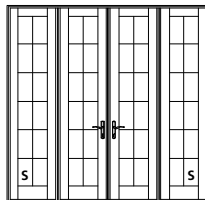

CIFRT8080

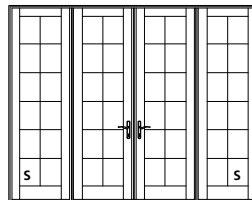

CIFRT10080

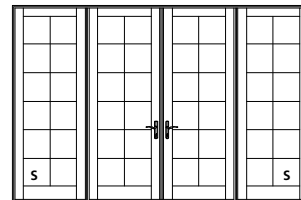

CIFRT12080

112 3/8" [2854]
113 7/8" [2892]
111 1/4" [2826]
110 1/2" [2807]
96 11/16" [2456]

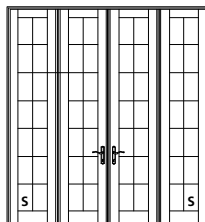

CIFRT8090

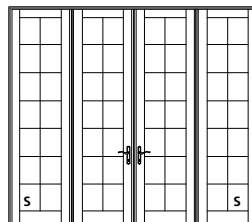

CIFRT10090

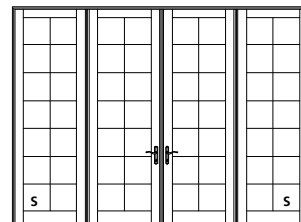

CIFRT12090

Note: Elevations shown DO NOT have exterior trim. Subtract 1/2" (12.7) from M.O. (Masonry Opening) for Unit Size. For other Trim Options refer to the Unit Sizing, Rough Opening & Masonry Openings page.

SCALE: 1/8" = 1'

ELEVATION SYMBOL LEGEND:
M.O. = MASONRY OPENING
VALUES IN [] ARE IN MILLIMETER CONVERSIONS.
VALUES IN () ARE NUMBER OF DAYLIGHT OPENINGS PER UNIT.
S PANEL IS AVAILABLE AS STATIONARY ONLY.

SINGLE DOOR WITH SINGLE SIDELITE

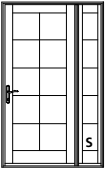
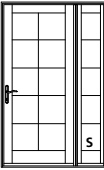
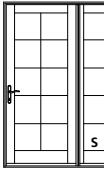
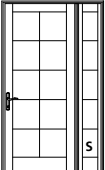
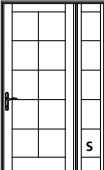
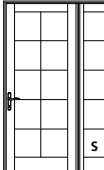
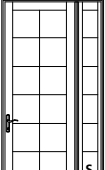
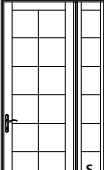
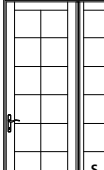
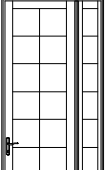
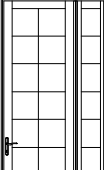
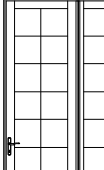
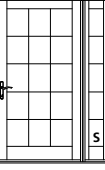
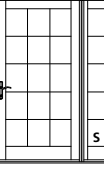
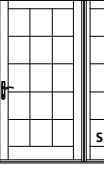
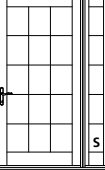
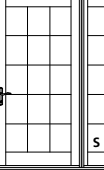
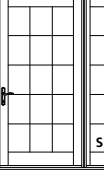
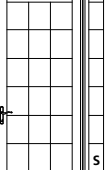
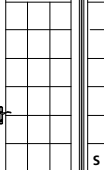
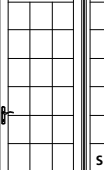
| M.O. BRICKMOULD | 54" [1372] | 56" [1422] | 58" [1473] |
|--|---|---|--|
| M.O. ADAMS/FLAT CASING | 57 1/16" [1449] | 59 1/16" [1500] | 61 1/16" [1551] |
| ROUGH OPENING | 51 1/2" [1308] | 53 1/2" [1359] | 55 1/2" [1410] |
| FRAME SIZE | 50 3/4" [1289] | 52 3/4" [1340] | 54 3/4" [1391] |
| DAYLIGHT OPENING | 26 5/8" [676] - 7 1/2" [190] | 26 5/8" [676] - 9 1/2" [241] | 26 5/8" [676] - 11 1/2" [292] |
| 84 3/8" [2143] 85 7/8" [2181] 83 1/4" [2114] 82 1/2" [2096] 68 11/16" [1745] |  |  |  |
| | CISWT3068B10 | CISWT3068B12 | CISWT3068B14 |
| 88 3/8" [2245] 89 7/8" [2283] 87 1/4" [2216] 86 1/2" [2197] 72 11/16" [1846] |  |  |  |
| | CISWT3070B10 | CISWT3070B12 | CISWT3070B14 |
| 100 3/8" [2550] 101 7/8" [2588] 99 1/4" [2521] 98 1/2" [2502] 84 11/16" [2151] |  |  |  |
| | CISWT3080B10 | CISWT3080B12 | CISWT3080B14 |
| 112 3/8" [2854] 113 7/8" [2892] 111 1/4" [2826] 110 1/2" [2807] 96 11/16" [2456] |  |  |  |
| | CISWT3090B10 | CISWT3090B12 | CISWT3090B14 |
| M.O. BRICKMOULD | 60" [1524] | 62" [1575] | 64" [1626] |
| M.O. ADAMS/FLAT CASING | 63 1/16" [1602] | 65 1/16" [1653] | 67 1/16" [1703] |
| ROUGH OPENING | 57 1/2" [1460] | 59 1/2" [1511] | 61 1/2" [1562] |
| FRAME SIZE | 56 3/4" [1441] | 58 3/4" [1492] | 60 3/4" [1543] |
| DAYLIGHT OPENING | 32 5/8" [829] - 7 1/2" [190] | 32 5/8" [829] - 9 1/2" [241] | 32 5/8" [829] - 11 1/2" [292] |
| 84 3/8" [2143] 85 7/8" [2181] 83 1/4" [2115] 82 1/2" [2096] 68 11/16" [1745] |  |  |  |
| | CISWT3668B10 | CISWT3668B12 | CISWT3668B14 |
| 88 3/8" [2245] 89 7/8" [2283] 87 1/4" [2216] 86 1/2" [2197] 72 11/16" [1846] |  |  |  |
| | CISWT3670B10 | CISWT3670B12 | CISWT3670B14 |
| 100 3/8" [2550] 101 7/8" [2588] 99 1/4" [2521] 98 1/2" [2502] 84 11/16" [2151] |  |  |  |
| | CISWT3680B10 | CISWT3680B12 | CISWT3680B14 |

ELEVATION SYMBOL LEGEND:
M.O. = MASONRY OPENING
 VALUES IN [] ARE IN MILLIMETER CONVERSIONS.
 VALUES IN () ARE NUMBER OF DAYLIGHT OPENINGS PER UNIT.
S PANEL IS AVAILABLE AS STATIONARY ONLY.

Note: Elevations shown DO NOT have exterior trim. Subtract 1/2" (12.7) from M.O. (Masonry Opening) for Unit Size. For other Trim Options refer to the Unit Sizing, Rough Opening & Masonry Openings page.

SCALE: 1/8" = 1'

SINGLE DOOR WITH TWO SIDELITES

| M.O. BRICKMOULD | 67 5/16" [1710] | 71 5/16" [1811] | 75 5/16" [1913] |
|--|----------------------------------|----------------------------------|-----------------------------------|
| M.O. ADAMS/FLAT CASING | 70 3/8" [1788] | 74 3/8" [1889] | 78 3/8" [1991] |
| ROUGH OPENING | 64 13/16" [1646] | 68 13/16" [1747] | 72 13/16" [1849] |
| FRAME SIZE | 64 1/16" [1627] | 68 1/16" [1729] | 72 1/16" [1830] |
| DAYLIGHT OPENING | 26 5/8" [676] - 7 1/2" [190] (2) | 26 5/8" [676] - 9 1/2" [241] (2) | 26 5/8" [676] - 11 1/2" [292] (2) |
| 84 3/8" [2143] 85 7/8" [2181] 87 1/4" [2214] 88 1/2" [2245] 89 7/8" [2283] | | | |
| 88 3/8" [2245] 89 7/8" [2283] 87 1/4" [2216] 86 1/2" [2197] 72 11/16" [1846] | | | |
| 100 3/8" [2550] 101 7/8" [2588] 99 1/4" [2521] 98 1/2" [2502] 85 3/4" [2178] 84 11/16" [2151] | | | |
| 112 3/8" [2854] 113 7/8" [2892] 111 1/4" [2825] 110 1/2" [2807] 96 11/16" [2456] | | | |
| M.O. BRICKMOULD | 73 5/16" [1862] | 77 5/16" [1964] | 81 5/16" [2065] |
| M.O. ADAMS/FLAT CASING | 76 3/8" [1940] | 80 3/8" [2042] | 84 3/8" [2143] |
| ROUGH OPENING | 70 13/16" [1798] | 74 13/16" [1900] | 78 13/16" [2001] |
| FRAME SIZE | 70 1/16" [1780] | 74 1/16" [1881] | 78 1/16" [1983] |
| DAYLIGHT OPENING | 32 5/8" [829] - 7 1/2" [190] (2) | 32 5/8" [829] - 9 1/2" [241] (2) | 32 5/8" [829] - 11 1/2" [292] (2) |
| 84 3/8" [2143] 85 7/8" [2181] 83 1/4" [2114] 82 1/2" [2096] 68 11/16" [1745] | | | |
| 88 3/8" [2245] 89 7/8" [2283] 87 1/4" [2216] 86 1/2" [2197] | | | |
| 100 3/8" [2550] 101 7/8" [2588] 99 1/4" [2521] 98 1/2" [2502] 84 11/16" [2151] | | | |

ELEVATION SYMBOL LEGEND:
M.O. = MASONRY OPENING
 VALUES IN [] ARE IN MILLIMETER CONVERSIONS.
 VALUES IN () ARE NUMBER OF DAYLIGHT OPENINGS PER UNIT.
S PANEL IS AVAILABLE AS STATIONARY ONLY.

Note: Elevations shown DO NOT have exterior trim. Subtract 1/2" (12.7) from M.O. (Masonry Opening) for Unit Size. For other Trim Options refer to the Unit Sizing, Rough Opening & Masonry Openings page.

SCALE: 1/8" = 1'

FRENCH DOOR WITH TWO SIDELITES
5-0 UNITS

M.O. BRICKMOULD
M.O. ADAMS/FLAT CASING
ROUGH OPENING
FRAME SIZE
DAYLIGHT OPENING

92 1/2" [2350]
95 9/16" [2427]
90" [2286]
89 1/4" [2267]
20 5/8" [524] (2) - 7 1/2" [190] (2)

96 1/2" [2451]
99 9/16" [2529]
94" [2387]
93 1/4" [2369]
20 5/8" [524] (2) - 9 1/2" [241] (2)

100 1/2" [2553]
103 9/16" [2630]
98" [2489]
97 1/4" [2470]
20 5/8" [524] (2) - 11 1/2" [292] (2)

84 3/8" [2143]
85 7/8" [2181]
83 1/4" [2114]
82 1/2" [2096]
68 11/16" [1745]

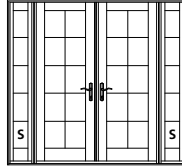

CIFRT5068Q10

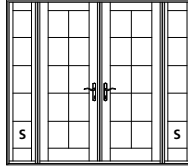

CIFRT5068Q12

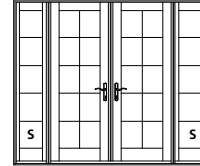

CIFRT5068Q14

88 3/8" [2245]
89 7/8" [2283]
87 1/4" [2216]
86 1/2" [2197]
72 11/16" [1846]

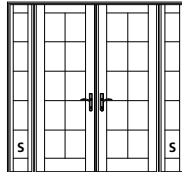

CIFRT5070Q10

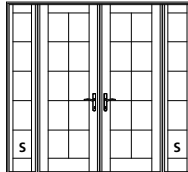

CIFRT5070Q12

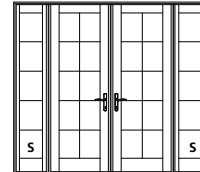

CIFRT5070Q14

100 3/8" [2550]
101 7/8" [2588]
99 1/4" [2521]
98 1/2" [2502]
84 11/16" [2151]

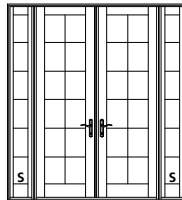

CIFRT5080Q10

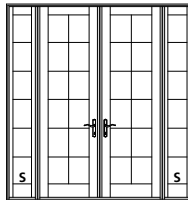

CIFRT5080Q12

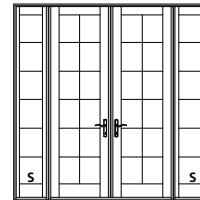

CIFRT5080Q14

112 3/8" [2854]
113 7/8" [2892]
111 1/4" [2825]
110 1/2" [2807]
96 11/16" [2456]

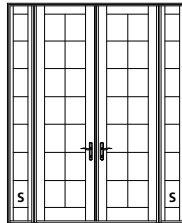

CIFRT5090Q10

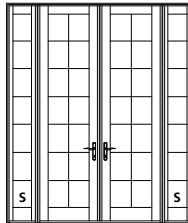

CIFRT5090Q12

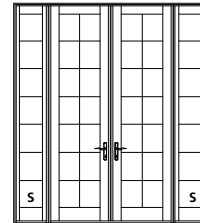

CIFRT5090Q14

ELEVATION SYMBOL LEGEND:

M.O. = MASONRY OPENING
VALUES IN [] ARE IN MILLIMETER CONVERSIONS.
VALUES IN () ARE NUMBER OF DAYLIGHT OPENINGS PER UNIT.
S PANEL IS AVAILABLE AS STATIONARY ONLY.

Note: Elevations shown DO NOT have exterior trim. Subtract 1/2" (12.7) from M.O. (Masonry Opening) for Unit Size. For other Trim Options refer to the Unit Sizing, Rough Opening & Masonry Openings page.

SCALE: 1/8" = 1'

FRENCH DOOR WITH TWO SIDELITES
5-4 UNITS

M.O. BRICKMOLD
M.O. ADAMS/FLAT CASING
ROUGH OPENING
FRAME SIZE
DAYLIGHT OPENING

96 1/2" [2451]
99 9/16" [2529]
94" [2387]
93 1/4" [2369]
22 5/8" [575] (2) - 7 1/2" [190] (2)

100 1/2" [2553]
103 9/16" [2630]
98" [2489]
97 1/4" [2470]
22 5/8" [575] (2) - 9 1/2" [241] (2)

104 1/2" [2654]
107 9/16" [2732]
102" [2600]
101 1/4" [2572]
22 5/8" [602] (2) - 11 1/2" [292] (2)

84 3/8" [2143]
85 7/8" [2181]
83 1/4" [2114]
82 1/2" [2096]
68 11/16" [1745]

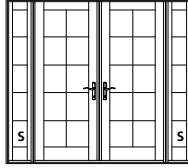

CIFRT5468Q10

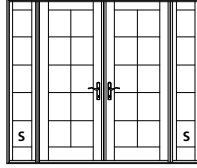

CIFRT5468Q12

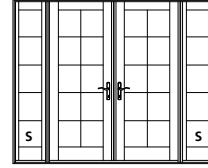

CIFRT5468Q14

88 3/8" [2245]
89 7/8" [2283]
87 1/4" [2216]
86 1/2" [2197]
72 11/16" [1846]

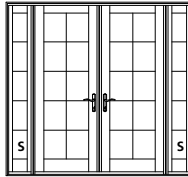

CIFRT5470Q10

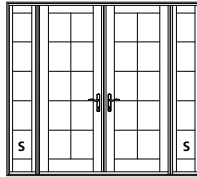

CIFRT5470Q12

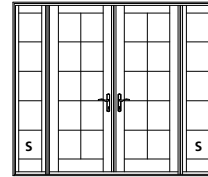

CIFRT5470Q14

100 3/8" [2550]
101 7/8" [2588]
99 1/4" [2521]
98 1/2" [2502]
84 11/16" [2151]

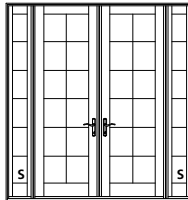

CIFRT5480Q10

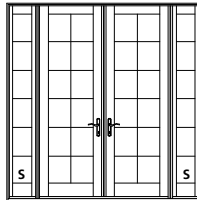

CIFRT5480Q12

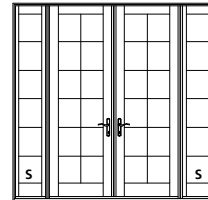

CIFRT5480Q14

112 3/8" [2854]
113 7/8" [2892]
111 1/4" [2825]
110 1/2" [2807]
96 11/16" [2456]

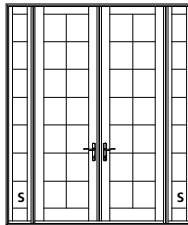

CIFRT5490Q10

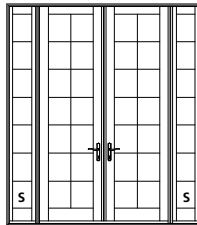

CIFRT5490Q12

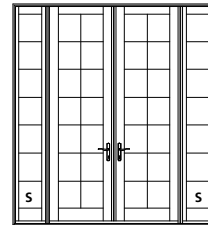

CIFRT5490Q14

ELEVATION SYMBOL LEGEND:

M.O. = MASONRY OPENING
VALUES IN [] ARE IN MILLIMETER CONVERSIONS.
VALUES IN () ARE NUMBER OF DAYLIGHT OPENINGS PER UNIT.
S PANEL IS AVAILABLE AS STATIONARY ONLY.

Note: Elevations shown DO NOT have exterior trim. Subtract 1/2" (12.7) from M.O. (Masonry Opening) for Unit Size. For other Trim Options refer to the Unit Sizing, Rough Opening & Masonry Openings page.

SCALE: 1/8" = 1'

FRENCH DOOR WITH TWO SIDELITES
6-0 UNITS

M.O. BRICKMOUND
M.O. ADAMS/FLAT CASING
ROUGH OPENING
FRAME SIZE
DAYLIGHT OPENING

104 1/2" [2654]
107 9/16" [2732]
102" [2590]
101 1/4" [2572]
26 5/8" [676] (2) - 7 1/2" [190] (2)

108 1/2" [2756]
111 9/16" [2834]
106" [2692]
105 1/4" [2673]
26 5/8" [676] (2) - 9 1/2" [241] (2)

112 1/2" [2858]
115 9/16" [2935]
110" [2794]
109 1/4" [2775]
26 5/8" [676] (2) - 11 1/2" [292] (2)

84 3/8" [2143]
85 7/8" [2181]
83 1/4" [2114]
82 1/2" [2096]
69 3/4" [1772]
69 3/4" [1745]

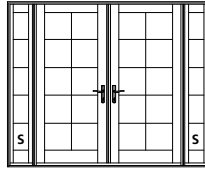

CIFRT6068Q10

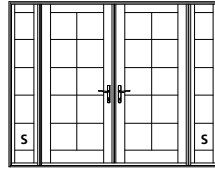

CIFRT6068Q12

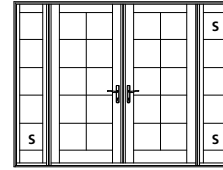

CIFRT6068Q14

88 3/8" [2245]
89 7/8" [2283]
87 1/4" [2216]
86 1/2" [2197]
75 3/4" [1872]
72 11/16" [1846]

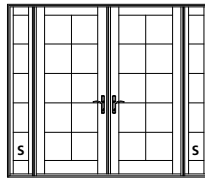

CIFRT6070Q10

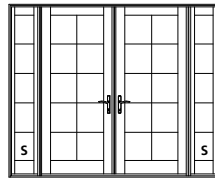

CIFRT6070Q12



CIFRT6070Q14

100 3/8" [2550]
101 7/8" [2588]
99 1/4" [2521]
98 1/2" [2502]
85 3/4" [2178]
84 11/16" [2151]

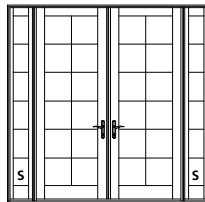

CIFRT6080Q10

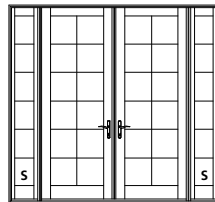

CIFRT6080Q12

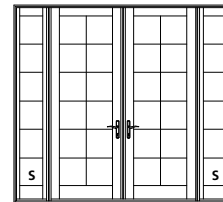

CIFRT6080Q14

112 3/8" [2854]
113 7/8" [2892]
111 1/4" [2825]
110 1/2" [2807]
97 3/4" [2483]
96 11/16" [2456]

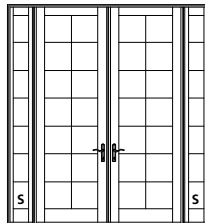

CIFRT6090Q10

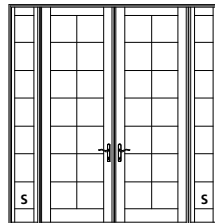

CIFRT6090Q12

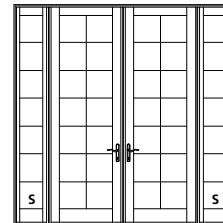

CIFRT6090Q14

ELEVATION SYMBOL LEGEND:

M.O. = MASONRY OPENING
VALUES IN () ARE IN MILLIMETER CONVERSIONS.
VALUES IN () ARE NUMBER OF DAYLIGHT OPENINGS PER UNIT.
S PANEL IS AVAILABLE AS STATIONARY ONLY.

Note: Elevations shown DO NOT have exterior trim. Subtract 1/2" (12.7) from M.O. (Masonry Opening) for Unit Size. For other Trim Options refer to the Unit Sizing, Rough Opening & Masonry Openings page.

SCALE: 1/8" = 1'

FRENCH DOOR WITH TWO SIDELITES
7-0 UNITS

M.O. BRICKMOULD
M.O. ADAMS/FLAT CASING
ROUGH OPENING
FRAME SIZE
DAYLIGHT OPENING

116 1/2" [2959]
119 9/16" [3037]
114" [2885]
113 1/4" [2877]
32 5/8" [829] (2) - 7 1/2" [190] (2)

120 1/2" [3061]
123 9/16" [3138]
118" [2997]
117 1/4" [2978]
32 5/8" [829] (2) - 9 1/2" [241] (2)

124 1/2" [3162]
127 9/16" [3240]
122" [3098]
121 1/4" [3080]
32 5/8" [829] (2) - 11 1/2" [292] (2)

84 3/8" [2143]
85 7/8" [2181]
83 1/4" [2114]
82 1/2" [2096]
68 11/16" [1745]

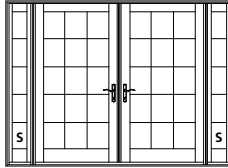

CIFRT7068Q10

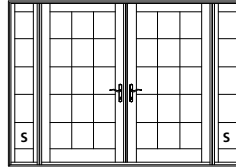

CIFRT7068Q12

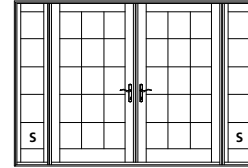

CIFRT7068Q14

88 3/8" [2245]
89 7/8" [2283]
87 1/4" [2216]
86 1/2" [2197]
72 11/16" [1846]

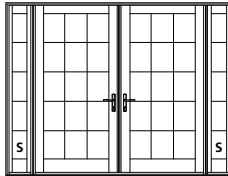

CIFRT7070Q10

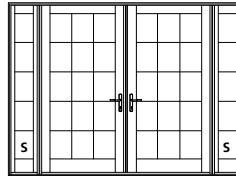

CIFRT7070Q12

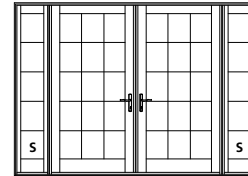

CIFRT7070Q14

100 3/8" [2550]
101 7/8" [2588]
99 1/4" [2521]
98 1/2" [2502]
84 11/16" [2151]

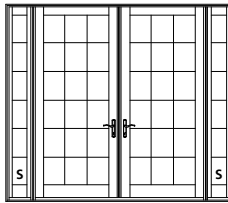

CIFRT7080Q10

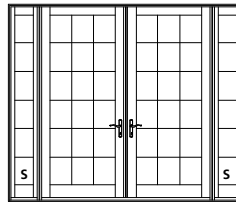

CIFRT7080Q12

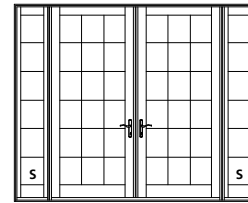

CIFRT7080Q14







ELEVATION SYMBOL LEGEND:







M.O. = MASONRY OPENING
VALUES IN [] ARE IN MILLIMETER CONVERSIONS.
VALUES IN () ARE NUMBER OF DAYLIGHT OPENINGS PER UNIT.
S PANEL IS AVAILABLE AS STATIONARY ONLY.

Note: Elevations shown DO NOT have exterior trim. Subtract 1/2" (12.7) from M.O. (Masonry Opening) for Unit Size. For other Trim Options refer to the Unit Sizing, Rough Opening & Masonry Openings page.









SINGLE SASH TRANSOMS









| | | | | | | |
|-------------------------------|-----------------|-----------------|-----------------|------------------|------------------|------------------|
| M.O. BRICKMOULD | 26 11/16" [678] | 32 11/16" [830] | 38 11/16" [983] | 49 7/8" [1267] | 61 7/8" [1572] | 73 7/8" [1876] |
| M.O. ADAMS/FLAT CASING | 29 3/4" [756] | 35 3/4" [908] | 41 3/4" [1060] | 52 15/16" [1345] | 64 15/16" [1649] | 76 15/16" [1954] |
| ROUGH OPENING | 24 3/16" [614] | 30 3/16" [767] | 36 3/16" [919] | 47 3/8" [1203] | 59 3/8" [1508] | 71 3/8" [1815] |
| FRAME SIZE | 23 7/16" [595] | 29 7/16" [748] | 35 7/16" [900] | 46 5/8" [1184] | 58 5/8" [1489] | 70 5/8" [1794] |
| DAYLIGHT OPENING | 12 5/8" [321] | 18 5/8" [473] | 24 5/8" [625] | 35 13/16" [910] | 47 13/16" [1214] | 59 13/16" [1519] |

| | | | | | | |
|-----------------|---|---|---|---|--|---|
| 20 1/2" [521] |  |  |  |  |  |  |
| 22" [559] | CTISWR2016 | CTISWR2616 | CTISWR3016 | CTIFRR4016 | CTIFRR5016 | CTIFRR6016 |
| 18 3/4" [476] | | | | | | |
| 18" [457] | | | | | | |
| 10 15/16" [278] | | | | | | |





| | | | | | | |
|-----------------|---|---|---|---|--|---|
| 32 1/2" [826] |  |  |  |  |  |  |
| 34" [864] | CTISWR2026 | CTISWR2626 | CTISWR3026 | CTIFRR4026 | CTIFRR5026 | CTIFRR6026 |
| 30 3/4" [781] | | | | | | |
| 30" [762] | | | | | | |
| 22 15/16" [583] | | | | | | |

| | | | | | | | | |
|-------------------------------|-----------------|-----------------|-----------------|-----------------|-----------------|-----------------|------------------|------------------|
| M.O. BRICKMOULD | 16 13/16" [427] | 18 13/16" [478] | 20 13/16" [529] | 28 11/16" [729] | 34 11/16" [881] | 36 11/16" [932] | 40 11/16" [1033] | 46 11/16" [1186] |
| M.O. ADAMS/FLAT CASING | 19 7/8" [505] | 21 7/8" [556] | 23 7/8" [606] | 31 3/4" [806] | 37 3/4" [959] | 39 3/4" [1010] | 43 3/4" [1111] | 49 3/4" [1264] |
| ROUGH OPENING | 14 5/16" [364] | 16 5/16" [414] | 18 5/16" [465] | 26 3/16" [665] | 32 3/16" [818] | 34 3/16" [868] | 38 3/16" [970] | 44 3/16" [1122] |
| FRAME SIZE | 13 9/16" [344] | 15 9/16" [395] | 17 9/16" [446] | 25 7/16" [646] | 31 7/16" [799] | 33 7/16" [849] | 37 7/16" [951] | 43 7/16" [1103] |
| DAYLIGHT OPENING | 7 1/2" [190] | 9 1/2" [241] | 11 1/2" [292] | 14 5/8" [371] | 20 5/8" [524] | 22 5/8" [575] | 26 5/8" [676] | 32 5/8" [829] |

| | | | | | | | | |
|-----------------|---|---|---|---|---|---|---|---|
| 20 1/2" [521] |  |  |  |  |  |  |  |  |
| 22" [559] | CTISWT1016 | CTISWT1216 | CTISWT1416 | CTISWT2016 | CTISWT2616 | CTISWT2816 | CTISWT3016 | CTISWT3616 |
| 18 3/4" [476] | | | | | | | | |
| 18" [457] | | | | | | | | |
| 10 15/16" [278] | | | | | | | | |

| | | | | | | | | |
|-----------------|---|---|---|---|---|---|---|---|
| 32 1/2" [826] |  |  |  |  |  |  |  |  |
| 34" [864] | CTISWT1026 | CTISWT1226 | CTISWT1426 | CTISWT2026 | CTISWT2626 | CTISWT2826 | CTISWT3026 | CTISWT3626 |
| 30 3/4" [781] | | | | | | | | |
| 30" [762] | | | | | | | | |
| 22 15/16" [583] | | | | | | | | |

| | | | | | |
|-------------------------------|------------------|------------------|------------------|------------------|------------------|
| M.O. BRICKMOULD | 53 7/8" [1368] | 65 7/8" [1673] | 69 7/8" [1775] | 77 7/8" [1978] | 89 7/8" [2283] |
| M.O. ADAMS/FLAT CASING | 56 15/16" [1446] | 68 15/16" [1751] | 72 15/16" [1853] | 80 15/16" [2056] | 92 15/16" [2361] |
| ROUGH OPENING | 51 3/8" [1305] | 63 3/8" [1610] | 67 3/8" [1711] | 75 3/8" [1915] | 87 3/8" [2219] |
| FRAME SIZE | 62 5/8" [1591] | 62 5/8" [1591] | 66 5/8" [1692] | 74 5/8" [1895] | 86 5/8" [2200] |
| DAYLIGHT OPENING | 39 13/16" [1011] | 51 13/16" [1316] | 55 13/16" [1418] | 63 13/16" [1621] | 75 13/16" [1926] |

| | | | | | |
|-----------------|---|---|---|--|---|
| 20 1/2" [521] |  |  |  |  |  |
| 22" [559] | CTIFRT4016 | CTIFRT5016 | CTIFRT5416 | CTIFRT6016 | CTIFRT7016 |
| 18 3/4" [476] | | | | | |
| 18" [457] | | | | | |
| 10 15/16" [278] | | | | | |

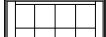
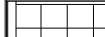
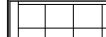
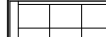
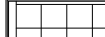
| | | | | | |
|-----------------|---|---|---|--|---|
| 32 1/2" [826] |  |  |  |  |  |
| 34" [864] | CTIFRT4026 | CTIFRT5026 | CTIFRT5426 | CTIFRT6026 | CTIFRT7026 |
| 30 3/4" [781] | | | | | |
| 30" [762] | | | | | |
| 22 15/16" [583] | | | | | |

ELEVATION SYMBOL LEGEND:

M.O. = MASONRY OPENING
VALUES IN [] ARE IN MILLIMETER CONVERSIONS.
VALUES IN () ARE NUMBER OF DAYLIGHT OPENINGS PER UNIT.

Note: Vertical Masonry Opening sizes are shown for units with 4-9/16" jamb. For transom units with 6-9/16" jamb subtract 1/8" from the finished dimensions.

Note: Elevations shown DO NOT have exterior trim. Subtract 1/2" (12.7) from M.O. (Masonry Opening) for Unit Sizes. Masonry Openings above include Sill Nose, see Transom Rail & Sill Options page for Sill Nose specifications. For other Trim Options refer to the Unit Sizing, Rough Opening & Masonry Openings page.

SCALE: 1/8" = 1'

2-SASH TRANSOMS

| | | | | |
|---|------------------------------|------------------------------|-------------------------------|-------------------|
| M.O. BRICKMOULD M.O. ADAMS/FLAT CASING ROUGH OPENING FRAME SIZE DAYLIGHT OPENING | 49 7/8" [1267] | 61 7/8" [1572] | 73 7/8" [1876] | 53 7/8" [1368] |
| | 52 15/16" [1345] | 64 15/16" [1649] | 76 15/16" [1954] | 56 15/16" [1446] |
| | 47 3/8" [1203] | 59 3/8" [1508] | 71 3/8" [1813] | 51 3/8" [1305] |
| | 46 5/8" [1184] | 58 5/8" [1489] | 70 5/8" [1794] | 50 5/8" [1286] |
| | 12 5/8" [321] (2) | 18 5/8" [473] (2) | 24 5/8" [625] (2) | 14 5/8" [371] (2) |
| 20 1/2" [521] 22" [559] 18 3/4" [476] 18" [457] 10 15/16" [278] | | | | |
| | CTISWR4016 | CTISWR5016 | CTISWR6016 | CTISWT4016 |
| 32 1/2" [826] 34" [864] 30 3/4" [781] 30" [762] 22 15/16" [583] | | | | |
| | CTISWR4026 | CTISWR5026 | CTISWR6026 | CTISWT4026 |
| M.O. BRICKMOULD M.O. ADAMS/FLAT CASING ROUGH OPENING FRAME SIZE DAYLIGHT OPENING | 65 7/8" [1673] | 69 7/8" [1775] | 77 7/8" [1978] | 89 7/8" [2263] |
| | 68 15/16" [1751] | 72 15/16" [1853] | 80 15/16" [2056] | 92 15/16" [2361] |
| | 63 3/8" [1610] | 67 3/8" [1711] | 75 3/8" [1915] | 87 3/8" [2219] |
| | 62 5/8" [1591] | 66 5/8" [1692] | 74 5/8" [1895] | 86 5/8" [2200] |
| | 20 5/8" [524] (2) | 22 5/8" [575] (2) | 26 5/8" [676] (2) | 32 5/8" [829] (2) |
| 20 1/2" [521] 22" [559] 18 3/4" [476] 18" [457] 10 15/16" [278] | | | | |
| | CTISWT5016 | CTISWT5416 | CTISWT6016 | CTISWT7016 |
| 32 1/2" [826] 34" [864] 30 3/4" [781] 30" [762] 22 15/16" [583] | | | | |
| | CTISWT5026 | CTISWT5426 | CTISWT6026 | CTISWT7026 |
| M.O. BRICKMOULD M.O. ADAMS/FLAT CASING ROUGH OPENING FRAME SIZE DAYLIGHT OPENING | 54" [1372] | 56" [1422] | 58" [1473] | |
| | 57 1/16" [1449] | 59 1/16" [1500] | 61 1/16" [1551] | |
| | 51 1/2" [1308] | 53 1/2" [1359] | 55 1/2" [1410] | |
| | 50 3/4" [1289] | 52 3/4" [1340] | 54 3/4" [1391] | |
| | 26 5/8" [676] - 7 1/2" [190] | 26 5/8" [703] - 9 1/2" [241] | 26 5/8" [676] - 11 1/2" [292] | |
| 20 1/2" [521] 22" [559] 18 3/4" [476] 18" [457] 10 15/16" [278] | | | | |
| | CTISWT3016B10 | CTISWT3016B12 | CTISWT3016B14 | |
| 32 1/2" [826] 34" [864] 30 3/4" [781] 30" [762] 22 15/16" [583] | | | | |
| | CTISWT3026B10 | CTISWT3026B12 | CTISWT3026B14 | |
| M.O. BRICKMOULD M.O. ADAMS/FLAT CASING ROUGH OPENING FRAME SIZE DAYLIGHT OPENING | 60" [1524] | 62" [1575] | 64" [1626] | |
| | 63 1/16" [1602] | 65 1/16" [1653] | 67 1/16" [1703] | |
| | 57 1/2" [1461] | 59 1/2" [1511] | 61 1/2" [1562] | |
| | 56 3/4" [1441] | 58 3/4" [1492] | 60 3/4" [1543] | |
| | 32 5/8" [829] - 7 1/2" [190] | 32 5/8" [829] - 9 1/2" [241] | 32 5/8" [829] - 11 1/2" [292] | |
| 20 1/2" [521] 22" [559] 18 3/4" [476] 18" [457] 10 15/16" [278] | | | | |
| | CTISWT3616B10 | CTISWT3616B12 | CTISWT3616B14 | |
| 32 1/2" [826] 34" [864] 30 3/4" [781] 30" [762] 22 15/16" [583] | | | | |
| | CTISWT3626B10 | CTISWT3626B12 | CTISWT3626B14 | |

ELEVATION SYMBOL LEGEND:

M.O. = MASONRY OPENING
 VALUES IN [] ARE IN MILLIMETER CONVERSIONS.
 VALUES IN () ARE NUMBER OF DAYLIGHT OPENINGS PER UNIT.

Note: Elevations shown DO NOT have exterior trim. Subtract 1/2" (12.7) from M.O. (Masonry Opening) for Unit Sizes. Masonry Openings above include Sill Nose, see Transom Rail & Sill Options page for Sill Nose specifications. For other Trim Options refer to the Unit Sizing, Rough Opening & Masonry Openings page.

SCALE: 1/8" = 1'

3-SASH TRANSOMS

M.O. BRICKMOULD
M.O. ADAMS/FLAT CASING
ROUGH OPENING
FRAME SIZE
DAYLIGHT OPENING

91 1/16" [2313]
94 1/8" [2391]
88 9/16" [2249]
87 13/16" [2230]
18 5/8" [473] (3)

109 1/16" [2770]
112 1/8" [2848]
106 9/16" [2707]
105 13/16" [2688]
24 5/8" [625] (3)

97 1/16" [2465]
100 1/8" [2543]
94 9/16" [2402]
93 13/16" [2383]
20 5/8" [524] (3)

20 1/2" [521]
22" [559]
18 3/4" [476]
30" [762]
18" [457]
22 15/16" [278]

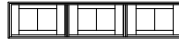

CTISWR7616



CTISWR9016

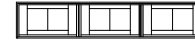

CTISWT7616

32 1/2" [826]
34" [864]
30 3/4" [781]
30" [762]
18" [457]
22 15/16" [583]

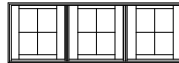

CTISWR7626

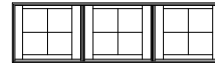

CTISWR9026

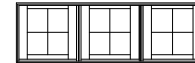

CTISWT7626

M.O. BRICKMOULD
M.O. ADAMS/FLAT CASING
ROUGH OPENING
FRAME SIZE
DAYLIGHT OPENING

103 1/16" [2618]
106 1/8" [2696]
100 9/16" [2554]
99 13/16" [2535]
22 5/8" [575] (3)

115 1/16" [2923]
118 1/8" [3000]
112 9/16" [2859]
111 13/16" [2840]
26 5/8" [676] (3)

20 1/2" [521]
22" [559]
18 3/4" [476]
30" [762]
18" [457]
10 15/16" [278]



CTISWT8016



CTISWT9016

32 1/2" [826]
34" [864]
30 3/4" [781]
30" [762]
18" [457]
22 15/16" [583]

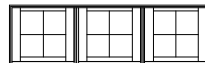

CTISWT8026



CTISWT9026

M.O. BRICKMOULD
M.O. ADAMS/FLAT CASING
ROUGH OPENING
FRAME SIZE
DAYLIGHT OPENING

67 5/16" [1710]
70 3/8" [1788]
64 13/16" [1646]
64 1/16" [1627]
26 5/8" [676] - 7 1/2" [190] (2)

71 1/16" [1811]
74 3/8" [1889]
68 13/16" [1748]
68 1/16" [1729]
26 5/8" [676] - 9 1/2" [241] (2)

75 1/16" [1913]
78 3/8" [1991]
72 13/16" [1849]
72 1/16" [1830]
26 5/8" [676] - 11 1/2" [292] (2)

20 1/2" [521]
22" [559]
18 3/4" [476]
30" [762]
18" [457]
10 15/16" [278]



CTISWT3016F10



CTISWT3016F12



CTISWT3016F12

32 1/2" [826]
34" [864]
30 3/4" [781]
30" [762]
18" [457]
22 15/16" [583]



CTISWT3026F10



CTISWT3026F12

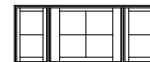

CTISWT3026F12

M.O. BRICKMOULD
M.O. ADAMS/FLAT CASING
ROUGH OPENING
FRAME SIZE
DAYLIGHT OPENING

73 5/16" [1862]
76 3/8" [1940]
70 13/16" [1799]
70 1/16" [1780]
32 5/8" [829] - 7 1/2" [190] (2)

77 5/16" [1964]
80 3/8" [2042]
74 13/16" [1900]
74 1/16" [1881]
32 5/8" [829] - 9 1/2" [241] (2)

81 5/16" [2065]
84 3/8" [2143]
78 13/16" [2002]
78 1/16" [1983]
32 5/8" [829] - 11 1/2" [292] (2)

20 1/2" [521]
22" [559]
18 3/4" [476]
30" [762]
18" [457]
10 15/16" [278]



CTISWT3616F10



CTISWT3616F10



CTISWT3616F10

32 1/2" [826]
34" [864]
30 3/4" [781]
30" [762]
18" [457]
22 15/16" [583]

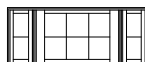

CTISWT3626F10

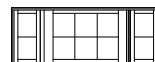

CTISWT3626F10



CTISWT3626F10

ELEVATION SYMBOL LEGEND:

M.O. = MASONRY OPENING
VALUES IN [] ARE IN MILLIMETER CONVERSIONS.
VALUES IN () ARE NUMBER OF DAYLIGHT OPENINGS PER UNIT.

Note: Elevations shown DO NOT have exterior trim. Subtract 1/2" (12.7) from M.O. (Masonry Opening) for Unit Sizes. Masonry Openings above include Sill Nose, see Transom Rail & Sill Options page for Sill Nose specifications. For other Trim Options refer to the Unit Sizing, Rough Opening & Masonry Openings page.

SCALE: 1/8" = 1'

4-SASH FRENCH TRANSOMS

M.O. BRICKMOULD
M.O. ADAMS/FLAT CASING
ROUGH OPENING
FRAME SIZE
DAYLIGHT OPENING

96 1/4" [2445]
99 5/16" [2523]
93 3/4" [2381]
93" [2362]
12 5/8" [321] (4)

120 1/4" [3054]
123 5/16" [3132]
117 3/4" [2991]
117" [2972]
18 5/8" [473] (4)

144 1/4" [3664]
147 5/16" [3742]
141 3/4" [3600]
141" [3581]
24 5/8" [625] (4)

20 1/2" [521]
22" [559]
18 3/4" [476]
18" [457]
10 15/16" [278]

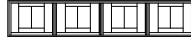

CTIFRR8016

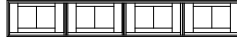

CTIFRR10016



CTIFRR12016

32 1/2" [826]
34" [864]
30 3/4" [781]
30" [762]
22 15/16" [583]

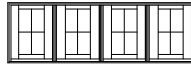

CTIFRR8026

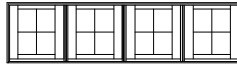

CTIFRR10026

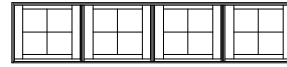

CTIFRR12026

M.O. BRICKMOULD
M.O. ADAMS/FLAT CASING
ROUGH OPENING
FRAME SIZE
DAYLIGHT OPENING

104 1/4" [2648]
107 5/16" [2726]
101 3/4" [2584]
101" [2565]
14 5/8" [371] (4)

128 1/4" [3258]
131 5/16" [3335]
125 3/4" [3194]
125" [3175]
20 5/8" [524] (4)

152 1/4" [3867]
155 5/16" [3945]
149 3/4" [3804]
149" [3785]
26 5/8" [676] (4)

20 1/2" [521]
22" [559]
18 3/4" [476]
18" [457]
10 15/16" [278]

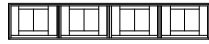

CTIFRT8016

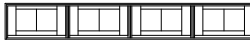

CTIFRT10016

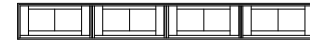

CTIFRT12016

32 1/2" [826]
34" [864]
30 3/4" [781]
30" [762]
22 15/16" [583]



CTIFRT8026



CTIFRT10026



CTIFRT12026

ELEVATION SYMBOL LEGEND:

























M.O. = MASONRY OPENING
VALUES IN [] ARE IN MILLIMETER CONVERSIONS.
VALUES IN () ARE NUMBER OF DAYLIGHT OPENINGS PER UNIT.

Note: Elevations shown DO NOT have exterior trim. Subtract 1/2" (12.7) from M.O. (Masonry Opening) for Unit Sizes. Masonry Openings above include Sill Nose, see Transom Rail & Sill Options page for Sill Nose specifications. For other Trim Options refer to the Unit Sizing, Rough Opening & Masonry Openings page.

Continued on next page

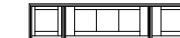
SCALE: 1/8" = 1'

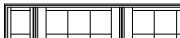
FRENCH TRANSOMS WITH TWO SIDELITES

| | | | |
|---|--|--|--|
| M.O. BRICKMOULD M.O. ADAMS/FLAT CASING ROUGH OPENING FRAME SIZE DAYLIGHT OPENING | 92 1/2" [2350] 95 9/16" [2427] 90" [2286] 89 1/4" [2267] | 96 1/2" [2451] 99 9/16" [2529] 94" [2388] 93 1/4" [2369] | 100 1/2" [2553] 103 9/16" [2630] 98" [2489] 97 1/4" [2470] |
| | 20 5/8" [524] (2) - 7 1/2" [190] (2) | 20 5/8" [524] (2) - 9 1/2" [241] (2) | 20 5/8" [524] (2) - 11 1/2" [292] (2) |
| 20 1/2" [521] 22" [559] 18 3/4" [476] 18" [457] 10 15/16" [278] |  CTIFRT5016Q10 |  CTIFRT5016Q12 |  CTIFRT5016Q14 |
| 32 1/2" [826] 34" [864] 30 3/4" [781] 30" [762] 22 15/16" [583] |  CTIFRT5026Q10 |  CTIFRT5026Q12 |  CTIFRT5026Q14 |
| M.O. BRICKMOULD M.O. ADAMS/FLAT CASING ROUGH OPENING FRAME SIZE DAYLIGHT OPENING | 96 1/2" [2451] 99 9/16" [2529] 94" [2388] 93 1/4" [2369] | 100 1/2" [2553] 103 9/16" [2630] 98" [2489] 97 1/4" [2470] | 104 1/2" [2654] 107 9/16" [2732] 102" [2591] 101 1/4" [2572] |
| | 22 5/8" [575] (2) - 7 1/2" [190] (2) | 22 5/8" [575] (2) - 9 1/2" [241] (2) | 22 5/8" [575] (2) - 11 1/2" [292] (2) |
| 20 1/2" [521] 22" [559] 18 3/4" [476] 18" [457] 10 15/16" [278] |  CTIFRT5416Q10 |  CTIFRT5416Q12 |  CTIFRT5416Q12 |
| 32 1/2" [826] 34" [864] 30 3/4" [781] 30" [762] 22 15/16" [583] |  CTIFRT5426Q10 |  CTIFRT5426Q12 |  CTIFRT5426Q12 |
| M.O. BRICKMOULD M.O. ADAMS/FLAT CASING ROUGH OPENING FRAME SIZE DAYLIGHT OPENING | 104 1/2" [2654] 107 9/16" [2732] 102" [2591] 101 1/4" [2572] | 108 1/2" [2756] 111 9/16" [2834] 106" [2692] 105 1/4" [2673] | 112 1/2" [2858] 115 9/16" [2935] 110" [2794] 109 1/4" [2775] |
| | 26 5/8" [676] (2) - 7 1/2" [190] (2) | 26 5/8" [676] (2) - 9 1/2" [241] (2) | 26 5/8" [676] (2) - 11 1/2" [292] (2) |
| 20 1/2" [521] 22" [559] 18 3/4" [476] 18" [457] 10 15/16" [278] |  CTIFRT6016Q10 |  CTIFRT6016Q12 |  CTIFRT6016Q14 |
| 32 1/2" [826] 34" [864] 30 3/4" [781] 30" [762] 22 15/16" [583] |  CTIFRT6026Q10 |  CTIFRT6026Q12 |  CTIFRT6026Q14 |
| M.O. BRICKMOULD M.O. ADAMS/FLAT CASING ROUGH OPENING FRAME SIZE DAYLIGHT OPENING | 116 1/2" [2959] 119 9/16" [3037] 114" [2896] 113 1/4" [2877] | 120 1/2" [3061] 123 9/16" [3138] 118" [2997] 117 1/4" [2978] | 124 1/2" [3162] 127 9/16" [3240] 122" [3099] 121 1/4" [3080] |
| | 32 5/8" [829] (2) - 7 1/2" [190] (2) | 32 5/8" [829] (2) - 9 1/2" [241] (2) | 32 5/8" [829] (2) - 11 1/2" [292] (2) |
| 20 1/2" [521] 22" [559] 18 3/4" [476] 18" [457] 10 15/16" [278] |  CTIFRT7016Q10 |  CTIFRT7016Q12 |  CTIFRT7016Q14 |
| 32 1/2" [826] 34" [864] 30 3/4" [781] 30" [762] 22 15/16" [583] |  CTIFRT7026Q10 |  CTIFRT7026Q12 |  CTIFRT7026Q14 |

ELEVATION SYMBOL LEGEND:
M.O. = MASONRY OPENING
 VALUES IN [] ARE IN MILLIMETER CONVERSIONS.
 VALUES IN () ARE NUMBER OF DAYLIGHT OPENINGS PER UNIT.

Note: Elevations shown DO NOT have exterior trim. Subtract 1/2" (12.7) from M.O. (Masonry Opening) for Unit Sizes. Masonry Openings above include Sill Nose, see Transom Rail & Sill Options page for Sill Nose specifications. For other Trim Options refer to the Unit Sizing, Rough Opening & Masonry Openings page.

SCALE: 1/8" = 1'

1-PANEL SECTOR TOP DOORS

M.O. BRICKMOULD
M.O. ADAMS/FLAT CASING
ROUGH OPENING
FRAME SIZE
DAYLIGHT OPENING

28 11/16" [729]
31 3/4" [806]
26 3/16" [665]
25 7/16" [646]
14 5/8" [371]

34 11/16" [881]
37 3/4" [959]
32 3/16" [817]
31 7/16" [799]
20 5/8" [524]

36 11/16" [932]
39 3/4" [1010]
34 3/16" [868]
33 7/16" [849]
22 5/8" [575]

40 11/16" [1033]
43 3/4" [1111]
38 3/16" [970]
37 7/16" [951]
26 5/8" [676]

46 11/16" [1186]
49 3/4" [1264]
44 3/16" [1122]
43 7/16" [1103]
32 5/8" [829]

84 3/8" [2143]
85 7/8" [2181]
83 1/4" [2115]
82 1/2" [2096]
68 1 1/16" [1745]

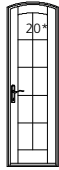

CISWTS2068

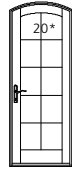

CISWTS2668

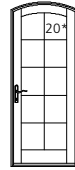

CISWTS2868

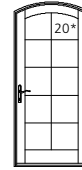

CISWTS3068

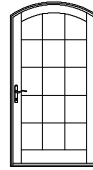

CISWTS3668

88 3/8" [2245]
89 7/8" [2283]
87 1/4" [2216]
86 1/2" [2197]
72 1 1/16" [1846]



CISWTS2070

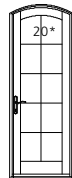

CISWTS2670

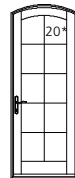

CISWTS2870

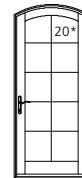

CISWTS3070

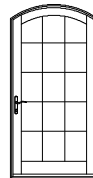

CISWTS3670

100 3/8" [2550]
101 7/8" [2588]
99 1/4" [2521]
98 1/2" [2502]
84 1 1/16" [2151]

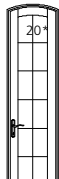

CISWTS2080

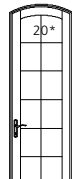

CISWTS2680

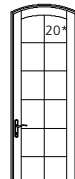

CISWTS2880

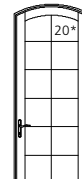

CISWTS3080

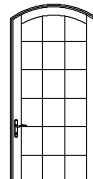

CISWTS3680

112 3/8" [2854]
113 7/8" [2892]
111 1/4" [2825]
110 1/2" [2807]
96 1 1/16" [2456]

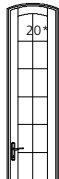

CISWTS2090

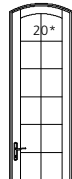

CISWTS2690

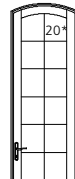

CISWTS2890

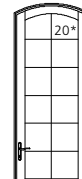

CISWTS3090

ELEVATION SYMBOL LEGEND:

M.O. = MASONRY OPENING
VALUES IN [] ARE IN MILLIMETER CONVERSIONS.
VALUES IN () ARE NUMBER OF DAYLIGHT OPENINGS PER UNIT.
##* NUMBER INDICATES DESIGN PRESSURE (DP) RATING WITH STANDARD GLAZING. OPERATING UNITS UTILIZE MULTI-POINT LOCKING HARDWARE FOR DP RATINGS.

Note: Elevations shown DO NOT have exterior trim. Subtract 1/2" (12.7) from M.O. (Masonry Opening) for Unit Size. For other Trim Options refer to the Unit Sizing, Rough Opening & Masonry Openings page.

SCALE: 1/8" = 1'

3-PANEL SECTOR TOP DOORS

M.O. BRICKMOLD
M.O. ADAMS/FLAT CASING
ROUGH OPENING
FRAME SIZE
DAYLIGHT OPENING

97 1/16" [2465]
100 1/8" [2543]
94 9/16" [2402]
93 13/16" [2383]
20 5/8" [524] (3)

103 1/16" [2618]
106 1/8" [2696]
100 9/16" [2554]
99 13/16" [2535]
22 5/8" [575] (3)

115 1/16" [2923]
118 1/8" [3000]
112 9/16" [2859]
111 13/16" [2840]
26 5/8" [676] (3)

84 3/8" [2143]
85 7/8" [2181]
83 1/4" [2114]
82 1/2" [2096]
68 11/16" [1745]

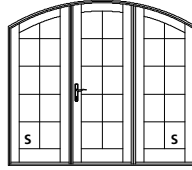

CISWTS7668

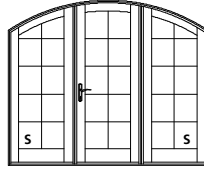

CISWTS8068

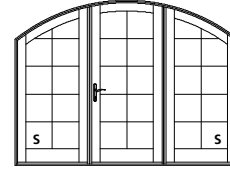

CISWTS9068

88 3/8" [2245]
89 7/8" [2283]
87 1/4" [2216]
86 1/2" [2197]
72 11/16" [1846]

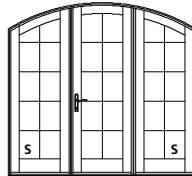

CISWTS7670

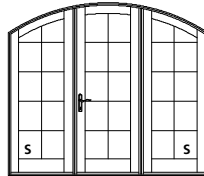

CISWTS8070

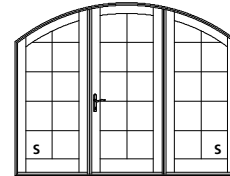

CISWTS9070

100 3/8" [2550]
101 7/8" [2588]
99 1/4" [2521]
96 1/2" [2502]
84 11/16" [2151]

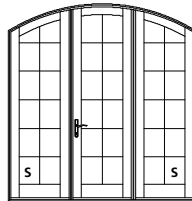

CISWTS7680

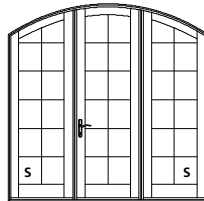

CISWTS8080

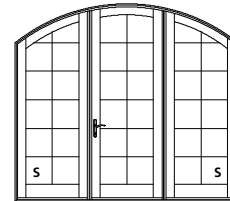

CISWTS9080

112 3/8" [2854]
113 7/8" [2892]
111 1/4" [2825]
110 1/2" [2807]
96 11/16" [2456]

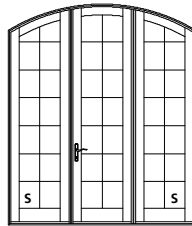

CISWTS7690

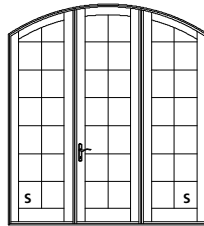

CISWTS8090

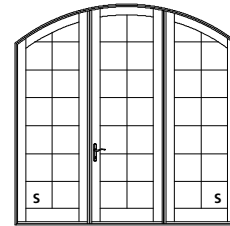

CISWTS9090

ELEVATION SYMBOL LEGEND:

M.O. = MASONRY OPENING
VALUES IN [] ARE IN MILLIMETER CONVERSIONS.
VALUES IN () ARE NUMBER OF DAYLIGHT OPENINGS PER UNIT.
S PANEL IS AVAILABLE AS STATIONARY ONLY.

Note: Elevations shown DO NOT have exterior trim. Subtract 1/2" (12.7) from M.O. (Masonry Opening) for Unit Size. For other Trim Options refer to the Unit Sizing, Rough Opening & Masonry Openings page.

SCALE: 1/8" = 1'

2-PANEL FRENCH SECTOR TOP DOORS

M.O. BRICKMOULD
M.O. ADAMS/FLAT CASING
ROUGH OPENING
FRAME SIZE
DAYLIGHT OPENING

53 7/8" [1368]
56 15/16" [1446]
51 3/8" [1305]
50 5/8" [1286]
14 5/8" [371] (2)

65 7/8" [1673]
68 15/16" [1751]
63 3/8" [1610]
62 5/8" [1591]
20 5/8" [524] (2)

69 7/8" [1775]
72 15/16" [1853]
67 3/8" [1711]
66 5/8" [1692]
22 5/8" [575] (2)

77 7/8" [1978]
80 15/16" [2056]
75 3/8" [1914]
74 5/8" [1895]
26 5/8" [676] (2)

89 7/8" [2283]
92 15/16" [2361]
87 3/8" [2219]
86 5/8" [2200]
32 5/8" [829] (2)

84 3/8" [2143]
85 7/8" [2181]
83 1/4" [2114]
82 1/2" [2096]
68 11/16" [1745]

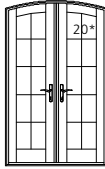

CIFRTS4068

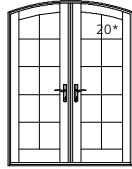

CIFRTS5068

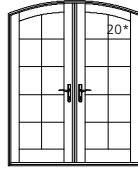

CIFRTS5468

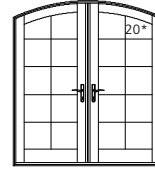

CIFRTS6068

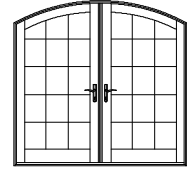

CIFRTS7068

88 3/8" [2245]
89 7/8" [2283]
87 1/4" [2216]
86 1/2" [2197]
72 11/16" [1846]

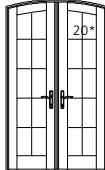

CIFRTS4070

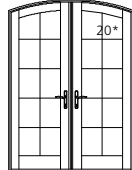

CIFRTS5070

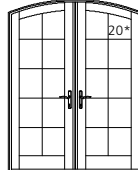

CIFRTS5470

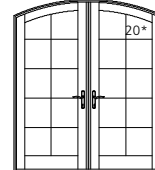

CIFRTS6070

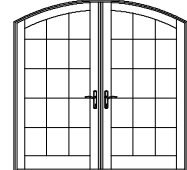

CIFRTS7070

100 3/8" [2550]
101 7/8" [2588]
99 1/4" [2521]
98 1/2" [2502]
84 11/16" [2151]

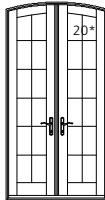

CIFRTS4080

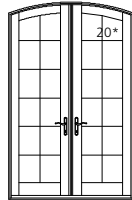

CIFRTS5080

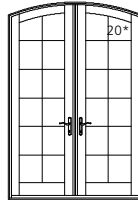

CIFRTS5480

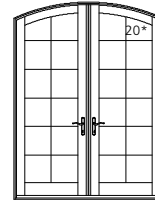

CIFRTS6080

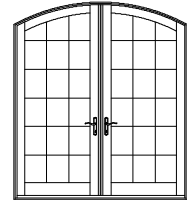

CIFRTS7080

100 3/8" [2550]
101 7/8" [2588]
99 1/4" [2521]
98 1/2" [2502]
84 11/16" [2151]

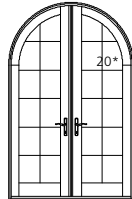

CIFRTH5080

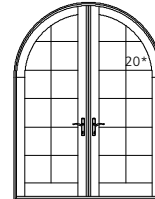

CIFRTH6080

112 3/8" [2854]
113 7/8" [2892]
111 1/4" [2825]
110 1/2" [2807]
96 11/16" [2456]

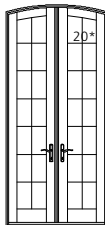

CIFRTS4090

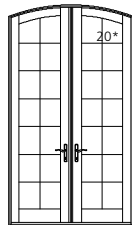

CIFRTS5090

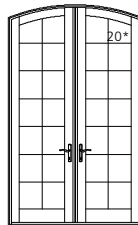

CIFRTS5490

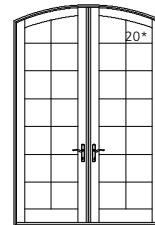

CIFRTS6090

112 3/8" [2854]
113 7/8" [2892]
111 1/4" [2825]
110 1/2" [2807]
96 11/16" [2456]

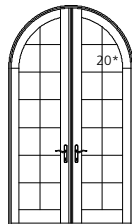

CIFRTH5090

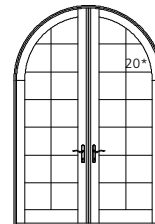

CIFRTH6090

ELEVATION SYMBOL LEGEND:

M.O. = MASONRY OPENING
VALUES IN [] ARE IN MILLIMETER CONVERSIONS.
VALUES IN () ARE NUMBER OF DAYLIGHT OPENINGS PER UNIT.
NUMBER INDICATES DESIGN PRESSURE (DP) RATING
WITH STANDARD GLAZING. OPERATING UNITS UTILIZE
MULTI-POINT LOCKING HARDWARE FOR DP RATINGS.

Note: Elevations shown DO NOT have exterior trim. Subtract 1/2" (12.7) from M.O. (Masonry Opening) for Unit Size. For other Trim Options refer to the Unit Sizing, Rough Opening & Masonry Openings page.

SCALE: 1/8" = 1'

4-PANEL FRENCH SECTOR TOP DOORS

M.O. BRICKMOUND
M.O. ADAMS/FLAT CASING
ROUGH OPENING
FRAME SIZE
DAYLIGHT OPENING

96 1/4" [2445]
99 5/16" [2523]
101 3/4" [2584]
101" [2564]
12 5/8" [321] (4)

120 1/4" [3054]
123 5/16" [3132]
125 3/4" [3194]
125" [3175]
18 5/8" [473] (4)

84 3/8" [2143]
85 7/8" [2181]
83 1/4" [2115]
82 1/2" [2096]
68 11/16" [1745]

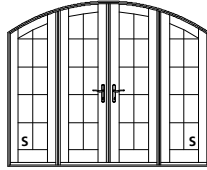

CIFRTS8068

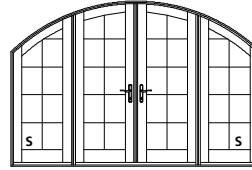

CIFRTS10068

88 3/8" [2245]
89 7/8" [2283]
87 1/4" [2216]
86 1/2" [2197]
72 11/16" [1846]

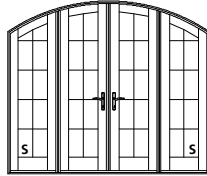

CIFRTS8070

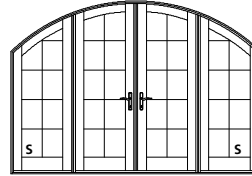

CIFRTS10070

100 3/8" [2550]
101 7/8" [2588]
99 1/4" [2521]
98 1/2" [2502]
84 11/16" [2151]

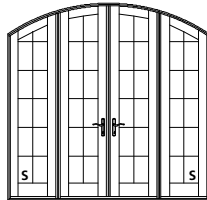

CIFRTS8080

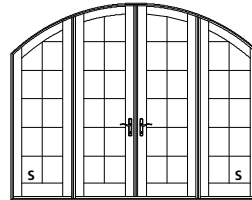

CIFRTS10080

112 3/8" [2854]
113 7/8" [2892]
111 1/4" [2826]
110 1/2" [2807]
96 11/16" [2456]

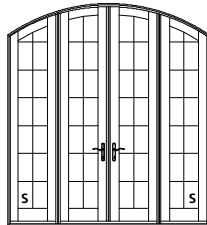

CIFRTS8090

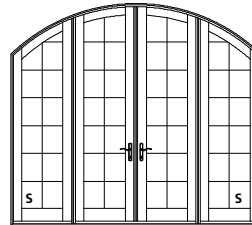

CIFRTS10090

ELEVATION SYMBOL LEGEND:

M.O. = MASONRY OPENING
VALUES IN [] ARE IN MILLIMETER CONVERSIONS.
VALUES IN () ARE NUMBER OF DAYLIGHT OPENINGS PER UNIT.
S = PANEL IS AVAILABLE AS STATIONARY ONLY.

Note: Elevations shown DO NOT have exterior trim. Subtract 1/2" (12.7) from M.O. (Masonry Opening) for Unit Size. For other Trim Options refer to the Unit Sizing, Rough Opening & Masonry Openings page.

SCALE: 1/8" = 1'

FRENCH SECTOR TOP DOOR WITH TWO SIDELITES
5-0 UNITS

M.O. BRICKMOUND
M.O. ADAMS/FLAT CASING
ROUGH OPENING
FRAME SIZE
DAYLIGHT OPENING

92 1/2" [2350]
95 9/16" [2427]
90" [2286]
89 1/4" [2267]
20 5/8" [524] (2) - 7 1/2" [190] (2)

96 1/2" [2451]
99 9/16" [2529]
94" [2387]
93 1/4" [2369]
20 5/8" [524] (2) - 9 1/2" [241] (2)

100 1/2" [2553]
103 9/16" [2630]
98" [2489]
97 1/4" [2470]
20 5/8" [524] (2) - 11 1/2" [292] (2)

84 3/8" [2143]
85 7/8" [2181]
83 1/4" [2114]
82 1/2" [2096]
68 11/16" [1745]

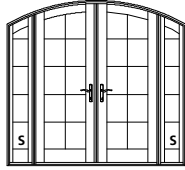

CIFRTS5068Q10

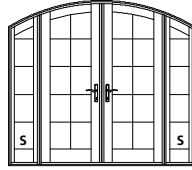

CIFRTS5068Q12

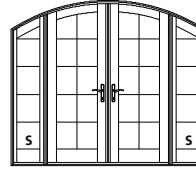

CIFRTS5068Q14

88 3/8" [2245]
89 7/8" [2283]
87 1/4" [2216]
86 1/2" [2197]
72 11/16" [1846]

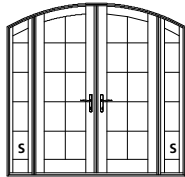

CIFRTS5070Q10

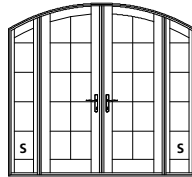

CIFRTS5070Q12

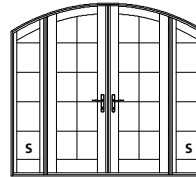

CIFRTS5070Q14

100 3/8" [2550]
101 7/8" [2588]
99 1/4" [2521]
98 1/2" [2502]
84 11/16" [2151]

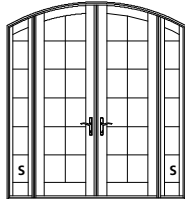

CIFRTS5080Q10

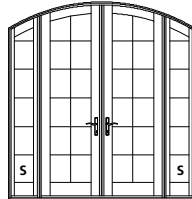

CIFRTS5080Q12

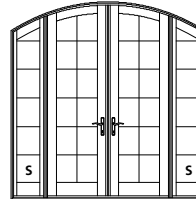

CIFRTS5080Q14

112 3/8" [2854]
113 7/8" [2892]
111 1/4" [2825]
110 1/2" [2807]
96 11/16" [2456]

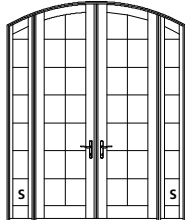

CIFRTS5090Q10

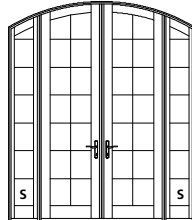

CIFRTS5090Q12

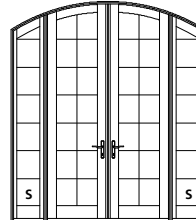

CIFRTS5090Q14

ELEVATION SYMBOL LEGEND:

M.O. = MASONRY OPENING
VALUES IN () ARE IN MILLIMETER CONVERSIONS.
VALUES IN () ARE NUMBER OF DAYLIGHT OPENINGS PER UNIT.
S PANEL IS AVAILABLE AS STATIONARY ONLY.

Note: Elevations shown DO NOT have exterior trim. Subtract 1/2" (12.7) from M.O. (Masonry Opening) for Unit Size. For other Trim Options refer to the Unit Sizing, Rough Opening & Masonry Openings page.

SCALE: 1/8" = 1'

FRENCH SECTOR TOP DOOR WITH TWO SIDELITES
5-4 UNITS

| | | | |
|-------------------------------|--------------------------------------|--------------------------------------|---------------------------------------|
| M.O. BRICKMOULD | 96 1/2" [2451] | 100 1/2" [2553] | 104 1/2" [2654] |
| M.O. ADAMS/FLAT CASING | 99 9/16" [2529] | 103 9/16" [2630] | 107 9/16" [2732] |
| ROUGH OPENING | 94" [2387] | 98" [2493] | 102" [2590] |
| FRAME SIZE | 93 1/4" [2369] | 97 1/4" [2470] | 101 1/4" [2572] |
| DAYLIGHT OPENING | 22 5/8" [575] (2) - 7 1/2" [190] (2) | 22 5/8" [575] (2) - 9 1/2" [241] (2) | 22 5/8" [575] (2) - 11 1/2" [292] (2) |

84 3/8" [2143]
85 7/8" [2181]
83 1/4" [2114]
82 1/2" [2096]
68 1 1/16" [1745]

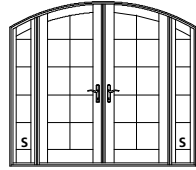

CIFRTS5468Q10

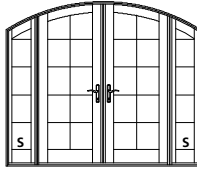

CIFRTS5468Q12

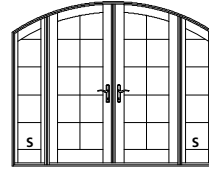

CIFRTS5468Q14

88 3/8" [2245]
89 7/8" [2283]
87 1/4" [2216]
86 1/2" [2197]
72 11/16" [1846]

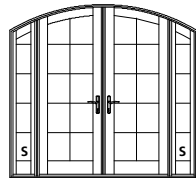

CIFRTS5470Q10

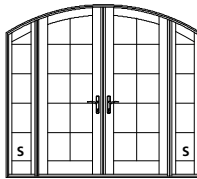

CIFRTS5470Q12

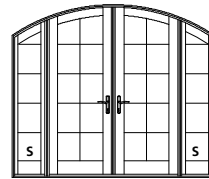

CIFRTS5470Q14

100 3/8" [2550]
101 7/8" [2588]
99 1/4" [2521]
98 1/2" [2502]
84 11/16" [2151]

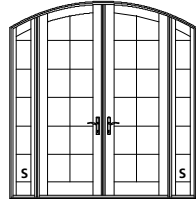

CIFRTS5480Q10

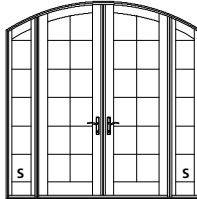

CIFRTS5480Q12

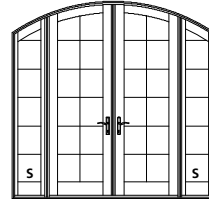

CIFRTS5480Q14

112 3/8" [2854]
113 7/8" [2892]
111 1/4" [2825]
110 1/2" [2807]
96 11/16" [2456]

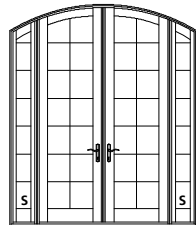

CIFRTS5490Q10

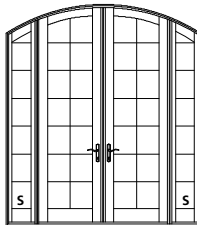

CIFRTS5490Q12

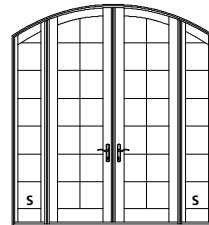

CIFRTS5490Q14

ELEVATION SYMBOL LEGEND:

M.O. = MASONRY OPENING
VALUES IN [] ARE IN MILLIMETER CONVERSIONS.
VALUES IN () ARE NUMBER OF DAYLIGHT OPENINGS PER UNIT.
S PANEL IS AVAILABLE AS STATIONARY ONLY.

Note: Elevations shown DO NOT have exterior trim. Subtract 1/2" (12.7) from M.O. (Masonry Opening) for Unit Size. For other Trim Options refer to the Unit Sizing, Rough Opening & Masonry Openings page.

SCALE: 1/8" = 1'

FRENCH SECTOR TOP DOOR WITH TWO SIDELITES
6-0 UNITS

M.O. BRICKMOULD
M.O. ADAMS/FLAT CASING
ROUGH OPENING
FRAME SIZE
DAYLIGHT OPENING

104 1/2" [2654]
107 9/16" [2732]
102" [2590]
101 1/4" [2572]
26 5/8" [676] (2) - 7 1/2" [190] (2)

108 1/2" [2756]
111 9/16" [2834]
106" [2692]
105 1/4" [2673]
26 5/8" [676] (2) - 9 1/2" [241] (2)

112 1/2" [2858]
115 9/16" [2935]
110" [2794]
109 1/4" [2775]
26 5/8" [676] (2) - 11 1/2" [292] (2)

84 3/8" [2143]
85 7/8" [2181]
83 1/4" [2114]
82 1/2" [2096]
68 11/16" [1745]

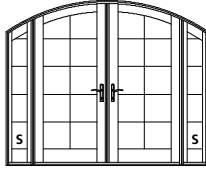

CIFRTS6068Q10

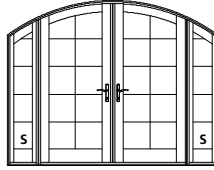

CIFRTS6068Q12

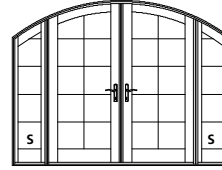

CIFRTS6068Q14

88 3/8" [2245]
89 7/8" [2283]
87 1/4" [2216]
86 1/2" [2197]
72 11/16" [1873]

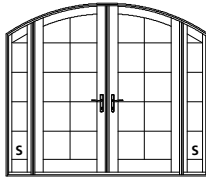

CIFRTS6070Q10

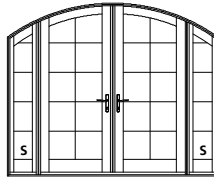

CIFRTS6070Q12

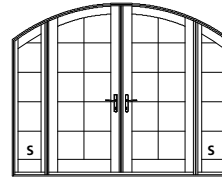

CIFRTS6070Q14

100 3/8" [2550]
101 7/8" [2588]
99 1/4" [2521]
98 1/2" [2502]
84 11/16" [2151]

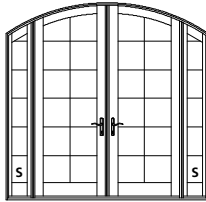

CIFRTS6080Q10

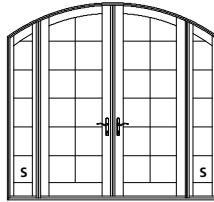

CIFRTS6080Q12

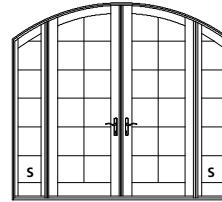

CIFRTS6080Q14

112 3/8" [2854]
113 7/8" [2892]
111 1/4" [2825]
110 1/2" [2807]
96 11/16" [2456]

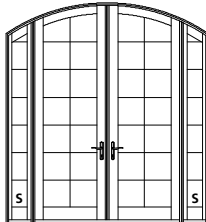

CIFRTS6090Q10

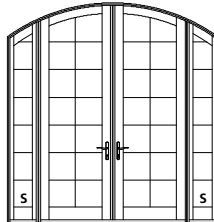

CIFRTS6090Q12

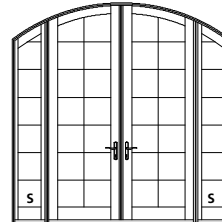

CIFRTS6090Q14

ELEVATION SYMBOL LEGEND:

M.O. = MASONRY OPENING
VALUES IN [] ARE IN MILLIMETER CONVERSIONS.
VALUES IN () ARE NUMBER OF DAYLIGHT OPENINGS PER UNIT.
S PANEL IS AVAILABLE AS STATIONARY ONLY.

Note: Elevations shown DO NOT have exterior trim. Subtract 1/2" (12.7) from M.O. (Masonry Opening) for Unit Size. For other Trim Options refer to the Unit Sizing, Rough Opening & Masonry Openings page.

SCALE: 1/8" = 1'

FRENCH SECTOR TOP DOOR WITH TWO SIDELITES
7-0 UNITS

M.O. BRICKMOULD
M.O. ADAMS/FLAT CASING
ROUGH OPENING
FRAME SIZE
DAYLIGHT OPENING

116 1/2" [2959]
119 9/16" [3037]
114" [2895]
113 1/4" [2877]
32 5/8" [829] (2) - 7 1/2" [190] (2)

120 1/2" [3061]
123 9/16" [3138]
118" [2997]
117 1/4" [2978]
32 5/8" [829] (2) - 9 1/2" [241] (2)

124 1/2" [3162]
127 9/16" [3240]
122" [3098]
121 1/4" [3080]
32 5/8" [829] (2) - 11 1/2" [292] (2)

84 3/8" [2143]
85 7/8" [2181]
83 1/4" [2114]
82 1/2" [2096]
68 11/16" [1745]

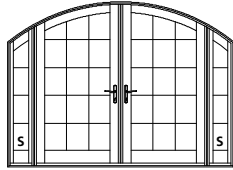

CIFRTS7068Q10

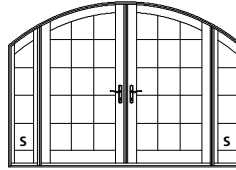

CIFRTS7068Q12

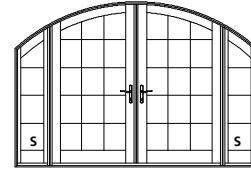

CIFRTS7068Q14

88 3/8" [2245]
89 7/8" [2283]
87 1/4" [2216]
86 1/2" [2197]
72 11/16" [1846]

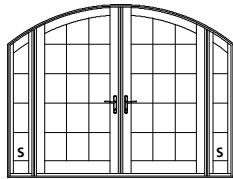

CIFRTS7070Q10

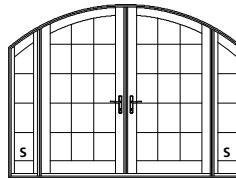

CIFRTS7070Q12

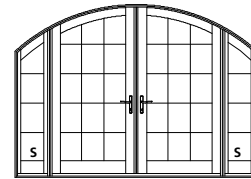

CIFRTS7070Q14

100 3/8" [2550]
101 7/8" [2588]
99 1/4" [2521]
98 1/2" [2502]
84 11/16" [2151]

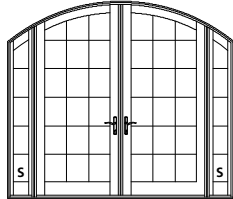

CIFRTS7080Q10

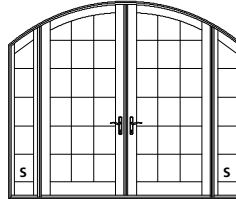

CIFRTS7080Q12

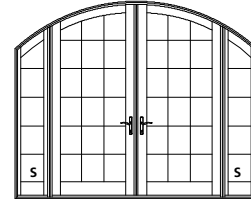















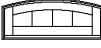

CIFRTS7080Q14

ELEVATION SYMBOL LEGEND:

M.O. = MASONRY OPENING
VALUES IN [] ARE IN MILLIMETER CONVERSIONS.
VALUES IN () ARE NUMBER OF DAYLIGHT OPENINGS PER UNIT.
S PANEL IS AVAILABLE AS STATIONARY ONLY.

Note: Elevations shown DO NOT have exterior trim. Subtract 1/2" (12.7) from M.O. (Masonry Opening) for Unit Size. For other Trim Options refer to the Unit Sizing, Rough Opening & Masonry Openings page.

SECTOR TOP TRANSOM UNITS

| | | | | |
|---|--|--|--|--|
| M.O. BRICKMOULD M.O. ADAMS/FLAT CASING ROUGH OPENING FRAME SIZE DAYLIGHT OPENING | 28 11/16" [729] | 34 11/16" [881] | 36 11/16" [932] | 40 11/16" [1033] |
| | 31 3/4" [806] | 37 3/4" [959] | 39 3/4" [1010] | 43 3/4" [1111] |
| | 26 3/16" [665] | 32 3/16" [818] | 34 3/16" [868] | 38 3/16" [970] |
| | 25 7/16" [646] | 31 7/16" [799] | 33 7/16" [849] | 37 7/16" [951] |
| | 14 5/8" [371] | 20 5/8" [524] | 22 5/8" [575] | 26 5/8" [676] |
| |  |  |  |  |
| 22 1/2" [572] 24" [607] 20 3/4" [527] 20" [508] 12 15/16" [329] | CTISWTS2018 | CTISWTS2618 | CTISWTS2818 | CTISWTS3018 |
| |  |  |  |  |
| 32 1/2" [826] 34" [864] 30 3/4" [781] 30" [762] 22 15/16" [583] | CTISWTS2026 | CTISWTS2626 | CTISWTS2826 | CTISWTS3026 |
| M.O. BRICKMOULD M.O. ADAMS/FLAT CASING ROUGH OPENING FRAME SIZE DAYLIGHT OPENING | 53 7/8" [1368] | 65 7/8" [1673] | 69 7/8" [1775] | 77 7/8" [1978] |
| | 56 15/16 [1446] | 68 15/16" [1751] | 72 15/16" [1853] | 80 15/16" [2056] |
| | 51 3/8" [1304] | 63 3/8" [1610] | 67 3/8" [1711] | 75 3/8" [1914] |
| | 50 5/8 [1286] | 62 5/8" [1591] | 66 5/8" [1692] | 74 5/8" [1895] |
| | 39 13/16" [1011] | 51 13/16" [1316] | 55 13/16" [1418] | 63 13/16" [1621] |
| |  |  |  |  |
| 22 1/2" [572] 24" [607] 20 3/4" [527] 20" [508] 12 15/16" [329] | CTIFRTS4018 | CTIFRTS5018 | CTIFRTS5418 | CTIFRTS6018 |
| |  |  |  |  |
| 32 1/2" [826] 34" [864] 30 3/4" [781] 30" [762] 22 15/16" [583] | CTIFRTS4026 | CTIFRTS5026 | CTIFRTS5426 | CTIFRTS6026 |

ELEVATION SYMBOL LEGEND:
M.O. = MASONRY OPENING
 VALUES IN [] ARE IN MILLIMETER CONVERSIONS.

Note: Vertical Masonry Opening sizes are shown for units with 4-9/16" jamb. For transom units with 6-9/16" jamb subtract 1/8" from the finished dimensions.

Note: Elevations shown DO NOT have exterior trim. Subtract 1/2" (12.7) from M.O. (Masonry Opening) for Unit Sizes. Masonry Openings above include Sill Nose, see Transom Rail & Sill Options page for Sill Nose specifications. For other Trim Options refer to the Unit Sizing, Rough Opening & Masonry Openings page.

SCALE: 1/8" = 1'

GLAZING OPTIONS

INTERIOR GLAZED
INSULATED 3/4" [19] GLASS

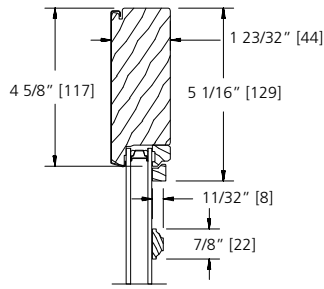

7/8" GRILLE BAR

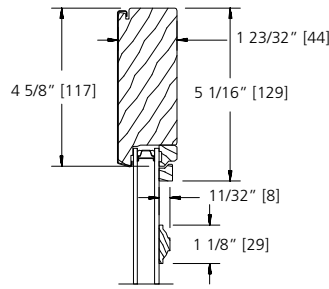

1 1/8" GRILLE BAR

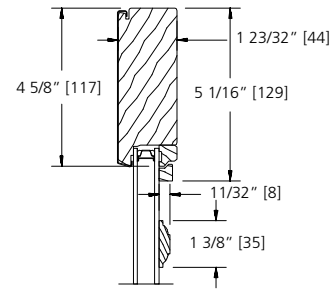

1 3/8" GRILLE BAR

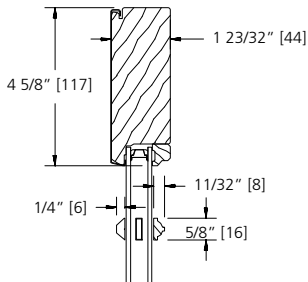

**5/8" SDL BAR
(PUTTY/BEAD)**

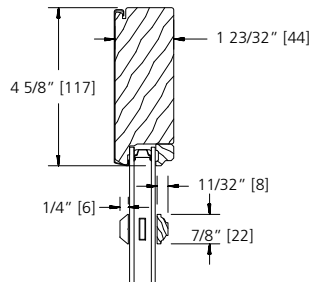

**7/8" SDL BAR
(PUTTY/BEAD)**

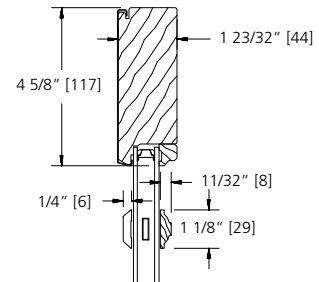

**1 1/8" SDL BAR
(PUTTY/BEAD)**

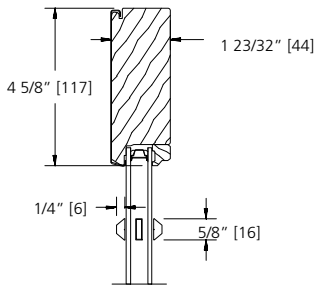

**5/8" SDL BAR
(PUTTY/PUTTY)**

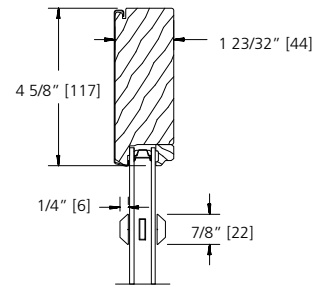

**7/8" SDL BAR
(PUTTY/PUTTY)**

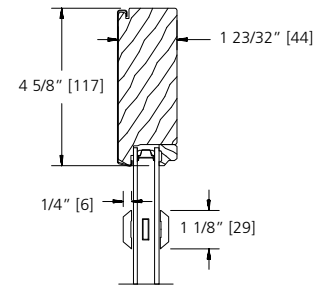

**1 1/8" SDL BAR
(PUTTY/PUTTY)**

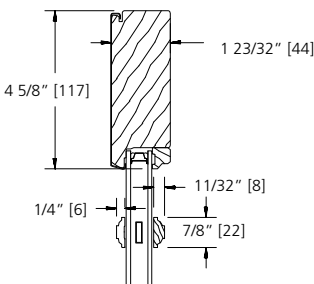

**7/8" SDL BAR
(BEAD STOP)**

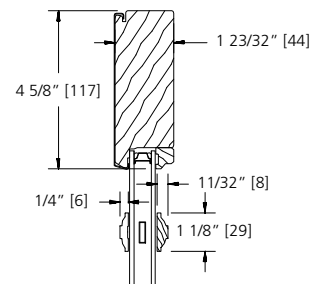

**1 1/8" SDL BAR
(BEAD STOP)**

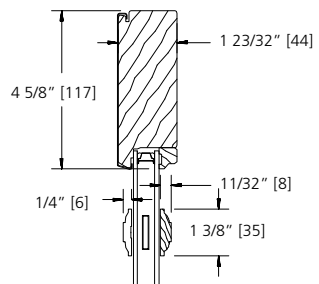

**1 3/8" SDL BAR
(BEAD STOP)**

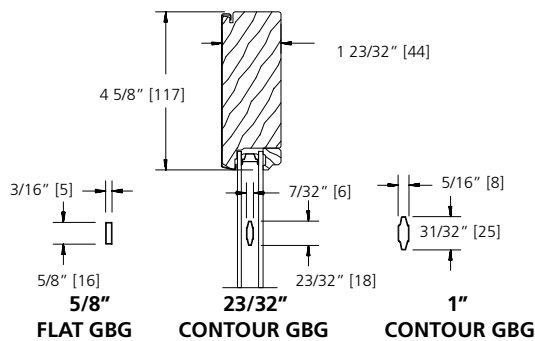

5/8" FLAT GBG

23/32" CONTOUR GBG

1" CONTOUR GBG

SCALE: NTS

GLAZING OPTIONS

INTERIOR GLAZED
SINGLE 1/8" [3] GLASS

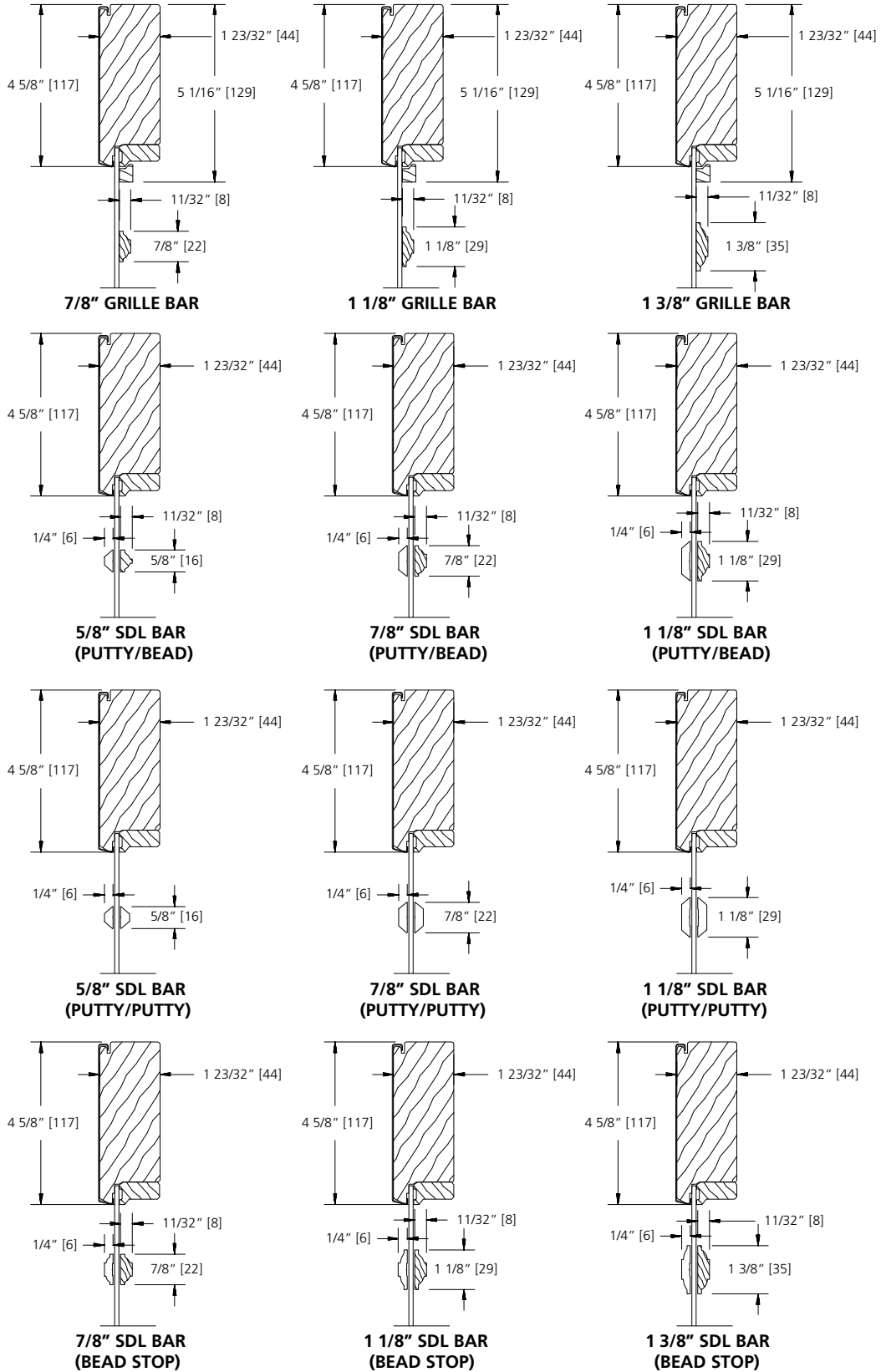

SCALE: NTS

GLAZING OPTIONS

**INTERIOR GLAZED
IMPACT RESISTANT GLASS**

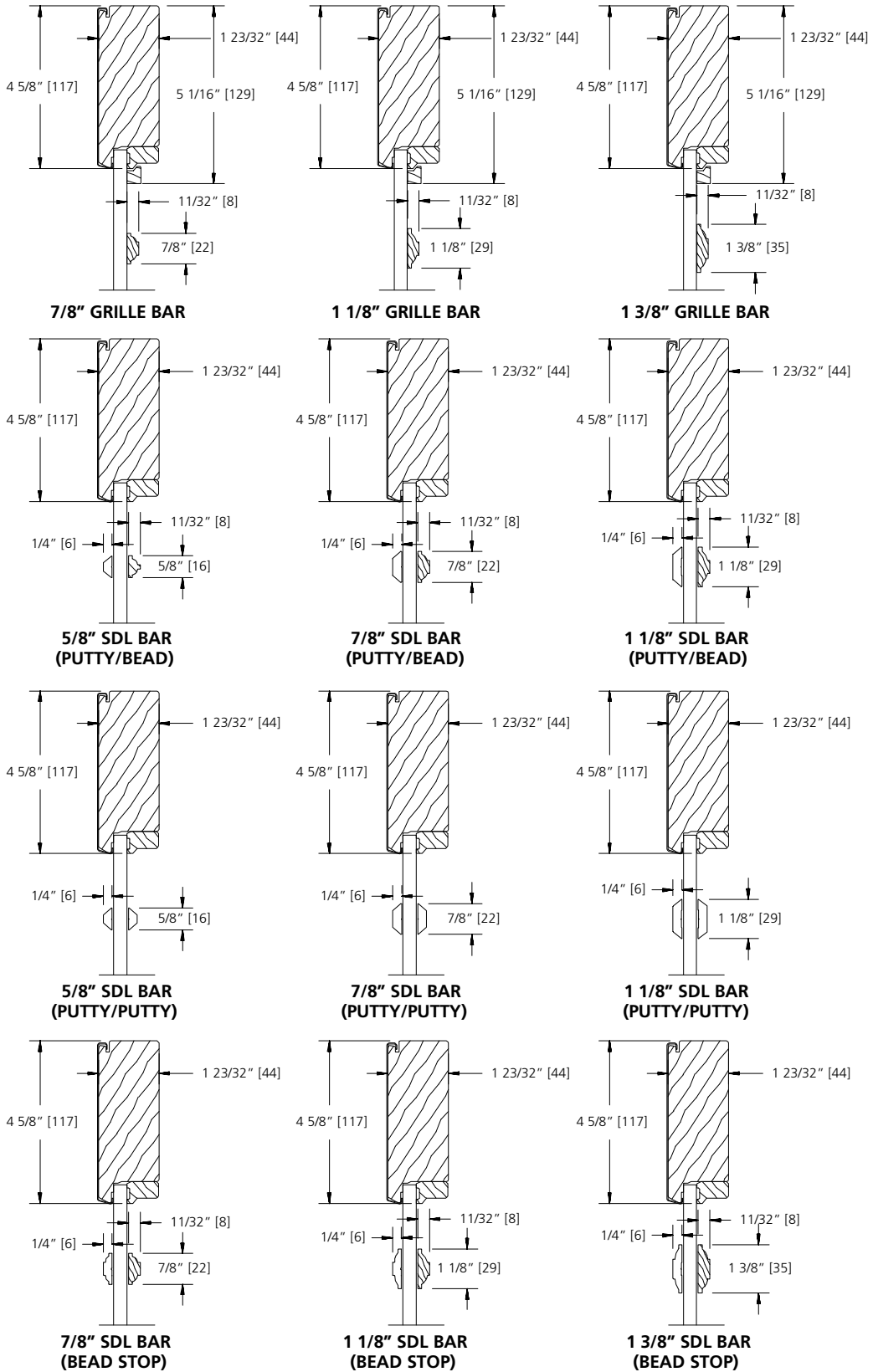

SCALE: NTS

TRIM OPTIONS

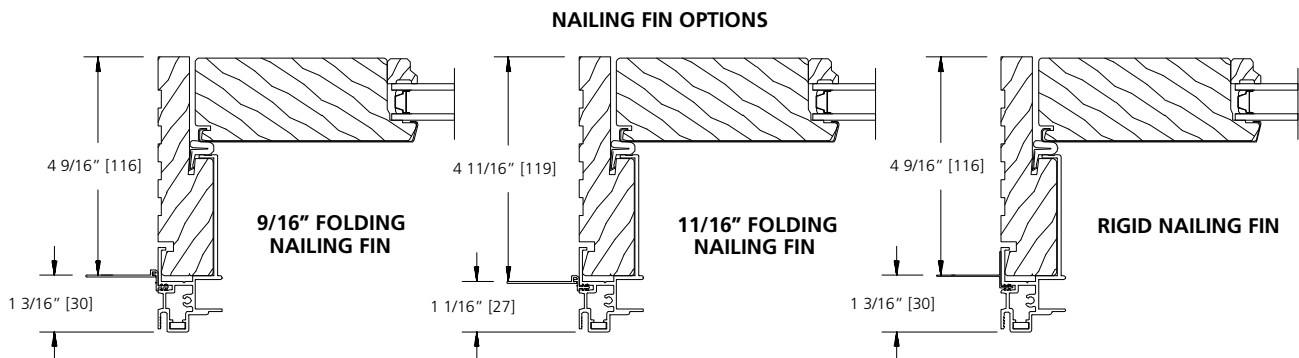
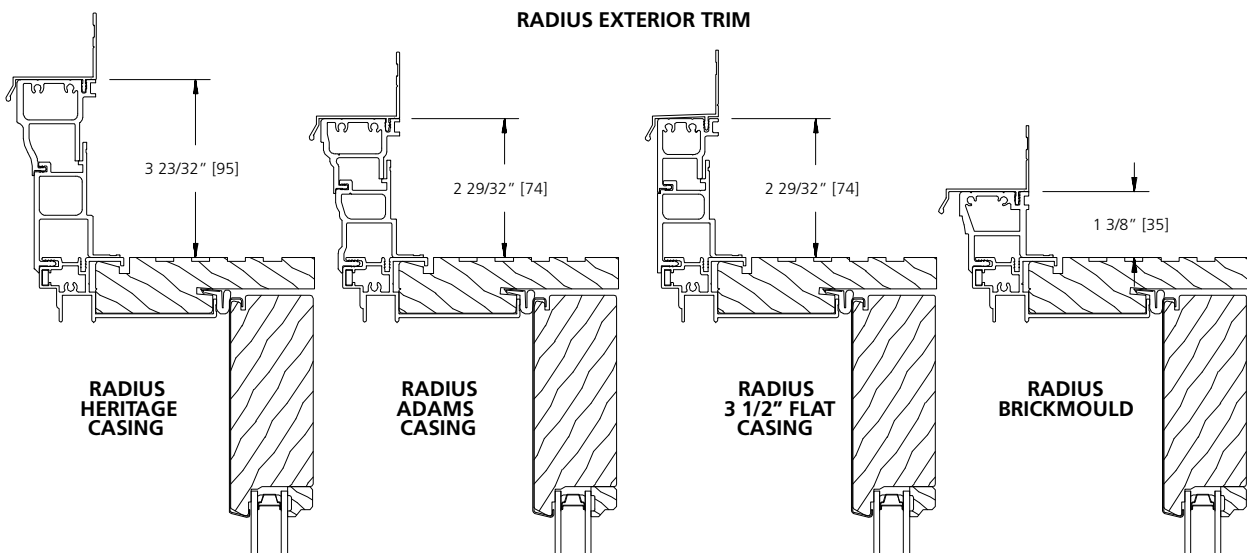
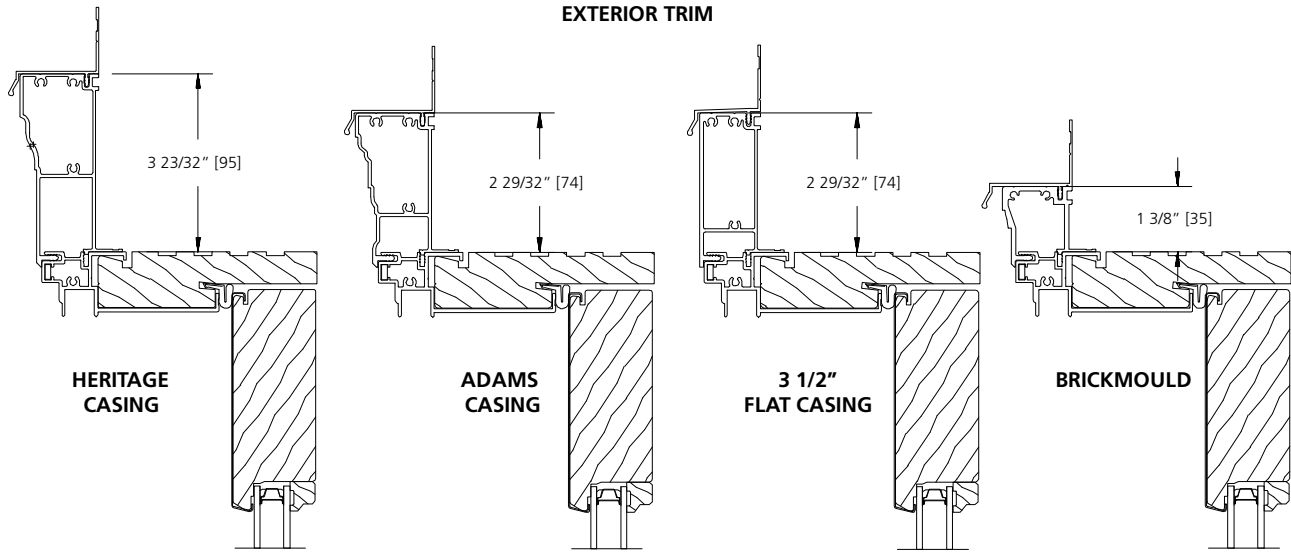

NOTE: 11/16\"/>

SCALE: 3\"/>

RAIL, PANEL & SILL OPTIONS

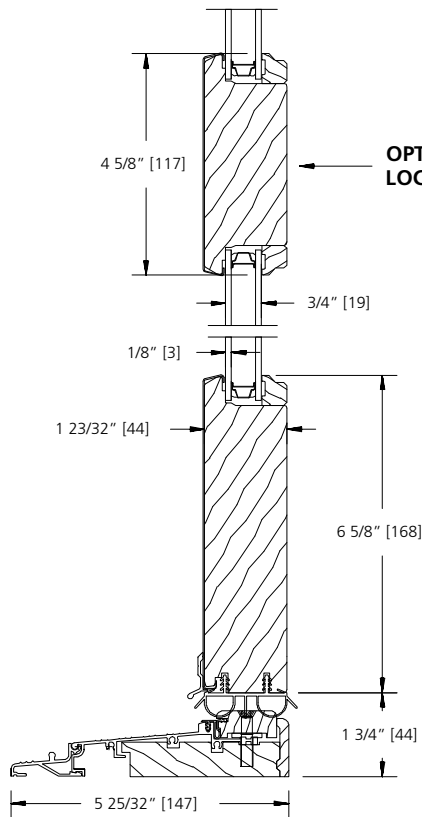

**STANDARD 6 5/8" BOTTOM RAIL
STANDARD SILL (4 9/16 JAMB)**

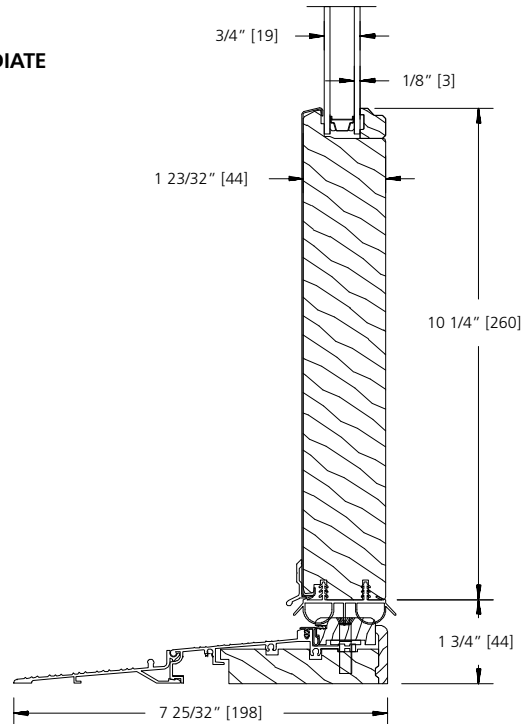

**OPTIONAL 10 1/4" BOTTOM RAIL
SILL EXTENSION (6 9/16 JAMB)**

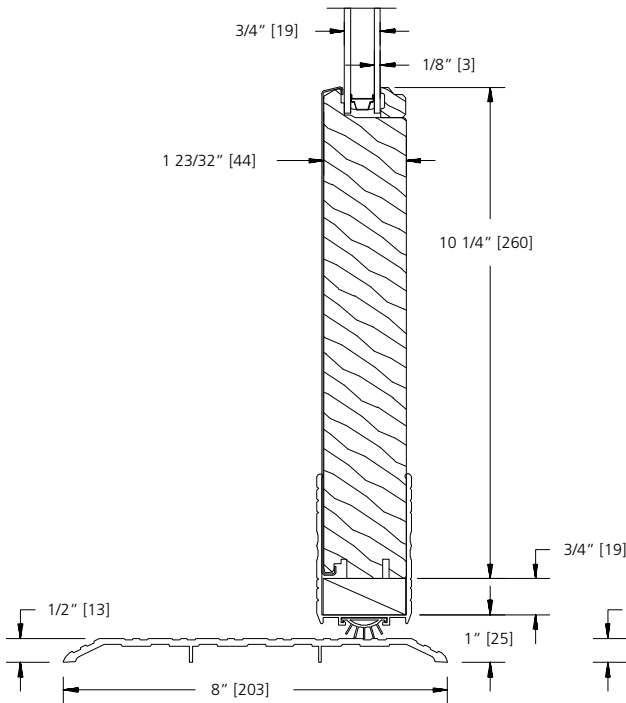

**OPTIONAL 10 1/4" BOTTOM RAIL
HANDICAP SILL (4 9/16 JAMB)**

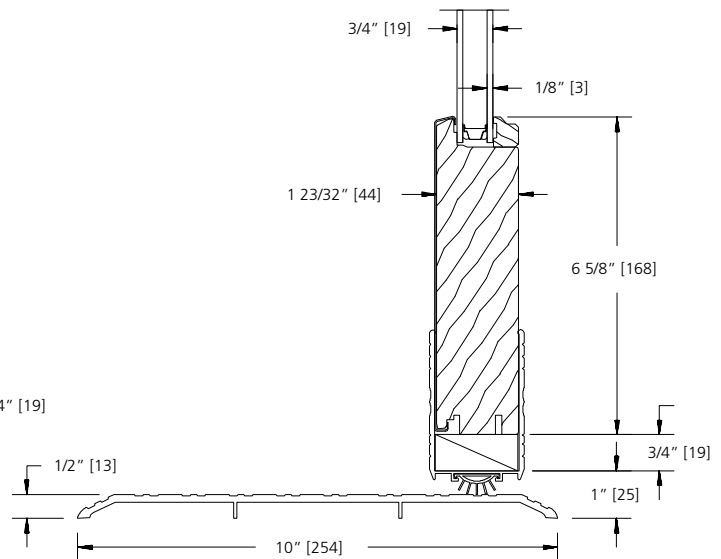

**STANDARD 6 5/8" BOTTOM RAIL
HANDICAP SILL (6 9/16 JAMB)**

SCALE: 3" = 1'

RAIL, PANEL & SILL OPTIONS

TRANSOM

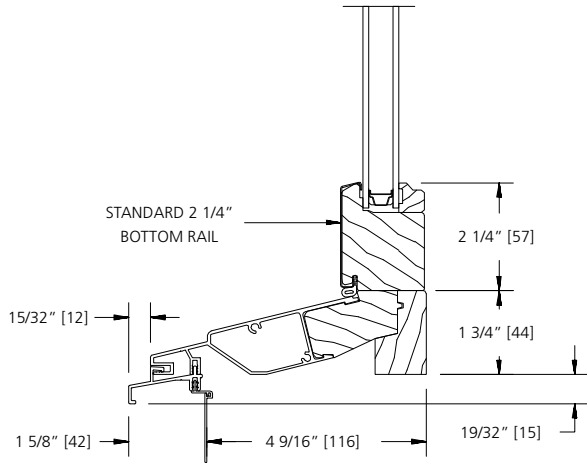

**TRANSOM
SILL NOSE
(4 9/16" JAMB)**

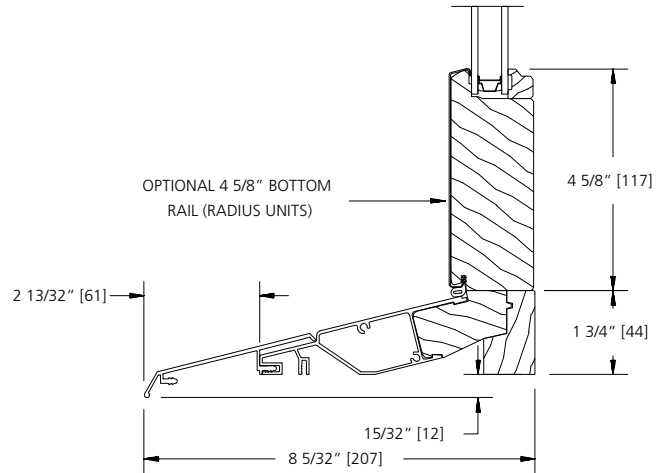

**TRANSOM
2" SILL EXTENSION
(6 9/16" JAMB)**

NOTE: SILL NOSE CAN BE USED WITH ALL STANDARD TRIM OPTIONS.

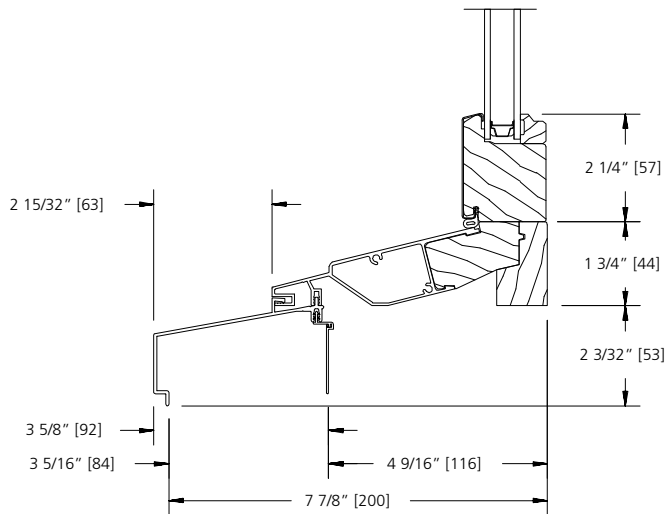

**TRANSOM
EXTENDED SILL NOSE
(4 9/16" JAMB)**

SCALE: 3" = 1'

RAIL, PANEL & SILL OPTIONS

STANDARD RAISED PANEL OPTIONS

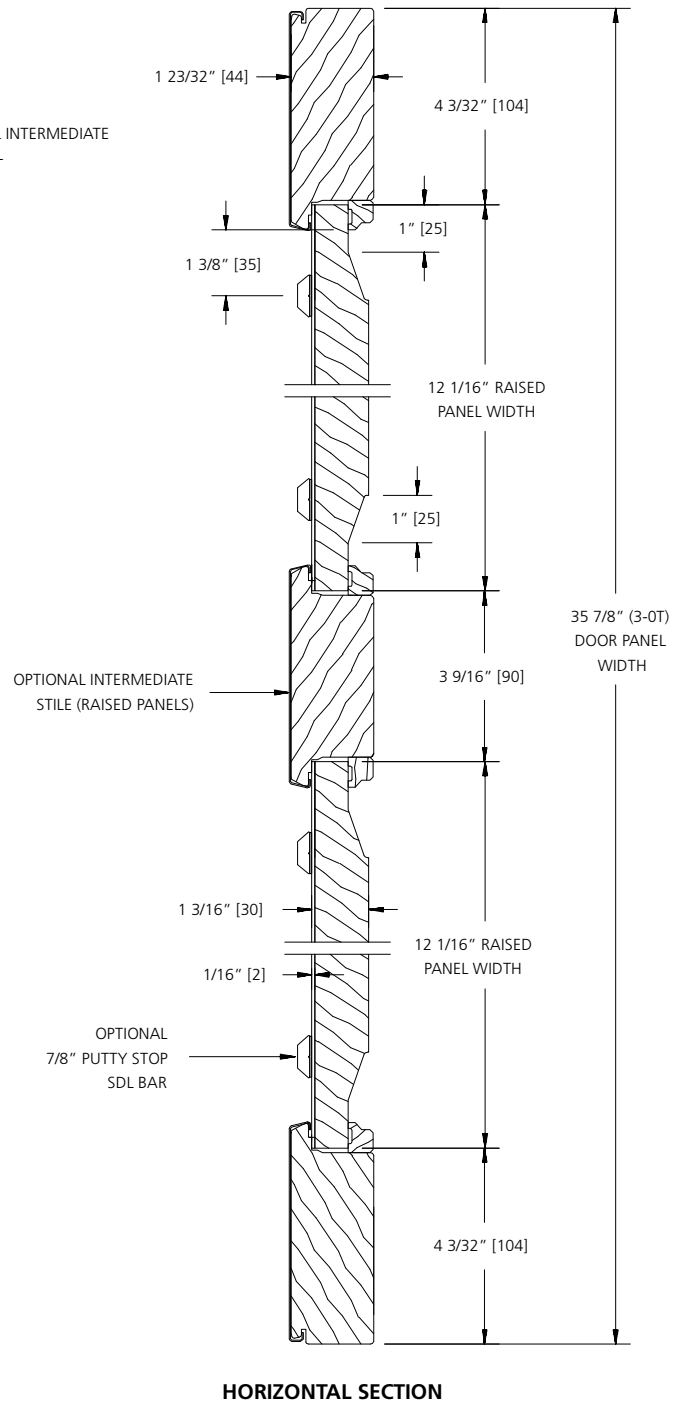
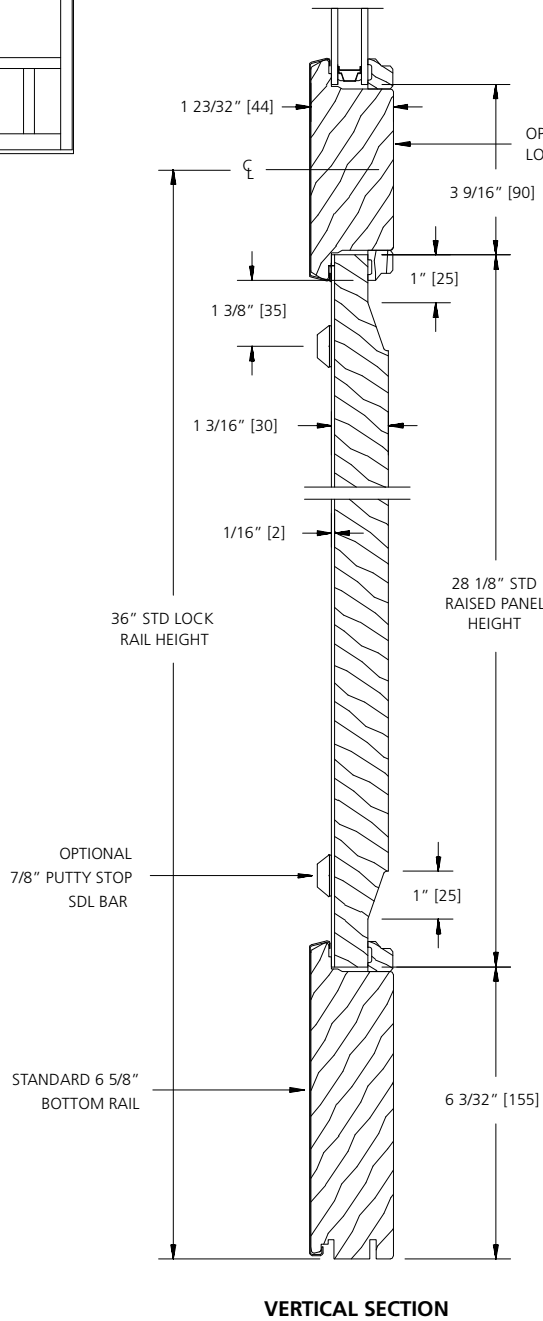
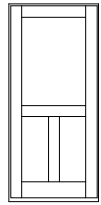

SCALE: 3" = 1'

RAIL, PANEL & SILL OPTIONS

OPTIONAL RAISED PANEL OPTIONS

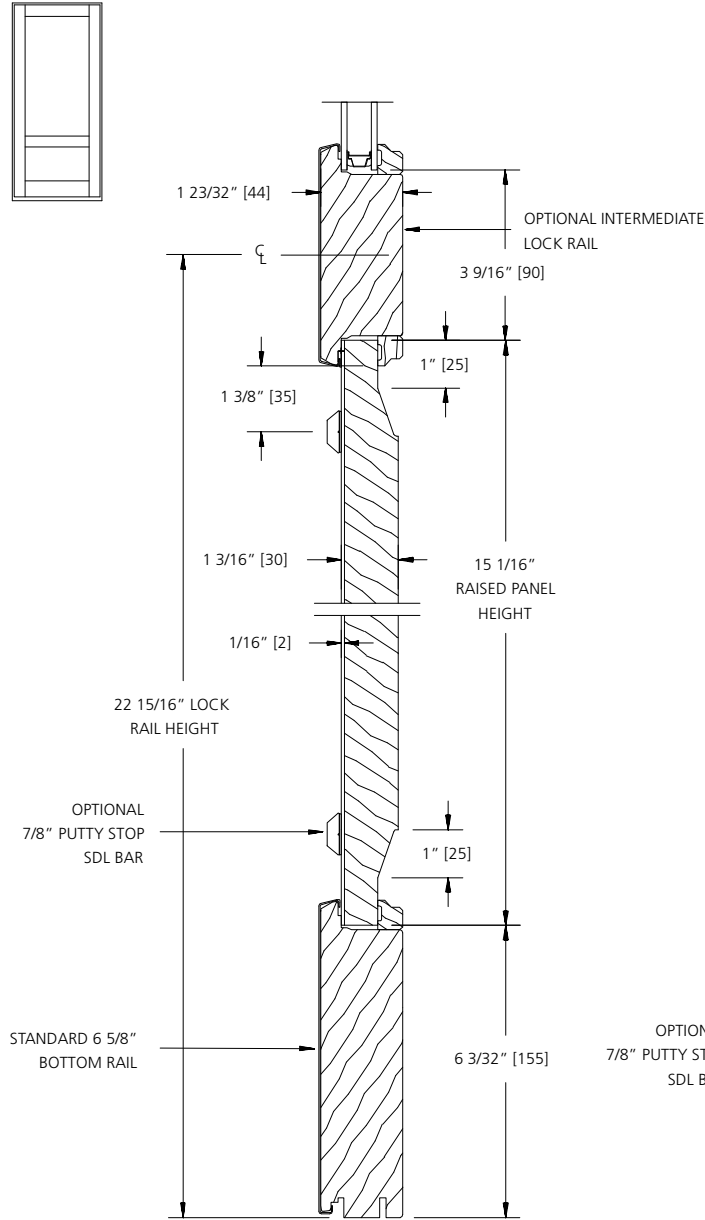
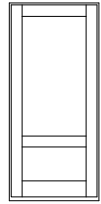

VERTICAL SECTION

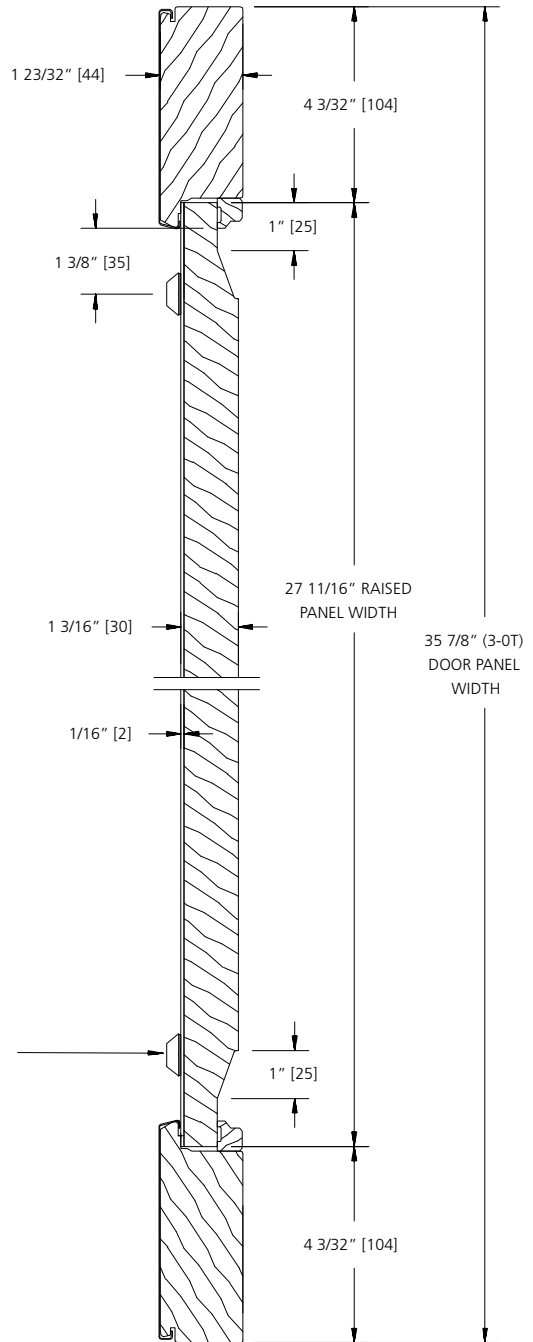

HORIZONTAL SECTION

SCALE: 3" = 1'

STANDARD MULLION DETAILS

4 9/16" JAMB

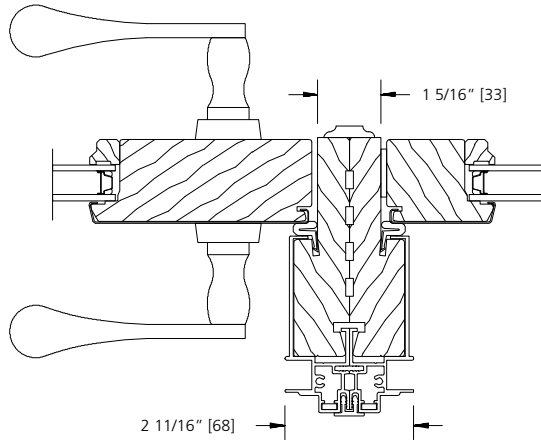

SIDE JAMB

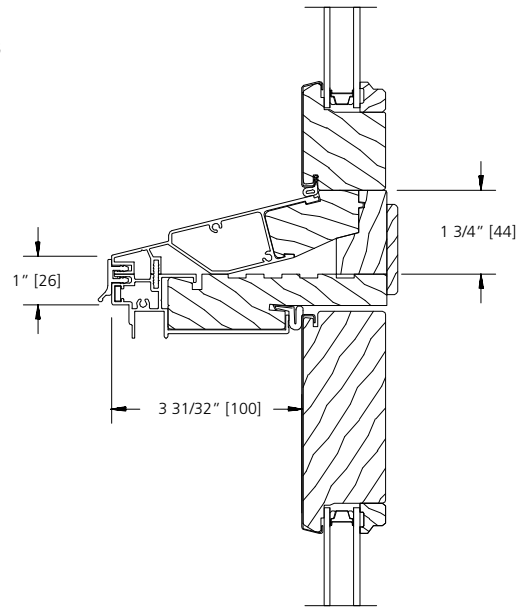

HEAD/SILL

6 9/16" JAMB

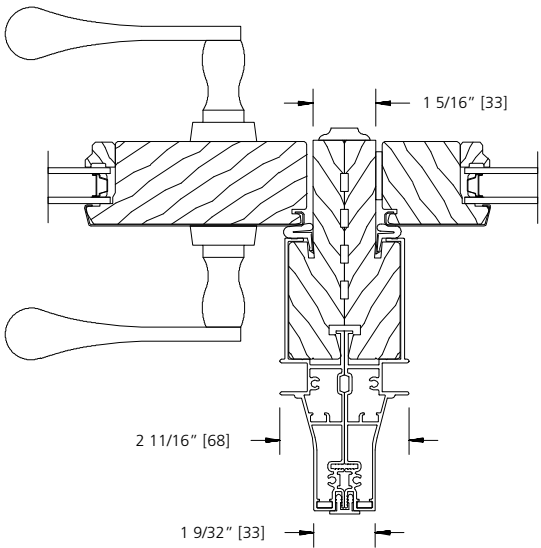

SIDE JAMB

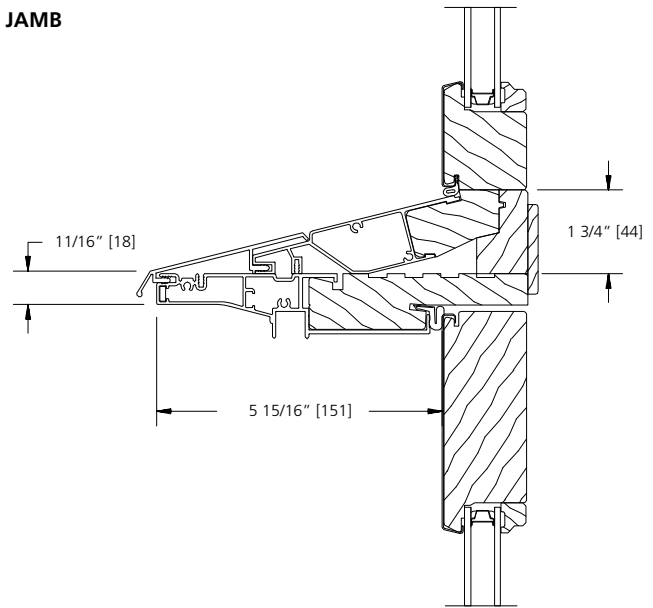

HEAD/SILL

SCALE: 3" = 1'

LITE CUT INFORMATION

Clad in-swing patio doors are available with removable grilles in 5/8", 7/8", 1-1/8", and 1-3/8" widths, with GBG (Grilles between the Glass), or with Simulated Divided Lites. Standard lite cuts are rectangular.

LITE CUT OPTIONS

Special lite cut patterns can include a wide variety of straight line and radius patterns. The illustrations shown here represent just a few of the possibilities. Rectangular, horizontal, vertical and Prairie lite patterns are available in all standard size clad swinging patio doors. Uneven, diamond, radius and Gothic lite cuts are available, subject to approval. Approvals are based on the ability to fulfill the design requirement while maintaining the construction integrity of the finished product.

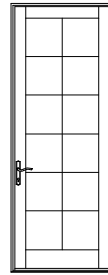

RECTANGULAR

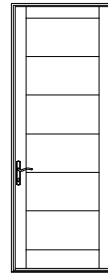

HORIZONTAL

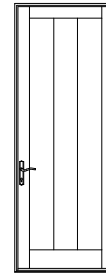

VERTICAL

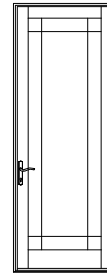

PRAIRIE

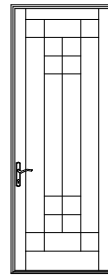

UNEVEN

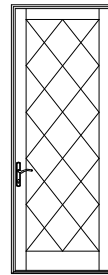

DIAMOND

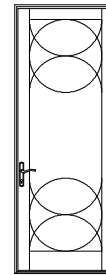

RADIUS

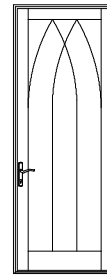

GOTHIC

BAR ALIGNMENT

Alignment of divided lite muntin bars from one product to the next is often required by fine architectural design. Wood grilles, GBG (Grilles between the Glass), and Simulated Divided Lights may be specified with muntin bars aligned.

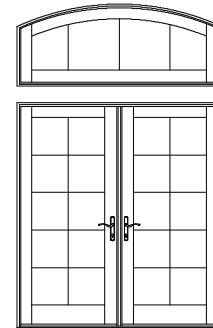
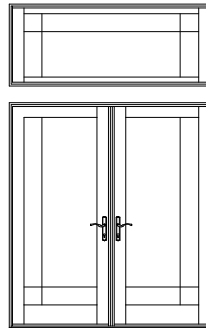

**UNIT SIZING, ROUGH OPENINGS
& MASONRY OPENINGS**

STANDARD OFFERING

DRIP CAP & NAILING FLANGE

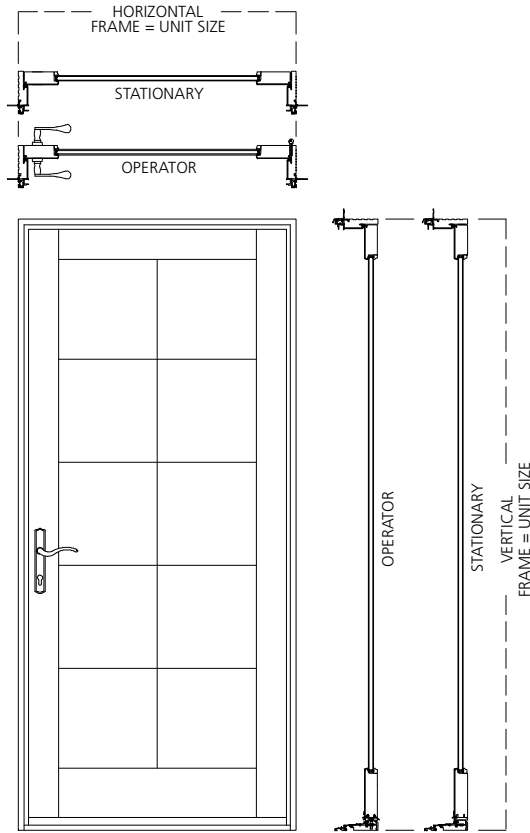

GENERAL NOTES:

UNITS WITH NO EXTERIOR TRIM
OR DRIP CAP & NAILING FLANGE:
FRAME SIZE = UNIT SIZE

UNIT SIZE IS ALWAYS THE
EXTREME SIZE OF THE DOOR
WITH OR WITHOUT TRIM
(DRIP CAP & NAILING FLANGE ARE
NOT ADDED TO ANY UNIT SIZING)

ROUGH OPENING IS ALWAYS 3/4" OVER
FRAME SIZE OF THE DOOR

MASONRY OPENING IS ALWAYS 1/2"
OVER THE UNIT SIZE OF THE DOOR

ROUGH OPENING:

DRIP CAP & NAILING FLANGE

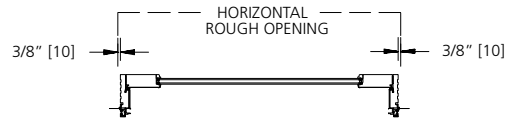

UNIT SIZE

FRAME TO EXTERIOR TRIM (UNIT) SIZE

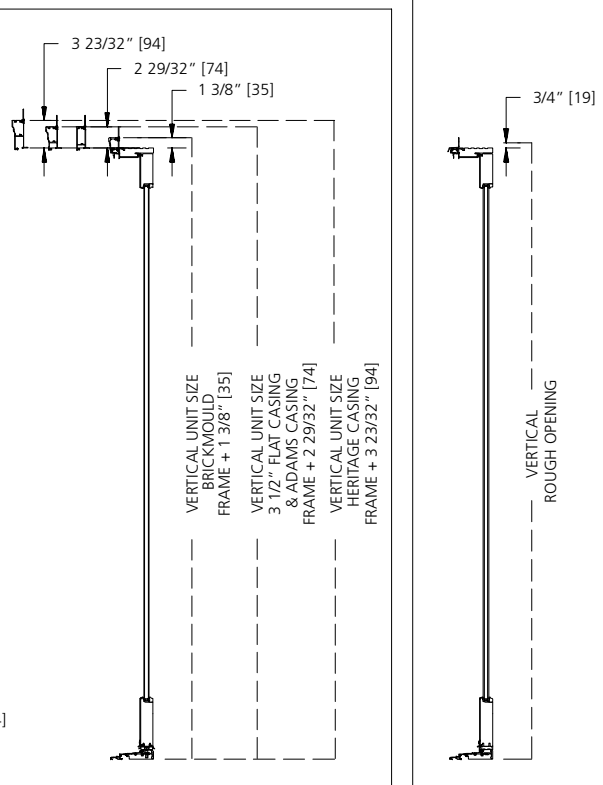
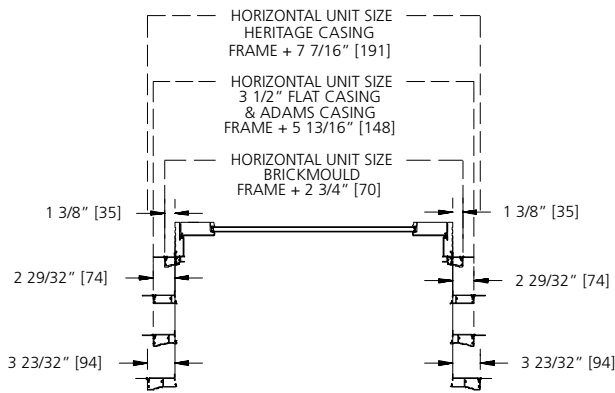

**VERTICAL SECTION
1-PANEL UNIT**

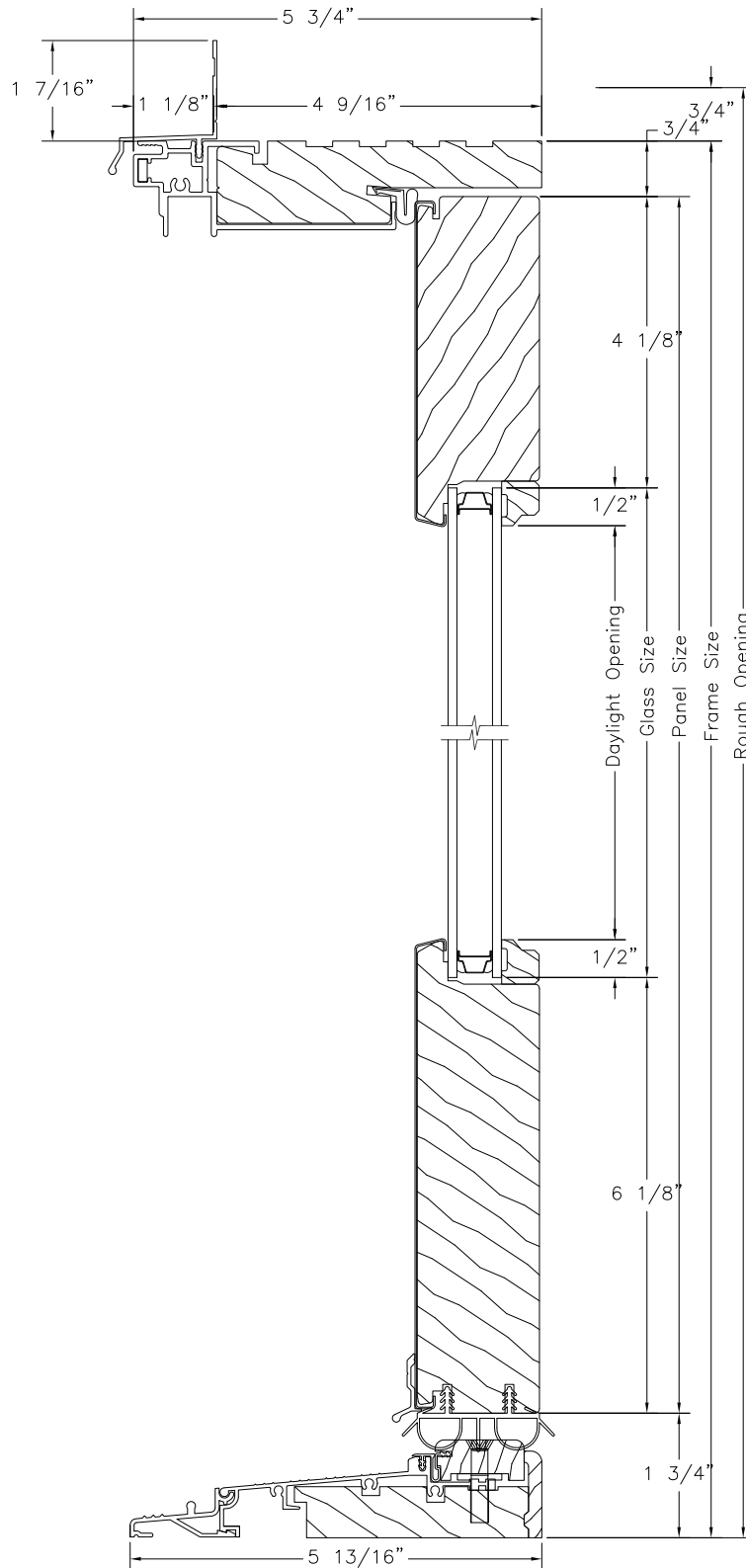

HORIZONTAL SECTION
1-PANEL OPERATING UNIT

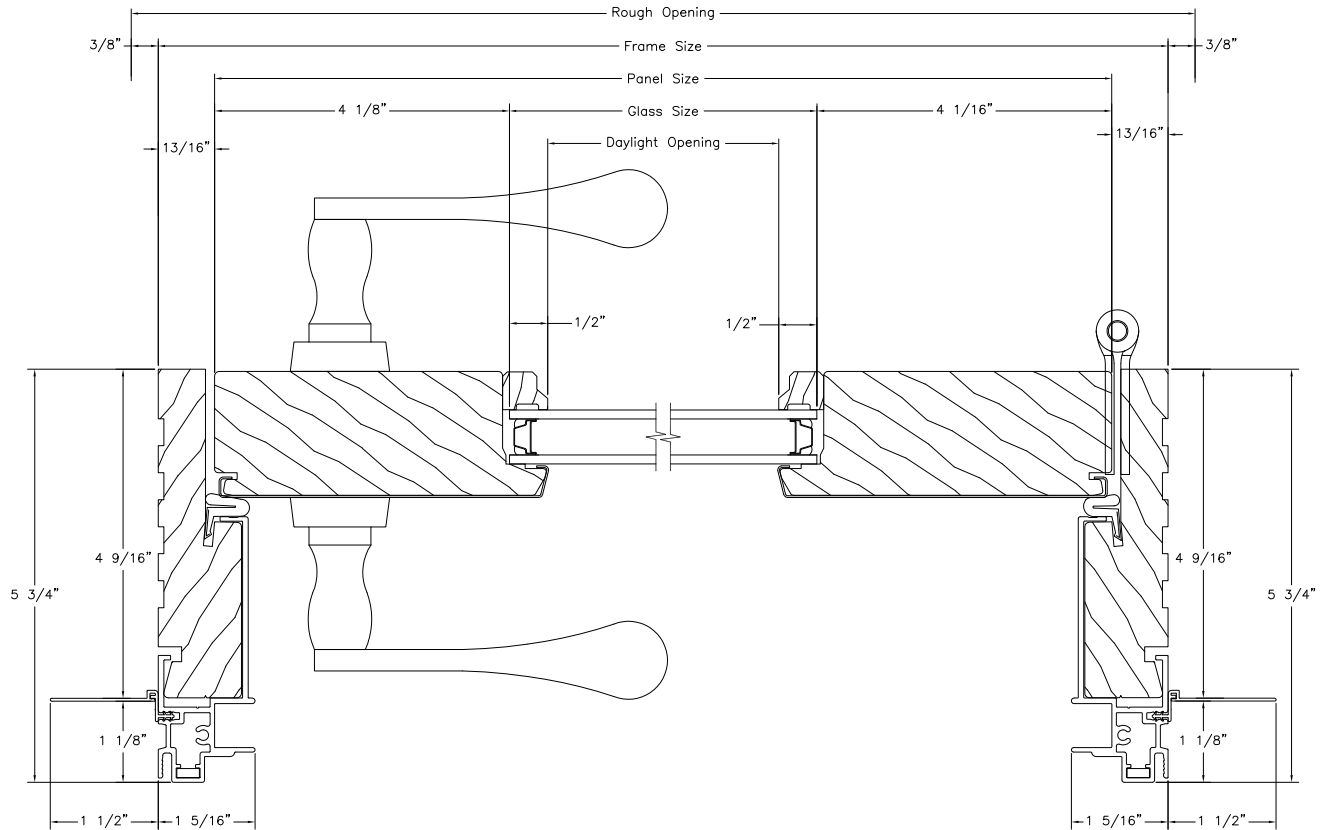

HORIZONTAL SECTION
2-PANEL UNIT

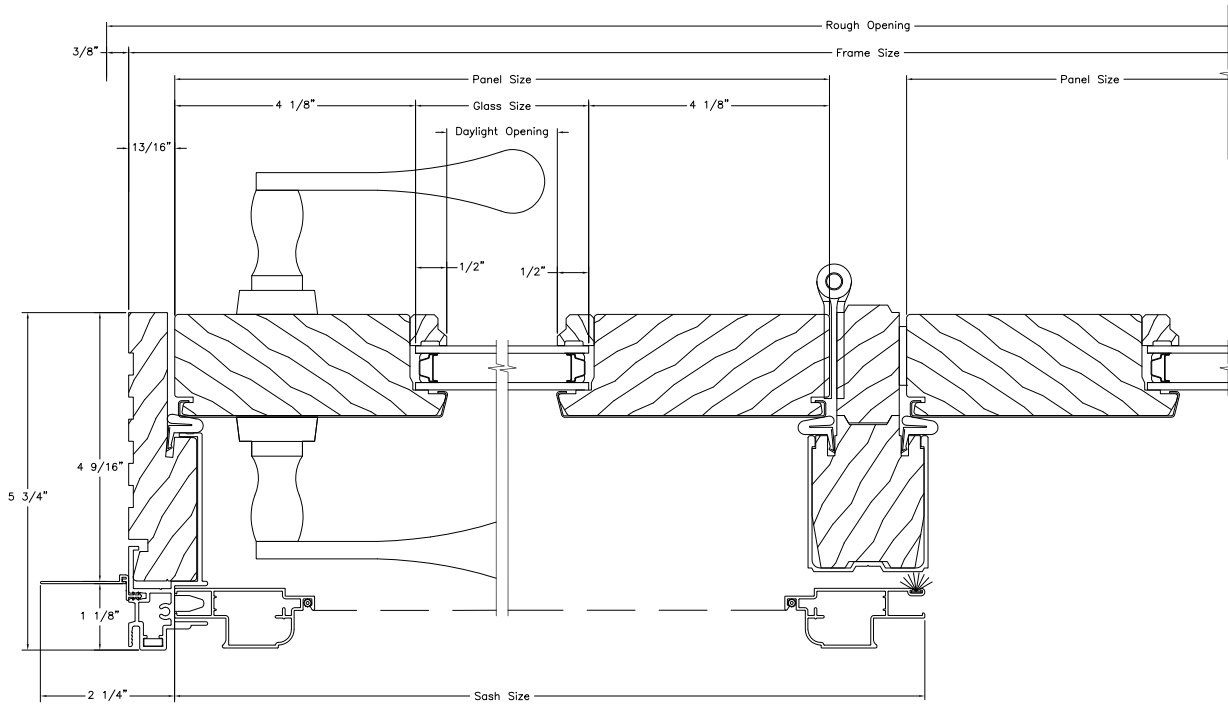

HORIZONTAL SECTION
1 PANEL UNIT WITH SIDELIGHT(S)

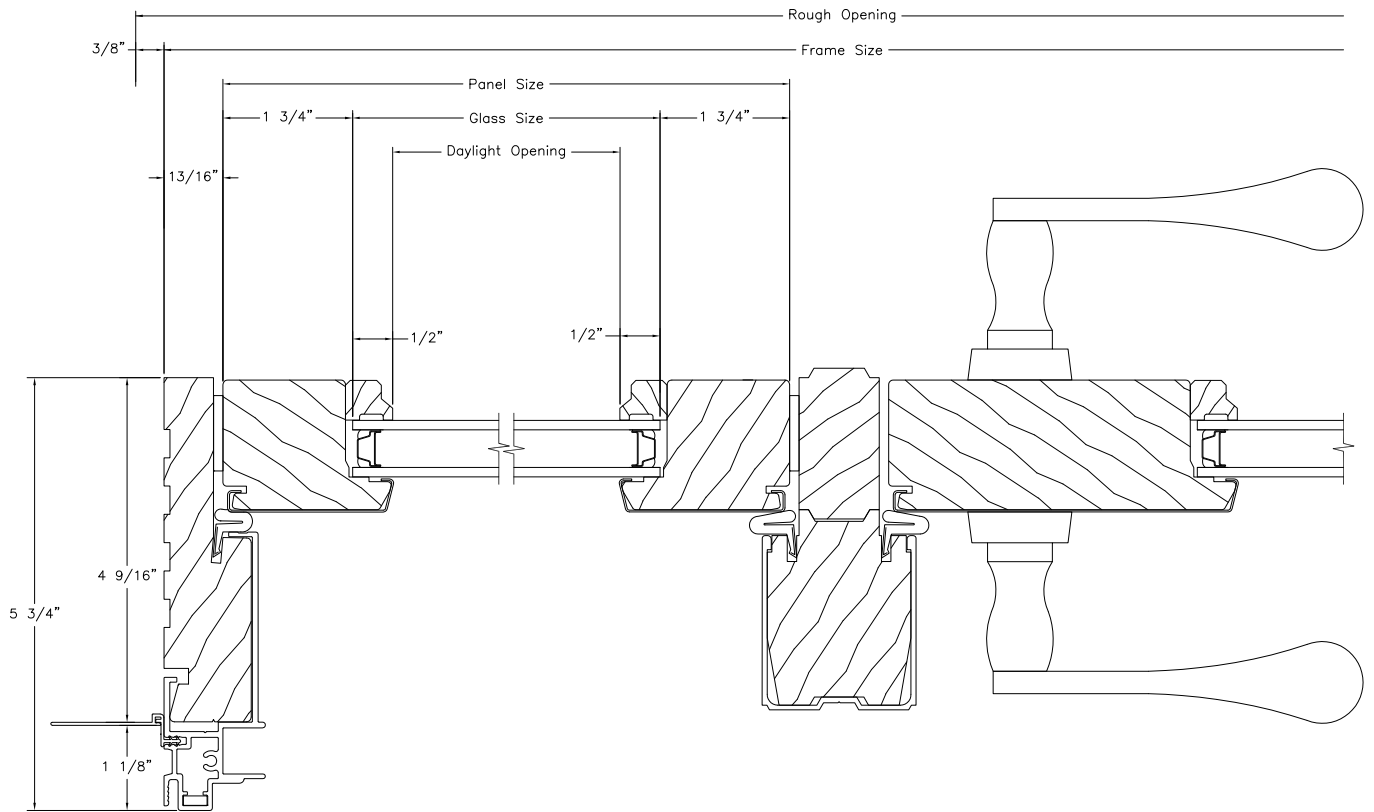

**HORIZONTAL SECTION
FRENCH DOOR UNIT**

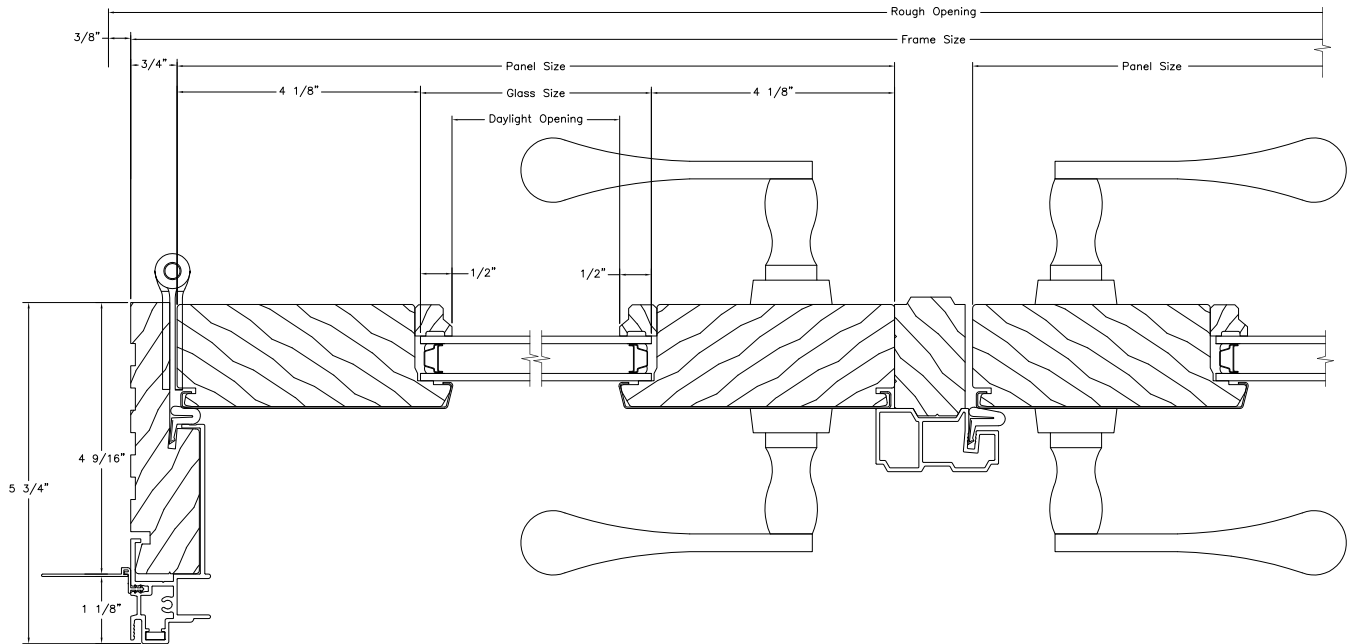

HORIZONTAL SECTION
FRENCH UNIT WITH SIDELITE

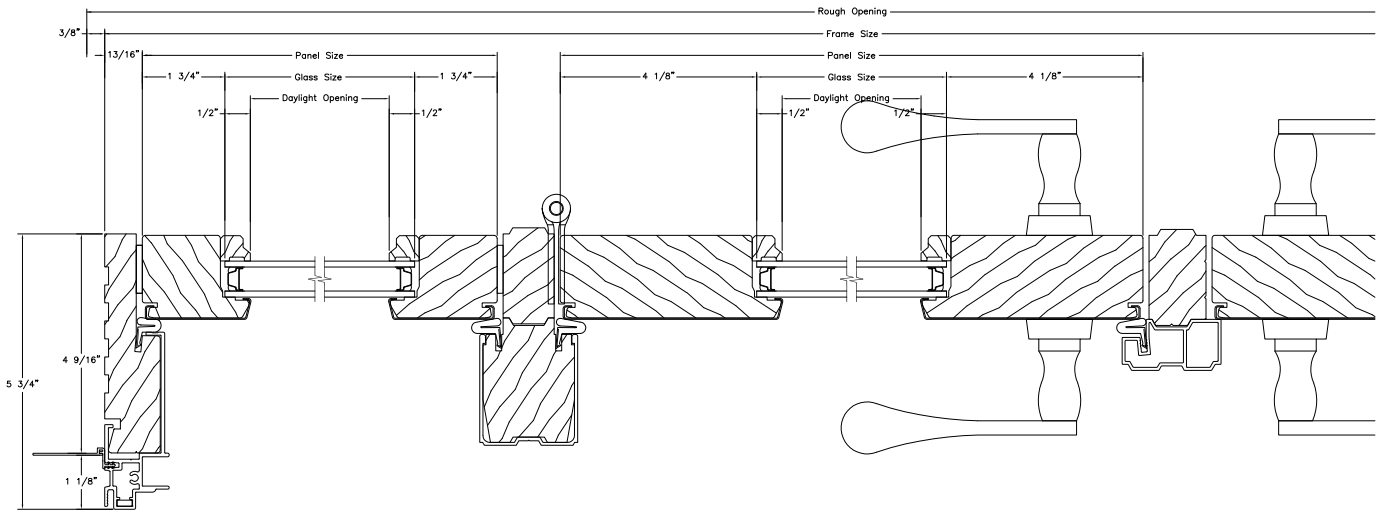

**VERTICAL SECTION
STATIONARY SIDELITE**

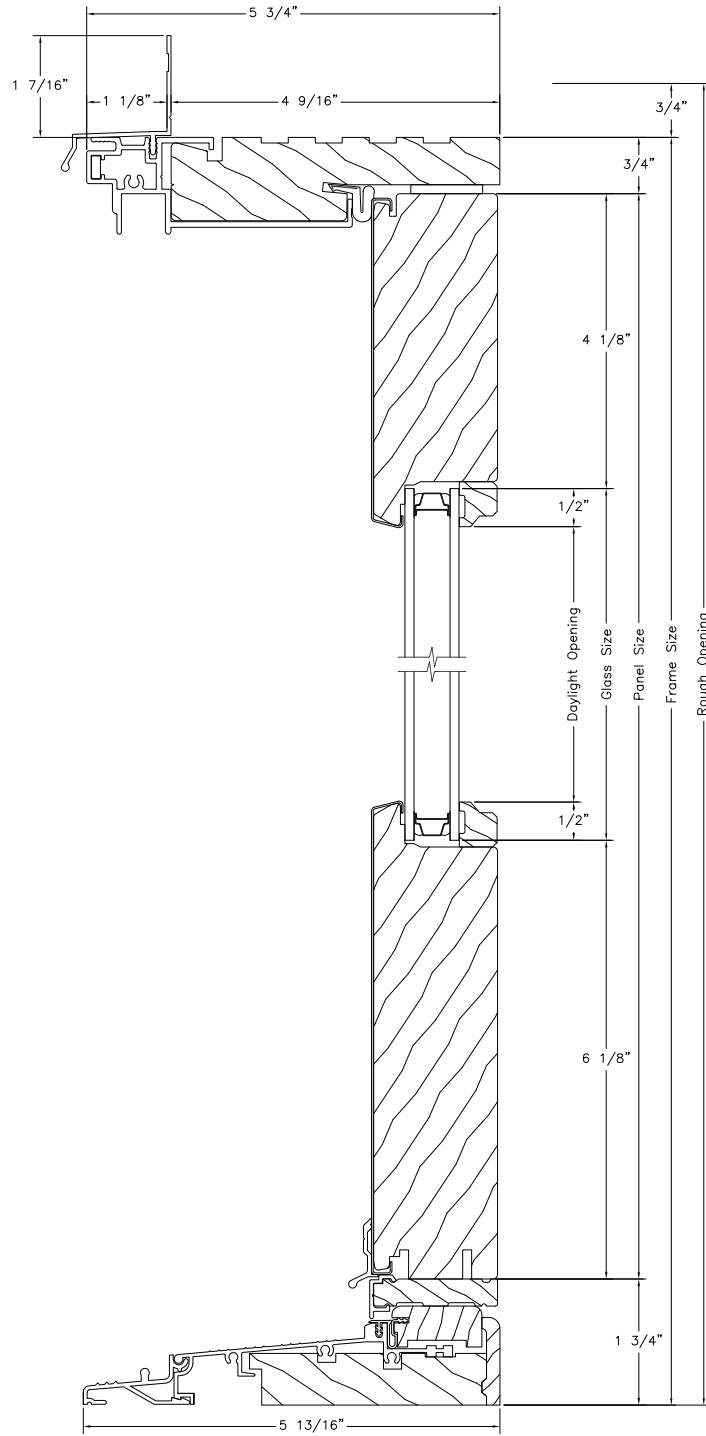

HORIZONTAL SECTION
1-PANEL SIDELITE STATIONARY UNIT

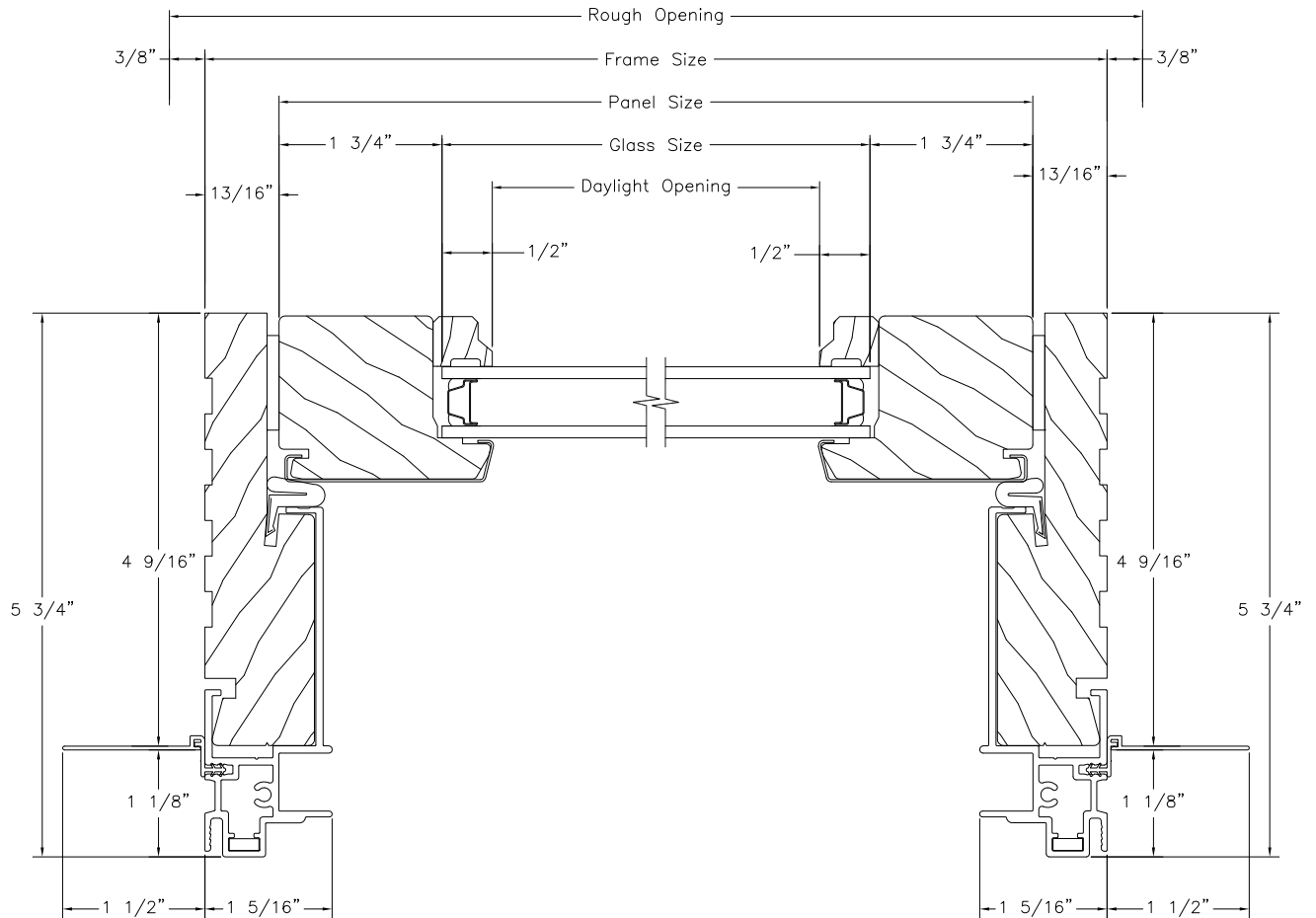

**VERTICAL SECTION
4 9/16" JAMB TRANSOM UNIT**

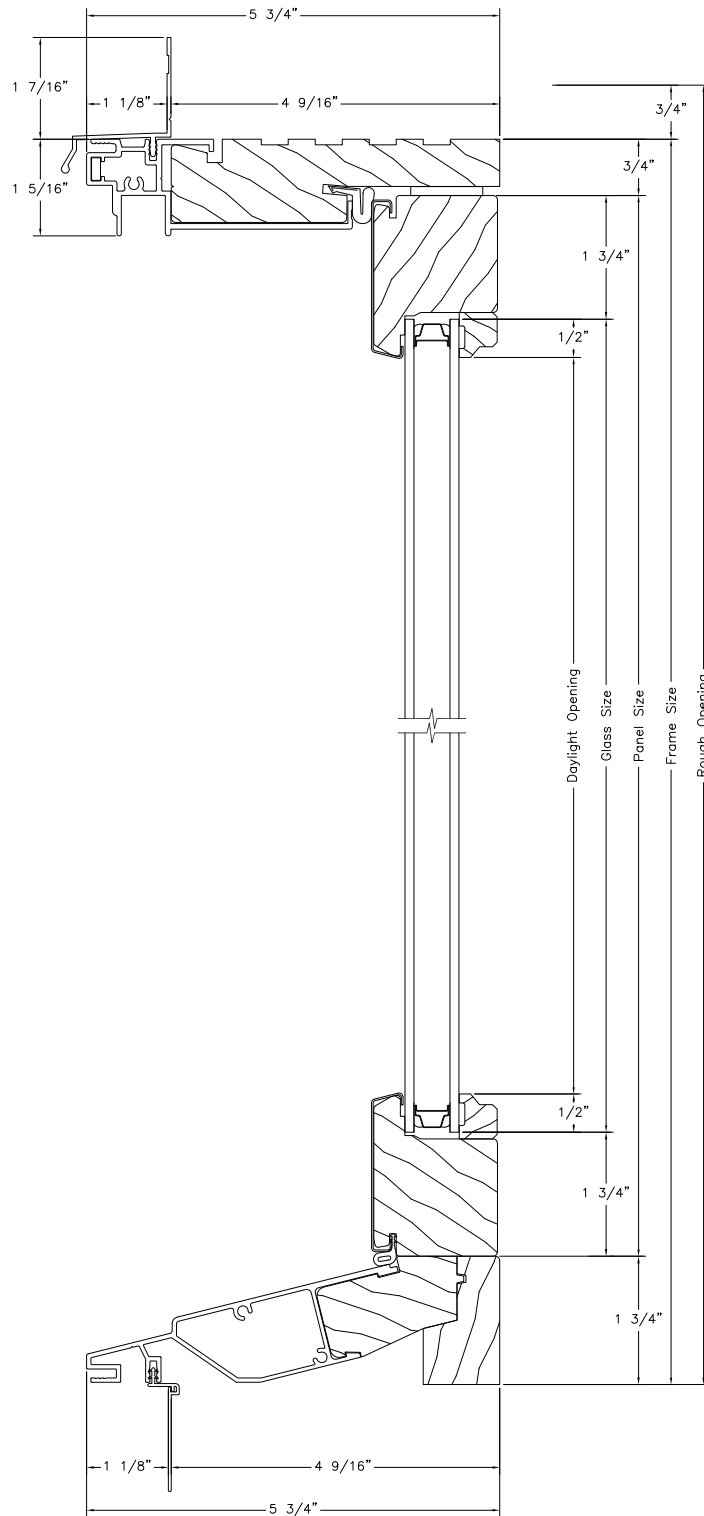

VERTICAL SECTION
1-SASH TRANSM WITH 6 9/16" JAMB

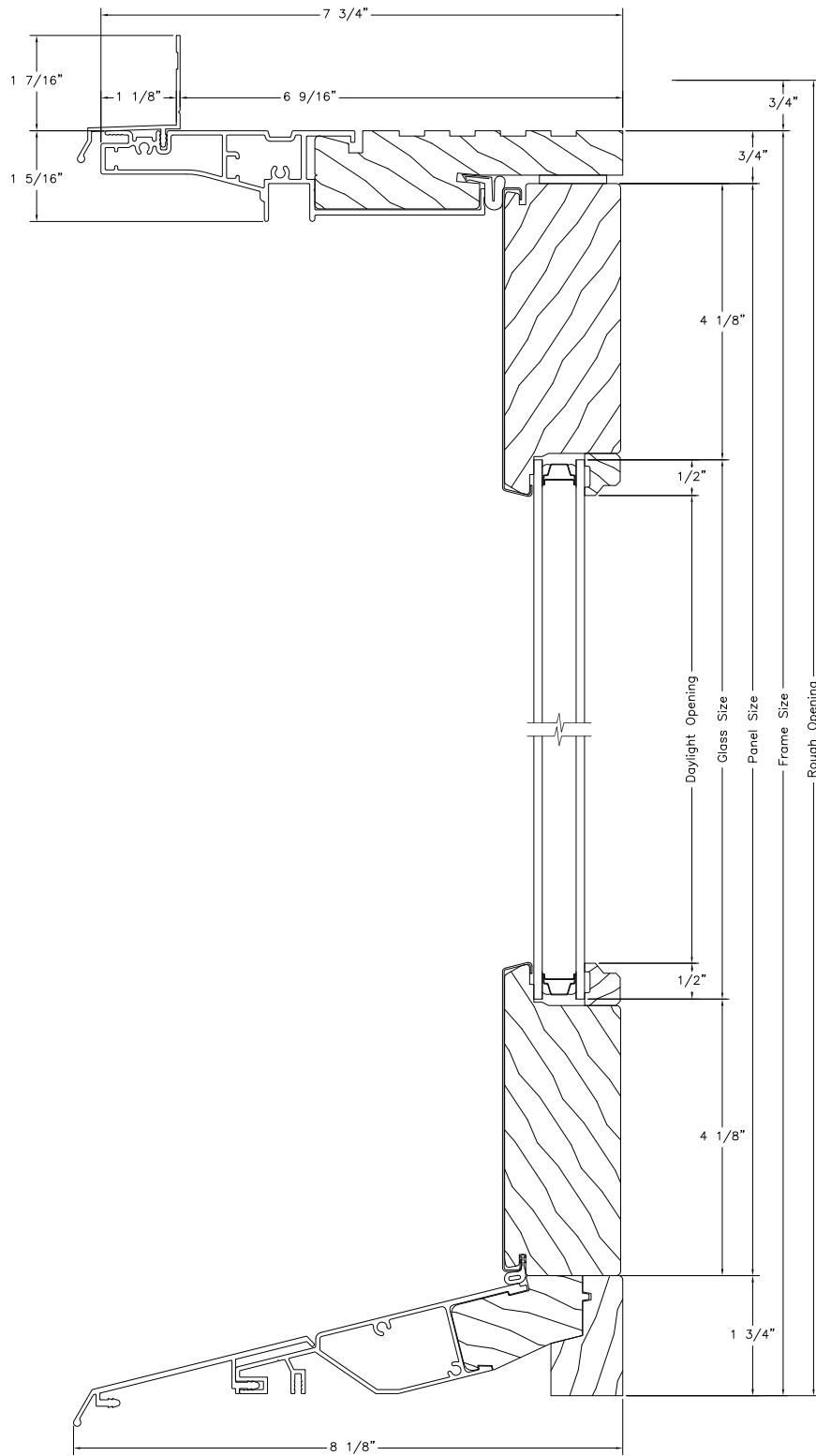

**HORIZONTAL SECTION
SINGLE SASH TRANSOM UNIT**

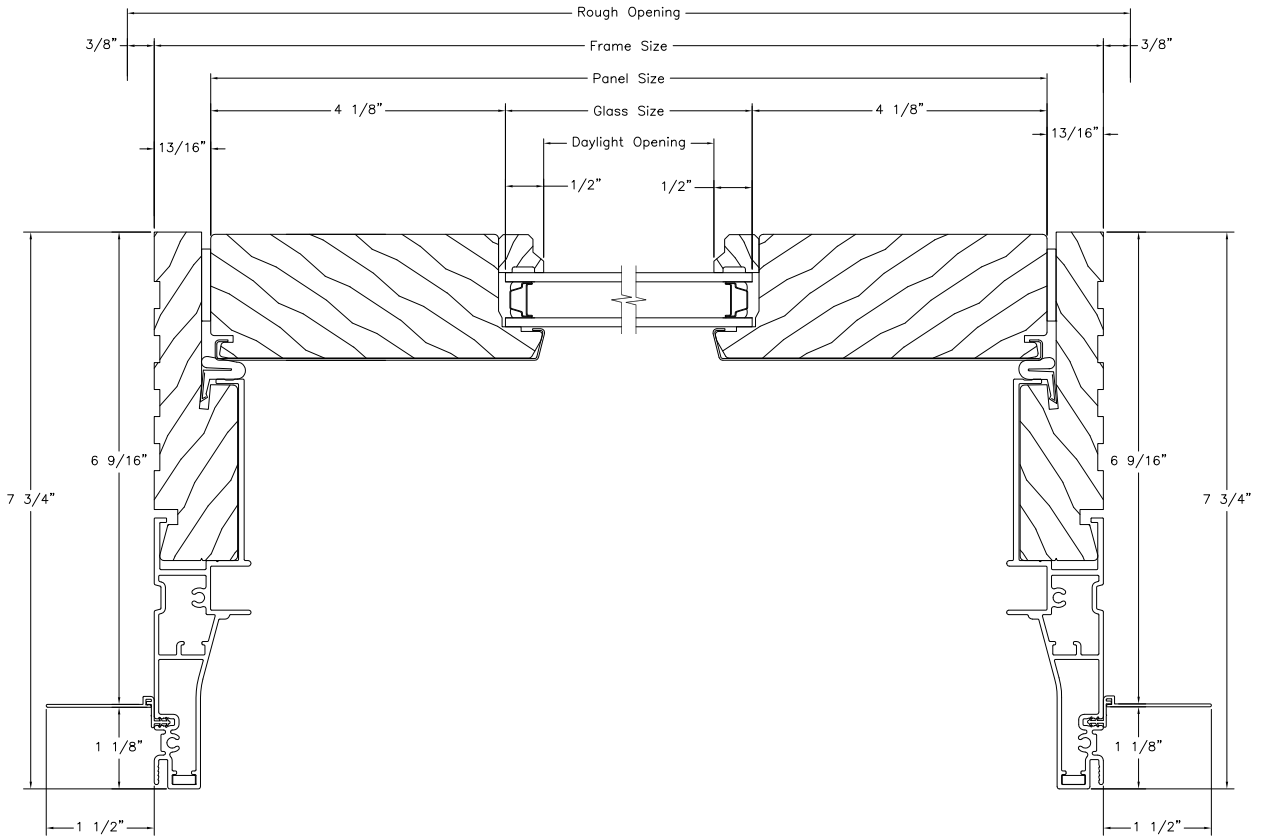

**HORIZONTAL SECTION
VENTING SIDELIGHT UNIT**

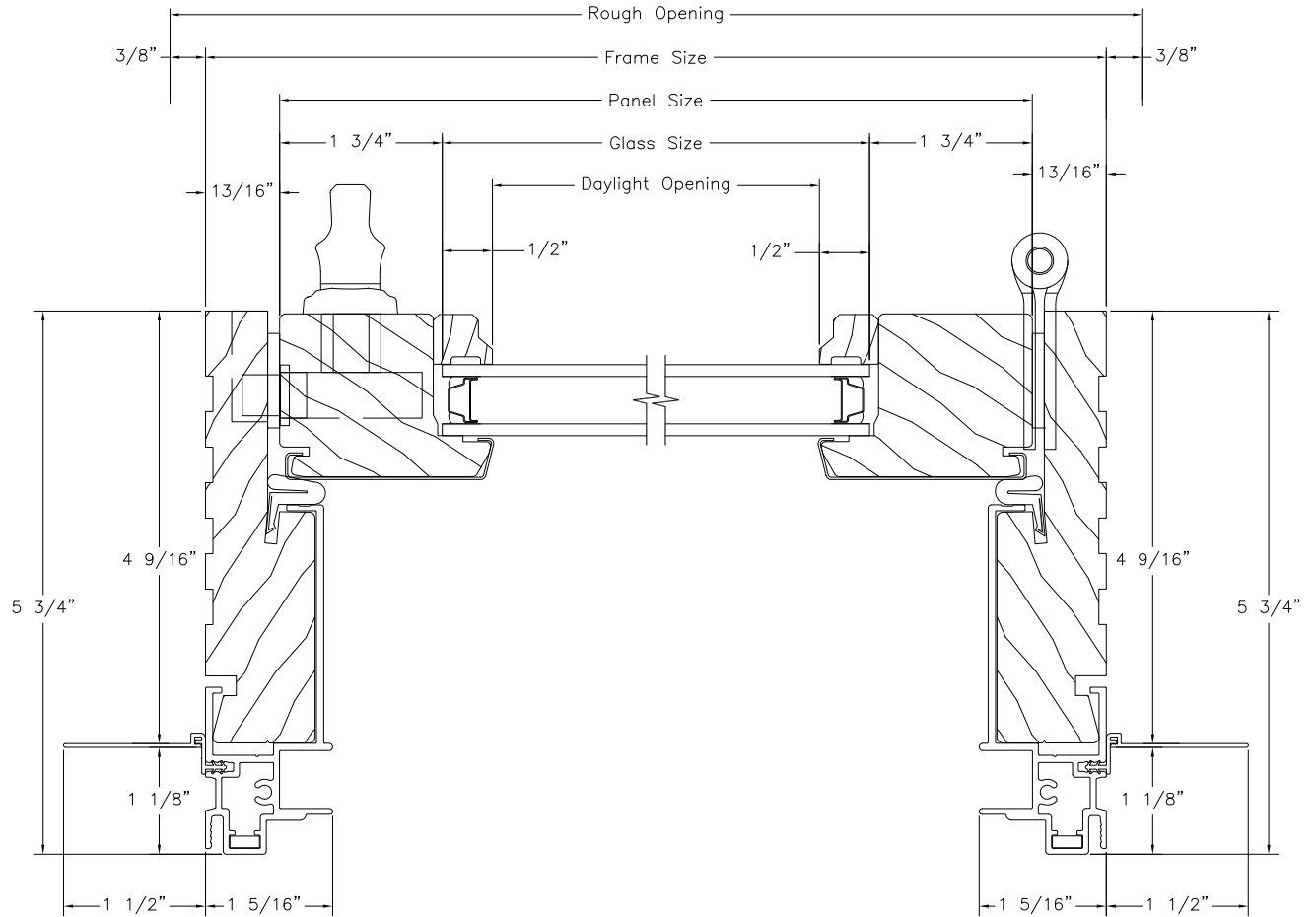

HORIZONTAL SECTION
1-PANEL STRUCTURAL UNIT
W/ VENTING WIDE STILE SIDELITES

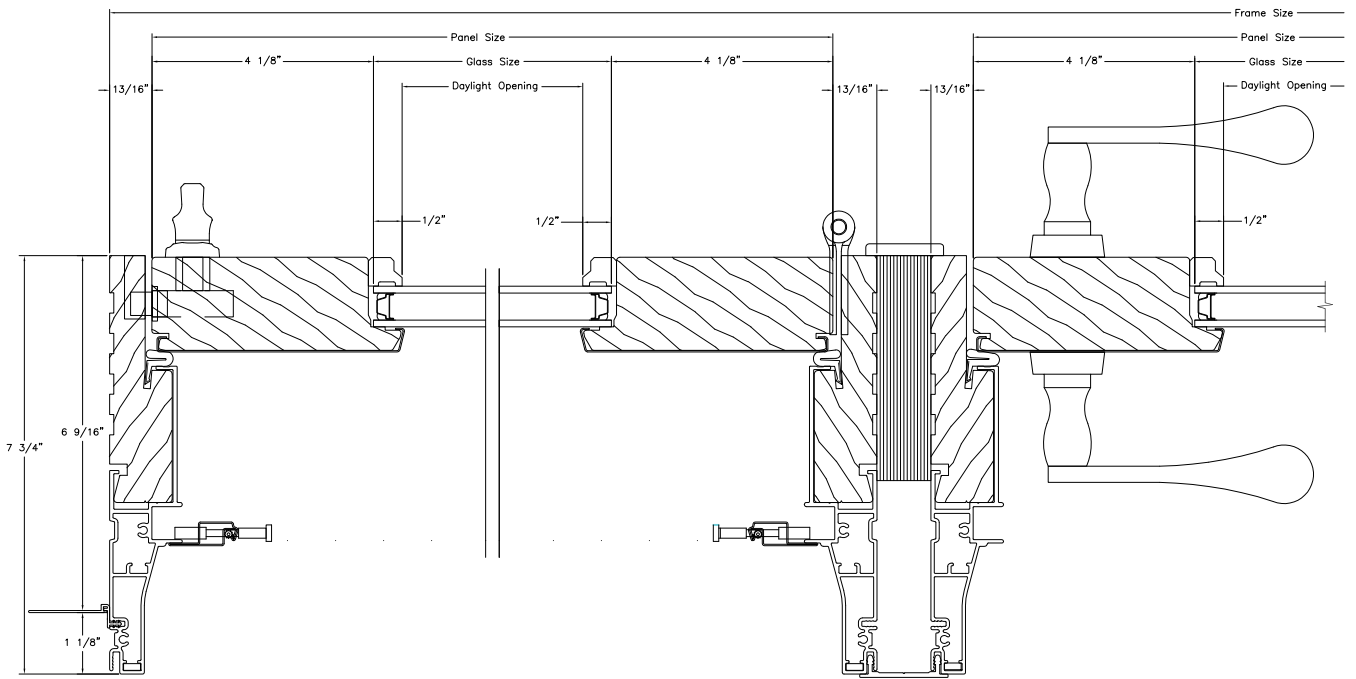

**HORIZONTAL SECTION
FRENCH DOOR STRUCTURAL UNIT
WITH SIDELITES**

