TABLE OF CONTENTS

Specifications	22-2
Quick Spec Guide	22-4
Elevations/Sizes: 1/8" Scale	22-6
Swinging Door Units	22-8
French Units	22-11
Single Door with Single Sidelite	22-13
Single Door with Two Sidelites	22-14
French Door with Two Sidelites	22-15
Transom Units	22-19
Sector Top Doors	22-24
French Sector Top Doors	22-26
French Sector Top Doors with Two Sidelites	22-28
Sector Top Transom Units	22-32
Glazing Options	22-33
Trim Options	22-36
Rail, Panel & Sill Options	22-37
Mullion Details	22-41
Grille & SDL Patterns	22-42
Unit Sizing, Rough Openings & Masonry Openings	22-43
Section Details: 3" Scale	22-44

PRODUCT SPECIFICATIONS**EXTERIOR FINISH**

Exterior aluminum surfaces are finished with a fluoropolymer (70% Kynar 500®) multi-coat finish system to meet the performance standards required by AAMA specification #2605. 41 standard colors include Brilliant White, Chestnut Bronze, Desert Sand, French Vanilla, Hartford Green, Mesa Red, Black Licorice, Heirloom White, Hunter Green, Redwood, Sage Brown, Smoke and more. Custom Color Matching available. Three Copper finishes are available on door panels.

AURALAST® WOOD

AuraLast® wood is fundamentally different from wood treated in traditional millwork preservation processes in that it uses a proprietary vacuum/pressure process to provide protection throughout the wood parts used to make windows and doors. AuraLast® wood is distinguished from wood using traditional preservation methods by its unique ability to achieve greater penetration of the active ingredients into the wood parts, with a minimum treatment penetration of 92%.

INTERIOR FINISH

Interior surfaces are unfinished clear pine ready for on-site finishing. Optional prefinished pine interiors include four acrylic colors (Moderate White, Extra White, Natural Choice, Pure White), five stains (Wheat, Cherry, Fruitwood, Cordovan, Cider) and a clear lacquer topcoat. Primed interior is also available. Optional interior wood species include vertical grain Douglas Fir, Mahogany and Knotty Alder.

FRAME

Frame is assembled from select kiln-dried pine AuraLast® wood on all exterior parts. Exterior surface is covered with .050 gauge extruded aluminum cladding. Standard jamb width is 4-9/16". Radius frames are produced in only three different radii: 90-9/32", 37-19/16", and 31-19/32".

PANELS

1-23/32" thick select kiln-dried pine AuraLast® wood. Exterior surface is covered with .024 gauge roll formed aluminum cladding. The top and bottom rails are formed from solid Western Pine veneers laminated to a kiln dried edge-and-end-glued core, while the stiles have the same veneer laminated to a Timberstrand core. The standard layout is 4-5/8" top rail and stiles and a 6-5/8" bottom rail. Other door rail options include wide bottom rail, lock rail and raised panels.

GLAZING

Insulating glass is constructed from two panes of tempered glass, utilizing a continuous roll formed stainless steel spacer with dual seal sealant. A computer-controlled application of clear silicone is used to bed the exterior of the insulating glass into the panel. An acrylic sealant is used to bed the interior. All insulating glass units comply with the performance requirements of IGCC in accordance with either ASTM E774 or E2190.

GLAZING OPTIONS - TEMPERED

Tempered insulating glass available in Low-E with Argon, Low-E, Low-E 366, Clear, Neat Glass, Seedy Reamy, tinted, reflective, or obscure, or other specialty glass as specified. Preserve® film is a 0.003" thick polyethylene film with a low tack acrylic adhesive applied to the glass for protection during shipping and installation. Installations at 4,000 foot elevations and higher require a capillary tube to equalize environmental stress (otherwise known as High Altitude glazing). High altitude glazing does not allow the use of Argon as listed under glazing options.

WEATHER-STRIPPING

Engineered system with dual foam filled bulb seal compressed between the exterior of the panel and the frame in a continuous plane on all four sides.

SILL

The sill is a dark bronze anodized aluminum with oak interior trim. A vinyl fin-and-bulb bottom door sweep is applied. An optional handicapped sill with a maximum height of 1/2" is available to meet the standards set forth by the ADA for handicapped access.

HARDWARE

The door panels are mounted into the frame utilizing 4" x 4" heavy gauge solid brass hinges with stainless steel pins. Three hinges are used on 6-8 and 7-0 heights, and four hinges on all larger heights. Optional adjustable hinges are also available providing both vertical and horizontal adjustment. The standard finish for all hinges is Polished Brass, with optional finishes available in Antique Brass, Polished Chrome, Brushed Chrome, Oil-Rubbed Bronze, White Powder Coat, Black Powder Coat, and Satin Nickel. The standard locking system is a single point mortise with lever handle, and thumb turn dead bolt, shipped separately for field installation. Matching dummy handle sets are included for French Door applications. Optional multipoint lock systems are factory installed securing the active panel at three points. The system is manually activated from the handle.

GRILLES

SDL (Simulated Divided Lites) - extruded aluminum muntins permanently applied to the exterior of the insulating glass unit (not available on textured glass) in 5/8", 7/8", 1-1/8", or 1-3/8" widths. Profiles are bead stop in all widths, and a putty profile in 5/8", 7/8", and 1-1/8" widths only. 1" Copper SDL is also available. SDL is standard with a light bronze internal shadow bar to give a true divided lite appearance. As an option, SDL may be ordered with a silver shadow bar. Clear wood interior muntin bars match the exterior muntin width and are permanently bonded to the interior of the glass. Also available is a 2-5/16" SDL bar, which simulates a double-hung checkrail.

Full-Surround Removable Wood Grilles - Rectangular, unfinished interior clear pine wood grilles in 7/8", 1-1/8", and 1-3/8" are available in patterns selected by the owner.

GBG (Grilles between the Glass) - 5/8" flat, 23/32" contour, or 1" contour grilles mounted between the glass panes suspended within the air cavity.

EXTERIOR TRIM

Nail flange and drip cap standard with optional extruded aluminum brickmould, 3-1/2" flat, 3-1/2" Adams and Heritage trims. Optional mull covers to accommodate 1" (spread only), 2", 3-1/2" and 6" spread and stud pocket mull.

EXTENSION JAMBS

Extension jambs are available for wall depths up to 6-11/16".

Continued on next page

PRODUCT SPECIFICATIONS

INSTALLATION

Installation per JELD-WEN Installation Method for Metal Clad Patio Doors. See www.jeld-wen.com/resources for instructions.

PERFORMANCE

ANSI/AAMA/NWDA/101/I.S.2-97
AMMA/WDMA/CSA 101/I.S.2/A440-05
WDMA Hallmark Certified

See www.jeld-wen.com for architectural and performance information.

QUICK SPEC GUIDE

SPECIFICATION	STANDARD FEATURES	OPTIONAL FEATURES <i>Some options may require additional lead times. Consult your JELD-WEN Sales Representative.</i>	
EXTERIOR FINISH	<ul style="list-style-type: none"> • Brilliant White • Chestnut Bronze • Desert Sand • French Vanilla • Mesa Red • Hartford Green • Black Licorice • Heirloom White • Hunter Green • Redwood • Sage Brown • Smoke • Artic Silver • Dark Chocolate • Black Emerald • Bone White • Bronze • Buckskin • Cambridge White • Capri Blue • Cascade 	<ul style="list-style-type: none"> • Champagne • Clover Mist • Dark Buckskin • Dark Ivy • Deep Summer • Garnet • Haverstraw • Hudson Blue • Ivory • Ivy • Liberty Blue • Mocha Cream • Mosaic Green • Pueblo Tan • Rosewood • Scarlet Haze • Sea Foam • Teal • Wedgewood • White 	<ul style="list-style-type: none"> • Custom Color Matching <div style="border: 1px solid black; padding: 5px; margin-top: 10px;"> <p>Panel Only:</p> <ul style="list-style-type: none"> • Bright Copper • Speckled Patina Copper • Hand Rubbed Patina Copper </div>
EXTERIOR TRIM	<ul style="list-style-type: none"> • Drip Cap & Integral Nailing Fin 	<ul style="list-style-type: none"> • Extruded Aluminum Brickmould • Adams Casing 	<ul style="list-style-type: none"> • 3-1/2" Flat Casing • Heritage Casing • Folding Nailing Fin
INTERIOR WOOD	<ul style="list-style-type: none"> • Western Pine 	<ul style="list-style-type: none"> • Knotty Alder • Vertical Grain Douglas Fir • Mahogany 	
INTERIOR FINISH	<ul style="list-style-type: none"> • Natural 	<ul style="list-style-type: none"> • Priming Available <p>Pre-finished Interior Options are:</p> <ul style="list-style-type: none"> • Paint - Pure White, Extra White, Natural Choice, Moderate White • Stain - Wheat, Fruitwood, Cherry, Cordovan, Cider • Clear Lacquer 	
SIZE	<ul style="list-style-type: none"> • Width: 2-0, 2-6, 2-8, 3-0, 3-6, 5-0, 5-4, 6-0, 7-6, 8-0, 9-0 • Height: 6-8, 7-0, 8-0, 9-0 	<ul style="list-style-type: none"> • Any Panel Width: 2-0 to 3-6 (Certain restrictions apply) • Any Panel Height: 4-0 to 10-0 (Certain restrictions apply) 	
GLAZING (ALL TEMPERED)	<ul style="list-style-type: none"> • Low-E Tempered Insulating Glass (with Argon) • Low-E 366 • Preserve® Protective Film 	<ul style="list-style-type: none"> • Clear • Obscure • Tints: Bronze, Gray, Green • Reflective: Bronze and Gray • Glue Chip • Safety Laminate in Clear, Bronze or Gray 	<ul style="list-style-type: none"> • Neat Glass • Seedy Reamy • Rain • Narrow Reed • Sandblasted • Tempered • Impact Resistant
		<ul style="list-style-type: none"> • High Altitude (Breather Tube, no Argon) 	

Continued on next page

QUICK SPEC GUIDE

SPECIFICATION	STANDARD FEATURES	OPTIONAL FEATURES <i>Some options may require additional lead times. Consult your JELD-WEN Sales Representative.</i>
GRILLES		SDL Bead Profile: <ul style="list-style-type: none"> • 5/8", 7/8", 1-1/8", 1-3/8", 2-5/16" with Light Bronze Shadow Bar • 5/8", 7/8", 1-1/8", 1-3/8", 2-5/16" with Silver Shadow Bar SDL Putty Profile: <ul style="list-style-type: none"> • 5/8", 7/8" and 1-1/8" with Light Bronze Shadow Bar • 5/8", 7/8" and 1-1/8" with Silver Shadow Bar • 1" Copper SDL GBG (Grilles between the Glass): <ul style="list-style-type: none"> • 5/8" Flat, 23/32" Contour, 1" Contour Full-Surround: <ul style="list-style-type: none"> • 7/8", 1-1/8", 1-3/8"
HARDWARE	<ul style="list-style-type: none"> • 4 x 4 Heavy Gauge Hinges • Single Point Mortise Lock with Lever Handle 	<ul style="list-style-type: none"> • Adjustable Hinges • Multipoint Manually Activated Lock
HARDWARE COLOR	<ul style="list-style-type: none"> • Polished Brass 	<ul style="list-style-type: none"> • Antique Brass • Polished Chrome • Brushed Chrome • Oil-Rubbed Bronze • White Powder Coat • Black Powder Coat
JAMB	<ul style="list-style-type: none"> • Applied, 5/4 • 4-9/16" 	<ul style="list-style-type: none"> • Up to 6-11/16"* <p><i>*6-11/16" only available with Folding Nailing Flange option</i></p>

GENERAL INFORMATION

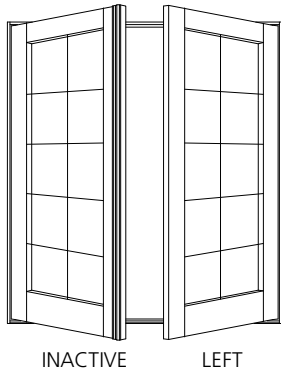

DIMENSIONAL DOORS

Clad out-swing patio doors may be specified as "dimensional" by adjusting the desired rough opening width or height in 1/4" increments from standard.

Clad out-swing patio doors are available in single, twin, triple and quad panel doors. Transoms are available to match the variety of door sizes. The standard size range includes sizes specifically designed for replacement of older patio door models in existing structures, as well as a full range of "true size" products for architectural consistency.

OPERATION

Clad out-swing patio doors are available in a full range of operating styles. Single panel doors may be specified as stationary (non-venting) or can operate left or right. Center swing two- or three-panel doors are available with left or right operation. French doors feature two operating panels (one active, which opens first; and one inactive, which closes first), and are available in two-panel and four-panel styles. Configuration and handing is based on viewing the door from the exterior.

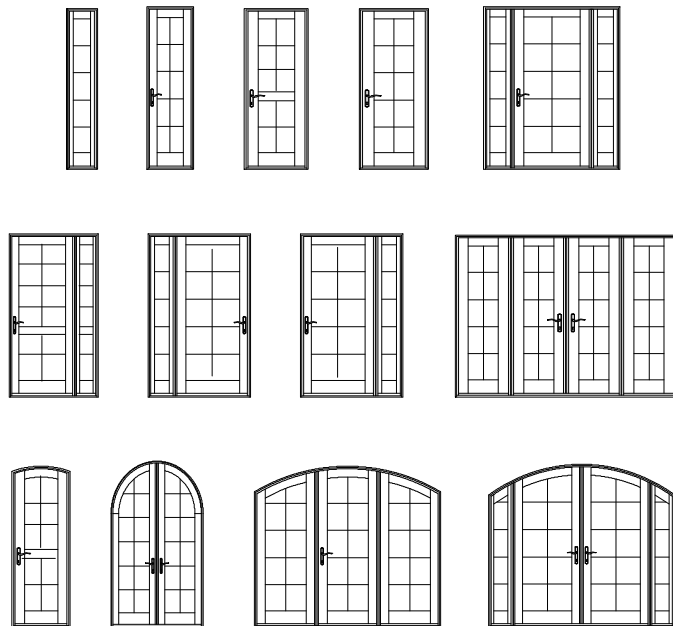

MULTIPLE ASSEMBLIES

Clad out-swing patio doors are available in a wide variety of multiple panel configurations from the factory, all of which are assembled with continuous sills. Clad out-swing patio doors may be mulled below or beside other clad door and clad window products. Factory assembled mulls are limited in height (100"), width (150"), and a total area (75 square feet).

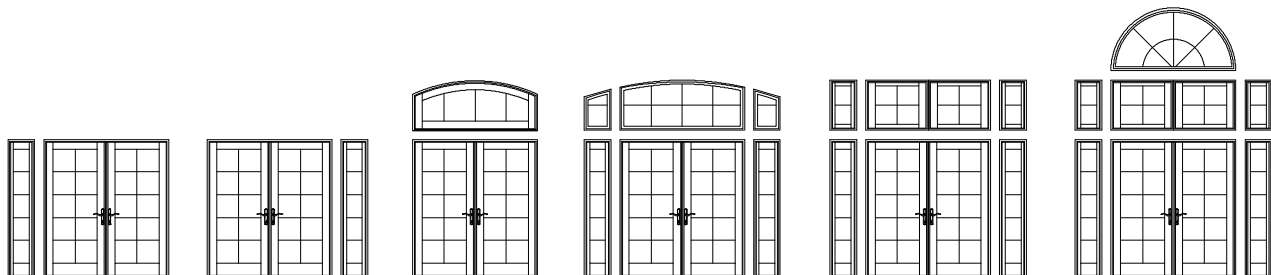

ELEVATION NOTES

ELEVATION DRAWINGS UTILIZE A LIMITED NUMBER OF PROJECTED LINES TO PRODUCE A RUDIMENTARY DRAWING INTENDED TO BE USED IN A SMALL GRAPHICAL SCALE. ELEVATIONS ARE VIEWED PERPENDICULAR FROM THE EXTERIOR OF THE STRUCTURE. IF MORE DIMENSIONS ARE NEEDED, USE THE SECTION DRAWINGS FOR MORE COMPLETE DEPICTIONS.

M.O. Brickmould	41 1/4" [1048]	Masonry Openings for Brickmould, Flat & Adams Casing. Vertical measurements for transoms include sill nose. (Subtract 1/2" from Masonry Opening for Unit Size)
M.O. Adams/Flat Casing	44 5/16" [1126]	
Rough Opening	38 3/4" [984]	
Frame Size	38" [365]	
Glass Size	26 5/8" [676]	

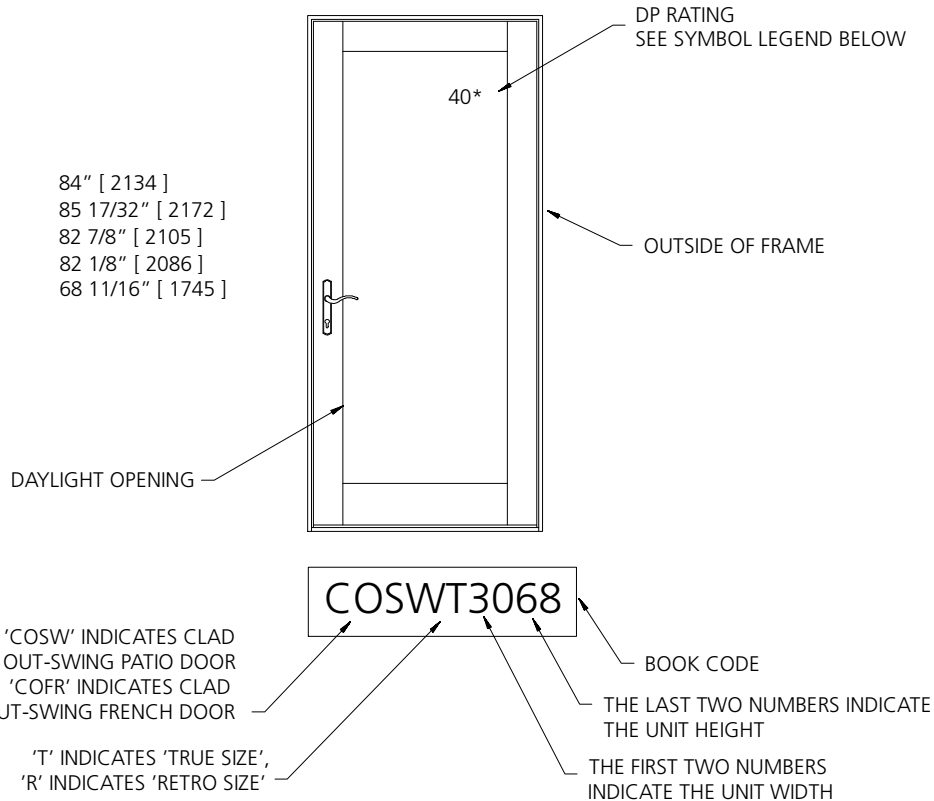

GENERAL SWINGING DOOR NOTES

1. CLAD OUT-SWING PATIO DOOR (COSW / COFR) UNITS ARE AVAILABLE AS OPERATING OR STATIONARY UNITS.
2. UNIT ELEVATIONS ARE SHOWN WITHOUT EXTERIOR TRIM. UNIT SIZES & MASONRY OPENING DIMENSIONS WILL CHANGE WITH THE ADDITION OF EXTERIOR TRIM. SEE THE 'UNIT SIZING, ROUGH OPENINGS & MASONRY OPENINGS' PAGE FOR EXTERIOR TRIM EFFECTS.
3. OPERATING UNITS ARE AVAILABLE AS LEFT OR RIGHT HAND OPERATION.
4. HANDICAP SILL, 10 1/4" BOTTOM RAILS, INTERMEDIATE LOCK RAILS AND RAISED PANELS ARE AVAILABLE FOR ALL UNITS.

ELEVATION SYMBOL LEGEND:

- S** PANEL IS AVAILABLE AS STATIONARY ONLY.
- ##*** NUMBER INDICATES DESIGN PRESSURE (DP) RATING WITH STANDARD GLAZING. OPERATING UNITS UTILIZE MULTI-POINT LOCKING HARDWARE FOR DP RATINGS.

1-PANEL UNITS

M.O. BRICKMOULD
M.O. ADAMS/FLAT CASING
ROUGH OPENING
FRAME SIZE
DAYLIGHT OPENING

27 1/4" [692]
 30 5/16" [770]
 24 3/4" [629]
 24" [610]
 12 5/8" [321]

33 1/4" [845]
 36 5/16" [922]
 30 3/4" [781]
 30" [762]
 18 5/8" [473]

35 1/4" [895]
 38 5/16" [973]
 32 3/4" [832]
 32" [813]
 20 5/8" [524]

39 1/4" [997]
 42 5/16" [1075]
 36 3/4" [933]
 36" [914]
 24 5/8" [627]

81" [2057]
 82 17/32" [2096]
 79 7/8" [2029]
 79 1/8" [2010]
 65 11/16" [1668]

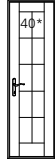

COSWR2068

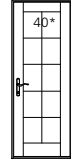

COSWR2668

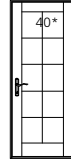

COSWR2868

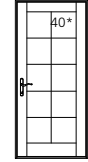

COSWR3068

97" [2464]
 98 17/32" [2503]
 95 7/8" [2435]
 95 1/8" [2416]
 81 1/16" [2075]

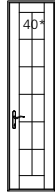

COSWR2080

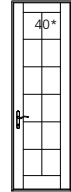

COSWR2680

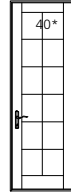

COSWR2880

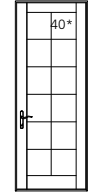

COSWR3080

109" [2769]
 110 17/32" [2807]
 107 7/8" [2740]
 107 1/8" [2721]
 93 11/16" [2380]

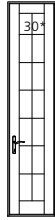

COSWR2090

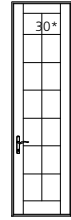

COSWR2690

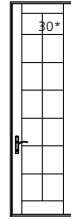

COSWR2890

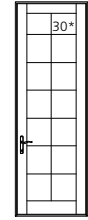

COSWR3090

ELEVATION SYMBOL LEGEND:

M.O. = MASONRY OPENING
 VALUES IN () ARE NUMBER OF DAYLIGHT OPENINGS PER UNIT.
 VALUES IN [] ARE IN MILLIMETER CONVERSIONS.

S PANEL IS AVAILABLE AS STATIONARY ONLY.

NUMBER INDICATES DESIGN PRESSURE (DP) RATING WITH STANDARD GLAZING. OPERATING UNITS UTILIZE MULTI-POINT LOCKING HARDWARE FOR DP RATINGS.

Note: Elevations shown DO NOT have exterior trim. Subtract 1/2" (12.7) from M.O. (Masonry Opening) for Unit Size. For other Trim Options refer to the Unit Sizing, Rough Opening & Masonry Openings page.

M.O. BRICKMOULD
M.O. ADAMS/FLAT CASING
ROUGH OPENING
FRAME SIZE
DAYLIGHT OPENING

17 3/8" [441]
 20 7/16" [519]
 14 7/8" [378]
 14 1/8" [359]
 7 1/2" [190]

19 3/8" [492]
 22 7/16" [570]
 16 7/8" [429]
 16 1/8" [410]
 9 1/2" [241]

21 3/8" [543]
 24 7/16" [621]
 18 7/8" [479]
 18 1/8" [460]
 11 1/2" [292]

29 1/4" [743]
 32 5/16" [821]
 26 3/4" [679]
 26" [660]
 14 5/8" [368]

35 1/4" [895]
 38 5/16" [973]
 32 3/4" [832]
 32" [813]
 20 5/8" [524]

37 1/4" [946]
 40 5/16" [1024]
 34 3/4" [883]
 34" [864]
 22 5/8" [571]

41 1/4" [1048]
 44 5/16" [1126]
 38 3/4" [984]
 38" [965]
 26 5/8" [676]

47 1/4" [1200]
 50 5/16" [1278]
 44 3/4" [1137]
 44" [1118]
 32 5/8" [829]

84" [2134]
 85 17/32" [2172]
 82 7/8" [2105]
 68 1/8" [2086]
 68 11/16" [1745]

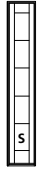

COSWT1068



COSWT1268



COSWT1468

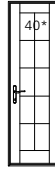

COSWT2068

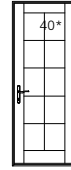

COSWT2668

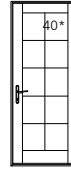

COSWT2868

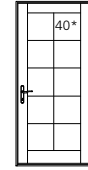

COSWT3068

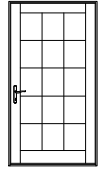

COSWT3668

88" [2235]
 89 17/32" [2274]
 86 7/8" [2206]
 86 1/8" [2188]
 72 11/16" [1846]

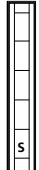

COSWT1070



COSWT1270



COSWT1470

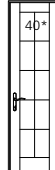

COSWT2070

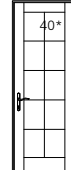

COSWT2670

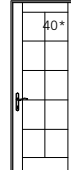

COSWT2870

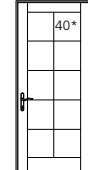

COSWT3070

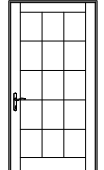

COSWT3670

100" [2540]
 101 17/32" [2579]
 98 7/8" [2511]
 98 1/8" [2492]
 84 11/16" [2151]

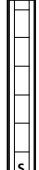

COSWT1080

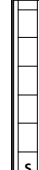

COSWT1280



COSWT1480

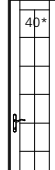

COSWT2080

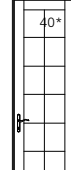

COSWT2680

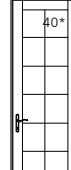

COSWT2880

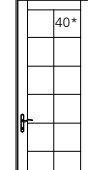

COSWT3080

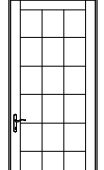

COSWT3680

112" [2845]
 113 17/32" [2884]
 110 7/8" [2816]
 110 1/8" [2797]
 96 11/16" [2456]

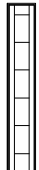

COSWT1090



COSWT1290



COSWT1490

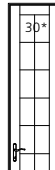

COSWT2090

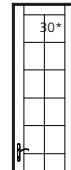

COSWT2690

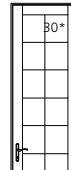

COSWT2890

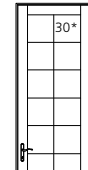

COSWT3090

SCALE: 1/8" = 1'

2-PANEL UNITS

**M.O. BRICKMOULD
M.O. ADAMS/FLAT CASING
ROUGH OPENING
FRAME SIZE
DAYLIGHT OPENING**

62 7/16" [1586]
65 1/2" [1664]
59 15/16" [1522]
59 3/16" [1503]
18 5/8" [473] (2)

81" [2057]
82 17/32" [2096]
79 7/8" [2029]
79 1/8" [2010]
65 11/16" [1668]

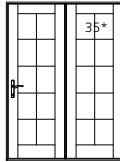

COSWR5068

97" [2464]
98 17/32" [2503]
95 7/8" [2435]
95 1/8" [2416]
81 11/16" [2075]

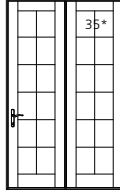

COSWR5080

109" [2769]
110 17/32" [2807]
107 7/8" [2740]
107 1/8" [2721]
93 11/16" [2380]

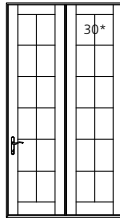

COSWR5090

**M.O. BRICKMOULD
M.O. ADAMS/FLAT CASING
ROUGH OPENING
FRAME SIZE
DAYLIGHT OPENING**

66 7/16" [1688]
69 1/2" [1765]
63 15/16" [1624]
63 3/16" [1605]
20 5/8" [524] (2)

84" [2134]
85 17/32" [2172]
82 7/8" [2105]
82 1/8" [2086]
68 11/16" [1745]

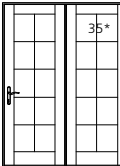

COSWT5068

88" [2235]
89 17/32" [2274]
86 7/8" [2207]
86 1/8" [2188]
72 11/16" [1846]

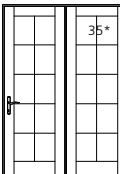

COSWT5070

100" [2540]
101 17/32" [2579]
98 7/8" [2511]
98 1/8" [2492]
84 11/16" [2151]

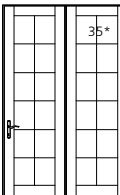

COSWT5080

112" [2845]
113 17/32" [2884]
110 7/8" [2816]
110 1/8" [2797]
96 11/16" [2456]

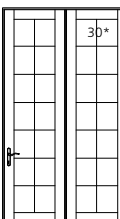

COSWT5090

66 7/16" [1688]
69 1/2" [1765]
63 15/16" [1624]
63 3/16" [1605]
20 5/8" [524] (2)

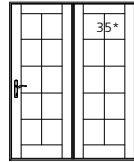

COSWR5468

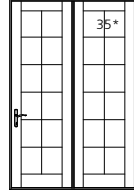

COSWR5480

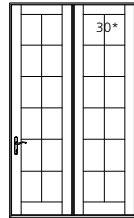

COSWR5490

70 7/16" [1789]
73 1/2" [1867]
67 15/16" [1726]
67 3/16" [1707]
22 5/8" [575] (2)

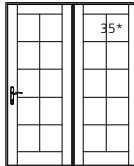

COSWT5468

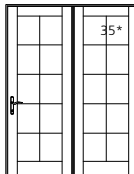

COSWT5470

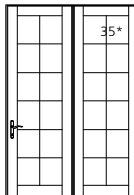

COSWT5480

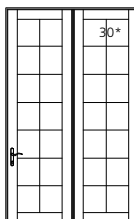

COSWT5490

74 7/16" [1891]
77 1/2" [1969]
71 15/16" [1827]
71 3/16" [1808]
24 5/8" [625] (2)

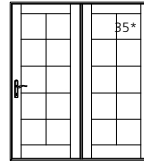

COSWR6068

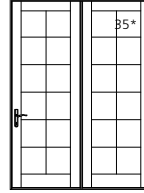

COSWR6080

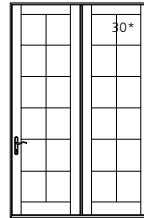

COSWR6090

78 7/16" [1992]
81 1/2" [2070]
75 15/16" [1929]
75 3/16" [1910]
26 5/8" [676] (2)

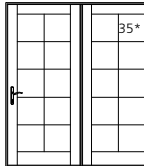

COSWT6068

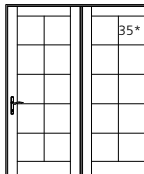

COSWT6070

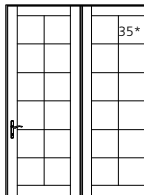

COSWT6080

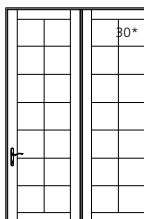

COSWT6090

90 7/16" [2297]
93 1/2" [2375]
87 15/16" [2234]
87 3/16" [2215]
32 5/8" [829] (2)

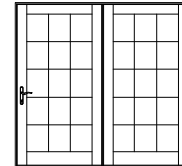

COSWT7068

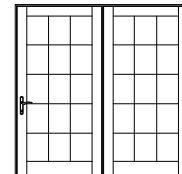

COSWT7070

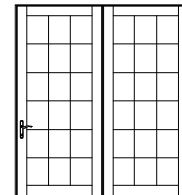

COSWT7080

ELEVATION SYMBOL LEGEND:

M.O. = MASONRY OPENING
VALUES IN () ARE NUMBER OF DAYLIGHT OPENINGS PER UNIT.
VALUES IN [] ARE IN MILLIMETER CONVERSIONS.
NUMBER INDICATES DESIGN PRESSURE (DP) RATING WITH STANDARD GLAZING. OPERATING UNITS UTILIZE MULTI-POINT LOCKING HARDWARE FOR DP RATINGS.

Note: Elevations shown DO NOT have exterior trim. Subtract 1/2" (12.7) from M.O. (Masonry Opening) for Unit Size. For other Trim Options refer to the Unit Sizing, Rough Opening & Masonry Openings page.

SCALE: 1/8" = 1'

3-PANEL UNITS

M.O. BRICKMOULD
M.O. ADAMS/FLAT CASING
ROUGH OPENING
FRAME SIZE
DAYLIGHT OPENING

91 5/8" [2327]
94 11/16" [2405]
89 1/8" [2264]
88 3/8" [2245]
18 3/8" [473] (3)

97 5/8" [2480]
100 11/16" [2557]
95 1/8" [2416]
94 3/8" [2397]
20 5/8" [524] (3)

109 5/8" [2784]
112 11/16" [2862]
107 1/8" [2721]
106 3/8" [2702]
24 5/8" [625] (3)

81" [2057]
82 17/32" [2096]
79 7/8" [2029]
79 1/8" [2010]
65 11/16" [1668]

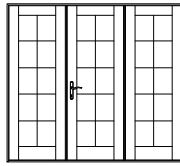

COSWR7668

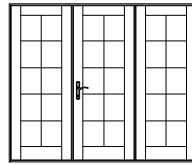

COSWR8068

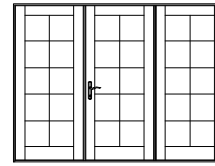

COSWR9068

97" [2464]
98 17/32" [2503]
95 7/8" [2435]
95 1/8" [2416]
81 11/16" [2075]

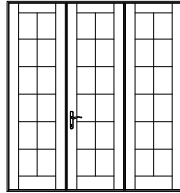

COSWR7680

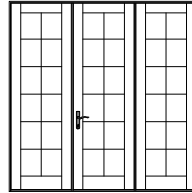

COSWR8080

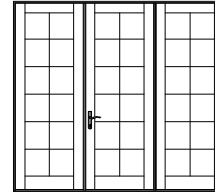

COSWR9080

109" [2769]
110 17/32" [2807]
107 7/8" [2740]
107 1/8" [2721]
93 11/16" [2380]

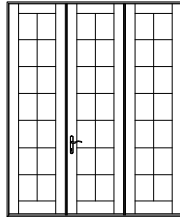

COSWR7690

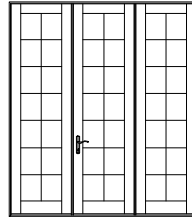

COSWR8090

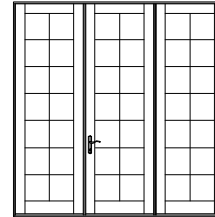

COSWR9090

M.O. BRICKMOULD
M.O. ADAMS/FLAT CASING
ROUGH OPENING
FRAME SIZE
DAYLIGHT OPENING

97 5/8" [2480]
100 11/16" [2557]
95 1/8" [2416]
94 3/8" [2397]
20 5/8" [524] (3)

103 5/8" [2632]
106 11/16" [2710]
101 1/8" [2569]
100 3/8" [2550]
22 5/8" [575] (3)

115 5/8" [2937]
118 11/16" [3015]
113 1/8" [2873]
112 3/8" [2854]
26 5/8" [676] (3)

84" [2134]
85 17/32" [2172]
82 7/8" [2105]
82 1/8" [2086]
68 11/16" [1745]

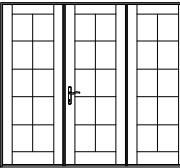

COSWT7668

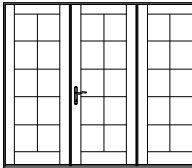

COSWT8068

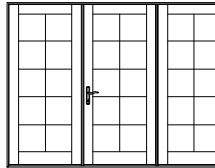

COSWT9068

88" [2235]
89 17/32" [2274]
86 7/8" [2206]
86 1/8" [2188]
72 11/16" [1846]

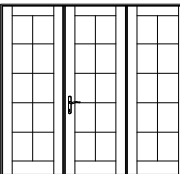

COSWT7670

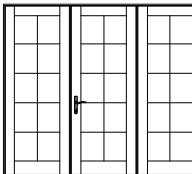

COSWT8070

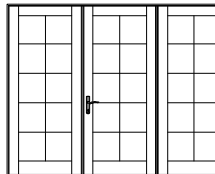

COSWT9070

100" [2540]
101 17/32" [2579]
97 7/8" [2511]
98 1/8" [2492]
84 11/16" [2151]

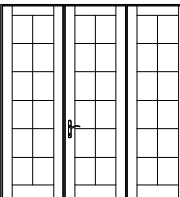

COSWT7680

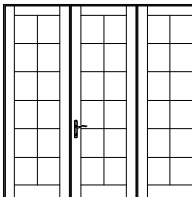

COSWT8080

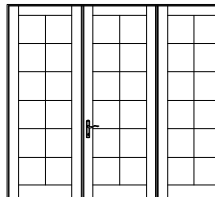

COSWT9080

112" [2845]
113 17/32" [2884]
110 1/8" [2816]
110 1/8" [2797]
96 11/16" [2456]

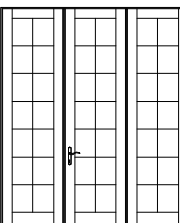

COSWT7690

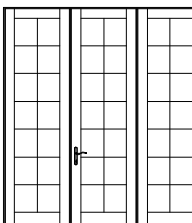

COSWT8090

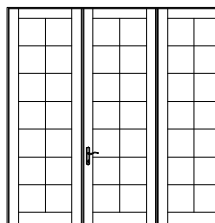

COSWT9090

ELEVATION SYMBOL LEGEND:
M.O. = MASONRY OPENING
VALUES IN () ARE NUMBER OF DAYLIGHT OPENINGS PER UNIT.
VALUES IN [] ARE IN MILLIMETER CONVERSIONS.

Note: Elevations shown DO NOT have exterior trim. Subtract 1/2" (12.7) from M.O. (Masonry Opening) for Unit Size. For other Trim Options refer to the Unit Sizing, Rough Opening & Masonry Openings page.

SCALE: 1/8" = 1'

2-PANEL FRENCH UNITS

M.O. BRICKMOULD
M.O. ADAMS/FLAT CASING
ROUGH OPENING
FRAME SIZE
DAYLIGHT OPENING

50 7/16" [1281]
 53 1/2" [1359]
 47 15/16" [1218]
 47 3/16" [1199]
 12 5/8" [321] (2)

62 7/16" [1586]
 65 1/2" [1664]
 59 15/16" [1522]
 59 3/16" [1503]
 18 5/8" [473] (2)

66 7/16" [1688]
 69 1/2" [1765]
 63 15/16" [1624]
 63 3/16" [1605]
 20 5/8" [524] (2)

74 7/16" [1891]
 77 1/2" [1969]
 71 15/16" [1827]
 71 3/16" [1808]
 24 5/8" [625] (2)

81" [2057]
 82 17/32" [2096]
 79 7/8" [2029]
 79 1/8" [2010]
 65 11/16" [1668]

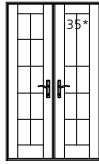

COFRR4068

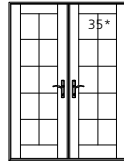

COFRR5068

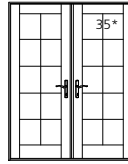

COFRR5468

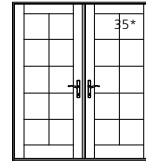

COFRR6068

97" [2464]
 98 17/32" [2503]
 95 7/8" [2435]
 95 1/8" [2416]
 81 11/16" [2075]

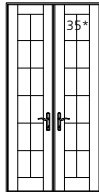

COFRR4080

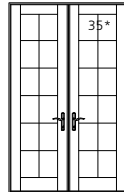

COFRR5080

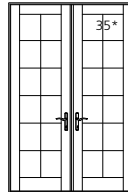

COFRR5480

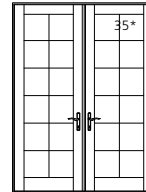

COFRR6080

109" [2769]
 110 17/32" [2807]
 107 7/8" [2740]
 107 1/8" [2721]
 93 11/16" [2380]

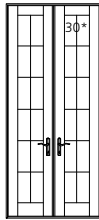

COFRR4090

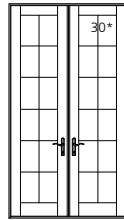

COFRR5090

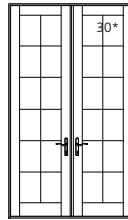

COFRR5490

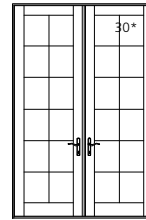

COFRR6090

M.O. BRICKMOULD
M.O. ADAMS/FLAT CASING
ROUGH OPENING
FRAME SIZE
DAYLIGHT OPENING

54 7/16" [1382]
 57 1/2" [1461]
 51 15/16" [1319]
 51 3/16" [1300]
 14 5/8" [371] (2)

66 7/16" [1688]
 69 1/2" [1765]
 63 15/16" [1624]
 63 3/16" [1605]
 20 5/8" [524] (2)

70 7/16" [1789]
 73 1/2" [1867]
 67 15/16" [1726]
 67 3/16" [1707]
 22 5/8" [575] (2)

78 7/16" [1992]
 81 1/2" [2070]
 75 15/16" [1929]
 75 3/16" [1910]
 26 5/8" [676] (2)

90 7/16" [2297]
 93 1/2" [2375]
 87 15/16" [2234]
 87 3/16" [2215]
 32 5/8" [829] (2)

84" [2134]
 85 17/32" [2172]
 82 7/8" [2105]
 82 1/8" [2086]
 68 11/16 [1745]

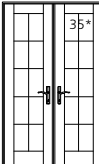

COFRT4068

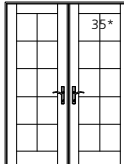

COFRT5068

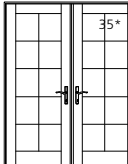

COFRT5468

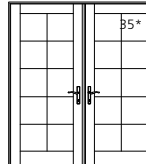

COFRT6068

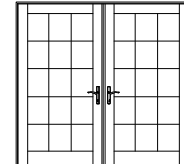

COFRT7068

88" [2235]
 89 17/32" [2274]
 86 7/8" [2207]
 86 1/8" [2188]
 72 11/16" [1846]

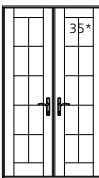

COFRT4070

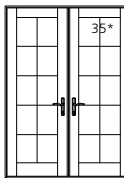

COFRT5070

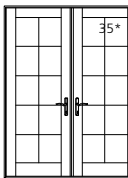

COFRT5470

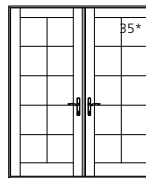

COFRT6070

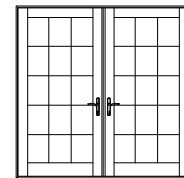

COFRT7070

100" [2540]
 101 17/32" [2579]
 98 7/8" [2511]
 98 1/8" [2492]
 84 11/16" [2151]

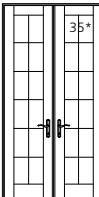

COFRT4080

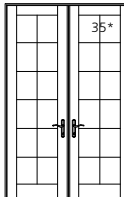

COFRT5080

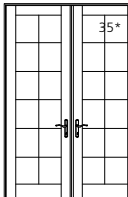

COFRT5480

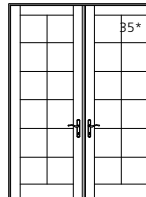

COFRT6080

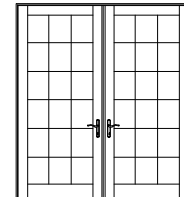

COFRT7080

112" [2845]
 113 17/32" [2884]
 110 7/8" [2816]
 110 1/8" [2797]
 96 11/16" [2456]

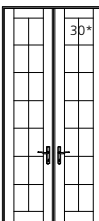

COFRT4090

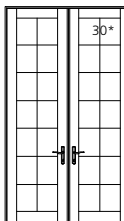

COFRT5090

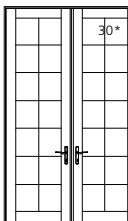

COFRT5490

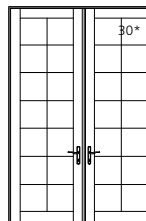

COFRT6090

ELEVATION SYMBOL LEGEND:
M.O. = MASONRY OPENING
 VALUES IN () ARE NUMBER OF DAYLIGHT OPENINGS PER UNIT.
 VALUES IN [] ARE IN MILLIMETER CONVERSIONS.
= NUMBER INDICATES DESIGN PRESSURE (DP) RATING
 WITH STANDARD GLAZING. OPERATING UNITS UTILIZE
 MULTI-POINT LOCKING HARDWARE FOR DP RATINGS.

Note: Elevations shown DO NOT have exterior trim. Subtract 1/2" (12.7) from M.O. (Masonry Opening) for Unit Size. For other Trim Options refer to the Unit Sizing, Rough Opening & Masonry Openings page.

SCALE: 1/8" = 1'

4-PANEL FRENCH UNITS

M.O. BRICKMOULD
M.O. ADAMS/FLAT CASING
ROUGH OPENING
FRAME SIZE
DAYLIGHT OPENING

96 13/16" [2459]
99 7/8" [2537]
94 5/16" [2396]
93 9/16" [2376]
12 5/8" [321] (4)

120 13/16" [3069]
123 7/8" [3146]
118 5/16" [3005]
117 9/16" [2986]
18 5/8" [473] (4)

144 13/16" [3678]
147 7/8" [3756]
142 5/16" [3615]
141 9/16" [3596]
24 5/8" [625] (4)

81" [2057]
82 17/32" [2096]
79 7/8" [2029]
79 1/8" [2010]
65 11/16" [1668]

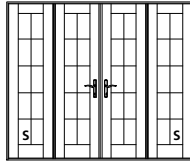

COFRR8068

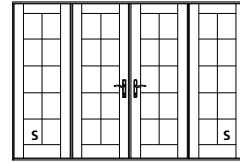

COFRR10068

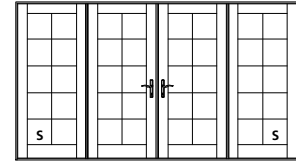

COFRR12068

97" [2464]
98 17/32" [2503]
95 7/8" [2435]
95 1/8" [2416]
81 11/16" [2075]

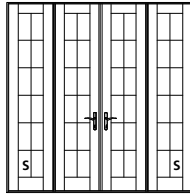

COFRR8080

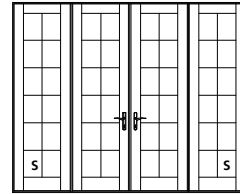

COFRR10080

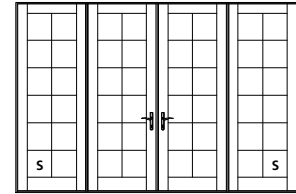

COFRR12080

103" [2769]
110 17/32" [2807]
107 7/8" [2740]
107 1/8" [2721]
93 11/16" [2380]

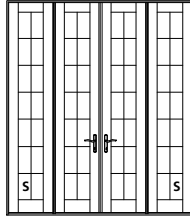

COFRR8090

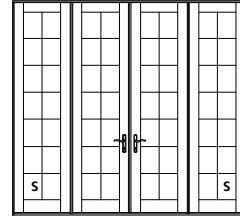

COFRR10090

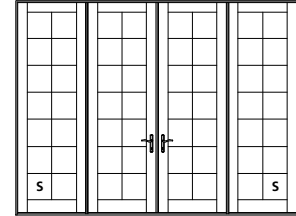

COFRR12090

M.O. BRICKMOULD
M.O. ADAMS/FLAT CASING
ROUGH OPENING
FRAME SIZE
DAYLIGHT OPENING

104 13/16" [2662]
107 7/8" [2740]
102 5/16" [2599]
101 9/16" [2580]
14 5/8" [371] (4)

128 13/16" [3272]
131 7/8" [3350]
126 5/16" [3208]
125 9/16" [3189]
20 5/8" [524] (4)

152 13/16" [3881]
155 7/8" [3959]
150 5/16" [3818]
149 9/16" [3799]
26 5/8" [676] (4)

84" [2134]
85 17/32" [2172]
82 7/8" [2105]
82 1/8" [2086]
68 11/16" [1745]

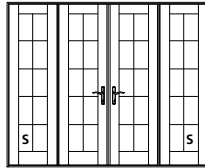

COFRT8068

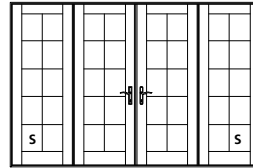

COFRT10068

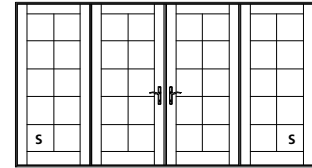

COFRT12068

88" [2235]
89 17/32" [2274]
86 7/8" [2206]
86 1/8" [2188]
72 11/16" [1846]

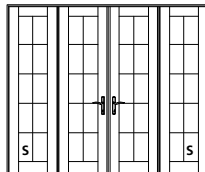

COFRT8070

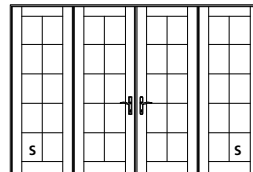

COFRT10070

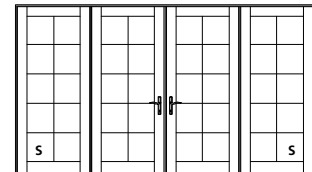

COFRT12070

100" [2540]
101 17/32" [2579]
98 7/8" [2511]
98 1/8" [2492]
84 11/16" [2151]

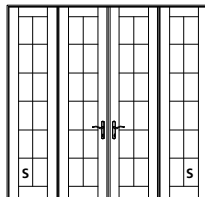

COFRT8080

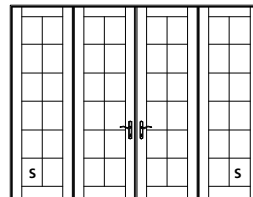

COFRT10080

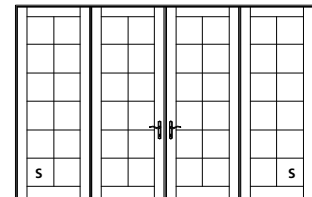

COFRT12080

112" [2845]
113 17/32" [2884]
110 7/8" [2816]
110 1/8" [2797]
96 11/16" [2456]

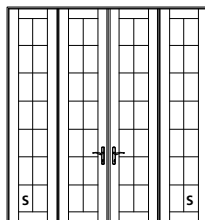

COFRT8090

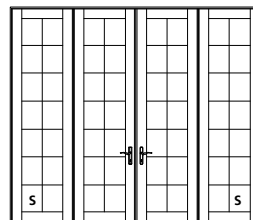

COFRT10090

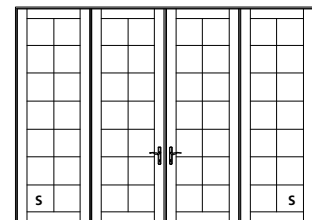

COFRT12090

ELEVATION SYMBOL LEGEND:

M.O. = MASONRY OPENING
VALUES IN () ARE NUMBER OF DAYLIGHT OPENINGS PER UNIT.
VALUES IN [] ARE IN MILLIMETER CONVERSIONS.
S PANEL IS AVAILABLE AS STATIONARY ONLY.

Note: Elevations shown DO NOT have exterior trim. Subtract 1/2" (12.7) from M.O. (Masonry Opening) for Unit Size. For other Trim Options refer to the Unit Sizing, Rough Opening & Masonry Openings page.

SCALE: 1/8" = 1'

SINGLE DOOR WITH SINGLE SIDELITE

M.O. BRICKMOULD	54 9/16" [1386]	56 9/16" [1437]	58 9/16" [1487]
M.O. ADAMS/FLAT CASING	57 5/8" [1464]	59 5/8" [1514]	61 5/8" [1565]
ROUGH OPENING	52 1/16" [1322]	54 1/16" [1373]	56 1/16" [1424]
FRAME SIZE	51 5/16" [1303]	53 5/16" [1354]	55 5/16" [1405]
DAYLIGHT OPENING	26 5/8" [676] - 7 1/2" [190]	26 5/8" [676] - 9 1/2" [241]	26 5/8" [676] - 11 1/2" [292]

84" [2134]
85 17/32" [2172]
87 7/8" [2105]
82 1/8" [2086]
68 11/16" [1745]

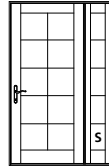

COSWT3068B10

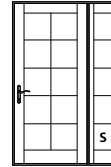

COSWT3068B12

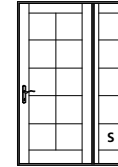

COSWT3068B14

88" [2235]
89 17/32" [2274]
86 7/8" [2206]
86 1/8" [2188]
72 11/16" [1846]

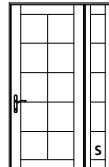

COSWT3070B10

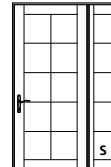

COSWT3070B12

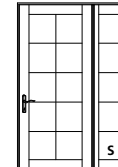

COSWT3070B14

100" [2540]
101 17/32" [2579]
98 7/8" [2511]
98 1/8" [2492]
84 11/16" [2151]

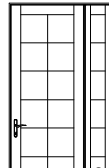

COSWT3080B10

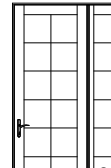

COSWT3080B12

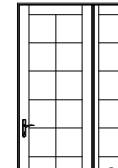

COSWT3080B14

112" [2845]
113 17/32" [2884]
110 7/8" [2816]
110 1/8" [2797]
96 11/16" [2456]

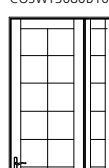

COSWT3090B10

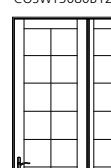

COSWT3090B12

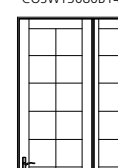

COSWT3090B14

M.O. BRICKMOULD	60 9/16" [1538]	62 9/16" [1589]	64 9/16" [1640]
M.O. ADAMS/FLAT CASING	63 5/8" [1616]	65 5/8" [1667]	67 5/8" [1718]
ROUGH OPENING	58 1/16" [1475]	60 1/16" [1526]	62 1/16" [1576]
FRAME SIZE	57 5/16" [1456]	59 5/16" [1507]	61 5/16" [1557]
DAYLIGHT OPENING	32 5/8" [829] - 7 1/2" [190]	32 5/8" [829] - 9 1/2" [241]	32 5/8" [829] - 11 1/2" [292]

84" [2134]
85 17/32" [2172]
87 7/8" [2105]
82 1/8" [2086]
68 11/16" [1745]

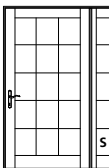

COSWT3668B10

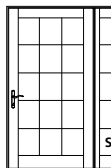

COSWT3668B12

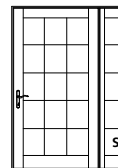

COSWT3668B14

88" [2235]
89 17/32" [2274]
86 7/8" [2206]
86 1/8" [2188]
72 11/16" [1846]

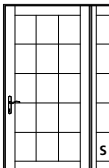

COSWT3670B10

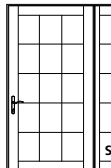

COSWT3670B12

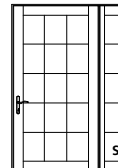

COSWT3670B14

100" [2540]
101 17/32" [2579]
98 7/8" [2511]
98 1/8" [2492]
84 11/16" [2151]

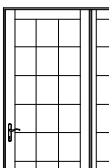

COSWT3680B10

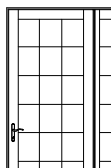

COSWT3680B12

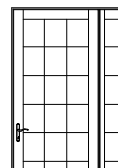

COSWT3680B14

ELEVATION SYMBOL LEGEND:
M.O. = MASONRY OPENING
VALUES IN () ARE NUMBER OF DAYLIGHT OPENINGS PER UNIT.
VALUES IN [] ARE IN MILLIMETER CONVERSIONS.
S = PANEL IS AVAILABLE AS STATIONARY ONLY.

Note: Elevations shown DO NOT have exterior trim.
Subtract 1/2" (12.7) from M.O. (Masonry Opening)
for Unit Size. For other Trim Options refer to the Unit
Sizing, Rough Opening & Masonry Openings page.

SCALE: 1/8" = 1'

SINGLE DOOR WITH TWO SIDELITES

M.O. BRICKMOULD
M.O. ADAMS/FLAT CASING
ROUGH OPENING
FRAME SIZE
DAYLIGHT OPENING

67 7/8" [1724]	71 7/8" [1826]	75 7/8" [1927]
70 15/16" [1802]	74 15/16" [1903]	78 15/16" [2005]
65 3/8" [1661]	69 3/8" [1762]	73 3/8" [1864]
64 5/8" [1641]	68 5/8" [1743]	72 5/8" [1845]
26 5/8" [676] - 7 1/2" [190] (2)	26 5/8" [676] - 9 1/2" [241] (2)	26 5/8" [676] - 11 1/2" [292] (2)

84" [2134]
85 17/32" [2172]
82 7/8" [2105]
82 1/8" [2086]
68 11/16" [1745]

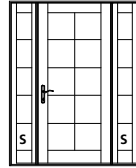

COSWT3068F10

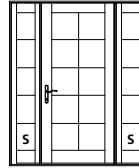

COSWT3068F12

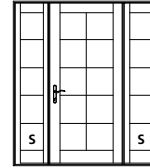

COSWT3068F14

88" [2235]
89 17/32" [2274]
86 7/8" [2206]
86 1/8" [2188]
72 11/16" [1846]

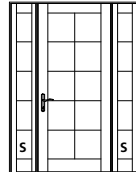

COSWT3070F10

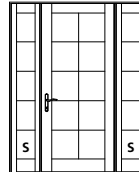

COSWT3070F12

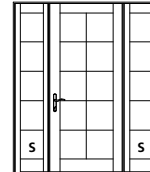

COSWT3070F14

100" [2540]
101 17/32" [2579]
98 7/8" [2511]
98 1/8" [2492]
84 11/16" [2151]

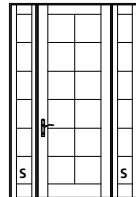

COSWT3080F10

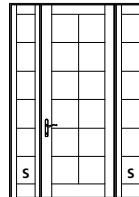

COSWT3080F12

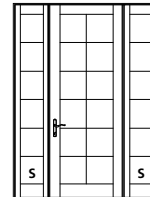

COSWT3080F14

112" [2845]
113 17/32" [2884]
110 7/8" [2816]
110 1/8" [2797]
96 11/16" [2456]

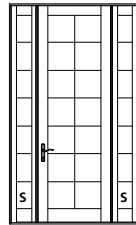

COSWT3090F10

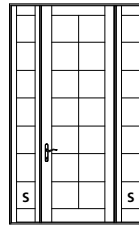

COSWT3090F12

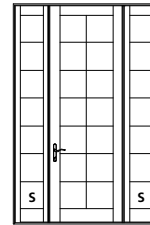

COSWT3090F14

M.O. BRICKMOULD
M.O. ADAMS/FLAT CASING
ROUGH OPENING
FRAME SIZE
DAYLIGHT OPENING

73 7/8" [1876]	77 7/8" [1978]	81 5/16" [2065]
76 15/16" [1954]	80 15/16" [2056]	84 15/16" [2157]
71 3/8" [1813]	75 3/8" [1915]	79 3/8" [2016]
70 5/8" [1794]	74 5/8" [1895]	78 5/8" [1997]
32 5/8" [829] - 7 1/2" [190] (2)	32 5/8" [829] - 9 1/2" [241] (2)	32 5/8" [829] - 11 1/2" [292] (2)

84" [2134]
85 17/32" [2172]
82 7/8" [2105]
82 1/8" [2086]
68 11/16" [1745]

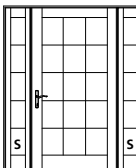

COSWT3668F10

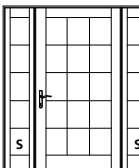

COSWT3668F12

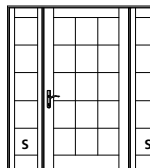

COSWT3668F14

88" [2235]
89 17/32" [2274]
86 7/8" [2206]
86 1/8" [2188]
72 11/16" [1846]

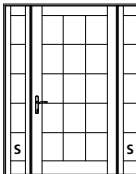

COSWT3670F10

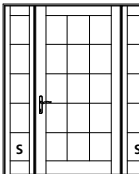

COSWT3670F12

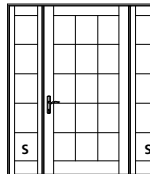

COSWT3670F14

100" [2540]
101 17/32" [2579]
98 7/8" [2511]
98 1/8" [2492]
84 11/16" [2151]

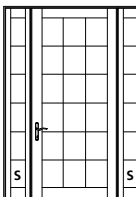

COSWT3680F10

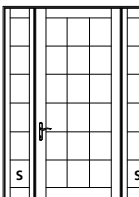

COSWT3680F12

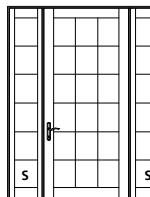

COSWT3680F14

ELEVATION SYMBOL LEGEND:

M.O. = MASONRY OPENING
VALUES IN () ARE NUMBER OF DAYLIGHT OPENINGS PER UNIT.
VALUES IN [] ARE IN MILLIMETER CONVERSIONS.
S PANEL IS AVAILABLE AS STATIONARY ONLY.

Note: Elevations shown DO NOT have exterior trim. Subtract 1/2" (12.7) from M.O. (Masonry Opening) for Unit Size. For other Trim Options refer to the Unit Sizing, Rough Opening & Masonry Openings page.

SCALE: 1/8" = 1'

FRENCH DOOR WITH TWO SIDELITES
5-0 UNITS

M.O. BRICKMOULD
M.O. ADAMS/FLAT CASING
ROUGH OPENING
FRAME SIZE
DAYLIGHT OPENING

93 1/16" [2364]
96 1/8" [2442]
90 9/16" [2300]
89 13/16" [2281]
20 5/8" [524] (2) - 7 1/2" [190] (2)

97 1/16" [2465]
100 1/8" [2543]
94 9/16" [2402]
93 13/16" [2383]
20 5/8" [524] (2) - 9 1/2" [241] (2)

101 1/16" [2567]
104 1/8" [2645]
98 9/16" [2503]
97 13/16" [2484]
20 5/8" [524] (2) - 11 1/2" [292] (2)

84" [2134]
85 17/32" [2172]
82 7/8" [2105]
83 1/8" [2086]
68 11/16" [1745]

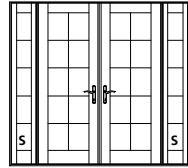

COFRT5068Q10

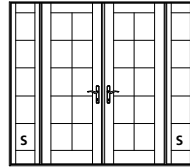

COFRT5068Q12

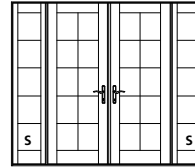

COFRT5068Q14

88" [2235]
89 17/32" [2274]
86 7/8" [2206]
86 1/8" [2188]
72 11/16" [1846]

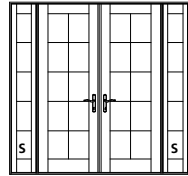

COFRT5070Q10

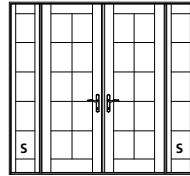

COFRT5070Q12

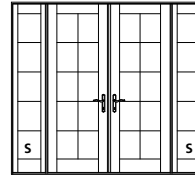

COFRT5070Q14

100" [2540]
101 17/32" [2579]
98 7/8" [2511]
98 1/8" [2492]
84 11/16" [2151]

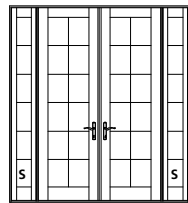

COFRT5080Q10

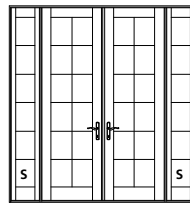

COFRT5080Q12

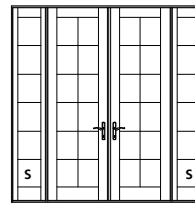

COFRT5080Q14

112" [2845]
113 17/32" [2884]
110 7/8" [2816]
110 1/8" [2797]
96 11/16" [2456]

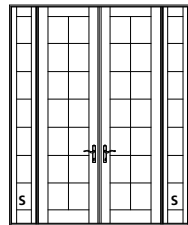

COFRT5090Q10

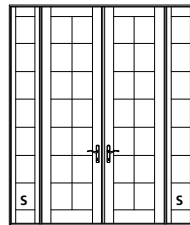

COFRT5090Q12

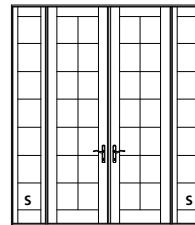

COFRT5090Q14

ELEVATION SYMBOL LEGEND:

M.O. = MASONRY OPENING
VALUES IN () ARE NUMBER OF DAYLIGHT OPENINGS PER UNIT.
VALUES IN [] ARE IN MILLIMETER CONVERSIONS.
S PANEL IS AVAILABLE AS STATIONARY ONLY.

Note: Elevations shown DO NOT have exterior trim. Subtract 1/2" (12.7) from M.O. (Masonry Opening) for Unit Size. For other Trim Options refer to the Unit Sizing, Rough Opening & Masonry Openings page.

SCALE: 1/8" = 1'

FRENCH DOOR WITH TWO SIDELITES
5-4 UNITS

M.O. BRICKMOUND
M.O. ADAMS/FLAT CASING
ROUGH OPENING
FRAME SIZE
DAYLIGHT OPENING

97 1/16" [2465]
100 1/8" [2543]
94 9/16" [2402]
93 13/16" [2383]
22 5/8" [575] (2) - 7 1/2" [190] (2)

101 1/16" [2567]
104 1/8" [2645]
98 9/16" [2503]
97 13/16" [2484]
22 5/8" [575] (2) - 9 1/2" [241] (2)

105 1/16" [2669]
108 1/8" [2746]
102 9/16" [2605]
101 13/16" [2586]
22 5/8" [602] (2) - 11 1/2" [292] (2)

84" [2134]
85 17/32" [2172]
82 7/8" [2105]
82 1/8" [2086]
68 11/16" [1745]

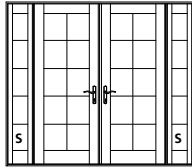

COFRT5468Q10

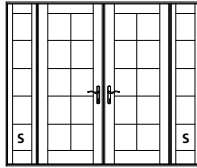

COFRT5468Q12

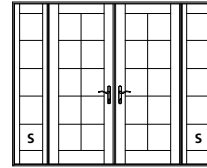

COFRT5468Q14

88" [2235]
89 17/32" [2274]
86 7/8" [2206]
86 1/8" [2188]
72 11/16" [1846]

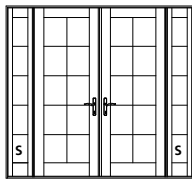

COFRT5470Q10

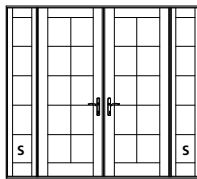

COFRT5470Q12

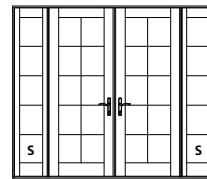

COFRT5470Q14

100" [2540]
101 17/32" [2579]
98 7/8" [2511]
98 1/8" [2492]
84 11/16" [2151]

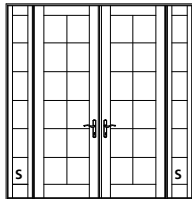

COFRT5480Q10

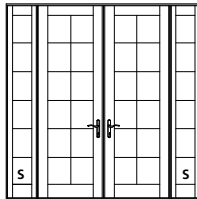

COFRT5480Q12

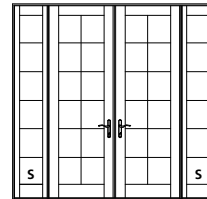

COFRT5480Q14

112" [2845]
113 17/32" [2884]
110 7/8" [2816]
110 1/8" [2797]
96 11/16" [2456]

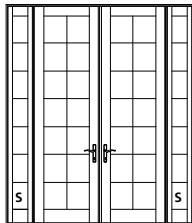

COFRT5490Q10

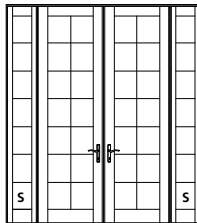

COFRT5490Q12

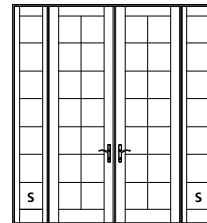

COFRT5490Q14

ELEVATION SYMBOL LEGEND:

M.O. = MASONRY OPENING
VALUES IN () ARE NUMBER OF DAYLIGHT OPENINGS PER UNIT.
VALUES IN [] ARE IN MILLIMETER CONVERSIONS.
S PANEL IS AVAILABLE AS STATIONARY ONLY.

Note: Elevations shown DO NOT have exterior trim. Subtract 1/2" (12.7) from M.O. (Masonry Opening) for Unit Size. For other Trim Options refer to the Unit Sizing, Rough Opening & Masonry Openings page.

SCALE: 1/8" = 1'

FRENCH DOOR WITH TWO SIDELITES
6-0 UNITS

M.O. BRICKMOUND
M.O. ADAMS/FLAT CASING
ROUGH OPENING
FRAME SIZE
DAYLIGHT OPENING

105 1/16" [2669]
108 1/8" [2746]
102 9/16" [2605]
101 13/16" [2586]
26 5/8" [676] (2) - 7 1/2" [190] (2)

109 1/16" [2770]
112 1/8" [2848]
106 9/16" [2707]
105 13/16" [2688]
26 5/8" [676] (2) - 9 1/2" [241] (2)

113 1/16" [2872]
116 1/8" [2950]
110 9/16" [2808]
109 13/16" [2789]
26 5/8" [676] (2) - 11 1/2" [292] (2)

84" [2134]
85 17/32" [2172]
82 7/8" [2105]
82 1/8" [2086]
68 11/16" [1745]

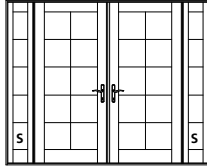

COFRT6068Q10

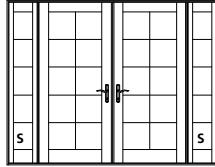

COFRT6068Q12

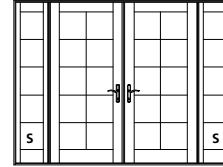

COFRT6068Q14

88" [2235]
89 17/32" [2274]
86 7/8" [2206]
86 1/8" [2188]
72 11/16" [1846]

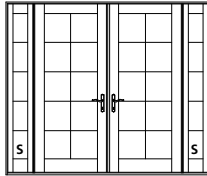

COFRT6070Q10

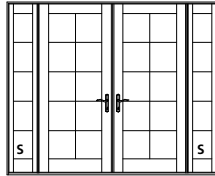

COFRT6070Q12

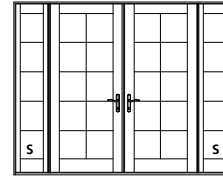

COFRT6070Q14

100" [2540]
101 17/32" [2579]
98 7/8" [2511]
98 1/8" [2492]
84 11/16" [2151]

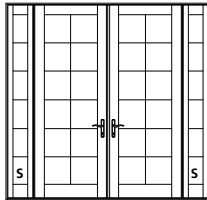

COFRT6080Q10

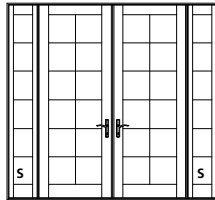

COFRT6080Q12

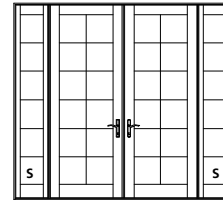

COFRT6080Q14

112" [2845]
113 17/32" [2884]
110 7/8" [2816]
110 1/8" [2797]
96 11/16" [2456]

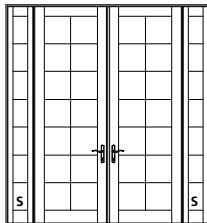

COFRT6090Q10

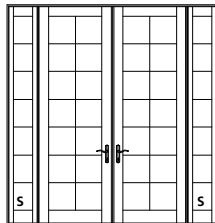

COFRT6090Q12

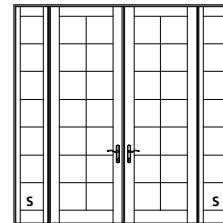

COFRT6090Q14

ELEVATION SYMBOL LEGEND:

M.O. = MASONRY OPENING
VALUES IN () ARE NUMBER OF DAYLIGHT OPENINGS PER UNIT.
VALUES IN [] ARE IN MILLIMETER CONVERSIONS.
S PANEL IS AVAILABLE AS STATIONARY ONLY.

Note: Elevations shown DO NOT have exterior trim. Subtract 1/2" (12.7) from M.O. (Masonry Opening) for Unit Size. For other Trim Options refer to the Unit Sizing, Rough Opening & Masonry Openings page.

SCALE: 1/8" = 1'

FRENCH DOOR WITH TWO SIDELITES
7-0 UNITS

M.O. BRICKMOULD
M.O. ADAMS/FLAT CASING
ROUGH OPENING
FRAME SIZE
DAYLIGHT OPENING

117 1/16" [2973]
120 1/8" [3051]
114 9/16" [2910]
113 13/16" [2891]
32 5/8" [829] (2) - 7 1/2" [190] (2)

121 1/16" [3075]
124 1/8" [3153]
118 9/16" [3011]
117 13/16" [2992]
32 5/8" [829] (2) - 9 1/2" [241] (2)

125 1/16" [3177]
128 1/8" [3254]
122 9/16" [3113]
121 13/16" [3094]
32 5/8" [829] (2) - 11 1/2" [292] (2)

84" [2134]
85 17/32" [2172]
82 7/8" [2105]
82 1/8" [2086]
68 11/16" [1745]

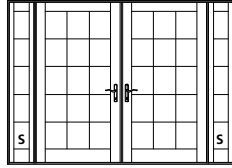

COFRT7068Q10

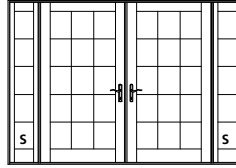

COFRT7068Q12

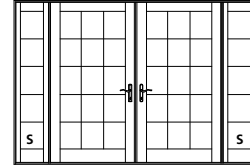

COFRT7068Q14

88" [2235]
89 17/32" [2274]
86 7/8" [2206]
86 1/8" [2188]
72 11/16" [1846]

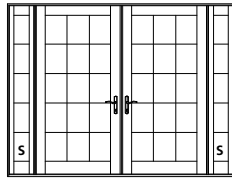

COFRT7070Q10

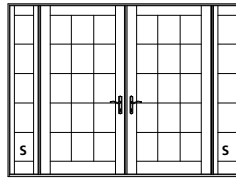

COFRT7070Q12

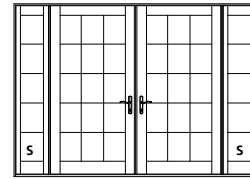

COFRT7070Q14

100" [2540]
101 17/32" [2579]
98 7/8" [2511]
98 1/8" [2492]
84 11/16" [2151]

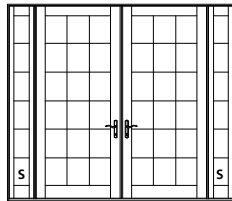

COFRT7080Q10

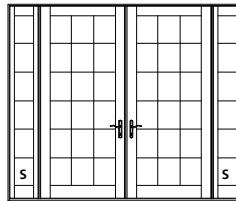

COFRT7080Q12

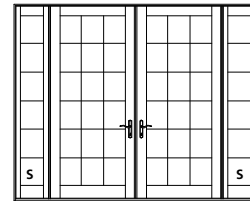

COFRT7080Q14

ELEVATION SYMBOL LEGEND:

M.O. = MASONRY OPENING
VALUES IN () ARE NUMBER OF DAYLIGHT OPENINGS PER UNIT.
VALUES IN [] ARE IN MILLIMETER CONVERSIONS.
S PANEL IS AVAILABLE AS STATIONARY ONLY.

Note: Elevations shown DO NOT have exterior trim. Subtract 1/2" (12.7) from M.O. (Masonry Opening) for Unit Size. For other Trim Options refer to the Unit Sizing, Rough Opening & Masonry Openings page.

SCALE: 1/8" = 1'

SINGLE SASH TRANSOMS

**M.O. BRICKMOLD
M.O. ADAMS/FLAT CASING
ROUGH OPENING
FRAME SIZE
DAYLIGHT OPENING**

27 1/4" [692]	33 1/4" [845]	39 1/4" [997]	50 7/16" [1281]	62 7/16" [1586]	74 7/16" [1891]
30 5/16" [770]	36 5/16" [922]	42 5/16" [1075]	52 15/16" [1345]	65 1/2" [1664]	77 1/2" [1969]
24 3/4" [629]	30 3/4" [781]	36 3/4" [933]	47 15/16" [1218]	59 15/16" [1522]	71 15/16" [1827]
24" [610]	30" [762]	36" [914]	47 3/16" [1199]	59 3/16" [1503]	71 3/16" [1808]
12 5/8" [321]	18 5/8" [473]	24 5/8" [625]	35 13/16" [910]	47 13/16" [1214]	59 13/16" [1519]

20 1/2" [521]
22" [559]
18 3/4" [476]
18" [457]
11 1/2" [292]



32 1/2" [826]
34" [864]
30 3/4" [781]
30" [762]
23 1/2" [597]

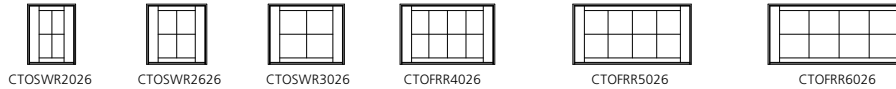

**M.O. BRICKMOLD
M.O. ADAMS/FLAT CASING
ROUGH OPENING
FRAME SIZE
DAYLIGHT OPENING**

17 3/8" [441]	19 3/8" [492]	21 3/8" [543]	29 1/4" [743]	35 1/4" [895]	37 1/4" [946]	41 1/4" [1048]	47 1/4" [1200]
20 7/16" [519]	22 7/16" [570]	24 7/16" [621]	32 5/16" [821]	38 5/16" [973]	40 5/16" [1024]	44 5/16" [1126]	50 5/16" [1278]
14 7/8" [378]	16 7/8" [429]	18 7/8" [479]	26 3/4" [679]	32 3/4" [832]	34 3/4" [883]	38 3/4" [984]	44 3/4" [1137]
14 1/8" [359]	16 1/8" [410]	18 1/8" [460]	26" [660]	32" [813]	34" [864]	38" [965]	44" [1118]
7 1/2" [190]	9 1/2" [241]	11 1/2" [292]	14 5/8" [371]	20 5/8" [524]	22 5/8" [575]	26 5/8" [676]	32 5/8" [829]

20 1/2" [521]
22" [559]
18 3/4" [476]
18" [457]
11 1/2" [292]



32 1/2" [826]
34" [864]
30 3/4" [781]
30" [762]
23 1/2" [597]



**M.O. BRICKMOLD
M.O. ADAMS/FLAT CASING
ROUGH OPENING
FRAME SIZE
DAYLIGHT OPENING**

54 7/16" [1383]	66 7/16" [1688]	70 7/16" [1789]	78 7/16" [1992]	90 7/16" [2297]
57 1/2" [1461]	69 1/2" [1765]	73 1/2" [1867]	81 1/2" [2070]	93 1/2" [2375]
51 15/16" [1319]	63 15/16" [1624]	67 15/16" [1726]	75 15/16" [1929]	87 15/16" [2234]
51 3/16" [1300]	63 3/16" [1605]	67 3/16" [1707]	75 3/16" [1910]	87 3/16" [2215]
39 13/16" [1011]	51 13/16" [1316]	55 13/16" [1418]	63 13/16" [1621]	75 13/16" [1926]

20 1/2" [521]
22" [559]
18 3/4" [476]
18" [457]
11 1/2" [292]

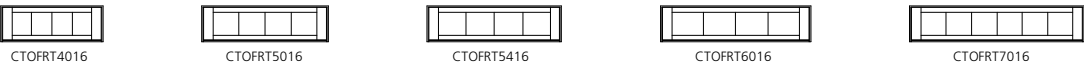

32 1/2" [826]
34" [864]
30 3/4" [781]
30" [762]
23 1/2" [597]

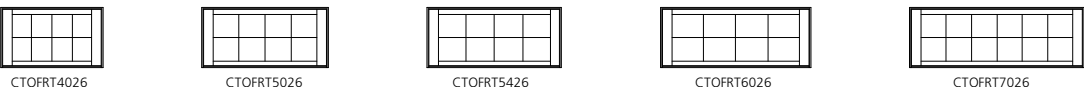

ELEVATION SYMBOL LEGEND:
M.O. = MASONRY OPENING
VALUES IN [] ARE IN MILLIMETER CONVERSIONS.

Note: Elevations shown DO NOT have exterior trim. Subtract 1/2" (12.7) from M.O. (Masonry Opening) for Unit Sizes. Masonry Openings above include Sill Nose, see Transom Rail & Sill Options page for Sill Nose specifications. For other Trim Options refer to the Unit Sizing, Rough Opening & Masonry Openings page.

SCALE: 1/8" = 1'

2-SASH TRANSOMS

M.O. BRICKMOULD
M.O. ADAMS/FLAT CASING
ROUGH OPENING
FRAME SIZE
DAYLIGHT OPENING

50 7/16" [1281]
53 1/2" [1359]
47 15/16" [1218]
47 3/16" [1199]
12 5/8" [321] (2)

62 7/16" [1586]
65 1/2" [1684]
59 15/16" [1522]
59 3/16" [1503]
18 5/8" [473] (2)

74 7/16" [1891]
77 1/2" [1969]
71 15/16" [1827]
71 3/16" [1808]
24 5/8" [625] (2)

54 7/16" [1383]
57 1/2" [1461]
51 15/16" [1319]
51 3/16" [1300]
14 5/8" [371] (2)

20 1/2" [521]
22" [559]
18 3/4" [476]
18" [457]
11 1/2" [292]



CTOSWR4016



CTOSWR5016

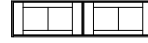

CTOSWR6016

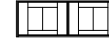

CTOSWT4016

32 1/2" [826]
34" [864]
30 3/4" [781]
30" [762]
23 1/2" [597]

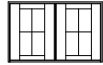

CTOSWR4026

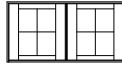

CTOSWR5026

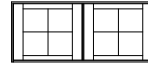

CTOSWR6026

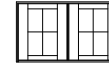

CTOSWT4026

M.O. BRICKMOULD
M.O. ADAMS/FLAT CASING
ROUGH OPENING
FRAME SIZE
DAYLIGHT OPENING

66 7/16" [1688]
69 1/2" [1765]
63 15/16" [1624]
63 3/16" [1605]
20 5/8" [524] (2)

70 7/16" [1789]
73 1/2" [1867]
67 15/16" [1726]
67 3/16" [1707]
22 5/8" [575] (2)

78 7/16" [1992]
81 1/2" [2070]
75 15/16" [1929]
75 3/16" [1910]
26 5/8" [676] (2)

90 7/16" [2297]
93 1/2" [2375]
87 15/16" [2234]
87 3/16" [2215]
32 5/8" [829] (2)

20 1/2" [521]
22" [559]
18 3/4" [476]
18" [457]
11 1/2" [292]



CTOSWT5016

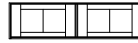

CTOSWT5416

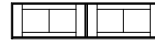

CTOSWT6016



CTOSWT7016

32 1/2" [826]
34" [864]
30 3/4" [781]
30" [762]
23 1/2" [597]

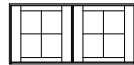

CTOSWT5026

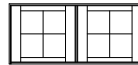

CTOSWT5426

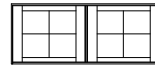

CTOSWT6026

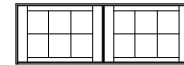

CTOSWT7026

M.O. BRICKMOULD
M.O. ADAMS/FLAT CASING
ROUGH OPENING
FRAME SIZE
DAYLIGHT OPENING

54 9/16" [1386]
57 5/8" [1464]
52 1/16" [1322]
51 5/16" [1303]
26 5/8" [676] - 7 1/2" [190]

56 9/16" [1437]
59 5/8" [1514]
54 1/16" [1373]
53 5/16" [1354]
26 5/8" [676] - 9 1/2" [241]

58 9/16" [1487]
61 5/8" [1565]
56 1/16" [1424]
55 5/16" [1405]
26 5/8" [676] - 11 1/2" [292]

20 1/2" [521]
22" [559]
18 3/4" [476]
18" [457]
11 1/2" [292]

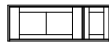

CTOSWT3016B10

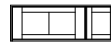

CTOSWT3016B12

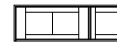

CTOSWT3016B14

32 1/2" [826]
34" [864]
30 3/4" [781]
30" [762]
23 1/2" [597]

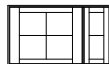

CTOSWT3026B10

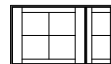

CTOSWT3026B12

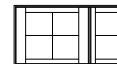

CTOSWT3026B14

M.O. BRICKMOULD
M.O. ADAMS/FLAT CASING
ROUGH OPENING
FRAME SIZE
DAYLIGHT OPENING

60 9/16" [1538]
63 5/8" [1616]
58 1/16" [1475]
57 5/16" [1456]
32 5/8" [829] - 7 1/2" [190]

62 9/16" [1589]
65 5/8" [1667]
60 1/16" [1526]
59 5/16" [1507]
32 5/8" [829] - 9 1/2" [241]

64 9/16" [1640]
67 5/8" [1718]
62 1/16" [1576]
61 5/16" [1557]
32 5/8" [829] - 11 1/2" [290]

20 1/2" [521]
22" [559]
18 3/4" [476]
18" [457]
11 1/2" [292]

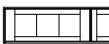

CTOSWT3616B10

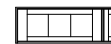

CTOSWT3616B10

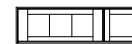

CTOSWT3616B10

32 1/2" [826]
34" [864]
30 3/4" [781]
30" [762]
23 1/2" [597]



CTOSWT3626B10



CTOSWT3626B10

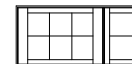

CTOSWT3626B10

ELEVATION SYMBOL LEGEND:

M.O. = MASONRY OPENING
VALUES IN () ARE NUMBER OF DAYLIGHT OPENINGS PER UNIT.
VALUES IN [] ARE IN MILLIMETER CONVERSIONS.

Note: Elevations shown DO NOT have exterior trim. Subtract 1/2" (12.7) from M.O. (Masonry Opening) for Unit Sizes. Masonry Openings above include Sill Nose, see Transom Rail & Sill Options page for Sill Nose specifications. For other Trim Options refer to the Unit Sizing, Rough Opening & Masonry Openings page.

SCALE: 1/8" = 1'

3-SASH TRANSOMS

M.O. BRICKMOULD
M.O. ADAMS/FLAT CASING
ROUGH OPENING
FRAME SIZE
DAYLIGHT OPENING

91 5/8" [2237]
94 11/16" [2405]
89 1/8" [2264]
88 3/8" [2245]
18 5/8" [473] (3)

109 5/8" [2784]
112 11/16" [2862]
107 1/8" [2721]
106 3/8" [2702]
24 5/8" [625] (3)

97 5/8" [2480]
100 11/16" [2557]
95 1/8" [2416]
94 3/8" [2397]
20 5/8" [524] (3)

20 1/2" [521]
22" [559]
18 3/4" [476]
18" [457]
11 1/2" [292]

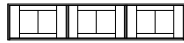

CTOSWR7616

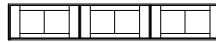

CTOSWR9016

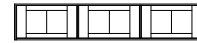

CTOSWT7616

32 1/2" [826]
34" [864]
30 3/4" [781]
30" [762]
23 1/2" [597]

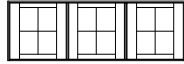

CTOSWR7626

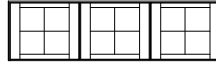

CTOSWR9026

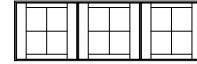

CTOSWT7626

M.O. BRICKMOULD
M.O. ADAMS/FLAT CASING
ROUGH OPENING
FRAME SIZE
DAYLIGHT OPENING

103 5/8" [2632]
106 11/16" [2710]
101 1/8" [2569]
100 3/8" [2550]
22 5/8" [575] (3)

115 5/8" [2937]
118 11/16" [3015]
113 1/8" [2873]
112 13/16" [2854]
26 5/8" [676] (3)

20 1/2" [521]
22" [559]
18 3/4" [476]
18" [457]
11 1/2" [292]

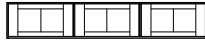

CTOSWT8016

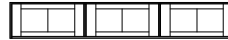

CTOSWT9016

32 1/2" [826]
34" [864]
30 3/4" [781]
30" [762]
23 1/2" [597]

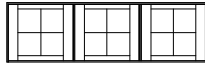

CTOSWT8026

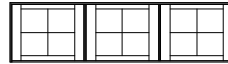

CTOSWT9026

M.O. BRICKMOULD
M.O. ADAMS/FLAT CASING
ROUGH OPENING
FRAME SIZE
DAYLIGHT OPENING

67 7/8" [1724]
70 15/16" [1802]
65 3/8" [1661]
64 5/8" [1641]
26 5/8" [676] - 7 1/2" [190] (2)

71 7/8" [1826]
74 15/16" [1903]
69 3/8" [1762]
68 5/8" [1743]
26 5/8" [676] - 9 1/2" [241] (2)

75 7/8" [1927]
78 15/16" [2005]
73 3/8" [1864]
72 5/8" [1845]
26 5/8" [676] - 11 1/2" [292] (2)

20 1/2" [521]
22" [559]
18 3/4" [476]
18" [457]
11 1/2" [292]



CTOSWT3016F10



CTOSWT3016F12



CTOSWT3016F14

32 1/2" [826]
34" [864]
30 3/4" [781]
30" [762]
23 1/2" [597]

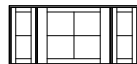

CTOSWT3026F10

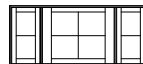

CTOSWT3026F12

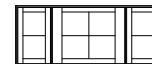

CTOSWT3026F14

M.O. BRICKMOULD
M.O. ADAMS/FLAT CASING
ROUGH OPENING
FRAME SIZE
DAYLIGHT OPENING

73 7/8" [1876]
76 15/16" [1954]
71 3/8" [1813]
70 5/8" [1794]
32 5/8" [829] - 7 1/2" [190] (2)

77 7/8" [1978]
80 15/16" [2056]
75 3/8" [1915]
74 5/8" [1895]
32 5/8" [829] - 9 1/2" [241] (2)

77 7/8" [1978]
80 15/16" [2056]
79 3/8" [2016]
74 5/8" [1895]
32 5/8" [829] - 11 1/2" [292] (2)

20 1/2" [521]
22" [559]
18 3/4" [476]
18" [457]
11 1/2" [292]

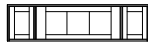

CTOSWT3616F10

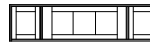

CTOSWT3616F12

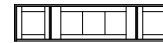

CTOSWT3616F14

32 1/2" [826]
34" [864]
30 3/4" [781]
30" [762]
23 1/2" [597]

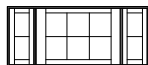

CTOSWT3626F10

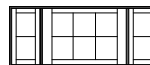

CTOSWT3626F12

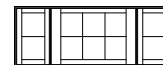

CTOSWT3626F14

ELEVATION SYMBOL LEGEND:

M.O. = MASONRY OPENING
VALUES IN () ARE NUMBER OF DAYLIGHT OPENINGS PER UNIT.
VALUES IN [] ARE IN MILLIMETER CONVERSIONS.

Note: Elevations shown DO NOT have exterior trim. Subtract 1/2" (12.7) from M.O. (Masonry Opening) for Unit Sizes. Masonry Openings above include Sill Nose, see Transom Rail & Sill Options page for Sill Nose specifications. For other Trim Options refer to the Unit Sizing, Rough Opening & Masonry Openings page.

SCALE: 1/8" = 1'

4-SASH FRENCH TRANSOMS

M.O. BRICKMOULD	96 13/16" [2459]	120 13/16" [3069]	144 13/16" [3678]
M.O. ADAMS/FLAT CASING	99 7/8" [2537]	123 7/8" [3146]	147 7/8" [3756]
ROUGH OPENING	94 5/16" [2396]	118 5/16" [3005]	142 5/16" [3615]
FRAME SIZE	93 9/16" [2376]	117 9/16" [2986]	141 9/16" [3596]
DAYLIGHT OPENING	12 5/8" [321] (2)	18 5/8" [473] (2)	24 5/8" [625] (2)

20 1/2" [521]
22" [559]
18 3/4" [476]
18" [457]
11 1/2" [292]

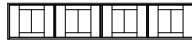

CTOFRR8016

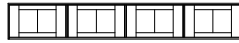

CTOFRR10016



CTOFRR12016

32 1/2" [826]
34" [864]
30 3/4" [781]
30" [762]
23 1/2" [597]

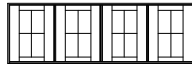

CTOFRR8026

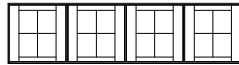

CTOFRR10026

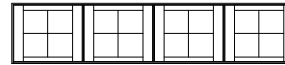

CTOFRR12026

M.O. BRICKMOULD	104 13/16" [2662]	128 13/16" [3272]	152 13/16" [3881]
M.O. ADAMS/FLAT CASING	107 7/8" [2740]	131 7/8" [3350]	155 7/8" [3989]
ROUGH OPENING	102 5/16" [2599]	126 5/16" [3208]	150 5/16" [3818]
FRAME SIZE	101 9/16" [2580]	125 9/16" [3189]	149 9/16" [3799]
DAYLIGHT OPENING	14 5/8" [371] (2)	20 5/8" [524] (2)	26 5/8" [676] (2)

20 1/2" [521]
22" [559]
18 3/4" [476]
18" [457]
11 1/2" [292]

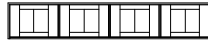

CTOFRT8016

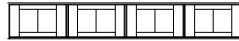

CTOFRT10016

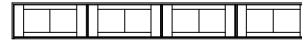

CTOFRT12016

32 1/2" [826]
34" [864]
30 3/4" [781]
30" [762]
23 1/2" [597]

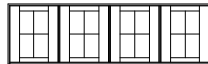

CTOFRT8026

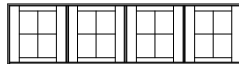

CTOFRT10026

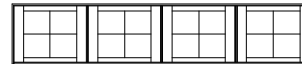

CTOFRT12026

ELEVATION SYMBOL LEGEND:

M.O. = MASONRY OPENING
VALUES IN () ARE NUMBER OF DAYLIGHT OPENINGS PER UNIT.
VALUES IN [] ARE IN MILLIMETER CONVERSIONS.

Note: Elevations shown DO NOT have exterior trim. Subtract 1/2" (12.7) from M.O. (Masonry Opening) for Unit Sizes. Masonry Openings above include Sill Nose, see Transom Rail & Sill Options page for Sill Nose specifications. For other Trim Options refer to the Unit Sizing, Rough Opening & Masonry Openings page.

Continued on next page

SCALE: 1/8" = 1'

FRENCH TRANSOMS WITH TWO SIDELITES

M.O. BRICKMOULD
M.O. ADAMS/FLAT CASING
ROUGH OPENING
FRAME SIZE
DAYLIGHT OPENING

93 1/16" [2364]
96 1/8" [2442]
90 9/16" [2300]
89 13/16" [2281]
20 5/8" [524] (2) - 7 1/2" [190] (2)

20 1/2" [521]
22" [559]
18 3/4" [476]
18" [457]
11 1/2" [292]

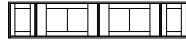

CTOFRT5016Q10

97 1/16" [2465]
100 1/8" [2543]
94 9/16" [2402]
93 13/16" [2363]
20 5/8" [551] (2) - 9 1/2" [241] (2)

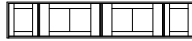

CTOFRT5016Q12

101 1/16" [2567]
104 1/8" [2645]
98 9/16" [2503]
97 13/16" [2484]
20 5/8" [524] (2) - 11 1/2" [292] (2)



CTOFRT5016Q14

32 1/2" [826]
34" [864]
30 3/4" [781]
30" [762]
23 1/2" [597]

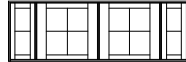

CTOFRT5026Q10

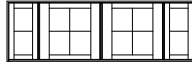

CTOFRT5026Q12



CTOFRT5026Q14

M.O. BRICKMOULD
M.O. ADAMS/FLAT CASING
ROUGH OPENING
FRAME SIZE
DAYLIGHT OPENING

97 1/16" [2465]
100 1/8" [2543]
94 9/16" [2402]
93 13/16" [2383]
22 5/8" [575] (2) - 7 1/2" [190] (2)

20 1/2" [521]
22" [559]
18 3/4" [476]
18" [457]
11 1/2" [292]



CTOFRT5416Q10



CTOFRT5416Q12



CTOFRT5416Q14

32 1/2" [826]
34" [864]
30 3/4" [781]
30" [762]
23 1/2" [597]



CTOFRT5426Q10



CTOFRT5426Q12



CTOFRT5426Q14

M.O. BRICKMOULD
M.O. ADAMS/FLAT CASING
ROUGH OPENING
FRAME SIZE
DAYLIGHT OPENING

105 1/16" [2669]
108 1/8" [2746]
102 9/16" [2605]
101 13/16" [2586]
26 5/8" [676] (2) - 7 1/2" [190] (2)

20 1/2" [521]
22" [559]
18 3/4" [476]
18" [457]
11 1/2" [292]



CTOFRT6016Q10



CTOFRT6016Q12



CTOFRT6016Q14

32 1/2" [826]
34" [864]
30 3/4" [781]
30" [762]
23 1/2" [597]



CTOFRT6026Q10



CTOFRT6026Q12



CTOFRT6026Q14

M.O. BRICKMOULD
M.O. ADAMS/FLAT CASING
ROUGH OPENING
FRAME SIZE
DAYLIGHT OPENING

117 1/16" [2973]
120 1/8" [3051]
114 9/16" [2910]
113 13/16" [2891]
32 5/8" [829] (2) - 7 1/2" [190] (2)

20 1/2" [521]
22" [559]
18 3/4" [476]
18" [457]
11 1/2" [292]



CTOFRT7016Q10



CTOFRT7016Q12



CTOFRT7016Q14

32 1/2" [826]
34" [864]
30 3/4" [781]
30" [762]
23 1/2" [597]



CTOFRT7026Q10



CTOFRT7026Q12



CTOFRT7026Q14

ELEVATION SYMBOL LEGEND:

M.O. = MASONRY OPENING
VALUES IN () ARE NUMBER OF DAYLIGHT OPENINGS PER UNIT.
VALUES IN [] ARE IN MILLIMETER CONVERSIONS.

Note: Elevations shown DO NOT have exterior trim. Subtract 1/2" (12.7) from M.O. (Masonry Opening) for Unit Sizes. Masonry Openings above include Sill Nose, see Transom Rail & Sill Options page for Sill Nose specifications. For other Trim Options refer to the Unit Sizing, Rough Opening & Masonry Openings page.

SCALE: 1/8" = 1'

1-PANEL SECTOR TOP DOORS

M.O. BRICKMOULD
M.O. ADAMS/FLAT CASING
ROUGH OPENING
FRAME SIZE
DAYLIGHT OPENING

29 1/4" [743]
32 5/16" [821]
26 3/4" [679]
26" [660]
14 5/8" [371]

35 1/4" [895]
38 5/16" [973]
32 3/4" [832]
32" [813]
20 5/8" [524]

37 1/4" [946]
40 5/16" [1024]
34 3/4" [883]
34" [864]
22 5/8" [575]

41 1/4" [1048]
44 5/16" [1126]
38 3/4" [984]
38" [965]
26 5/8" [676]

47 1/4" [1200]
50 5/16" [1278]
44 3/4" [1137]
44" [1118]
32 5/8" [829]

84" [2134]
85 17/32" [2172]
82 7/8" [2105]
82 1/8" [2086]
68 11/16" [1745]

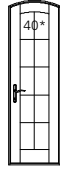

COSWTS2068

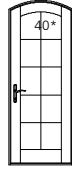

COSWTS2668

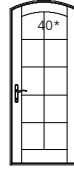

COSWTS2868

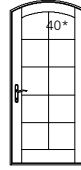

COSWTS3068

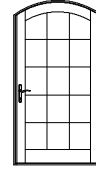

COSWTS3668

88" [2235]
89 17/32" [2274]
86 7/8" [2207]
86 7/8" [2188]
72 11/16" [1846]

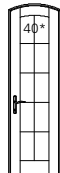

COSWTS2070

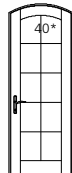

COSWTS2670

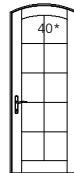

COSWTS2870

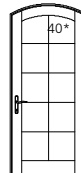

COSWTS3070

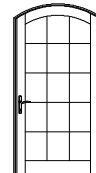

COSWTS3670

100" [2540]
101 17/32" [2579]
98 7/8" [2511]
98 1/8" [2492]
84 11/16" [2151]

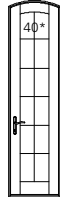

COSWTS2080

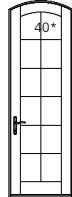

COSWTS2680

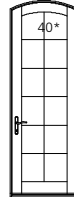

COSWTS2880

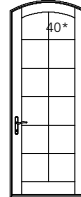

COSWTS3080

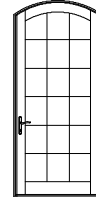

COSWTS3680

112" [2845]
113 17/32" [2884]
110 7/8" [2816]
110 1/8" [2797]
96 11/16" [2456]

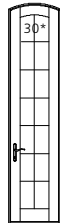

COSWTS2090

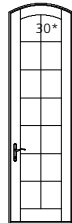

COSWTS2690

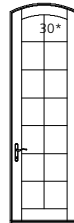

COSWTS2890

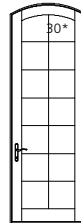

COSWTS3090

ELEVATION SYMBOL LEGEND:

M.O. = MASONRY OPENING
VALUES IN () ARE NUMBER OF DAYLIGHT OPENINGS PER UNIT.
VALUES IN [] ARE IN MILLIMETER CONVERSIONS.
##* NUMBER INDICATES DESIGN PRESSURE (DP) RATING WITH STANDARD GLAZING. OPERATING UNITS UTILIZE MULTI-POINT LOCKING HARDWARE FOR DP RATINGS.

Note: Elevations shown DO NOT have exterior trim. Subtract 1/2" (12.7) from M.O. (Masonry Opening) for Unit Size. For other Trim Options refer to the Unit Sizing, Rough Opening & Masonry Openings page.

SCALE: 1/8" = 1'

3-PANEL SECTOR TOP DOORS

M.O. BRICKMOULD
M.O. ADAMS/FLAT CASING
ROUGH OPENING
FRAME SIZE
DAYLIGHT OPENING

97 5/8" [2480]
100 11/16" [2557]
95 1/8" [2416]
94 3/8" [2397]
20 5/8" [524] (3)

103 5/8" [2632]
106 11/16" [2710]
101 1/8" [2569]
100 3/8" [2550]
22 5/8" [575] (3)

115 5/8" [2937]
118 11/16" [3015]
113 1/8" [2873]
112 3/8" [2854]
26 5/8" [676] (3)

84" [2134]
85 17/32" [2172]
82 7/8" [2105]
82 1/8" [2086]
68 11/16" [1745]

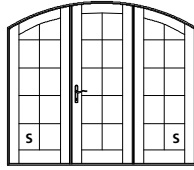

COSWTS7668

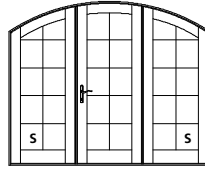

COSWTS8068

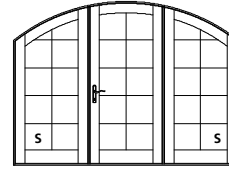

COSWTS9068

88" [2235]
89 17/32" [2274]
86 7/8" [2207]
86 1/8" [2188]
72 11/16" [1846]

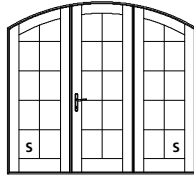

COSWTS7670

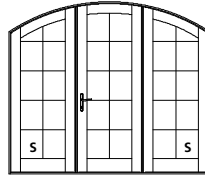

COSWTS8070

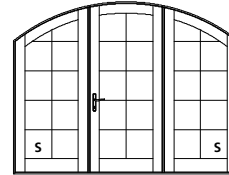

COSWTS9070

100" [2540]
101 17/32" [2579]
98 7/8" [2511]
98 1/8" [2492]
84 11/16" [2151]

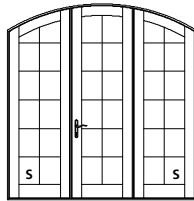

COSWTS7680

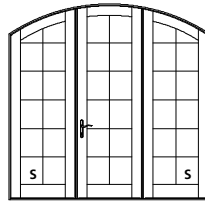

COSWTS8080

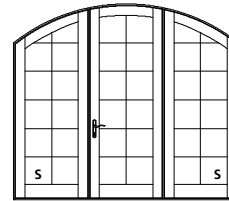

COSWTS9080

112" [2845]
113 17/32" [2884]
110 7/8" [2816]
110 1/8" [2797]
96 11/16" [2456]

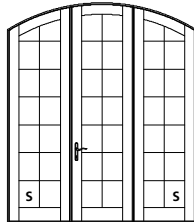

COSWTS7690

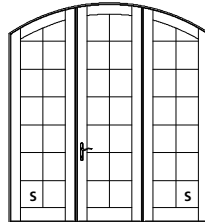

COSWTS8090

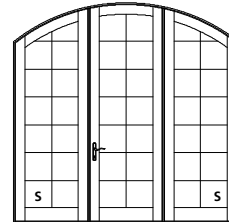

COSWTS9090

ELEVATION SYMBOL LEGEND:

M.O. = MASONRY OPENING
VALUES IN () ARE NUMBER OF DAYLIGHT OPENINGS PER UNIT.
VALUES IN [] ARE IN MILLIMETER CONVERSIONS.
S PANEL IS AVAILABLE AS STATIONARY ONLY.

Note: Elevations shown DO NOT have exterior trim. Subtract 1/2" (12.7) from M.O. (Masonry Opening) for Unit Size. For other Trim Options refer to the Unit Sizing, Rough Opening & Masonry Openings page.

SCALE: 1/8" = 1'

2-PANEL FRENCH SECTOR TOP DOORS

M.O. BRICKMOULD
M.O. ADAMS/FLAT CASING
ROUGH OPENING
FRAME SIZE
DAYLIGHT OPENING

54 7/16" [1383]
57 1/2" [1461]
51 15/16" [1319]
51 3/16" [1300]
14 5/8" [371] (2)

66 7/16" [1688]
69 1/2" [1765]
63 15/16" [1624]
63 3/16" [1605]
20 5/8" [524] (2)

70 7/16" [1789]
73 1/2" [1867]
67 15/16" [1726]
67 3/16" [1707]
22 5/8" [575] (2)

78 7/16" [1992]
81 1/2" [2070]
75 15/16" [1929]
75 3/16" [1910]
26 5/8" [676] (2)

90 7/16" [2297]
93 1/2" [2375]
87 15/16" [2234]
87 3/16" [2215]
32 5/8" [829] (2)

84" [2134]
85 17/32" [2172]
82 7/8" [2105]
82 1/8" [2086]
68 11/16" [1745]

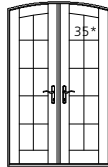

COFRTS4068

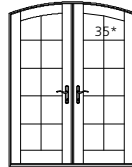

COFRTS5068

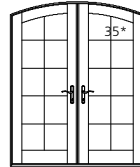

COFRTS5468

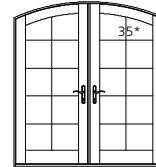

COFRTS6068

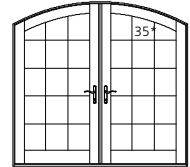

COFRTS7068

88" [2235]
89 17/32" [2274]
86 7/8" [2207]
86 1/8" [2188]
72 11/16" [1846]

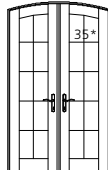

COFRTS4070

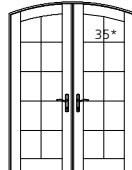

COFRTS5070

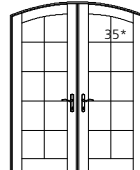

COFRTS5470

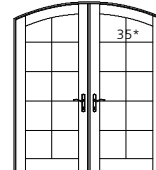

COFRTS6070

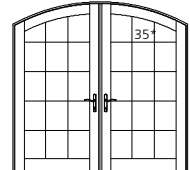

COFRTS7070

100" [2540]
101 17/32" [2579]
98 7/8" [2511]
98 1/8" [2492]
84 11/16" [2151]

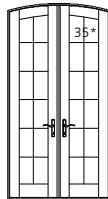

COFRTS4080

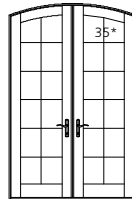

COFRTS5080

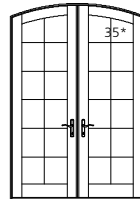

COFRTS5480

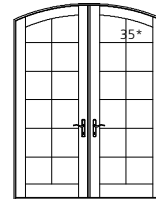

COFRTS6080

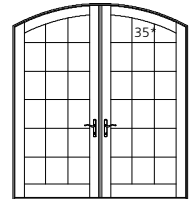

COFRTS7080

100" [2540]
101 17/32" [2579]
98 7/8" [2511]
98 1/8" [2492]
84 11/16" [2151]

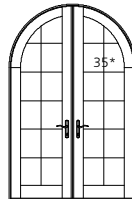

COFRTH5080

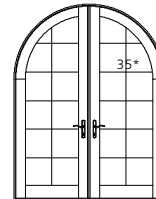

COFRTH6080

112" [2845]
113 17/32" [2884]
110 7/8" [2816]
110 1/8" [2797]
96 11/16" [2456]

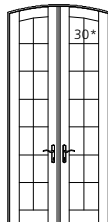

COFRTS4090

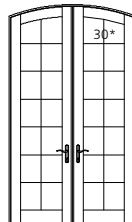

COFRTS5090

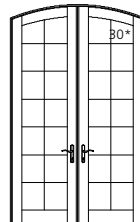

COFRTS5490

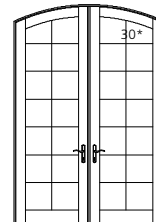

COFRTS6090

112" [2845]
113 17/32" [2884]
110 7/8" [2816]
110 1/8" [2797]
96 11/16" [2456]

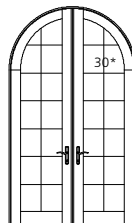

COFRTH5090

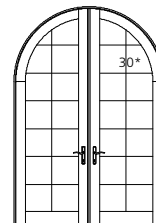

COFRTH6090

ELEVATION SYMBOL LEGEND:

M.O. = MASONRY OPENING
VALUES IN () ARE NUMBER OF DAYLIGHT OPENINGS PER UNIT.
VALUES IN [] ARE IN MILLIMETER CONVERSIONS.
##* NUMBER INDICATES DESIGN PRESSURE (DP) RATING
WITH STANDARD GLAZING. OPERATING UNITS UTILIZE
MULTI-POINT LOCKING HARDWARE FOR DP RATINGS.

Note: Elevations shown DO NOT have exterior trim. Subtract 1/2" (12.7) from M.O. (Masonry Opening) for Unit Size. For other Trim Options refer to the Unit Sizing, Rough Opening & Masonry Openings page.

SCALE: 1/8" = 1'

4-PANEL FRENCH SECTOR TOP DOORS

M.O. BRICKMOUND
M.O. ADAMS/FLAT CASING
ROUGH OPENING
FRAME SIZE
DAYLIGHT OPENING

104 13/16" [2662]
107 7/8" [2740]
102 5/16" [2599]
101 9/16" [2580]
14 5/8" [371] (4)

128 13/16" [3272]
131 7/8" [3350]
126 5/16" [3208]
125 9/16" [3189]
20 5/8" [524] (4)

84" [2134]
85 17/32" [2172]
82 7/8" [2105]
82 1/8" [2086]
68 11/16" [1745]

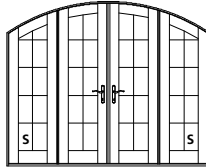

COFRTS8068

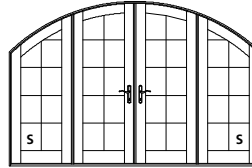

COFRTS10068

88" [2235]
89 17/32" [2274]
86 7/8" [2207]
86 1/8" [2188]
72 11/16" [1846]

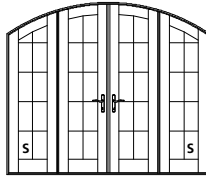

COFRTS8070

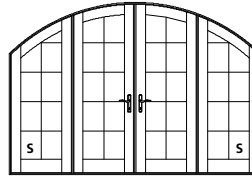

COFRTS10070

100" [2540]
101 17/32" [2579]
98 7/8" [2511]
98 1/8" [2492]
84 11/16" [2151]

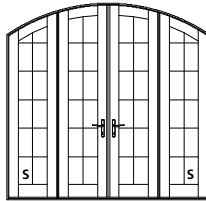

COFRTS8080

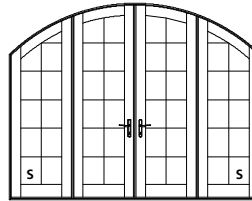

COFRTS10080

112" [2845]
113 17/32" [2884]
110 7/8" [2816]
110 1/8" [2797]
96 11/16" [2456]

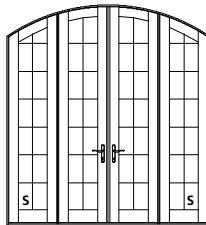

COFRTS8090

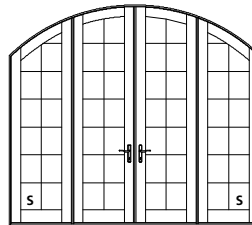

COFRTS10090

ELEVATION SYMBOL LEGEND:

M.O. = MASONRY OPENING
VALUES IN () ARE NUMBER OF DAYLIGHT OPENINGS PER UNIT.
VALUES IN [] ARE IN MILLIMETER CONVERSIONS.
S PANEL IS AVAILABLE AS STATIONARY ONLY.

Note: Elevations shown DO NOT have exterior trim. Subtract 1/2" (12.7) from M.O. (Masonry Opening) for Unit Size. For other Trim Options refer to the Unit Sizing, Rough Opening & Masonry Openings page.

SCALE: 1/8" = 1'

FRENCH SECTOR TOP DOORS WITH TWO SIDELIGHTS
5-0 UNITS

M.O. BRICKMOULD
M.O. ADAMS/FLAT CASING
ROUGH OPENING
FRAME SIZE
DAYLIGHT OPENING

93 1/16" [2364]
96 1/8" [2442]
90 9/16" [2300]
89 13/16" [2281]
20 5/8" [524] (2) - 7 1/2" [190] (2)

97 1/16" [2465]
100 1/8" [2543]
94 9/16" [2402]
93 13/16" [2383]
20 5/8" [524] (2) - 9 1/2" [241] (2)

101 1/16" [2567]
104 1/8" [2645]
98 9/16" [2503]
97 13/16" [2484]
20 5/8" [524] (2) - 11 1/2" [292] (2)

84" [2134]
85 17/32" [2172]
82 7/8" [2105]
82 1/8" [2086]
68 11/16" [1745]

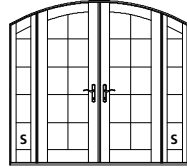

COFRTS5068Q10

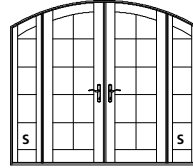

COFRTS5068Q12

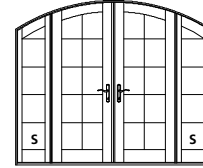

COFRTS5068Q14

88" [2235]
89 17/32" [2274]
86 7/8" [2207]
86 1/8" [2188]
72 11/16" [1846]

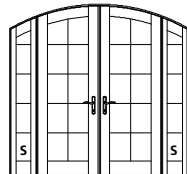

COFRTS5070Q10

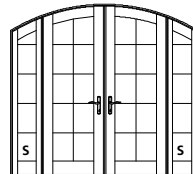

COFRTS5070Q12

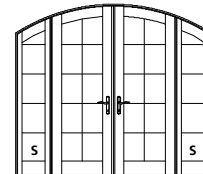

COFRTS5070Q14

100" [2540]
101 17/32" [2579]
98 7/8" [2511]
98 1/8" [2492]
84 11/16" [2151]

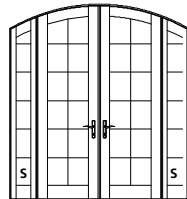

COFRTS5080Q10

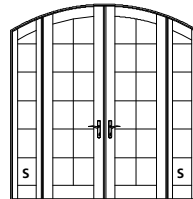

COFRTS5080Q12

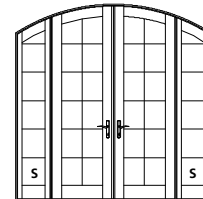

COFRTS5080Q14

112" [2845]
113 17/32" [2884]
110 7/8" [2816]
110 1/8" [2797]
96 11/16" [2456]

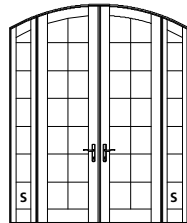

COFRTS5090Q10

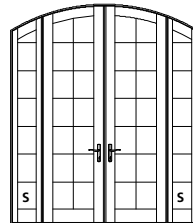

COFRTS5090Q12

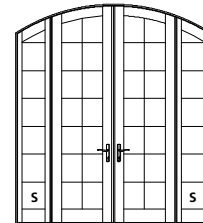

COFRTS5090Q14

ELEVATION SYMBOL LEGEND:

M.O. = MASONRY OPENING
VALUES IN () ARE NUMBER OF DAYLIGHT OPENINGS PER UNIT.
VALUES IN [] ARE IN MILLIMETER CONVERSIONS.
S PANEL IS AVAILABLE AS STATIONARY ONLY.

Note: Elevations shown DO NOT have exterior trim. Subtract 1/2" (12.7) from M.O. (Masonry Opening) for Unit Size. For other Trim Options refer to the Unit Sizing, Rough Opening & Masonry Openings page.

SCALE: 1/8" = 1'

FRENCH SECTOR TOP DOORS WITH TWO SIDELITES
5-4 UNITS

M.O. BRICKMOULD	97 1/16" [2465]	101 1/16" [2567]	105 1/16" [2669]
M.O. ADAMS/FLAT CASING	100 1/8" [2543]	104 1/8" [2645]	108 1/8" [2746]
ROUGH OPENING	94 9/16" [2402]	98 9/16" [2503]	102 9/16" [2605]
FRAME SIZE	93 13/16" [2383]	97 13/16" [2484]	101 13/16" [2586]
DAYLIGHT OPENING	22 5/8" [575] (2) - 7 1/2" [190] (2)	22 5/8" [575] (2) - 9 1/2" [241] (2)	22 5/8" [575] (2) - 11 1/2" [292] (2)

84" [2134]
85 17/32" [2172]
82 7/8" [2105]
82 1/8" [2086]
68 11/16" [1745]

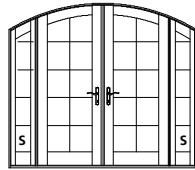

COFRTS5468Q10

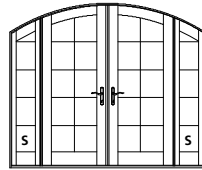

COFRTS5468Q12

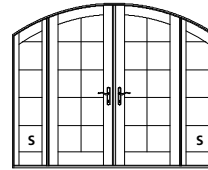

COFRTS5468Q14

88" [2235]
89 17/32" [2274]
86 7/8" [2207]
86 1/8" [2188]
72 11/16" [1846]

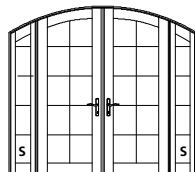

COFRTS5470Q10

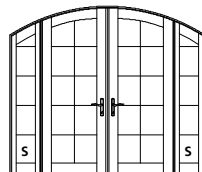

COFRTS5470Q12

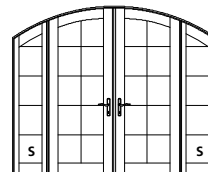

COFRTS5470Q14

100" [2540]
101 17/32" [2579]
98 7/8" [2511]
98 1/8" [2492]
84 11/16" [2151]

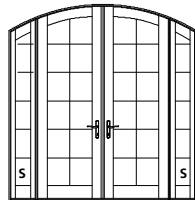

COFRTS5480Q10

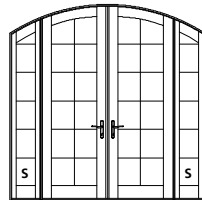

COFRTS5480Q12

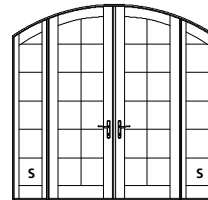

COFRTS5480Q14

112" [2845]
113 17/32" [2884]
110 7/8" [2816]
110 1/8" [2797]
96 11/16" [2456]

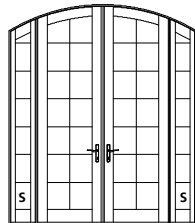

COFRTS5490Q10

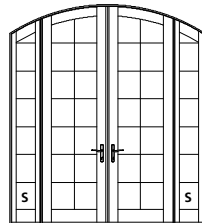

COFRTS5490Q12

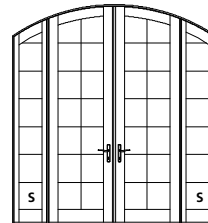

COFRTS5490Q14

ELEVATION SYMBOL LEGEND:
M.O. = MASONRY OPENING
VALUES IN () ARE NUMBER OF DAYLIGHT OPENINGS PER UNIT.
VALUES IN [] ARE IN MILLIMETER CONVERSIONS.
S PANEL IS AVAILABLE AS STATIONARY ONLY.

Note: Elevations shown DO NOT have exterior trim. Subtract 1/2" (12.7) from M.O. (Masonry Opening) for Unit Size. For other Trim Options refer to the Unit Sizing, Rough Opening & Masonry Openings page.

SCALE: 1/8" = 1'

FRENCH SECTOR TOP DOORS WITH TWO SIDELITES
6-0 UNITS

M.O. BRICKMOULD
M.O. ADAMS/FLAT CASING
ROUGH OPENING
FRAME SIZE
DAYLIGHT OPENING

105 1/16" [2669]
108 1/8" [2746]
102 9/16" [2605]
101 13/16" [2586]
26 5/8" [676] (2) - 7 1/2" [190] (2)

109 1/16" [2770]
112 1/8" [2848]
106 9/16" [2707]
105 13/16" [2688]
26 5/8" [676] (2) - 9 1/2" [241] (2)

113 1/16" [2872]
116 1/8" [2950]
110 9/16" [2808]
109 13/16" [2789]
26 5/8" [676] (2) - 11 1/2" [292] (2)

84" [2134]
85 17/32" [2172]
82 7/8" [2105]
82 1/8" [2086]
68 11/16" [1745]

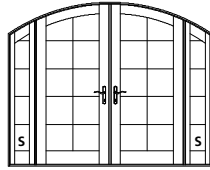

COFRTS6068Q10

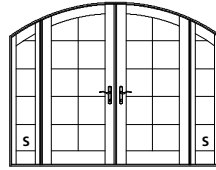

COFRTS6068Q12

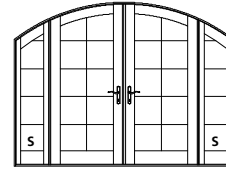

COFRTS6068Q14

88" [2235]
89 17/32" [2274]
86 7/8" [2207]
86 1/8" [2188]
72 11/16" [1873]

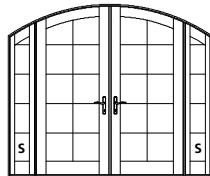

COFRTS6070Q10

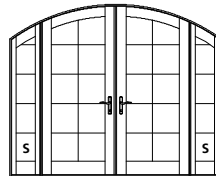

COFRTS6070Q12

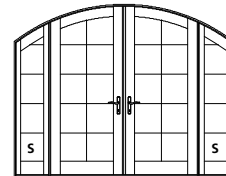

COFRTS6070Q14

100" [2540]
101 17/32" [2579]
98 7/8" [2511]
98 1/8" [2492]
84 11/16" [2151]

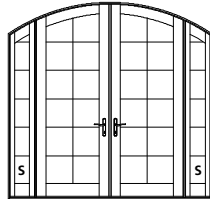

COFRTS6080Q10

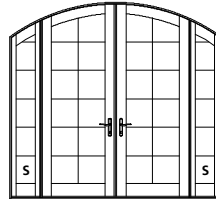

COFRTS6080Q12

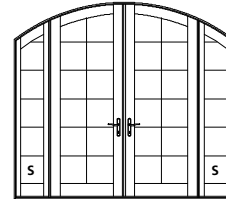

COFRTS6080Q14

112" [2845]
113 17/32" [2884]
110 7/8" [2816]
110 1/8" [2797]
96 11/16" [2456]

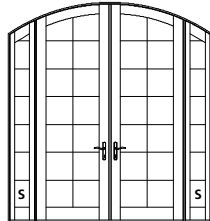

COFRTS6090Q10

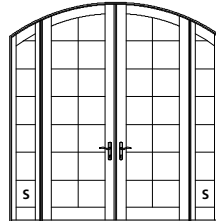

COFRTS6090Q12

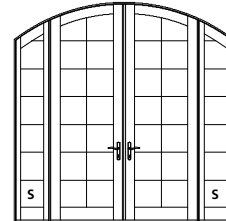

COFRTS6090Q14

ELEVATION SYMBOL LEGEND:

M.O. = MASONRY OPENING
VALUES IN () ARE NUMBER OF DAYLIGHT OPENINGS PER UNIT.
VALUES IN [] ARE IN MILLIMETER CONVERSIONS.
S PANEL IS AVAILABLE AS STATIONARY ONLY.

Note: Elevations shown DO NOT have exterior trim. Subtract 1/2" (12.7) from M.O. (Masonry Opening) for Unit Size. For other Trim Options refer to the Unit Sizing, Rough Opening & Masonry Openings page.

SCALE: 1/8" = 1'

FRENCH SECTOR TOP DOORS WITH TWO SIDELITES
7-0 UNITS

M.O. BRICKMOUND
M.O. ADAMS/FLAT CASING
ROUGH OPENING
FRAME SIZE
DAYLIGHT OPENING

117 1/16" [2973]
120 1/8" [3051]
114 9/16" [2910]
113 13/16" [2891]
32 5/8" [829] (2) - 7 1/2" [190] (2)

121 1/16" [3075]
124 1/8" [3153]
118 9/16" [3011]
117 13/16" [2992]
32 5/8" [829] (2) - 9 1/2" [241] (2)

125 1/16" [3177]
128 1/8" [3254]
122 9/16" [3113]
121 13/16" [3094]
32 5/8" [829] (2) - 11 1/2" [292] (2)

84" [2134]
85 17/32" [2172]
82 7/8" [2105]
82 1/8" [2086]
68 11/16" [1745]

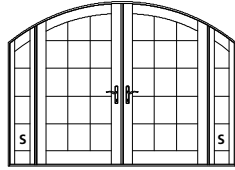

COFRTS7068Q10

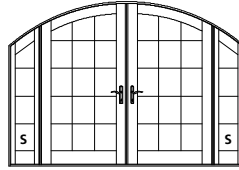

COFRTS7068Q12

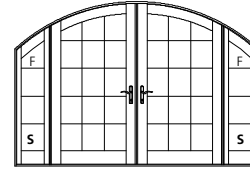

COFRTS7068Q14

88" [2235]
89 17/32" [2274]
86 7/8" [2207]
86 1/8" [2188]
72 11/16" [1846]

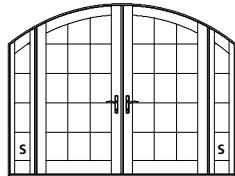

COFRTS7070Q10

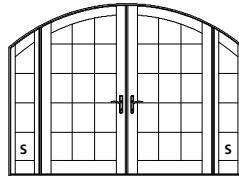

COFRTS7070Q12

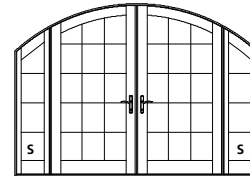

COFRTS7070Q14

100" [2540]
101 17/32" [2579]
98 7/8" [2511]
98 1/8" [2492]
84 11/16" [2151]

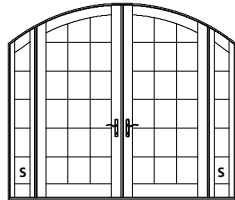

COFRTS7080Q10

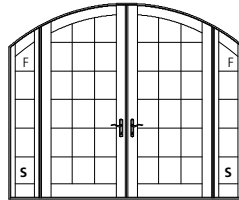

COFRTS7080Q12

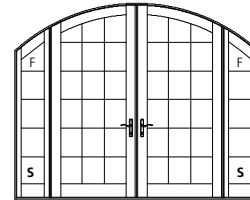

COFRTS7080Q14

ELEVATION SYMBOL LEGEND:

M.O. = MASONRY OPENING
VALUES IN () ARE NUMBER OF DAYLIGHT OPENINGS PER UNIT.
VALUES IN [] ARE IN MILLIMETER CONVERSIONS.
S PANEL IS AVAILABLE AS STATIONARY ONLY.

Note: Elevations shown DO NOT have exterior trim. Subtract 1/2" (12.7) from M.O. (Masonry Opening) for Unit Size. For other Trim Options refer to the Unit Sizing, Rough Opening & Masonry Openings page.

SECTOR TOP TRANSOM UNITS

M.O. BRICKMOULD
M.O. ADAMS/FLAT CASING
ROUGH OPENING
FRAME SIZE
DAYLIGHT OPENING

29 1/4" [743]
32 5/16" [821]
26 3/4" [679]
26" [660]
14 5/8" [371]

35 1/4" [895]
38 5/16" [973]
32 3/4" [832]
32" [813]
20 5/8" [524]

37 1/4" [946]
40 5/16" [1024]
34 3/4" [883]
34" [864]
22 5/8" [575]

41 1/4" [1048]
44 5/16" [1126]
38 3/4" [984]
38" [965]
26 5/8" [676]

22 1/2" [572]
24" [607]
20 3/4" [527]
20" [508]
13 1/2" [343]



CTOSWTS2018



CTOSWTS2618



CTOSWTS2818



CTOSWTS3018

32 1/2" [826]
34" [864]
30 3/4" [781]
30" [762]
23 1/2" [597]



CTOSWTS2026



CTOSWTS2626



CTOSWTS2826



CTOSWTS3026

M.O. BRICKMOULD
M.O. ADAMS/FLAT CASING
ROUGH OPENING
FRAME SIZE
DAYLIGHT OPENING

54 7/16" [1383]
57 1/2" [1461]
51 15/16" [1319]
51 3/16" [1300]
39 13/16" [1011]

66 7/16" [1688]
69 1/2" [1765]
63 15/16" [1623]
63 3/16" [1605]
51 13/16" [1316]

70 7/16" [1789]
73 1/2" [1867]
67 15/16" [1726]
67 3/16" [1707]
55 13/16" [1418]

78 7/16" [1992]
81 1/2" [2070]
75 15/16" [1929]
75 3/16" [1910]
63 13/16" [1621]

22 1/2" [572]
24" [607]
20 3/4" [527]
20" [508]
13 1/2" [343]



CTOFRTS4018



CTOFRTS5018



CTOFRTS5418



CTOFRTS6018

32 1/2" [826]
34" [864]
30 3/4" [781]
30" [762]
23 1/2" [597]

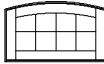

CTOFRTS4018

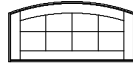

CTOFRTS5018

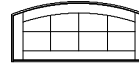

CTOFRTS5418

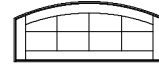

CTOFRTS6018

ELEVATION SYMBOL LEGEND:

M.O. = MASONRY OPENING
VALUES IN [] ARE IN MILLIMETER CONVERSIONS.

Note: Elevations shown DO NOT have exterior trim. Subtract 1/2" (12.7) from M.O. (Masonry Opening) for Unit Sizes. Masonry Openings above include Sill Nose, see Transom Rail & Sill Options page for Sill Nose specifications. For other Trim Options refer to the Unit Sizing, Rough Opening & Masonry Openings page.

GLAZING OPTIONS

INTERIOR GLAZED
INSULATED 3/4" [19] GLASS

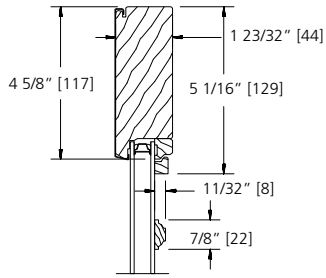

7/8" GRILLE BAR

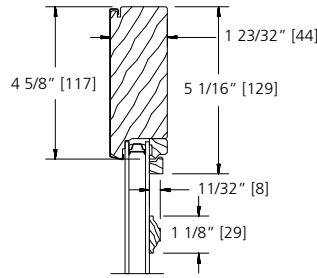

1 1/8" GRILLE BAR

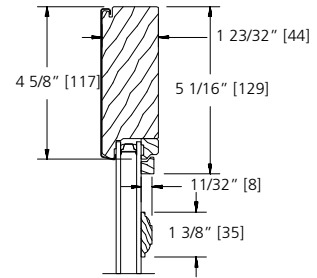

1 3/8" GRILLE BAR

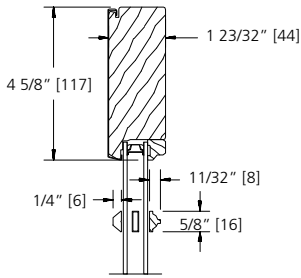

**5/8" SDL BAR
(PUTTY/BEAD)**

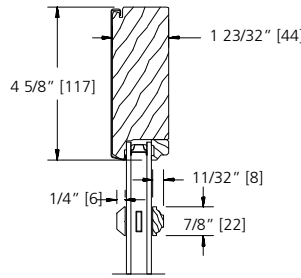

**7/8" SDL BAR
(PUTTY/BEAD)**

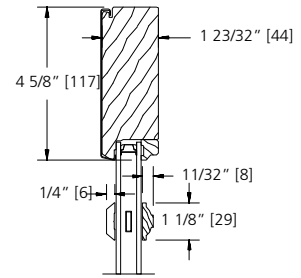

**1 1/8" SDL BAR
(PUTTY/BEAD)**

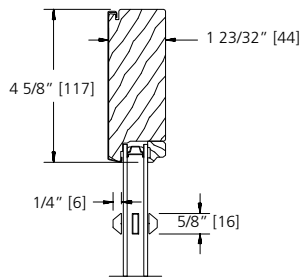

**5/8" SDL BAR
(PUTTY/PUTTY)**

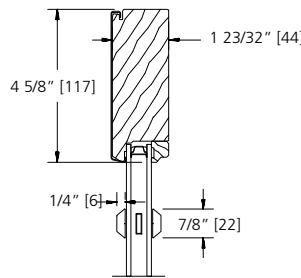

**7/8" SDL BAR
(PUTTY/PUTTY)**

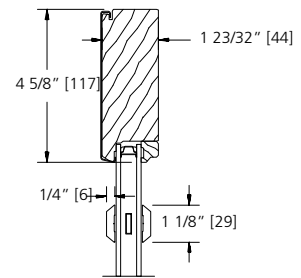

**1 1/8" SDL BAR
(PUTTY/PUTTY)**

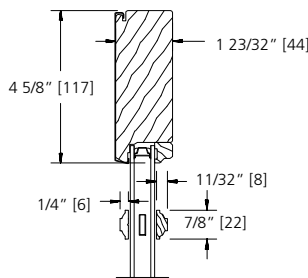

**7/8" SDL BAR
(BEAD STOP)**

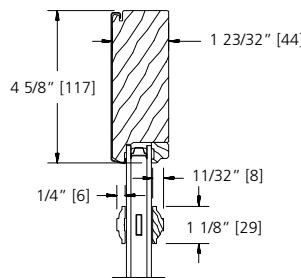

**1 1/8" SDL BAR
(BEAD STOP)**

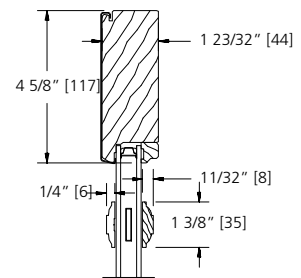

**1 3/8" SDL BAR
(BEAD STOP)**

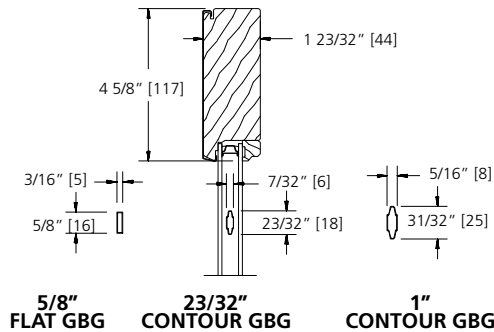

5/8" FLAT GBG 23/32" CONTOUR GBG 1" CONTOUR GBG

SCALE: NTS

GLAZING OPTIONS

INTERIOR GLAZED
SINGLE 1/8" [3] GLASS

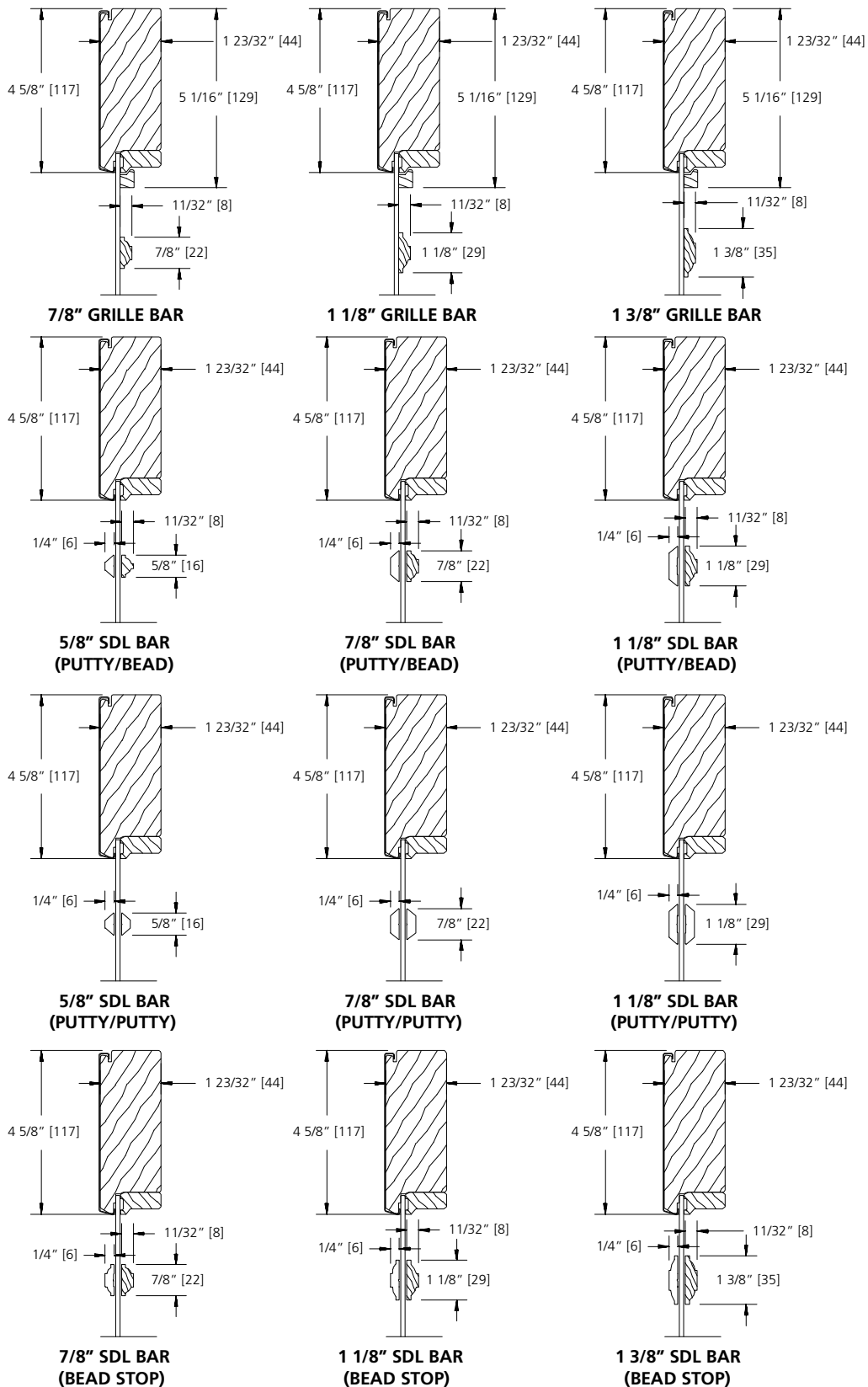

SCALE: NTS

GLAZING OPTIONS

INTERIOR GLAZED
IMPACT RESISTANT GLASS

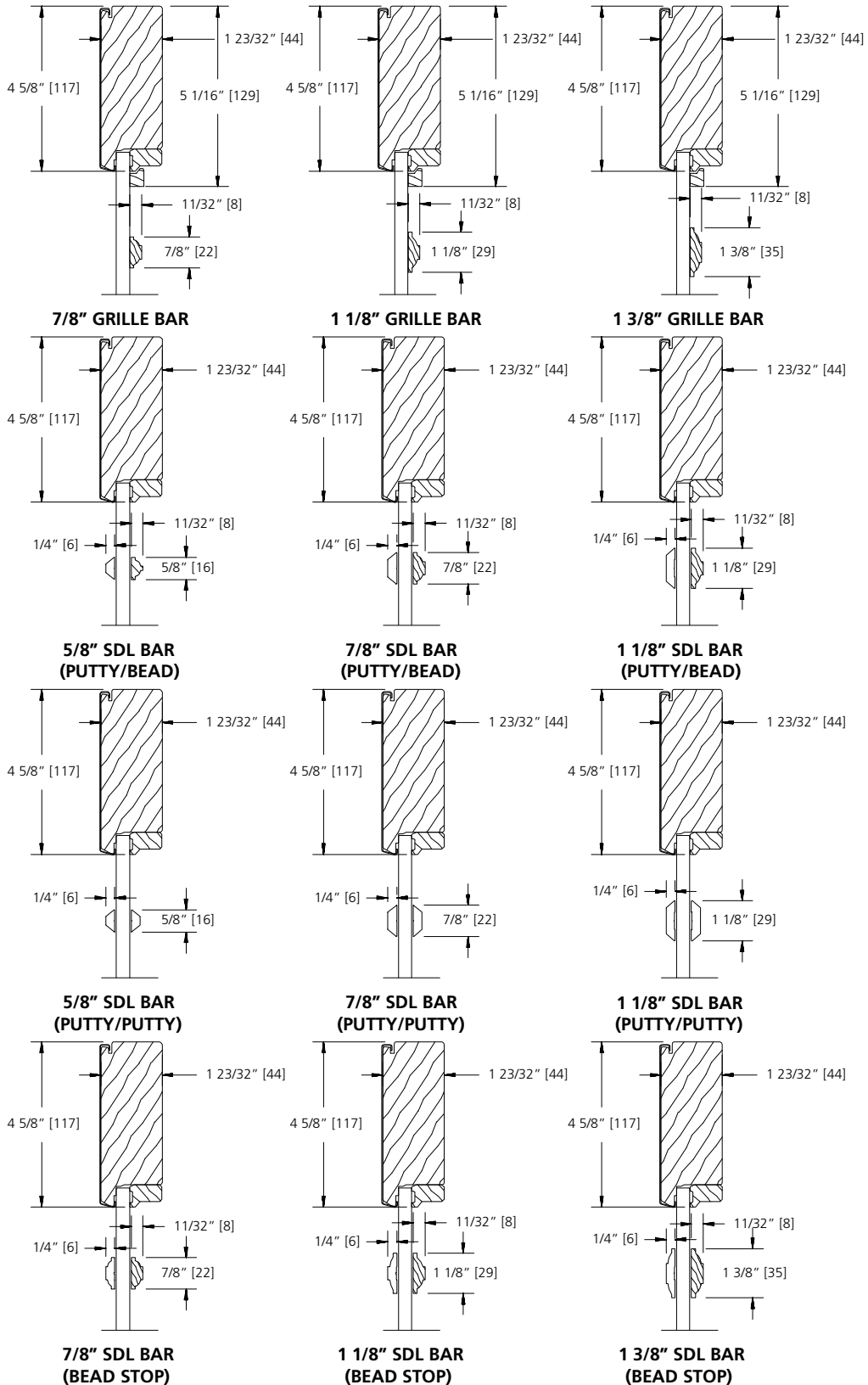

SCALE: NTS

TRIM OPTIONS

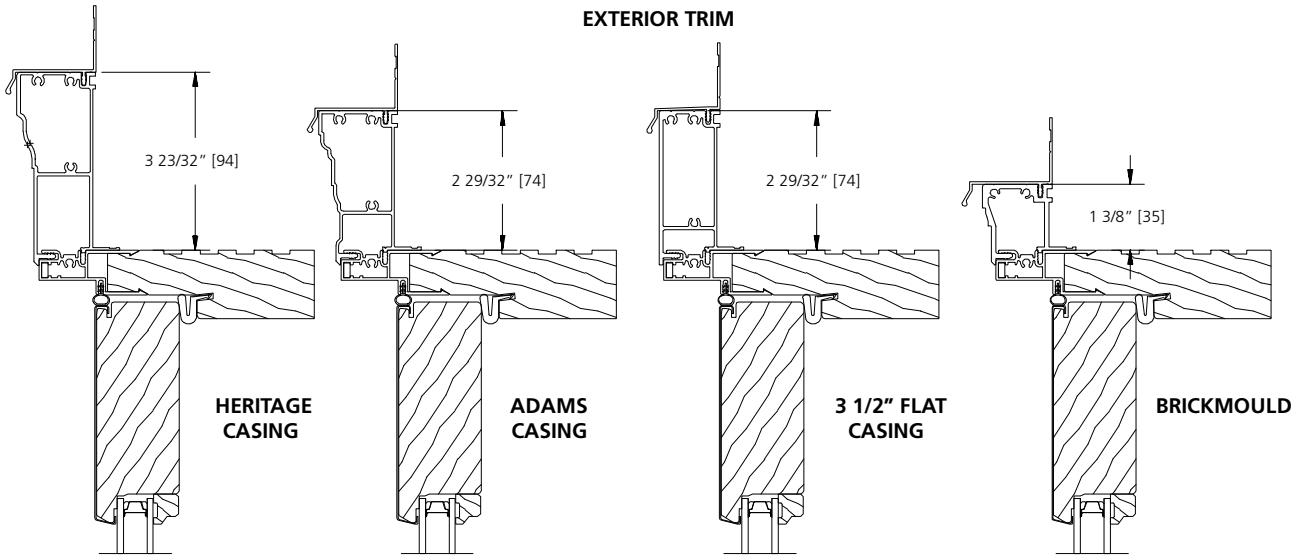

NOTE: 11/16" FOLDING NAILING FLANGE WILL BE USED ON SIDE JAMBS AND TRANSOM SILLS WITH ALL STANDARD TRIM OPTIONS

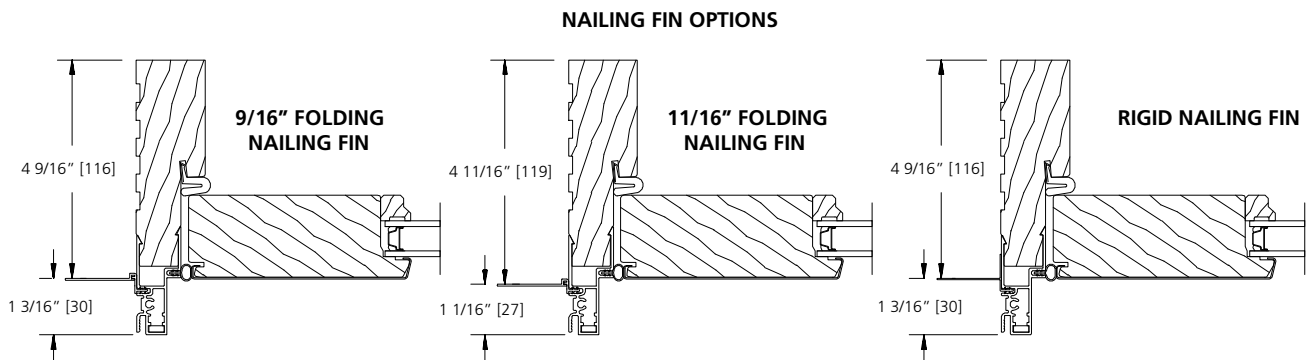
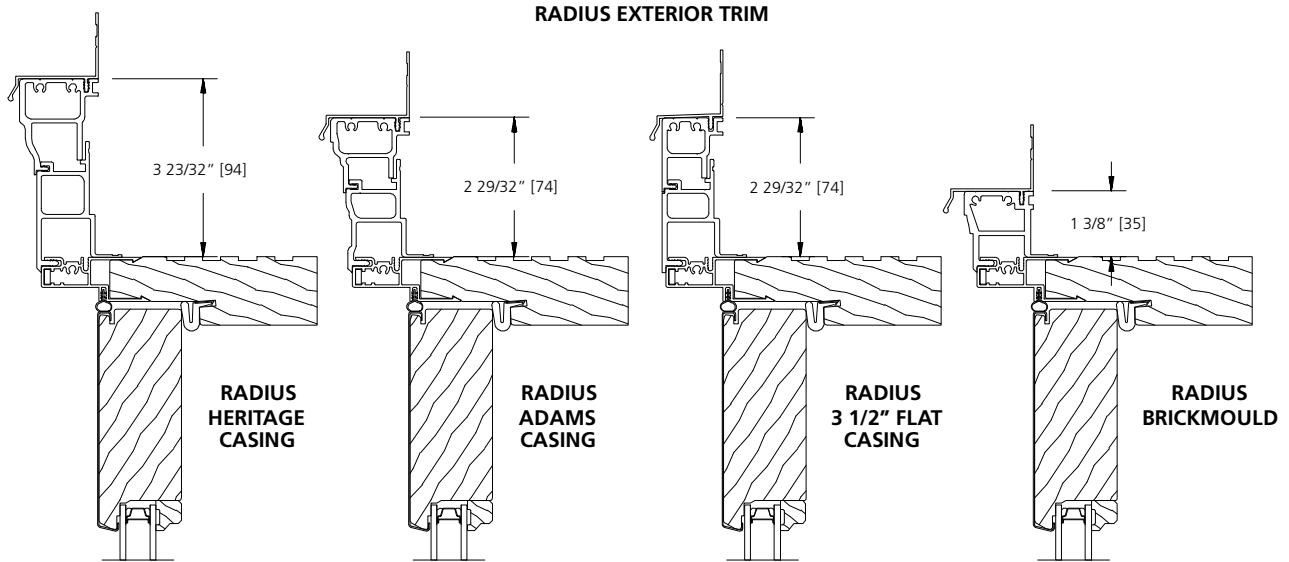

NOTE: 11/16" FOLDING NAILING FLANGE WILL BE USED ON SIDE JAMBS AND TRANSOM SILLS WITH ALL STANDARD TRIM OPTIONS. ON UNITS WITH 11/16" FOLDING NAILING FLANGE AND EXTERIOR TRIM, THE 11/16" DRIPCAP IS USED.

SCALE: 3" = 1'

RAIL, PANEL & SILL OPTIONS

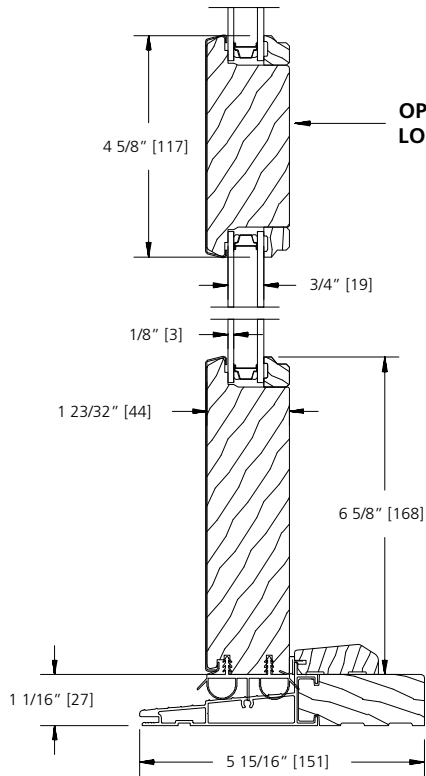

STANDARD 6 5/8" BOTTOM RAIL
STANDARD SILL (4 9/16" & 6 9/16" JAMB)

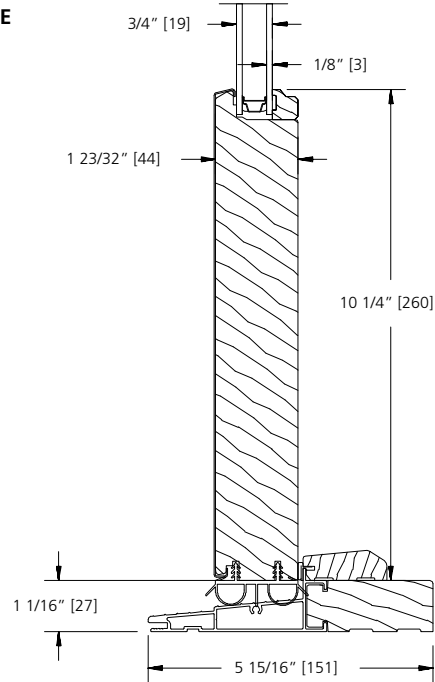

OPTIONAL 10 1/4" BOTTOM RAIL
STANDARD SILL (4 9/16" & 6 9/16" JAMB)

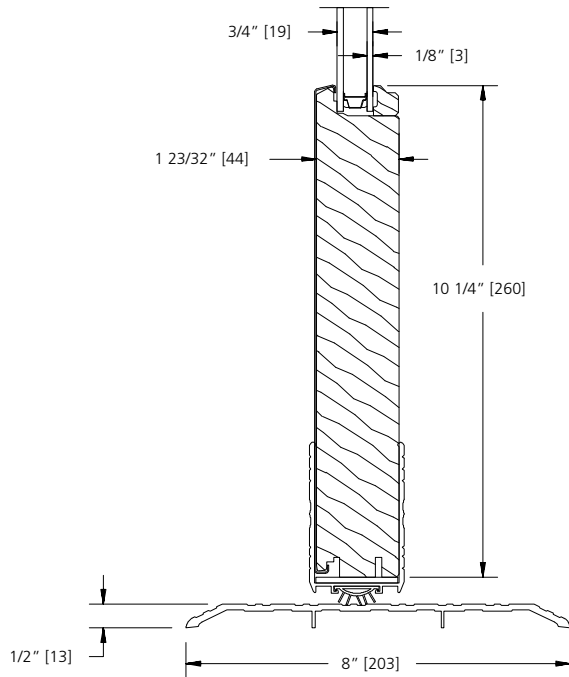

OPTIONAL 10 1/4" BOTTOM RAIL
HANDICAP SILL (4 9/16" JAMB)

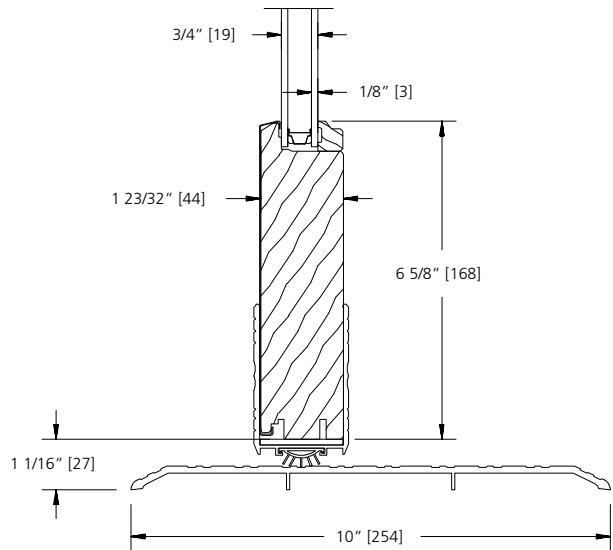

STANDARD 6 5/8" BOTTOM RAIL
HANDICAP SILL (6 9/16" JAMB)

SCALE: 3" = 1'

RAIL, PANEL & SILL OPTIONS
TRANSOM

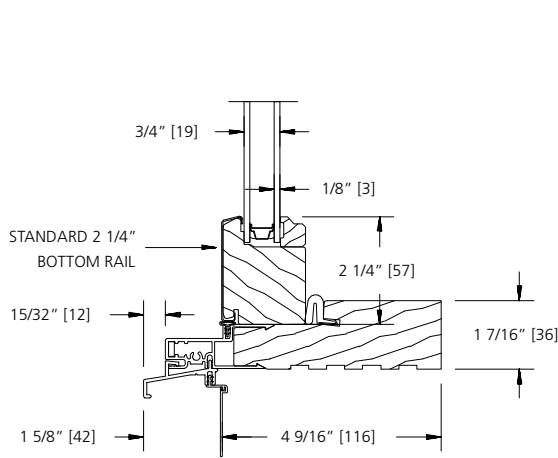

**TRANSOM
SILL NOSE
(4 9/16" JAMB)**

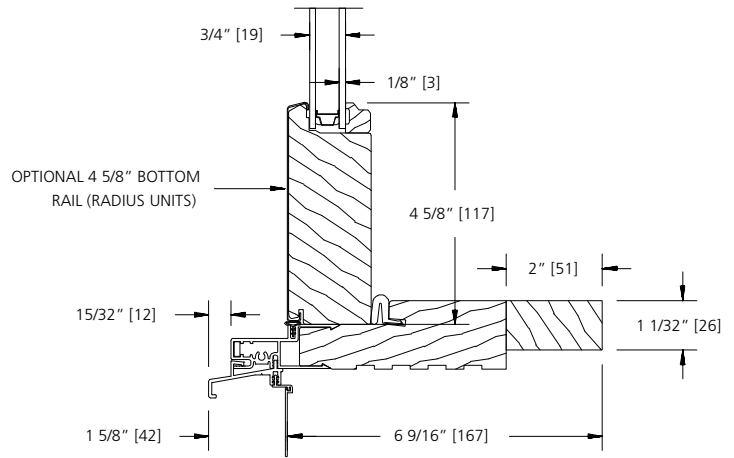

**TRANSOM
SILL NOSE
(6 9/16" JAMB)**

NOTE: SILL NOSE CAN BE USED WITH ALL STANDARD TRIM OPTIONS.

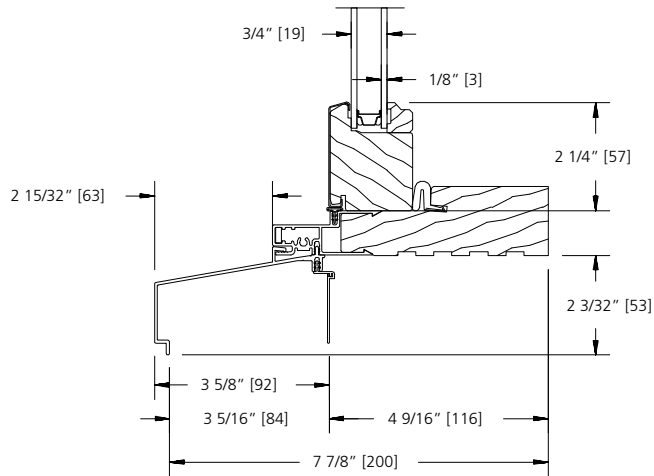

**TRANSOM
EXTENDED SILL NOSE
(4 9/16" JAMB)**

SCALE: 3" = 1'

RAIL, PANEL & SILL OPTIONS

STANDARD RAISED PANEL OPTIONS

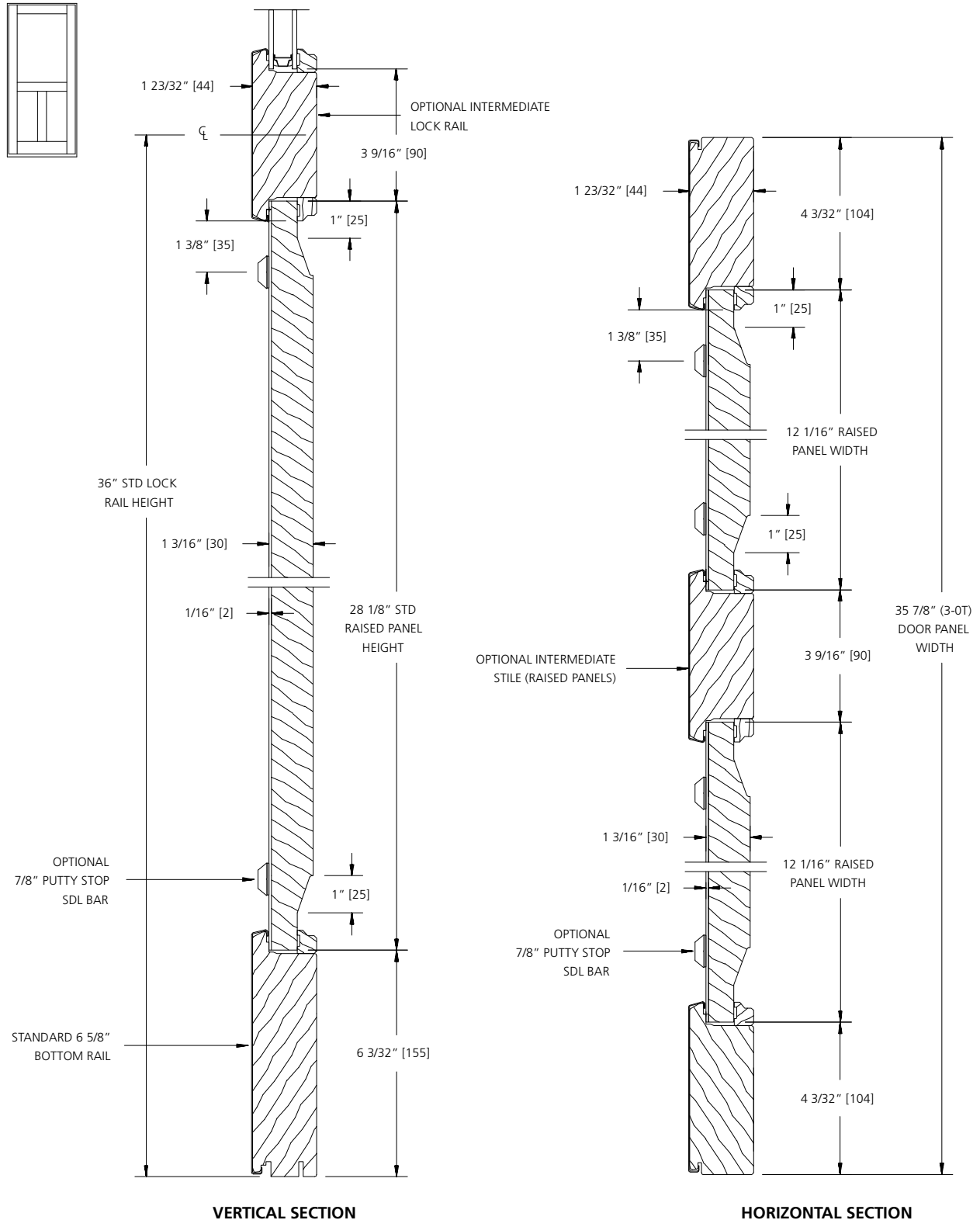

SCALE: 3" = 1'

RAIL, PANEL & SILL OPTIONS

OPTIONAL RAISED PANEL OPTIONS

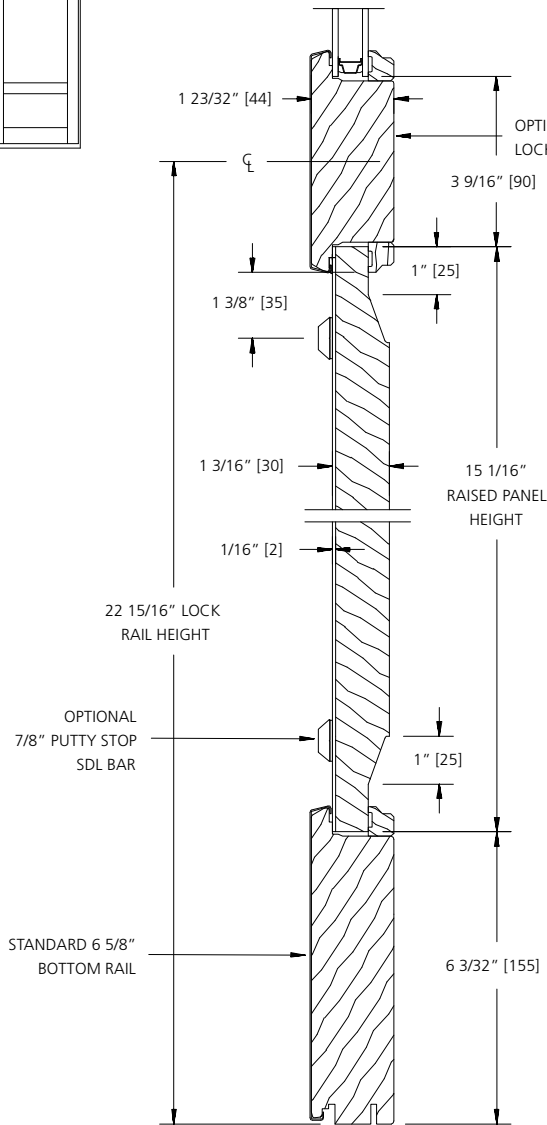
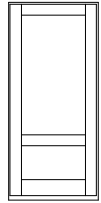

VERTICAL SECTION

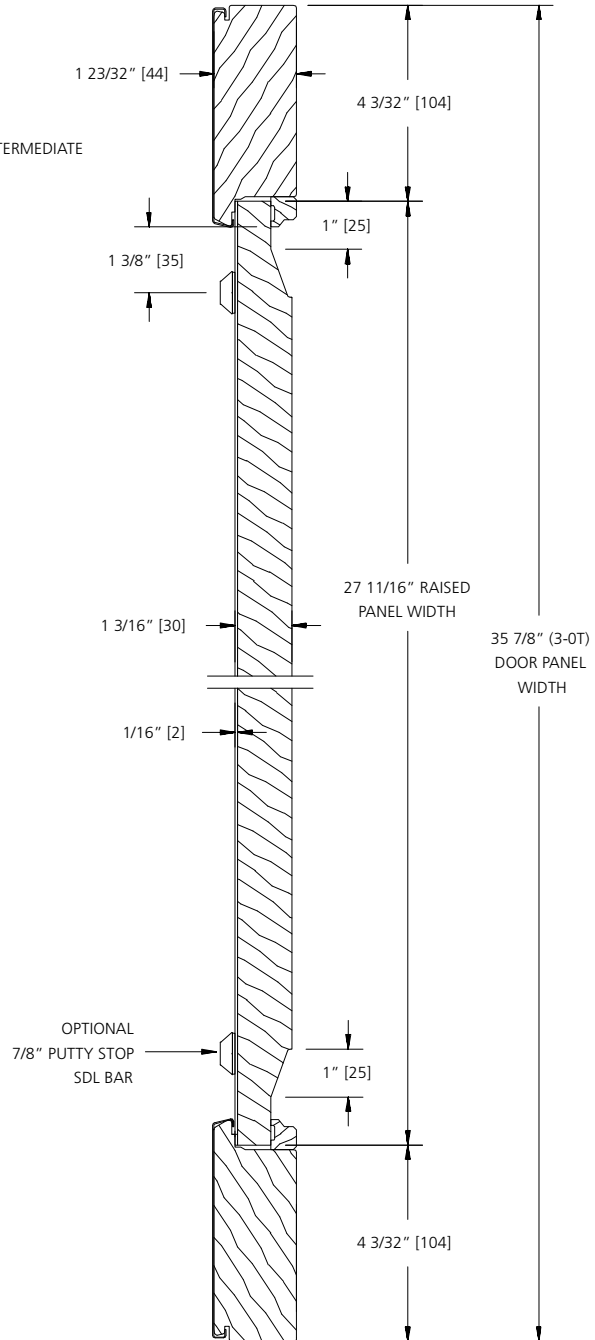

HORIZONTAL SECTION

SCALE: 3" = 1'

STANDARD MULLION DETAILS

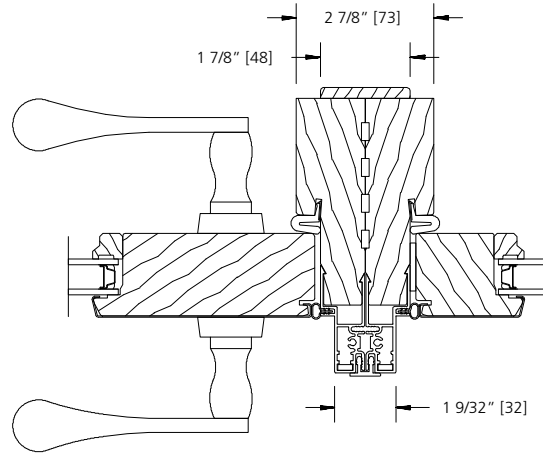

SIDE JAMB

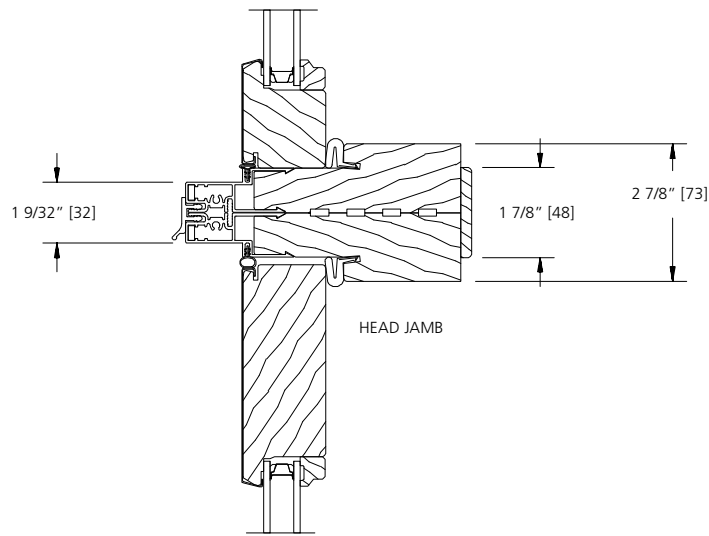

TRANSOM SILL

SCALE: 3" = 1'

LITE CUT INFORMATION

Clad out-swing patio doors are available with removable grilles in 5/8", 7/8", 1-1/8", and 1-3/8" widths, with GBG (Grilles between the Glass), or with Simulated Divided Lites. Standard lite cuts are rectangular.

LITE CUT OPTIONS

Special lite cut patterns can include a wide variety of straight line and radius patterns. The illustrations shown here represent just a few of the possibilities. Rectangular, horizontal, vertical and Prairie lite patterns are available in all standard size clad swinging patio doors. Uneven, diamond, radius, and gothic lite cuts are available, subject to approval. Approvals are based on the ability to fulfill the design requirement while maintaining the construction integrity of the finished product.

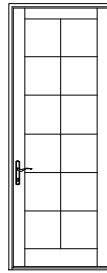

RECTANGULAR

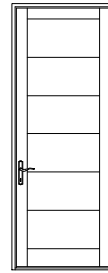

HORIZONTAL

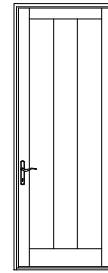

VERTICAL

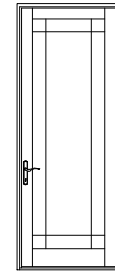

PRAIRIE

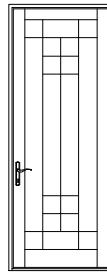

UNEVEN

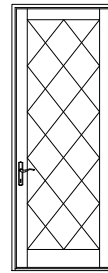

DIAMOND

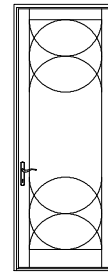

RADIUS

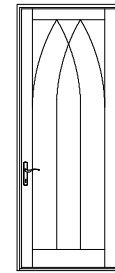

GOthic

BAR ALIGNMENT

Alignment of divided lite muntin bars from one product to the next is often required by fine architectural design. Wood grilles, GBG (Grilles between the Glass), and Simulated Divided Lites may be specified with muntin bars aligned.

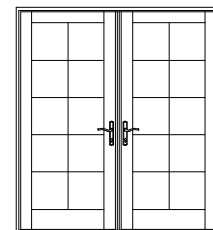
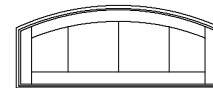
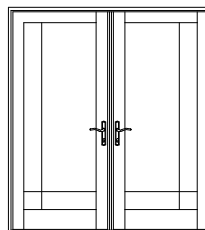
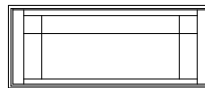

**UNIT SIZING, ROUGH OPENINGS
& MASONRY OPENINGS**

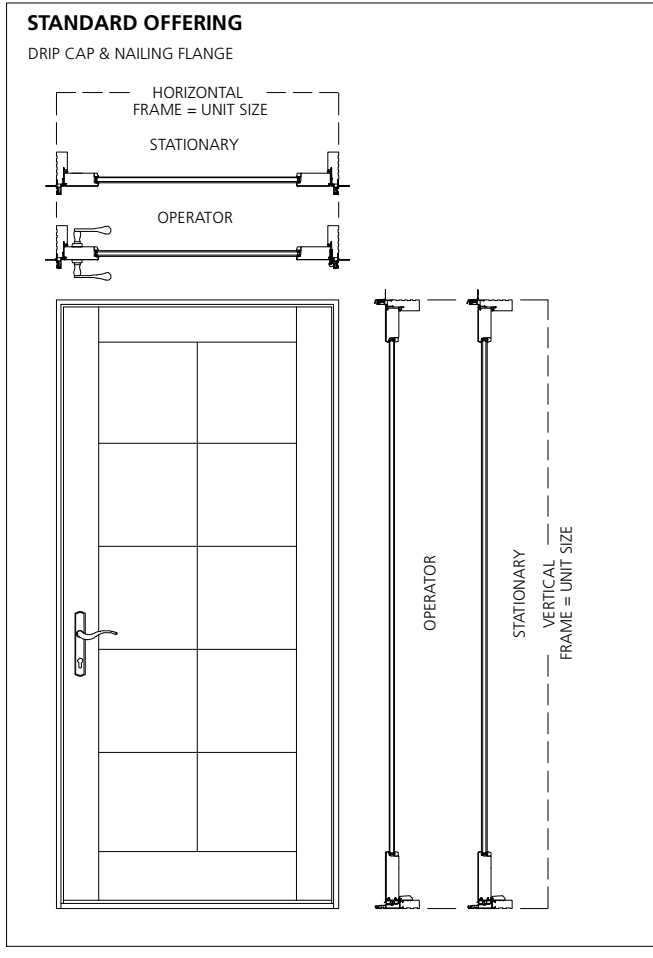

GENERAL NOTES:

UNITS WITH NO EXTERIOR TRIM
OR DRIP CAP & NAILING FLANGE:
FRAME SIZE = UNIT SIZE

UNIT SIZE IS ALWAYS THE
EXTREME SIZE OF THE DOOR
WITH OR WITHOUT TRIM
(DRIP CAP & NAILING FLANGE ARE
NOT ADDED TO ANY UNIT SIZING)

ROUGH OPENING IS ALWAYS 3/4" OVER
FRAME SIZE OF THE DOOR

MASONRY OPENING IS ALWAYS 1/2"

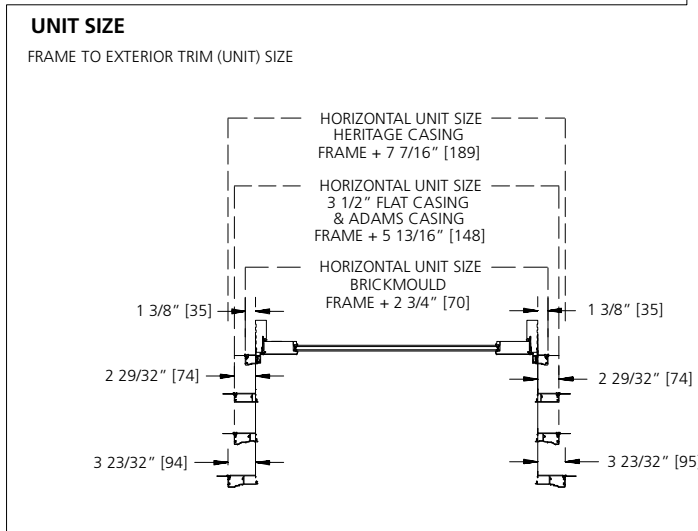
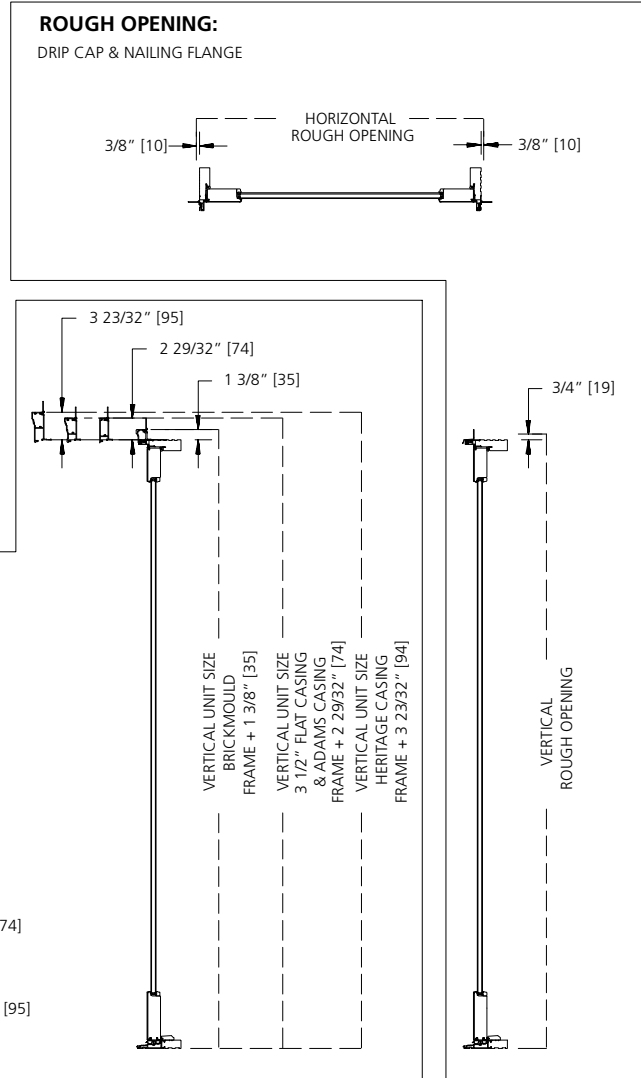

1-PANEL OPERATING UNIT

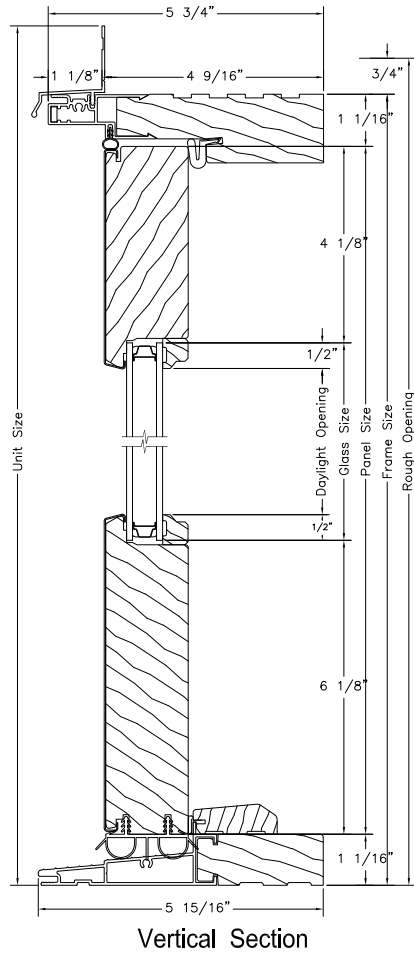

1-PANEL OPERATING UNIT

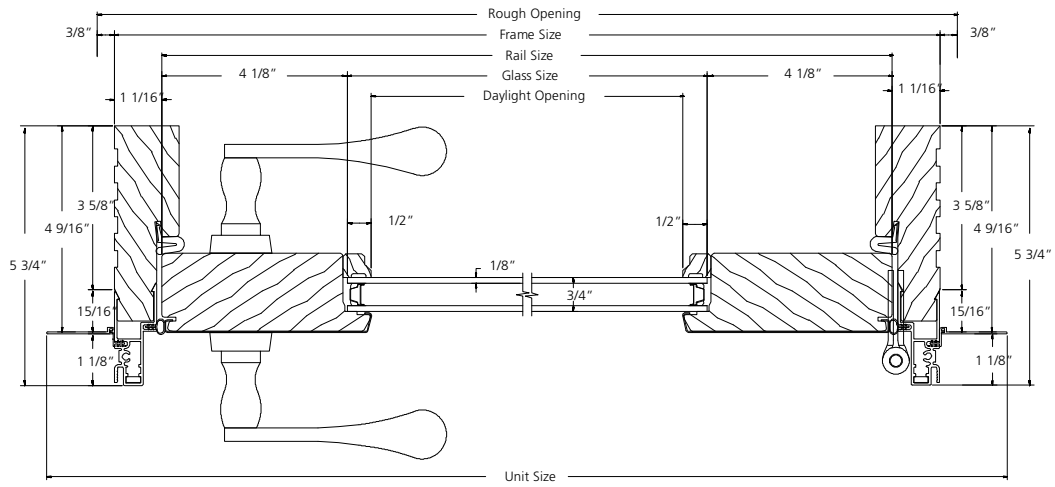

HORIZONTAL SECTION

2-PANEL UNIT

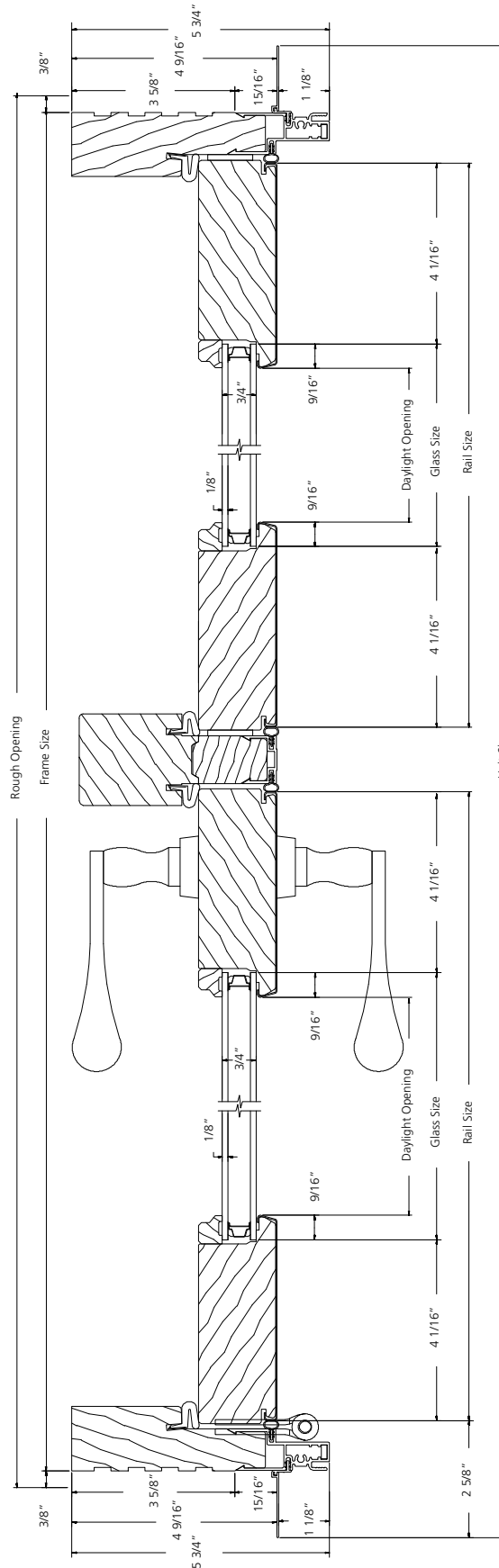

HORIZONTAL SECTION

SCALE: 3" = 1'

3-PANEL UNIT

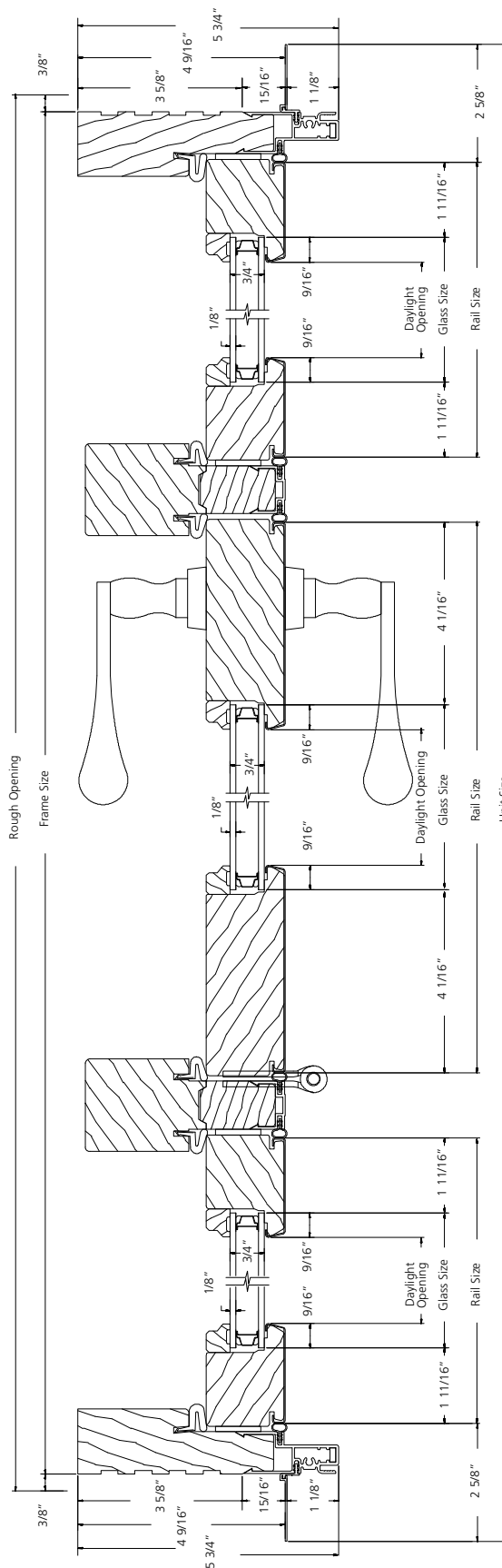

HORIZONTAL SECTION

2-PANEL FRENCH UNIT

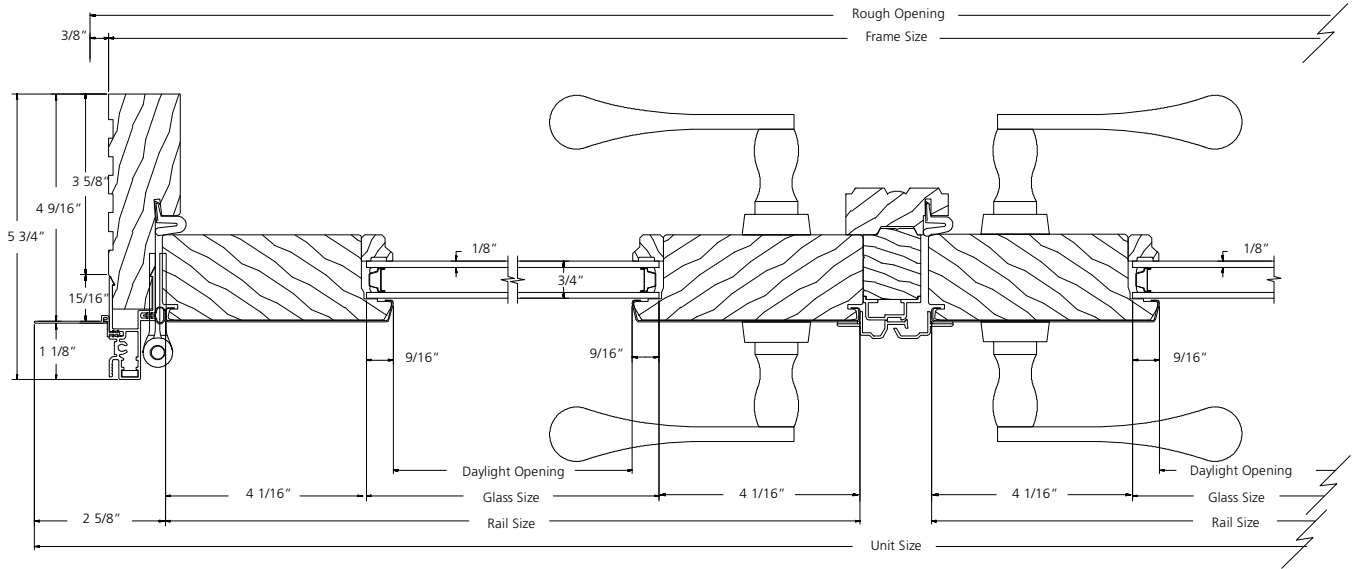

HORIZONTAL SECTION

SCALE: 3" = 1'

4-PANEL FRENCH UNIT

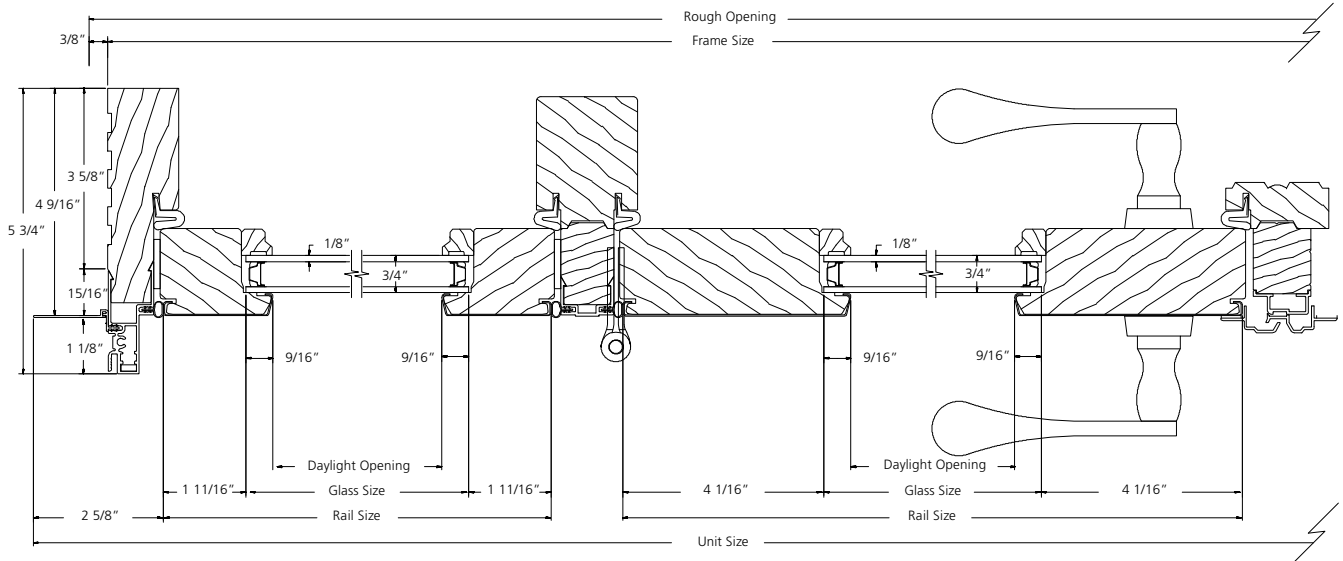

HORIZONTAL SECTION

SCALE: 3" = 1'

STATIONARY UNIT - SIDELITE

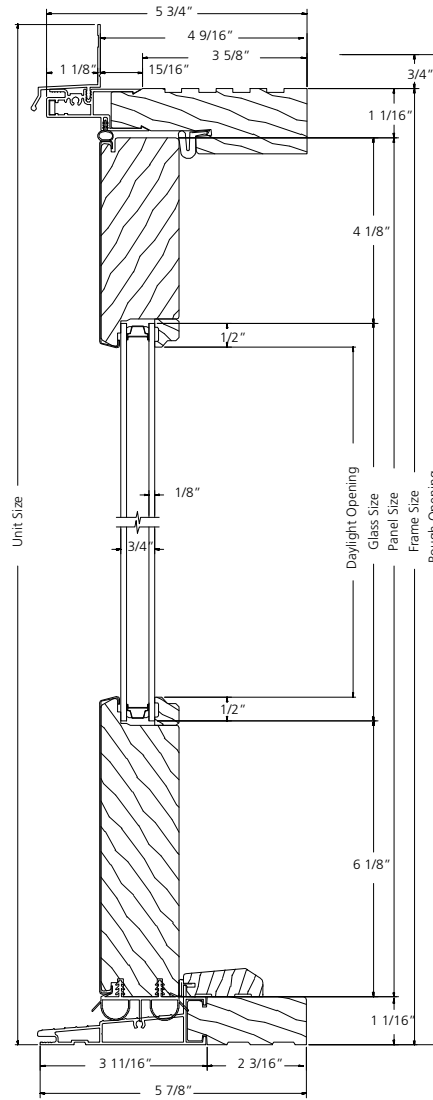

VERTICAL SECTION

SCALE: 3" = 1'

STATIONARY UNIT - SIDELITE

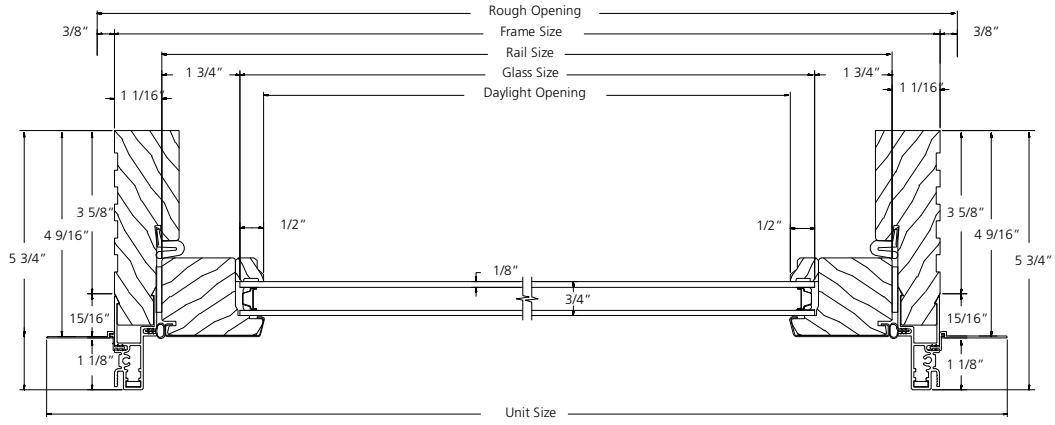

HORIZONTAL SECTION

SCALE: 3" = 1'

**SINGLE SASH TRANSOM
WITH 4-9/16" JAMB**

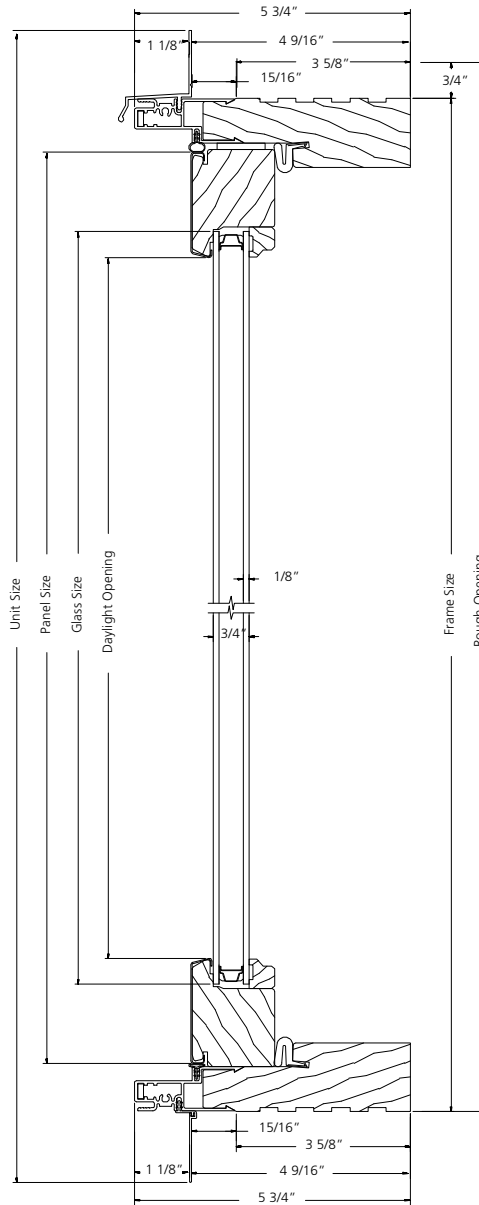

VERTICAL SECTION

SCALE: 3" = 1'

**SINGLE SASH TRANSOM
WITH 6-916" JAMB**

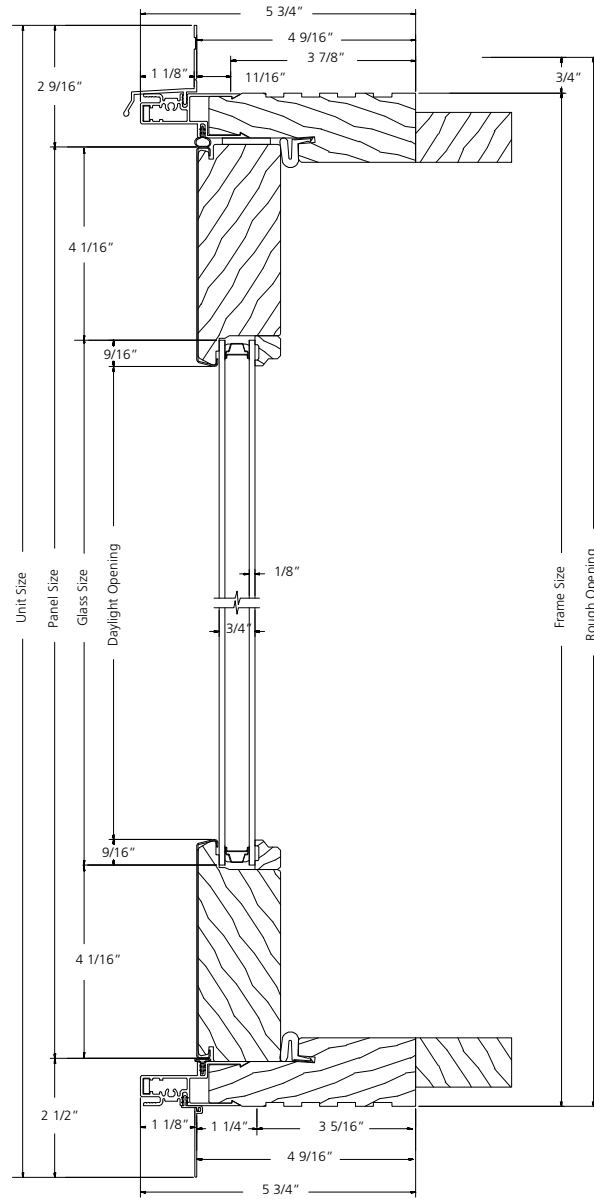

VERTICAL SECTION

SCALE: 3" = 1'

SINGLE SASH TRANSOM

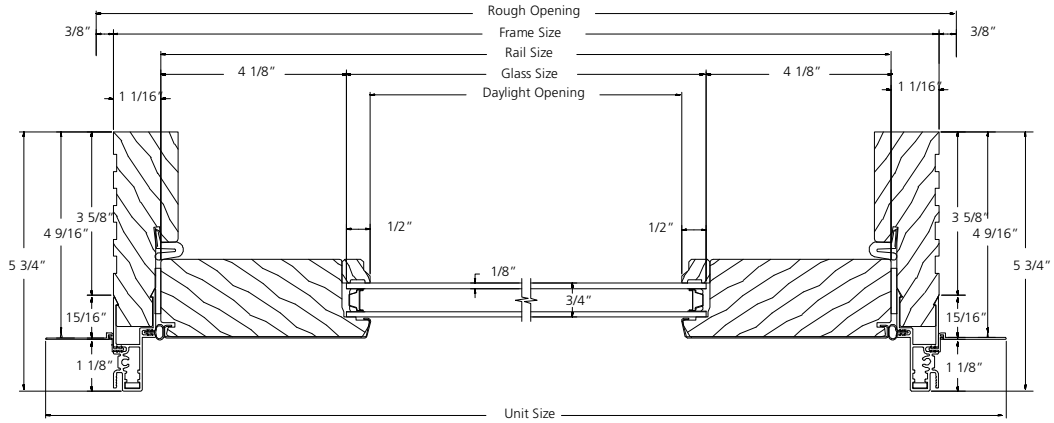

HORIZONTAL SECTION

SCALE: 3" = 1'

MULTI-SASH TRANSOM

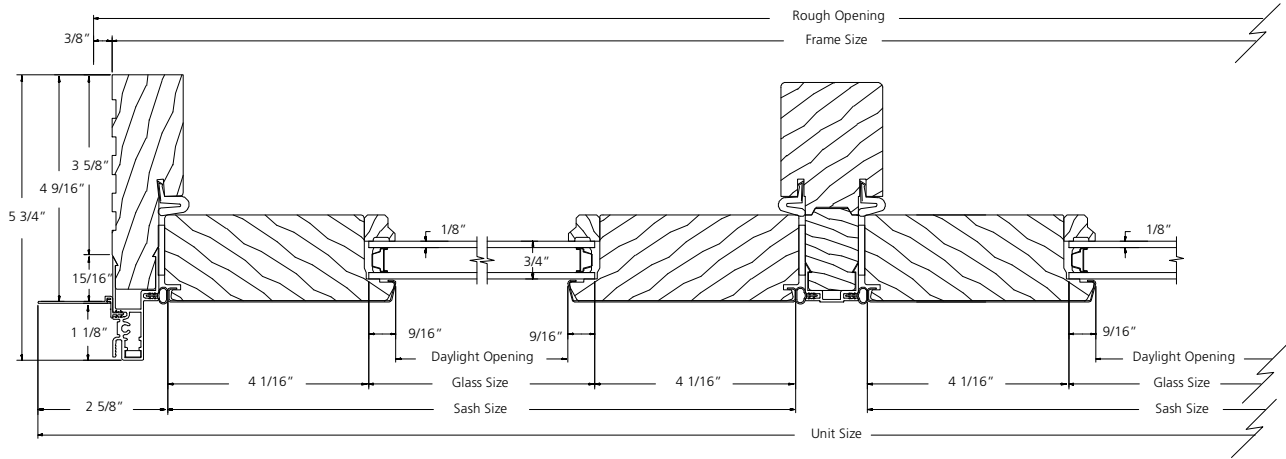

HORIZONTAL SECTION

SCALE: 3" = 1'