

---

**TABLE OF CONTENTS**

---

|  |       |
|--|-------|
| Specifications .....                                 | 23-2  |
| Quick Spec Guide .....                               | 23-4  |
| Elevations/Sizes: 1/8" Scale .....                   | 23-6  |
| Swinging Door Units .....                            | 23-8  |
| French Units .....                                   | 23-11 |
| Single Door with Single Sidelite .....               | 23-13 |
| Single Door with Two Sidelites .....                 | 23-14 |
| French Door with Two Sidelites .....                 | 23-15 |
| Transom Units .....                                  | 23-19 |
| Sector Top Doors .....                               | 23-24 |
| French Sector Top Doors .....                        | 23-26 |
| French Sector Top Doors with Two Sidelites .....     | 23-28 |
| Sector Top Transom Units .....                       | 23-32 |
| Glazing Options .....                                | 23-33 |
| Trim Options .....                                   | 23-37 |
| Rail, Panel & Sill Options .....                     | 23-38 |
| Mullion Details .....                                | 23-42 |
| Grille & SDL Patterns .....                          | 23-43 |
| Unit Sizing, Rough Openings & Masonry Openings ..... | 23-44 |
| Section Details: 3" Scale .....                      | 23-45 |

**PRODUCT SPECIFICATIONS****EXTERIOR FINISH**

The standard exterior is factory-applied latex primer with an option for unfinished (stain grade) natural pine exterior available.

**AURALAST® WOOD**

AuraLast® wood is fundamentally different from wood treated in traditional millwork preservation processes in that it uses a proprietary vacuum/pressure process to provide protection throughout the wood parts used to make windows and doors. AuraLast® wood is distinguished from wood using traditional preservation methods by its unique ability to achieve greater penetration of the active ingredients into the wood parts, with a minimum treatment penetration of 92%.

**INTERIOR FINISH**

Interior surfaces are unfinished clear pine ready for on-site finishing. Optional prefinished pine interiors include four acrylic colors (Moderate White, Extra White, Natural Choice, Pure White), five stains (Wheat, Cherry, Fruitwood, Cordovan, Cider) and a clear lacquer topcoat. Primed interior is also available.

**FRAME**

Frame is assembled from select kiln-dried pine AuraLast® wood on all exterior parts. Standard jamb width is 4-9/16". Radius frames are produced in only three different radii: 90-9/32", 37-19/16", and 31-19/32".

**PANELS**

1-23/32" thick select kiln-dried pine AuraLast® wood. The top and bottom rails are formed from solid Western Pine veneers laminated to a kiln dried edge-and-end-glued core, while the stiles have the same veneer laminated to a Timberstrand core. The layout is 4-5/8" top rail and stiles, and a 6-5/8" bottom rail. Other door rail options include wide bottom rail, lock rail and raised panels.

**GLAZING**

Insulating glass is constructed from two panes of tempered glass, utilizing a continuous roll formed stainless steel spacer with dual seal sealant. A computer-controlled application of clear silicone is used to bed the exterior of the insulating glass into the panel. An acrylic sealant is used to bed the interior. All insulating glass units comply with the performance requirements of IGCC in accordance with either ASTM E774 or E2190.

**GLAZING OPTIONS - TEMPERED**

Tempered insulating glass available in Low-E with Argon, Low-E, Low-E 366, Clear, Neat Glass, Seedy Reamy, tinted, reflective, or obscure, or other specialty glass as specified. Preserve® film is a 0.003" thick polyethylene film with a low tack acrylic adhesive applied to the glass for protection during shipping and installation. Installations at 4,000 foot elevations and higher require a capillary tube to equalize environmental stress (otherwise known as High Altitude glazing). High altitude glazing does not allow the use of Argon as listed under glazing options.

**WEATHER-STRIPPING**

Engineered system with dual foam filled bulb seal compressed between the exterior of the panel and the frame in a continuous plane on all four sides.

**SILL**

The sill is a dark bronze anodized aluminum with interior trim and an adjustable composite threshold in combination with a vinyl fin-and-bulb bottom door sweep. An optional handicapped sill with a maximum height of 1/2" is available to meet the standards set forth by the ADA for handicapped access.

**HARDWARE**

The door panels are mounted into the frame utilizing 4" x 4" heavy gauge solid brass hinges with stainless steel pins. Three hinges are used on 6-8 and 7-0 heights, and four hinges on all larger heights. Optional adjustable hinges are also available providing both vertical and horizontal adjustment. The standard finish for all hinges is Polished Brass, with optional finishes available in Antique Brass, Polished Chrome, Brushed Chrome, Oil-Rubbed Bronze, White Powder Coat, Black Powder Coat, and Satin Nickel. The standard locking system is a single point mortise with lever handle, and thumb turn dead bolt, shipped separately for field installation. Matching dummy handle sets are included for French Door applications. Optional multipoint lock systems are factory installed securing the active panel at three points. The system is manually activated from the handle.

**INSECT SCREENS**

Optional exterior sliding screen is assembled with 18 x 16 fiberglass mesh screen cloth set in an extruded aluminum frame supplied with all necessary hardware. Standard colors are Brilliant White, Chestnut Bronze, Desert Sand, French Vanilla, Hartford Green, Mesa Red, Black Licorice, Heirloom White, Hunter Green, Redwood, Sage Brown, and Smoke. Screens not available for Single Swing, French or Radius doors. Insect screens are intended to allow air and light in and to keep insects out. They are not intended to keep anyone or anything from falling through an open window. For safety screens or other security devices contact your local building supply retailer.

**GRILLES**

**SDL** (Simulated Divided Lites) - extruded aluminum muntins permanently applied to the exterior of the insulating glass unit (not available on textured glass) in 5/8", 7/8", 1-1/8", or 1-3/8" widths. Profiles are bead stop in all widths, and a putty profile in 5/8", 7/8", and 1-1/8" widths only. 1" Copper SDL is also available. SDL is standard with a light bronze internal shadow bar to give a true divided lite appearance. As an option, SDL may be ordered with a silver shadow bar. Clear wood interior muntin bars match the exterior muntin width and are permanently bonded to the interior of the glass. Also available is a 2-5/16" SDL bar, which simulates a double-hung checkrail.

**PDL** (Precise Divided Lites) - Wood or extruded aluminum muntins permanently applied to the exterior of the insulating unit (not available on textured glass) in 3/4" and 1-1/2" widths or without a shadow bar. Clear wood interior muntin bars match the exterior muntin width and are permanently bonded to the interior of the glass.

**Full-Surround Removable Wood Grilles** - Rectangular, unfinished interior clear pine wood grilles in 7/8", 1-1/8", and 1-3/8" are available in patterns selected by the owner.

**GBG** (Grilles between the Glass) - 5/8" flat, 23/32" contour, or 1" contour grilles mounted between the glass panes suspended within the air cavity.

*Continued on next page*

---

**PRODUCT SPECIFICATIONS**

---

**EXTERIOR TRIM**

Brickmould standard with optional 3-1/2", 4-1/2", 5-1/2" flat trim, 3-1/2" Adams and 1 x 4 Backband trim. Optional mull covers to accommodate 1" (spread only), 2", 3-1/2" and 6" spread and stud pocket mull.

**EXTENSION JAMBS**

Extension jambs are available for wall depths up to 6-9/16".

**INSTALLATION**

Installation per JELD-WEN Installation Method for Wood Patio Doors. See [www.jeld-wen.com/resources](http://www.jeld-wen.com/resources) for instructions.

**PERFORMANCE**

**ANSI/AAMA/NWDA/101/I.S.2-97**  
**AMMA/WDMA/CSA 101/I.S.2/A440-05**  
**WDMA Hallmark Certified**

See [www.jeld-wen.com](http://www.jeld-wen.com) for architectural and performance information.

**QUICK SPEC GUIDE**

| SPECIFICATION                 | STANDARD FEATURES  | OPTIONAL FEATURES<br><i>Some options may require additional lead times.<br/>Consult your JELD-WEN Sales Representative.</i>  |
|-------------------------------|--|--|
| <b>EXTERIOR FINISH</b>        | <ul style="list-style-type: none"> <li>• Primed</li> </ul>   | <ul style="list-style-type: none"> <li>• Natural</li> <li>• Vertical Grain Douglas Fir</li> <li>• Mahogany</li> </ul>  |
|                               |  | Panel Only: <ul style="list-style-type: none"> <li>• Natural Copper*      <i>*Copper is only available when ordered with a clad panel</i></li> <li>• Speckled Patina Copper</li> <li>• Hand Rubbed Copper</li> </ul>   |
| <b>EXTERIOR TRIM</b>          | <ul style="list-style-type: none"> <li>• Brickmould &amp; Subsill</li> </ul>   | <ul style="list-style-type: none"> <li>• Adams Casing</li> <li>• 3-1/2" Flat Casing</li> <li>• 4-1/2" Flat Casing</li> <li>• 5-1/2" Flat Casing</li> </ul>   |
| <b>INTERIOR WOOD</b>          | <ul style="list-style-type: none"> <li>• Western Pine</li> </ul>   |  |
| <b>INTERIOR FINISH</b>        | <ul style="list-style-type: none"> <li>• Natural</li> </ul>  | <ul style="list-style-type: none"> <li>• Priming Available</li> </ul> Pre-finished Interior Options are: <ul style="list-style-type: none"> <li>• Paint - Pure White, Extra White, Natural Choice, Moderate White</li> <li>• Stain - Wheat, Fruitwood, Cherry, Cordovan, Cider</li> <li>• Clear Lacquer</li> </ul>   |
| <b>SIZE</b>                   | <ul style="list-style-type: none"> <li>• Width: 2-0, 2-6, 2-8, 3-0, 3-6, 5-0, 5-4, 6-0, 7-6, 8-0, 9-0</li> <li>• Height: 6-8, 7-0, 8-0, 9-0</li> </ul>     | <ul style="list-style-type: none"> <li>• Any Panel Width: 2-0 to 3-6 (Certain restrictions apply)</li> <li>• Any Panel Height: 4-0 to 10-0 (Certain restrictions apply)</li> </ul>   |
| <b>GLAZING (ALL TEMPERED)</b> | <ul style="list-style-type: none"> <li>• Low-E Tempered Insulating Glass (with Argon)</li> <li>• Low-E 366</li> <li>• Preserve® Protective Film</li> </ul> | <ul style="list-style-type: none"> <li>• Clear</li> <li>• Obscure</li> <li>• Reflective</li> <li>• Tints: Bronze, Gray, Green</li> <li>• Glue Chip</li> <li>• Neat Glass</li> <li>• Seedy Reamy</li> <li>• Safety Laminate in Clear, Bronze or Gray</li> <li>• Rain</li> <li>• Narrow Reed</li> <li>• Sandblasted</li> <li>• Tempered</li> <li>• Impact Resistant</li> </ul>   |
|                               |  | <ul style="list-style-type: none"> <li>• High Altitude (Breather Tube, no Argon)</li> </ul>  |
| <b>GRILLES</b>                |  | SDL Bead Profile: <ul style="list-style-type: none"> <li>• 5/8", 7/8", 1-1/8", 1-3/8", 2-5/16" with Light Bronze Shadow Bar</li> <li>• 5/8", 7/8", 1-1/8", 1-3/8", 2-5/16" with Silver Shadow Bar</li> </ul> SDL Putty Profile: <ul style="list-style-type: none"> <li>• 5/8", 7/8" and 1-1/8" with Light Bronze Shadow Bar</li> <li>• 5/8", 7/8" and 1-1/8" with Silver Shadow Bar</li> </ul> <ul style="list-style-type: none"> <li>• 1" Copper SDL</li> </ul> PDL: <ul style="list-style-type: none"> <li>• 3/4" or 1-1/2" Precise Divided Lite</li> </ul> GBG (Grilles between the Glass): <ul style="list-style-type: none"> <li>• 5/8" Flat, 23/32" Contour, 1" Contour</li> </ul> Full-Surround: <ul style="list-style-type: none"> <li>• 7/8", 1-1/8", 1-3/8"</li> </ul> |

*Continued on next page*

**QUICK SPEC GUIDE**

| SPECIFICATION             | STANDARD FEATURES   | OPTIONAL FEATURES<br><i>Some options may require additional lead times.<br/>Consult your JELD-WEN Sales Representative.</i>  |
|---------------------------|---|--|
| <b>HARDWARE</b>           | <ul style="list-style-type: none"> <li>• 4 x 4 Heavy Gauge Hinges</li> <li>• Single Point Mortise Lock with Lever Handle</li> </ul>   | <ul style="list-style-type: none"> <li>• Adjustable Hinges</li> <li>• Multipoint Manually Activated Lock</li> </ul>  |
| <b>HARDWARE COLOR</b>     | <ul style="list-style-type: none"> <li>• Polished Brass</li> </ul>  | <ul style="list-style-type: none"> <li>• Antique Brass</li> <li>• Polished Chrome</li> <li>• Brushed Chrome</li> <li>• Oil-Rubbed Bronze</li> <li>• White Powder Coat</li> <li>• Black Powder Coat</li> </ul>  |
| <b>JAMB</b>               | <ul style="list-style-type: none"> <li>• Applied, 5/4</li> <li>• 4-9/16"</li> </ul>   | <ul style="list-style-type: none"> <li>• Up to 6-9/16"</li> </ul>  |
| <b>INSECT SCREENS</b>     |   | <ul style="list-style-type: none"> <li>• Fiberglass</li> </ul>   |
| <b>SCREEN FRAME COLOR</b> | <ul style="list-style-type: none"> <li>• Brilliant White</li> <li>• Chestnut Bronze</li> <li>• Desert Sand</li> <li>• French Vanilla</li> <li>• Mesa Red</li> <li>• Hartford Green</li> <li>• Black Licorice</li> <li>• Heirloom White</li> <li>• Hunter Green</li> <li>• Redwood</li> <li>• Sage Brown</li> <li>• Smoke</li> </ul> | <ul style="list-style-type: none"> <li>• Black Emerald</li> <li>• Bone White</li> <li>• Bronze</li> <li>• Buckskin</li> <li>• Cambridge White</li> <li>• Capri Blue</li> <li>• Cascade</li> <li>• Champagne</li> <li>• Clover Mist</li> <li>• Dark Buckskin</li> <li>• Dark Ivy</li> <li>• Deep Summer</li> <li>• Garnet</li> <li>• Haverstraw</li> <li>• Hudson Blue</li> <li>• Ivory</li> <li>• Ivy</li> <li>• Liberty Blue</li> <li>• Mocha Cream</li> <li>• Mosiac Green</li> <li>• Pueblo Tan</li> <li>• Rosewood</li> <li>• Scarlet Haze</li> <li>• Sea Foam</li> <li>• Teal</li> <li>• Wedgewood</li> <li>• White</li> <li>• Clear Satin Anodized</li> <li>• Custom Color Matching</li> </ul> |

**GENERAL INFORMATION**

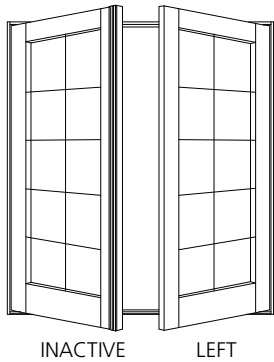

**DIMENSIONAL DOORS**

Wood in-swing patio doors may be specified as "dimensional" by adjusting the desired rough opening width or height in 1/4" increments from standard.

Wood in-swing patio doors are available in single, twin, triple and quad panel doors. Transoms are available to match the variety of door sizes. The standard size range includes sizes specifically designed for replacement of older patio door models in existing structures, as well as a full range of "true size" products for architectural consistency.

**OPERATION**

Wood in-swing patio doors are available in a full range of operating styles. Single panel doors may be specified as stationary (non-venting) or can operate left or right. Center swing two- or three-panel doors are available with left or right operation. French doors feature two operating panels (one active, which opens first; and one inactive, which closes first), and are available in two-panel and four-panel styles. Configuration and handing is based on viewing the door from the interior.

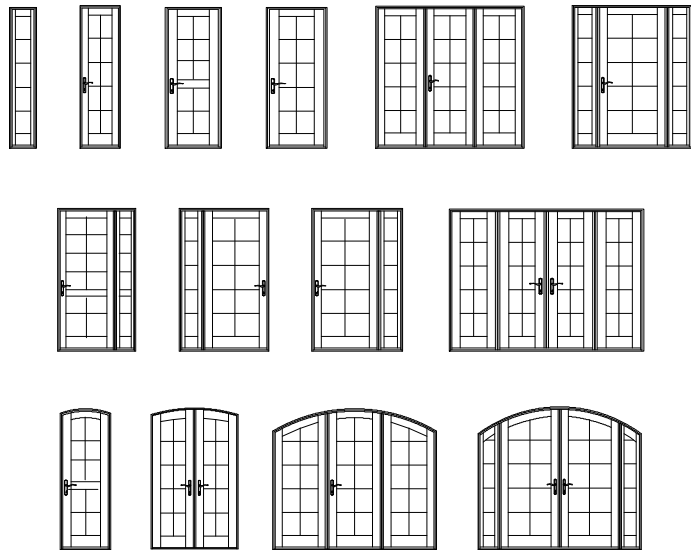

**MULTIPLE ASSEMBLIES**

Wood in-swing patio doors are available in a wide variety of multiple panel configurations from the factory, all of which are assembled with continuous sills. Wood in-swing patio doors may be mullered below or beside other wood door and wood window products. Factory assembled mulls are limited in height (100"), width (150"), and a total area (75 square feet).



**ELEVATION NOTES**

ELEVATION DRAWINGS UTILIZE A LIMITED NUMBER OF PROJECTED LINES TO PRODUCE A RUDIMENTARY DRAWING INTENDED TO BE USED IN A SMALL GRAPHICAL SCALE. ELEVATIONS ARE VIEWED PERPENDICULAR FROM THE EXTERIOR OF THE STRUCTURE. IF MORE DIMENSIONS ARE NEEDED, USE THE SECTION DRAWINGS FOR MORE COMPLETE DEPICTIONS.

|                        |                   |  |
|------------------------|-------------------|--|
| M.O. Brickmould        | 40 9/16" [ 1030 ] | Masonry Openings for Brickmould, Flat & Adams Casing. Vertical measurements for transoms include sill nose. (Subtract 1/2" from Masonry Opening for Unit Size) |
| M.O. Adams/Flat Casing | 43 5/8" [ 1108 ]  |  |
| Rough Opening          | 38 3/16" [ 970 ]  |  |
| Frame Size             | 37 7/16" [ 951 ]  |  |
| Daylight Opening       | 26 5/8" [ 676 ]   |  |

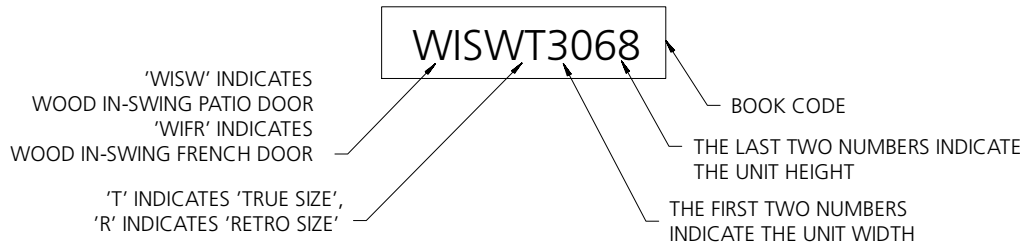
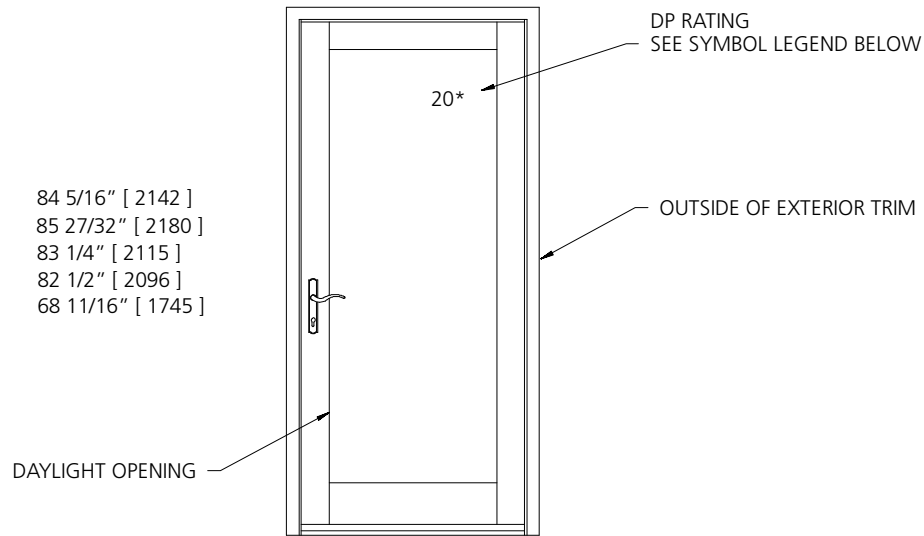

**GENERAL SWINGING DOOR NOTES**

1. WOOD IN-SWING PATIO DOOR (WISW) UNITS ARE AVAILABLE AS OPERATING OR STATIONARY UNITS.
2. UNIT ELEVATIONS ARE SHOWN WITH BRICKMOULD. TRANSOM UNITS ARE SHOWN WITH BRICKMOULD AND SILL NOSE.
3. OPERATING UNITS ARE AVAILABLE AS LEFT OR RIGHT HAND OPERATION.
4. HANDICAP SILL, 10 1/4" BOTTOM RAILS AND INTERMEDIATE LOCK RAILS ARE AVAILABLE FOR ALL UNITS.

**ELEVATION SYMBOL LEGEND:**

- S** PANEL IS AVAILABLE AS STATIONARY ONLY.
- ###** NUMBER INDICATES DESIGN PRESSURE (DP) RATING WITH STANDARD GLAZING. OPERATING UNITS UTILIZE MULTI-POINT LOCKING HARDWARE FOR DP RATINGS.

### 1-PANEL UNITS

**M.O. BRICKMOULD**  
**M.O. ADAMS/FLAT CASING**  
**ROUGH OPENING**  
**FRAME SIZE**  
**DAYLIGHT OPENING**

26 9/16" [675]  
 29 5/8" [752]  
 24 3/16" [614]  
 23 7/16" [595]  
 12 5/8" [321]

32 9/16" [827]  
 35 5/8" [905]  
 30 3/16" [767]  
 29 7/16" [748]  
 18 5/8" [473]

34 9/16" [878]  
 37 5/8" [956]  
 32 3/16" [818]  
 31 7/16" [799]  
 20 5/8" [524]

38 9/16" [979]  
 41 5/8" [1057]  
 36 3/16" [919]  
 35 7/16" [900]  
 24 5/8" [625]

81 5/16" [2065]  
 82 27/32" [2104]  
 80 1/4" [2038]  
 79 1/2" [2019]  
 65 11/16" [1668]

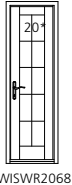

WISWR2068

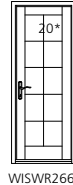

WISWR2668

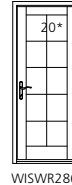

WISWR2868

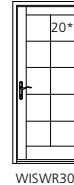

WISWR3068

97 5/16" [2472]  
 98 27/32" [2511]  
 96 1/4" [2445]  
 95 1/2" [2426]  
 81 11/16" [2075]



WISWR2080

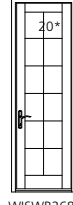

WISWR2680

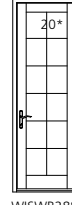

WISWR2880

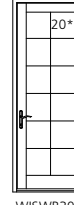

WISWR3080

109 5/16" [2777]  
 110 27/32" [2815]  
 108 1/4" [2750]  
 107 1/2" [2731]  
 93 11/16" [2380]

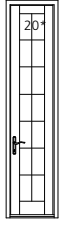

WISWR2090

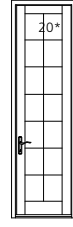

WISWR2690

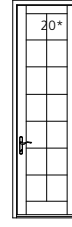

WISWR2890

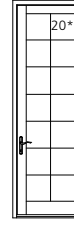

WISWR3090

**ELEVATION SYMBOL LEGEND:**

**M.O.** = MASONRY OPENING  
 VALUES IN [ ] ARE IN MILLIMETER CONVERSIONS.  
**S** PANEL IS AVAILABLE AS STATIONARY ONLY.  
**###** NUMBER INDICATES DESIGN PRESSURE (DP) RATING WITH STANDARD GLAZING. OPERATING UNITS UTILIZE MULTI-POINT LOCKING HARDWARE FOR DP RATINGS.

Note: Elevations shown DO NOT have exterior trim. Subtract 1/2" (12.7) from M.O. (Masonry Opening) for Unit Size. For other Trim Options refer to the Unit Sizing, Rough Opening & Masonry Openings page.

**M.O. BRICKMOULD**  
**M.O. ADAMS/FLAT CASING**  
**ROUGH OPENING**  
**FRAME SIZE**  
**DAYLIGHT OPENING**

16 11/16" [424]  
 19 7/8" [505]  
 14 1/16" [357]  
 13 9/16" [344]  
 7 1/2" [190]

18 11/16" [475]  
 21 3/4" [552]  
 16 1/16" [408]  
 15 9/16" [395]  
 8 1/2" [216]

20 11/16" [525]  
 23 3/4" [603]  
 18 1/16" [459]  
 17 9/16" [446]  
 11 1/2" [292]

28 9/16" [725]  
 31 5/8" [803]  
 26 3/16" [665]  
 25 7/16" [646]  
 14 5/8" [371]

34 9/16" [878]  
 37 5/8" [956]  
 32 3/16" [818]  
 31 7/16" [799]  
 20 5/8" [524]

36 9/16" [929]  
 39 5/8" [1006]  
 34 3/16" [868]  
 33 7/16" [849]  
 22 5/8" [575]

40 9/16" [1030]  
 43 5/8" [1108]  
 38 3/16" [970]  
 37 7/16" [951]  
 26 5/8" [676]

46 9/16" [1183]  
 49 5/8" [1260]  
 44 3/16" [1122]  
 43 7/16" [1103]  
 32 5/8" [829]

84 5/16" [2142]  
 85 27/32" [2180]  
 83 1/4" [2115]  
 82 1/2" [2096]  
 68 11/16" [1745]

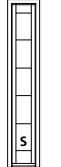

WISWT1068

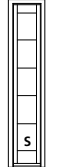

WISWT1268

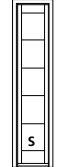

WISWT1468

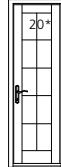

WISWT2068

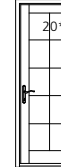

WISWT2668

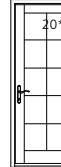

WISWT2868

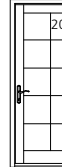

WISWT3068

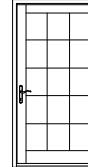

WISWT3668

88 5/16" [2243]  
 89 27/32" [2282]  
 87 1/4" [2216]  
 86 1/2" [2197]  
 72 11/16" [1846]

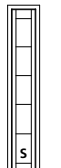

WISWT1070

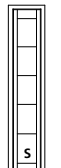

WISWT1270

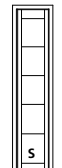

WISWT1470

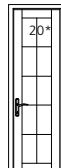

WISWT2070

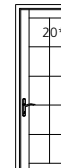

WISWT2670

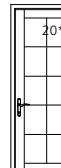

WISWT2870

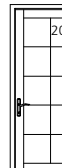

WISWT3070

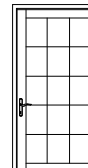

WISWT3670

100 5/16" [2548]  
 101 27/32" [2587]  
 99 1/4" [2521]  
 98 1/2" [2502]  
 84 11/16" [2151]

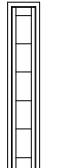

WISWT1080

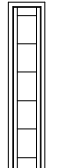

WISWT1280

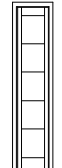

WISWT1480

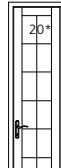

WISWT2080

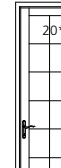

WISWT2680

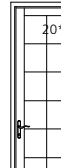

WISWT2880

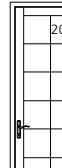

WISWT3080

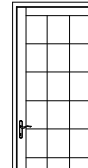

WISWT3680

112 5/16" [2853]  
 113 27/32" [2892]  
 111 1/4" [2826]  
 110 1/2" [2807]  
 96 11/16" [2456]

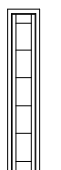

WISWT1090

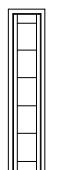

WISWT1290

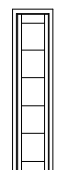

WISWT1490

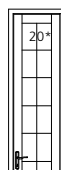

WISWT2090

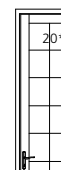

WISWT2690



WISWT2890



WISWT3090

SCALE: 1/8" = 1'



### 2-PANEL UNITS

**M.O. BRICKMOULD**  
**M.O. ADAMS/FLAT CASING**  
**ROUGH OPENING**  
**FRAME SIZE**  
**DAYLIGHT OPENING**

61 3/4" [1568]  
64 13/16" [1646]  
59 3/8" [1508]  
58 5/8" [1489]  
18 5/8" [473] (2)

65 3/4" [1670]  
68 13/16" [1748]  
63 3/8" [1610]  
62 5/8" [1591]  
20 5/8" [524] (2)

73 3/4" [1873]  
76 13/16" [1951]  
71 3/8" [1813]  
70 5/8" [1794]  
24 5/8" [625] (2)

81 5/16" [2065]  
82 27/32" [2104]  
80 1/4" [2038]  
79 1/2" [2019]  
65 11/16" [1668]

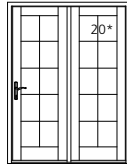

WISWR5068

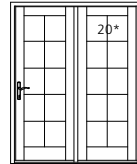

WISWR5468

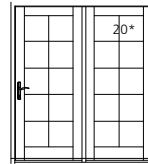

WISWR6068

97 5/16" [2472]  
98 27/32" [2511]  
96 1/4" [2445]  
95 1/2" [2426]  
81 11/16" [2075]

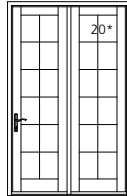

WISWR5080

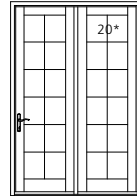

WISWR5480

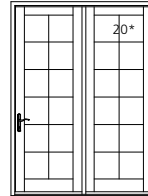

WISWR6080

109 5/16" [2777]  
110 27/32" [2815]  
108 1/4" [2750]  
107 1/2" [2731]  
93 11/16" [2380]

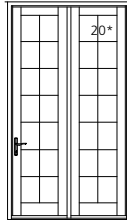

WISWR5090

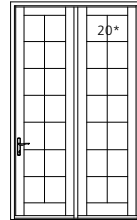

WISWR5490

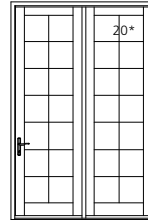

WISWR6090

**M.O. BRICKMOULD**  
**M.O. ADAMS/FLAT CASING**  
**ROUGH OPENING**  
**FRAME SIZE**  
**DAYLIGHT OPENING**

65 3/4" [1670]  
68 13/16" [1748]  
63 3/8" [1610]  
62 5/8" [1591]  
20 5/8" [524] (2)

69 3/4" [1772]  
72 13/16" [1849]  
67 3/8" [1711]  
66 5/8" [1692]  
22 5/8" [575] (2)

77 3/4" [1975]  
80 13/16" [2053]  
75 3/8" [1915]  
74 5/8" [1895]  
26 5/8" [676] (2)

89 3/4" [2280]  
92 13/16" [2357]  
87 3/8" [2219]  
86 5/8" [2200]  
32 5/8" [829] (2)

84 5/16" [2142]  
85 27/32" [2180]  
83 1/4" [2115]  
82 1/2" [2096]  
68 11/16" [1745]

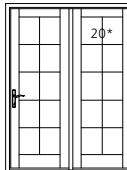

WISWT5068

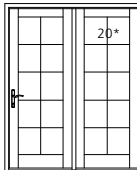

WISWT5468

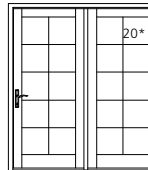

WISWT6068

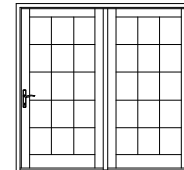

WISWT7068

88 5/16" [2243]  
89 27/32" [2282]  
87 1/4" [2215]  
86 1/2" [2197]  
72 11/16" [1846]

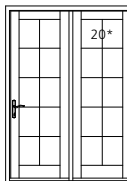

WISWT5070

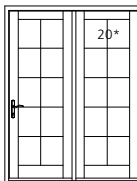

WISWT5470

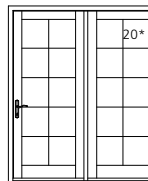

WISWT6070

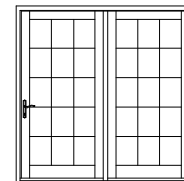

WISWT7070

100 5/16" [2548]  
101 27/32" [2587]  
99 1/4" [2521]  
98 1/2" [2502]  
84 11/16" [2151]

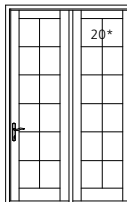

WISWT5080

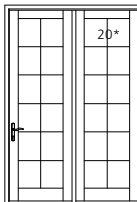

WISWT5480

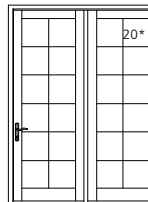

WISWT6080

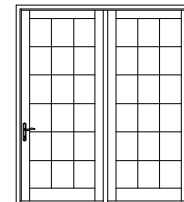

WISWT7080

112 5/16" [2853]  
113 27/32" [2892]  
111 1/4" [2826]  
110 1/2" [2807]  
96 11/16" [2456]

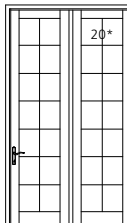

WISWT5090

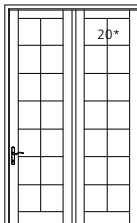

WISWT5490

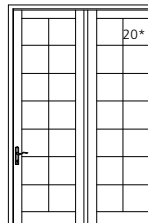

WISWT6090

**ELEVATION SYMBOL LEGEND:**

**M.O.** = MASONRY OPENING  
VALUES IN [ ] ARE IN MILLIMETER CONVERSIONS.  
VALUES IN ( ) ARE NUMBER OF DAYLIGHT OPENINGS PER UNIT.  
##\* NUMBER INDICATES DESIGN PRESSURE (DP) RATING  
WITH STANDARD GLAZING. OPERATING UNITS UTILIZE  
MULTI-POINT LOCKING HARDWARE FOR DP RATINGS.

Note: Elevations shown DO NOT have exterior trim.  
Subtract 1/2" (12.7) from M.O. (Masonry Opening)  
for Unit Size. For other Trim Options refer to the Unit  
Sizing, Rough Opening & Masonry Openings page.

SCALE: 1/8" = 1'

**3-PANEL UNITS**

**M.O. BRICKMOULD**  
**M.O. ADAMS/FLAT CASING**  
**ROUGH OPENING**  
**FRAME SIZE**  
**DAYLIGHT OPENING**

90 15/16" [2310]  
94" [2388]  
88 9/16" [2250]  
87 13/16" [2230]  
18 5/8" [473] (3)

96 15/16" [2462]  
100" [2540]  
94 9/16" [2402]  
93 13/16" [2383]  
20 5/8" [524] (3)

108 15/16" [2767]  
112" [2845]  
106 9/16" [2707]  
105 13/16" [2688]  
24 5/8" [625] (3)

81 5/16" [2065]  
82 27/32" [2104]  
80 1/4" [2038]  
79 1/2" [2019]  
65 11/16" [1695]

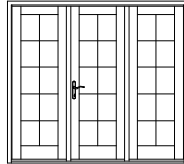

WISWR7668

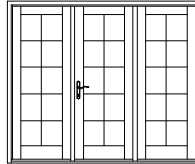

WISWR8068

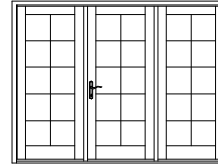

WISWR9068

97 5/16" [2472]  
98 27/32" [2511]  
96 1/4" [2445]  
95 1/2" [2426]  
81 11/16" [2075]

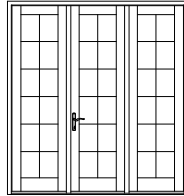

WISWR7680

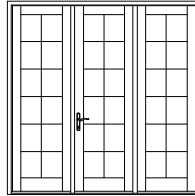

WISWR8080

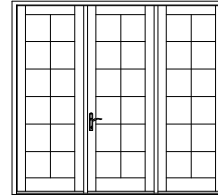

WISWR9080

109 5/16" [2777]  
110 27/32" [2815]  
108 1/4" [2750]  
107 1/2" [2731]  
93 11/16" [2380]

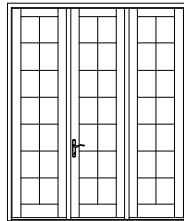

WISWR7690

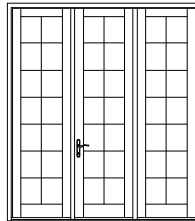

WISWR8090

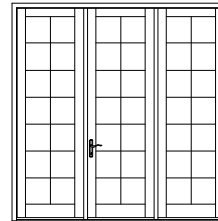

WISWR9090

**M.O. BRICKMOULD**  
**M.O. ADAMS/FLAT CASING**  
**ROUGH OPENING**  
**FRAME SIZE**  
**DAYLIGHT OPENING**

96 15/16" [2462]  
100" [2540]  
94 9/16" [2402]  
93 13/16" [2383]  
20 5/8" [524] (3)

102 15/16" [2615]  
106" [2692]  
100 9/16" [2554]  
99 13/16" [2535]  
22 5/8" [575] (3)

114 15/16" [2919]  
118" [2997]  
112 9/16" [2859]  
111 13/16" [2840]  
26 5/8" [676] (3)

84 5/16" [2142]  
85 27/32" [2180]  
83 1/4" [2038]  
82 1/2" [2096]  
68 11/16" [1745]

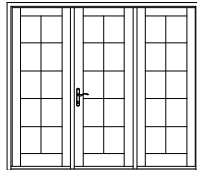

WISWT7668

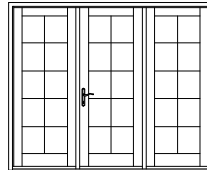

WISWT8068

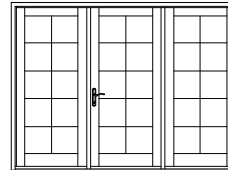

WISWT9068

88 5/16" [2243]  
89 27/32" [2282]  
87 1/4" [2216]  
86 1/2" [2197]  
72 11/16" [1846]

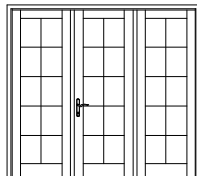

WISWT7670

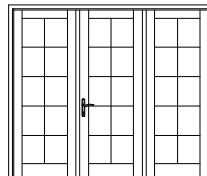

WISWT8070

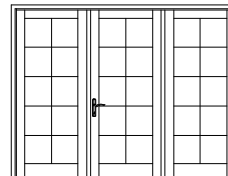

WISWT9070

100 5/16" [2548]  
101 27/32" [2587]  
99 1/4" [2521]  
98 1/2" [2502]  
84 11/16" [2151]

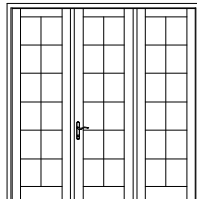

WISWT7680

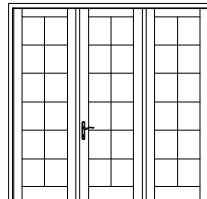

WISWT8080

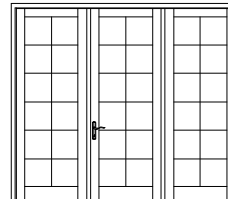

WISWT9080

112 5/16" [2853]  
113 27/32" [2892]  
111 1/4" [2826]  
110 1/2" [2807]  
96 11/16" [2456]

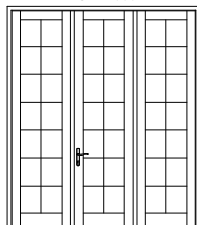

WISWT7690

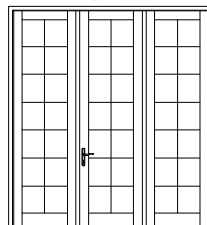

WISWT8090

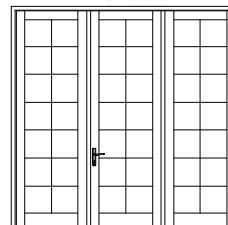

WISWT9090

**ELEVATION SYMBOL LEGEND:**

**M.O.** = MASONRY OPENING  
VALUES IN [ ] ARE IN MILLIMETER CONVERSIONS.  
VALUES IN ( ) ARE NUMBER OF DAYLIGHT OPENINGS PER UNIT.

Note: Elevations shown DO NOT have exterior trim. Subtract 1/2" (12.7) from M.O. (Masonry Opening) for Unit Size. For other Trim Options refer to the Unit Sizing, Rough Opening & Masonry Openings page.

SCALE: 1/8" = 1'

### 2-PANEL FRENCH UNITS

**M.O. BRICKMOULD  
M.O. ADAMS/FLAT CASING  
ROUGH OPENING  
FRAME SIZE  
DAYLIGHT OPENING**

81 5/16" [2065]  
82 27/32" [2104]  
86 1/4" [2038]  
79 1/2" [2019]  
65 11/16" [1668]

49 3/4" [1264]  
52 13/16" [1341]  
47 3/8" [1203]  
46 5/8" [1184]  
12 5/8" [321] (2)

61 3/4" [1568]  
64 13/16" [1646]  
59 3/8" [1508]  
58 5/8" [1489]  
18 5/8" [473] (2)

65 3/4" [1670]  
68 13/16" [1748]  
63 3/8" [1610]  
62 5/8" [1591]  
20 5/8" [524] (2)

73 3/4" [1873]  
76 13/16" [1951]  
71 3/8" [1813]  
70 5/8" [1794]  
24 5/8" [625] (2)

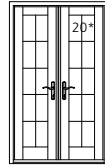

WIFRR4068

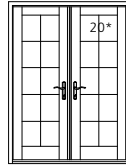

WIFRR5068

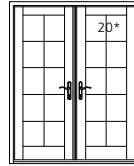

WIFRR5468

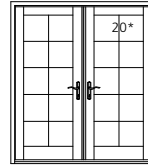

WIFRR6068

97 5/16" [2472]  
98 27/32" [2511]  
96 1/4" [245]  
95 1/2" [2426]  
81 11/16" [2075]

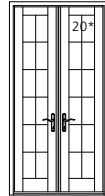

WIFRR4080

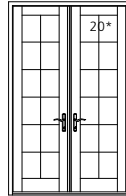

WIFRR5080

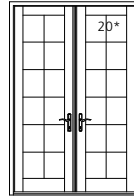

WIFRR5480

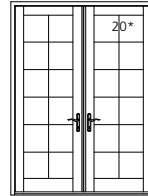

WIFRR6080

109 5/16" [2777]  
110 27/32" [2815]  
108 1/4" [2750]  
107 1/2" [2731]  
93 11/16" [2380]

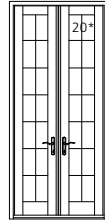

WIFRR4090

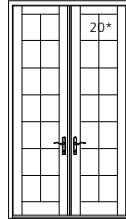

WIFRR5090

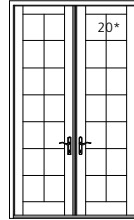

WIFRR5490

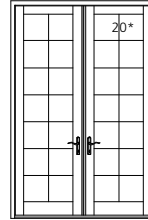

WIFRR6090

**M.O. BRICKMOULD  
M.O. ADAMS/FLAT CASING  
ROUGH OPENING  
FRAME SIZE  
DAYLIGHT OPENING**

84 5/16" [2142]  
85 27/32" [2180]  
83 1/4" [2115]  
82 1/2" [2096]  
68 11/16" [1745]

53 3/4" [1365]  
56 13/16" [1443]  
51 3/8" [1305]  
50 5/8" [1286]  
14 5/8" [371] (2)

65 3/4" [1670]  
68 13/16" [1748]  
63 3/8" [1610]  
62 5/8" [1591]  
20 5/8" [524] (2)

69 3/4" [1772]  
72 13/16" [1849]  
67 3/8" [1711]  
66 5/8" [1692]  
22 5/8" [575] (2)

77 3/4" [1975]  
80 13/16" [2053]  
75 3/8" [1915]  
74 5/8" [1895]  
26 5/8" [676] (2)

89 3/4" [2280]  
92 13/16" [2357]  
87 3/8" [2219]  
86 5/8" [2200]  
32 5/8" [829] (2)

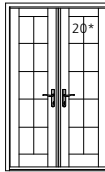

WIFRT4068

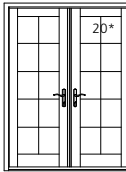

WIFRT5068

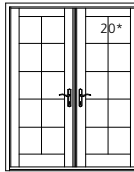

WIFRT5468

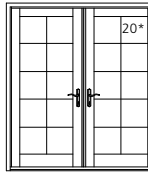

WIFRT6068

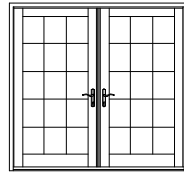

WIFRT7068

88 5/16" [2243]  
89 27/32" [2282]  
87 1/4" [2216]  
86 1/2" [2197]  
72 11/16" [1846]

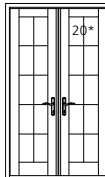

WIFRT4070

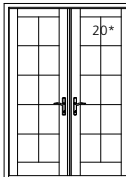

WIFRT5070

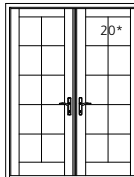

WIFRT5470

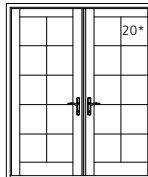

WIFRT6070

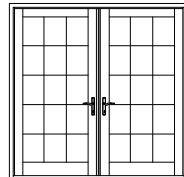

WIFRT7070

100 5/16" [2548]  
101 27/32" [2587]  
99 1/4" [2521]  
98 1/2" [2502]  
84 11/16" [2151]

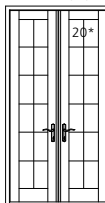

WIFRT4080

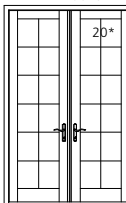

WIFRT5080

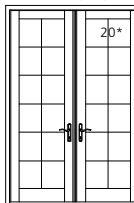

WIFRT5480

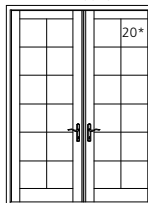

WIFRT6080

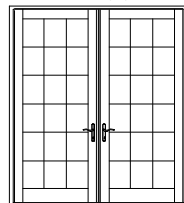

WIFRT7080

112 5/16" [2853]  
113 27/32" [2892]  
111 1/4" [2826]  
110 1/2" [2807]  
96 11/16" [2456]

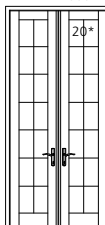

WIFRT4090

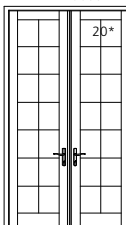

WIFRT5090

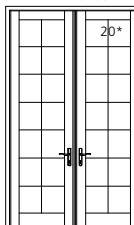

WIFRT5490

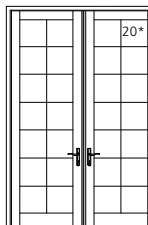

WIFRT6090

Note: Elevations shown DO NOT have exterior trim. Subtract 1/2" (12.7) from M.O. (Masonry Opening) for Unit Size. For other Trim Options refer to the Unit Sizing, Rough Opening & Masonry Openings page.

**ELEVATION SYMBOL LEGEND:**

M.O. = MASONRY OPENING  
VALUES IN [ ] ARE IN MILLIMETER CONVERSIONS.  
VALUES IN ( ) ARE NUMBER OF DAYLIGHT OPENINGS PER UNIT.  
## NUMBER INDICATES DESIGN PRESSURE (DP) RATING  
WITH STANDARD GLAZING. OPERATING UNITS UTILIZE MULTI-POINT LOCKING HARDWARE FOR DP RATINGS.

SCALE: 1/8" = 1'

**4-PANEL FRENCH UNITS**

**M.O. BRICKMOULD**  
**M.O. ADAMS/FLAT CASING**  
**ROUGH OPENING**  
**FRAME SIZE**  
**DAYLIGHT OPENING**

96 1/8" [2442]  
99 3/16" [2519]  
93 3/4" [2381]  
93" [2362]  
12 5/8" [321] (4)

120 1/8" [3051]  
123 3/16" [3129]  
117 3/4" [2991]  
117" [2972]  
18 5/8" [473] (4)

144 1/8" [3661]  
147 3/16" [3739]  
141 3/4" [3600]  
141" [3581]  
24 5/8" [625] (4)

81 5/16" [2065]  
82 27/32" [2104]  
80 1/4" [2038]  
79 1/2" [2019]  
65 11/16" [1695]

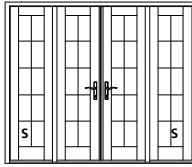

WIFRR8068

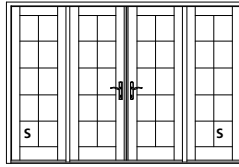

WIFRR10068

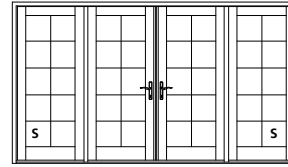

WIFRR12068

97 5/16" [2472]  
98 27/32" [2511]  
96 1/4" [2445]  
95 1/2" [2426]  
81 11/16" [2075]

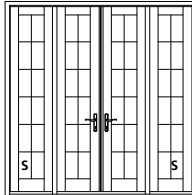

WIFRR8080

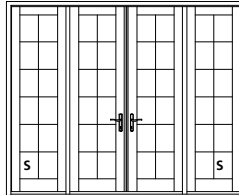

WIFRR10080

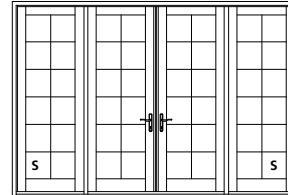

WIFRR12080

109 5/16" [2777]  
110 27/32" [2815]  
108 1/4" [2750]  
107 1/2" [2731]  
93 11/16" [2380]

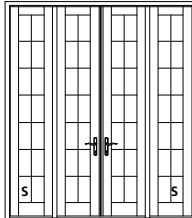

WIFRR8090

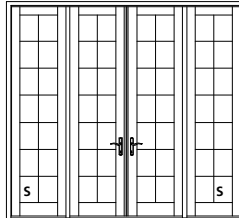

WIFRR10090

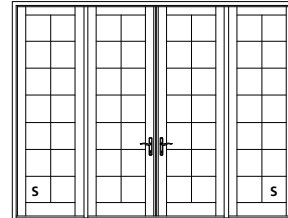

WIFRR12090

**M.O. BRICKMOULD**  
**M.O. ADAMS/FLAT CASING**  
**ROUGH OPENING**  
**FRAME SIZE**  
**DAYLIGHT OPENING**

104 1/8" [2645]  
107 3/16" [2723]  
101 3/4" [2584]  
101" [2565]  
14 5/8" [371] (4)

128 1/8" [3254]  
131 3/16" [3332]  
125 3/4" [3194]  
125" [3175]  
20 5/8" [524] (4)

152 1/8" [3864]  
155 3/16" [3942]  
149 3/4" [3804]  
149" [3785]  
26 5/8" [676] (4)

84 5/16" [2142]  
85 27/32" [2180]  
83 1/4" [2038]  
82 1/2" [2096]  
68 11/16" [1745]

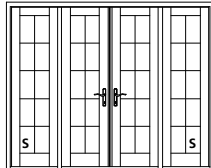

WIFRT8068

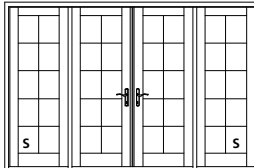

WIFRT10068

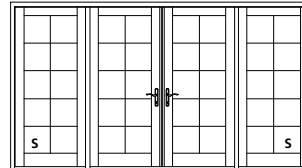

WIFRT12068

88 5/16" [2243]  
89 27/32" [2282]  
87 1/4" [2216]  
86 1/2" [2197]  
72 11/16" [1846]

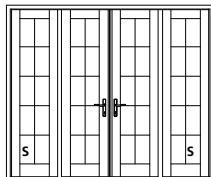

WIFRT8070

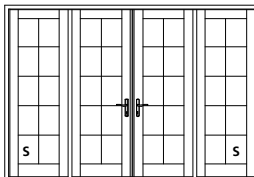

WIFRT10070

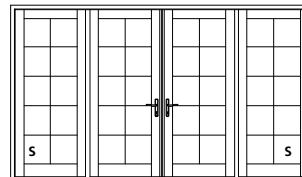

WIFRT12070

100 5/16" [2548]  
101 27/32" [2587]  
99 1/4" [2521]  
98 1/2" [2502]  
84 11/16" [2151]

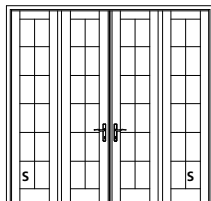

WIFRT8080

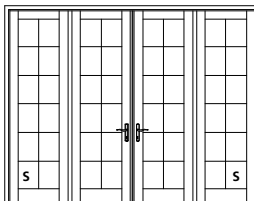

WIFRT10080

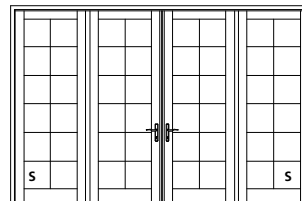

WIFRT12080

112 5/16" [2853]  
113 27/32" [2892]  
111 1/4" [2826]  
110 1/2" [2807]  
96 11/16" [2456]

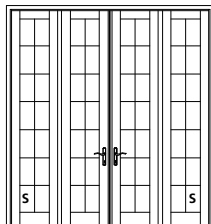

WIFRT8090

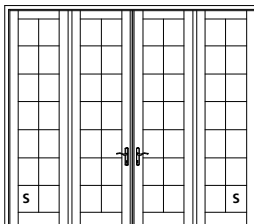

WIFRT10090

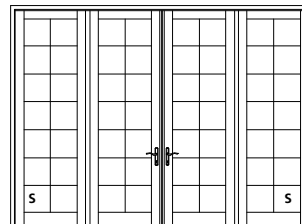

WIFRT12090

**ELEVATION SYMBOL LEGEND:**

M.O. = MASONRY OPENING  
VALUES IN [ ] ARE IN MILLIMETER CONVERSIONS.  
VALUES IN ( ) ARE NUMBER OF DAYLIGHT OPENINGS PER UNIT.  
S PANEL IS AVAILABLE AS STATIONARY ONLY.

Note: Elevations shown DO NOT have exterior trim. Subtract 1/2" (12.7) from M.O. (Masonry Opening) for Unit Size. For other Trim Options refer to the Unit Sizing, Rough Opening & Masonry Openings page.

SCALE: 1/8" = 1'

### SINGLE DOOR WITH SINGLE SIDELITE

**M.O. BRICKMOULD**  
**M.O. ADAMS/FLAT CASING**  
**ROUGH OPENING**  
**FRAME SIZE**  
**DAYLIGHT OPENING**

84 5/16" [2142]  
85 27/32" [2180]  
83 1/4" [2114]  
82 1/2" [2096]  
68 11/16" [1745]

53 7/8" [1368]  
56 15/16" [1446]  
51 1/2" [1308]  
50 3/4" [1289]

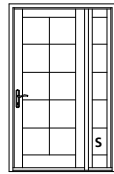

WISWT3068B10

55 7/8" [1419]  
58 15/16" [1497]  
53 1/2" [1359]  
52 3/4" [1340]

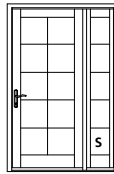

WISWT3068B12

57 7/8" [1470]  
60 15/16" [1548]  
55 1/2" [1410]  
54 3/4" [1391]

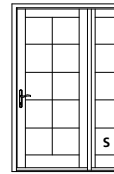

WISWT3068B14

88 5/16" [2243]  
89 27/32" [2282]  
87 1/4" [2216]  
86 1/2" [2197]  
72 11/16" [1846]

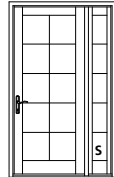

WISWT3070B10

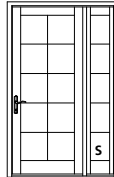

WISWT3070B12

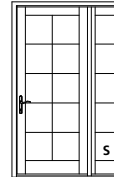

WISWT3070B14

100 5/16" [2548]  
101 27/32" [2587]  
99 1/4" [2522]  
98 1/2" [2502]  
84 11/16" [2151]

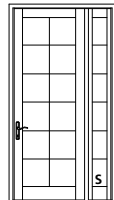

WISWT3080B10

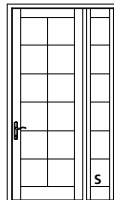

WISWT3080B12

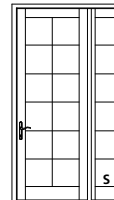

WISWT3080B14

112 5/16" [2853]  
113 27/32" [2892]  
111 1/4" [2826]  
110 1/2" [2807]  
96 11/16" [2456]

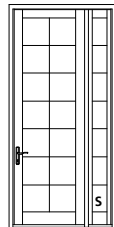

WISWT3090B10

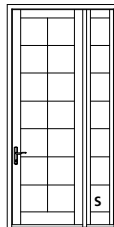

WISWT3090B12

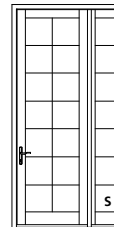

WISWT3090B14

**M.O. BRICKMOULD**  
**M.O. ADAMS/FLAT CASING**  
**ROUGH OPENING**  
**FRAME SIZE**  
**DAYLIGHT OPENING**

84 5/16" [2142]  
85 27/32" [2180]  
83 1/4" [2114]  
82 1/2" [2096]  
68 11/16" [1745]

59 7/8" [1521]  
62 15/16" [1599]  
57 1/2" [1460]  
56 3/4" [1441]

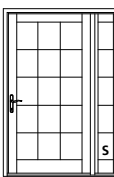

WISWT3668B10

61 7/8" [1572]  
64 15/16" [1649]  
59 1/2" [1511]  
58 3/4" [1492]

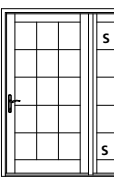

WISWT3668B12

63 7/8" [1622]  
66 15/16" [1700]  
61 1/2" [1562]  
60 3/4" [1543]

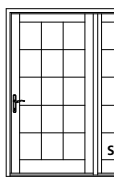

WISWT3668B14

88 5/16" [2243]  
89 27/32" [2282]  
87 1/4" [2216]  
86 1/2" [2197]  
72 11/16" [1846]

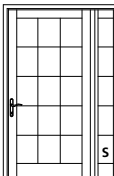

WISWT3670B10

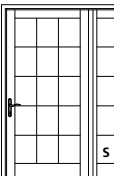

WISWT3670B12

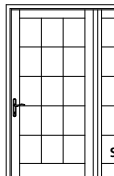

WISWT3670B14

100 5/16" [2548]  
101 27/32" [2587]  
99 1/4" [2522]  
98 1/2" [2502]  
84 11/16" [2151]

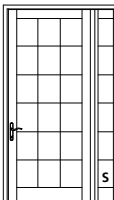

WISWT3680B10

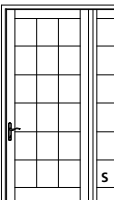

WISWT3680B12

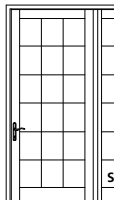

WISWT3680B14

**ELEVATION SYMBOL LEGEND:**  
M.O. = MASONRY OPENING  
VALUES IN [ ] ARE IN MILLIMETER CONVERSIONS.  
S = PANEL IS AVAILABLE AS STATIONARY ONLY.

Note: Elevations shown DO NOT have exterior trim. Subtract 1/2" (12.7) from M.O. (Masonry Opening) for Unit Size. For other Trim Options refer to the Unit Sizing, Rough Opening & Masonry Openings page.

SCALE: 1/8" = 1'

### SINGLE DOOR WITH TWO SIDELITES

| M.O. BRICKMOULD<br>M.O. ADAMS/FLAT CASING<br>ROUGH OPENING<br>FRAME SIZE<br>DAYLIGHT OPENING    | 67 3/16" [1707]<br>70 1/4" [1784]<br>64 13/16" [1647]<br>64 1/16" [1627] | 71 3/16" [1808]<br>74 1/4" [1886]<br>68 13/16" [1747]<br>68 1/16" [1729] | 75 3/16" [1910]<br>78 1/4" [1988]<br>72 13/16" [1849]<br>72 1/16" [1830] |
|---|--|--|--|
| 26 5/8" [676] - 7 1/2" [190] (2)  |  |  |  |
| 84 5/16" [2142]<br>85 27/32" [2180]<br>83 1/4" [2114]<br>82 1/2" [2096]<br>68 11/16" [1745]     | WISWT3068F10   | WISWT3068F12   | WISWT3068F14   |
| 88 5/16" [2243]<br>89 27/32" [2282]<br>87 1/4" [2216]<br>86 1/2" [2197]<br>72 11/16" [1846]     |  |  |  |
| WISWT3070F10  | WISWT3070F12   | WISWT3070F14   |  |
| 100 5/16" [2548]<br>101 27/32" [2587]<br>99 1/4" [2521]<br>98 1/2" [2502]<br>84 11/16" [2151]   |  |  |  |
| WISWT3080F10  | WISWT3080F12   | WISWT3080F14   |  |
| 112 5/16" [2853]<br>113 27/32" [2892]<br>111 1/4" [2826]<br>110 1/2" [2807]<br>96 11/16" [2456] |  |  |  |
| WISWT3090F10  | WISWT3090F12   | WISWT3090F14   |  |
| M.O. BRICKMOULD<br>M.O. ADAMS/FLAT CASING<br>ROUGH OPENING<br>FRAME SIZE<br>DAYLIGHT OPENING    | 73 3/16" [1859]<br>76 1/4" [1937]<br>70 13/16" [1798]<br>70 1/16" [1780] | 77 3/16" [1961]<br>80 1/4" [2038]<br>74 13/16" [1900]<br>74 1/16" [1881] | 81 3/16" [2062]<br>84 1/4" [2140]<br>78 13/16" [2001]<br>78 1/16" [1983] |
| 32 5/8" [829] - 7 1/2" [190] (2)  |  |  |  |
| 84 5/16" [2142]<br>85 27/32" [2180]<br>83 1/4" [2114]<br>82 1/2" [2096]<br>68 11/16" [1745]     | WISWT3668F10   | WISWT3668F12   | WISWT3668F14   |
| 88 5/16" [2243]<br>89 27/32" [2282]<br>87 1/4" [2216]<br>86 1/2" [2197]<br>72 11/16" [1846]     |  |  |  |
| WISWT3670F10  | WISWT3670F12   | WISWT3670F14   |  |
| 100 5/16" [2548]<br>101 27/32" [2587]<br>99 1/4" [2521]<br>98 1/2" [2502]<br>84 11/16" [2151]   |  |  |  |
| WISWT3680F10  | WISWT3680F12   | WISWT3680F14   |  |

**ELEVATION SYMBOL LEGEND:**  
**M.O.** = MASONRY OPENING  
 VALUES IN [ ] ARE IN MILLIMETER CONVERSIONS.  
 VALUES IN ( ) ARE NUMBER OF DAYLIGHT OPENINGS PER UNIT.  
**S** PANEL IS AVAILABLE AS STATIONARY ONLY.

Note: Elevations shown DO NOT have exterior trim. Subtract 1/2" (12.7) from M.O. (Masonry Opening) for Unit Size. For other Trim Options refer to the Unit Sizing, Rough Opening & Masonry Openings page.

SCALE: 1/8" = 1'

**FRENCH DOOR WITH TWO SIDELITES**  
**5-0 UNITS**

**M.O. BRICKMOULD**  
**M.O. ADAMS/FLAT CASING**  
**ROUGH OPENING**  
**FRAME SIZE**  
**DAYLIGHT OPENING**

92 3/8" [2346]  
95 7/16" [2424]  
90" [2286]  
89 1/4" [2267]  
20 5/8" [524] (2) - 7-1/2" [190] (2)

96 3/8" [2448]  
99 7/16" [2526]  
94" [2387]  
93 1/4" [2369]  
20 5/8" [524] (2) - 9 1/2" [241] (2)

100 3/8" [2550]  
103 7/16" [2627]  
98" [2489]  
97 1/4" [2470]  
20 5/8" [524] (2) - 11 1/2" [292] (2)

84 5/16" [2142]  
85 27/32" [2180]  
83 1/4" [2115]  
82 1/2" [2096]  
68 11/16" [1745]

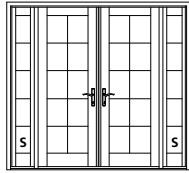

WIFRT5068Q10

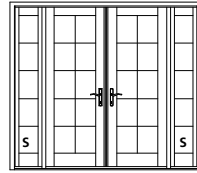

WIFRT5068Q12

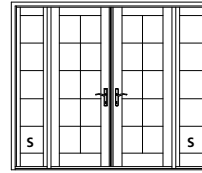

WIFRT5068Q14

88 5/16" [2243]  
89 27/32" [2282]  
87 1/4" [2216]  
86 1/2" [2197]  
72 11/16" [1846]

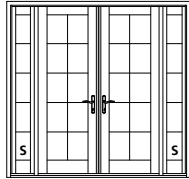

WIFRT5070Q10

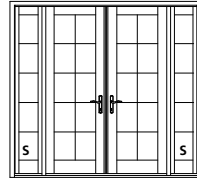

WIFRT5070Q12

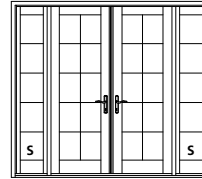

WIFRT5070Q14

100 5/16" [2548]  
101 27/32" [2587]  
99 1/4" [2521]  
98 1/2" [2502]  
84 11/16" [2151]

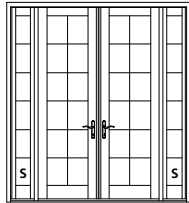

WIFRT5080Q10

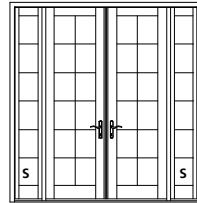

WIFRT5080Q12

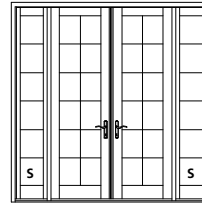

WIFRT5080Q14

112 5/16" [2853]  
113 27/32" [2892]  
111 1/4" [2826]  
110 1/2" [2807]  
96 11/16" [2456]

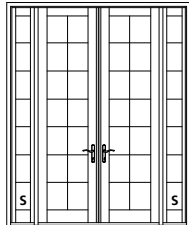

WIFRT5090Q10

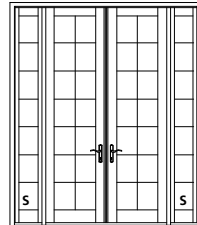

WIFRT5090Q12

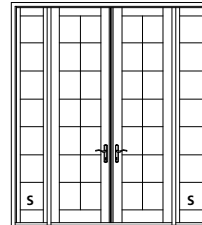

WIFRT5090Q14

**ELEVATION SYMBOL LEGEND:**

**M.O.** = MASONRY OPENING  
VALUES IN [ ] ARE IN MILLIMETER CONVERSIONS.  
VALUES IN ( ) ARE NUMBER OF DAYLIGHT OPENINGS PER UNIT.  
**S** PANEL IS AVAILABLE AS STATIONARY ONLY.

Note: Elevations shown DO NOT have exterior trim. Subtract 1/2" (12.7) from M.O. (Masonry Opening) for Unit Size. For other Trim Options refer to the Unit Sizing, Rough Opening & Masonry Openings page.

SCALE: 1/8" = 1'

**FRENCH DOOR WITH TWO SIDELITES**  
**5-4 UNITS**

**M.O. BRICKMOLD**  
**M.O. ADAMS/FLAT CASING**  
**ROUGH OPENING**  
**FRAME SIZE**  
**DAYLIGHT OPENING**

96 3/8" [2448]  
99 7/16" [2526]  
94" [2387]  
93 1/4" [2369]  
22 5/8" [575] (2) - 7 1/2" [190] (2)

100 3/8" [2550]  
103 7/16" [2627]  
98" [2489]  
97 1/4" [2470]  
22 5/8" [575] (2) - 9 1/2" [241] (2)

104 3/8" [2651]  
107 7/16" [2769]  
102" [2592]  
101 1/4" [2572]  
22 5/8" [575] (2) - 11 1/2" [292] (2)

84 5/16" [2142]  
85 27/32" [2180]  
83 1/4" [2114]  
82 1/2" [2096]  
68 11/16" [1745]

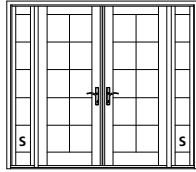

WIFRT5468Q10

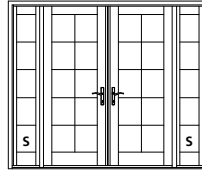

WIFRT5468Q12

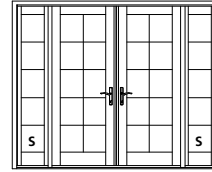

WIFRT5468Q14

88 5/16" [2243]  
89 27/32" [2282]  
87 1/4" [2216]  
86 1/2" [2197]  
72 11/16" [1846]

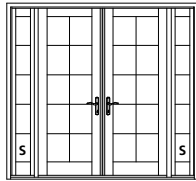

WIFRT5470Q10

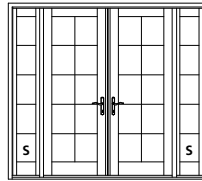

WIFRT5470Q12

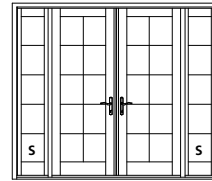

WIFRT5470Q14

100 5/16" [2548]  
101 27/32" [2587]  
99 1/4" [2521]  
98 1/2" [2502]  
84 11/16" [2151]

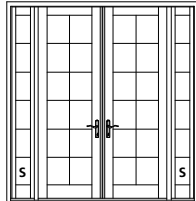

WIFRT5480Q10

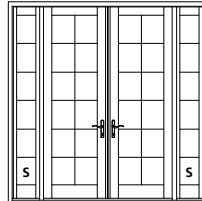

WIFRT5480Q12

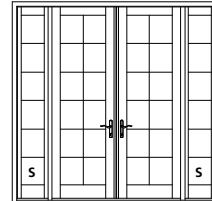

WIFRT5480Q14

112 5/16" [2853]  
113 27/32" [2892]  
111 1/4" [2826]  
110 1/2" [2807]  
96 11/16" [2456]

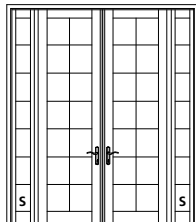

WIFRT5490Q10

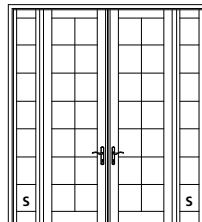

WIFRT5490Q12

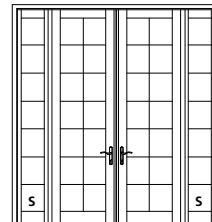

WIFRT5490Q14

**ELEVATION SYMBOL LEGEND:**

**M.O.** = MASONRY OPENING  
VALUES IN [ ] ARE IN MILLIMETER CONVERSIONS.  
VALUES IN ( ) ARE NUMBER OF DAYLIGHT OPENINGS PER UNIT.  
**S** PANEL IS AVAILABLE AS STATIONARY ONLY.

Note: Elevations shown DO NOT have exterior trim. Subtract 1/2" (12.7) from M.O. (Masonry Opening) for Unit Size. For other Trim Options refer to the Unit Sizing, Rough Opening & Masonry Openings page.

SCALE: 1/8" = 1'



**FRENCH DOOR WITH TWO SIDELITES**  
**6-0 UNITS**

**M.O. BRICKMOULD**  
**M.O. ADAMS/FLAT CASING**  
**ROUGH OPENING**  
**FRAME SIZE**  
**DAYLIGHT OPENING**

104 3/8" [2651]  
107 7/16" [2729]  
102" [2591]  
101 1/4" [2572]  
26 5/8" [575] (2) - 7 1/2" [190] (2)

108 3/8" [2753]  
111 7/16" [2831]  
106" [2692]  
105 1/4" [2673]  
26 5/8" [575] (2) - 9 1/2" [241] (2)

112 3/8" [2854]  
115 7/16" [2932]  
110" [2794]  
109 1/4" [2775]  
26 5/8" [575] (2) - 11 1/2" [292] (2)

84 5/16" [2142]  
85 27/32" [2180]  
83 1/4" [2114]  
82 1/2" [2096]  
68 11/16" [1745]

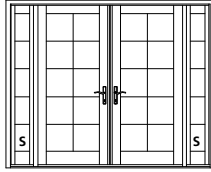

WIFRT6068Q10

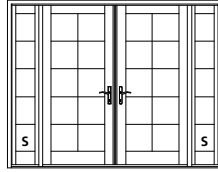

WIFRT6068Q12

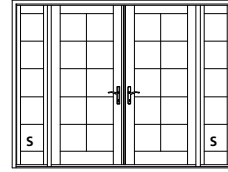

WIFRT6068Q14

88 5/16" [2243]  
89 27/32" [2282]  
87 1/4" [2216]  
86 1/2" [2197]  
72 11/16" [1846]

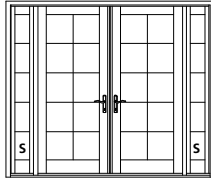

WIFRT6070Q10

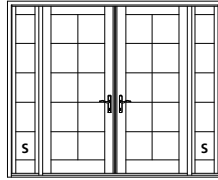

WIFRT6070Q12

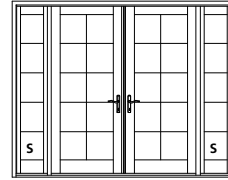

WIFRT6070Q14

100 5/16" [2548]  
101 27/32" [2587]  
99 1/4" [2521]  
98 1/2" [2502]  
84 11/16" [2151]

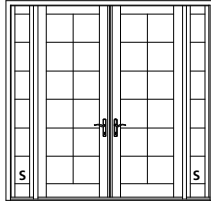

WIFRT6080Q10

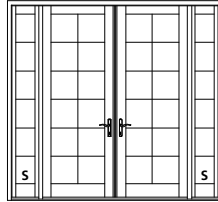

WIFRT6080Q12

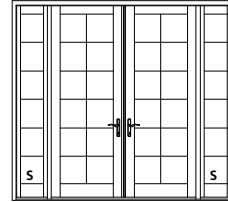

WIFRT6080Q14

112 5/16" [2853]  
113 27/32" [2892]  
111 1/4" [2826]  
110 1/2" [2807]  
96 11/16" [2456]

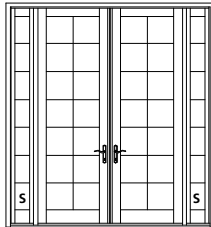

WIFRT6090Q10

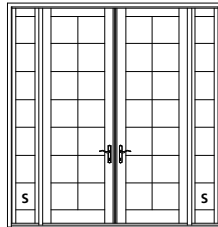

WIFRT6090Q12

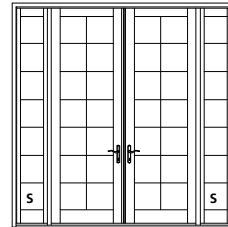

WIFRT6090Q14

**ELEVATION SYMBOL LEGEND:**

**M.O.** = MASONRY OPENING  
VALUES IN [ ] ARE IN MILLIMETER CONVERSIONS.  
VALUES IN ( ) ARE NUMBER OF DAYLIGHT OPENINGS PER UNIT.  
**S** PANEL IS AVAILABLE AS STATIONARY ONLY.

Note: Elevations shown DO NOT have exterior trim. Subtract 1/2" (12.7) from M.O. (Masonry Opening) for Unit Size. For other Trim Options refer to the Unit Sizing, Rough Opening & Masonry Openings page.

SCALE: 1/8" = 1'

**FRENCH DOOR WITH TWO SIDELITES**  
**7-0 UNITS**

**M.O. BRICKMOULD**  
**M.O. ADAMS/FLAT CASING**  
**ROUGH OPENING**  
**FRAME SIZE**  
**DAYLIGHT OPENING**

116 3/8" [2956]  
119 7/16" [3034]  
114" [2894]  
113 1/4" [2877]  
32 5/8" [829] (2) - 7 1/2" [190] (2)

120 3/8" [3058]  
123 7/16" [3135]  
118" [2997]  
117 1/4" [2978]  
32 5/8" [829] (2) - 9 1/2" [241] (2)

124 3/8" [3159]  
127 7/16" [3237]  
122" [3098]  
121 1/4" [3080]  
32 5/8" [829] (2) - 11 1/2" [292] (2)

84 3/8" [2143]  
85 7/8" [2181]  
83 1/4" [2114]  
82 1/2" [2096]  
68 11/16" [1745]

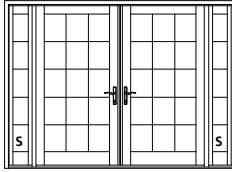

WIFRT7068Q10

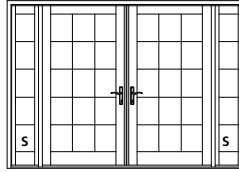

WIFRT7068Q12

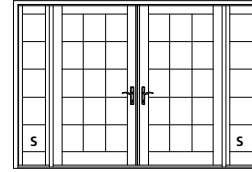

WIFRT7068Q14

88 3/8" [2245]  
89 7/8" [2283]  
87 1/4" [2216]  
86 1/2" [2197]  
72 11/16" [1846]

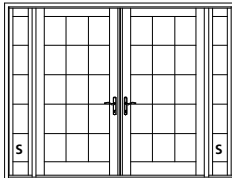

WIFRT7070Q10

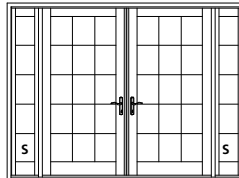

WIFRT7070Q12

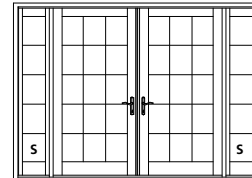

WIFRT7070Q14

100 3/8" [2550]  
101 7/8" [2588]  
99 1/4" [2521]  
98 1/2" [2502]  
84 11/16" [2151]

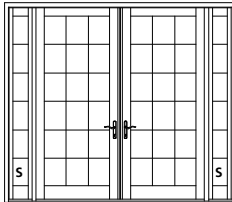

WIFRT7080Q10

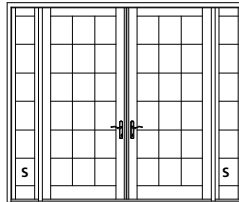

WIFRT7080Q12

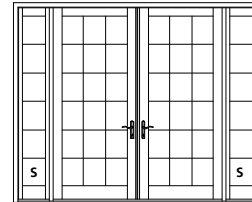

WIFRT7080Q14

**ELEVATION SYMBOL LEGEND:**

**M.O.** = MASONRY OPENING  
VALUES IN [ ] ARE IN MILLIMETER CONVERSIONS.  
VALUES IN ( ) ARE NUMBER OF DAYLIGHT OPENINGS PER UNIT.  
**S** PANEL IS AVAILABLE AS STATIONARY ONLY.

Note: Elevations shown DO NOT have exterior trim. Subtract 1/2" (12.7) from M.O. (Masonry Opening) for Unit Size. For other Trim Options refer to the Unit Sizing, Rough Opening & Masonry Openings page.

### SINGLE SASH TRANSOMS

**M.O. BRICKMOULD**  
**M.O. ADAMS/FLAT CASING**  
**ROUGH OPENING**  
**FRAME SIZE**  
**DAYLIGHT OPENING**

26 9/16" [675]  
29 5/8" [752]  
24 3/16" [614]  
23 7/16" [595]  
12 5/8" [321]

32 9/16" [827]  
35 5/8" [905]  
30 3/16" [767]  
29 7/16" [748]  
18 5/8" [473]

38 9/16" [979]  
41 5/8" [1057]  
36 3/16" [919]  
35 7/16" [900]  
24 5/8" [625]

49 3/4" [1264]  
52 13/16" [1341]  
47 3/8" [1203]  
46 5/8" [1184]  
36 13/16" [894]

61 3/4" [1568]  
64 13/16" [1646]  
59 3/8" [1507]  
58 5/8" [1489]  
47 13/16" [1198]

73 3/4" [1873]  
76 13/16" [1951]  
71 3/8" [1813]  
70 5/8" [1794]  
59 13/16" [1503]

20 1/2" [521]  
22" [559]  
18 3/4" [476]  
18" [457]  
10 15/16" [278]



WTISWR2016



WTISWR2616



WTISWR3016

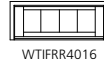

WTIFRR4016



WTIFRR5016



WTIFRR6016

32 1/2" [826]  
34" [864]  
30 3/4" [781]  
30" [762]  
22 15/16" [583]



WTISWR2026



WTISWR2626



WTISWR3026

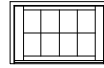

WTIFRR4026

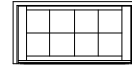

WTIFRR5026

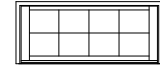

WTIFRR6026

**M.O. BRICKMOULD**  
**M.O. ADAMS/FLAT CASING**  
**ROUGH OPENING**  
**FRAME SIZE**  
**DAYLIGHT OPENING**

16 11/16" [424]  
19 3/4" [502]  
14 5/16" [364]  
13 9/16" [344]  
7 1/2" [190]

18 11/16" [475]  
21 3/4" [552]  
16 5/16" [414]  
15 9/16" [395]  
9 1/2" [241]

20 11/16" [525]  
23 3/4" [603]  
18 5/16" [465]  
17 9/16" [446]  
11 1/2" [292]

28 9/16" [725]  
31 5/8" [803]  
26 3/16" [665]  
25 7/16" [646]  
14 5/8" [371]

34 9/16" [878]  
37 5/8" [956]  
32 3/16" [817]  
31 7/16" [799]  
20 5/8" [524]

36 9/16" [929]  
39 5/8" [1006]  
34 3/16" [868]  
33 7/16" [849]  
25 5/8" [575]

40 9/16" [1030]  
43 5/8" [1108]  
38 3/16" [969]  
37 7/16" [951]  
26 5/8" [676]

46 9/16" [1183]  
49 5/8" [1260]  
44 3/16" [1122]  
43 7/16" [1103]  
32 5/8" [829]

20 1/2" [521]  
22" [559]  
18 3/4" [476]  
18" [457]  
10 15/16" [278]



WTISWT1016



WTISWT1216



WTISWT1416



WTISWT2016



WTISWT2616



WTISWT2816



WTISWT3016



WTISWT3616

32 1/2" [826]  
34" [864]  
30 3/4" [781]  
30" [762]  
22 15/16" [583]



WTISWT1026



WTISWT1226



WTISWT1426



WTISWT2026



WTISWT2626



WTISWT2826



WTISWT3026



WTISWT3626

**M.O. BRICKMOULD**  
**M.O. ADAMS/FLAT CASING**  
**ROUGH OPENING**  
**FRAME SIZE**  
**DAYLIGHT OPENING**

53 3/4" [1365]  
56 13/16" [1443]  
51 3/8" [1304]  
62 5/8" [1591]  
39 13/16" [1011]

65 3/4" [1670]  
68 13/16" [1748]  
63 3/8" [1610]  
62 5/8" [1591]  
51 13/16" [1216]

69 3/4" [1772]  
72 13/16" [1849]  
67 3/8" [1711]  
66 5/8" [1692]  
55 13/16" [1418]

77 3/4" [1975]  
80 13/16" [2053]  
75 3/8" [1914]  
74 5/8" [1895]  
63 13/16" [1621]

89 3/4" [2280]  
92 13/16" [2357]  
87 3/8" [2219]  
86 5/8" [2200]  
75 13/16" [1926]

20 1/2" [521]  
22" [559]  
18 3/4" [476]  
18" [457]  
10 15/16" [278]



WTIFRT4016



WTIFRT5016



WTIFRT5416



WTIFRT6016

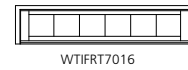

WTIFRT7016

32 1/2" [826]  
34" [864]  
30 3/4" [781]  
30" [762]  
22 15/16" [583]



WTIFRT4026



WTIFRT5026



WTIFRT5426



WTIFRT6026



WTIFRT7026

**ELEVATION SYMBOL LEGEND:**  
M.O. = MASONRY OPENING  
VALUES IN [ ] ARE IN MILLIMETER CONVERSIONS.

Note: Vertical Masonry Opening sizes are shown for units with 4-9/16" jamb. For transom units with 6-9/16" jamb subtract 1/8" from the finished dimensions.

Note: Elevations shown DO NOT have exterior trim. Subtract 1/2" (12.7) from M.O. (Masonry Opening) for Unit Sizes. Masonry Openings above include Sill Nose, see Transom Rail & Sill Options page for Sill Nose specifications. For other Trim Options refer to the Unit Sizing, Rough Opening & Masonry Openings page.

SCALE: 1/8" = 1'

**2-SASH TRANSOMS**

|  |  |   |   |
|--|--|---|---|
|  | <p><b>M.O. BRICKMOULD</b><br/><b>M.O. ADAMS/FLAT CASING</b><br/><b>ROUGH OPENING</b><br/><b>FRAME SIZE</b><br/><b>DAYLIGHT OPENING</b></p> <p>20 1/2" [521]<br/>22" [559]<br/>18 3/4" [476]<br/>18" [457]<br/>10 15/16" [278]</p> <p>32 1/2" [826]<br/>34" [864]<br/>30 3/4" [781]<br/>30" [762]<br/>22 15/16" [583]</p>   | <p>49 3/4" [1264]<br/>52 13/16" [1341]<br/>47 3/8" [1203]<br/>46 5/8" [1184]<br/>12 5/8" [321]</p> <p>61 3/4" [1568]<br/>64 13/16" [1646]<br/>59 3/8" [1507]<br/>58 5/8" [1489]<br/>18 5/8" [473]</p> <p>73 3/4" [1873]<br/>76 13/16" [1951]<br/>71 3/8" [1813]<br/>70 5/8" [1794]<br/>24 5/8" [625]</p>  | <p>WTISWR4016</p> <p>WTISWR5016</p> <p>WTISWR6016</p> <p>WTISWR4026</p> <p>WTISWR5026</p> <p>WTISWR6026</p>                   |
| <p><b>M.O. BRICKMOULD</b><br/><b>M.O. ADAMS/FLAT CASING</b><br/><b>ROUGH OPENING</b><br/><b>FRAME SIZE</b><br/><b>DAYLIGHT OPENING</b></p> <p>20 1/2" [521]<br/>22" [559]<br/>18 3/4" [476]<br/>18" [457]<br/>10 15/16" [278]</p> <p>32 1/2" [826]<br/>34" [864]<br/>30 3/4" [781]<br/>30" [762]<br/>22 15/16" [583]</p> | <p>53 3/4" [1365]<br/>56 13/16" [1443]<br/>51 3/8" [1304]<br/>50 5/8" [1286]<br/>14 5/8" [371] (2)</p> <p>65 3/4" [1670]<br/>68 13/16" [1748]<br/>63 3/8" [1610]<br/>62 5/8" [1591]<br/>20 5/8" [524] (2)</p> <p>69 3/4" [1772]<br/>72 13/16" [1849]<br/>67 3/8" [1711]<br/>66 5/8" [1692]<br/>22 5/8" [575] (2)</p> <p>77 3/4" [1975]<br/>80 13/16" [2053]<br/>75 3/8" [1914]<br/>74 5/8" [1895]<br/>26 5/8" [676] (2)</p> <p>89 3/4" [2280]<br/>92 13/16" [2357]<br/>87 3/8" [2219]<br/>86 5/8" [2200]<br/>32 5/8" [829] (2)</p> | <p>WTISWT4016</p> <p>WTISWT5016</p> <p>WTISWT5416</p> <p>WTISWT6016</p> <p>WTISWT7016</p> <p>WTISWT4026</p> <p>WTISWT5026</p> <p>WTISWT5426</p> <p>WTISWT6026</p> <p>WTISWT7026</p>   |   |
|  | <p><b>M.O. BRICKMOULD</b><br/><b>M.O. ADAMS/FLAT CASING</b><br/><b>ROUGH OPENING</b><br/><b>FRAME SIZE</b><br/><b>DAYLIGHT OPENING</b></p> <p>20 1/2" [521]<br/>22" [559]<br/>18 3/4" [476]<br/>18" [457]<br/>10 15/16" [278]</p> <p>32 1/2" [826]<br/>34" [864]<br/>30 3/4" [781]<br/>30" [762]<br/>22 15/16" [583]</p>   | <p>53 7/8" [1368]<br/>56 15/16" [1446]<br/>51 1/2" [1308]<br/>50 3/4" [1289]</p> <p>26 5/8" [676] - 7 1/2" [190]</p> <p>55 7/8" [1419]<br/>58 15/16" [1497]<br/>53 1/2" [1359]<br/>52 3/4" [1340]</p> <p>26 5/8" [676] - 9 1/2" [241]</p> <p>57 7/8" [1470]<br/>60 15/16" [1548]<br/>55 1/2" [1410]<br/>54 3/4" [1391]</p> <p>26 5/8" [676] - 11 1/2" [292]</p> | <p>WTISWT3016B10</p> <p>WTISWT3016B12</p> <p>WTISWT3016B14</p> <p>WTISWT3026B10</p> <p>WTISWT3026B12</p> <p>WTISWT3026B14</p> |
|  | <p><b>M.O. BRICKMOULD</b><br/><b>M.O. ADAMS/FLAT CASING</b><br/><b>ROUGH OPENING</b><br/><b>FRAME SIZE</b><br/><b>DAYLIGHT OPENING</b></p> <p>20 1/2" [521]<br/>22" [559]<br/>18 3/4" [476]<br/>18" [457]<br/>10 15/16" [278]</p> <p>32 1/2" [826]<br/>34" [864]<br/>30 3/4" [781]<br/>30" [762]<br/>22 15/16" [583]</p>   | <p>59 7/8" [1521]<br/>62 15/16" [1599]<br/>57 1/2" [1460]<br/>56 3/4" [1441]</p> <p>32 5/8" [829] - 7 1/2" [190]</p> <p>61 7/8" [1572]<br/>64 15/16" [1649]<br/>59 1/2" [1511]<br/>58 3/4" [1492]</p> <p>32 5/8" [829] - 9 1/2" [241]</p> <p>63 7/8" [1622]<br/>66 15/16" [1700]<br/>61 1/2" [1562]<br/>60 3/4" [1543]</p> <p>32 5/8" [829] - 11 1/2" [292]</p> | <p>WTISWT3616B10</p> <p>WTISWT3616B12</p> <p>WTISWT3616B14</p> <p>WTISWT3626B10</p> <p>WTISWT3626B12</p> <p>WTISWT3626B14</p> |

**ELEVATION SYMBOL LEGEND:**  
**M.O.** = MASONRY OPENING  
 VALUES IN [ ] ARE IN MILLIMETER CONVERSIONS.  
 VALUES IN ( ) ARE NUMBER OF DAYLIGHT OPENINGS PER UNIT.

Note: Vertical Masonry Opening sizes are shown for units with 4-9/16" jamb. For transom units with 6-9/16" jamb subtract 1/8" from the finished dimensions.

Note: Elevations shown DO NOT have exterior trim. Subtract 1/2" (12.7) from M.O. (Masonry Opening) for Unit Sizes. Masonry Openings above include Sill Nose, see Transom Rail & Sill Options page for Sill Nose specifications. For other Trim Options refer to the Unit Sizing, Rough Opening & Masonry Openings page.

SCALE: 1/8" = 1'

### 3-SASH TRANSOMS

**M.O. BRICKMOULD**  
**M.O. ADAMS/FLAT CASING**  
**ROUGH OPENING**  
**FRAME SIZE**  
**DAYLIGHT OPENING**

90 15/16" [2310]  
94" [2388]  
88 9/16" [2249]  
87 13/16" [2230]  
18 5/8" [473] (3)

108 15/16" [2767]  
112" [2845]  
106 9/16" [2707]  
105 13/16" [2688]  
24 5/8" [625] (3)

96 15/16" [2462]  
100" [2540]  
94 9/16" [2402]  
93 13/16" [2383]  
20 5/8" [524] (3)

102 15/16" [2615]  
106" [2692]  
100 9/16" [2554]  
99 13/16" [2383]  
22 5/8" [575] (3)

114 15/16" [2919]  
118" [2997]  
112 9/16" [2859]  
111 13/16" [2840]  
26 5/8" [676] (3)

20 1/2" [521]  
22" [559]  
18 3/4" [476]  
18" [457]  
10 15/16" [278]

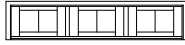

WTISWR7616

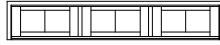

WTISWR9016

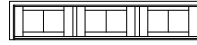

WTISWT7616

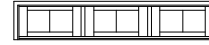

WTISWT8016

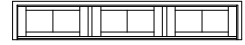

WTISWT9016

32 1/2" [826]  
34" [864]  
30 3/4" [781]  
30" [762]  
22 15/16" [583]

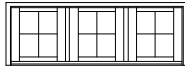

WTISWR7626

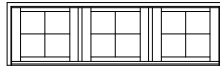

WTISWR9026

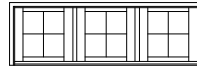

WTISWT7626

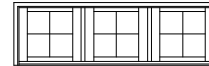

WTISWT8026

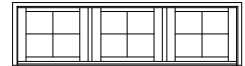

WTISWT9026

**M.O. BRICKMOULD**  
**M.O. ADAMS/FLAT CASING**  
**ROUGH OPENING**  
**FRAME SIZE**  
**DAYLIGHT OPENING**

67 3/16" [1707]  
70 1/4" [1784]  
64 13/16" [1646]  
64 1/16" [1627]  
26 5/8" [676] - 7 1/2" [190] (2)

71 3/16" [1808]  
74 1/4" [1886]  
68 13/16" [1748]  
68 1/16" [1729]  
26 5/8" [676] - 9 1/2" [241] (2)

75 3/16" [1910]  
78 1/4" [1988]  
72 13/16" [1849]  
72 1/16" [1830]  
26 5/8" [676] - 11 1/2" [292] (2)

20 1/2" [521]  
22" [559]  
18 3/4" [476]  
18" [457]  
10 15/16" [278]



WTISWT3016F10



WTISWT3016F12



WTISWT3016F14

32 1/2" [826]  
34" [864]  
30 3/4" [781]  
30" [762]  
22 15/16" [583]

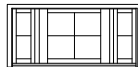

WTISWT3026F10

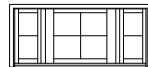

WTISWT3026F12

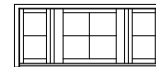

WTISWT3026F14

73 3/16" [1859]  
76 1/4" [1937]  
70 13/16" [1799]  
70 1/16" [1780]  
32 5/8" [829] - 7 1/2" [190] (2)

77 3/16" [1961]  
80 1/4" [2038]  
74 13/16" [1900]  
74 1/16" [1881]  
32 5/8" [829] - 9 1/2" [241] (2)

81 3/16" [2062]  
84 1/4" [2140]  
78 13/16" [2002]  
78 1/16" [1963]  
32 5/8" [829] - 11 1/2" [292] (2)

20 1/2" [521]  
22" [559]  
18 3/4" [476]  
18" [457]  
10 15/16" [278]



WTISWT3616F10



WTISWT3616F12



WTISWT3616F14

32 1/2" [826]  
34" [864]  
30 3/4" [781]  
30" [762]  
22 15/16" [583]



WTISWT3626F10

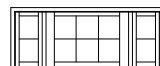

WTISWT3626F12

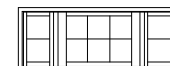

WTISWT3626F14

**ELEVATION SYMBOL LEGEND:**

**M.O.** = MASONRY OPENING  
VALUES IN [ ] ARE IN MILLIMETER CONVERSIONS.  
VALUES IN ( ) ARE NUMBER OF DAYLIGHT OPENINGS PER UNIT.

Note: Vertical Masonry Opening sizes are shown for units with 4-9/16" jamb. For transom units with 6-9/16" jamb subtract 1/8" from the finished dimensions.

Note: Elevations shown DO NOT have exterior trim. Subtract 1/2" (12.7) from M.O. (Masonry Opening) for Unit Sizes. Masonry Openings above include Sill Nose, see Transom Rail & Sill Options page for Sill Nose specifications. For other Trim Options refer to the Unit Sizing, Rough Opening & Masonry Openings page.

SCALE: 1/8" = 1'

**4-SASH FRENCH TRANSOMS**

**M.O. BRICKMOULD**  
**M.O. ADAMS/FLAT CASING**  
**ROUGH OPENING**  
**FRAME SIZE**  
**DAYLIGHT OPENING**

96 1/8" [2442]  
99 3/16" [2519]  
93 3/4" [2381]  
93" [2382]  
12 5/8" [321] (4)

120 1/8" [3051]  
123 3/16" [3129]  
117 3/4" [2991]  
117" [2972]  
18 5/8" [473] (4)

144 1/8" [3661]  
147 3/16" [3739]  
141 3/4" [3600]  
141" [3581]  
24 5/8" [625] (4)

20 1/2" [521]  
22" [559]  
18 3/4" [476]  
18" [457]  
10 15/16" [278]

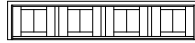

WTIFRR8016

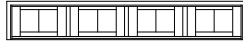

WTIFRR10016

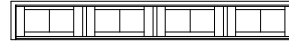

WTIFRR12016

32 1/2" [826]  
34" [864]  
30 3/4" [781]  
30" [762]  
22 15/16" [583]

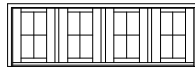

WTIFRR8026

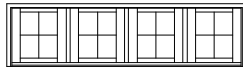

WTIFRR10026

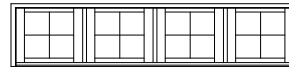

WTIFRR12026

**M.O. BRICKMOULD**  
**M.O. ADAMS/FLAT CASING**  
**ROUGH OPENING**  
**FRAME SIZE**  
**DAYLIGHT OPENING**

104 1/8" [2645]  
107 3/16" [2723]  
101 3/4" [2584]  
101" [2565]  
14 5/8" [371] (4)

128 1/8" [3254]  
131 3/16" [3332]  
125 3/4" [3194]  
125" [3175]  
20 5/8" [524] (4)

152 1/8" [3864]  
155 3/16" [3942]  
149 3/4" [3804]  
149" [3785]  
26 5/8" [676] (4)

20 1/2" [521]  
22" [559]  
18 3/4" [476]  
18" [457]  
10 15/16" [278]



WTIFRT8016



WTIFRT10016



WTIFRT10016

32 1/2" [826]  
34" [864]  
30 3/4" [781]  
30" [762]  
22 15/16" [583]

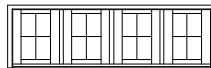

WTIFRT8026

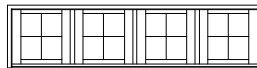

WTIFRT10026

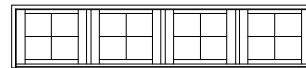

WTIFRT10026

**ELEVATION SYMBOL LEGEND:**

**M.O.** = MASONRY OPENING  
VALUES IN [ ] ARE IN MILLIMETER CONVERSIONS.  
VALUES IN ( ) ARE NUMBER OF DAYLIGHT OPENINGS PER UNIT.

Note: Vertical Masonry Opening sizes are shown for units with 4-9/16" jamb. For transom units with 6-9/16" jamb subtract 1/8" from the finished dimensions.

Note: Elevations shown DO NOT have exterior trim. Subtract 1/2" (12.7) from M.O. (Masonry Opening) for Unit Sizes. Masonry Openings above include Sill Nose, see Transom Rail & Sill Options page for Sill Nose specifications. For other Trim Options refer to the Unit Sizing, Rough Opening & Masonry Openings page.

*Continued on next page*

SCALE: 1/8" = 1'

**FRENCH TRANSOMS WITH TWO SIDELITES**

**M.O. BRICKMOULD**  
**M.O. ADAMS/FLAT CASING**  
**ROUGH OPENING**  
**FRAME SIZE**  
**DAYLIGHT OPENING**

92 3/8" [2346]  
95 7/16" [2424]  
90" [2286]  
89 1/4" [2267]  
20 5/8" [524] (2) - 7 1/2" [190] (2)

96 3/8" [2448]  
99 7/16" [2526]  
94" [2543]  
93 1/4" [2369]  
20 5/8" [524] (2) - 9 1/2" [241] (2)

100 3/8" [2550]  
103 7/16" [2627]  
98" [2489]  
97 1/4" [2470]  
20 5/8" [524] (2) - 11 1/2" [292] (2)

20 1/2" [521]  
22" [559]  
18 3/4" [476]  
18" [457]  
10 15/16" [278]

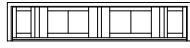

WTIFRT5016Q10

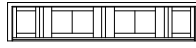

WTIFRT5016Q12

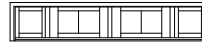

WTIFRT5016Q14

32 1/2" [826]  
34" [864]  
30 3/4" [781]  
30" [762]  
22 15/16" [583]

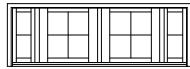

WTIFRT5026Q10

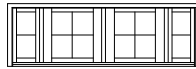

WTIFRT5026Q12

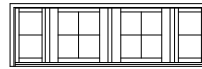

WTIFRT5026Q14

**M.O. BRICKMOULD**  
**M.O. ADAMS/FLAT CASING**  
**ROUGH OPENING**  
**FRAME SIZE**  
**DAYLIGHT OPENING**

96 3/8" [2448]  
99 7/16" [2526]  
94" [2388]  
93 1/4" [2369]  
22 5/8" [676] (2) - 7 1/2" [190] (2)

100 3/8" [2550]  
103 7/16" [2627]  
98" [2489]  
97 1/4" [2470]  
22 5/8" [676] (2) - 9 1/2" [241] (2)

104 3/8" [2651]  
107 7/16" [2769]  
102" [2591]  
101 1/4" [2572]  
22 5/8" [676] (2) - 11 1/2" [292] (2)

20 1/2" [521]  
22" [559]  
18 3/4" [476]  
18" [457]  
10 15/16" [278]

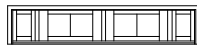

WTIFRT5416Q10

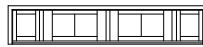

WTIFRT5416Q12

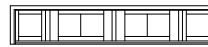

WTIFRT5416Q14

32 1/2" [826]  
34" [864]  
30 3/4" [781]  
30" [762]  
22 15/16" [583]

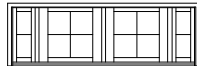

WTIFRT5426Q10

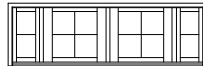

WTIFRT5426Q12

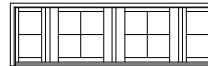

WTIFRT5426Q14

**M.O. BRICKMOULD**  
**M.O. ADAMS/FLAT CASING**  
**ROUGH OPENING**  
**FRAME SIZE**  
**DAYLIGHT OPENING**

104 3/8" [2651]  
107 7/16" [2729]  
101" [2591]  
101 1/4" [2572]  
26 5/8" [656] (2) - 7 1/2" [190] (2)

108 3/8" [2753]  
111 7/16" [2831]  
105" [2692]  
105 1/4" [2673]  
26 5/8" [656] (2) - 9 1/2" [241] (2)

112 3/8" [2854]  
115 7/16" [2932]  
109" [2794]  
109 1/4" [2775]  
26 5/8" [656] (2) - 11 1/2" [292] (2)

20 1/2" [521]  
22" [559]  
18 3/4" [476]  
18" [457]  
10 15/16" [278]

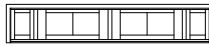

WTIFRT6016Q10

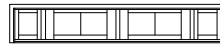

WTIFRT6016Q12

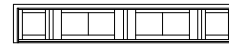

WTIFRT6016Q14

32 1/2" [826]  
34" [864]  
30 3/4" [781]  
30" [762]  
22 15/16" [583]

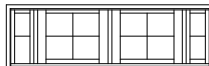

WTIFRT6026Q10

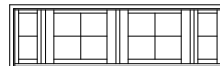

WTIFRT6026Q12

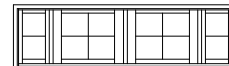

WTIFRT6026Q14

**M.O. BRICKMOULD**  
**M.O. ADAMS/FLAT CASING**  
**ROUGH OPENING**  
**FRAME SIZE**  
**DAYLIGHT OPENING**

116 3/8" [2956]  
119 7/16" [3034]  
114" [2896]  
113 1/4" [2877]  
32 5/8" [829] (2) - 7 1/2" [190] (2)

120 3/8" [3058]  
123 7/16" [3135]  
118" [2997]  
117 1/4" [2978]  
32 5/8" [829] (2) - 9 1/2" [241] (2)

124 3/8" [3159]  
127 7/16" [3237]  
122" [3099]  
121 1/4" [3080]  
32 5/8" [829] (2) - 11 1/2" [292] (2)

20 1/2" [521]  
22" [559]  
18 3/4" [476]  
18" [457]  
10 15/16" [278]

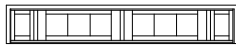

WTIFRT6016Q10

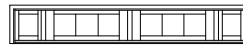

WTIFRT6016Q12

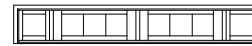

WTIFRT6016Q14

32 1/2" [826]  
34" [864]  
30 3/4" [781]  
30" [762]  
22 15/16" [583]

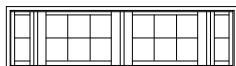

WTIFRT6026Q10

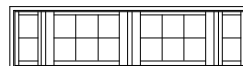

WTIFRT6026Q12



WTIFRT6026Q14

**ELEVATION SYMBOL LEGEND:**

**M.O.** = MASONRY OPENING  
VALUES IN [ ] ARE IN MILLIMETER CONVERSIONS.  
VALUES IN ( ) ARE NUMBER OF DAYLIGHT OPENINGS PER UNIT.

Note: Vertical Masonry Opening sizes are shown for units with 4-9/16" jamb. For transom units with 6-9/16" jamb subtract 1/8" from the finished dimensions.

Note: Elevations shown DO NOT have exterior trim. Subtract 1/2" (12.7) from M.O. (Masonry Opening) for Unit Sizes. Masonry Openings above include Sill Nose, see Transom Rail & Sill Options page for Sill Nose specifications. For other Trim Options refer to the Unit Sizing, Rough Opening & Masonry Openings page.

SCALE: 1/8" = 1'

**1-PANEL SECTOR TOP DOORS**

**M.O. BRICKMOULD**  
**M.O. ADAMS/FLAT CASING**  
**ROUGH OPENING**  
**FRAME SIZE**  
**DAYLIGHT OPENING**

28 9/16" [725]  
31 5/8" [803]  
26 3/16" [665]  
25 7/16" [646]  
14 5/8" [371]

34 9/16" [878]  
37 5/8" [956]  
32 3/16" [817]  
31 7/16" [799]  
20 5/8" [524]

36 9/16" [929]  
39 5/8" [1006]  
34 3/16" [868]  
33 7/16" [849]  
22 5/8" [575]

40 9/16" [1030]  
43 5/8" [1108]  
38 3/16" [969]  
37 7/16" [951]  
26 5/8" [676]

46 9/16" [1183]  
49 5/8" [1260]  
44 3/16" [1122]  
43 7/16" [1103]  
32 5/8" [829]

84 5/16" [2142]  
85 27/32" [2180]  
83 1/4" [2115]  
82 1/2" [2096]  
68 11/16" [1745]

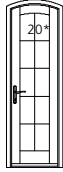

WISWTS2068

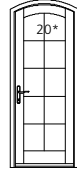

WISWTS2668

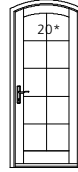

WISWTS2868

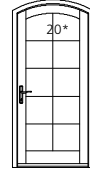

WISWTS3068

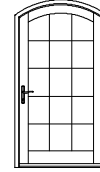

WISWTS3668

88 5/16" [2243]  
89 27/32" [2282]  
87 1/4" [2216]  
86 1/2" [2197]  
72 11/16" [1846]



WISWTS2070

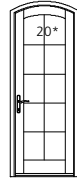

WISWTS2670



WISWTS2870

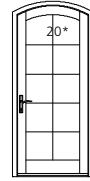

WISWTS3070

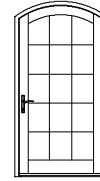

WISWTS3670

100 5/16" [2548]  
101 27/32" [2587]  
99 1/4" [2521]  
98 1/2" [2502]  
84 11/16" [2151]

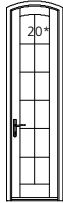

WISWTS2080

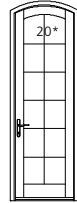

WISWTS2680

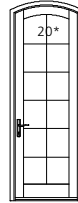

WISWTS2880

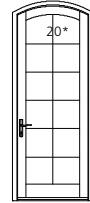

WISWTS3080

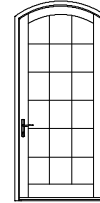

WISWTS3680

112 5/16" [2853]  
113 27/32" [2892]  
111 1/4" [2826]  
110 1/2" [2807]  
96 11/16" [2456]

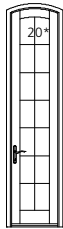

WISWTS2090

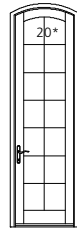

WISWTS2690

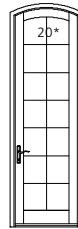

WISWTS2890

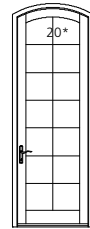

WISWTS3090

**ELEVATION SYMBOL LEGEND:**

**M.O.** = MASONRY OPENING  
VALUES IN [ ] ARE IN MILLIMETER CONVERSIONS.  
##\* NUMBER INDICATES DESIGN PRESSURE (DP) RATING  
WITH STANDARD GLAZING. OPERATING UNITS UTILIZE  
MULTI-POINT LOCKING HARDWARE FOR DP RATINGS.

Note: Elevations shown DO NOT have exterior trim. Subtract 1/2" (12.7) from M.O. (Masonry Opening) for Unit Size. For other Trim Options refer to the Unit Sizing, Rough Opening & Masonry Openings page.

SCALE: 1/8" = 1'



**3-PANEL SECTOR TOP DOORS**

**M.O. BRICKMOULD**  
**M.O. ADAMS/FLAT CASING**  
**ROUGH OPENING**  
**FRAME SIZE**  
**DAYLIGHT OPENING**

96 15/16" [2462]  
100" [2540]  
94 9/16" [2402]  
93 13/16" [2383]  
20 5/8" [524] (3)

102 15/16" [2615]  
106" [2692]  
100 9/16" [2554]  
99 13/16" [2535]  
22 5/8" [575] (3)

114 15/16" [2919]  
118" [2997]  
112 9/16" [2859]  
111 13/16" [2840]  
26 5/8" [676] (3)

84 5/16" [2142]  
85 27/32" [2180]  
83 1/4" [2115]  
82 1/2" [2096]  
68 11/16" [1745]

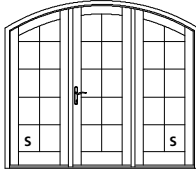

WISWTS7668

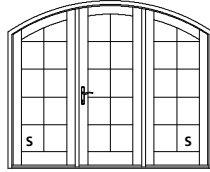

WISWTS8068

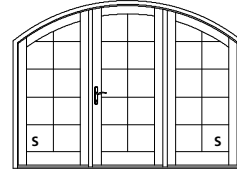

WISWTS9068

88 5/16" [2243]  
89 27/32" [2282]  
87 1/4" [22160]  
86 1/2" [2197]  
72 11/16" [1846]

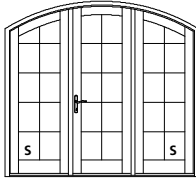

WISWTS7670

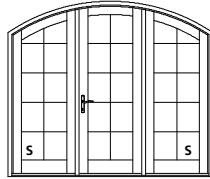

WISWTS8070

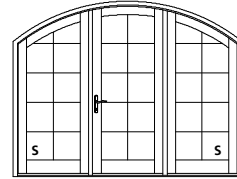

WISWTS9070

100 5/16" [2548]  
101 27/32" [2587]  
99 1/4" [2521]  
98 1/2" [2502]  
84 11/16" [2151]

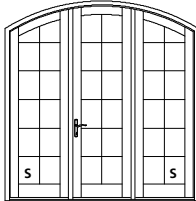

WISWTS7680

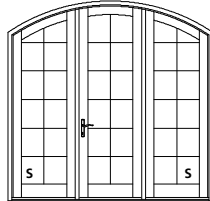

WISWTS8080

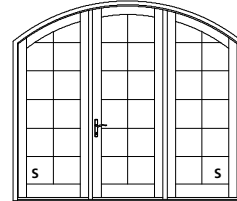

WISWTS9080

112 5/16" [2853]  
113 27/32" [2892]  
111 1/4" [2826]  
110 1/2" [2807]  
96 11/16" [2456]

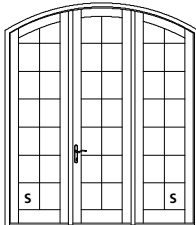

WISWTS7690

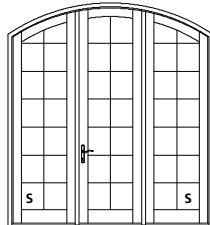

WISWTS8090

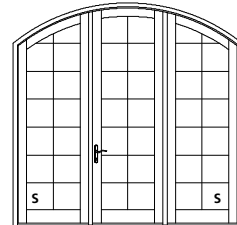

WISWTS9090

**ELEVATION SYMBOL LEGEND:**

**M.O.** = MASONRY OPENING  
VALUES IN [ ] ARE IN MILLIMETER CONVERSIONS.  
VALUES IN ( ) ARE NUMBER OF DAYLIGHT OPENINGS PER UNIT.  
**S** PANEL IS AVAILABLE AS STATIONARY ONLY.

Note: Elevations shown DO NOT have exterior trim. Subtract 1/2" (12.7) from M.O. (Masonry Opening) for Unit Size. For other Trim Options refer to the Unit Sizing, Rough Opening & Masonry Openings page.

SCALE: 1/8" = 1'

### 2-PANEL FRENCH SECTOR TOP DOORS

**M.O. BRICKMOULD**  
**M.O. ADAMS/FLAT CASING**  
**ROUGH OPENING**  
**FRAME SIZE**  
**DAYLIGHT OPENING**

53 3/4" [1365]  
56 13/16" [1443]  
51 3/8" [1304]  
50 5/8" [1286]  
14 5/8" [371] (2)

65 3/4" [1670]  
68 13/16" [1748]  
63 3/8" [1610]  
62 5/8" [1591]  
20 5/8" [524] (2)

69 3/4" [1772]  
72 13/16" [1849]  
67 3/8" [1711]  
66 5/8" [1692]  
22 5/8" [575] (2)

77 3/4" [1975]  
80 13/16" [2053]  
75 3/8" [1914]  
74 5/8" [1895]  
26 5/8" [676] (2)

89 3/4" [2280]  
92 13/16" [2357]  
87 3/8" [2219]  
86 5/8" [2200]  
32 5/8" [829] (2)

84 5/16" [2142]  
85 27/32" [2180]  
83 1/4" [2115]  
82 1/2" [2096]  
68 11/16" [1745]

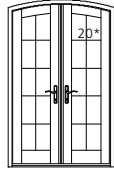

WIFRTS4068

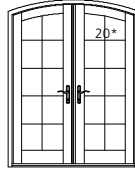

WIFRTS5068

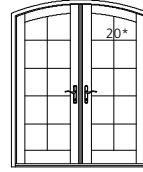

WIFRTS5468

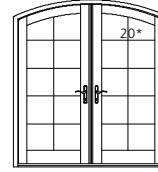

WIFRTS6068

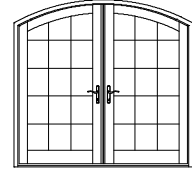

WIFRTS7068

88 5/16" [2243]  
89 27/32" [2282]  
87 1/4" [2216]  
86 1/2" [2197]  
72 11/16" [1846]

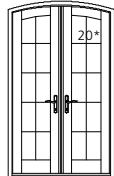

WIFRTS4070

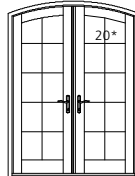

WIFRTS5070

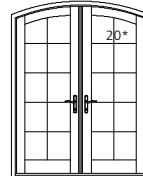

WIFRTS5470

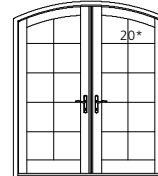

WIFRTS6070

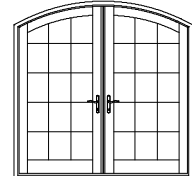

WIFRTS7070

100 5/16" [2548]  
101 27/32" [2587]  
99 1/4" [2521]  
98 1/2" [2502]  
84 11/16" [2151]

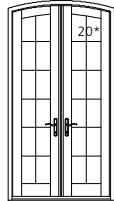

WIFRTS4080

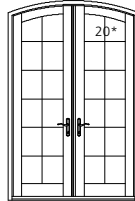

WIFRTS5080

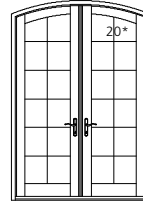

WIFRTS5480

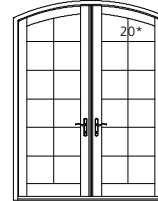

WIFRTS6080

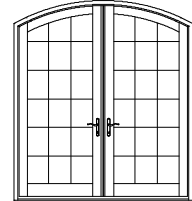

WIFRTS7080

100 5/16" [2548]  
101 27/32" [2587]  
99 1/4" [2521]  
98 1/2" [2502]  
84 11/16" [2151]

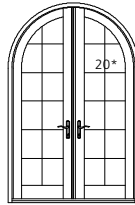

WIFRTH5080

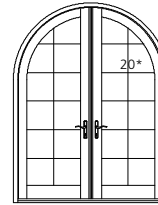

WIFRTH6080

112 5/16" [2853]  
113 27/32" [2892]  
111 1/4" [2826]  
110 1/2" [2807]  
96 11/16" [2456]

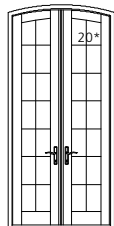

WIFRTS4090

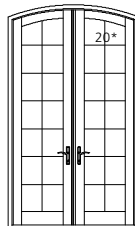

WIFRTS5090

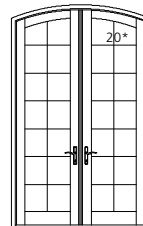

WIFRTS5490

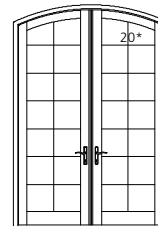

WIFRTS6090

112 5/16" [2853]  
113 27/32" [2892]  
111 1/4" [2826]  
110 1/2" [2807]  
96 11/16" [2456]

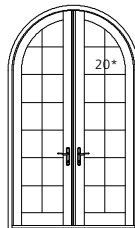

WIFRTH5090

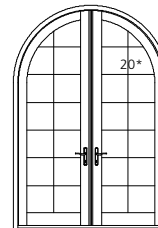

WIFRTH6090

**ELEVATION SYMBOL LEGEND:**

**M.O.** = MASONRY OPENING  
VALUES IN [ ] ARE IN MILLIMETER CONVERSIONS.  
VALUES IN ( ) ARE NUMBER OF DAYLIGHT OPENINGS PER UNIT.  
##\* NUMBER INDICATES DESIGN PRESSURE (DP) RATING WITH STANDARD GLAZING. OPERATING UNITS UTILIZE MULTI-POINT LOCKING HARDWARE FOR DP RATINGS.

Note: Elevations shown DO NOT have exterior trim. Subtract 1/2" (12.7) from M.O. (Masonry Opening) for Unit Size. For other Trim Options refer to the Unit Sizing, Rough Opening & Masonry Openings page.

SCALE: 1/8" = 1'

**4-PANEL FRENCH SECTOR TOP DOORS**

**M.O. BRICKMOULD**  
**M.O. ADAMS/FLAT CASING**  
**ROUGH OPENING**  
**FRAME SIZE**  
**DAYLIGHT OPENING**

104 1/8" [2645]  
107 3/16" [2723]  
101 3/4" [2584]  
101" [2565]  
14 5/8" [371] (4)

128 1/8" [3254]  
131 3/16" [3332]  
125 3/4" [3194]  
125" [3175]  
20 5/8" [524] (4)

84 5/16" [2142]  
85 27/32" [2180]  
83 1/4" [2115]  
82 1/2" [2096]  
68 11/16" [1745]

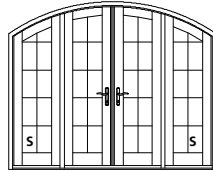

WIFRTS8068

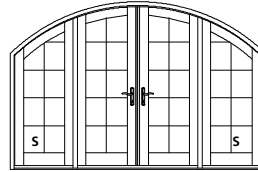

WIFRTS10068

88 5/16" [2243]  
89 27/32" [2282]  
87 1/4" [22160]  
86 1/2" [2197]  
72 11/16" [1846]

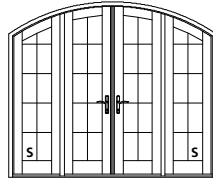

WIFRTS8070

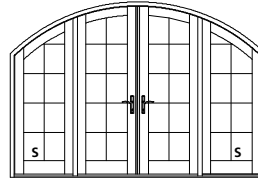

WIFRTS10070

100 5/16" [2548]  
101 27/32" [2587]  
99 1/4" [2521]  
98 1/2" [2502]  
84 11/16" [2151]

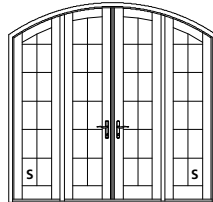

WIFRTS8080

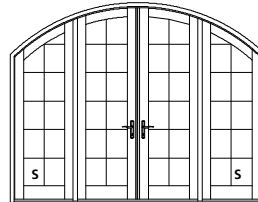

WIFRTS10080

112 5/16" [2853]  
113 27/32" [2892]  
111 1/4" [2826]  
110 1/2" [2807]  
96 11/16" [2456]

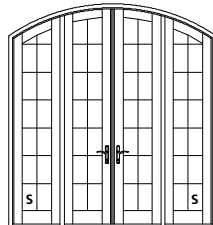

WIFRTS8090

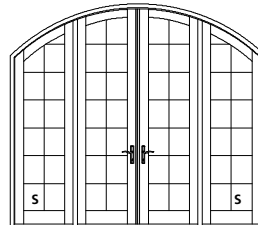

WIFRTS10090

**ELEVATION SYMBOL LEGEND:**

**M.O.** = MASONRY OPENING  
VALUES IN [ ] ARE IN MILLIMETER CONVERSIONS.  
VALUES IN ( ) ARE NUMBER OF DAYLIGHT OPENINGS PER UNIT.  
**S** PANEL IS AVAILABLE AS STATIONARY ONLY.

Note: Elevations shown DO NOT have exterior trim. Subtract 1/2" (12.7) from M.O. (Masonry Opening) for Unit Size. For other Trim Options refer to the Unit Sizing, Rough Opening & Masonry Openings page.

SCALE: 1/8" = 1'

**FRENCH SECTOR TOP DOORS WITH TWO SIDELITES**  
**5-0 UNITS**

**M.O. BRICKMOUND**  
**M.O. ADAMS/FLAT CASING**  
**ROUGH OPENING**  
**FRAME SIZE**  
**DAYLIGHT OPENING**

92 3/8" [2346]  
95 7/16" [2424]  
90" [2286]  
89 1/4" [2267]  
20 5/8" [524] (2) - 7 1/2" [190] (2)

96 3/8" [2448]  
99 7/16" [2526]  
94" [2388]  
93 1/4" [2369]  
20 5/8" [524] (2) - 9 1/2" [241] (2)

100 3/8" [2550]  
103 7/16" [2627]  
98" [2489]  
97 1/4" [2470]  
20 5/8" [524] (2) - 11 1/2" [292] (2)

84 5/16" [2142]  
85 27/32" [2180]  
83 1/4" [2115]  
82 1/2" [2096]  
68 11/16" [1745]

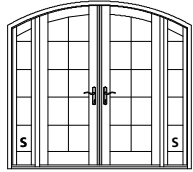

WIFRTS5068Q10

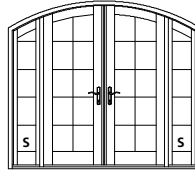

WIFRTS5068Q12

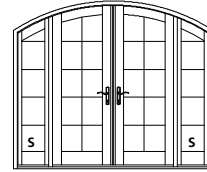

WIFRTS5068Q14

88 5/16" [2243]  
89 27/32" [2282]  
87 1/4" [2216]  
86 1/2" [2197]  
72 11/16" [1846]

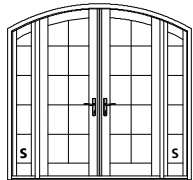

WIFRTS5070Q10

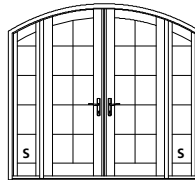

WIFRTS5070Q12

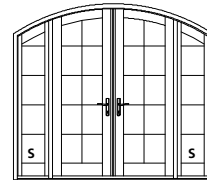

WIFRTS5070Q14

100 5/16" [2548]  
101 27/32" [2587]  
99 1/4" [2521]  
98 1/2" [2502]  
84 11/16" [2151]

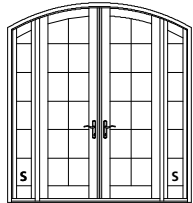

WIFRTS5080Q10

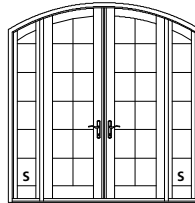

WIFRTS5080Q12

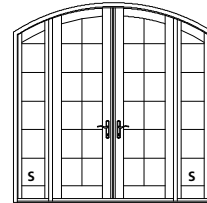

WIFRTS5080Q14

112 5/16" [2853]  
113 27/32" [2892]  
111 1/4" [2826]  
110 1/2" [2807]  
96 11/16" [2456]

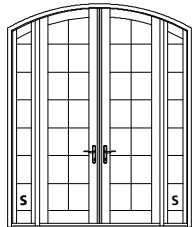

WIFRTS5090Q10

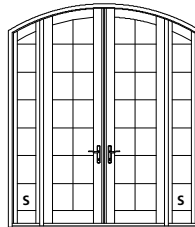

WIFRTS5090Q12

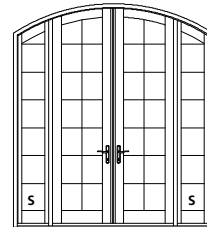

WIFRTS5090Q14

**ELEVATION SYMBOL LEGEND:**

**M.O.** = MASONRY OPENING  
VALUES IN [ ] ARE IN MILLIMETER CONVERSIONS.  
VALUES IN ( ) ARE NUMBER OF DAYLIGHT OPENINGS PER UNIT.  
**S** PANEL IS AVAILABLE AS STATIONARY ONLY.

Note: Elevations shown DO NOT have exterior trim. Subtract 1/2" (12.7) from M.O. (Masonry Opening) for Unit Size. For other Trim Options refer to the Unit Sizing, Rough Opening & Masonry Openings page.

SCALE: 1/8" = 1'

**FRENCH SECTOR TOP DOORS WITH TWO SIDELITES**  
**5-4 UNITS**

**M.O. BRICKMOULD**  
**M.O. ADAMS/FLAT CASING**  
**ROUGH OPENING**  
**FRAME SIZE**  
**DAYLIGHT OPENING**

96 3/8" [2448]  
99 7/16" [2526]  
94" [2388]  
93 1/4" [2369]  
22 5/8" [575] (2) - 7 1/2" [190] (2)

100 3/8" [2550]  
103 7/16" [2627]  
98" [2489]  
97 1/4" [2470]  
22 5/8" [575] (2) - 9 1/2" [241] (2)

104 3/8" [2651]  
107 7/16" [2729]  
102" [2591]  
101 1/4" [2572]  
22 5/8" [575] (2) - 11 1/2" [292] (2)

84 5/16" [2142]  
85 27/32" [2180]  
83 1/4" [2115]  
82 1/2" [2096]  
68 11/16" [1745]

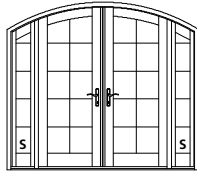

WIFRTS5468Q10

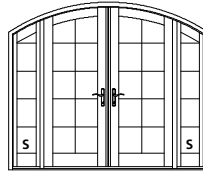

WIFRTS5468Q12

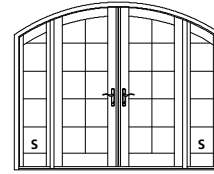

WIFRTS5468Q14

88 5/16" [2243]  
89 27/32" [2282]  
87 1/4" [2216]  
86 1/2" [2197]  
72 11/16" [1846]

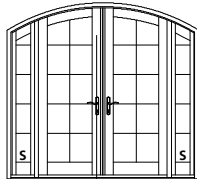

WIFRTS5470Q10

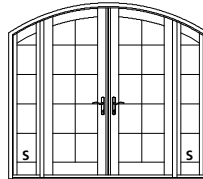

WIFRTS5470Q12

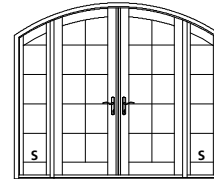

WIFRTS5470Q14

100 5/16" [2548]  
101 27/32" [2587]  
99 1/4" [2521]  
98 1/2" [2502]  
84 11/16" [2151]

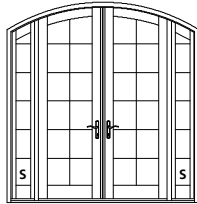

WIFRTS5480Q10

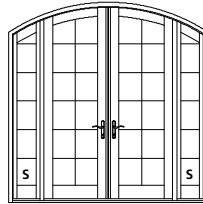

WIFRTS5480Q12

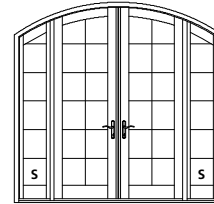

WIFRTS5480Q14

112 5/16" [2853]  
113 27/32" [2892]  
111 1/4" [2826]  
110 1/2" [2807]  
96 11/16" [2456]

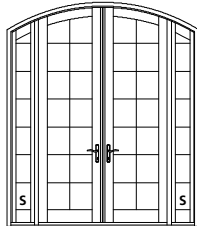

WIFRTS5490Q10

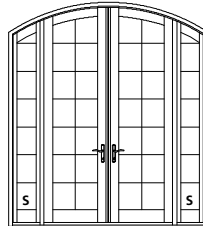

WIFRTS5490Q12

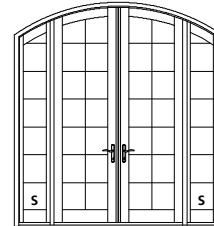

WIFRTS5490Q14

**ELEVATION SYMBOL LEGEND:**

**M.O.** = MASONRY OPENING  
VALUES IN [ ] ARE IN MILLIMETER CONVERSIONS.  
VALUES IN ( ) ARE NUMBER OF DAYLIGHT OPENINGS PER UNIT.  
**S** PANEL IS AVAILABLE AS STATIONARY ONLY.

Note: Elevations shown DO NOT have exterior trim. Subtract 1/2" (12.7) from M.O. (Masonry Opening) for Unit Size. For other Trim Options refer to the Unit Sizing, Rough Opening & Masonry Openings page.

SCALE: 1/8" = 1'

**FRENCH SECTOR TOP DOORS WITH TWO SIDELITES**  
**6-0 UNITS**

**M.O. BRICKMOUND**  
**M.O. ADAMS/FLAT CASING**  
**ROUGH OPENING**  
**FRAME SIZE**  
**DAYLIGHT OPENING**

104 3/8" [2651]  
107 7/16" [2729]  
102" [2591]  
101 1/4" [2572]  
26 5/8" [676] (2) - 7 1/2" [190] (2)

108 3/8" [2753]  
111 7/16" [2831]  
106" [2692]  
105 1/4" [2673]  
26 5/8" [676] (2) - 9 1/2" [241] (2)

112 3/8" [2854]  
115 7/16" [2932]  
110" [2794]  
109 1/4" [2775]  
26 5/8" [676] (2) - 11 1/2" [292] (2)

84 5/16" [2142]  
85 27/32" [2180]  
83 1/4" [2115]  
82 1/2" [2096]  
68 11/16" [1745]

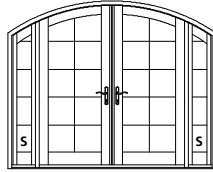

WIFRTS6068Q10

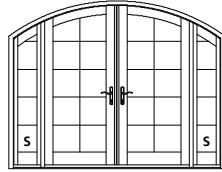

WIFRTS6068Q12

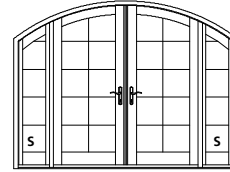

WIFRTS6068Q14

88 5/16" [2243]  
89 27/32" [2282]  
87 1/4" [2216]  
86 1/2" [2197]  
72 11/16" [1846]

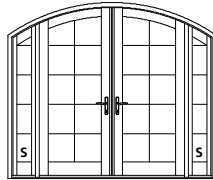

WIFRTS6070Q10

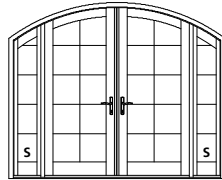

WIFRTS6070Q12

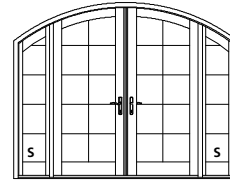

WIFRTS6070Q14

100 5/16" [2548]  
101 27/32" [2587]  
99 1/4" [2521]  
98 1/2" [2502]  
84 11/16" [2151]

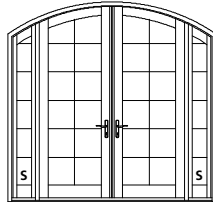

WIFRTS6080Q10

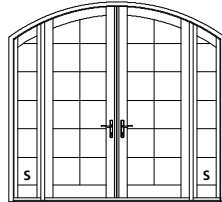

WIFRTS6080Q12

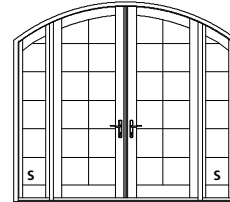

WIFRTS6080Q14

112 5/16" [2853]  
113 27/32" [2892]  
111 1/4" [2826]  
110 1/2" [2807]  
96 11/16" [2456]

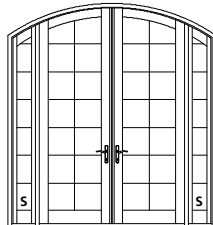

WIFRTS6090Q10

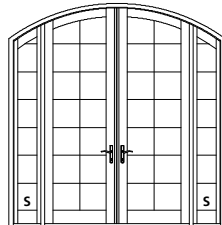

WIFRTS6090Q12

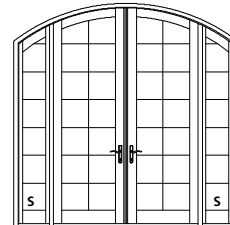

WIFRTS6090Q14

**ELEVATION SYMBOL LEGEND:**

**M.O.** = MASONRY OPENING  
VALUES IN [ ] ARE IN MILLIMETER CONVERSIONS.  
VALUES IN ( ) ARE NUMBER OF DAYLIGHT OPENINGS PER UNIT.  
**S** = PANEL IS AVAILABLE AS STATIONARY ONLY.

Note: Elevations shown DO NOT have exterior trim. Subtract 1/2" (12.7) from M.O. (Masonry Opening) for Unit Size. For other Trim Options refer to the Unit Sizing, Rough Opening & Masonry Openings page.

SCALE: 1/8" = 1'

**FRENCH SECTOR TOP DOORS WITH TWO SIDELITES**  
**7-0 UNITS**

**M.O. BRICKMOULD**  
**M.O. ADAMS/FLAT CASING**  
**ROUGH OPENING**  
**FRAME SIZE**  
**DAYLIGHT OPENING**

116 3/8" [2956]  
119 7/16" [3034]  
114" [2896]  
113 1/4" [2877]  
32 5/8" [829] (2) - 7 1/2" [190] (2)

120 3/8" [3058]  
123 7/16" [3135]  
118" [2997]  
117 1/4" [2978]  
32 5/8" [829] (2) - 9 1/2" [241] (2)

124 3/8" [3159]  
127 7/16" [3237]  
122" [3099]  
121 1/4" [3080]  
32 5/8" [829] (2) - 11 1/2" [292] (2)

84 5/16" [2142]  
85 27/32" [2180]  
83 1/4" [2115]  
82 1/2" [2096]  
68 11/16" [1745]

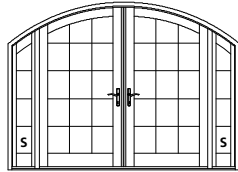

WIFRTS7068Q10

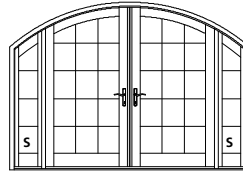

WIFRTS7068Q12

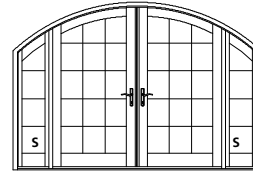

WIFRTS7068Q14

88 5/16" [2243]  
89 27/32" [2282]  
87 1/4" [2216]  
86 1/2" [2197]  
72 11/16" [1846]

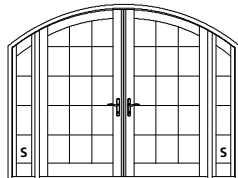

WIFRTS7070Q10

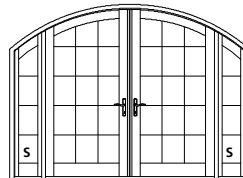

WIFRTS7070Q12

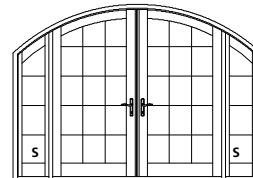

WIFRTS7070Q14

100 5/16" [2548]  
101 27/32" [2587]  
99 1/4" [2521]  
98 1/2" [2502]  
84 11/16" [2151]

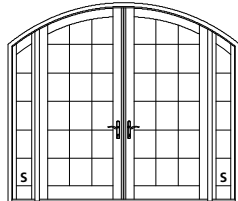

WIFRTS7080Q10

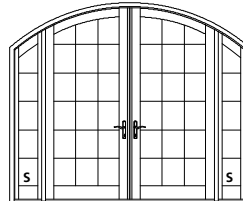

WIFRTS7080Q12

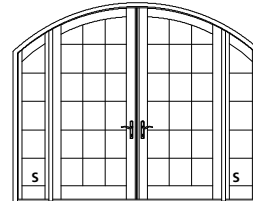

WIFRTS7080Q14

**ELEVATION SYMBOL LEGEND:**

**M.O.** = MASONRY OPENING  
VALUES IN [ ] ARE IN MILLIMETER CONVERSIONS.  
VALUES IN ( ) ARE NUMBER OF DAYLIGHT OPENINGS PER UNIT.  
**S** PANEL IS AVAILABLE AS STATIONARY ONLY.

Note: Elevations shown DO NOT have exterior trim. Subtract 1/2" (12.7) from M.O. (Masonry Opening) for Unit Size. For other Trim Options refer to the Unit Sizing, Rough Opening & Masonry Openings page.

**SECTOR TOP TRANSOM UNITS**

**M.O. BRICKMOULD**  
**M.O. ADAMS/FLAT CASING**  
**ROUGH OPENING**  
**FRAME SIZE**  
**DAYLIGHT OPENING**

28 11/16" [729]  
31 3/4" [806]  
26 3/16" [665]  
25 7/16" [646]  
14 5/8" [371]

34 11/16" [881]  
37 3/4" [959]  
32 3/16" [818]  
31 7/16" [799]  
20 5/8" [524]

36 11/16" [932]  
39 3/4" [1010]  
34 3/16" [868]  
33 7/16" [849]  
22 5/8" [575]

40 11/16" [1033]  
43 3/4" [1111]  
38 3/16" [970]  
37 7/16" [951]  
26 5/8" [676]

22 1/2" [572]  
24" [607]  
20 3/4" [527]  
20" [508]  
12 15/16" [329]



CTISWTS2018



CTISWTS2618



CTISWTS2818



CTISWTS3018

32 1/2" [826]  
34" [864]  
30 3/4" [781]  
30" [762]  
22 15/16" [583]



CTISWTS2026



CTISWTS2626



CTISWTS2826



CTISWTS3026

**M.O. BRICKMOULD**  
**M.O. ADAMS/FLAT CASING**  
**ROUGH OPENING**  
**FRAME SIZE**  
**DAYLIGHT OPENING**

65 7/8" [1673]  
68 15/16" [1751]  
51 3/8" [1304]  
62 5/8" [1591]  
39 13/16" [1011]

65 7/8" [1673]  
68 15/16" [1751]  
63 3/8" [1610]  
62 5/8" [1591]  
51 13/16" [1316]

69 7/8" [1775]  
72 15/16" [1853]  
67 3/8" [1711]  
66 5/8" [1692]  
55 13/16" [1418]

77 7/8" [1978]  
80 15/16" [2056]  
75 3/8" [1914]  
74 5/8" [1895]  
63 13/16" [1621]

22 1/2" [572]  
24" [607]  
20 3/4" [527]  
20" [508]  
12 15/16" [329]



CTIFRTS4018

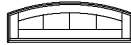

CTIFRTS5018



CTIFRTS5418



CTIFRTS6018

32 1/2" [826]  
34" [864]  
30 3/4" [781]  
30" [762]  
22 15/16" [583]

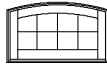

CTIFRTS4026

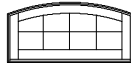

CTIFRTS5026



CTIFRTS5426

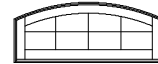

CTIFRTS6026

**ELEVATION SYMBOL LEGEND:**

**M.O.** = MASONRY OPENING  
VALUES IN [ ] ARE IN MILLIMETER CONVERSIONS.  
**F** PANEL IS AVAILABLE AS FIXED ONLY.

Note: Vertical Masonry Opening sizes are shown for units with 4-9/16" jamb. For transom units with 6-9/16" jamb subtract 1/8" from the finished dimensions.

Note: Elevations shown DO NOT have exterior trim. Subtract 1/2" (12.7) from M.O. (Masonry Opening) for Unit Sizes. Masonry Openings above include Sill Nose, see Transom Rail & Sill Options page for Sill Nose specifications. For other Trim Options refer to the Unit Sizing, Rough Opening & Masonry Openings page.

SCALE: 1/8" = 1'



**GLAZING OPTIONS**

**INTERIOR GLAZED**  
INSULATED 3/4" [19] GLASS

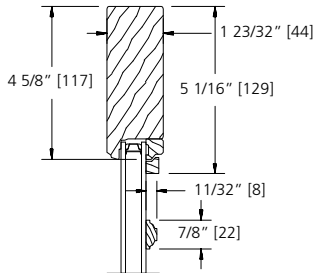

**7/8" GRILLE BAR**

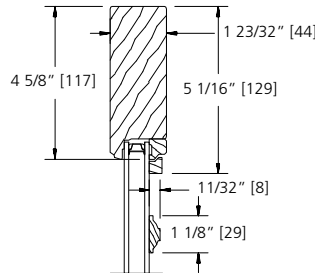

**1 1/8" GRILLE BAR**

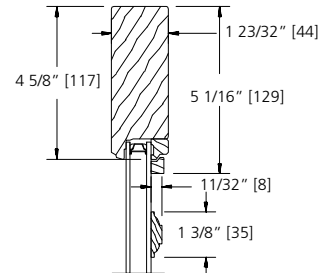

**1 3/8" GRILLE BAR**

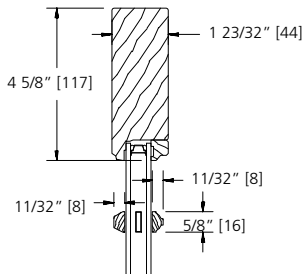

**5/8" SDL BAR  
(PUTTY/BEAD)**

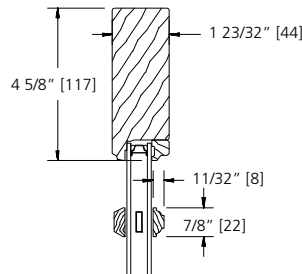

**7/8" SDL BAR  
(PUTTY/BEAD)**

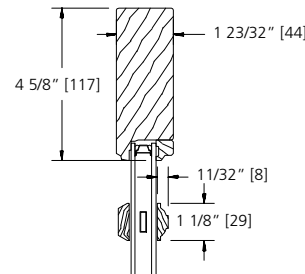

**1 1/8" SDL BAR  
(PUTTY/BEAD)**

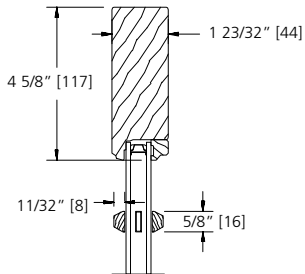

**5/8" SDL BAR  
(PUTTY/PUTTY)**

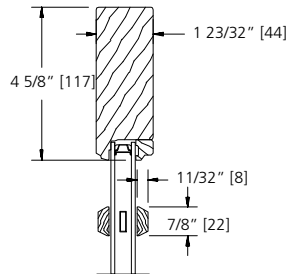

**7/8" SDL BAR  
(PUTTY/PUTTY)**

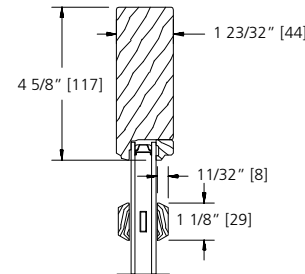

**1 1/8" SDL BAR  
(PUTTY/PUTTY)**

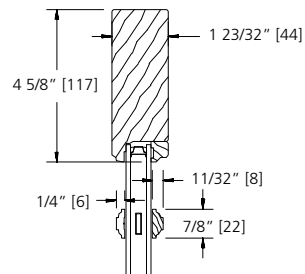

**7/8" SDL BAR  
(BEAD STOP)**

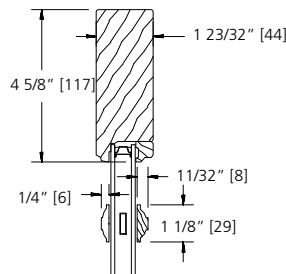

**1 1/8" SDL BAR  
(BEAD STOP)**

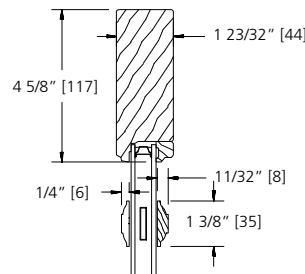

**1 3/8" SDL BAR  
(BEAD STOP)**

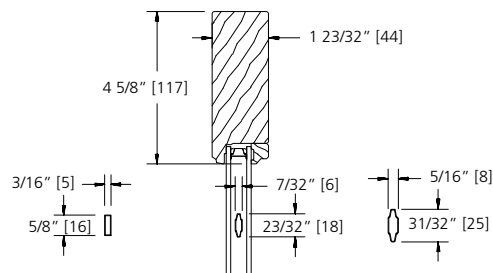

**5/8" FLAT GBG**

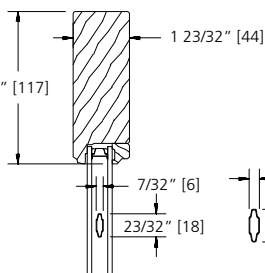

**23/32" CONTOUR GBG**

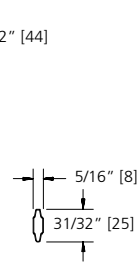

**1" CONTOUR GBG**

SCALE: NTS

**GLAZING OPTIONS**

**INTERIOR GLAZED**  
SINGLE 1/8" [3] GLASS

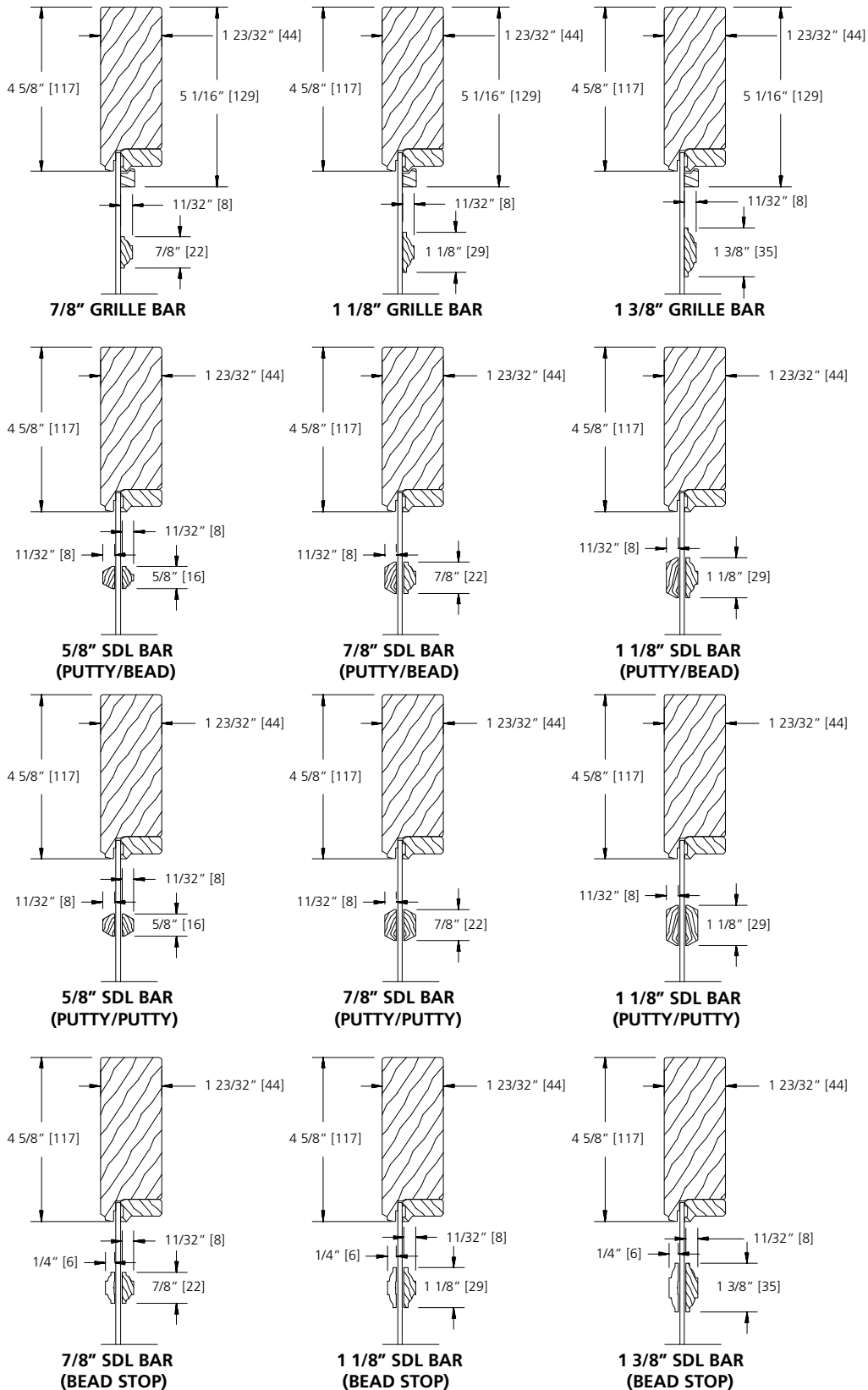

SCALE: NTS

**GLAZING OPTIONS**

**INTERIOR GLAZED**  
IMPACT RESISTANT GLASS

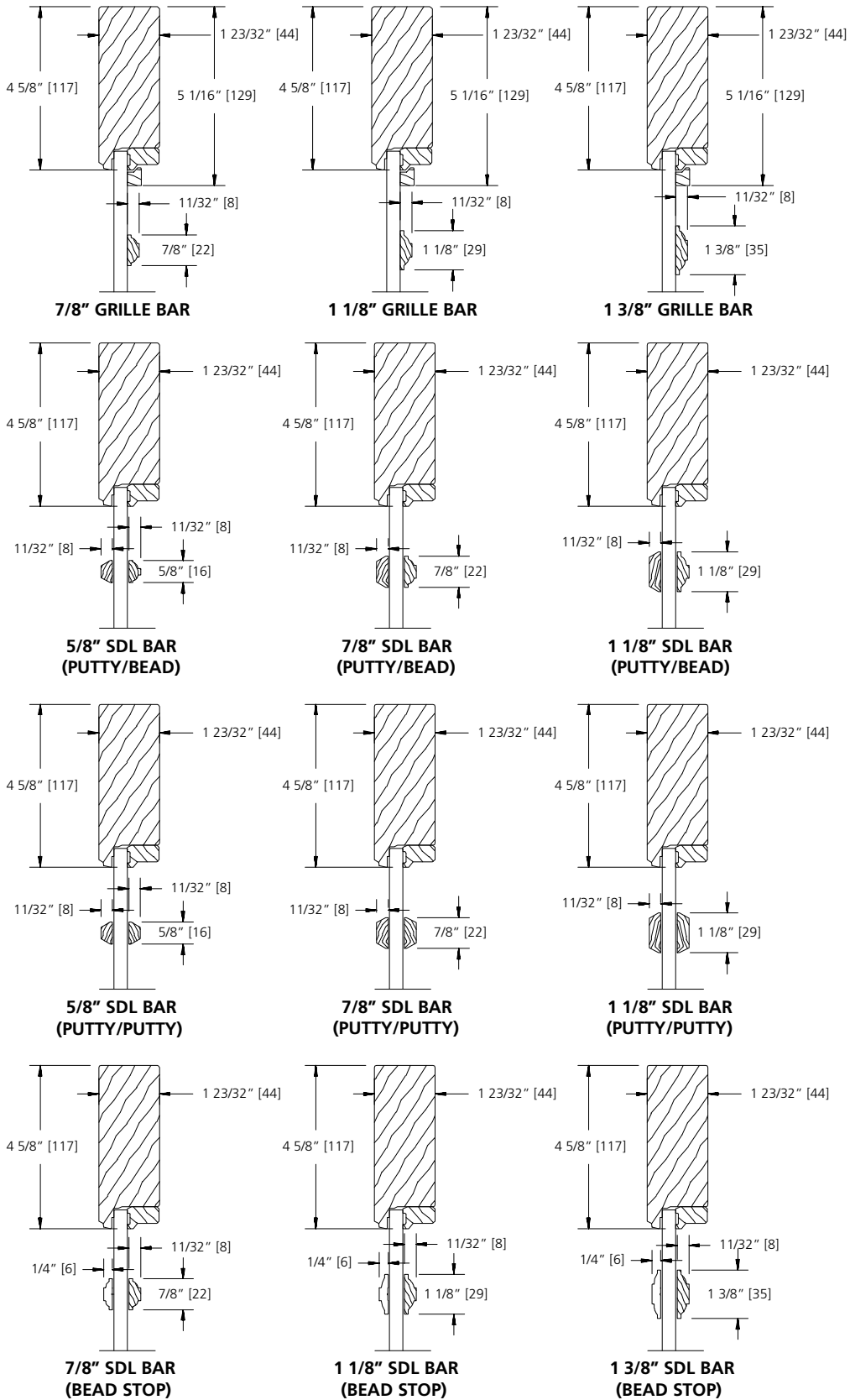

SCALE: NTS

**GLAZING OPTIONS**

**EXTERIOR GLAZED**

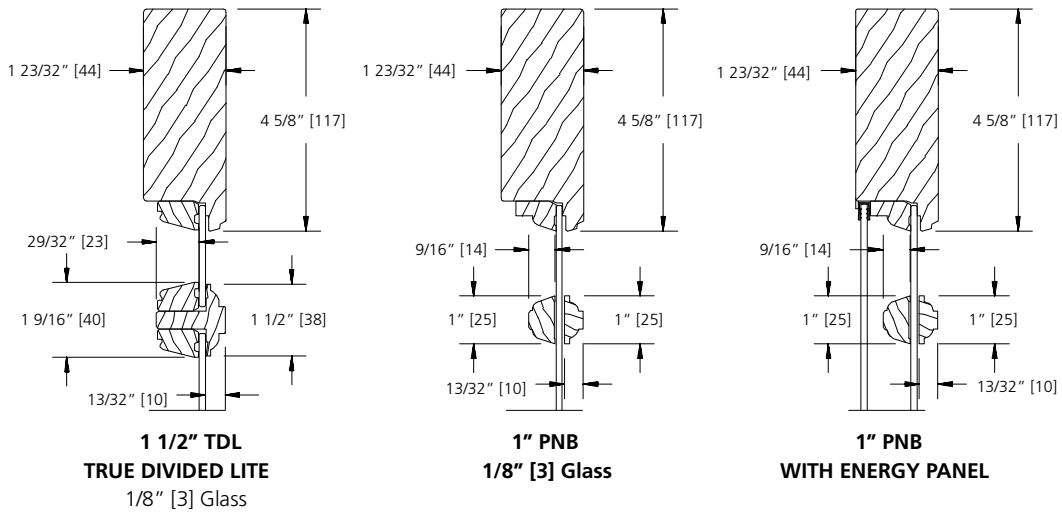
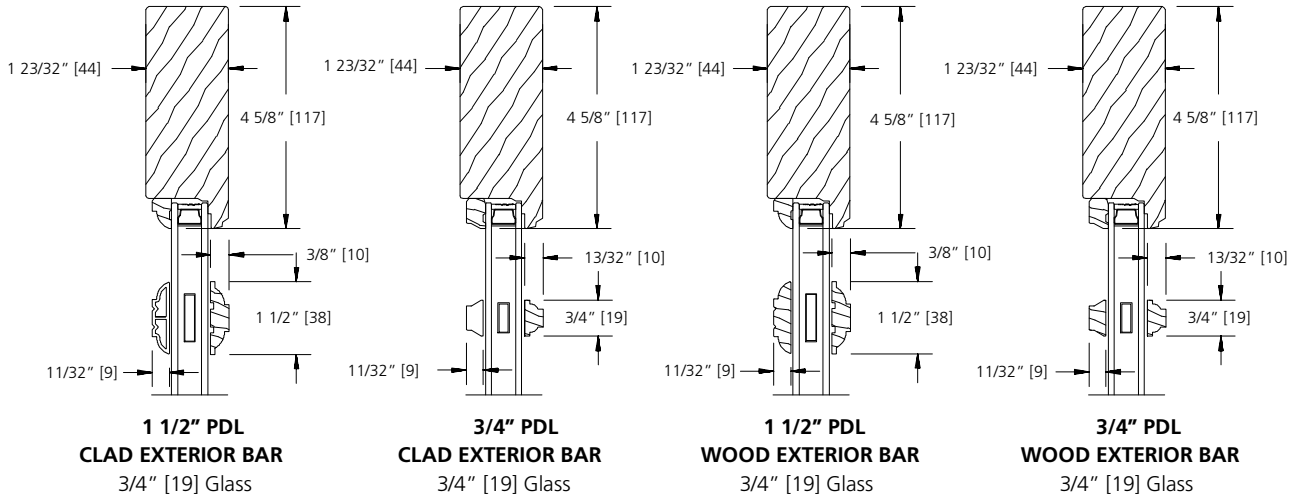

SCALE: NTS

**TRIM OPTIONS**

**EXTERIOR TRIM**

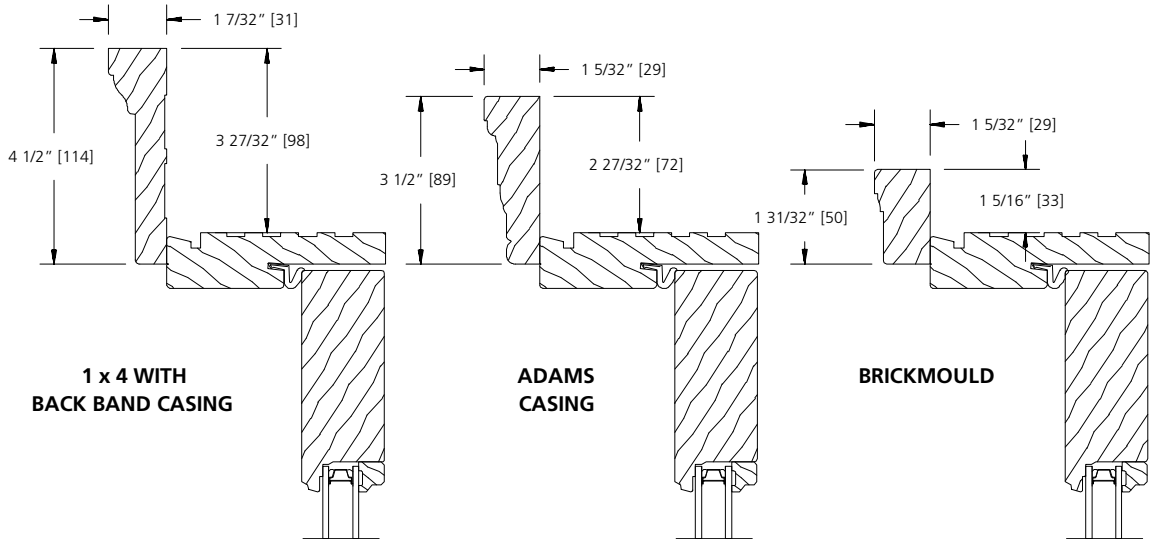
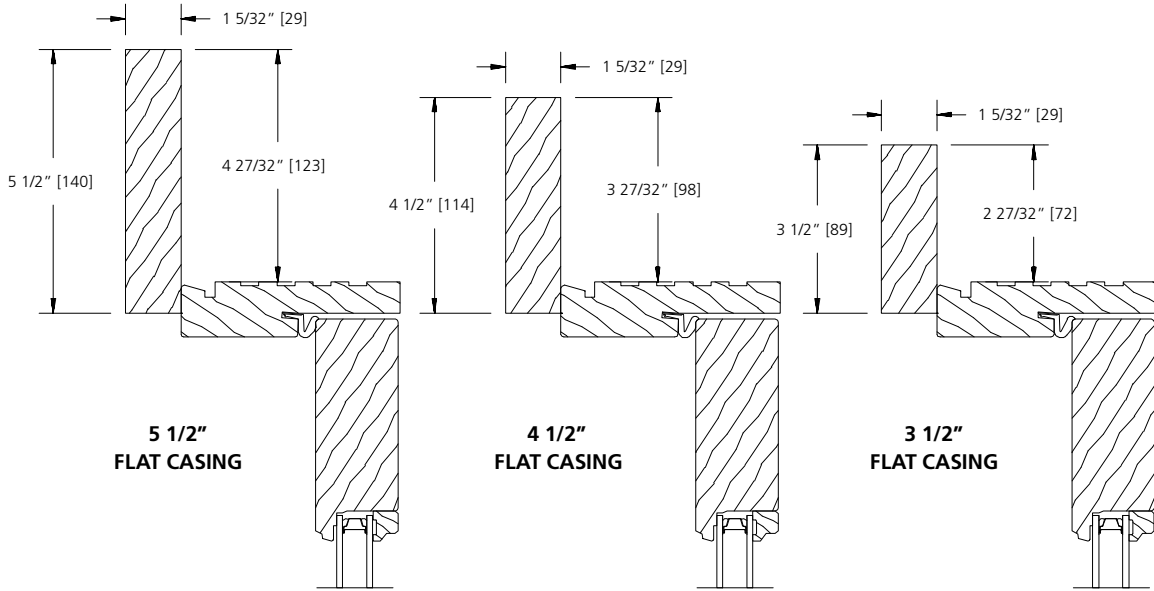

**STUCCO TRIM OPTION**

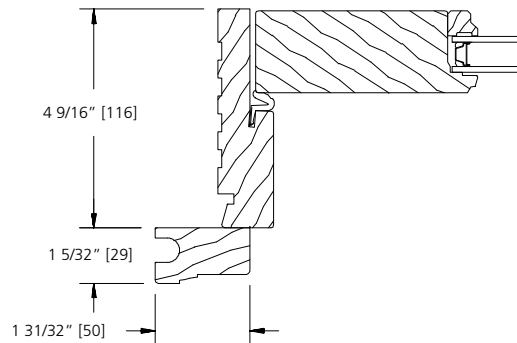

SCALE: 3" = 1'

**RAIL, PANEL & SILL OPTIONS**

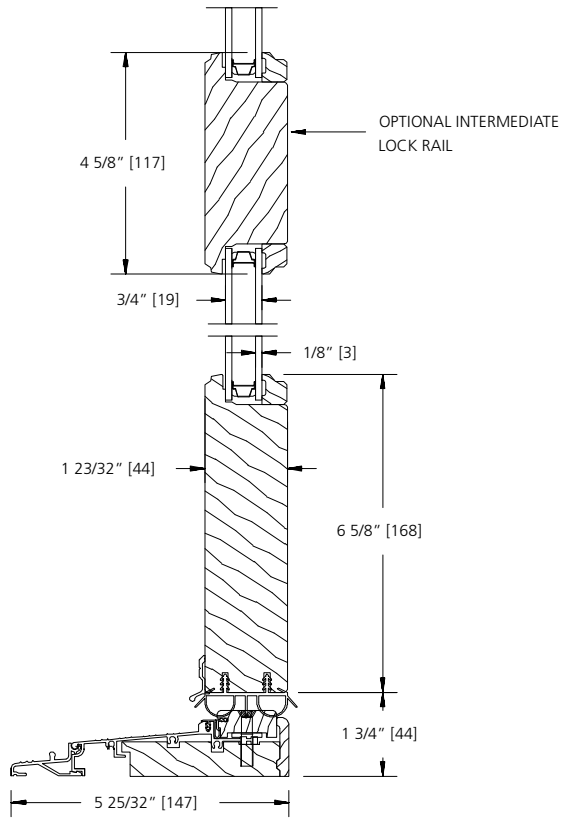

**STANDARD 6 5/8" BOTTOM RAIL**  
**STANDARD SILL (4 9/16 JAMB)**

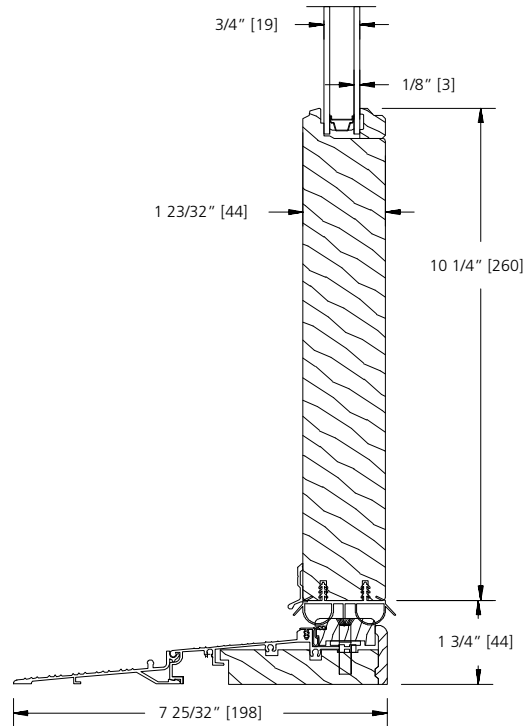

**OPTIONAL 10 1/4" BOTTOM RAIL**  
**SILL EXTENSION (6 9/16 JAMB)**

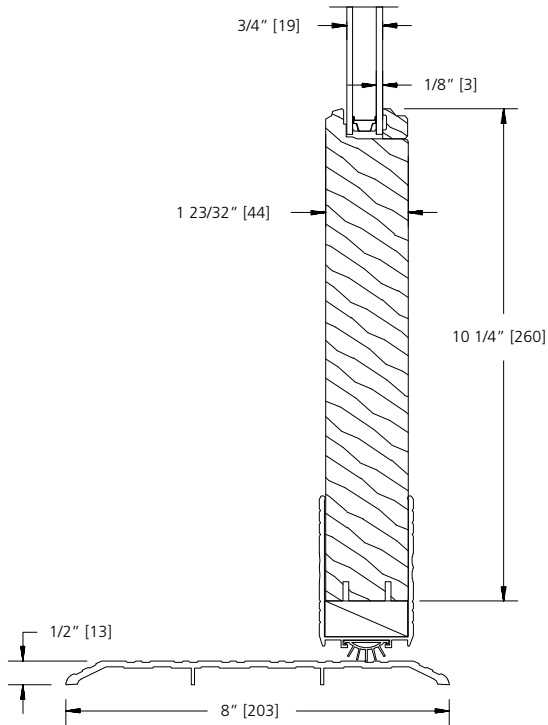

**OPTIONAL 10 1/4" BOTTOM RAIL**  
**HANDICAP SILL (4 9/16 JAMB)**

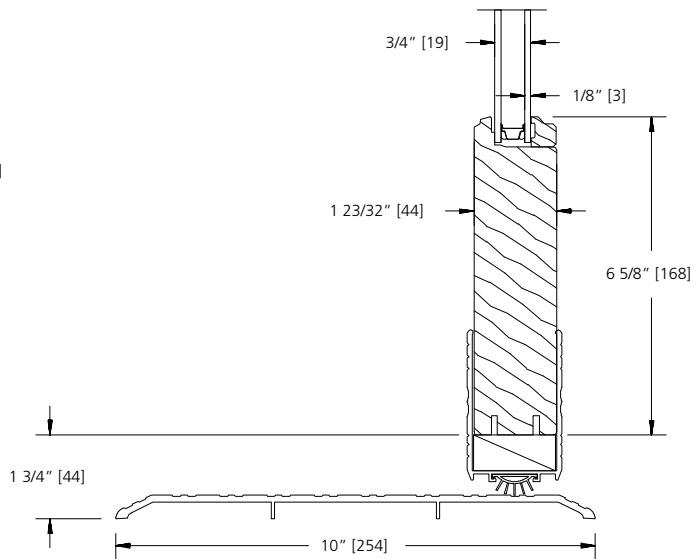

**STANDARD 6 5/8" BOTTOM RAIL**  
**HANDICAP SILL (6 9/16 JAMB)**

SCALE: 3" = 1'

**RAIL, PANEL & SILL OPTIONS**

**TRANSOM**

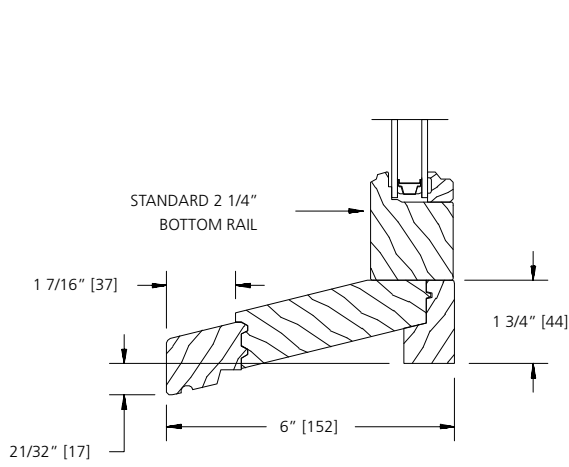

**TRANSOM  
SILL NOSE  
(4 9/16" JAMB)**

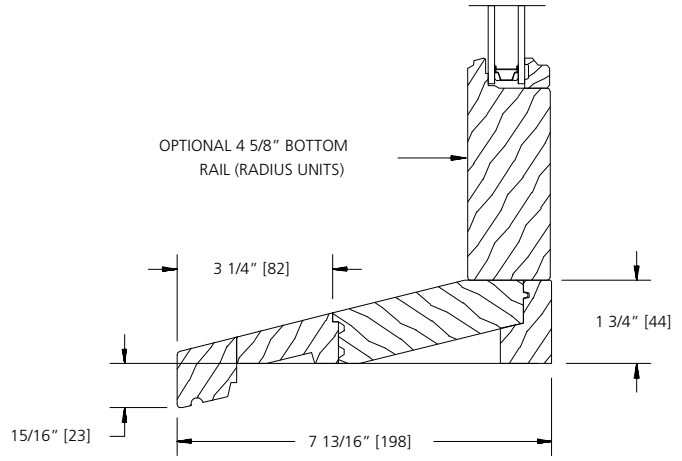

**TRANSOM  
SILL NOSE  
(6 9/16" JAMB)**

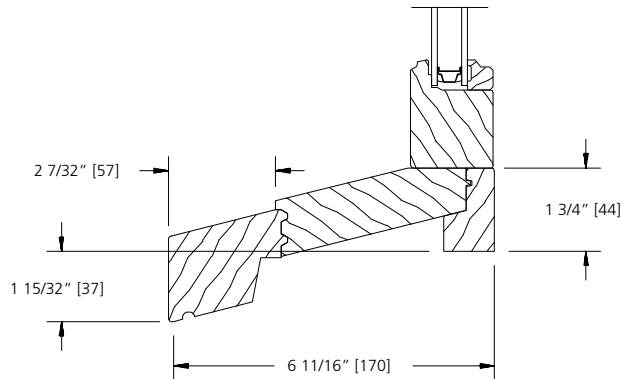

**TRANSOM  
EXTENDED SILL NOSE  
(4 9/16" JAMB)**

SCALE: 3" = 1'

**RAIL, PANEL & SILL OPTIONS**

**STANDARD RAISED PANEL OPTIONS**

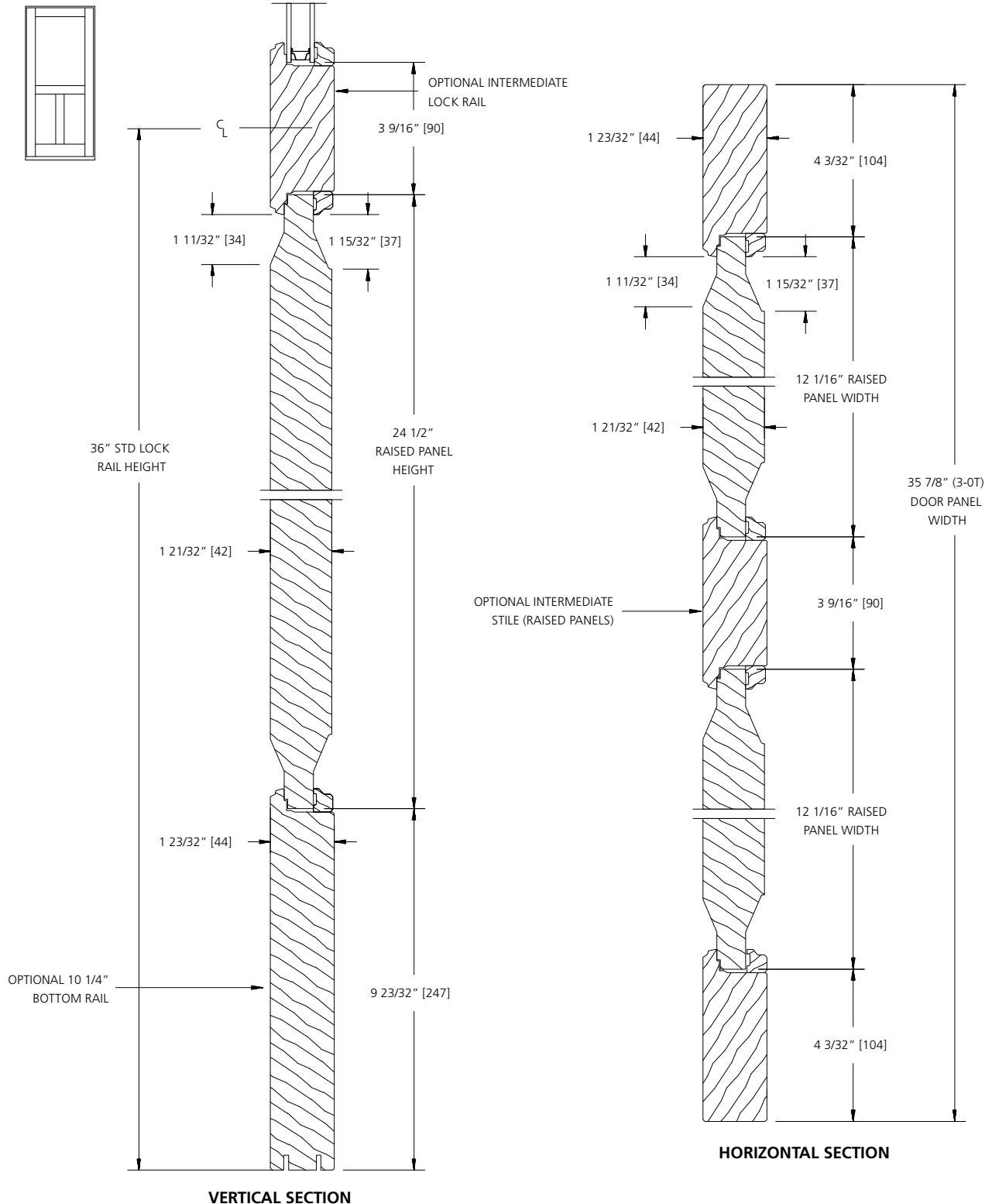

SCALE: 3" = 1'



**RAIL, PANEL & SILL OPTIONS**

**OPTIONAL RAISED PANEL OPTIONS**

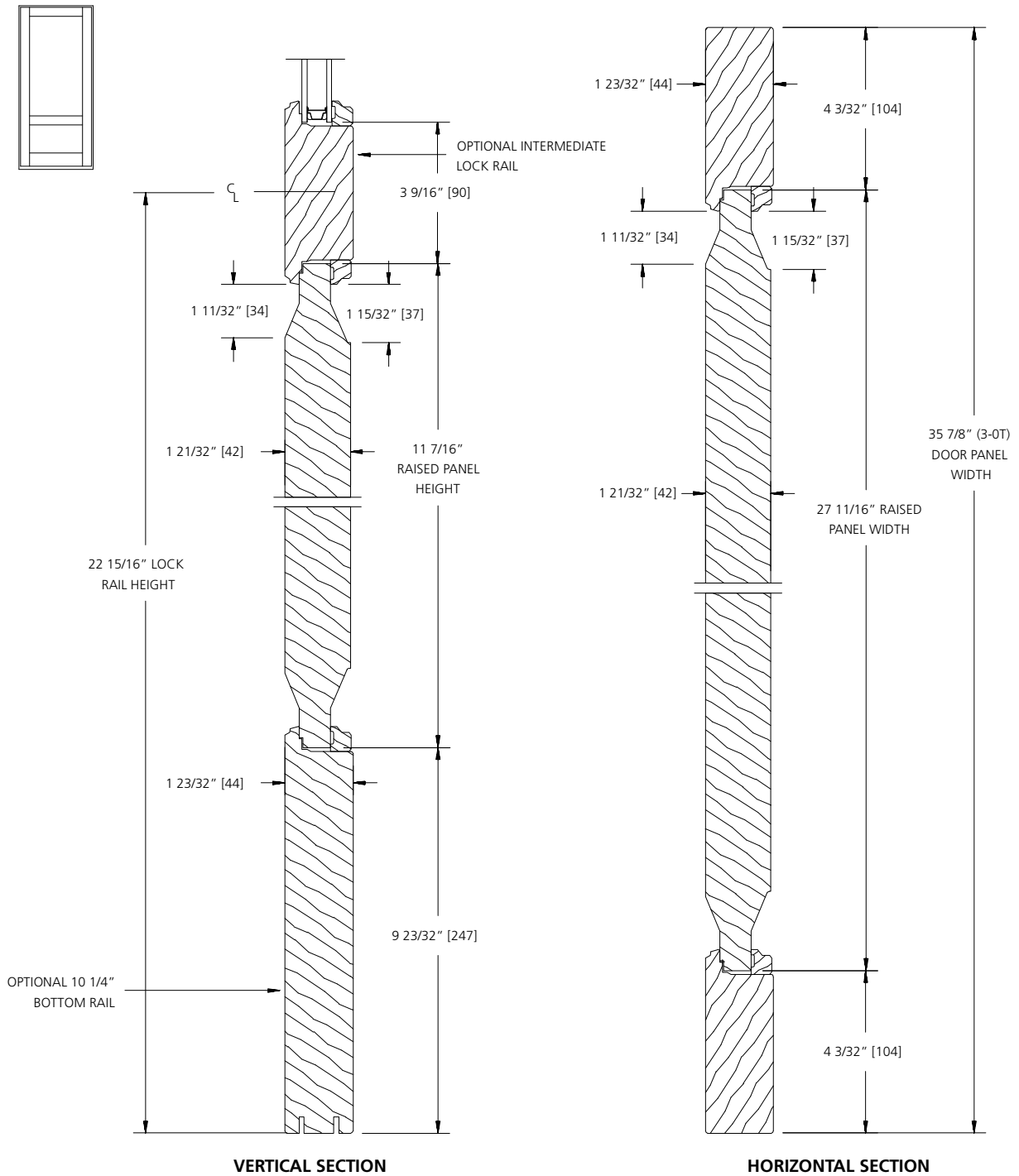

SCALE: 3" = 1'

**STANDARD MULLION DETAILS**

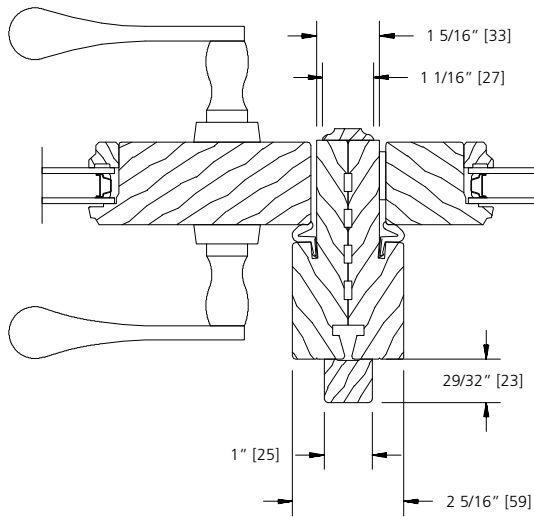

**SIDE JAMB**

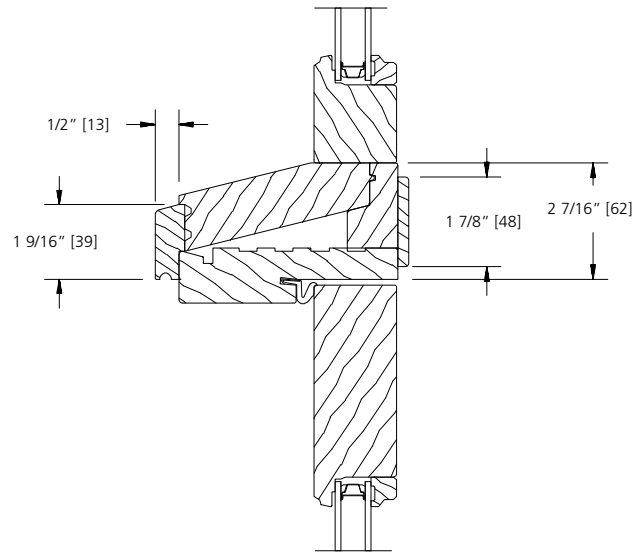

**HEAD / SILL  
(4 9/16" JAMB)**

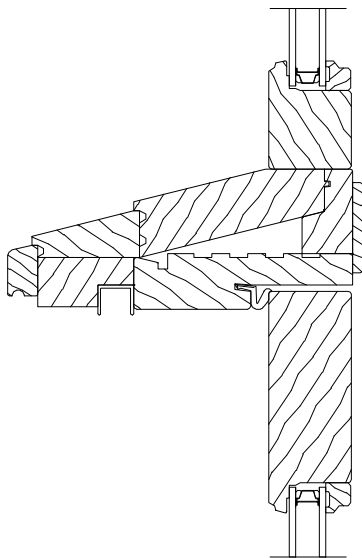

**HEAD / SILL WITH SCREEN  
(6 9/16" JAMB)**

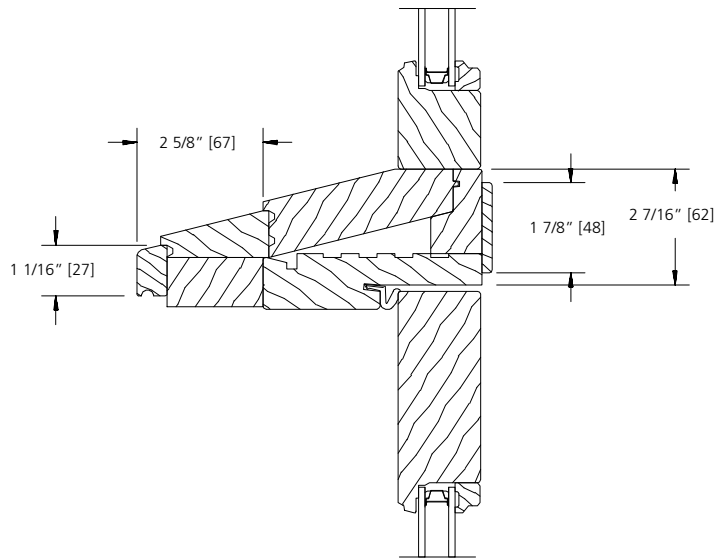

**HEAD / SILL  
(6 9/16" JAMB)**

SCALE: 3" = 1'

**LITE CUT INFORMATION**

Wood in-swing patio doors are available with removable grilles in 5/8", 7/8", 1-1/8", and 1-3/8" widths, with GBG (Grilles between the Glass), or with Simulated Divided Lites. Standard lite cuts are rectangular.

**LITE CUT OPTIONS**

Special lite cut patterns can include a wide variety of straight line and radius patterns. The illustrations shown here represent just a few of the possibilities. Rectangular, horizontal, vertical and Prairie lite patterns are available in all standard size wood swinging patio doors. Uneven, diamond, radius and Gothic lite cuts are available, subject to approval. Approvals are based on the ability to fulfill the design requirement while maintaining the construction integrity of the finished product.

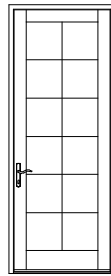

RECTANGULAR

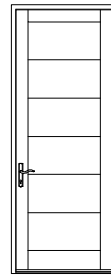

HORIZONTAL

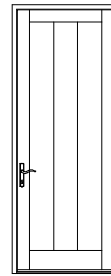

VERTICAL

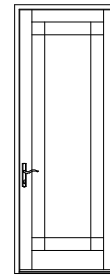

PRAIRIE

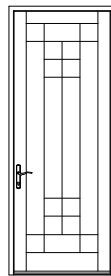

UNEVEN

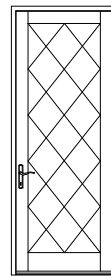

DIAMOND

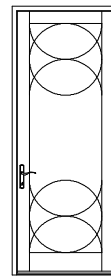

RADIUS

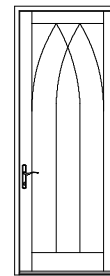

GOthic

**BAR ALIGNMENT**

Alignment of divided lite muntin bars from one product to the next is often required by fine architectural design. Wood grilles, GBG (Grilles between the Glass), and Simulated Divided Lites may be specified with muntin bars aligned.

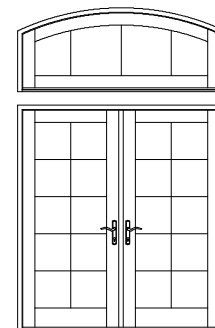
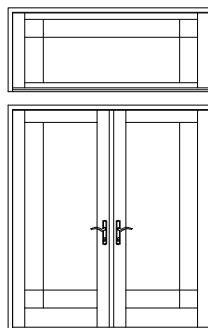

**UNIT SIZING, ROUGH OPENINGS  
& MASONRY OPENINGS**

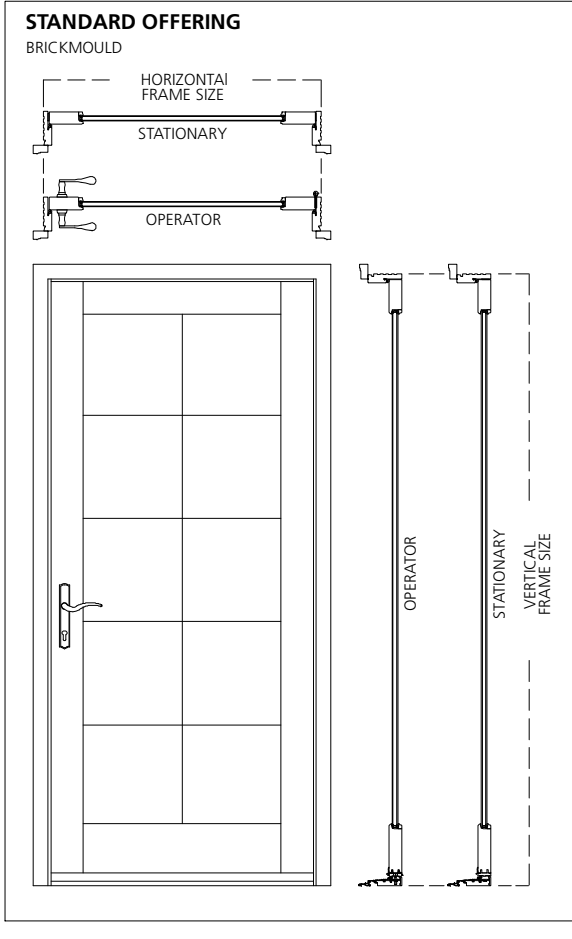

**GENERAL NOTES:**

UNITS WITH NO EXTERIOR TRIM  
FRAME SIZE = UNIT SIZE

UNIT SIZE IS ALWAYS THE  
EXTREME SIZE OF THE DOOR  
WITH OR WITHOUT TRIM

ROUGH OPENING IS ALWAYS 3/4" OVER  
FRAME SIZE OF THE DOOR

MASONRY OPENING IS ALWAYS 1/2"  
OVER THE UNIT SIZE OF THE DOOR

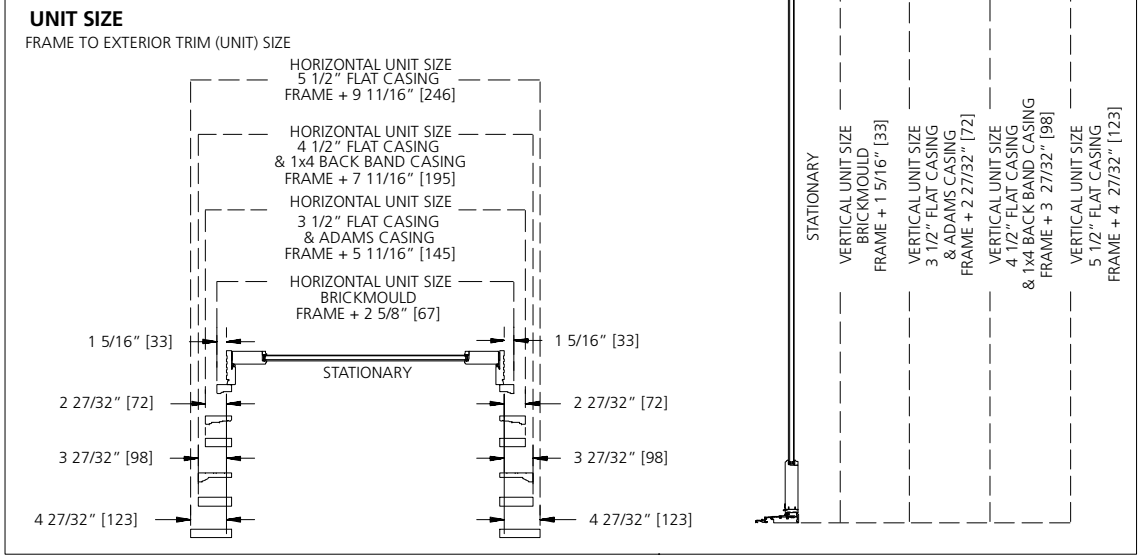
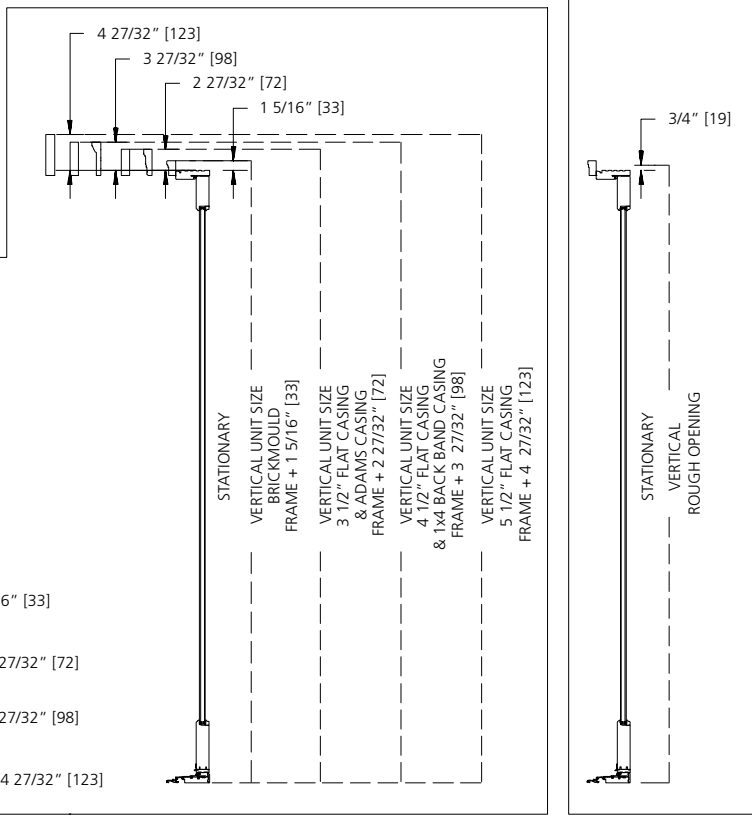
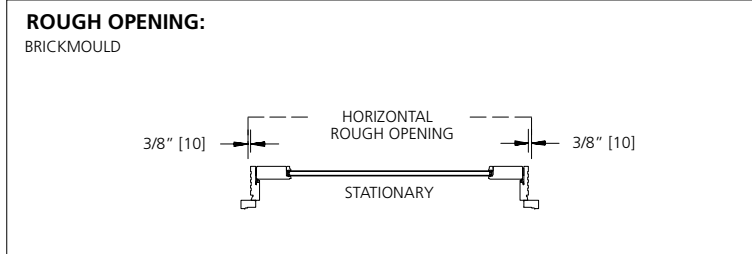

VERTICAL SECTION  
1-PANEL OPERATING UNIT

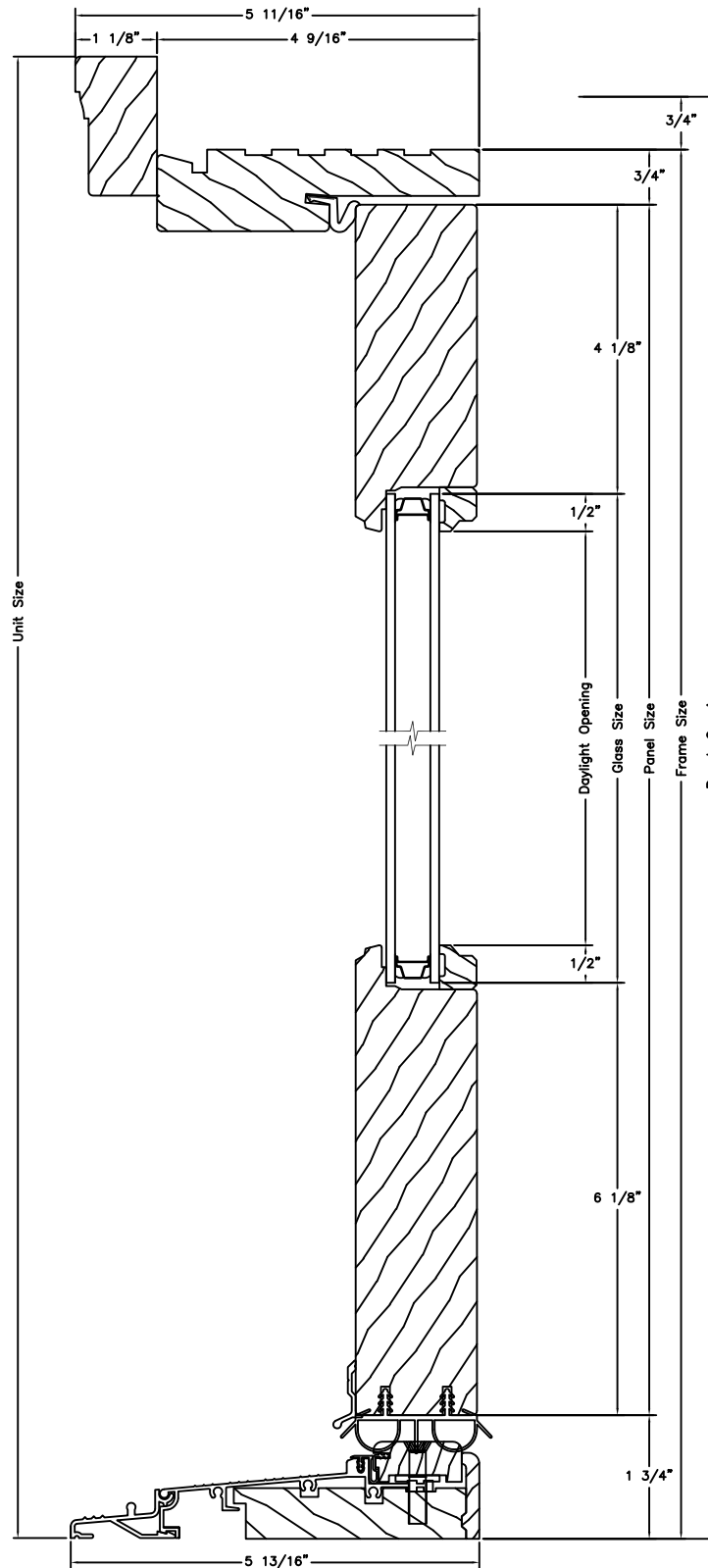

HORIZONTAL SECTION  
1-PANEL OPERATING UNIT

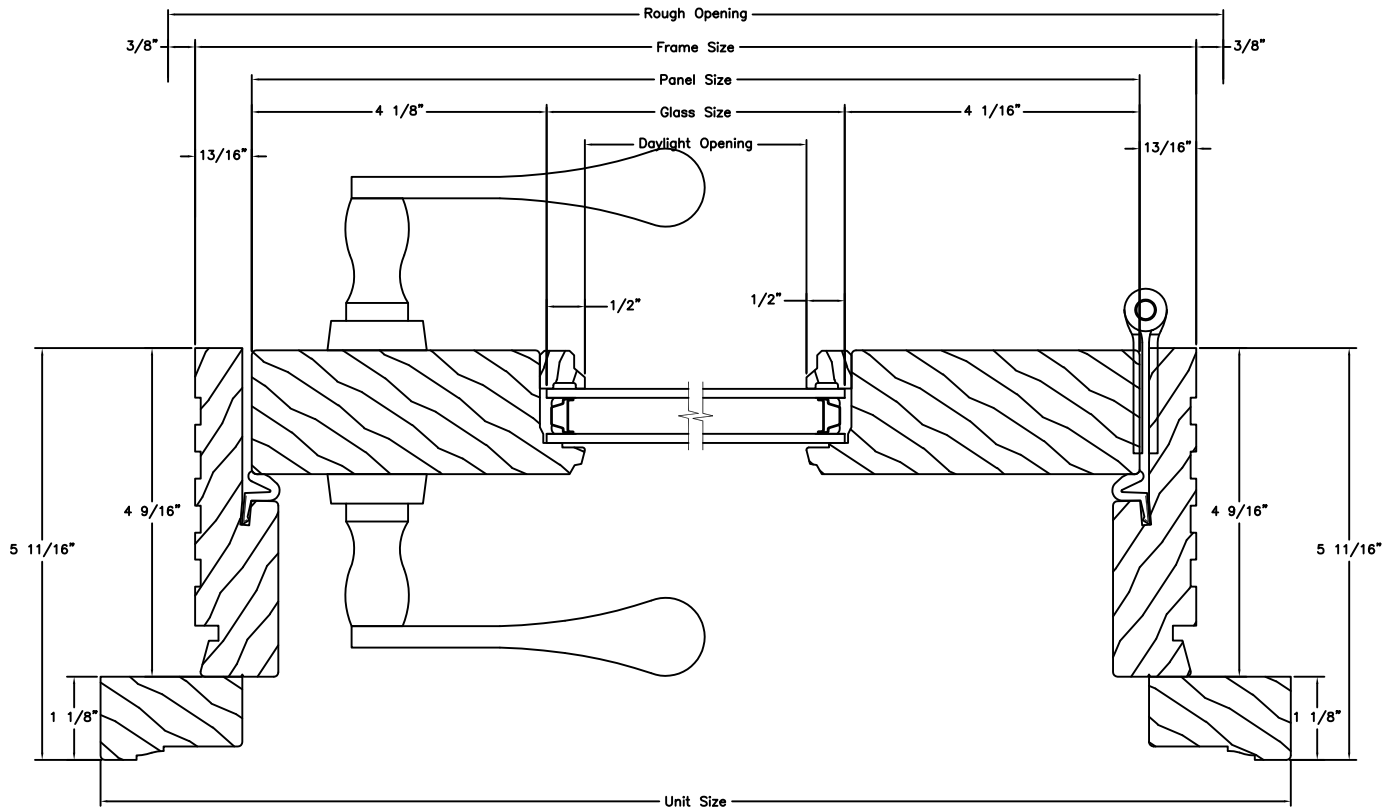

HORIZONTAL SECTION  
2-PANEL UNIT

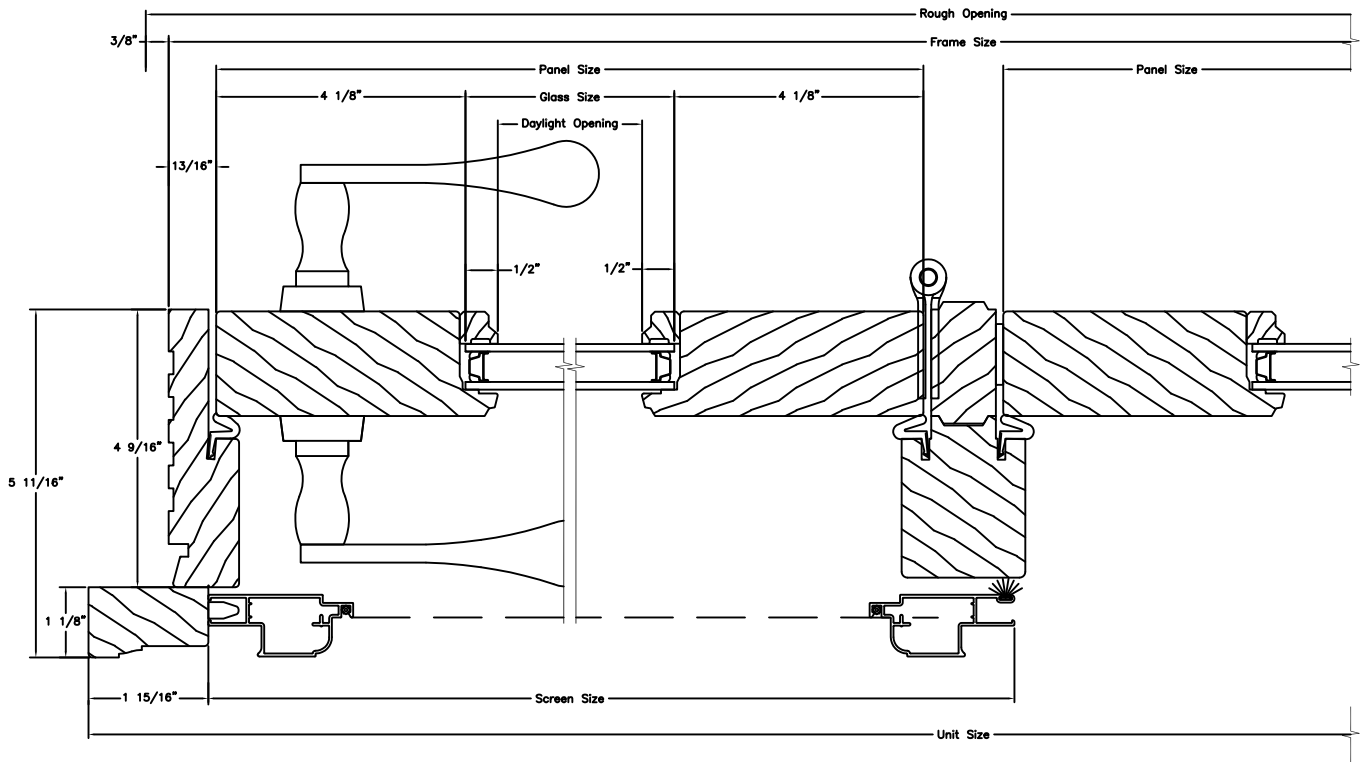

HORIZONTAL SECTION  
1-PANEL UNIT w/SIDELITE(S)

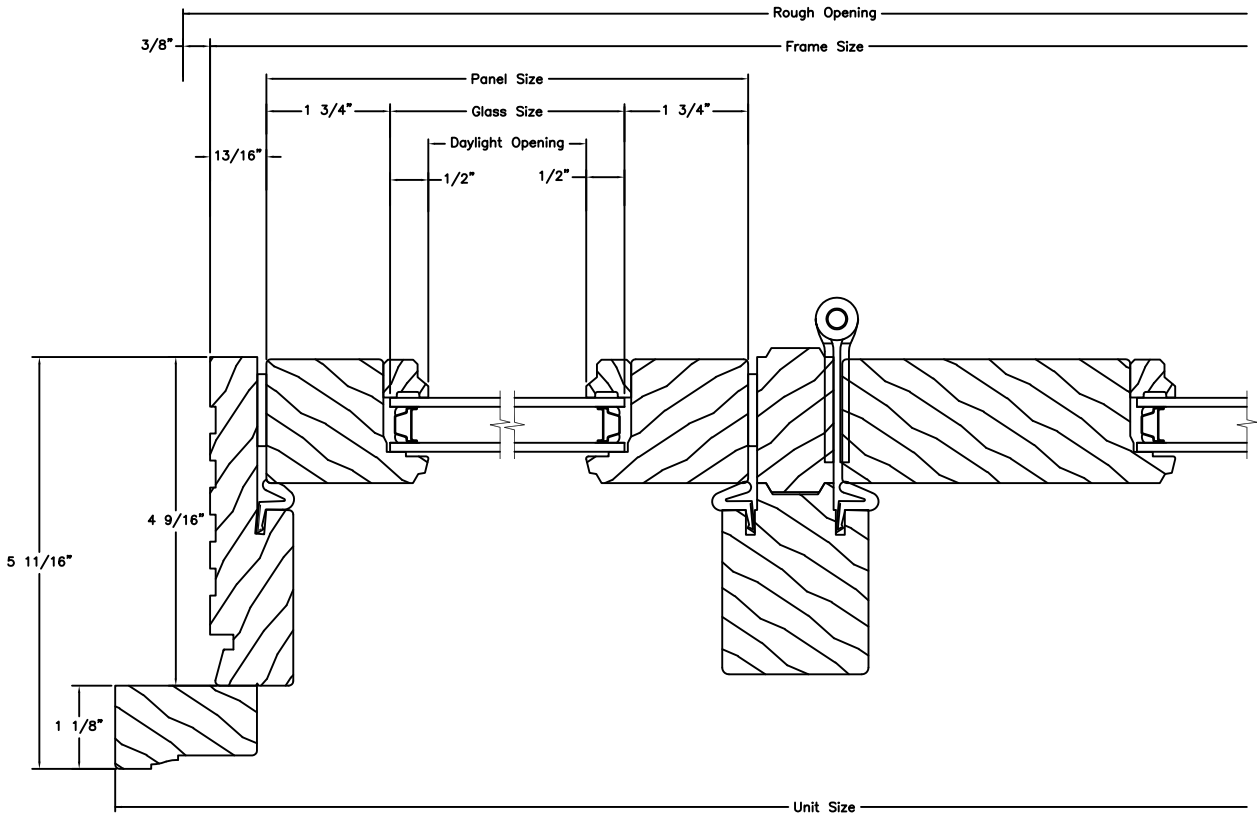



HORIZONTAL SECTION  
FRENCH DOOR UNIT W/ STATIONARY SIDELITE(S)

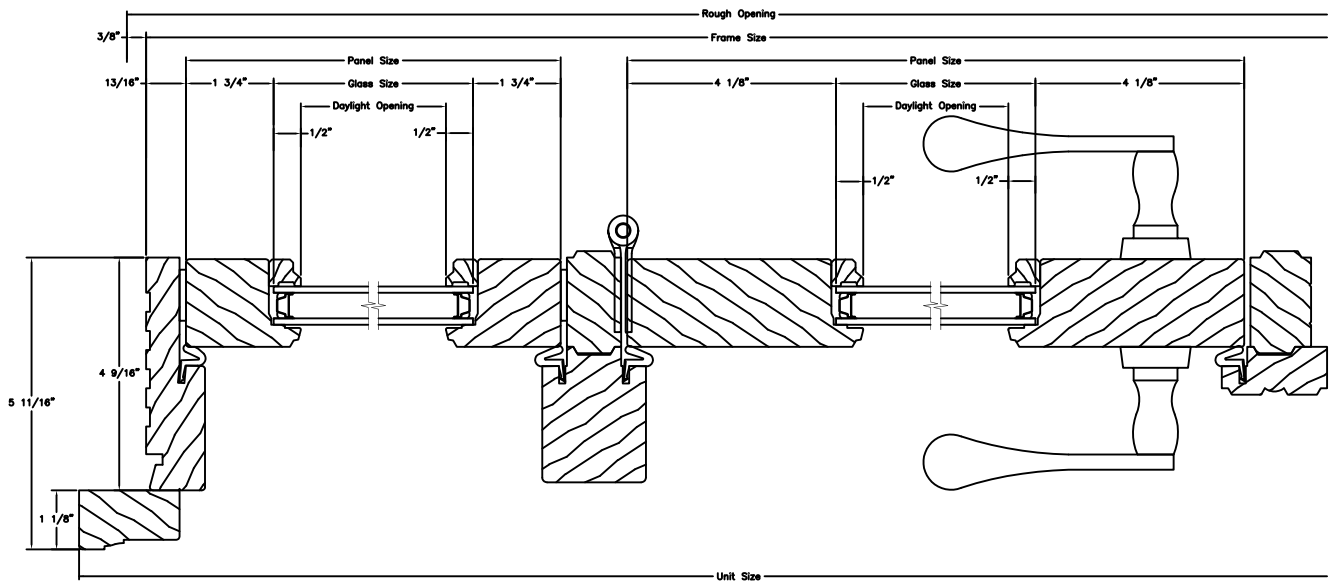

HORIZONTAL SECTION  
FRENCH DOOR UNIT

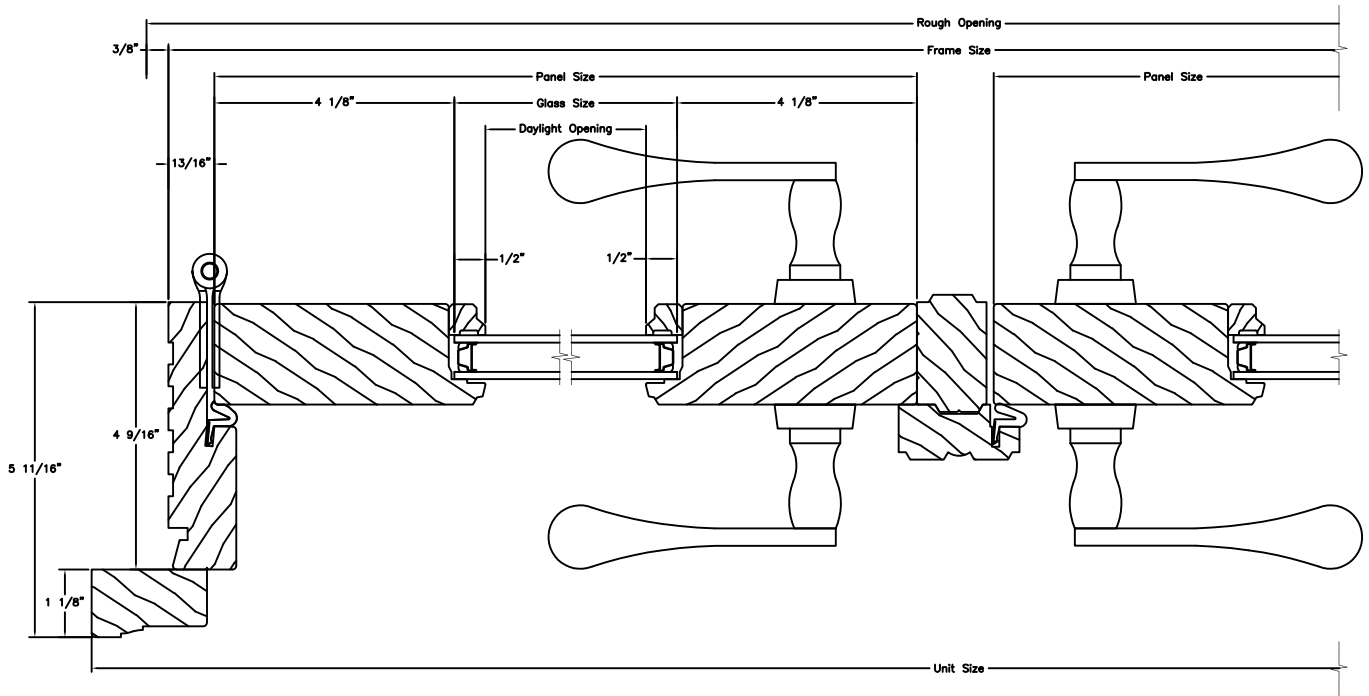

VERTICAL SECTION  
STATIONARY UNIT

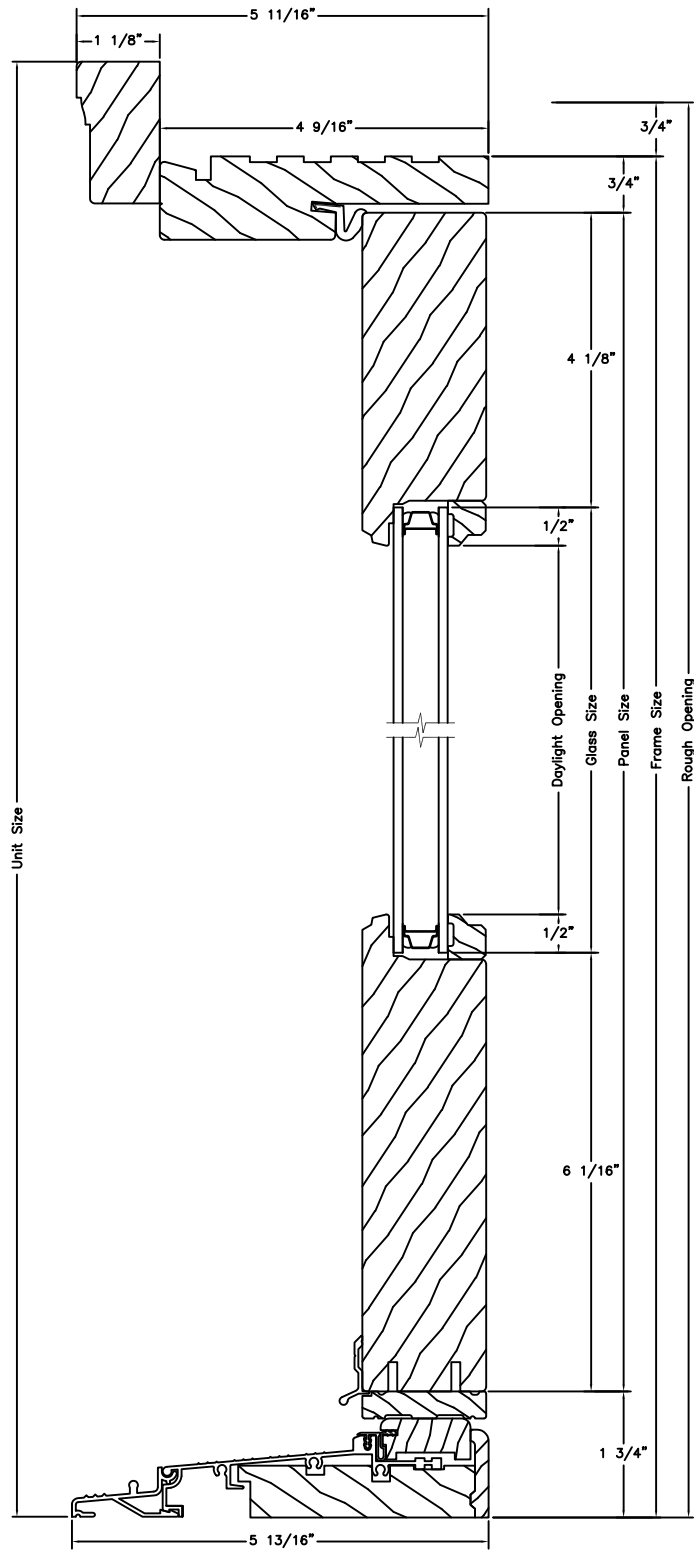

HORIZONTAL SECTION  
STATIONARY UNIT

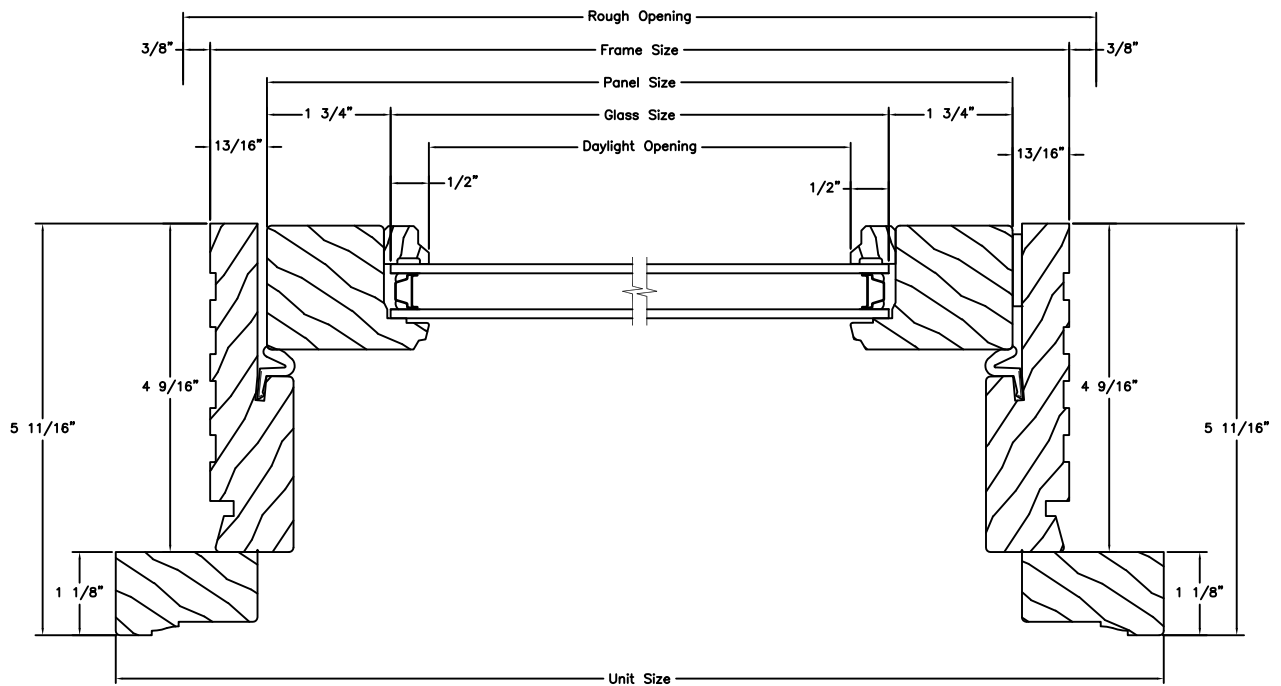

VERTICAL SECTION  
TRANSOM - 4 9/16" JAMB

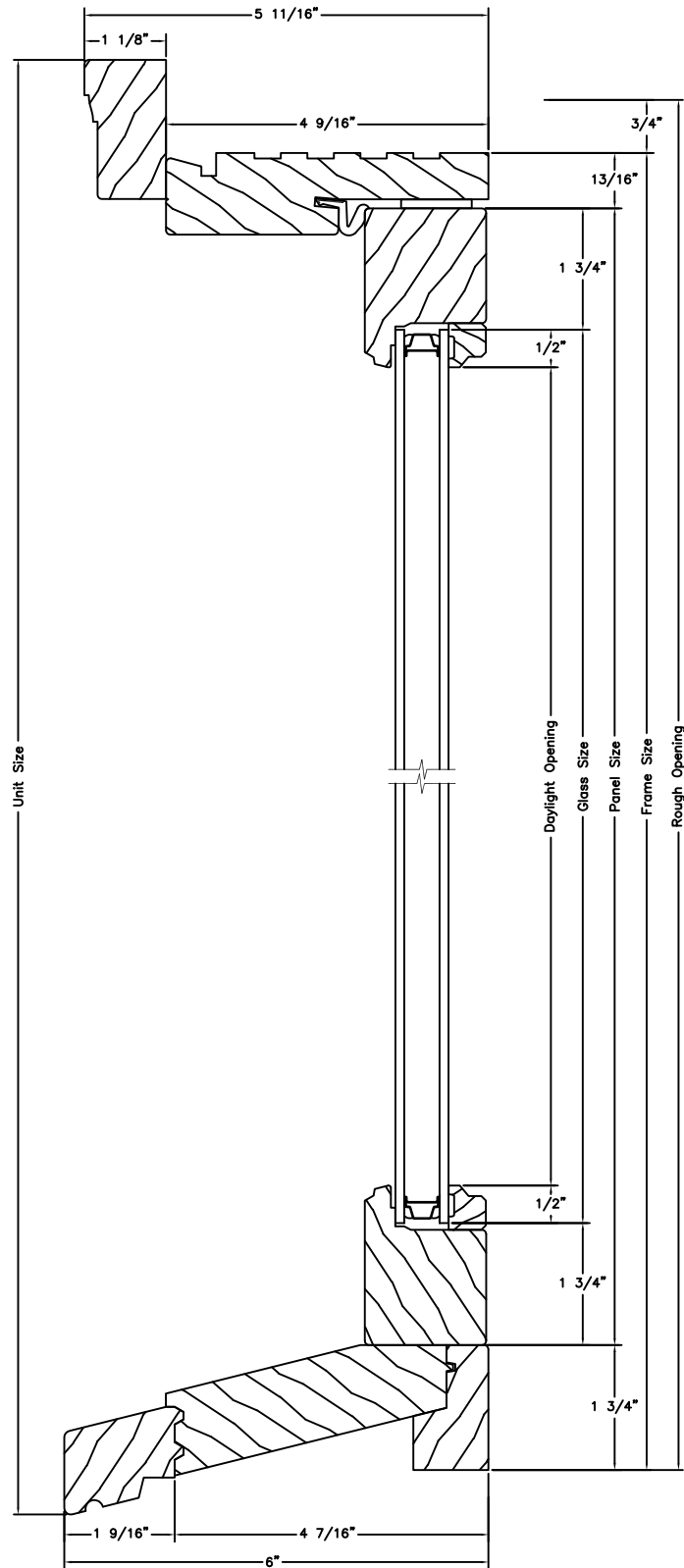

VERTICAL SECTION  
TRANSOM - 6 9/16" JAMB

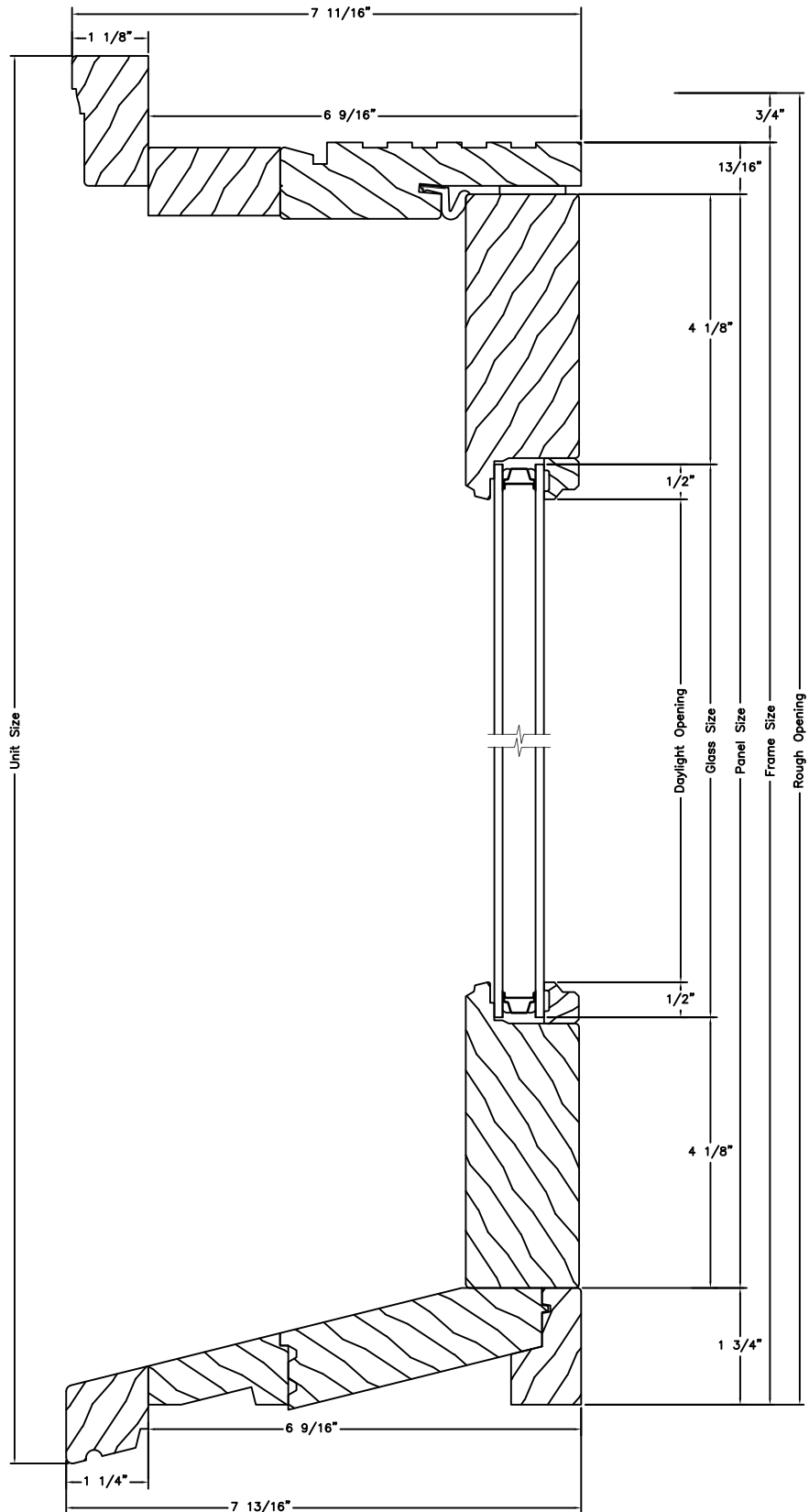

HORIZONTAL SECTION  
1-SASH TRANSOM UNIT

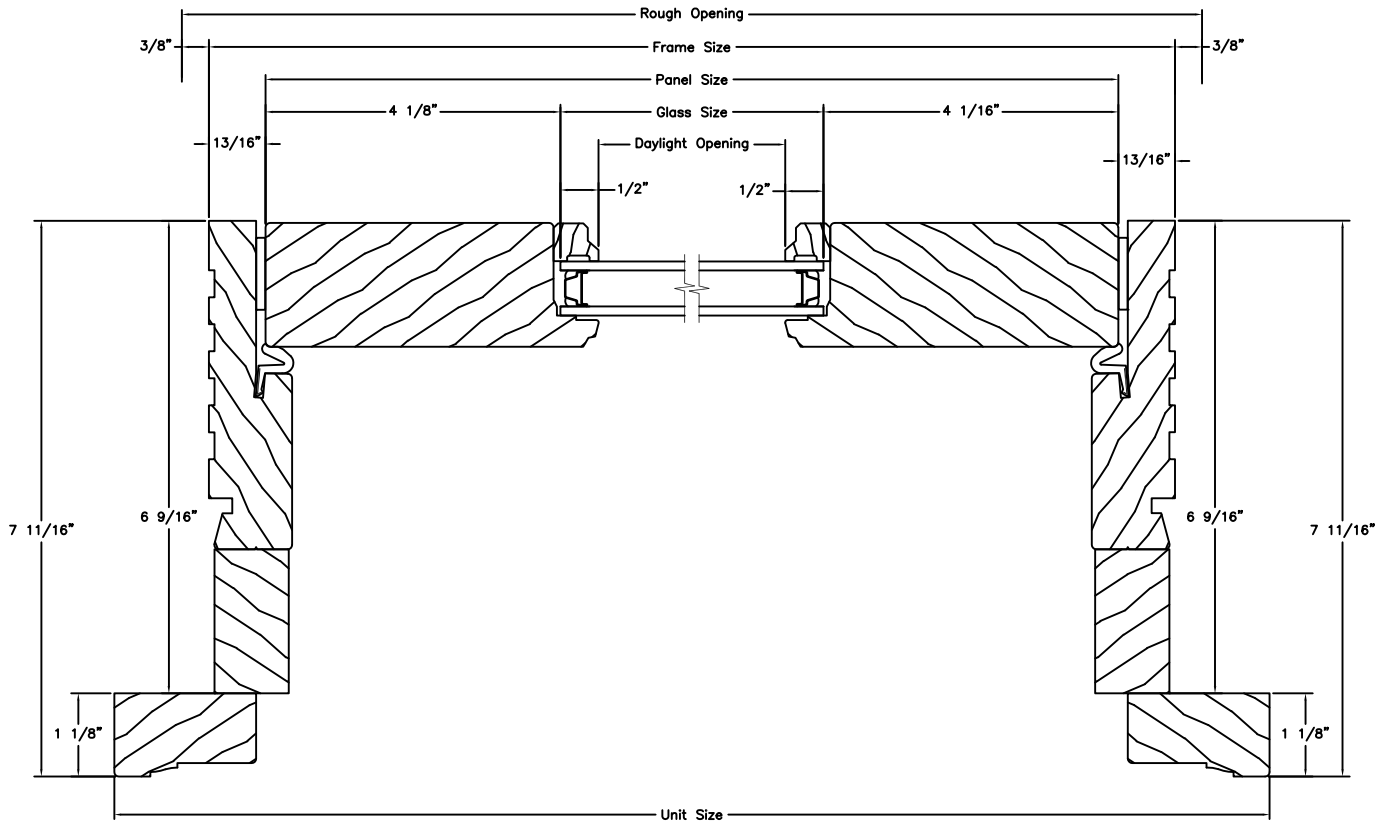

HORIZONTAL SECTION  
MULTI-SASH TRANSOM UNIT

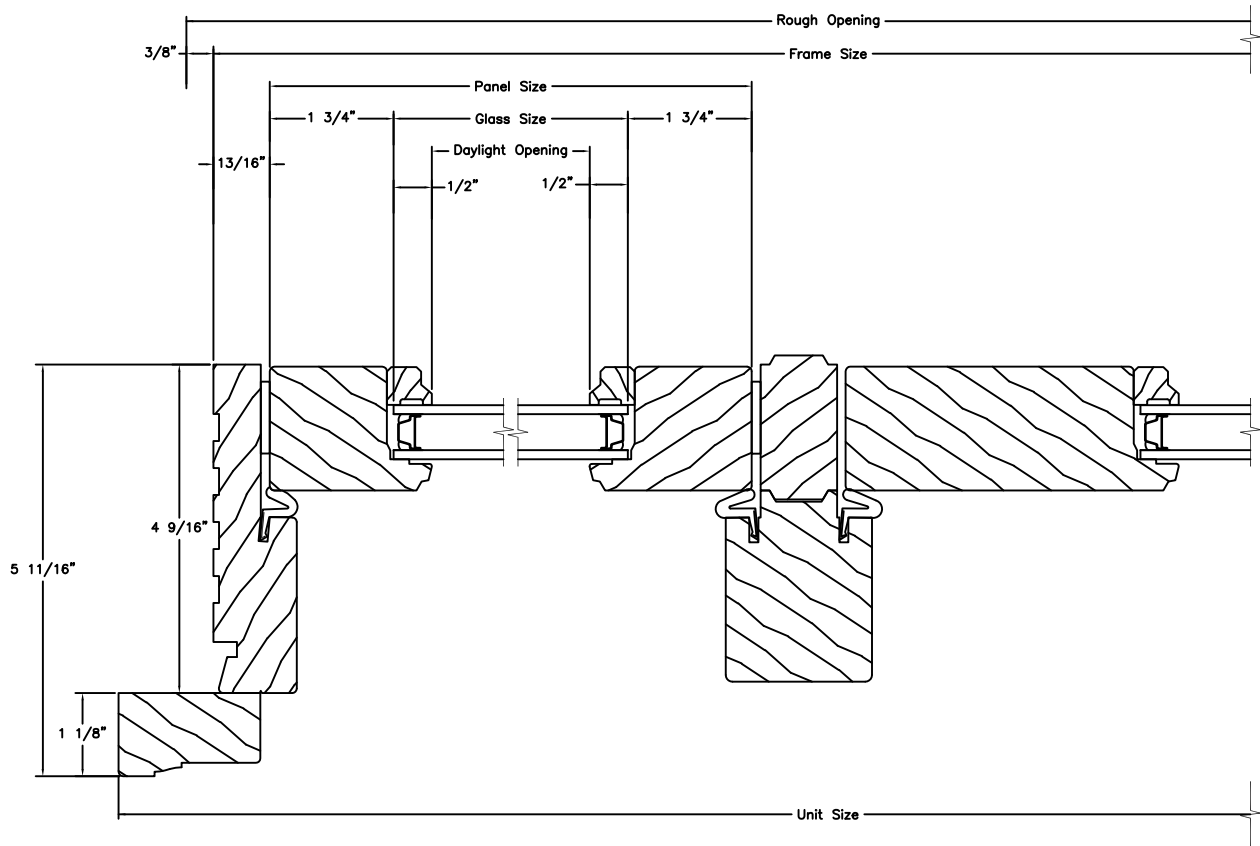



HORIZONTAL SECTION  
1 PANEL STRUCTURAL OPERATING UNIT  
W/ WIDE STILE VENTING SIDELITE

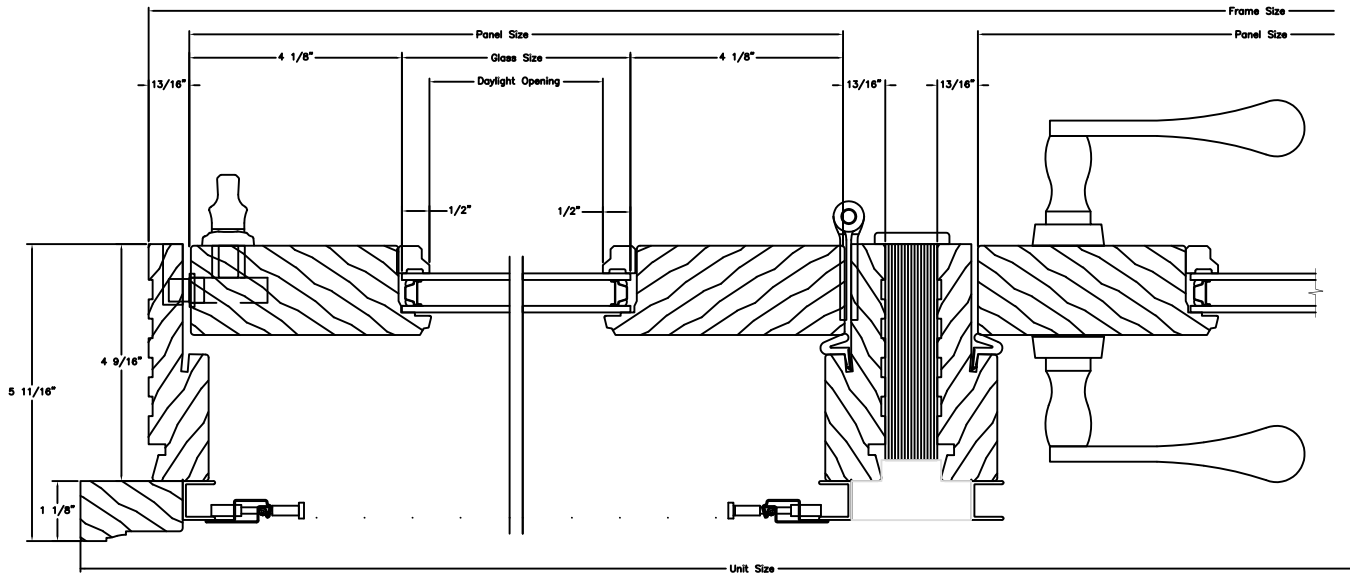

**HORIZONTAL SECTION**  
**FRENCH STRUCTURAL OPERATING UNIT**  
**W/ WIDE STILE VENTING SIDELITE**

