

TABLE OF CONTENTS

FULL VIEW

Elevations: 1/8" Scale

W10H	252	500	515	1101 Sidelight
W13V	260	508	750	
W17H	264	509	802	
W21M	266	510	880	
W24M	268	513	5037	

Decorative Hardware

Exterior Casing Options

Exterior/Interior Corner Block Options

Decorative Glass Options

Decorative Grilles - 5037 & 1101 Sidelight

Section Details

W10H	252	500	515	1101 Sidelight
W13V	260	508	750	
W17H	264	509	880	
W21M	266	510	5037	
W24M	268	513		

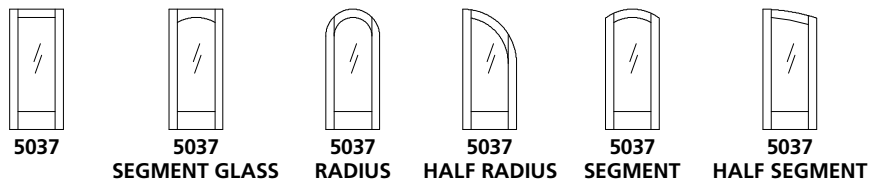
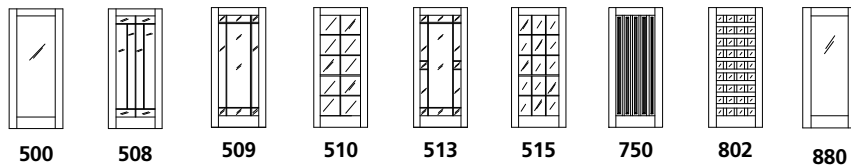
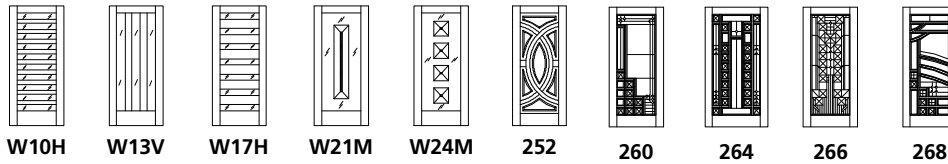

ELEVATION NOTES

Door Size = Book Size Before Prefit
 Daylight Opening (DLO) = Visible Glass
 Values in brackets [] are millimeter conversions.

DOOR CROSS-SECTION

Door Size	30" [762]	32" [813]	36" [914]	42" [1067]
Daylight Opening	18 3/4" [476]	20 3/4" [527]	24 3/4" [629]	30 3/4" [781]

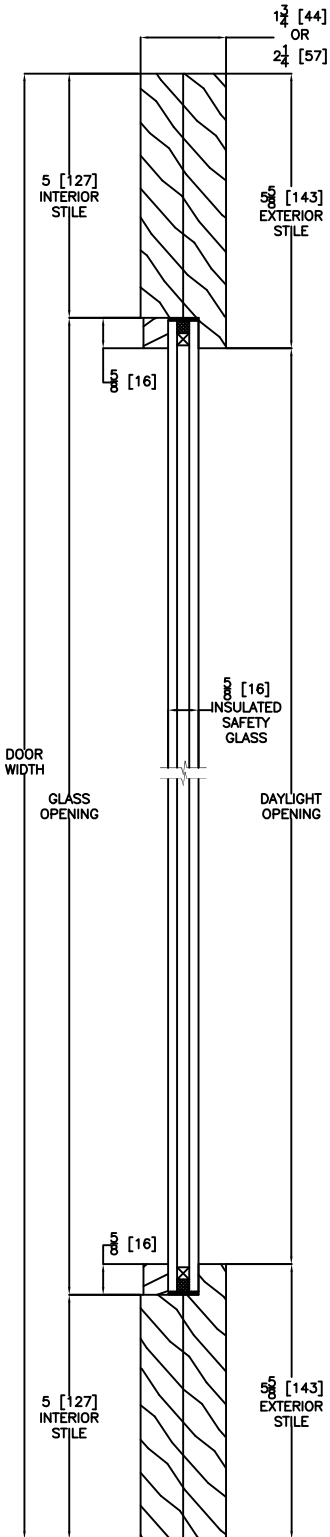
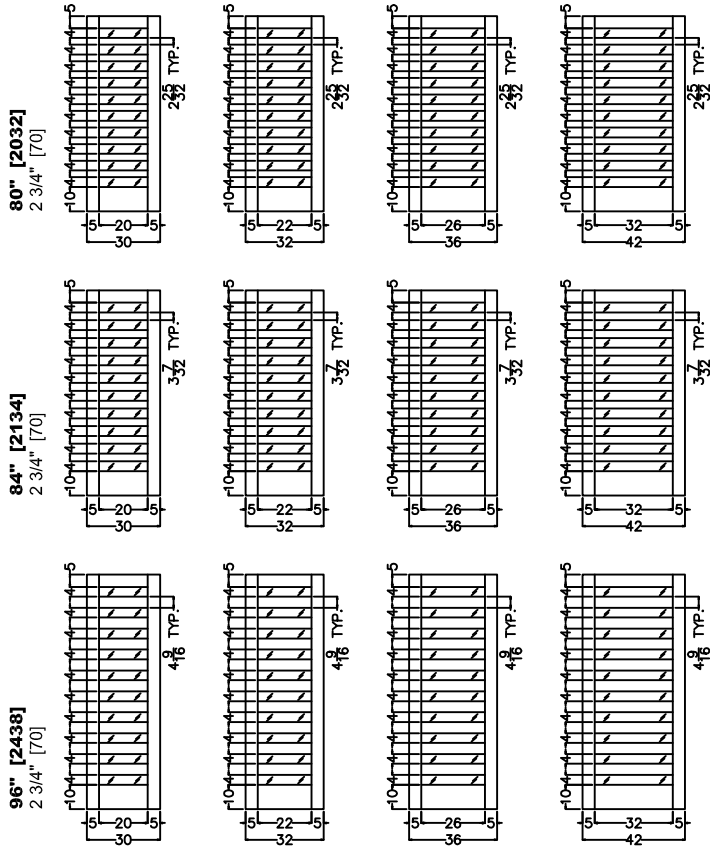

HORIZONTAL DOOR CROSS SECTION

ELEVATION NOTES

Door Size = Book Size Before Prefit
 Daylight Opening (DLO) = Visible Glass
 Values in brackets [] are millimeter conversions.

DOOR CROSS-SECTION

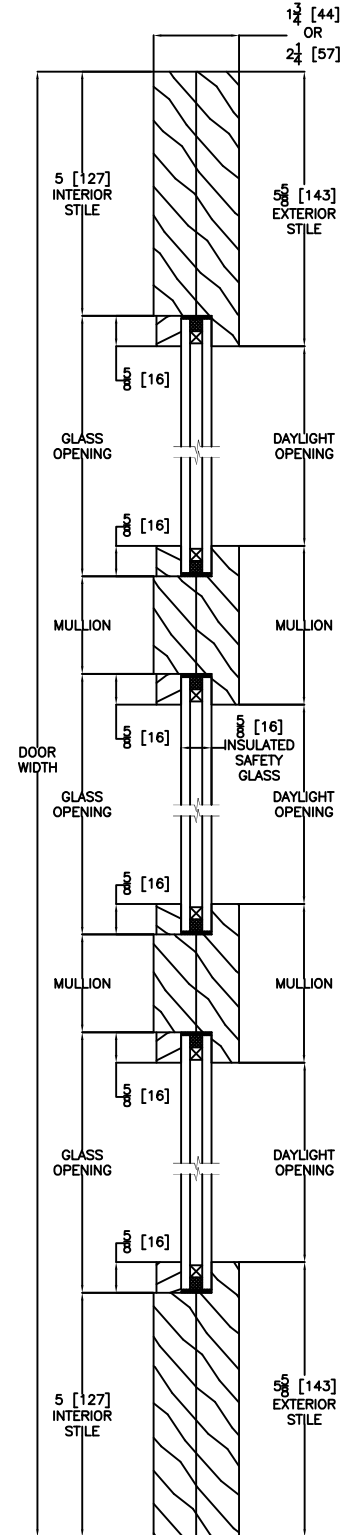
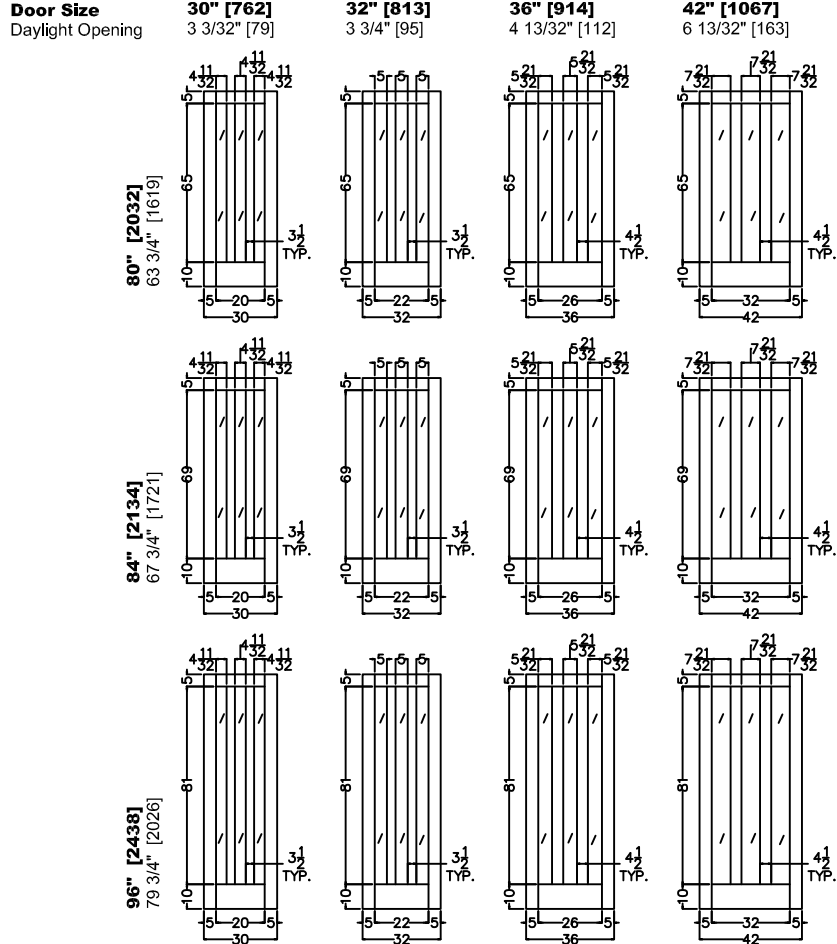

HORIZONTAL DOOR CROSS SECTION

ELEVATION NOTES

Door Size = Book Size Before Prefit
 Daylight Opening (DLO) = Visible Glass
 Values in brackets [] are millimeter conversions.

DOOR CROSS-SECTION

Door Size	30" [762]	32" [813]	36" [914]	42" [1067]
Daylight Opening	18 3/4" [476]	20 3/4" [527]	24 3/4" [629]	30 3/4" [781]

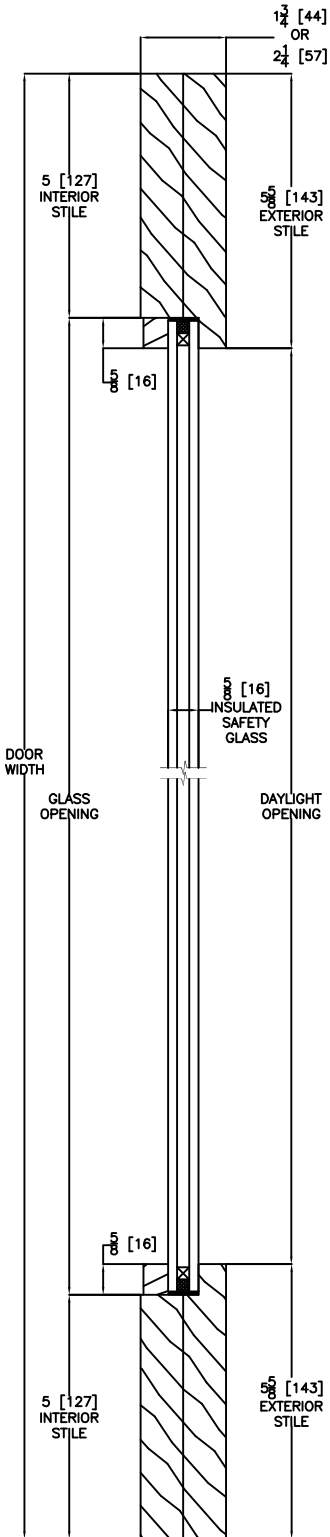
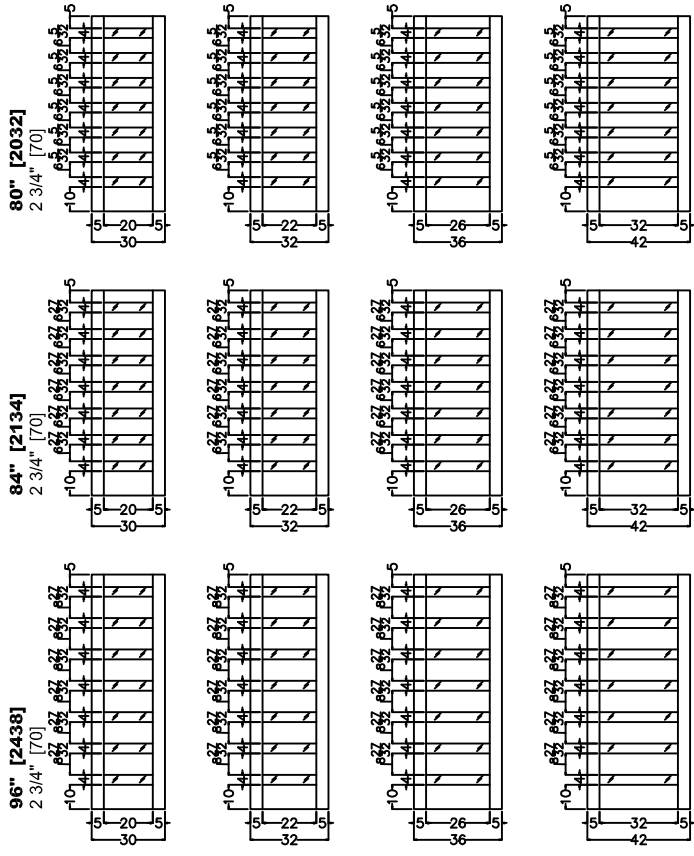

HORIZONTAL DOOR CROSS SECTION

ELEVATION NOTES

Door Size = Book Size Before Prefit
 Daylight Opening (DLO) = Visible Glass
 Values in brackets [] are millimeter conversions.

DOOR CROSS-SECTION

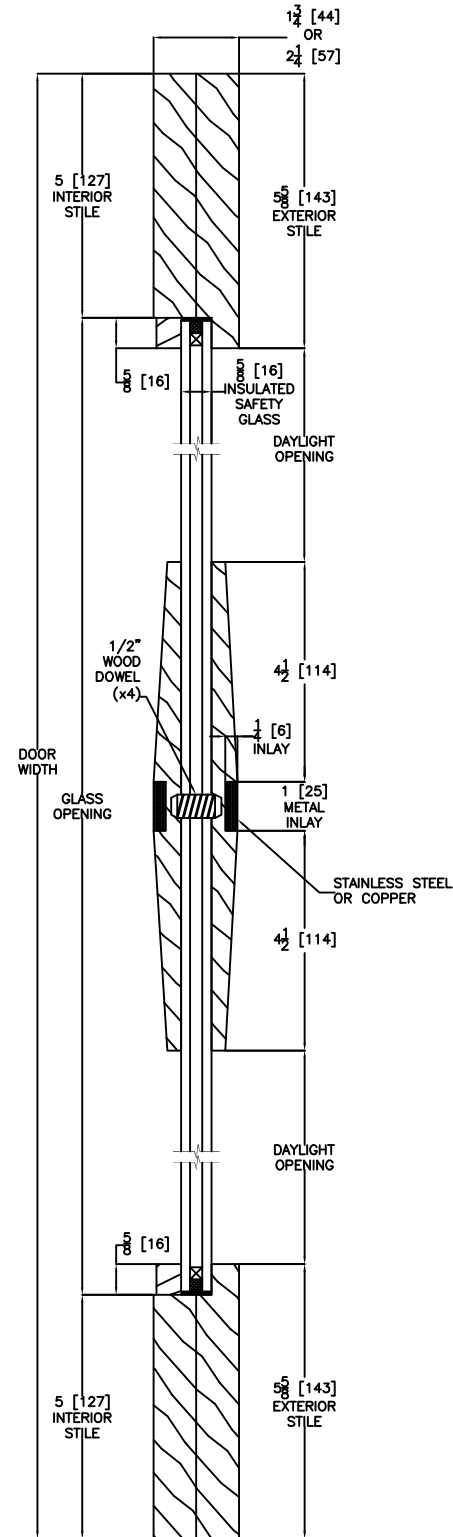

HORIZONTAL DOOR CROSS SECTION

Door Size
 Daylight Opening

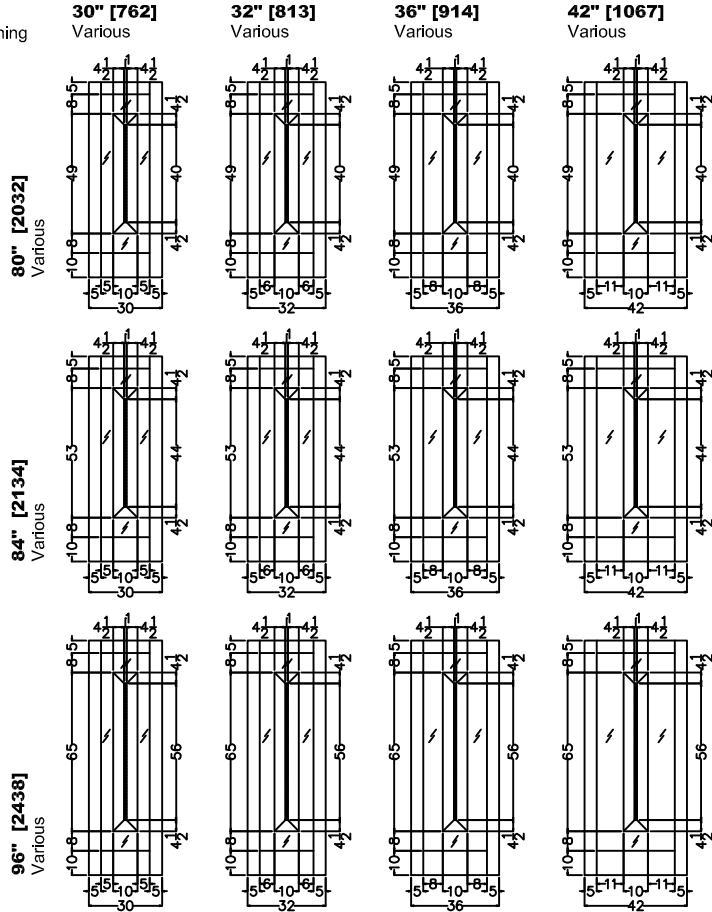

ELEVATION NOTES

Door Size = Book Size Before Prefit
 Daylight Opening (DLO) = Visible Glass
 Values in brackets [] are millimeter conversions.

DOOR CROSS-SECTION

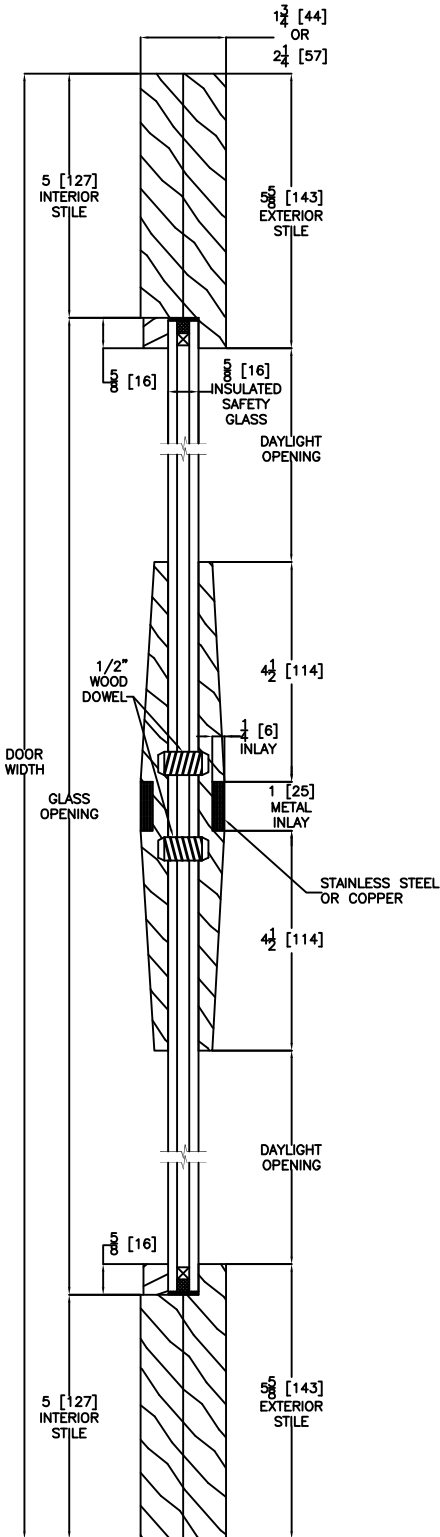
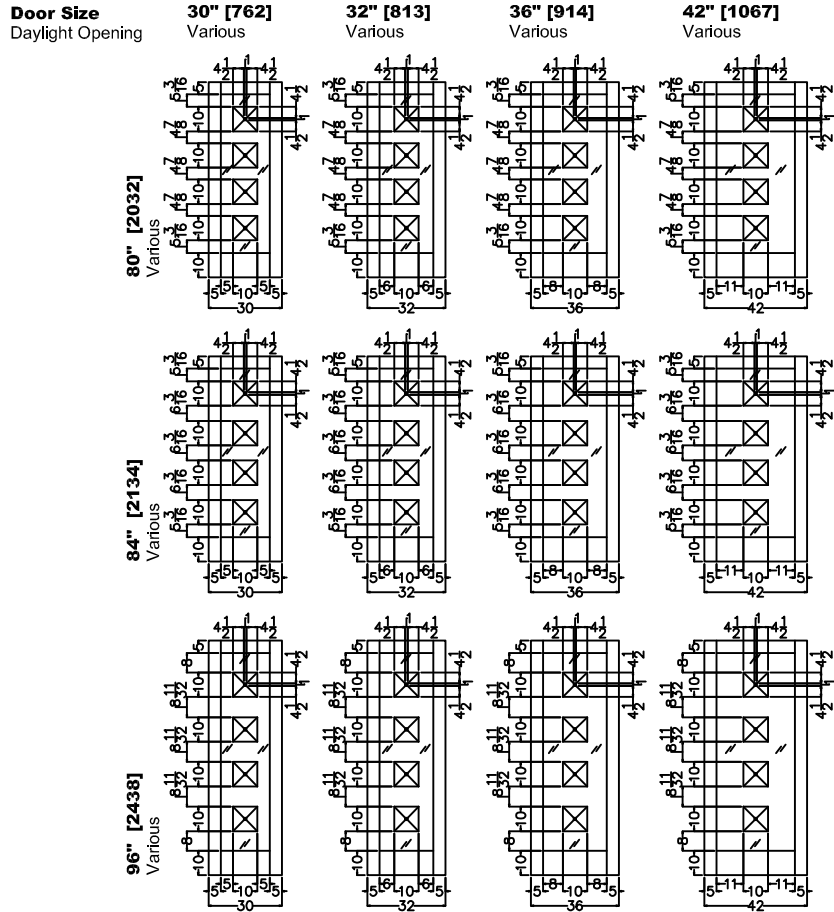

HORIZONTAL DOOR CROSS SECTION

ELEVATION NOTES

Door Size = Book Size Before Prefit
 Daylight Opening (DLO) = Visible Glass
 Values in brackets [] are millimeter conversions.

DOOR CROSS-SECTION

Moulding Profile = 112
 Panel Profile = Double Hip
 See 252 Cross Section sheet for more detail.

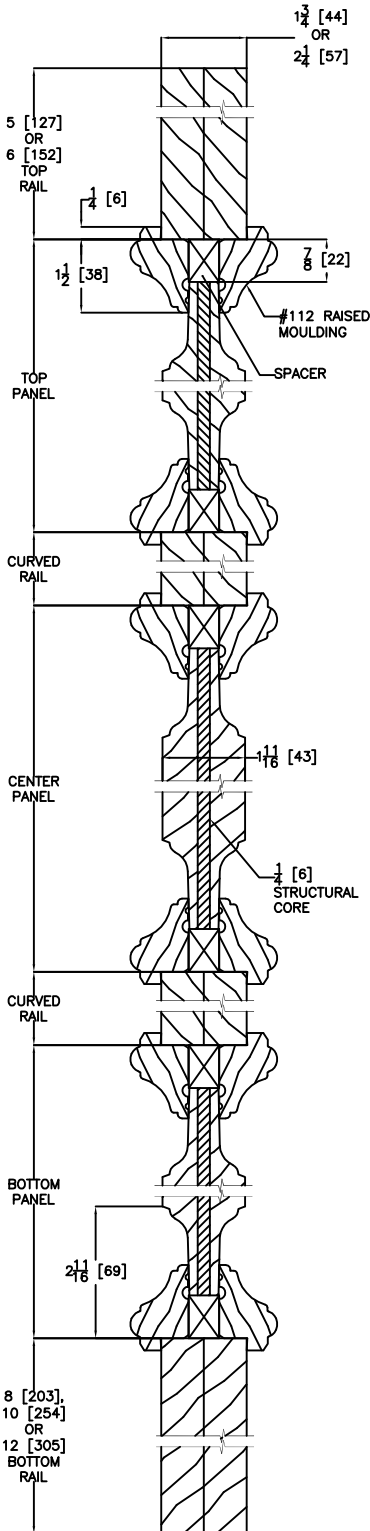

Door Size Daylight Opening	30" [762] Various	32" [813] Various	36" [914] Various	42" [1067] Various			
80" [2032] Various							
84" [2134] Various							
96" [2438] Various							
Sidelight Size Daylight Opening	12" [305] 6" [152]	13" [330] 6" [152]	14" [356] 6" [152]	15" [381] 8" [203]	16" [406] 8" [203]	17" [432] 8" [203]	18" [457] 8" [203]
80" [2032] 64" [1626]							
84" [2134] 68" [1727]							
96" [2438] 77" [1956]							

VERTICAL DOOR CROSS SECTION

ELEVATION NOTES

Door Size = Book Size Before Prefit
 Daylight Opening (DLO) = Visible Glass
 Values in brackets [] are millimeter conversions.

DOOR CROSS-SECTION

Moulding Profile = 300 Square Raised
 Panel Profile = n/a
 See 260 Cross Section sheet for more detail.

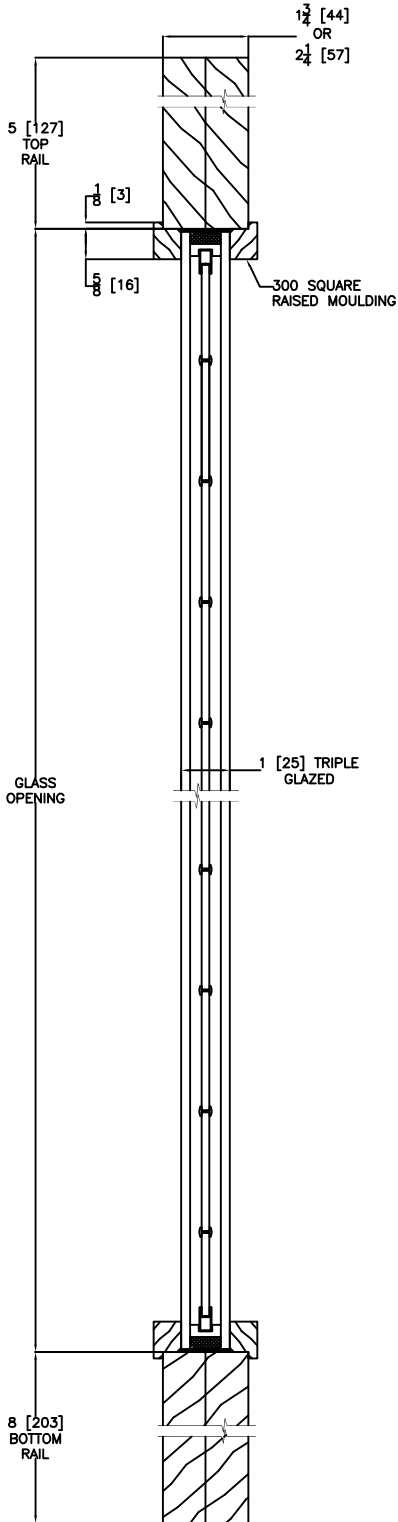

VERTICAL DOOR/SIDELIGHT CROSS SECTION
Triple Glazed

Door Size 36" [914]
 Daylight Opening Various

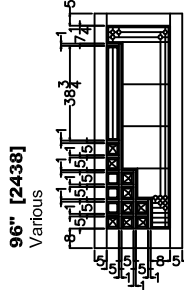
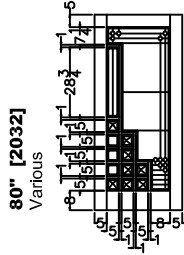

Sidelight Size 16" [406]
 Daylight Opening 10 3/4" [273]

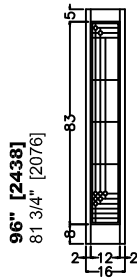
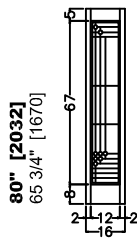

ELEVATION NOTES

Door Size = Book Size Before Prefit
 Daylight Opening (DLO) = Visible Glass
 Values in brackets [] are millimeter conversions.

DOOR CROSS-SECTION

Moulding Profile = 300 Square Raised
 Panel Profile = n/a
 See 264 Cross Section sheet for more detail.

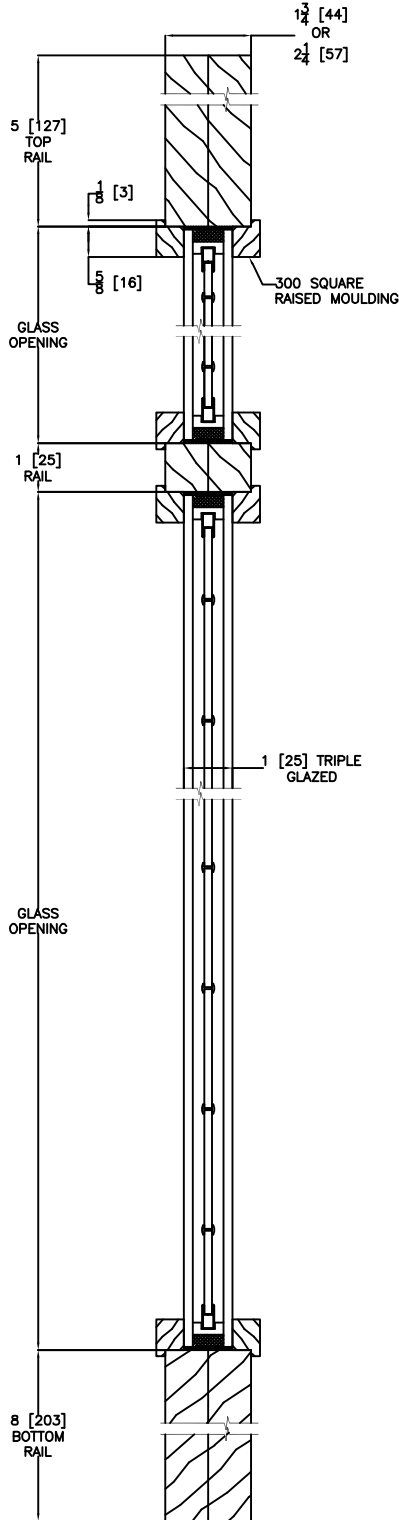

VERTICAL DOOR CROSS SECTION
Triple Glazed

Door Size 42" [1067]
 Daylight Opening Various

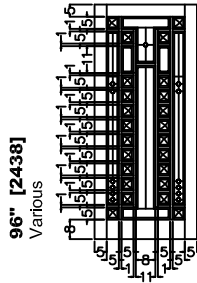
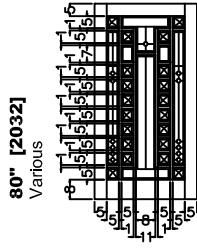

Sidelight Size 16" [406]
 Daylight Opening 10 3/4" [273]

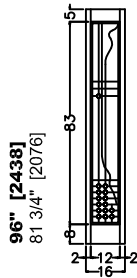
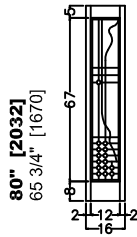

ELEVATION NOTES

Door Size = Book Size Before Prefit
 Daylight Opening (DLO) = Visible Glass
 Values in brackets [] are millimeter conversions.

DOOR CROSS-SECTION

Moulding Profile = 300 Square Raised
 Panel Profile = n/a
 See 266 Cross Section sheet for more detail.

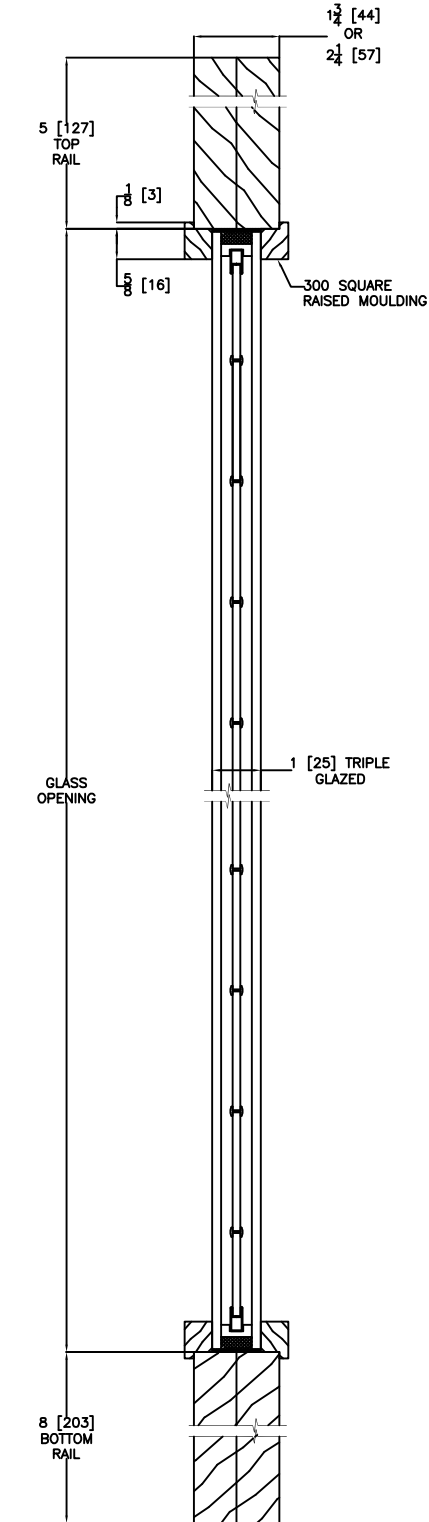

Door Size 36" [914]
 Daylight Opening 24 3/4" [629]

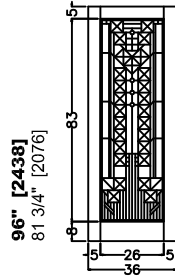
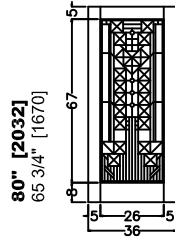

VERTICAL DOOR/SIDELIGHT CROSS SECTION
 Triple Glazed

ELEVATION NOTES

Door Size = Book Size Before Prefit
 Daylight Opening (DLO) = Visible Glass
 Values in brackets [] are millimeter conversions.

DOOR CROSS-SECTION

Moulding Profile = 300 Square Raised
 Panel Profile = n/a
 See 268 Cross Section sheet for more detail.

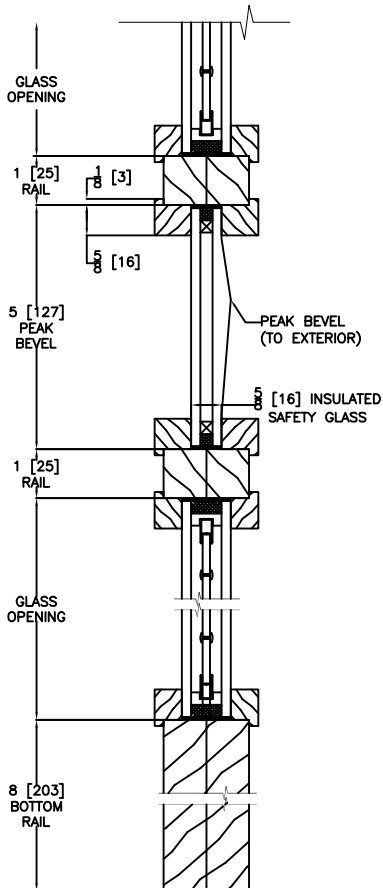
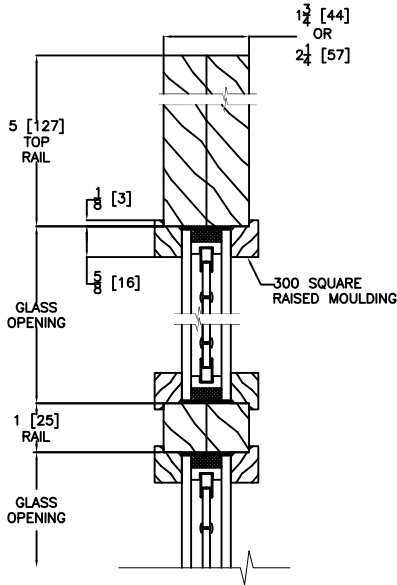

VERTICAL DOOR CROSS SECTION
 Insulated Glass/Triple Glazed

Door Size 36" [914]
 Daylight Opening Various

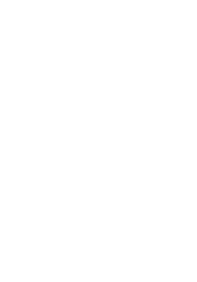
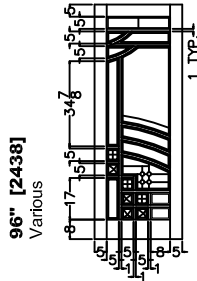
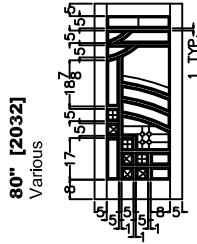

Sidelight Size 16" [406]
 Daylight Opening Various

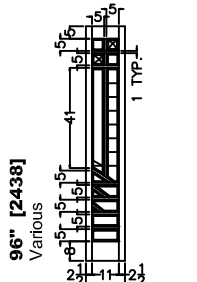
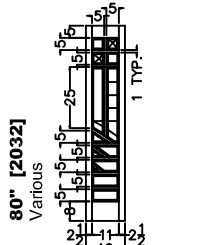

ELEVATION NOTES

Door Size = Book Size Before Prefit
 Daylight Opening (DLO) = Visible Glass
 Values in brackets [] are millimeter conversions.

DOOR CROSS-SECTION

Moulding Profile = Ovolo
 Panel Profile = n/a
 See 500 Cross Section sheet for more detail.

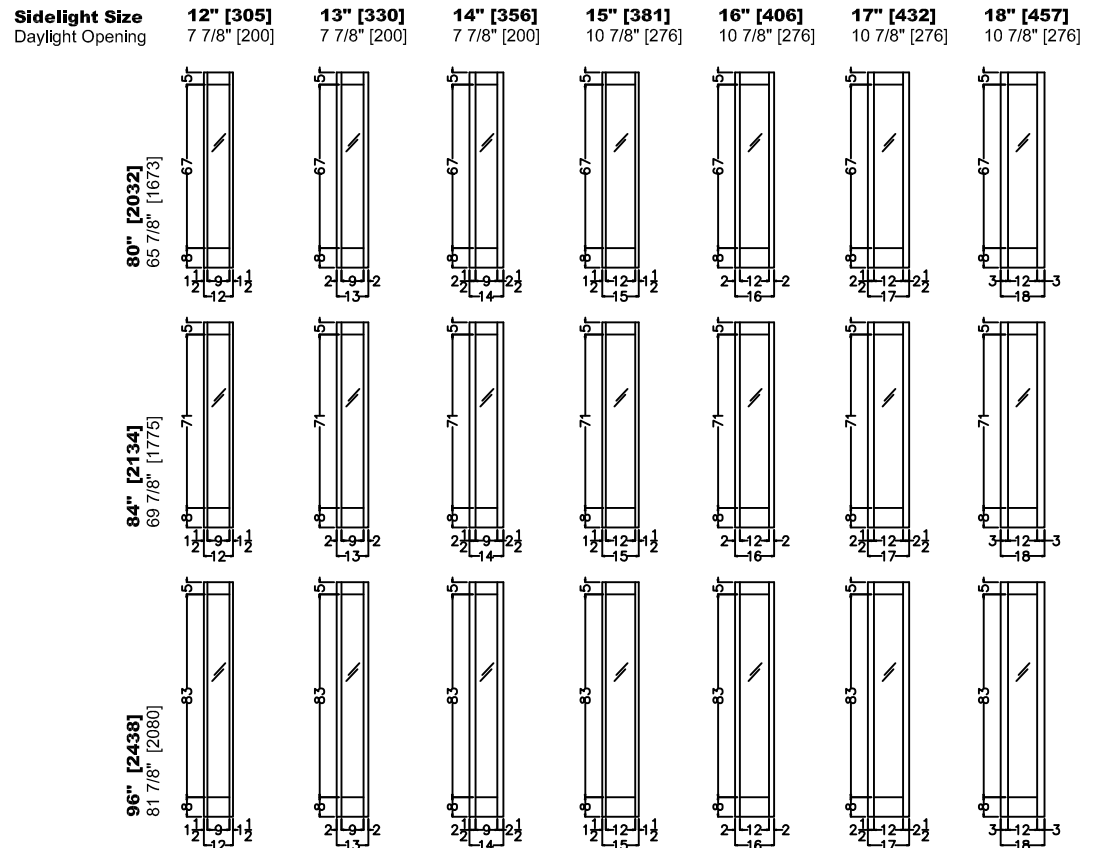
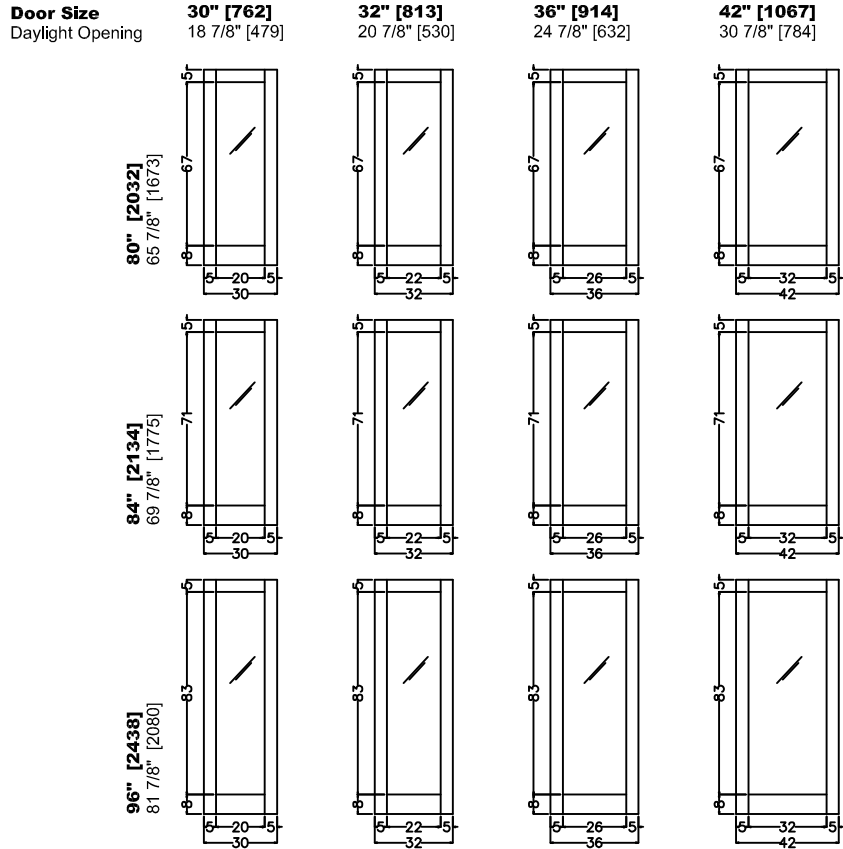
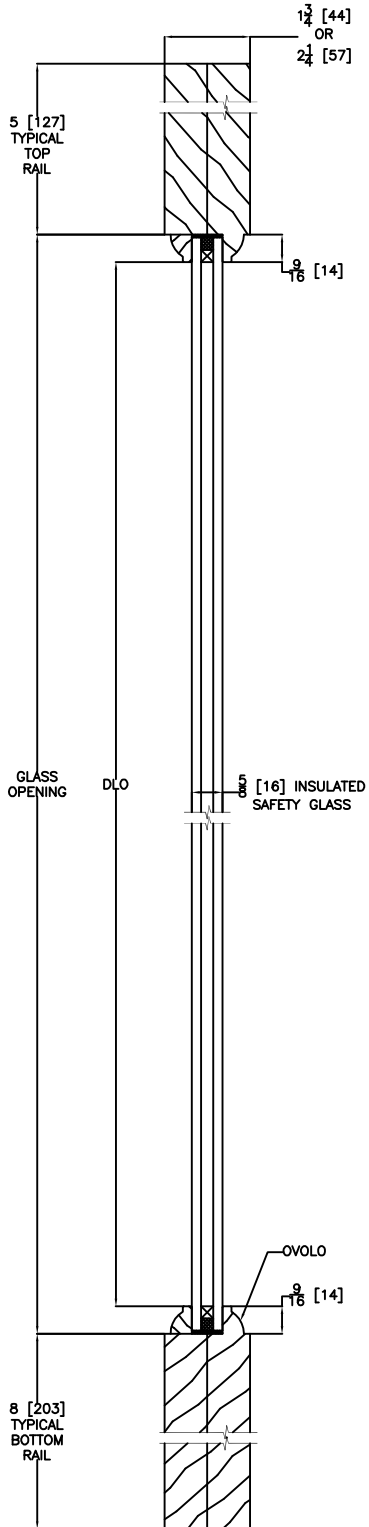

VERTICAL DOOR/SIDELIGHT CROSS SECTION
 Insulated Glass

ELEVATION NOTES

Door Size = Book Size Before Prefit
 Daylight Opening (DLO) = Visible Glass
 Values in brackets [] are millimeter conversions.

DOOR CROSS-SECTION

Moulding Profile = Ovolo
 Panel Profile = n/a
 See 508 Cross Section sheet for more detail.

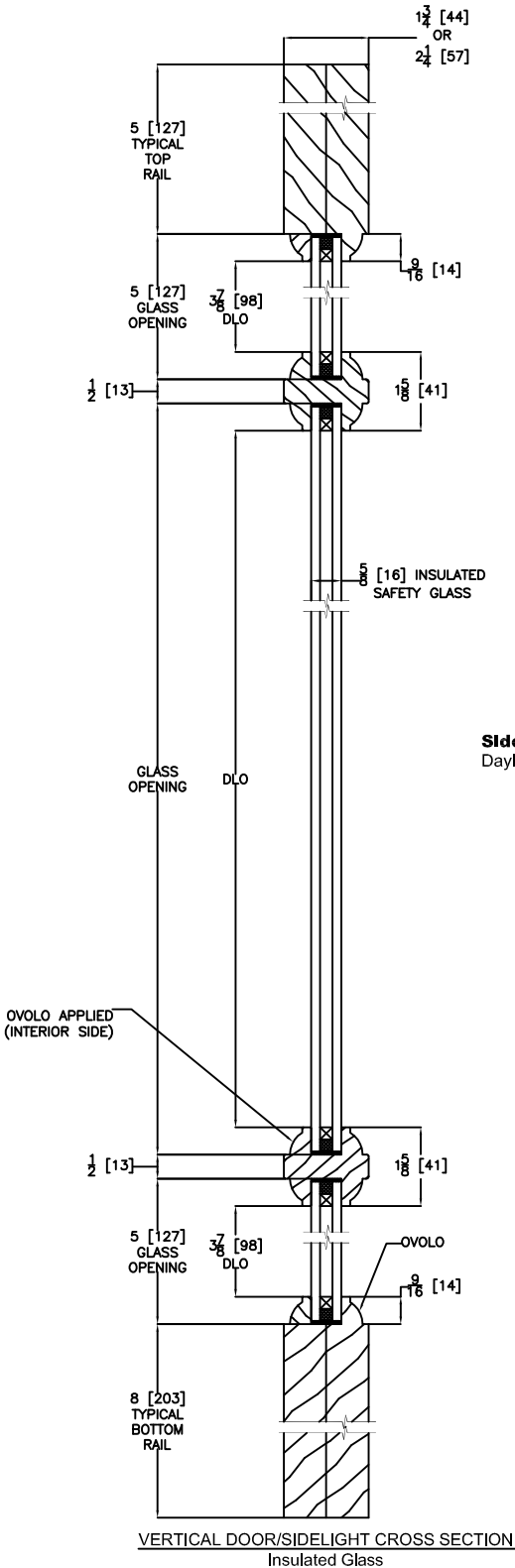

Door Size
 Daylight Opening

30" [762]
 Various

32" [813]
 Various

36" [914]
 Various

42" [1067]
 Various

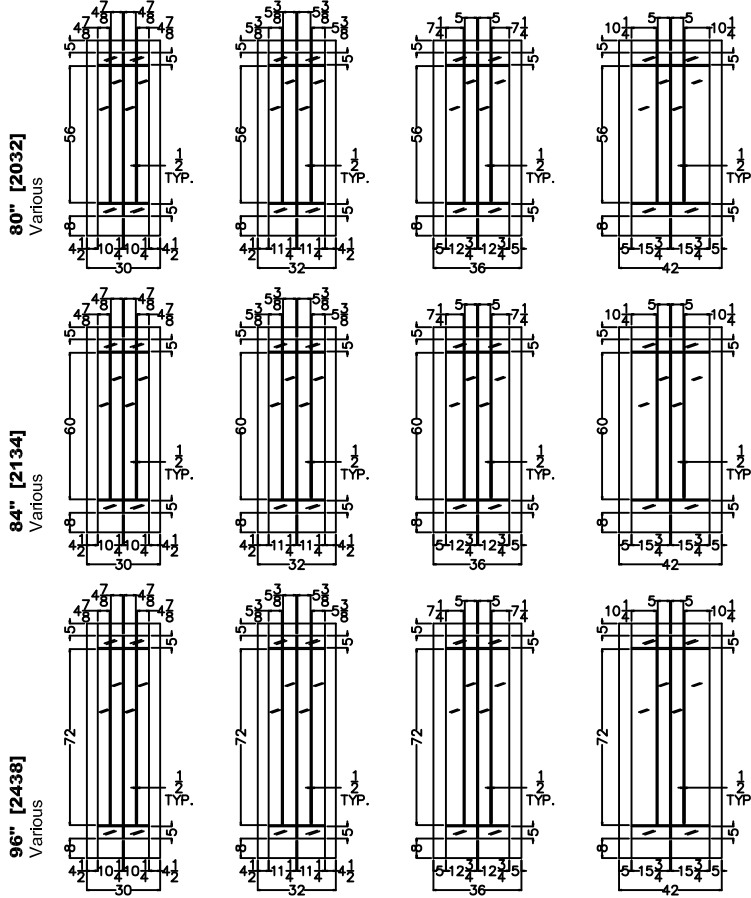

Sidelight Size
 Daylight Opening

12" [305]
 7 7/8" [200]

13" [330]
 7 7/8" [200]

14" [356]
 7 7/8" [200]

15" [381]
 10 7/8" [276]

16" [406]
 10 7/8" [276]

17" [432]
 10 7/8" [276]

18" [457]
 10 7/8" [276]

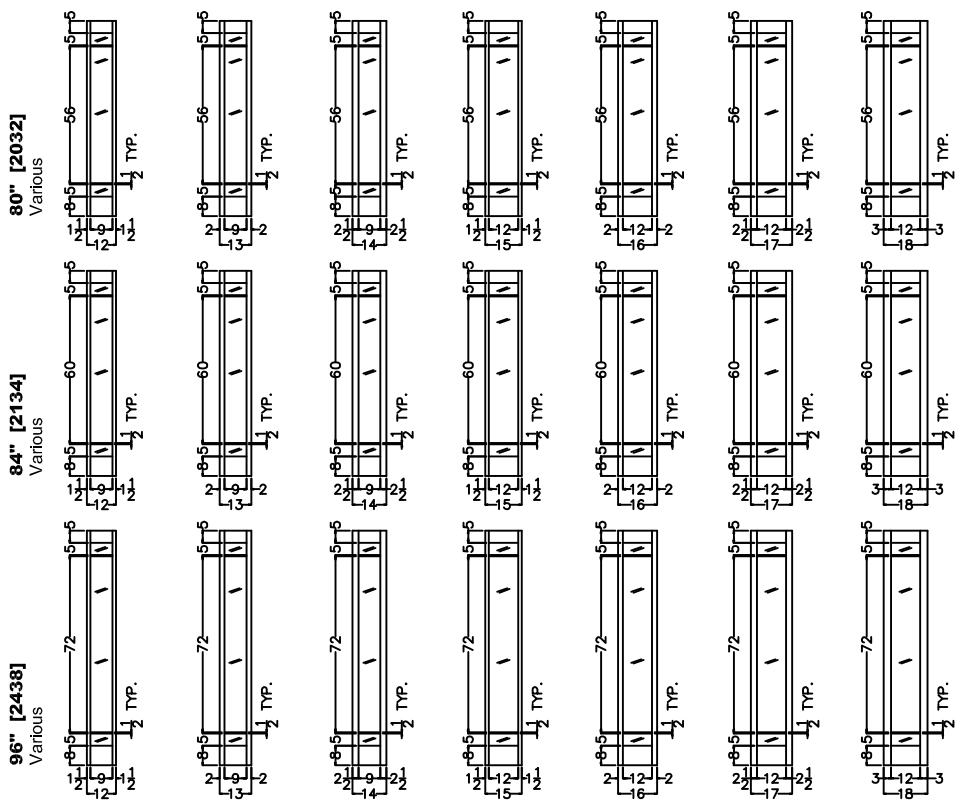

ELEVATION NOTES

Door Size = Book Size Before Prefit
 Daylight Opening (DLO) = Visible Glass
 Values in brackets [] are millimeter conversions.

DOOR CROSS-SECTION

Moulding Profile = Ovolo
 Panel Profile = n/a
 See 509 Cross Section sheet for more detail.

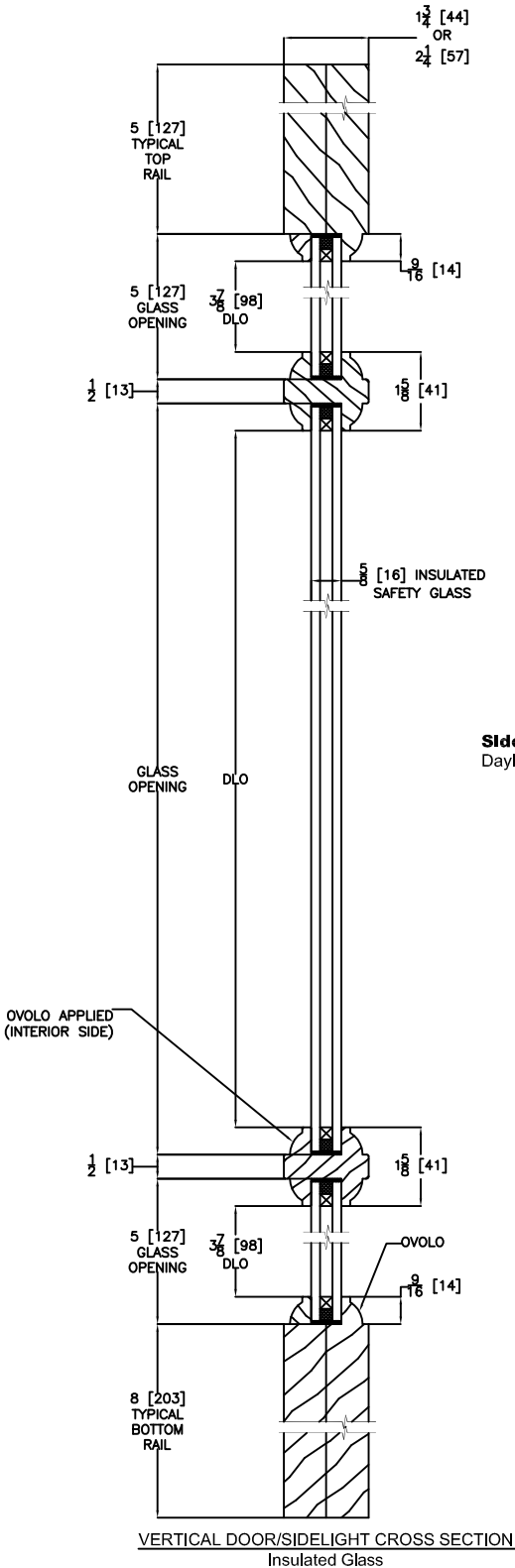

Door Size
 Daylight Opening

30" [762]
 Various

32" [813]
 Various

36" [914]
 Various

42" [1067]
 Various

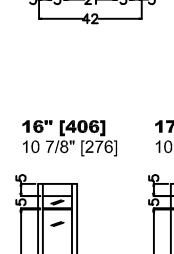
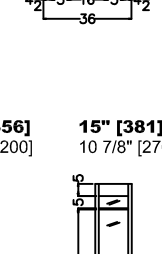
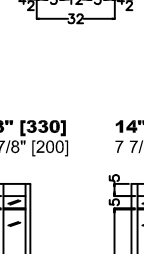
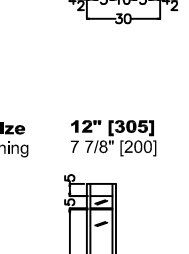
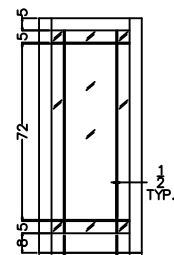
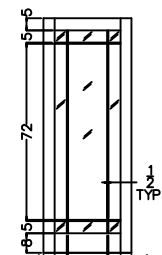
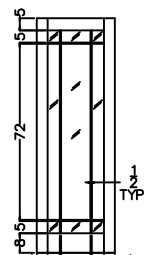
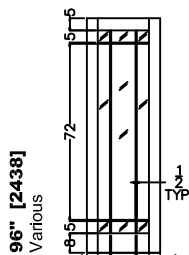
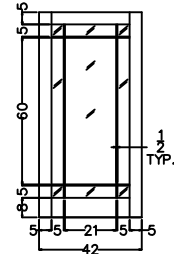
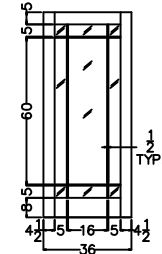
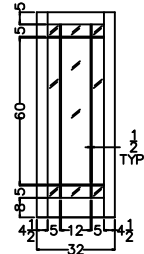
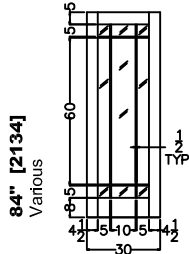
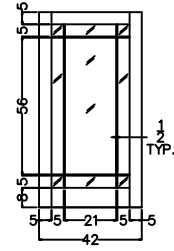
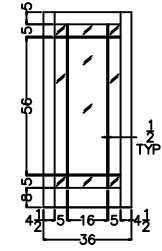
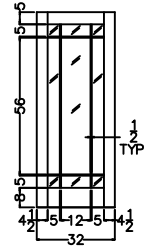
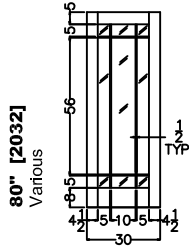

Sidelight Size
 Daylight Opening

12" [305]
 7 7/8" [200]

13" [330]
 7 7/8" [200]

14" [356]
 7 7/8" [200]

15" [381]
 10 7/8" [276]

16" [406]
 10 7/8" [276]

17" [432]
 10 7/8" [276]

18" [457]
 10 7/8" [276]

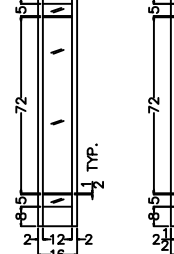
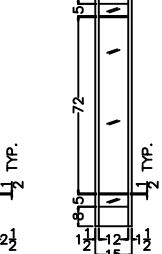
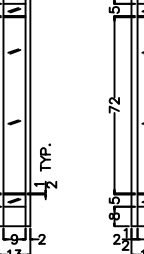
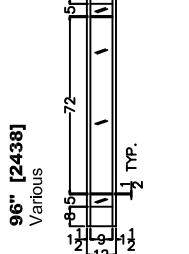
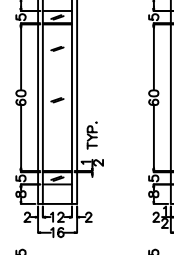
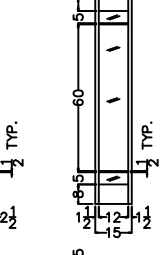
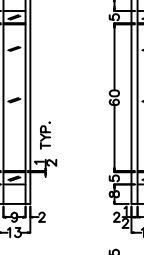
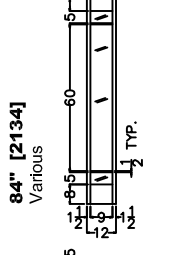
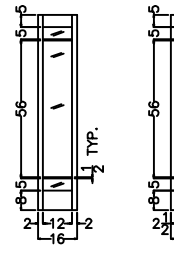
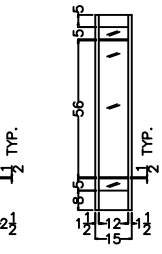
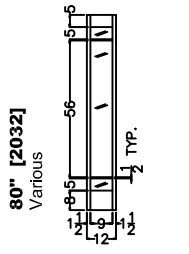

ELEVATION NOTES

Door Size = Book Size Before Prefit
 Daylight Opening (DLO) = Visible Glass
 Values in brackets [] are millimeter conversions.

DOOR CROSS-SECTION

Moulding Profile = Ovolo
 Panel Profile = n/a
 See 510 Cross Section sheet for more detail.

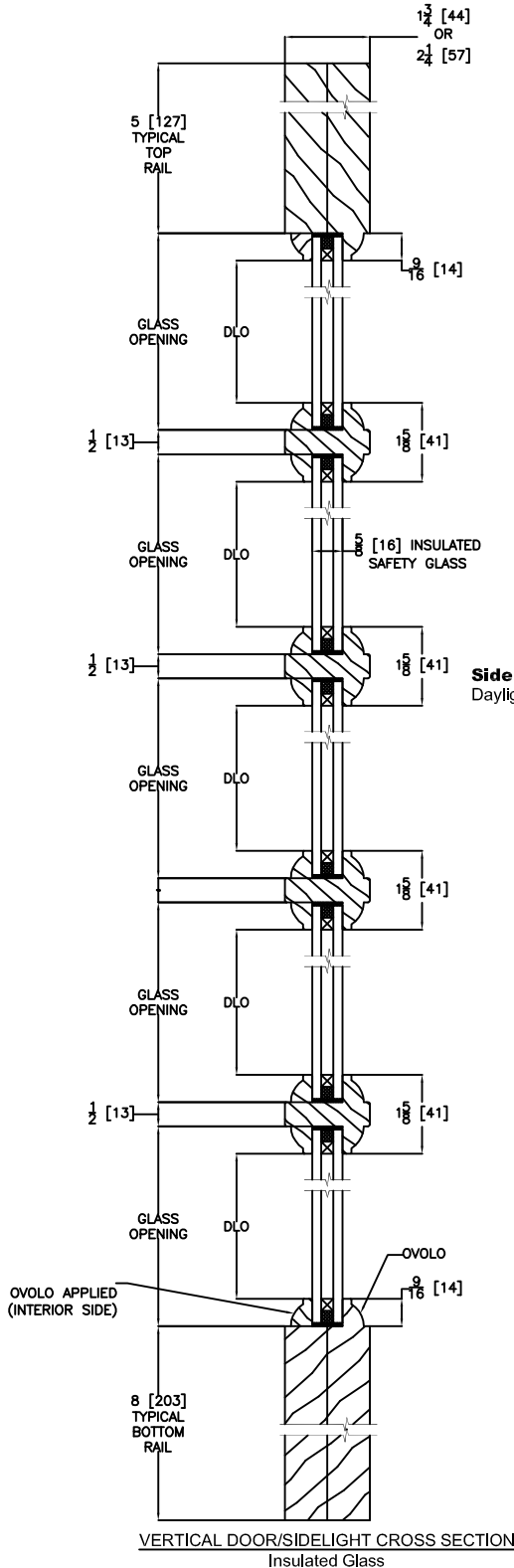

Door Size
 Daylight Opening

30" [762]
 9 1/8" [232]

32" [813]
 10 1/8" [257]

36" [914]
 12 1/8" [308]

42" [1067]
 14 5/8" [371]

80" [2032]
 11 7/8" [302]

84" [2134]
 12 11/16" [322]

96" [2438]
 12 9/32" [312]

Sidelight Size
 Daylight Opening

12" [305]
 7 1/2" [191]

13" [330]
 7 1/2" [191]

14" [356]
 7 1/2" [191]

15" [381]
 9 1/8" [232]

16" [406]
 9 1/8" [232]

17" [432]
 9 1/8" [232]

18" [457]
 9 1/8" [232]

80" [2032]
 11 7/8" [302]

84" [2134]
 12 11/16" [322]

96" [2438]
 12 9/32" [312]

12" [305]
 7 1/2" [191]

13" [330]
 7 1/2" [191]

14" [356]
 7 1/2" [191]

15" [381]
 9 1/8" [232]

16" [406]
 9 1/8" [232]

17" [432]
 9 1/8" [232]

18" [457]
 9 1/8" [232]

12" [305]
 7 1/2" [191]

13" [330]
 7 1/2" [191]

14" [356]
 7 1/2" [191]

15" [381]
 9 1/8" [232]

16" [406]
 9 1/8" [232]

17" [432]
 9 1/8" [232]

18" [457]
 9 1/8" [232]

12" [305]
 7 1/2" [191]

13" [330]
 7 1/2" [191]

14" [356]
 7 1/2" [191]

15" [381]
 9 1/8" [232]

16" [406]
 9 1/8" [232]

17" [432]
 9 1/8" [232]

18" [457]
 9 1/8" [232]

12" [305]
 7 1/2" [191]

13" [330]
 7 1/2" [191]

14" [356]
 7 1/2" [191]

15" [381]
 9 1/8" [232]

16" [406]
 9 1/8" [232]

17" [432]
 9 1/8" [232]

18" [457]
 9 1/8" [232]

12" [305]
 7 1/2" [191]

13" [330]
 7 1/2" [191]

14" [356]
 7 1/2" [191]

15" [381]
 9 1/8" [232]

16" [406]
 9 1/8" [232]

17" [432]
 9 1/8" [232]

18" [457]
 9 1/8" [232]

12" [305]
 7 1/2" [191]

13" [330]
 7 1/2" [191]

14" [356]
 7 1/2" [191]

15" [381]
 9 1/8" [232]

16" [406]
 9 1/8" [232]

17" [432]
 9 1/8" [232]

18" [457]
 9 1/8" [232]

ELEVATION NOTES

Door Size = Book Size Before Prefit
 Daylight Opening (DLO) = Visible Glass
 Values in brackets [] are millimeter conversions.

DOOR CROSS-SECTION

Moulding Profile = Ovolo
 Panel Profile = n/a
 See 515 Cross Section sheet for more detail.

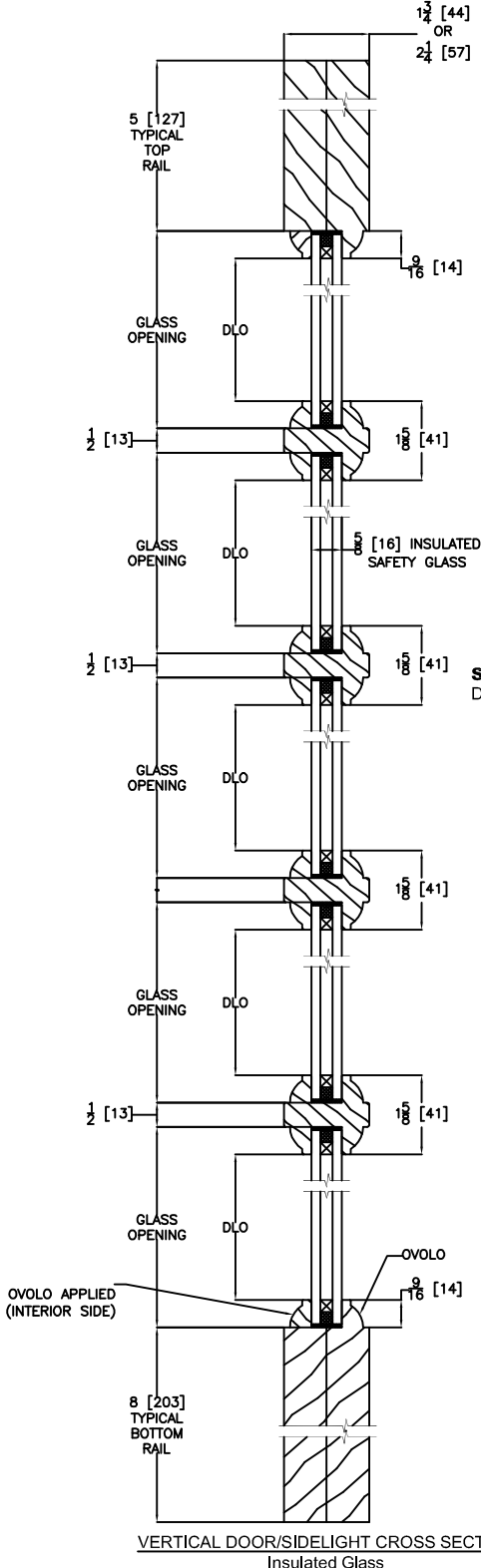

VERTICAL DOOR/SIDELIGHT CROSS SECTION
 Insulated Glass

Door Size	30" [762]	32" [813]	36" [914]	42" [1067]			
Daylight Opening	5 17/32" [140]	6 7/32" [158]	7 17/32" [191]	9 7/32" [234]			
80" [2032]	11 7/8" [302]						
84" [2134]	12 11/16" [322]						
96" [2438]	12 9/32" [312]						
Sidelight Size	12" [305]	13" [330]	14" [356]	15" [381]	16" [406]	17" [432]	18" [457]
Daylight Opening	7 1/2" [191]	7 1/2" [191]	7 1/2" [191]	9 1/8" [232]	9 1/8" [232]	9 1/8" [232]	9 1/8" [232]

ELEVATION NOTES

Door Size = Book Size Before Prefit
Daylight Opening (DLO) = Visible Glass
Values in brackets [] are millimeter conversions.

DOOR CROSS-SECTION

Moulding Profile = 800
Panel Profile = 45 Degree
See 750 Cross Section sheet for more detail.

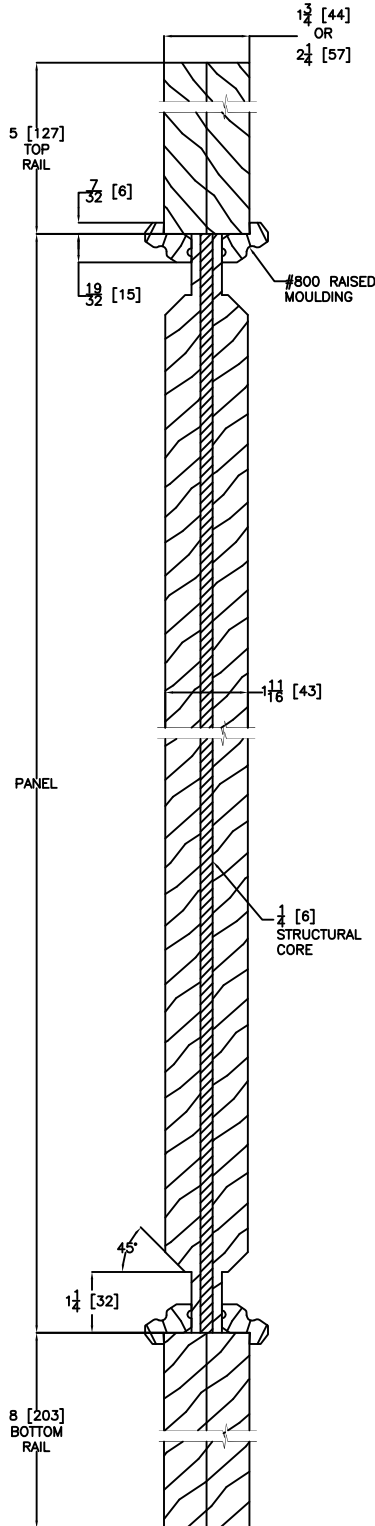

VERTICAL DOOR CROSS SECTION

Door Size
Daylight Opening

30" [762]
2 13/16" [71]

32" [813]
2 13/16" [71]

36" [914]
2 13/16" [71]

42" [1067]
3 13/16" [97]

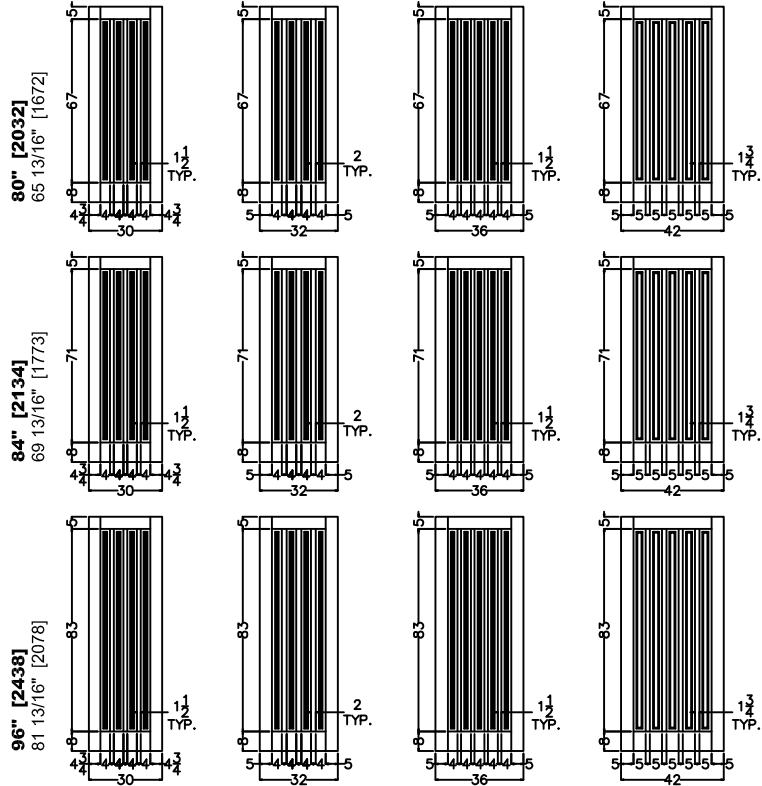

Sidelight Size
Daylight Opening

12" [305]
2 13/16" [71]

13" [330]
2 13/16" [71]

14" [356]
2 13/16" [71]

15" [381]
2 13/16" [71]

16" [406]
2 13/16" [71]

17" [432]
3 13/16" [97]

18" [457]
3 13/16" [97]

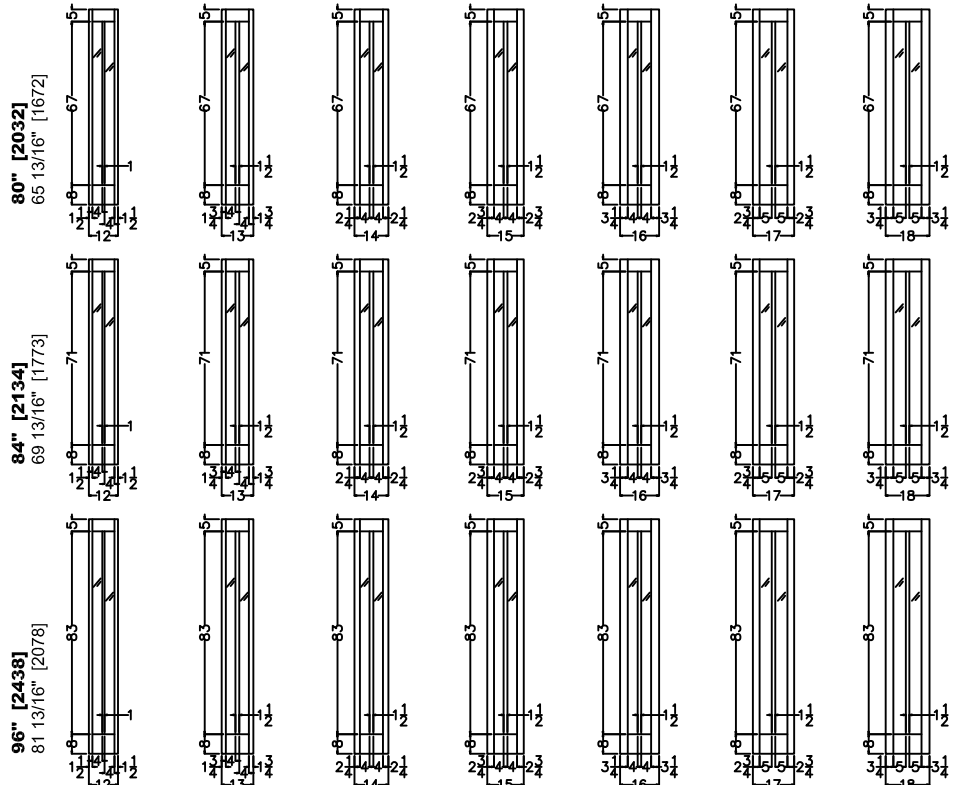

ELEVATION NOTES

Door Size = Book Size Before Prefit
 Daylight Opening (DLO) = Visible Glass
 Values in brackets [] are millimeter conversions.

DOOR CROSS-SECTION

Moulding Profile = Square Sticking
 Panel Profile = n/a
 See 802 Cross Section sheet for more detail.

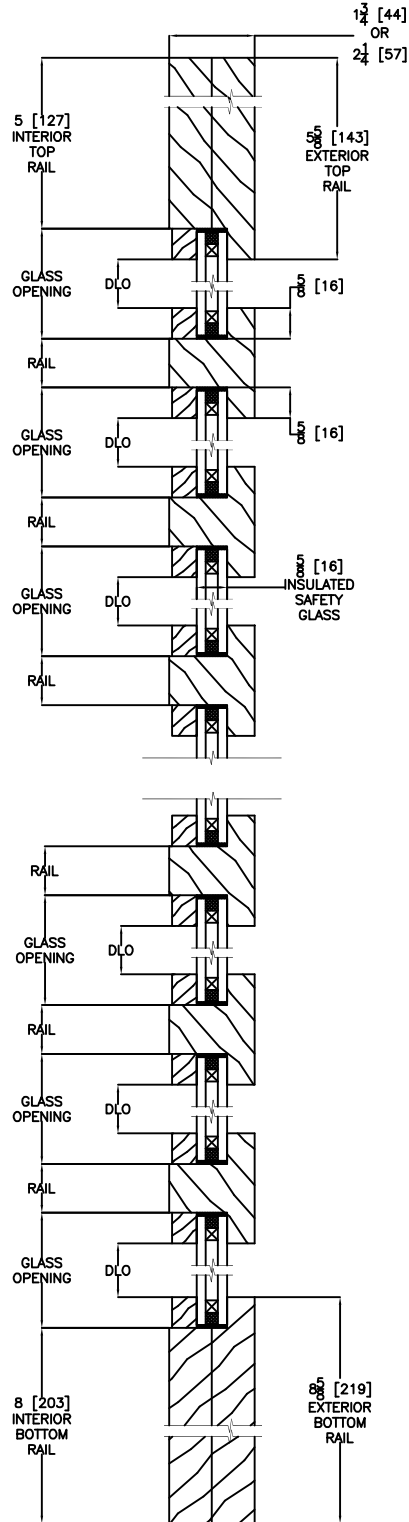

Door Size
 Daylight Opening

30" [762]
 3 3/4" [95]

32" [813]
 3 3/4" [95]

36" [914]
 3 3/4" [95]

42" [1067]
 4 1/4" [108]

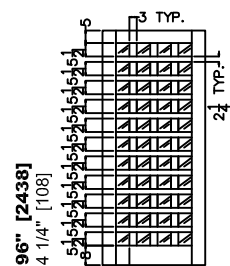
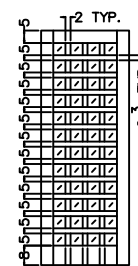
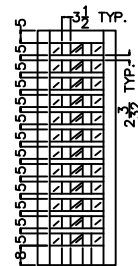
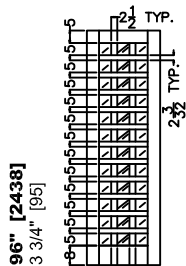
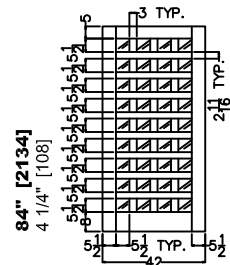
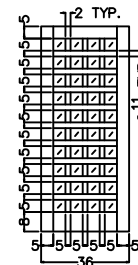
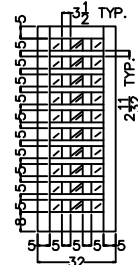
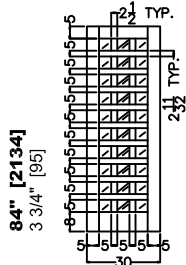
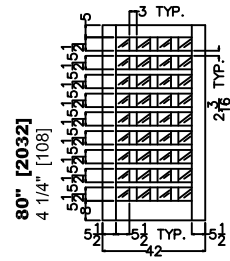
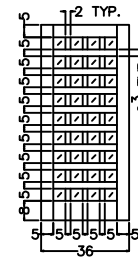
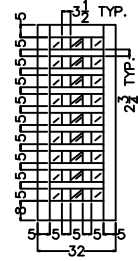
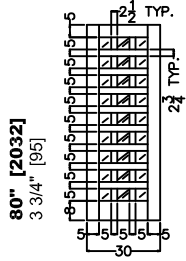

VERTICAL DOOR CROSS SECTION
 Insulated Glass

ELEVATION NOTES

Door Size = Book Size Before Prefit
 Daylight Opening (DLO) = Visible Glass
 Values in brackets [] are millimeter conversions.

DOOR CROSS-SECTION

Moulding Profile = 112
 Panel Profile = n/a
 See 880 Cross Section sheet for more detail.

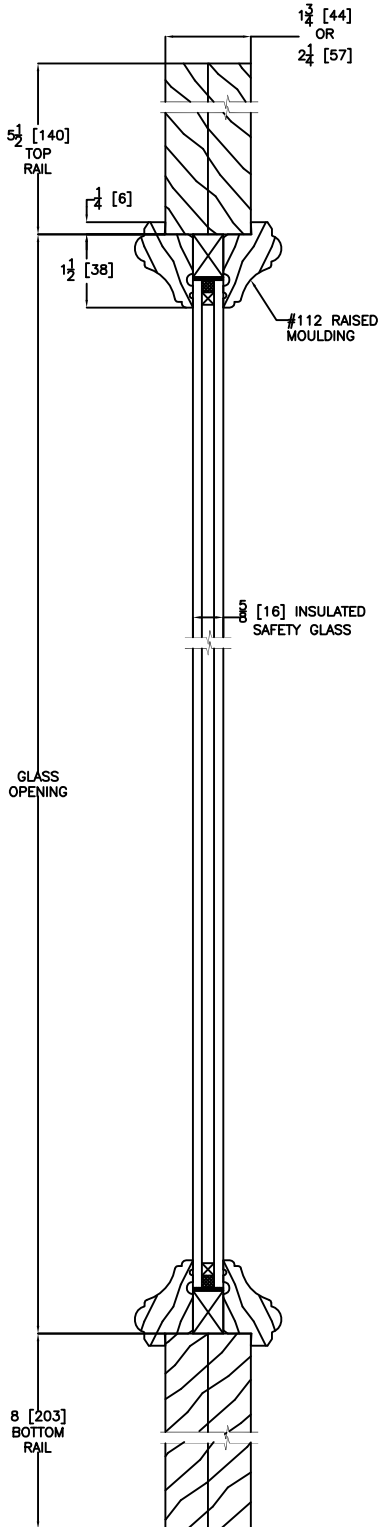

Door Size
 Daylight Opening

30" [762]
 17" [432]

32" [813]
 18" [457]

36" [914]
 22" [559]

42" [1067]
 28" [711]

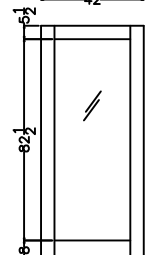
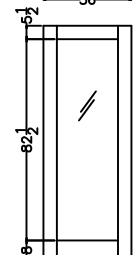
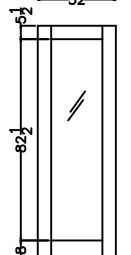
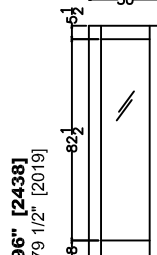
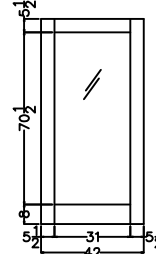
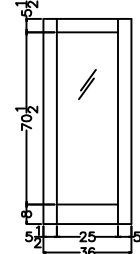
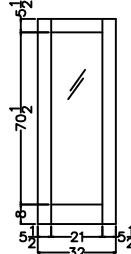
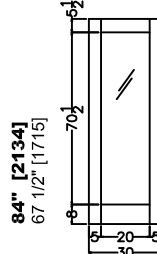
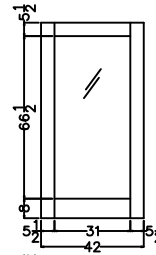
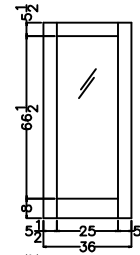
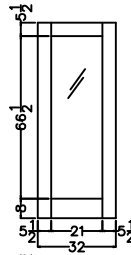
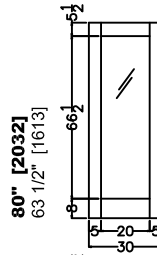

Sidelight Size
 Daylight Opening

12" [305]
 6" [152]

13" [330]
 6" [152]

14" [356]
 6" [152]

15" [381]
 8 3/4" [222]

16" [406]
 8 3/4" [222]

17" [432]
 8 3/4" [222]

18" [457]
 8 3/4" [222]

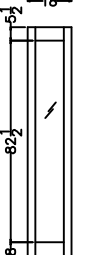
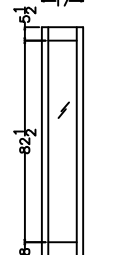
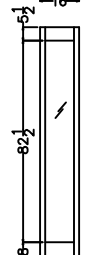
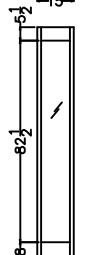
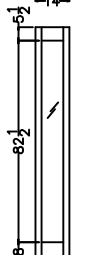
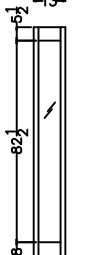
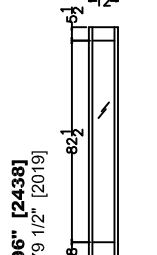
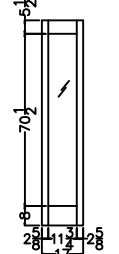
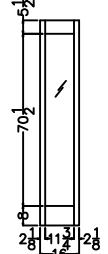
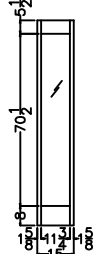
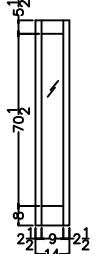
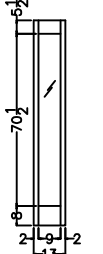
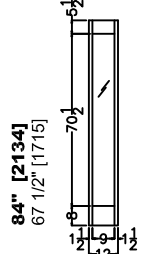
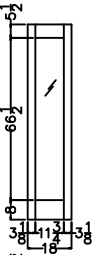
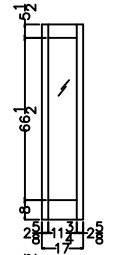
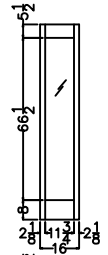
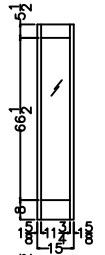
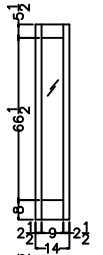
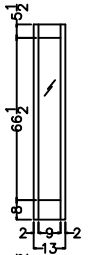
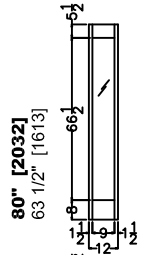

VERTICAL DOOR/SIDELIGHT CROSS SECTION
 Insulated Glass

ELEVATION NOTES

Door Size = Book Size Before Prefit
 Daylight Opening (DLO) = Visible Glass
 Values in brackets [] are millimeter conversions.

DOOR CROSS-SECTION

Moulding Profile = 141
 Panel Profile = n/a
 See 5037 Cross Section sheet for more detail.

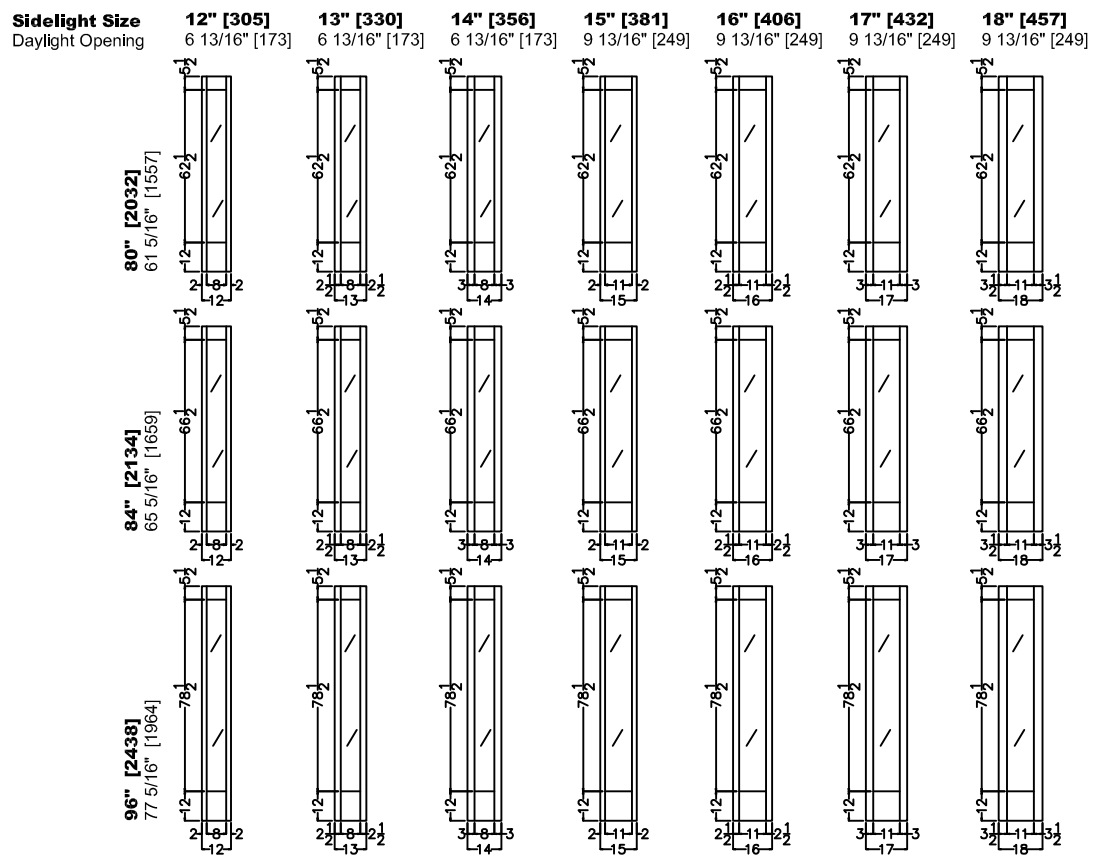
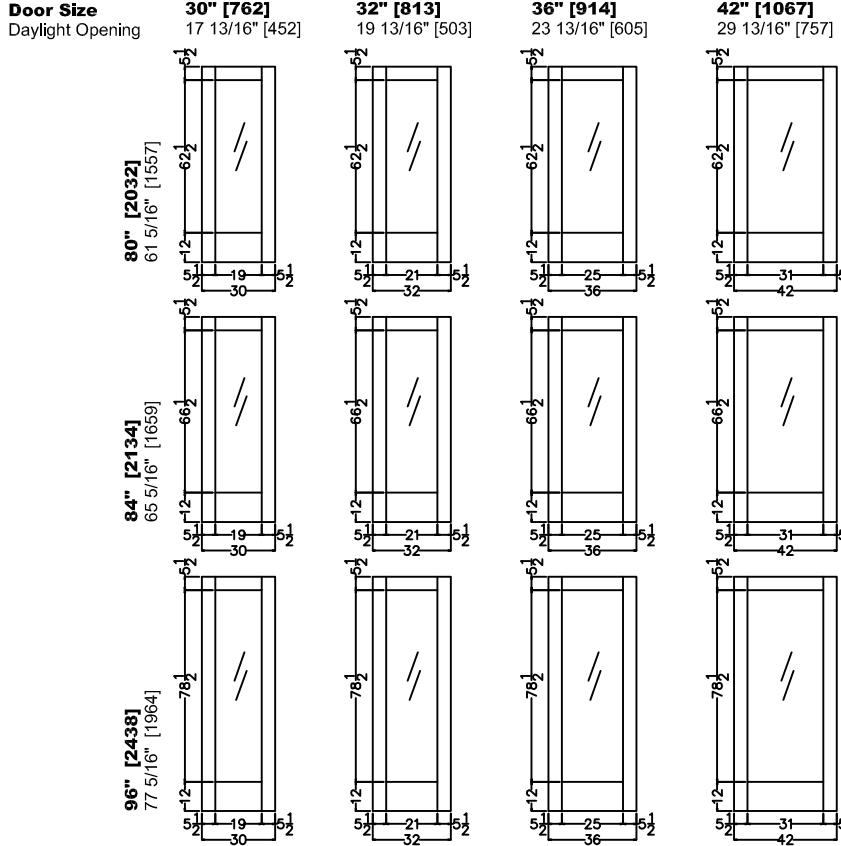
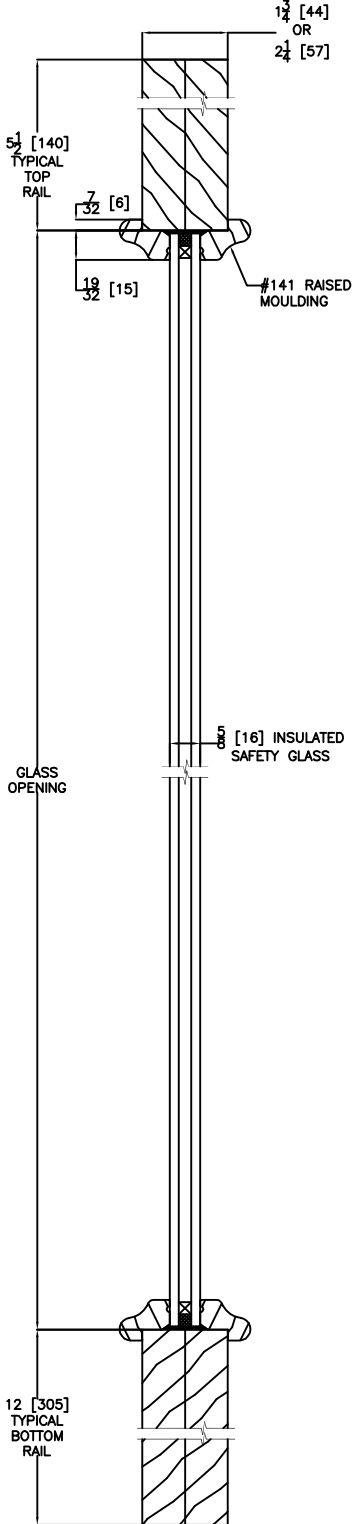

VERTICAL DOOR/SIDELIGHT CROSS SECTION
 Insulated Glass

ELEVATION NOTES

Door Size = Book Size Before Prefit
 Daylight Opening (DLO) = Visible Glass
 Values in brackets [] are millimeter conversions.

DOOR CROSS-SECTION

Moulding Profile = 141
 Panel Profile = n/a
 See 5037 Cross Section sheet for more detail.

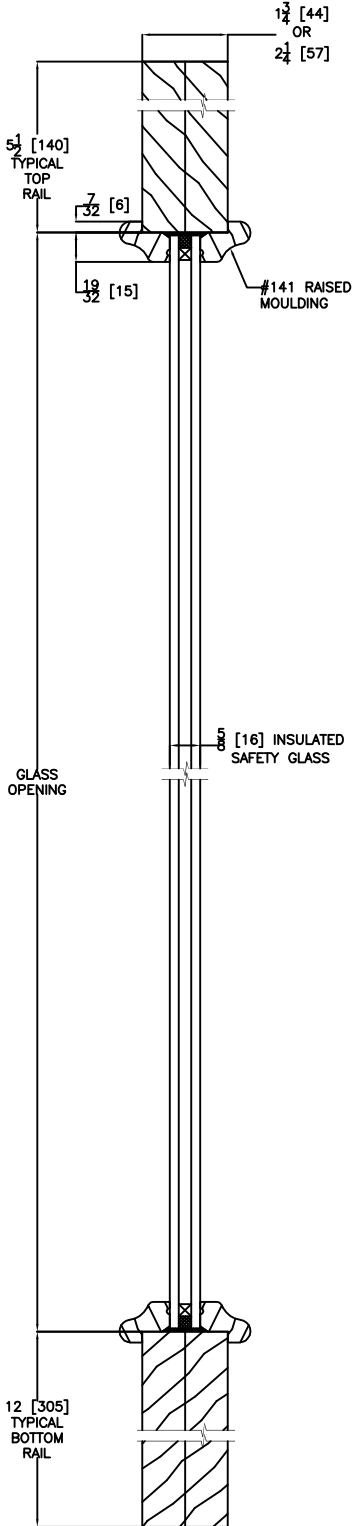

Door Size	30" [762]	32" [813]	36" [914]	42" [1067]
Daylight Opening	17 13/16" [452]	19 13/16" [503]	23 13/16" [605]	29 13/16" [757]
80" [2032]	61 5/16" [1557]			
84" [2134]	65 5/16" [1659]			
96" [2438]	77 5/16" [1964]			

VERTICAL DOOR/SIDELIGHT CROSS SECTION
 Insulated Glass

ELEVATION NOTES

Door Size = Book Size Before Prefit
 Daylight Opening (DLO) = Visible Glass
 Values in brackets [] are millimeter conversions.

DOOR CROSS-SECTION

Moulding Profile = 141
 Panel Profile = n/a
 See 5037 Cross Section sheet for more detail.

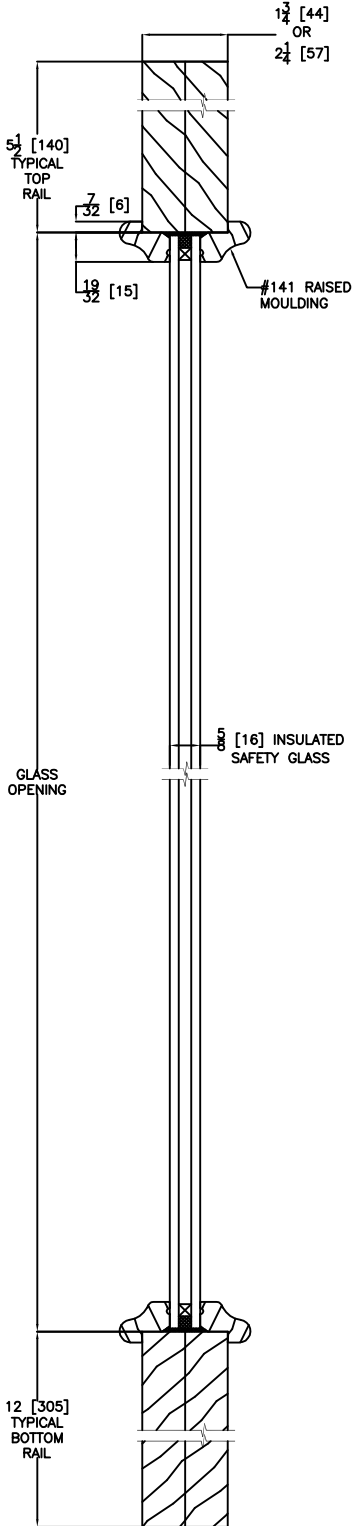

RADIUS

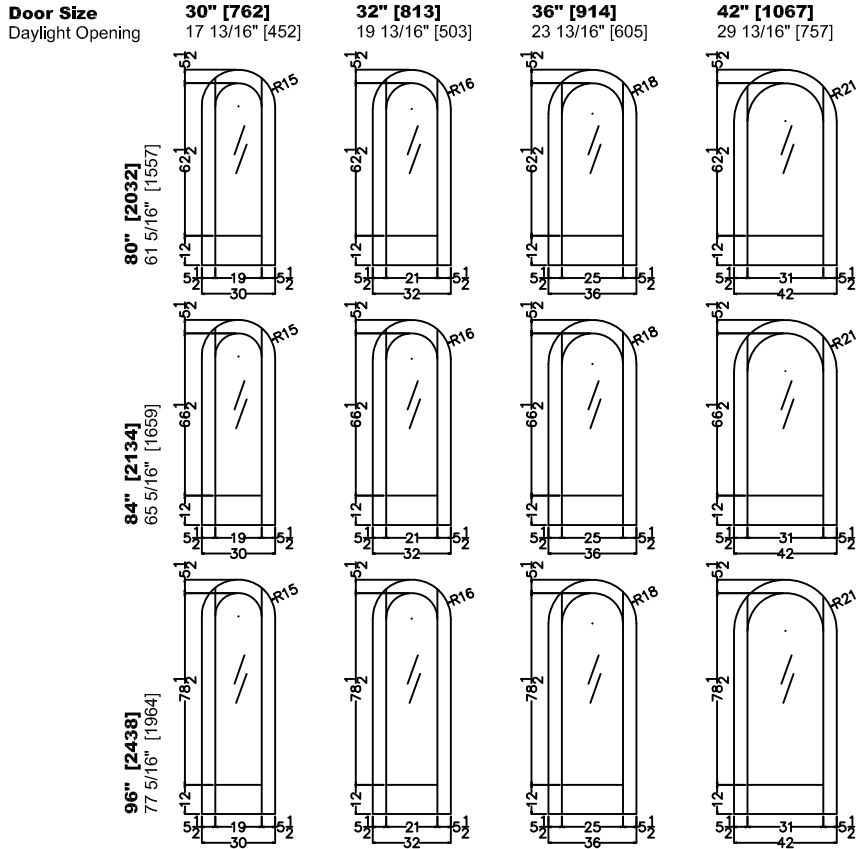

HALF RADIUS

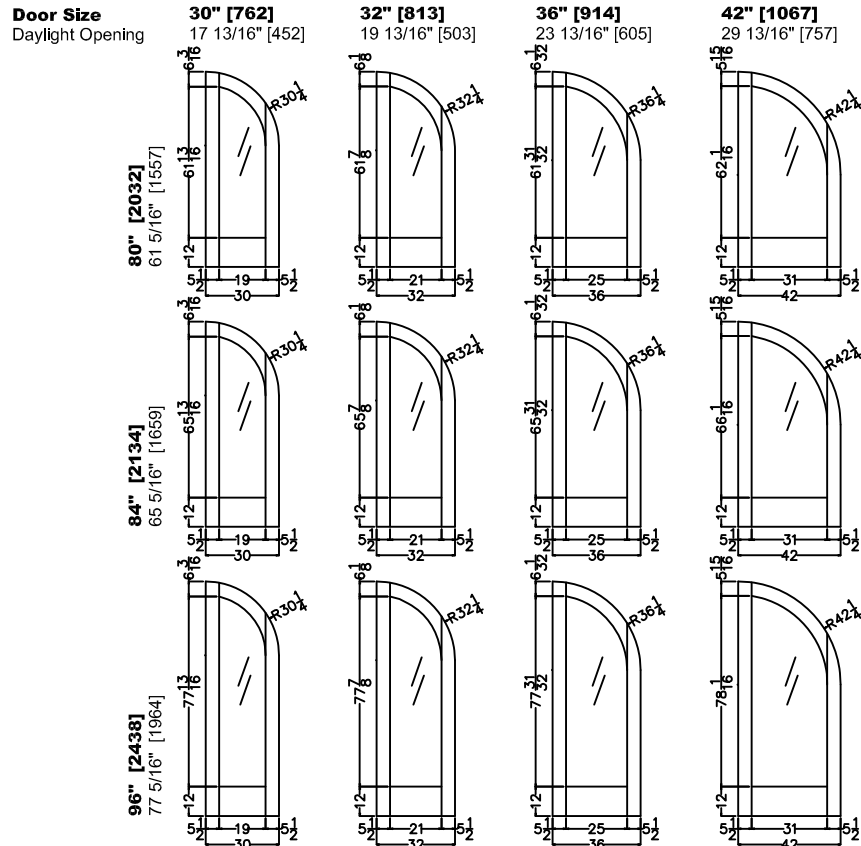

VERTICAL DOOR/SIDELIGHT CROSS SECTION
 Insulated Glass

ELEVATION NOTES

Door Size = Book Size Before Prefit
 Daylight Opening (DLO) = Visible Glass
 Values in brackets [] are millimeter conversions.

DOOR CROSS-SECTION

Moulding Profile = 141
 Panel Profile = n/a
 See 5037 Cross Section sheet for more detail.

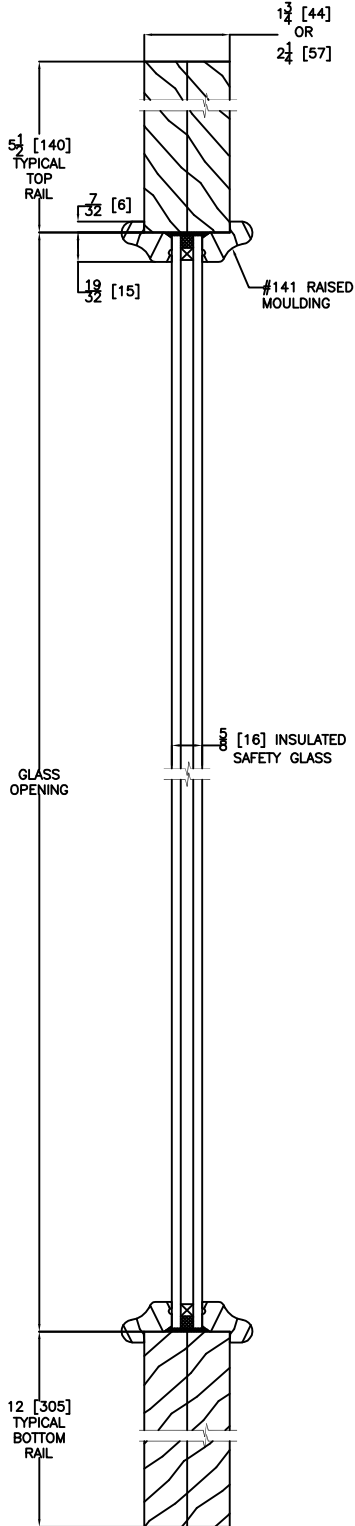

SEGMENT

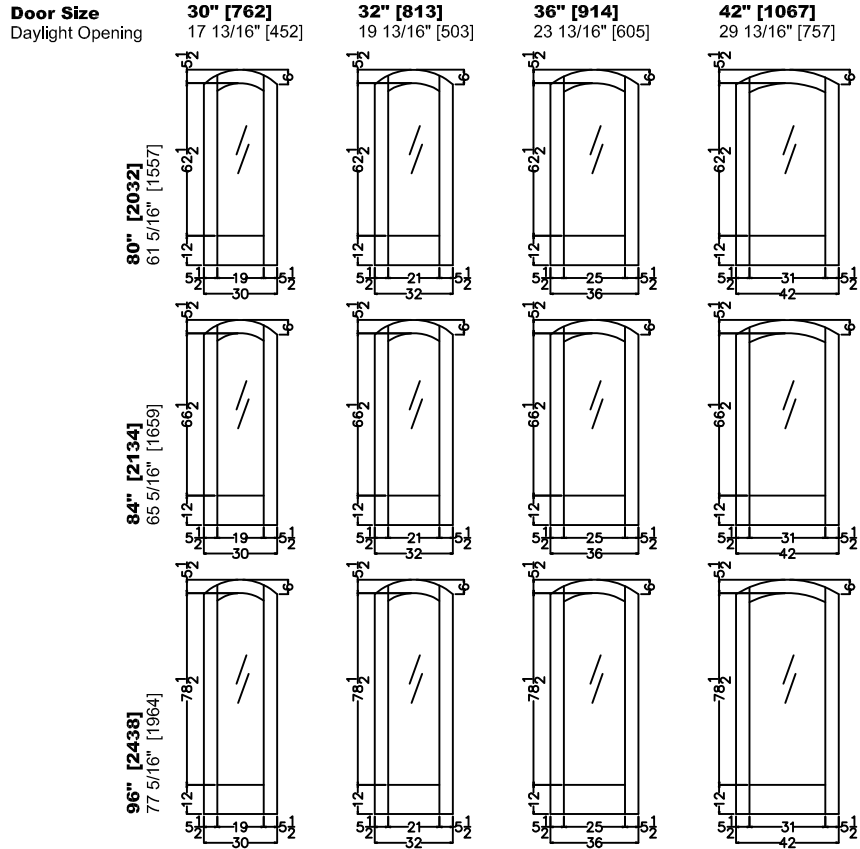

HALF SEGMENT

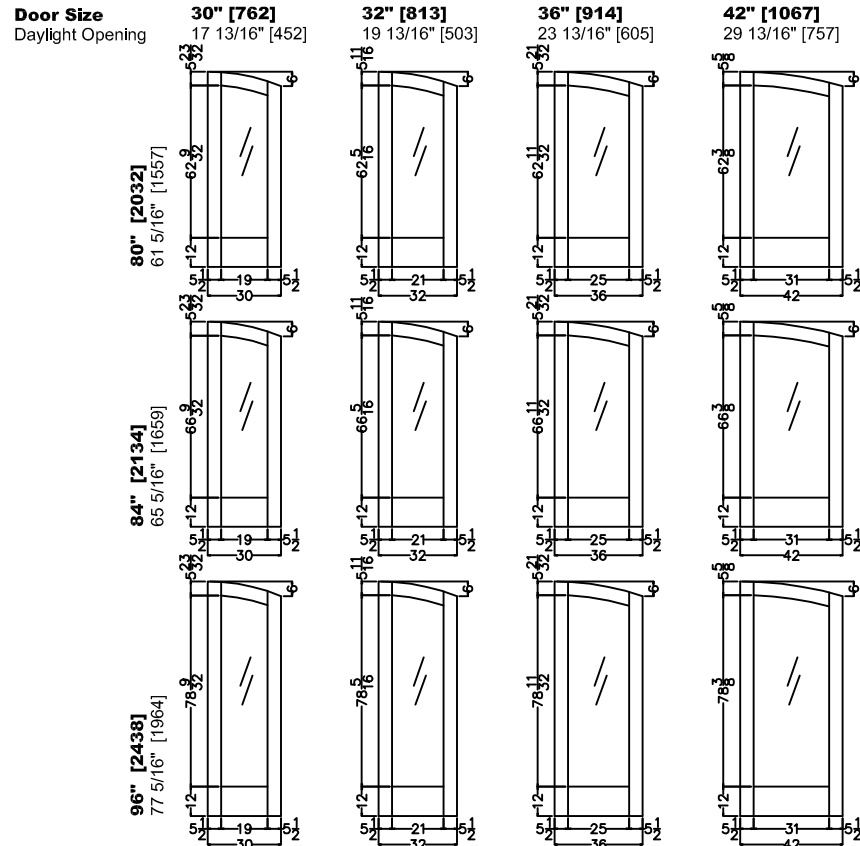

VERTICAL DOOR/SIDELIGHT CROSS SECTION
 Insulated Glass

ELEVATION NOTES

Door Size = Book Size Before Prefit
 Daylight Opening (DLO) = Visible Glass
 Values in brackets [] are millimeter conversions.

DOOR CROSS-SECTION

Moulding Profile = 1200
 Panel Profile = n/a
 See 1101 Cross Section sheet for more detail.

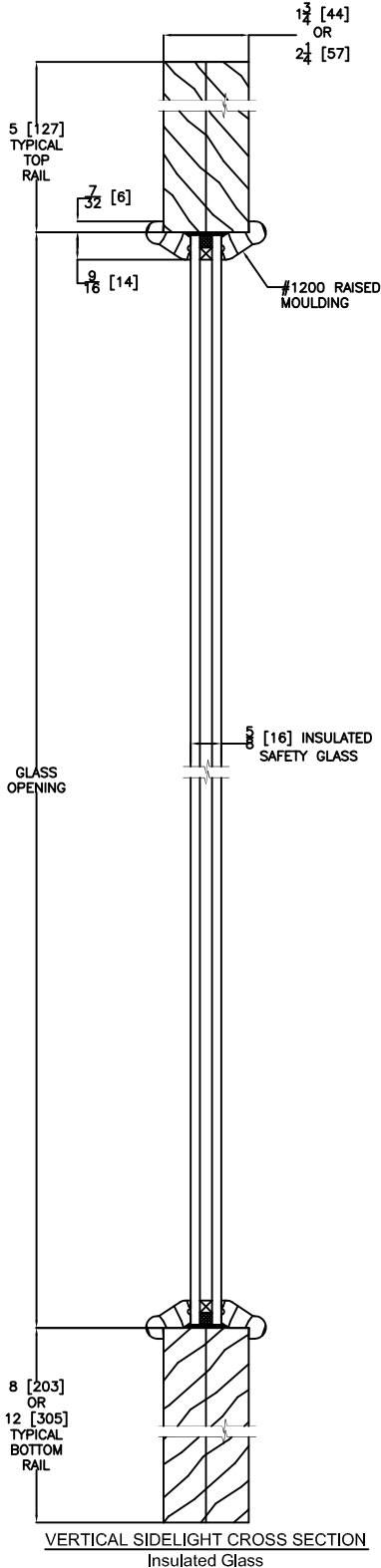

Sidelight Size	12" [305]	13" [330]	14" [356]	15" [381]	16" [406]	17" [432]	18" [457]
Daylight Opening	5 7/8" [149]	5 7/8" [149]	5 7/8" [149]	5 7/8" [149]	9 7/8" [251]	9 7/8" [251]	9 7/8" [251]
80" [2032]	65 7/8" [1673]						
84" [2134]	65 7/8" [1673]						
96" [2438]	81 7/8" [2080]						

DECORATIVE ACCENTS



ROUND CLAVOS

Size Options: 1" diameter, 1.75" diameter
 Finish Options: Dark Patina, Rust Patina
 Material: Aluminum with Powder Coat Finish



DIAMOND CLAVOS

Size Options: 1", 1.75"
 Finish Options: Dark Patina, Rust Patina
 Material: Aluminum with Powder Coat Finish

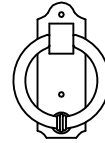

COLONIAL DOOR KNOCKER

Base: 2" Wide x 5 5/8" Tall, Handle: 4" Wide
 Finish Options: Dark Patina, Rust Patina
 Material: Iron

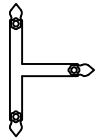

RAIL STRAP

Finish Options: Dark Patina, Rust Patina
 Material: Aluminum with Powder Coat Finish



CORNER STRAP

Finish Options: Dark Patina, Rust Patina
 Material: Aluminum with Powder Coat Finish

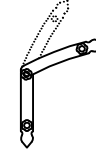

RADIUS STRAP

Finish Options: Dark Patina, Rust Patina
 Material: Aluminum with Powder Coat Finish
 Adjustable for Segment/Radius Shapes

SPEAKEASY/DOOR LIGHT

Glass Options: Clear IG, Clear SG, Bevel IG, Bevel SG, Glue Chip IG,
 Low E IG, Rain IG, Reed IG, Frosted IG, Open for Glass
 Handing: Will be Handed to Match the Door unless Otherwise Specified
 Frame Size: 11 3/4" x 14 3/4", Daylight Opening: 8" x 11", Actual Glass Size: 8 7/8" x 11 7/8"

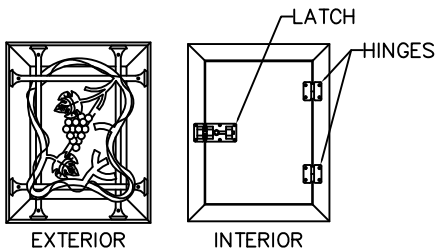

SPEAKEASY, BORDEAUX GRILLE

Hardware Finish Options: Dark Patina, Rust Patina
 Material: Wood Frame / Iron Hardware

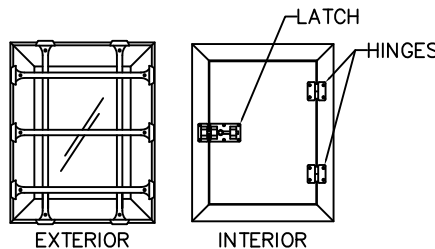

SPEAKEASY, RUSTIC GRILLE

Hardware Finish Options: Dark Patina, Rust Patina
 Material: Wood Frame / Iron Hardware

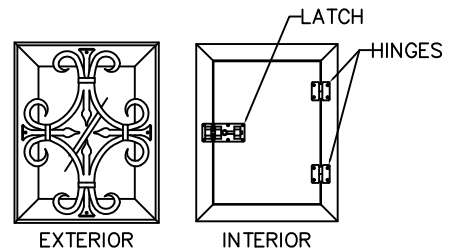

SPEAKEASY, SEVILLE GRILLE

Hardware Finish Options: Dark Patina, Rust Patina
 Material: Wood Frame / Iron Hardware

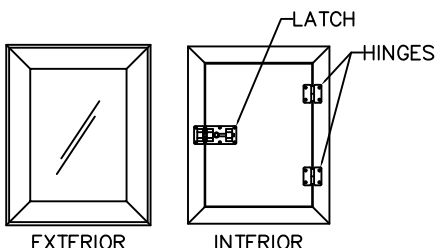

SPEAKEASY (NO GRILLE)

Hardware Finish Options: Dark Patina, Rust Patina
 Material: Wood Frame / Iron Hardware

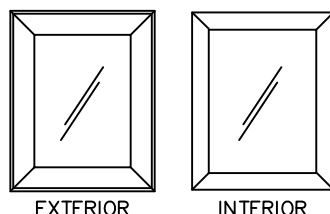

RECTANGLE DOOR LIGHT

Hardware Finish Options: n/a
 Material: Wood Frame
 Available with All Speakeasy Grilles

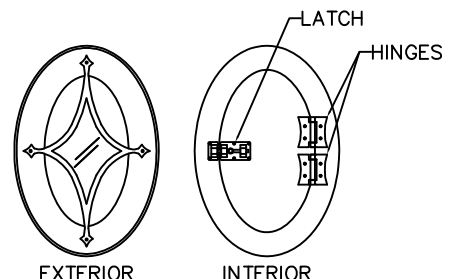

OVAL SPEAKEASY, VICTORIAN GRILLE

Hardware Finish Options: Dark Patina, Rust Patina
 Material: Wood Frame / Iron Hardware
 Frame Size: 12" x 17 1/2"



#20 CASING
2 1/4" X 1 1/8"



#20 w/ STUCCO KEY
2 1/4" X 1 1/8"



#22 CASING
2" X 1 1/8"



#13 CASING
3 1/2" X 3/4"



#14 CASING
2 1/4" X 3/4"

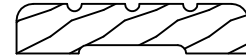

#15 CASING
3 1/2" X 3/4"



#16 CASING
2 1/4" X 3/4"



#17 CASING
4 1/2" X 1 3/16"

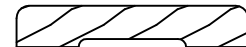

#21 CASING
3 1/2" X 5/8"



#23 CASING
3 1/2" X 1 1/8"

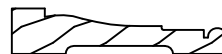

#24 CASING
3 1/4" X 11/16"

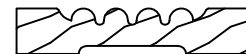

#25 CASING
3 1/2" X 11/16"

Notes:

Shown here are standard trim options.

Special size casing or custom profile casing may be available upon request.

EXTERIOR CORNER BLOCK

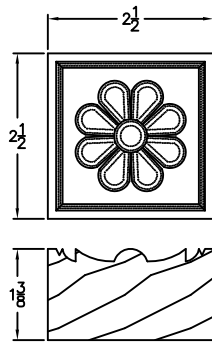

"A" BLOCK
2 1/2" X 2 1/2"

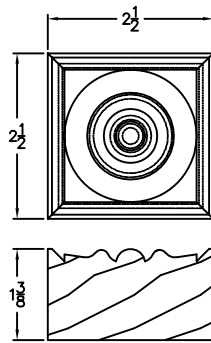

"B" BLOCK
2 1/2" X 2 1/2"

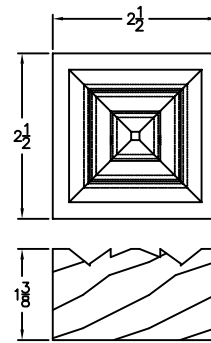

"C" BLOCK
2 1/2" X 2 1/2"

INTERIOR CORNER BLOCK

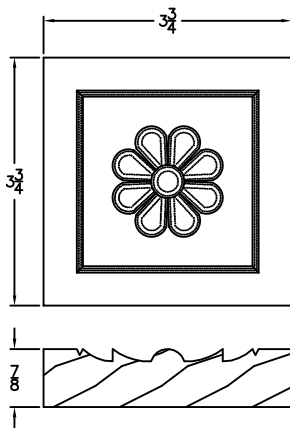

"A" BLOCK
3 3/4" X 3 3/4"

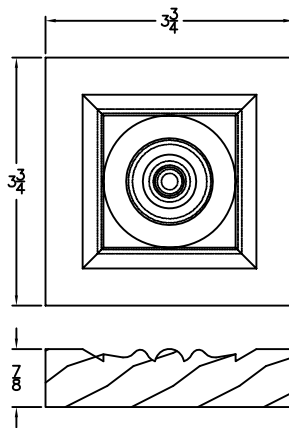

"B" BLOCK
3 3/4" X 3 3/4"

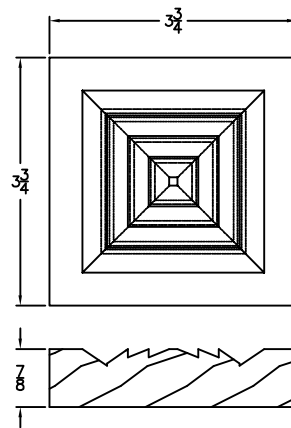

"C" BLOCK
3 3/4" X 3 3/4"

Notes:

Interior corner block may be used for exterior application and vice versa.

INSULATED GLASS

- Clear Safety
- Clear Beveled
- Glue Chip
- Low-E
- Rain
- Frosted

TRIPLE GLAZED

A

"A" GLASS

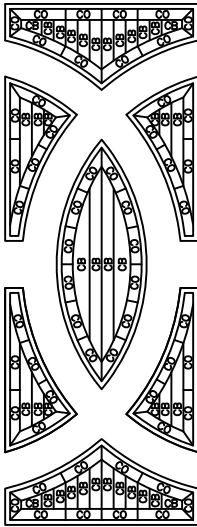

LEGEND
 CB-Clear Bevel
 CO-Cotswald

Door Size	12"-14"	15"-18"
Glass Size	7 1/8"	9 1/8"

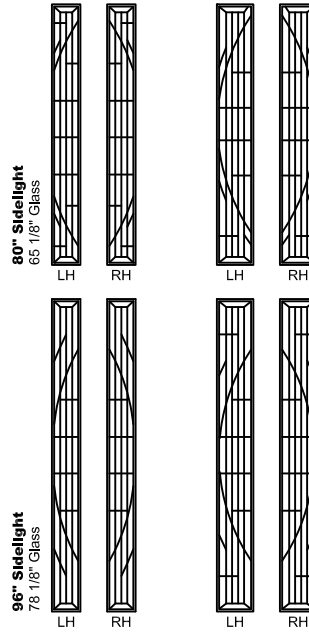

Door Size	30"	32"	36"	42"
Glass Size	Various	Various	Various	Various

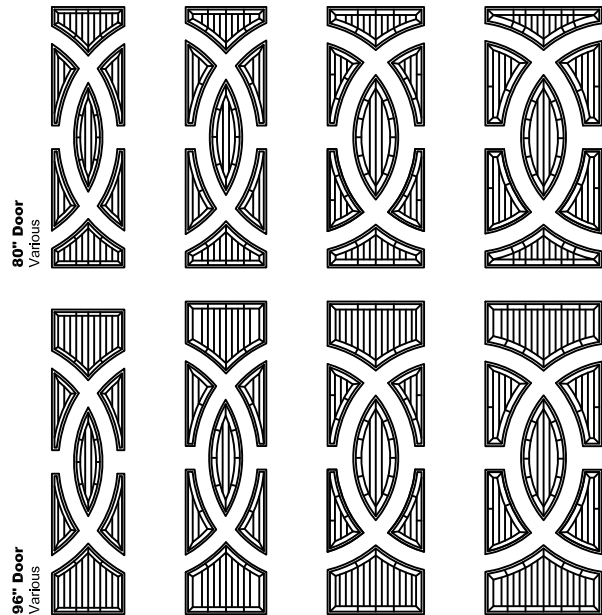

INSULATED GLASS

Clear Safety
Clear Beveled
Glue Chip
Low-E
Rain
Reed
Frosted

TRIPLE GLAZED

260 GLASS

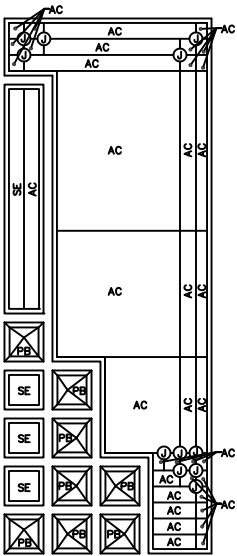

LEGEND

PB-Peaked Bevel (Dual Glazed)
AC-Clear Antique
SE-Seedy
J-Jewel

Door Size 16"
Glass Size 11 7/8"

80" Door
66 7/8"

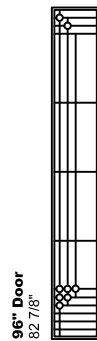

36"
Various

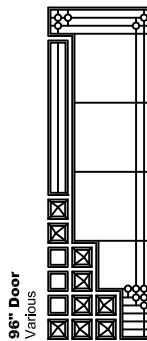
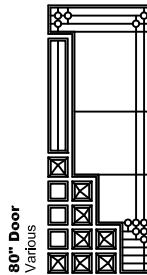

INSULATED GLASS

- Clear Safety
- Clear Beveled
- Glue Chip
- Low-E
- Rain
- Reed
- Frosted

TRIPLE GLAZED

264 GLASS

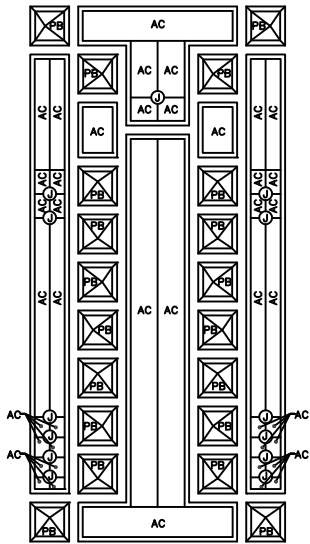

LEGEND

- PB-Peaked Bevel (Dual Glazed)
- AC-Clear Antique
- J-Jewel

Door Size 16"
Glass Size 11 7/8"

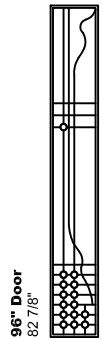
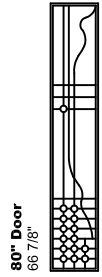

Door Size 42"
Glass Size Various

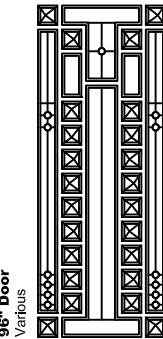
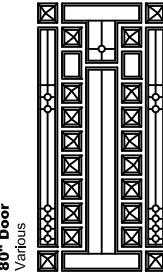

INSULATED GLASS

- Clear Safety
- Clear Beveled
- Glue Chip
- Low-E
- Rain
- Reed
- Frosted

TRIPLE GLAZED

266 GLASS

Door Size 36"
Glass Size 25 7/8"

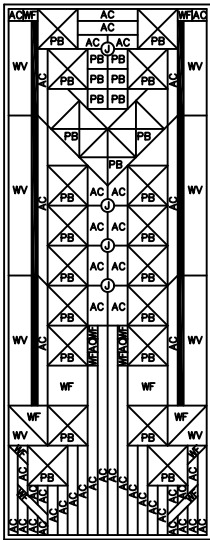

LEGEND

- PB-Peaked Bevel
- AC-Clear Antique
- WF-White Flash
- WV-Weave (Cross Reed)
- J-Jewel

80" Door
66 7/8"

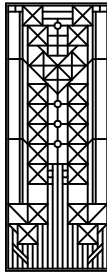

96" Door
82 7/8"

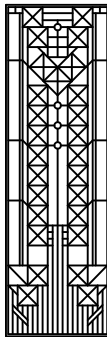

INSULATED GLASS

Clear Safety
Clear Beveled
Glue Chip
Low-E
Rain
Reed
Frosted

TRIPLE GLAZED

268 GLASS

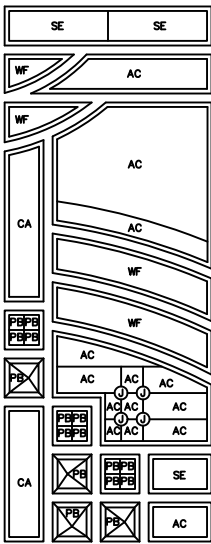

LEGEND
PB-Peaked Bevel
(Larger Bevels are Dual Glazed)
AC-Clear Antique
WF-White Flash
SE-Seedy
J-Jewel

Door Size
Glass Size

16"
Various

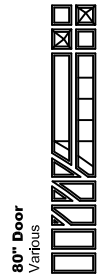

80" Door
Various

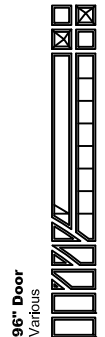

96" Door
Various

36"
Various

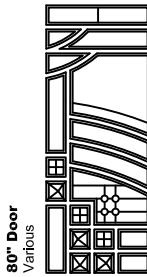

80" Door
Various

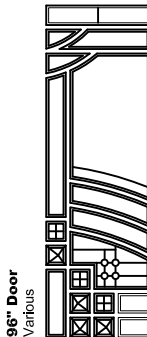

96" Door
Various

INSULATED GLASS

Clear Safety
 Clear Beveled
 Glue Chip
 Low-E
 Rain
 Reed
 Frosted

TRIPLE GLAZED

A - DE - FG - Q

"A" GLASS

Door Size
 Glass Size

12-14" 7 1/8" 15-18" 9 7/8" 30" 18 1/8" 36" 23 1/8" 42" 29 1/8"

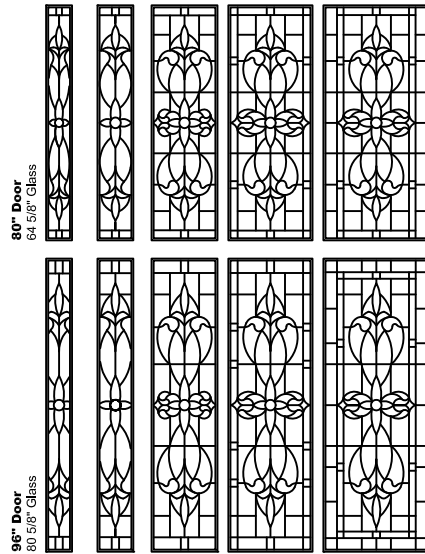
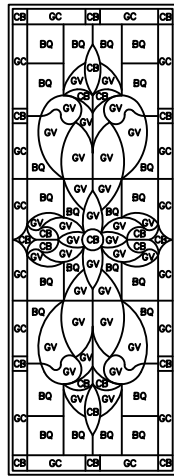

LEGEND
 CB-Clear Bevel
 GC-Glue Chip
 GV-Glue Chip Bevel
 BQ-Clear Baroque

"DE" GLASS

Door Size
 Glass Size

12-14" 7 1/8" 15-18" 9 7/8" 30" 18 1/8" 36" 23 1/8" 42" 29 1/8"

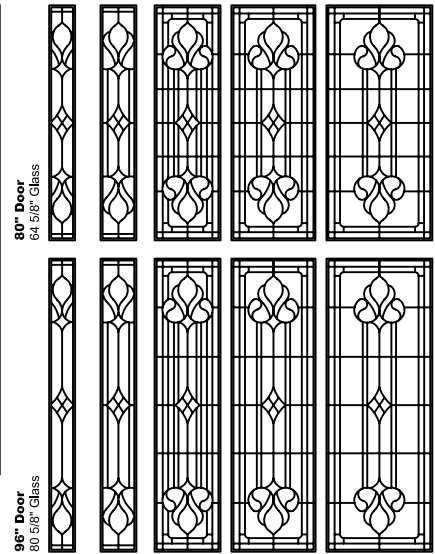
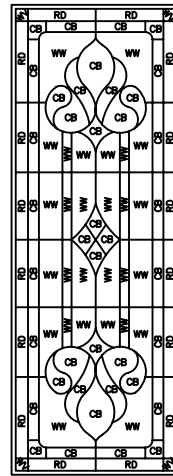

LEGEND
 CB-Clear Bevel
 WW-Clear Water
 WV-Weave (Cross Reed)
 RD-Reed

"FG" GLASS

Door Size
 Glass Size

12-14" 7 1/8" 15-18" 9 7/8" 30" 18 1/8" 36" 23 1/8" 42" 29 1/8"

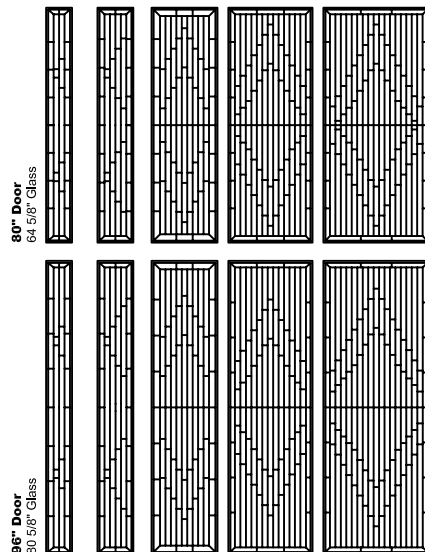
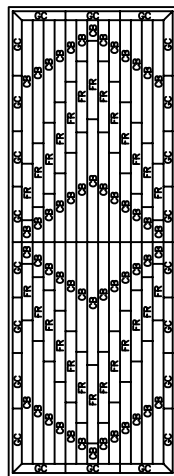

LEGEND
 CB-Clear Bevel
 GC-Glue Chip
 FR-Frosted

"Q" GLASS

Door Size
 Glass Size

12-14" 7 1/8" 15-18" 9 7/8" 30" 18 1/8" 36" 23 1/8" 42" 29 1/8"

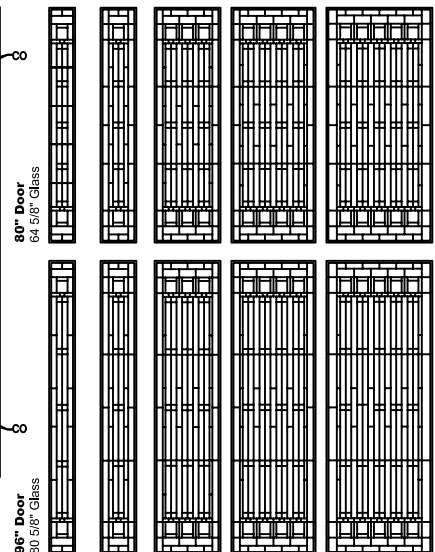
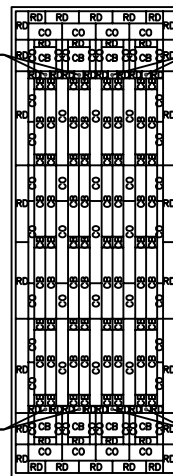

LEGEND
 CB-Clear Bevel
 CO-Cotswald (Rain)
 RD-Reed

INSULATED GLASS

Clear Safety
Clear Beveled
Glue Chip
Low-E
Rain
Reed
Frosted

TRIPLE GLAZED

ND - NV - NT

"ND" GLASS				"NV" GLASS				"NT" GLASS	
Door Size	Glass Size	12"-15"	16"-18"	Door Size	Glass Size	12"-15"	16"-18"	Door Size	Glass Size
		6 7/8"	10 7/8"			6 7/8"	10 7/8"		
		80" / 84" Door 66 7/8" Glass				80" / 84" Door 66 7/8" Glass		80" / 84" Door 66 7/8" Glass	
		96" Door 82 7/8" Glass				96" Door 82 7/8" Glass		96" Door 82 7/8" Glass	
LEGEND				LEGEND				LEGEND	
CB-Clear Bevel				CB-Clear Bevel				CB-Clear Bevel	
				CO-Cotswald				GC-Glue Chip	
				RI-Ripple				GA-Clear Gotta	
				BW-Antique Brown					
				B-Blue					

GRILLE NOTES

Finish: Dark Patina
Material: Aluminum

- Door & Sidelight Grilles are Operable
(Handed to Match Door)
- Design may Vary by Size/Shape of Door
(18"/36" x 96" Shown)
- Grilles May be Customized

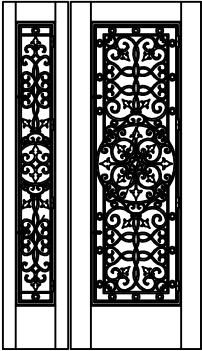

ARMADA

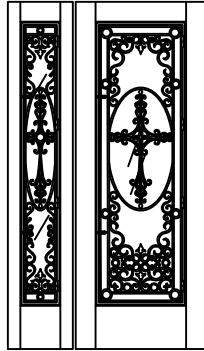

CATHEDRAL

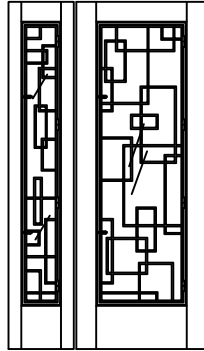

CENTURY

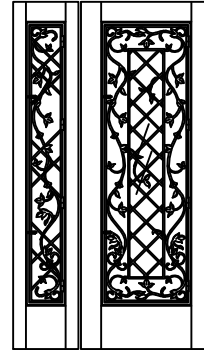

CHATEAU

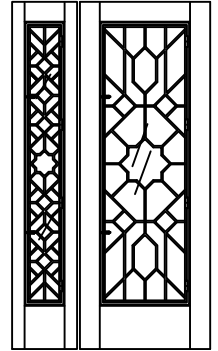

ETRUSCAN

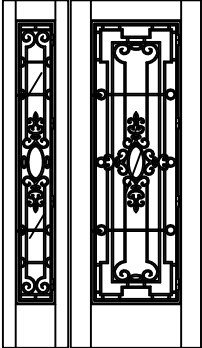

GEORGIAN

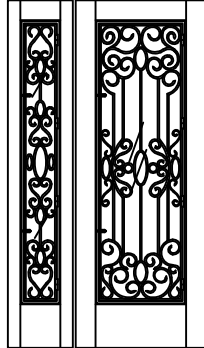

HERITAGE

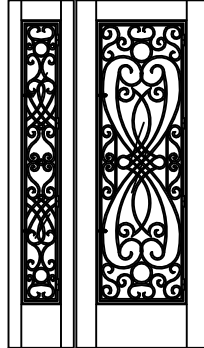

INFINITY

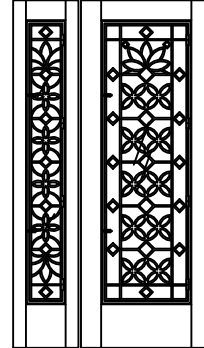

LOTUS

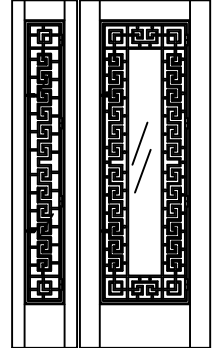

MEANDER

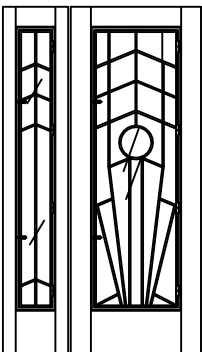

METROPOLIS

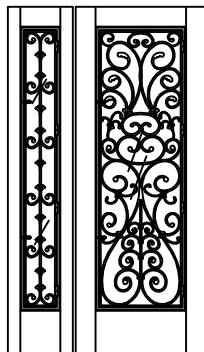

MONTE CARLO

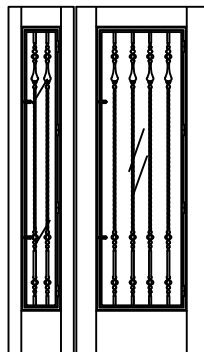

REGAL

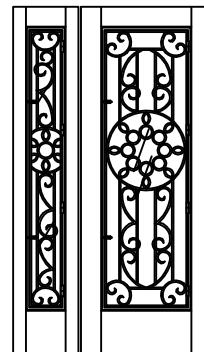

SUNDIAL

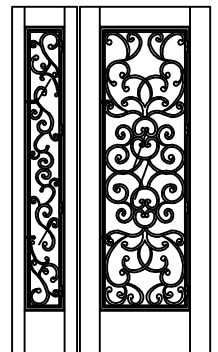

VERSAILLES

GRILLE NOTES

Finish: Dark Patina or Rust Patina
Material: Aluminum or Iron

- To Match Custom Wood Estate Series Doors (Flat Top)
- Grilles Are Fixed (Non-Operable)
- Design may Vary by Size/Shape (16" x 96" Shown)
- Surface Mounted to Stiles
- Grilles May be Customized



BORDEAUX



RUSTIC



SEVILLE



TUSCANY

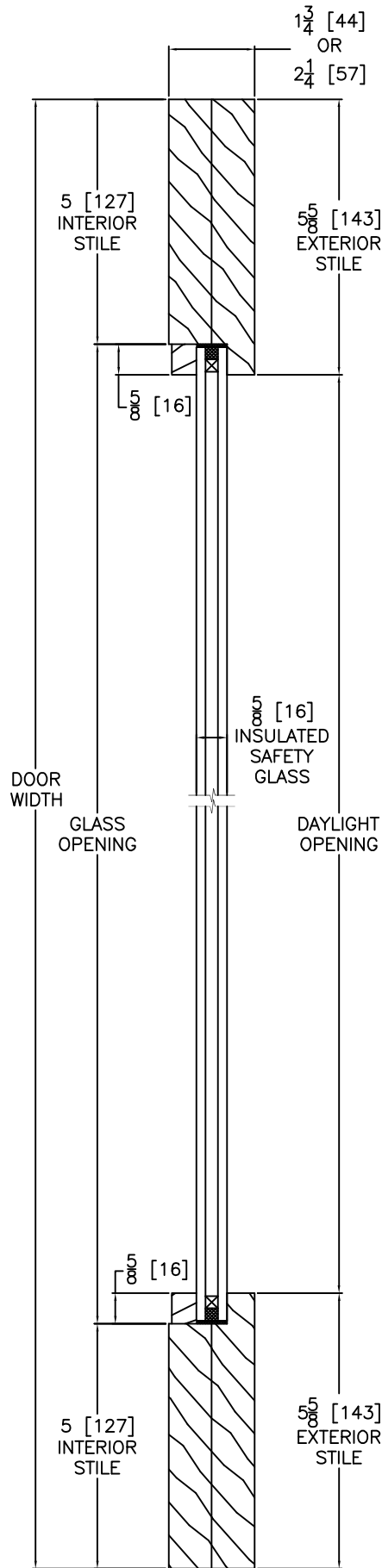
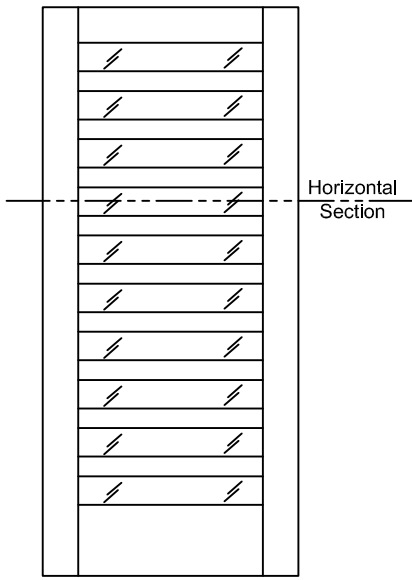

HORIZONTAL DOOR CROSS SECTION

Notes:
Stile,Rail,Panel & Glass
vary by Size & Model of Door.
Typical Sizes are Shown.

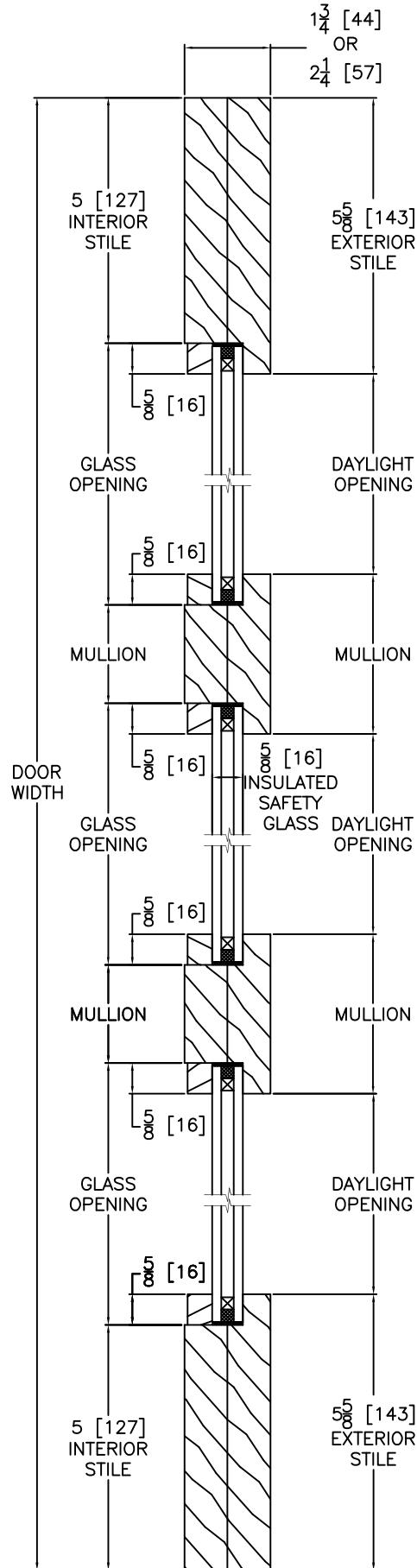
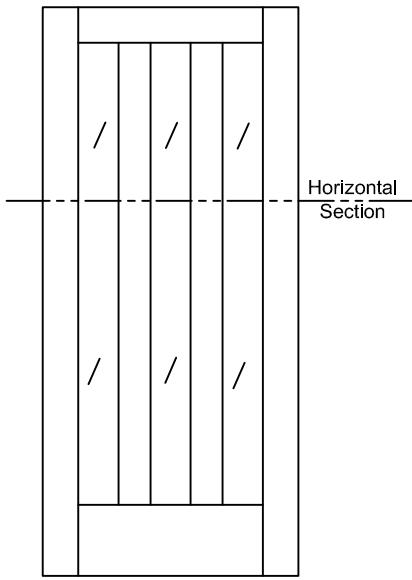

HORIZONTAL DOOR CROSS SECTION

Notes:
Stile, Rail, Panel & Glass
vary by Size & Model of Door.
Typical Sizes are Shown.

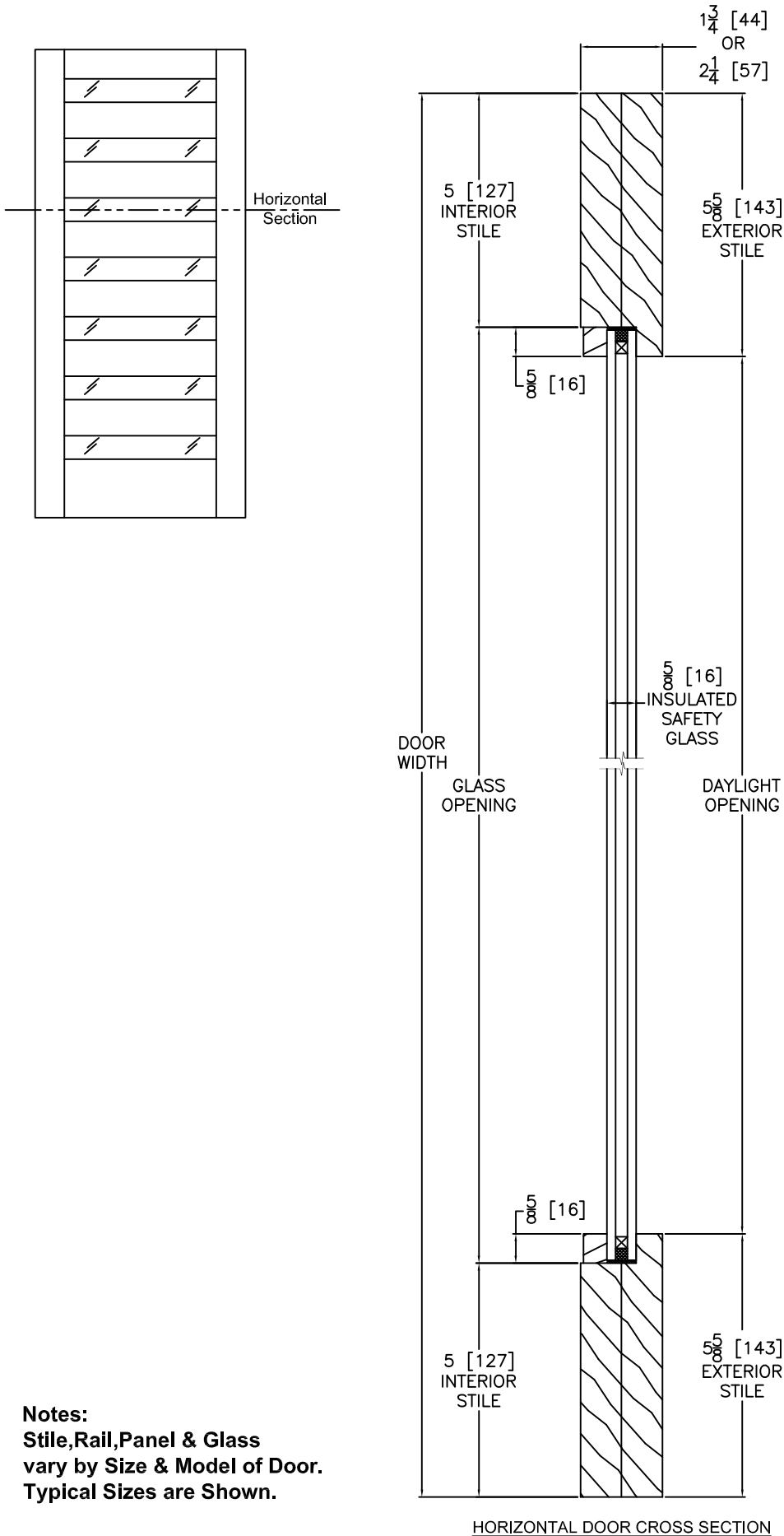

Notes:
Stile,Rail,Panel & Glass
vary by Size & Model of Door.
Typical Sizes are Shown.

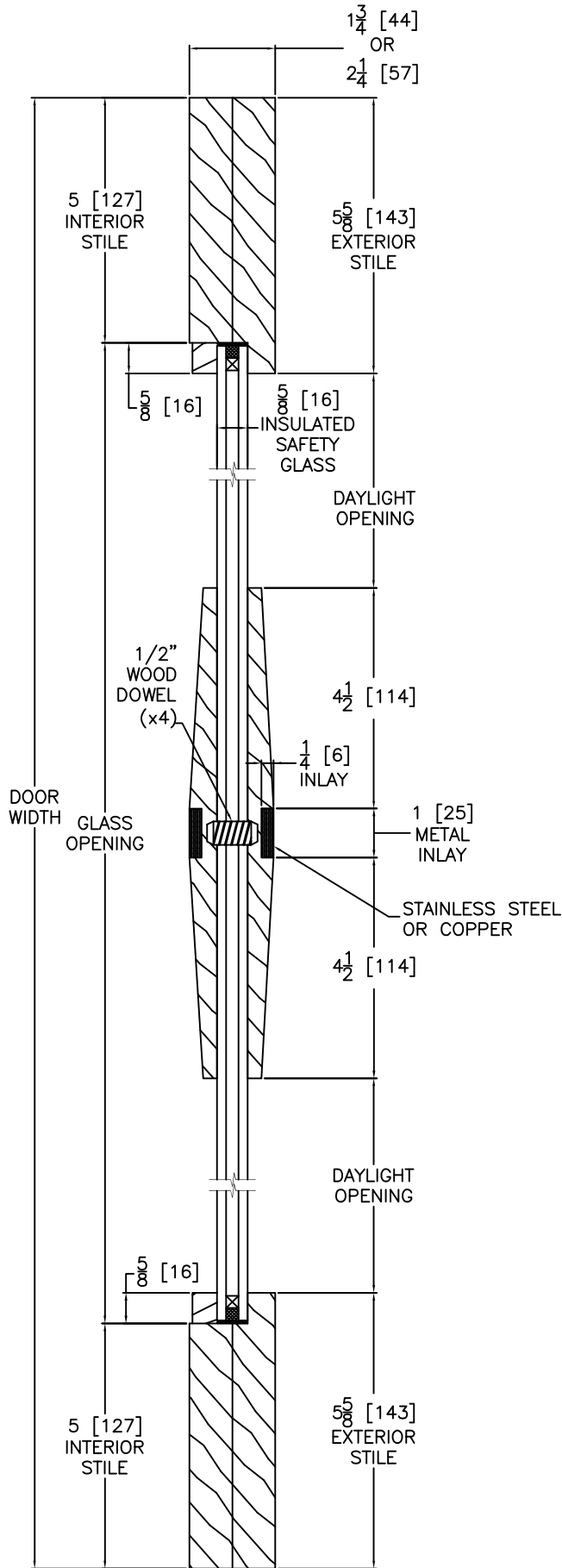
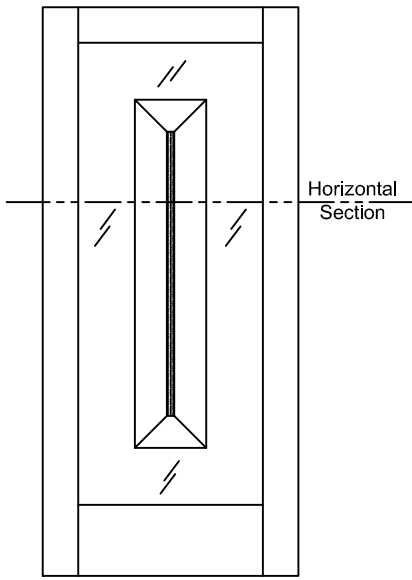

Notes:
Stile, Rail, Panel & Glass
vary by Size & Model of Door.
Typical Sizes are Shown.

HORIZONTAL DOOR CROSS SECTION

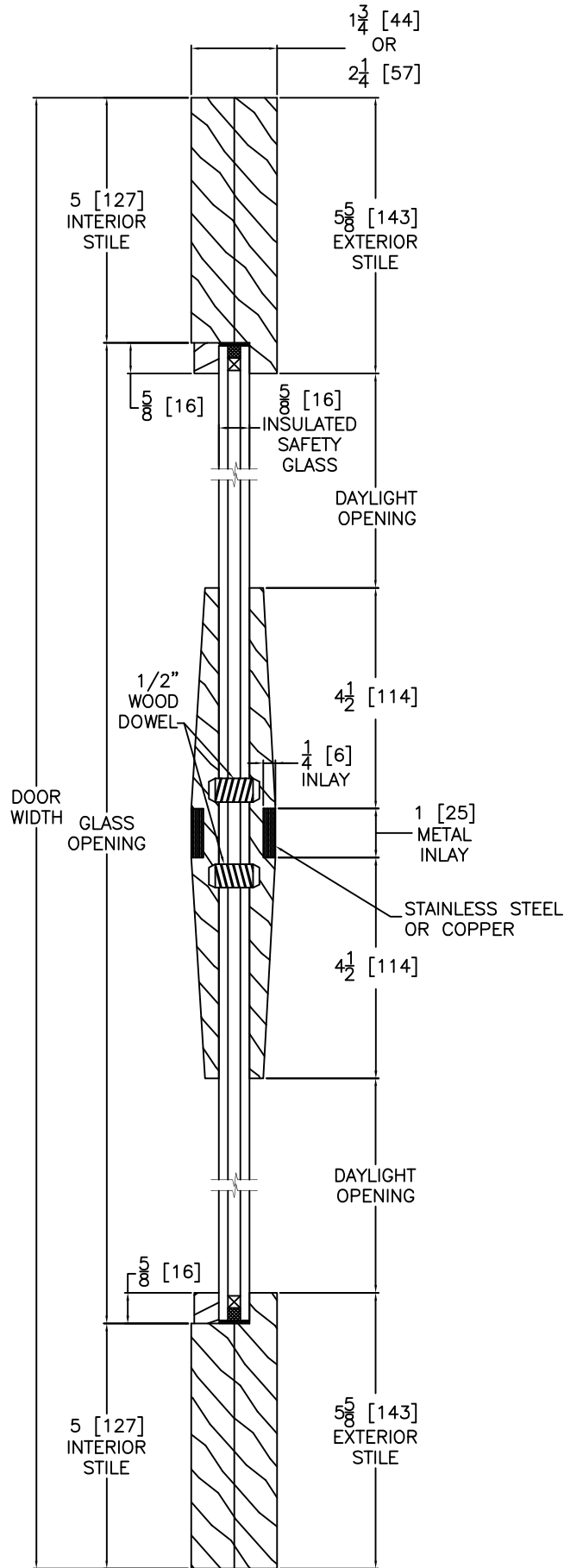
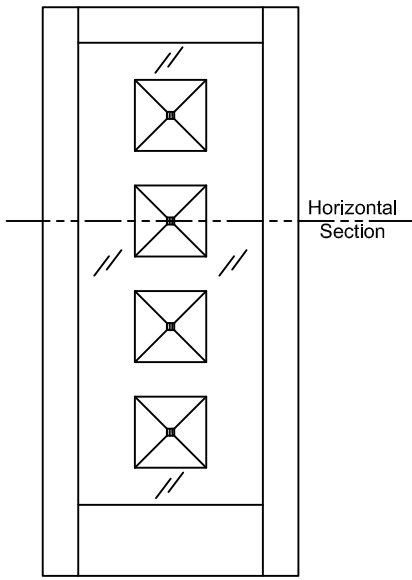

HORIZONTAL DOOR CROSS SECTION

Notes:
Stile, Rail, Panel & Glass
vary by Size & Model of Door.
Typical Sizes are Shown.

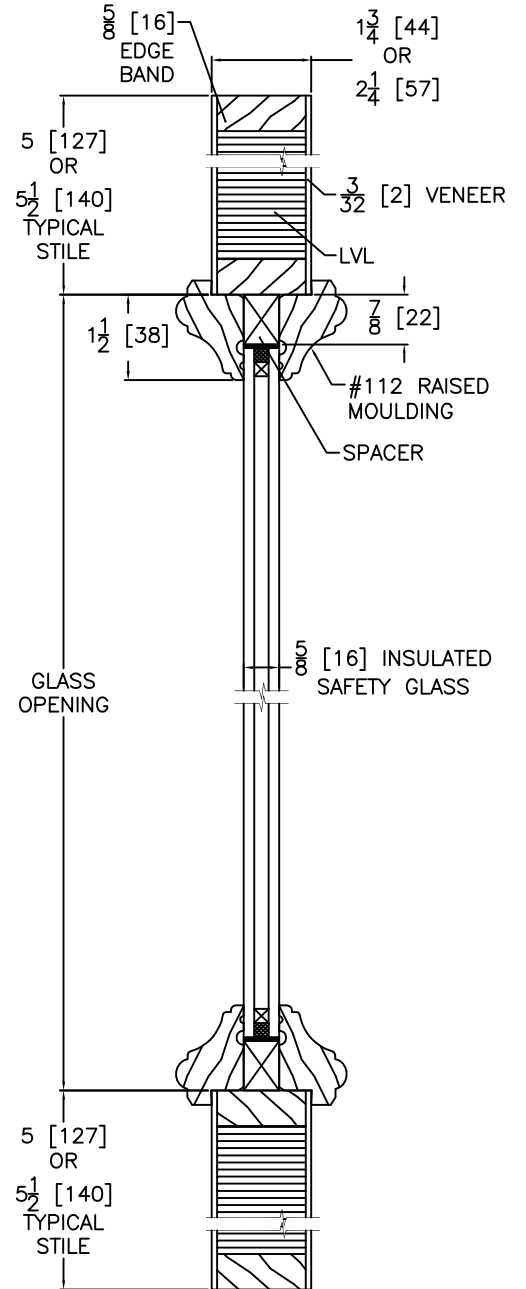
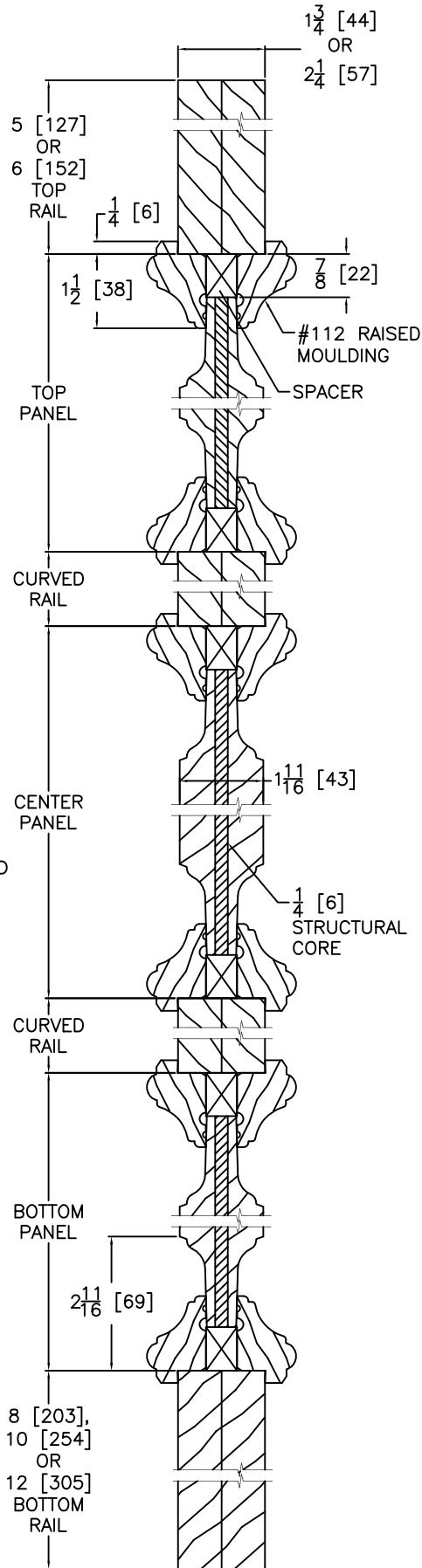
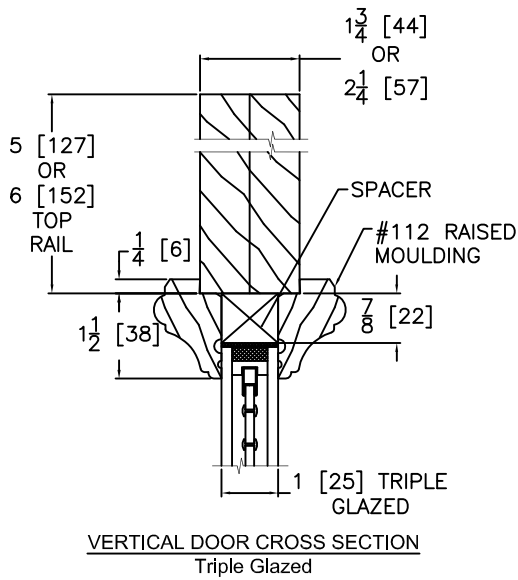
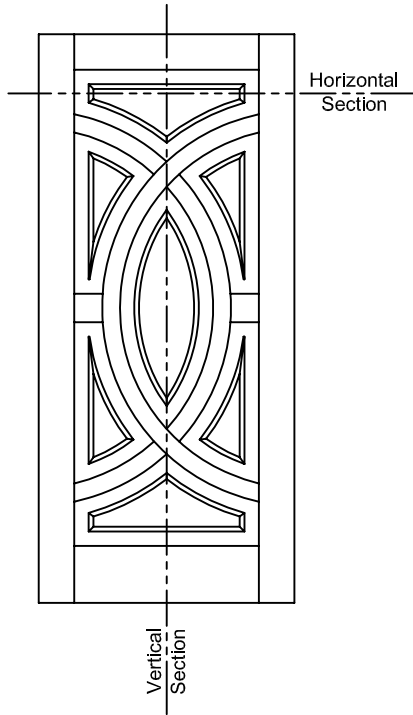

HORIZONTAL DOOR CROSS SECTION
Insulated Glass
Engineered Stile Option
(Upon Request or Doors > 3'-6" X 8'-0")

Notes:
Stile, Rail, Panel & Glass
vary by Size & Model of Door.
Typical Sizes are Shown.

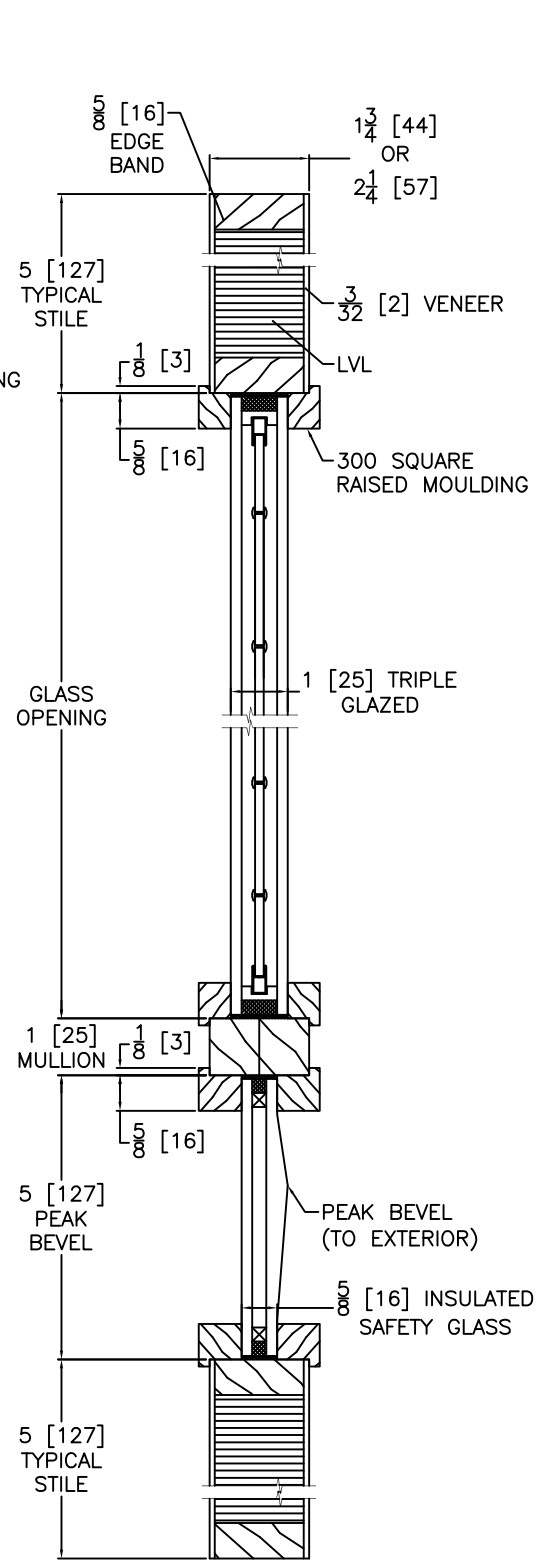
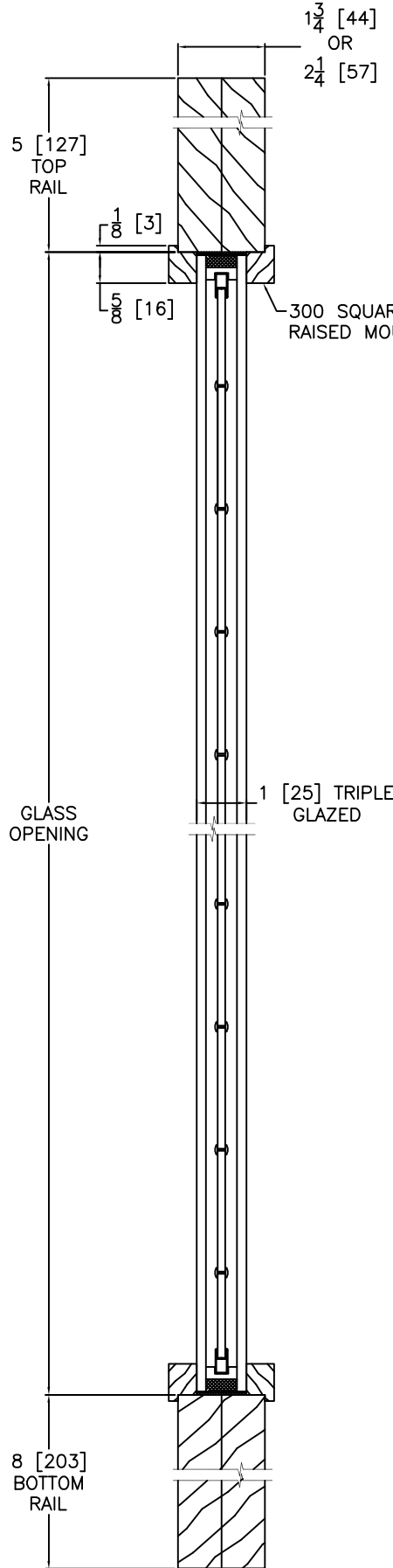
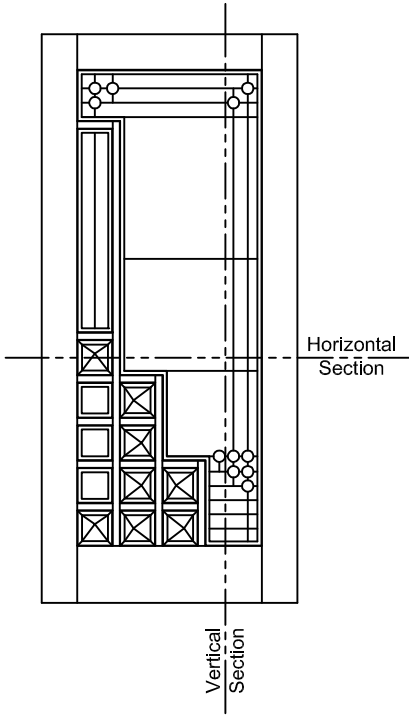

Notes:
Stile, Rail, Panel & Glass
vary by Size & Model of Door.
Typical Sizes are Shown.

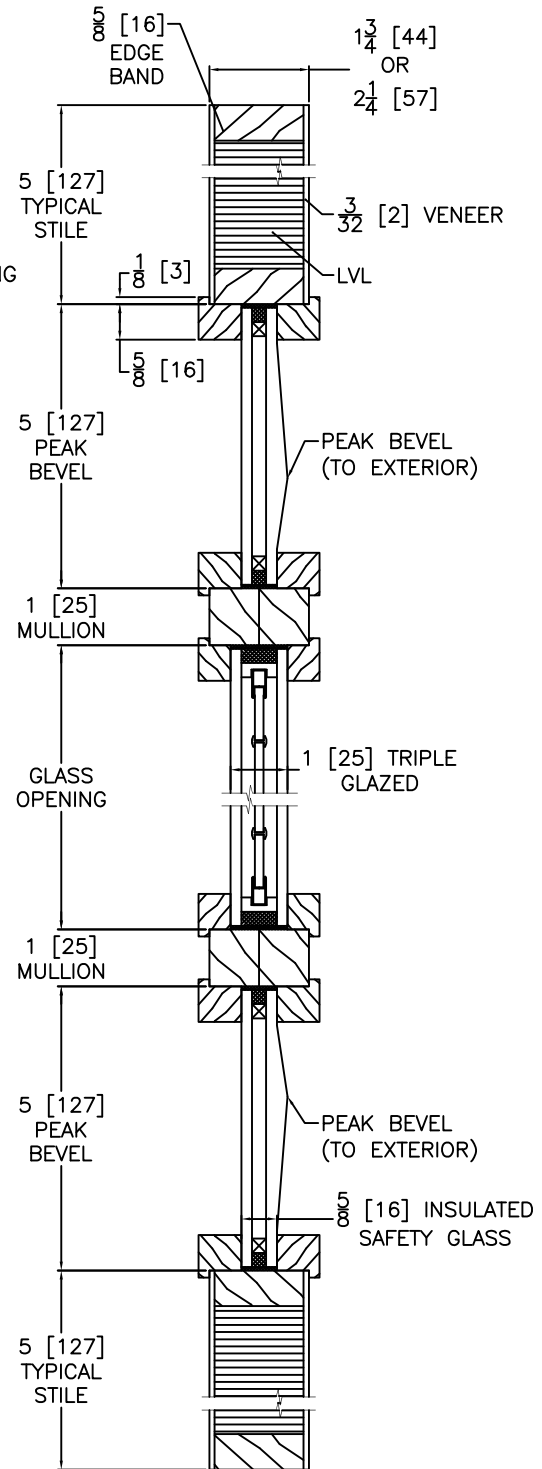
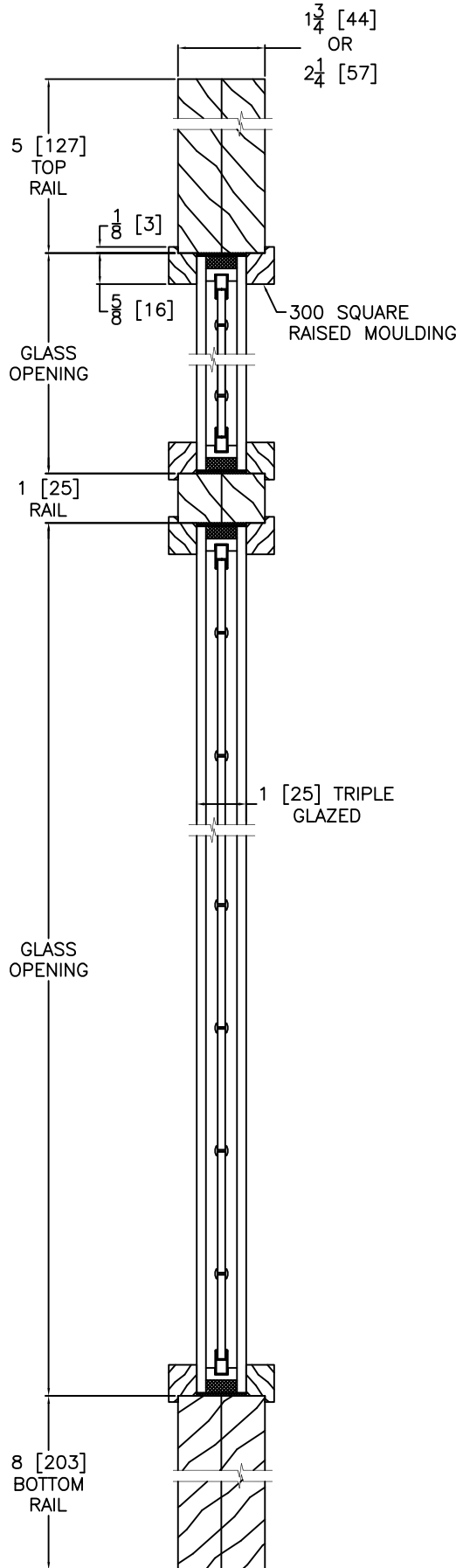
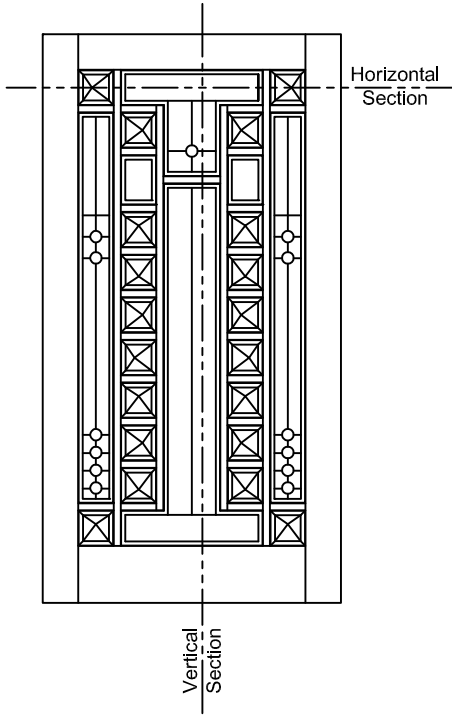

Notes:
Stile, Rail, Panel & Glass
vary by Size & Model of Door.
Typical Sizes are Shown.

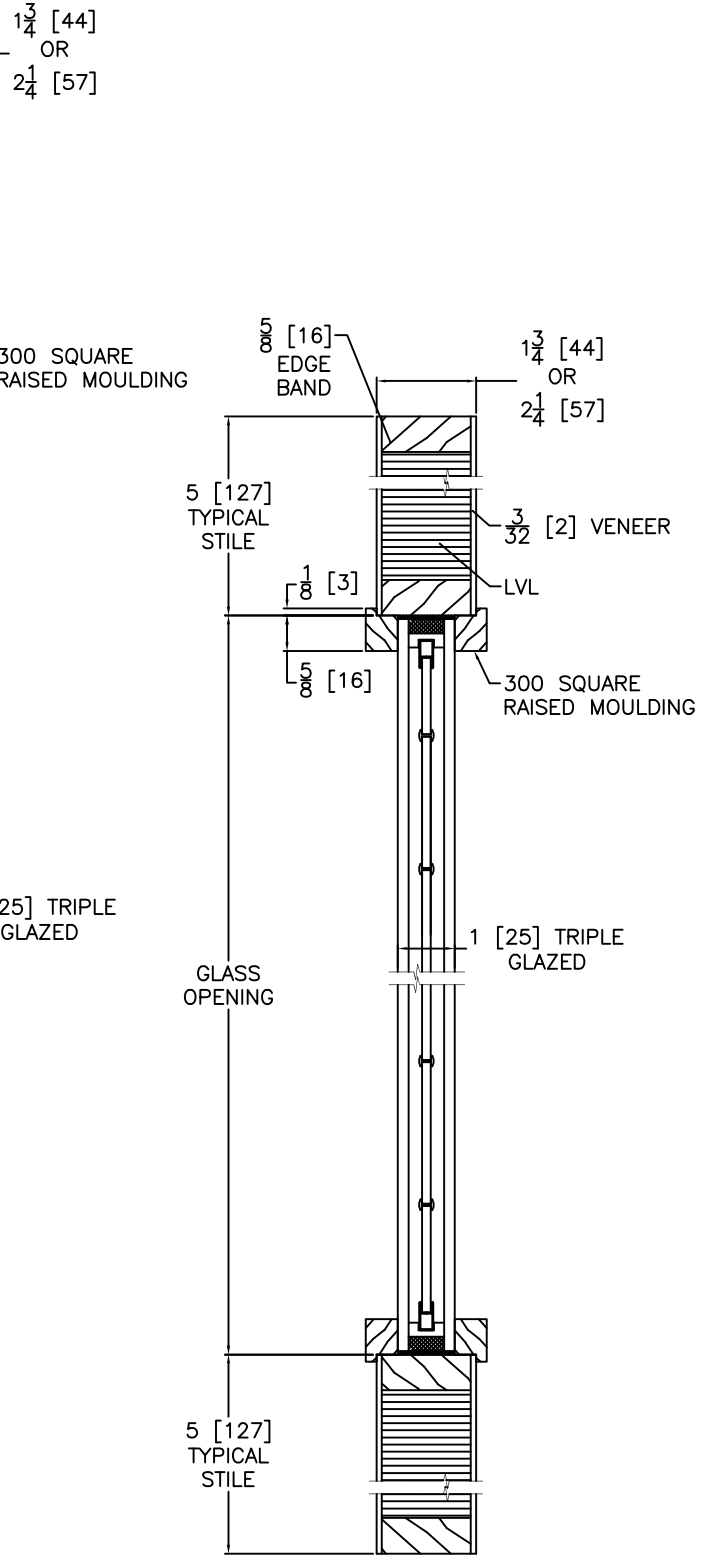
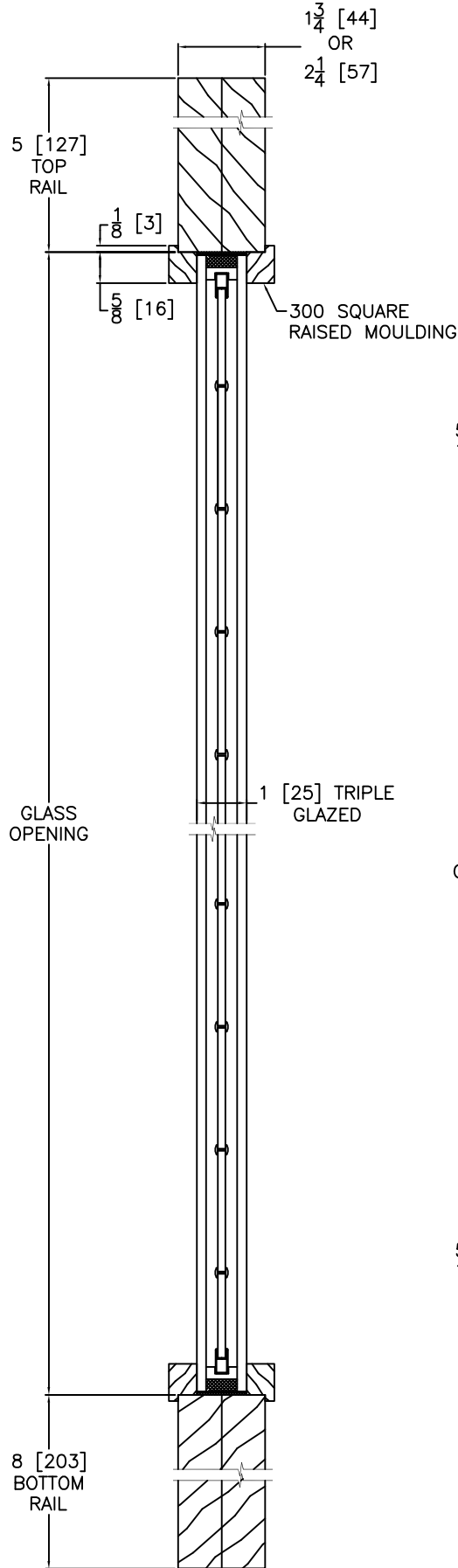
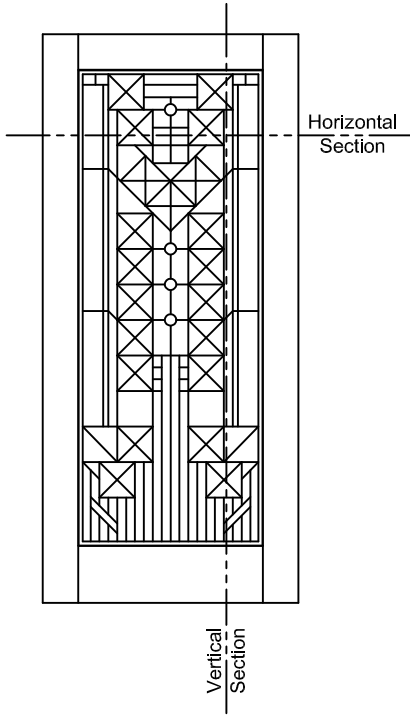

Notes:
Stile, Rail, Panel & Glass
vary by Size & Model of Door.
Typical Sizes are Shown.

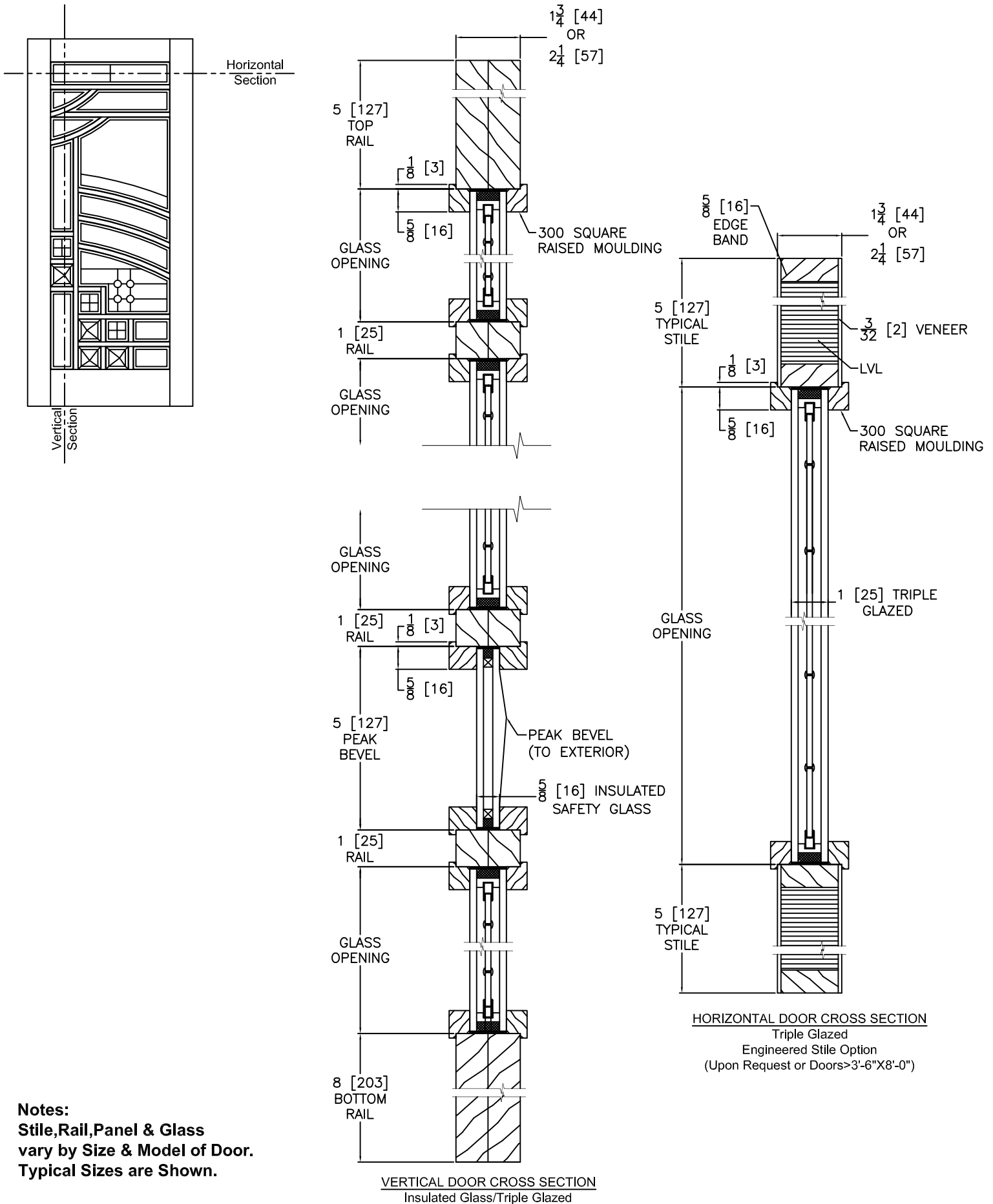

Notes:
Stile, Rail, Panel & Glass
vary by Size & Model of Door.
Typical Sizes are Shown.

VERTICAL DOOR CROSS SECTION
Insulated Glass/Triple Glazed

HORIZONTAL DOOR CROSS SECTION
Triple Glazed
Engineered Stile Option
(Upon Request or Doors >3'-6"X8'-0")

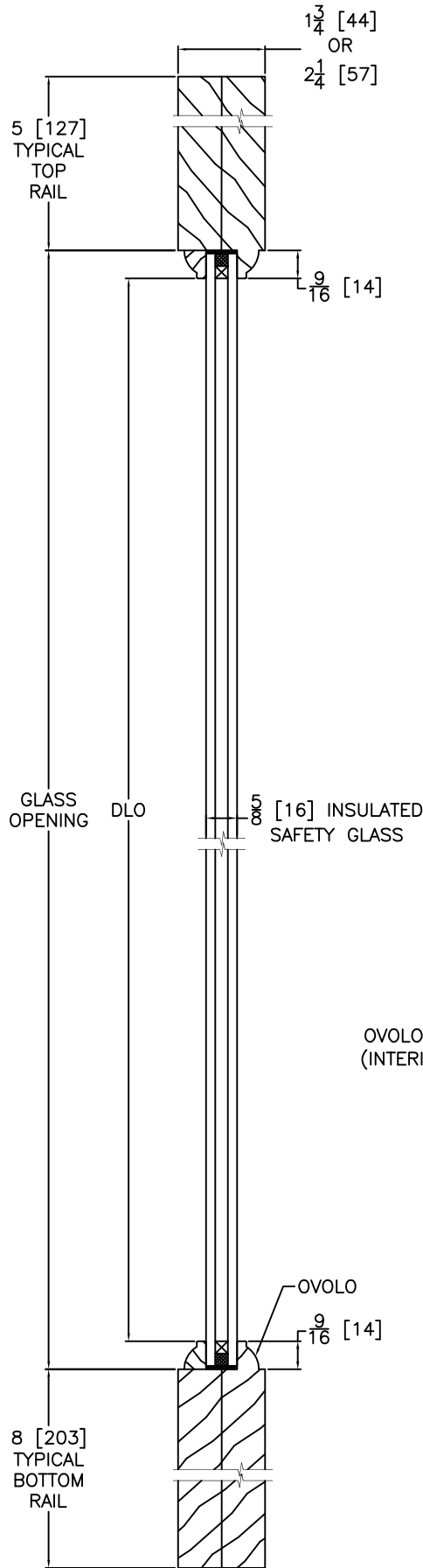
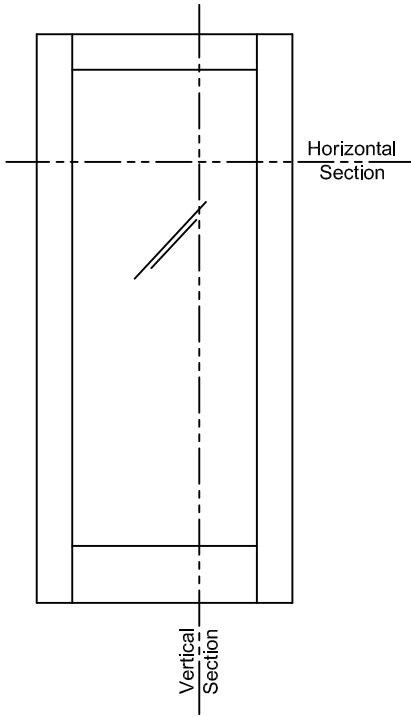

VERTICAL DOOR/SIDELIGHT CROSS SECTION
Insulated Glass

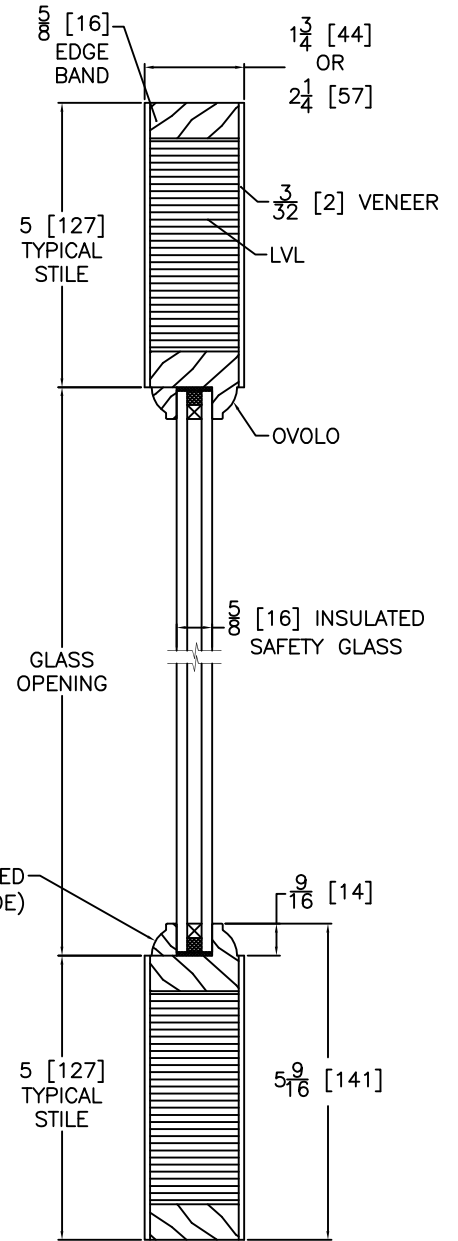

HORIZONTAL DOOR CROSS SECTION
Engineered Stile Option
(Upon Request or Doors > 3'-6" X 8'-0")

Notes:
Stile, Rail, Panel & Glass
vary by Size & Model of Door.
Typical Sizes are Shown.

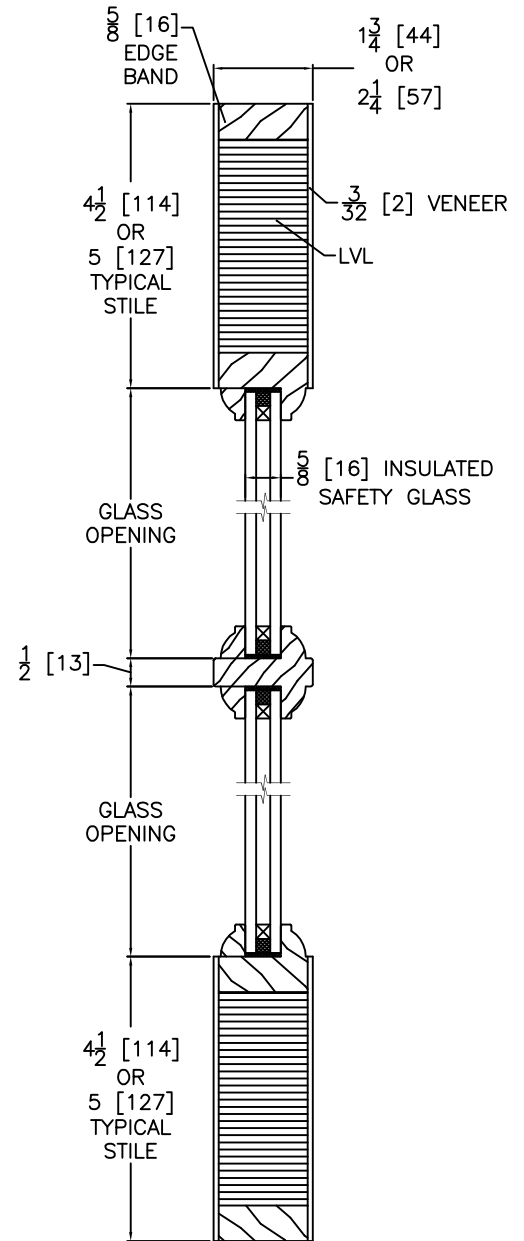
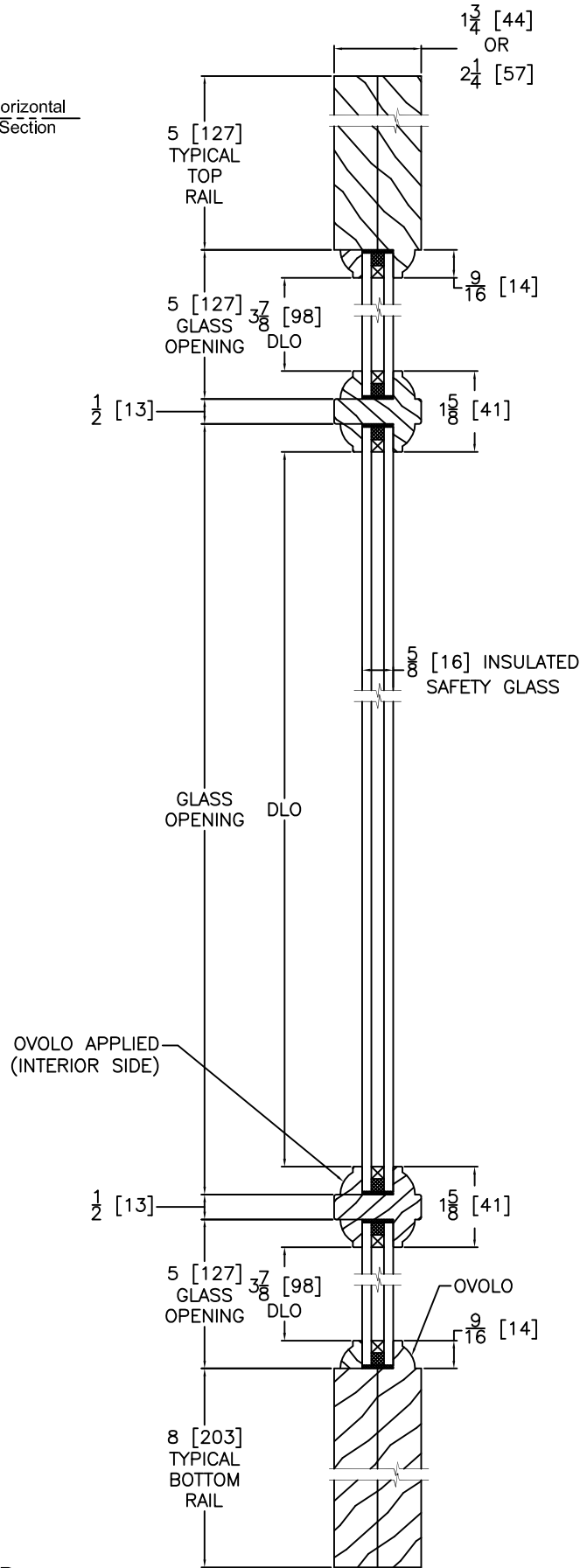
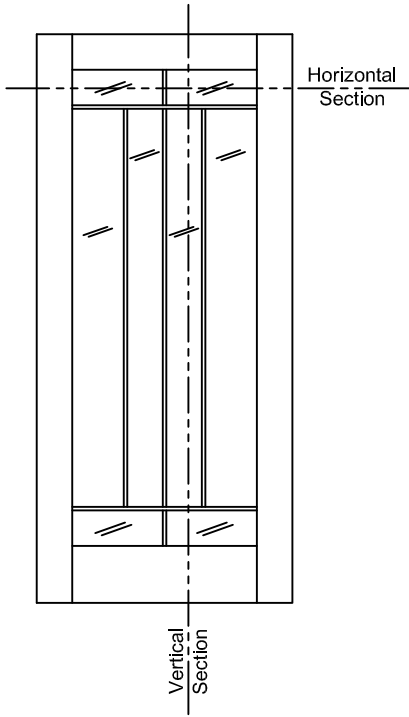

HORIZONTAL DOOR CROSS SECTION
Engineered Stile Option
(Upon Request or Doors >3'-6" X 8'-0")

Notes:
Stile, Rail, Panel & Glass
vary by Size & Model of Door.
Typical Sizes are Shown.

VERTICAL DOOR/SIDELIGHT CROSS SECTION
Insulated Glass

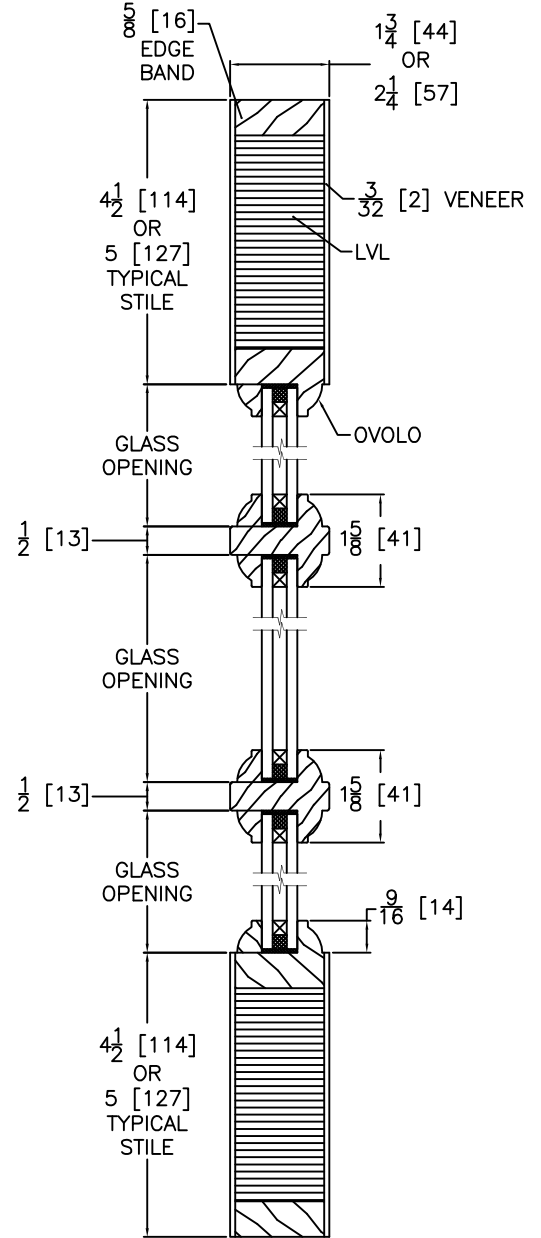
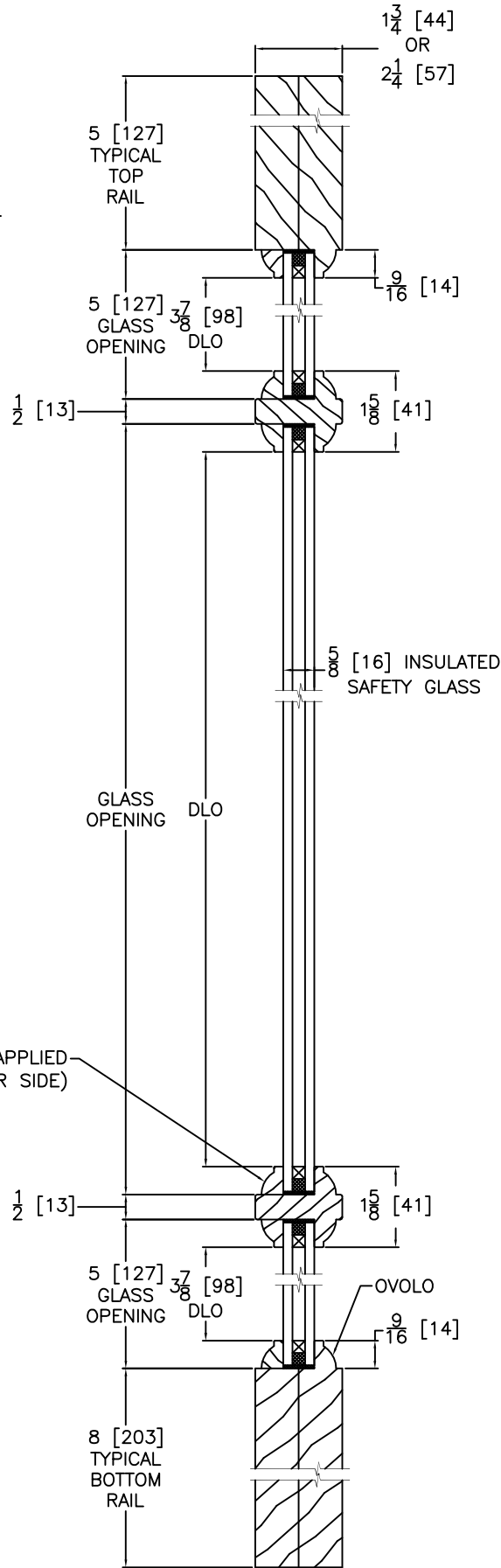
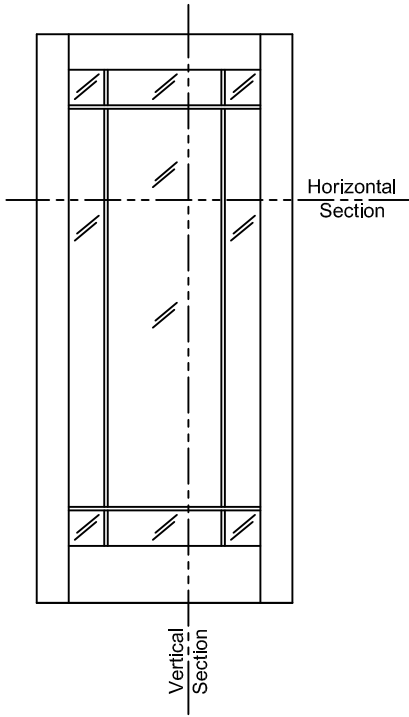

HORIZONTAL DOOR CROSS SECTION
Engineered Stile Option
(Upon Request or Doors > 3'-6" X 8'-0")

Notes:
Stile, Rail, Panel & Glass
vary by Size & Model of Door.
Typical Sizes are Shown.

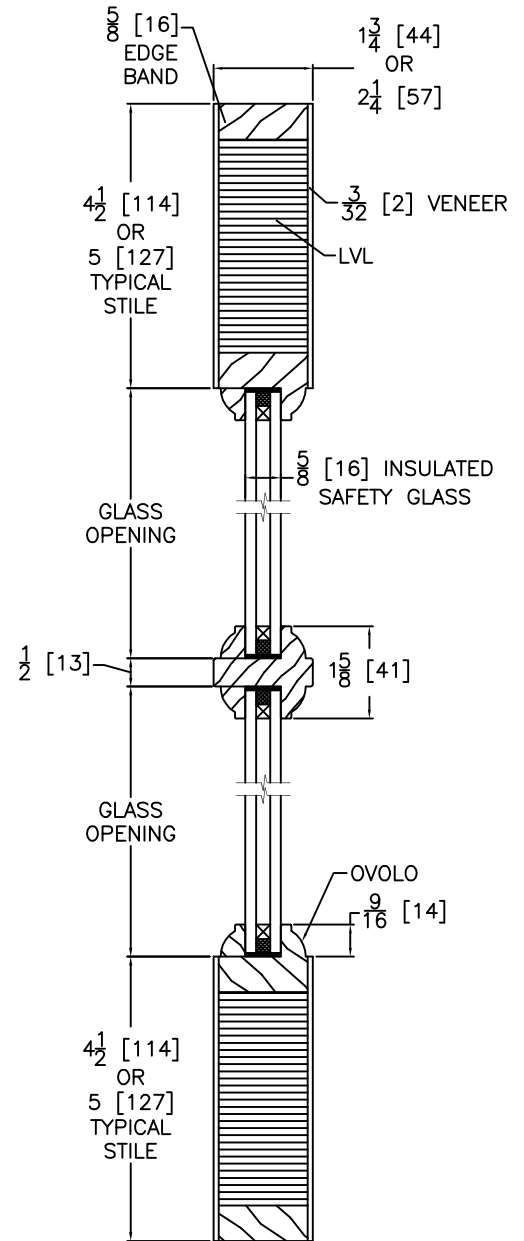
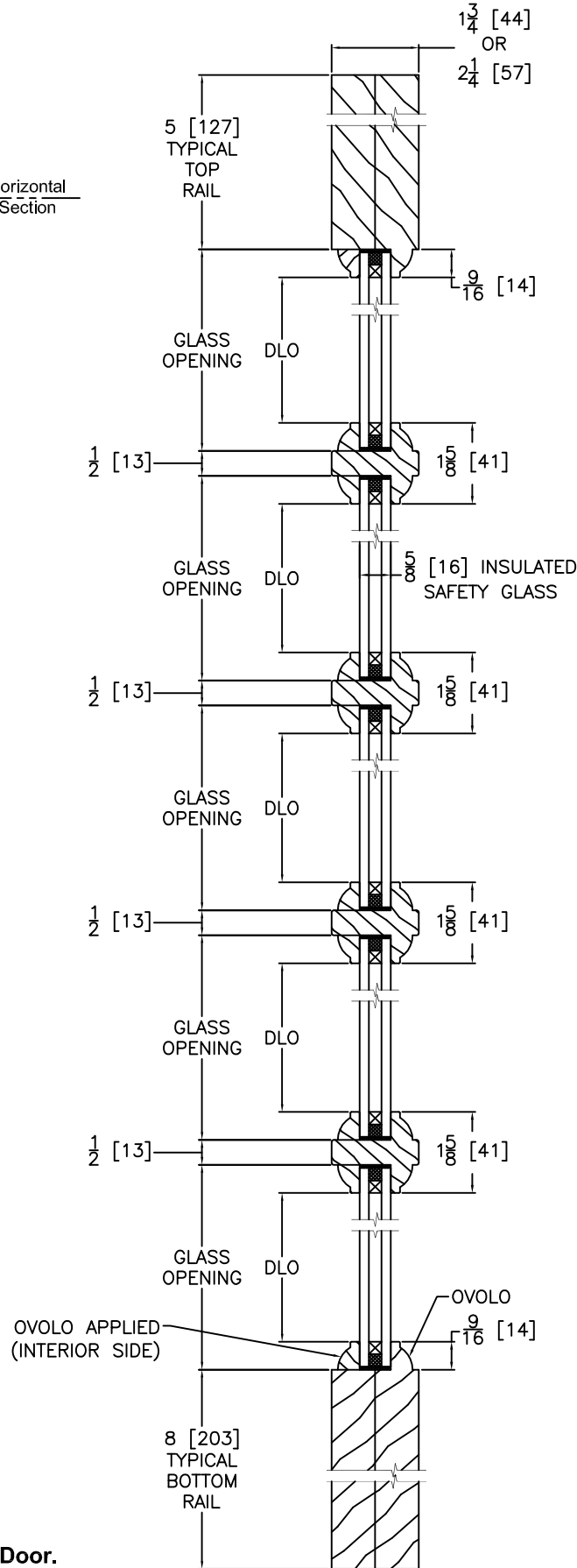
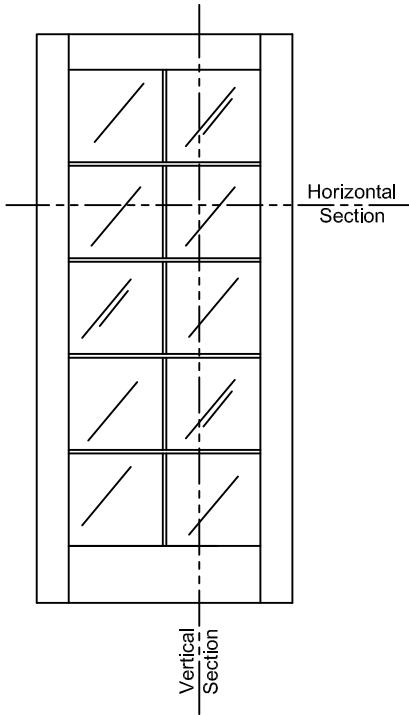

HORIZONTAL DOOR CROSS SECTION
Engineered Stile Option
(Upon Request or Doors > 3'-6" X 8'-0")

Notes:
Stile, Rail, Panel & Glass
vary by Size & Model of Door.
Typical Sizes are Shown.

VERTICAL DOOR/SIDELIGHT CROSS SECTION
Insulated Glass

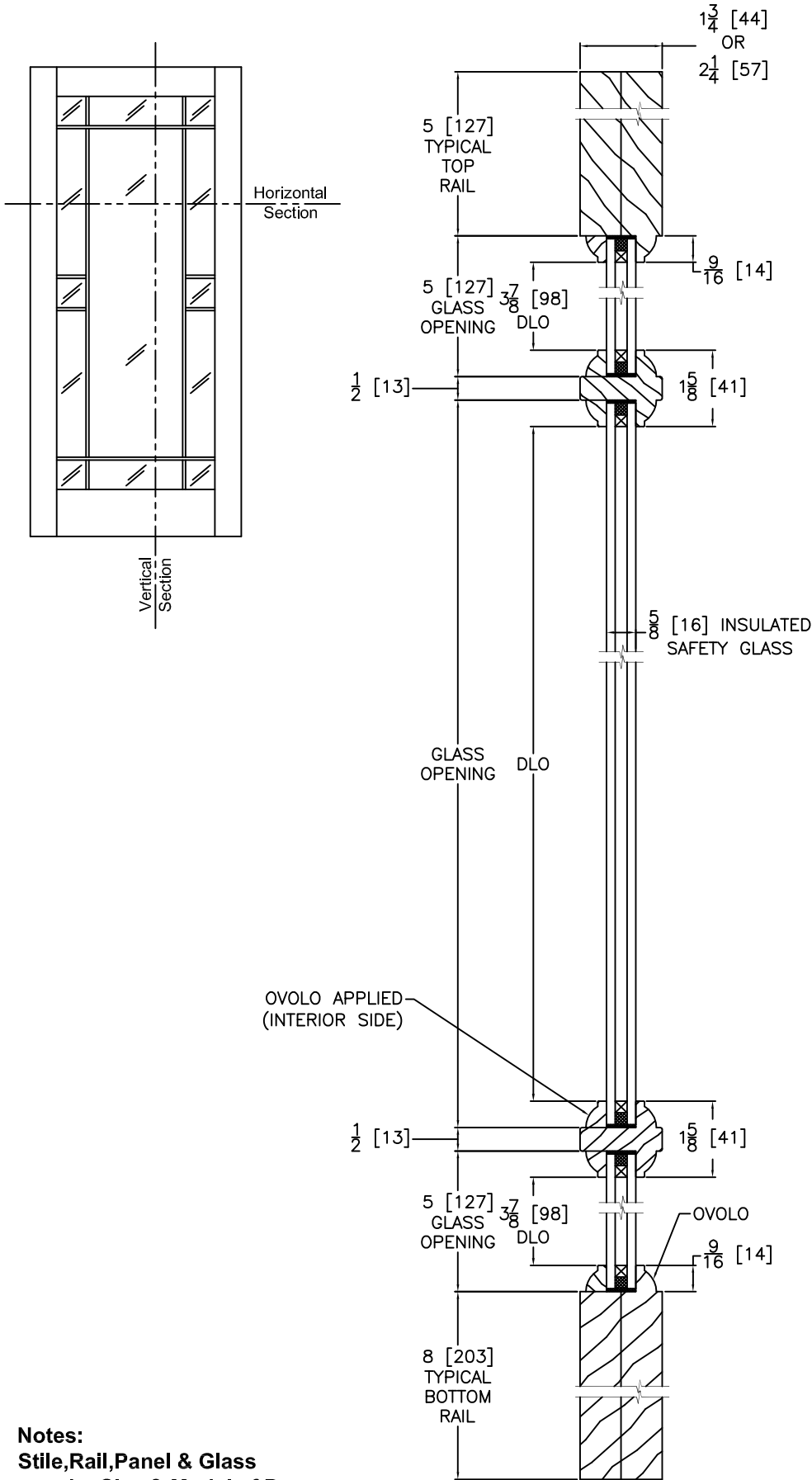

VERTICAL DOOR/SIDELIGHT CROSS SECTION
Insulated Glass

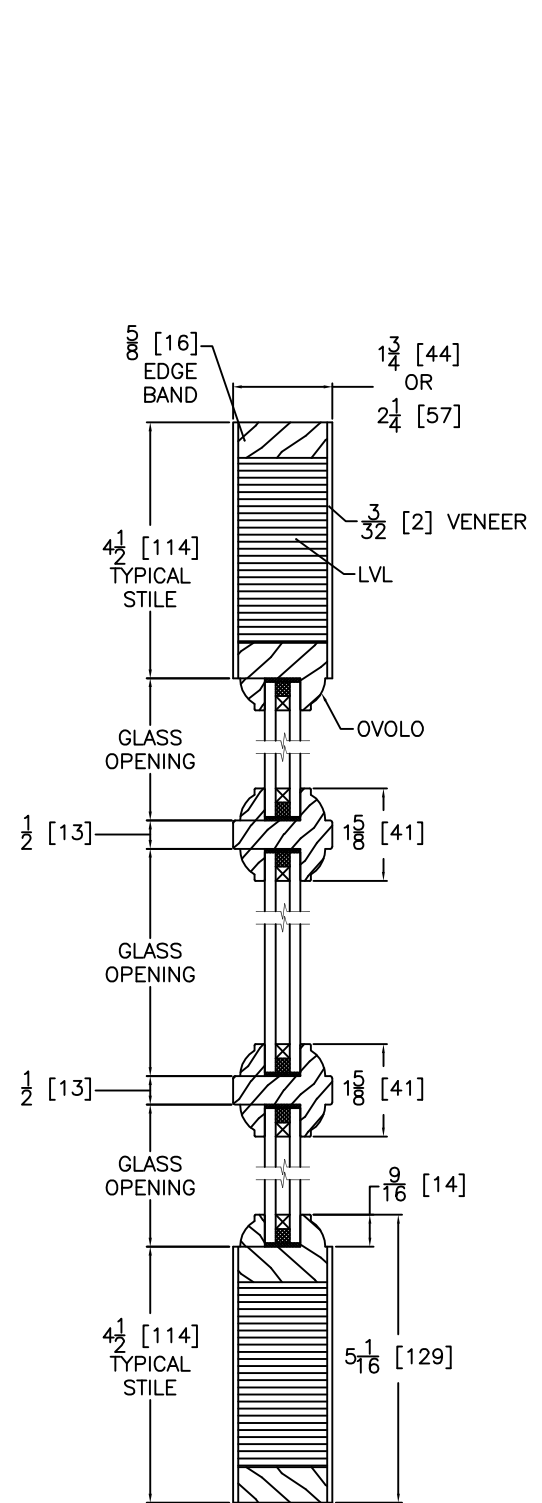

HORIZONTAL DOOR CROSS SECTION
Engineered Stile Option
(Upon Request or Doors > 3'-6" X 8'-0")

Notes:
Stile, Rail, Panel & Glass
vary by Size & Model of Door.
Typical Sizes are Shown.

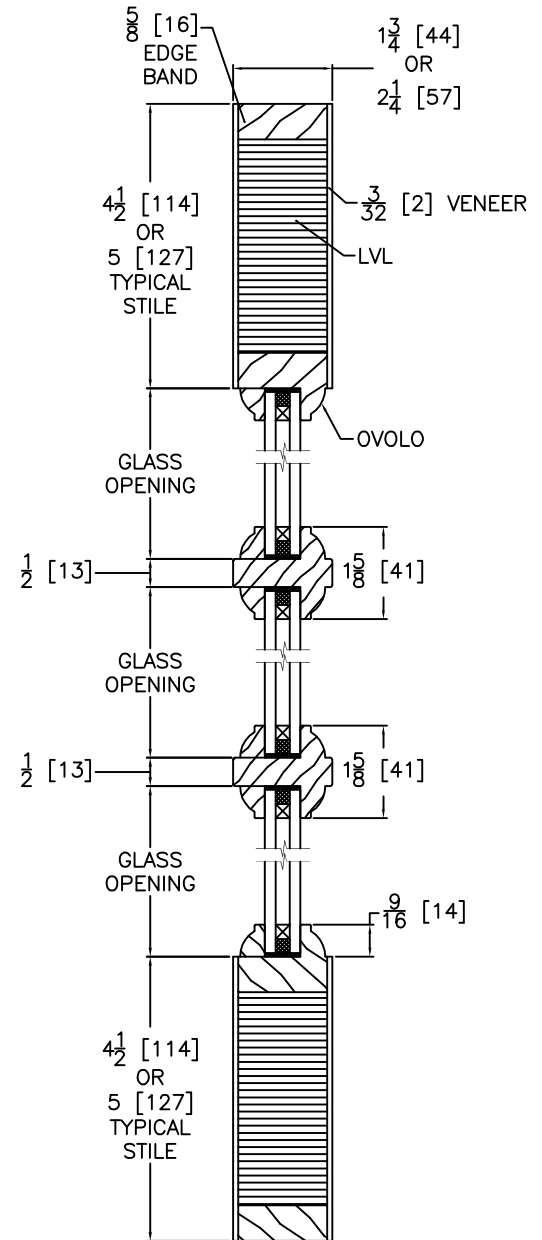
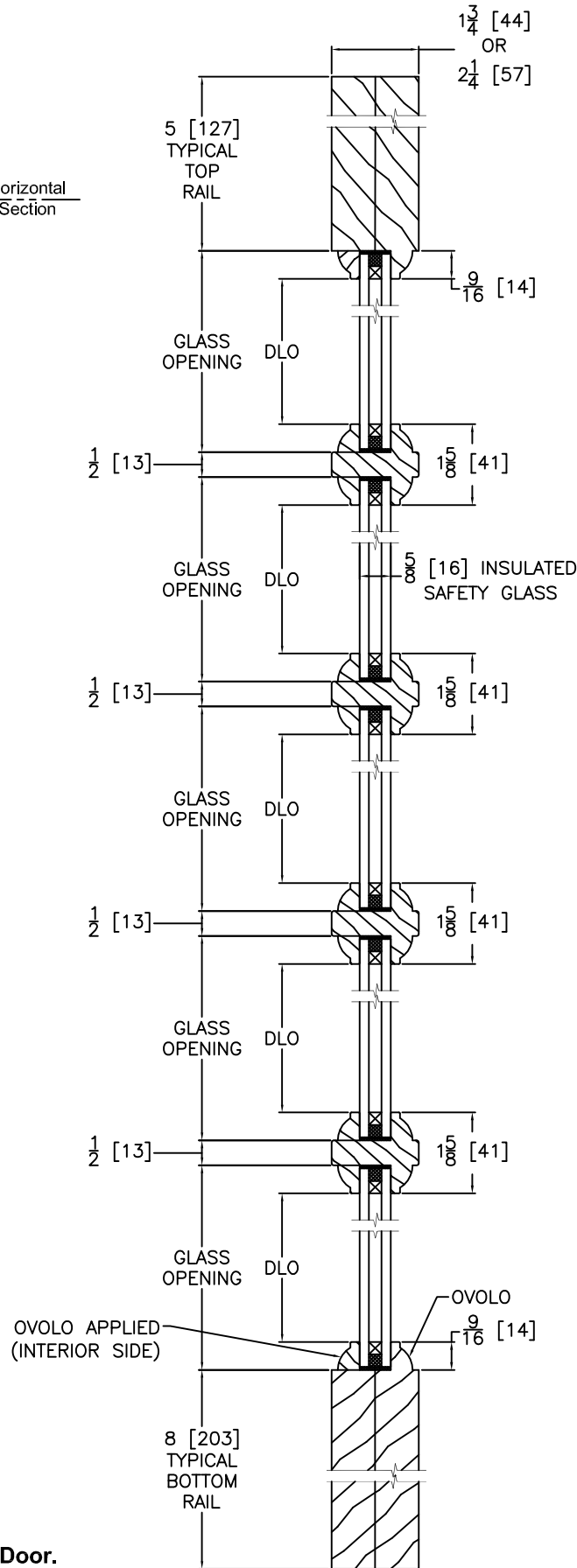
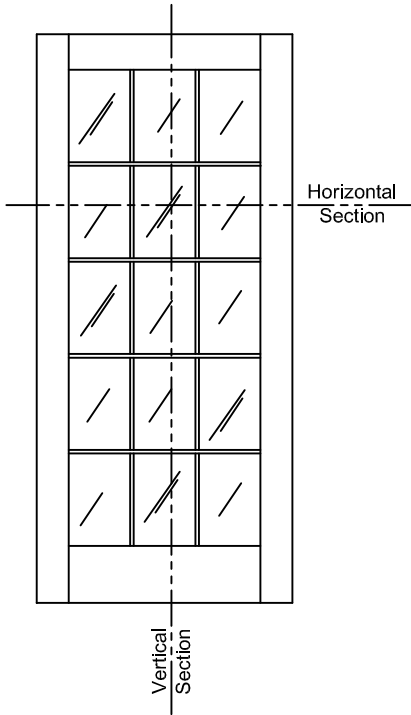

HORIZONTAL DOOR CROSS SECTION
Engineered Stile Option
(Upon Request or Doors > 3'-6" X 8'-0")

Notes:
Stile, Rail, Panel & Glass
vary by Size & Model of Door.
Typical Sizes are Shown.

VERTICAL DOOR/SIDELIGHT CROSS SECTION
Insulated Glass

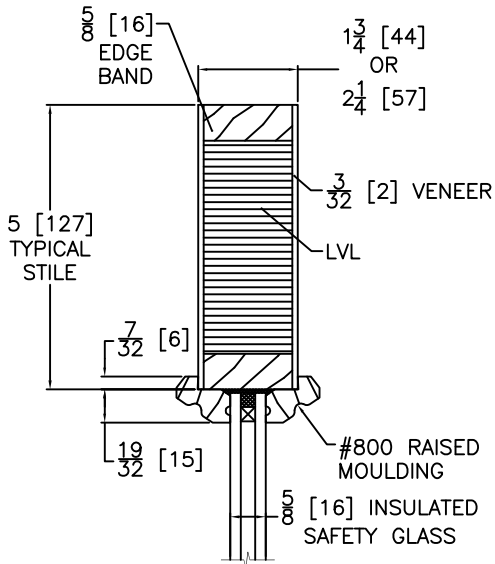
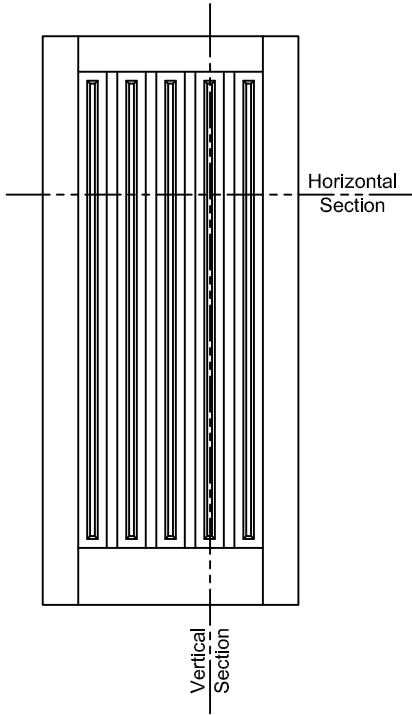

HORIZONTAL DOOR CROSS SECTION
Insulated Glass
Engineered Stile Option
(Upon Request or Doors >3'-6" X 8'-0")

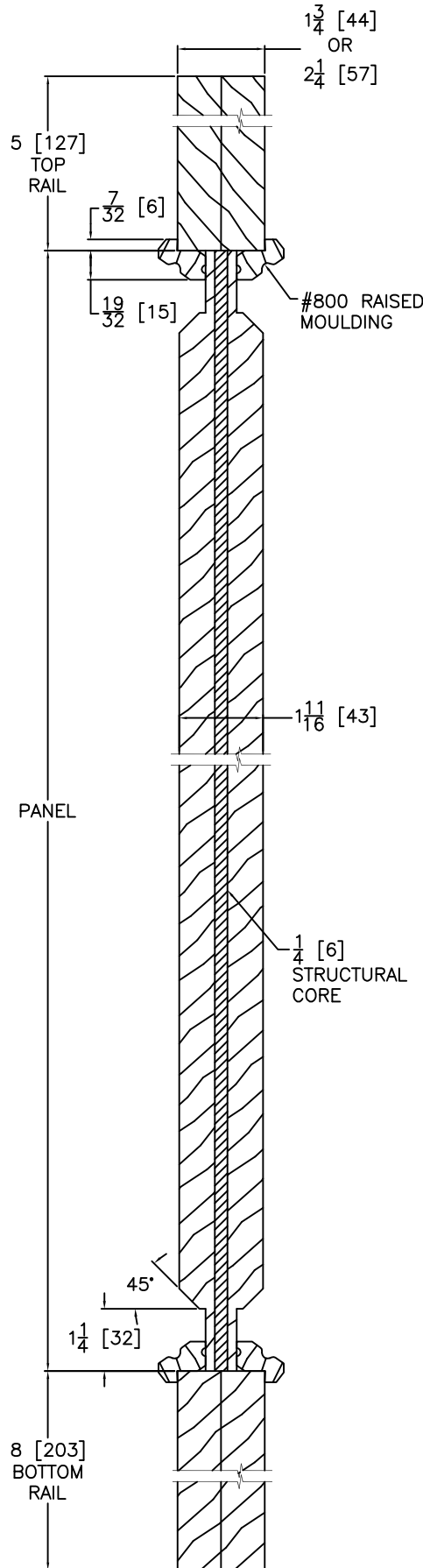

VERTICAL DOOR CROSS SECTION

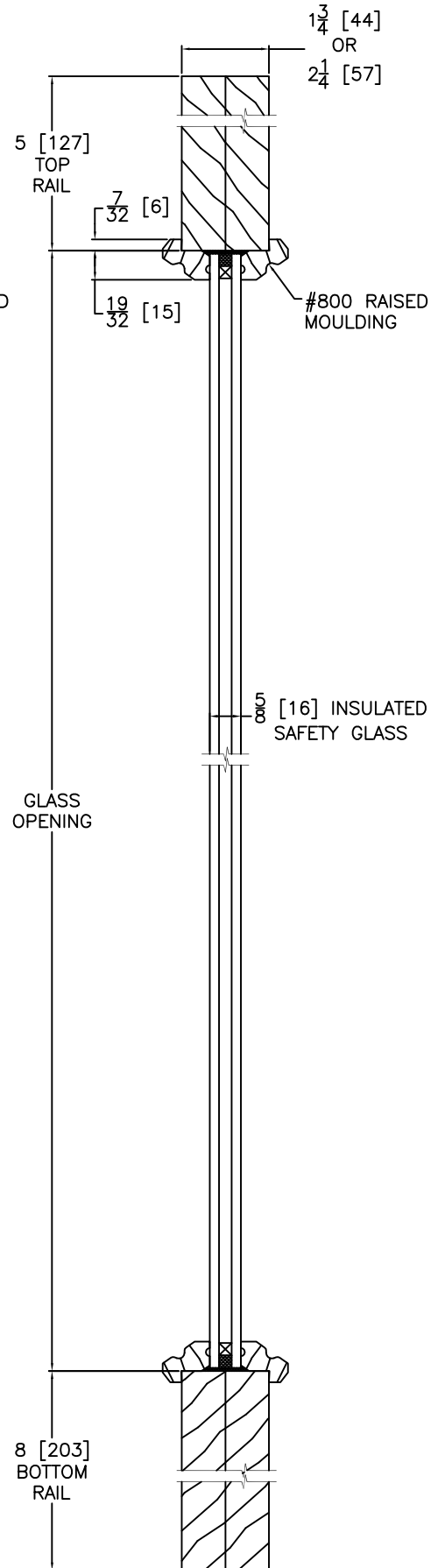

VERTICAL DOOR/SIDELIGHT CROSS SECTION
Insulated Glass

Notes:
Stile, Rail, Panel & Glass
vary by Size & Model of Door.
Typical Sizes are Shown.

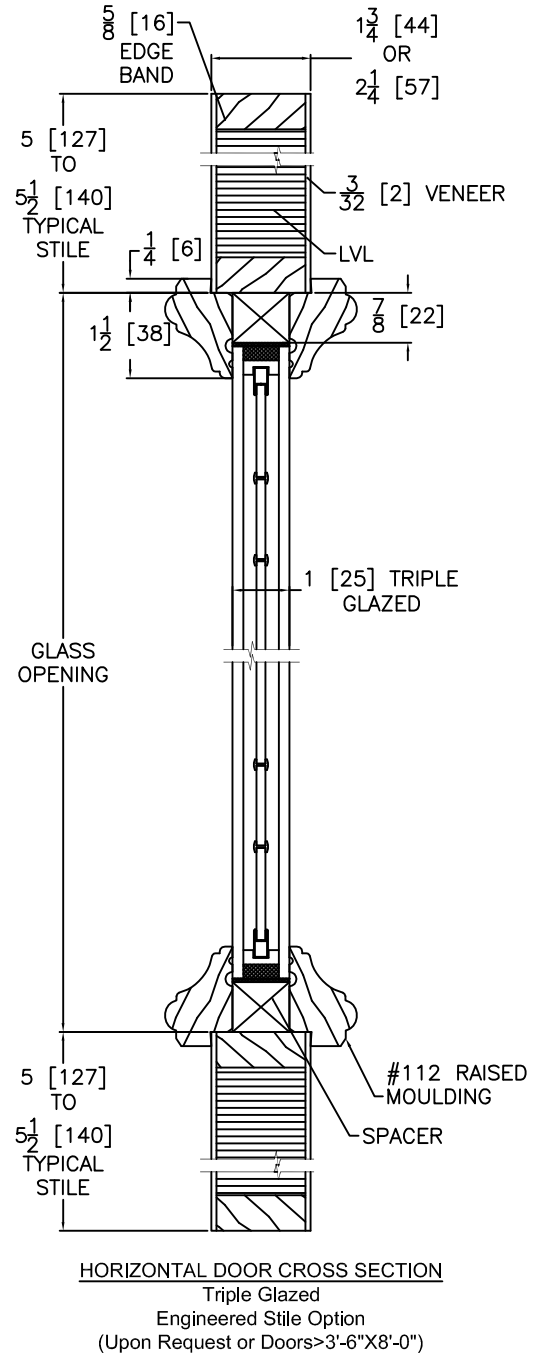
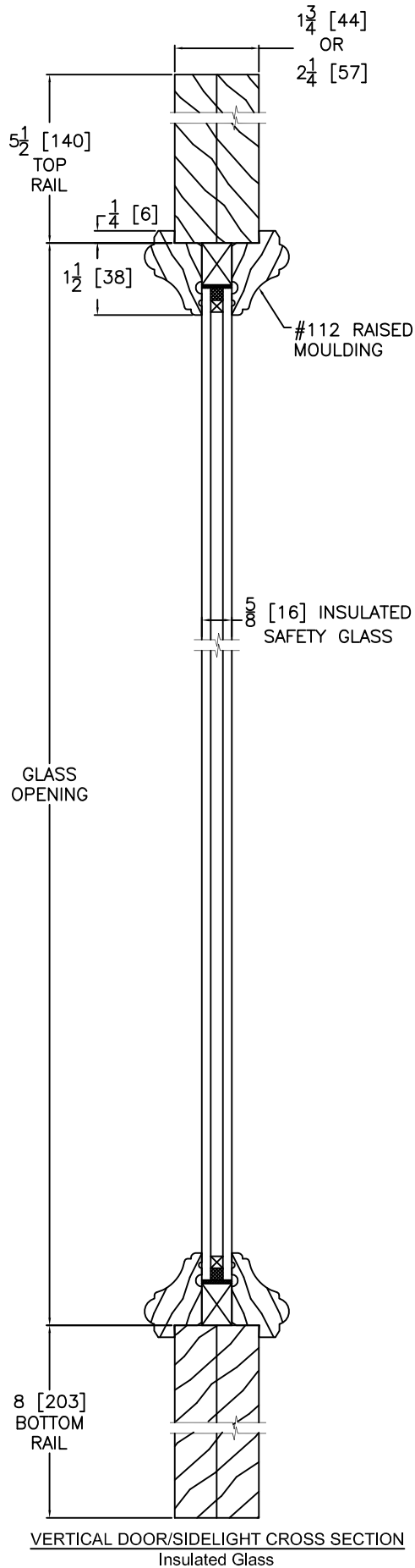
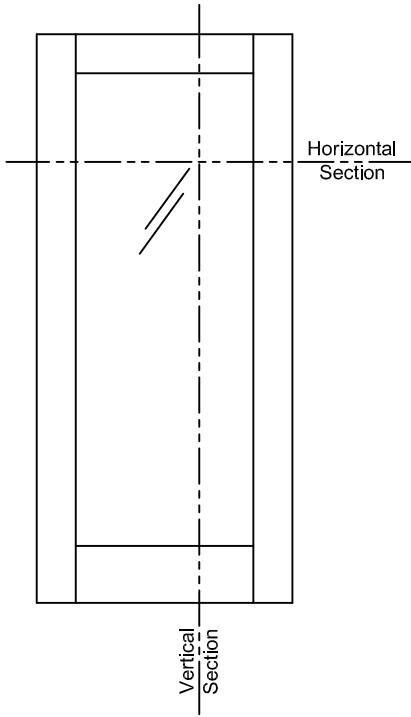

Notes:
Stile, Rail, Panel & Glass
vary by Size & Model of Door.
Typical Sizes are Shown.

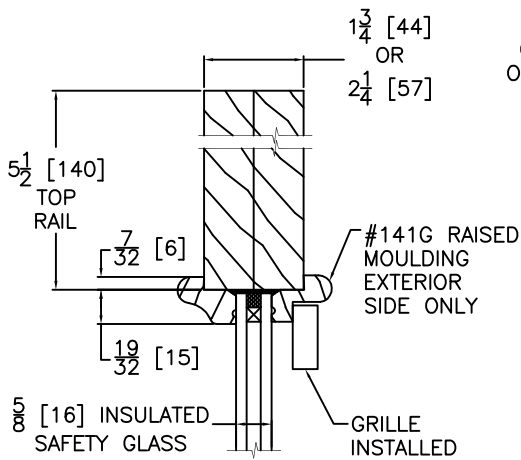
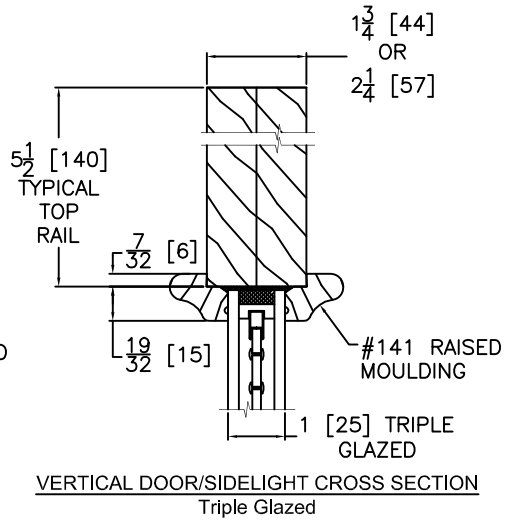
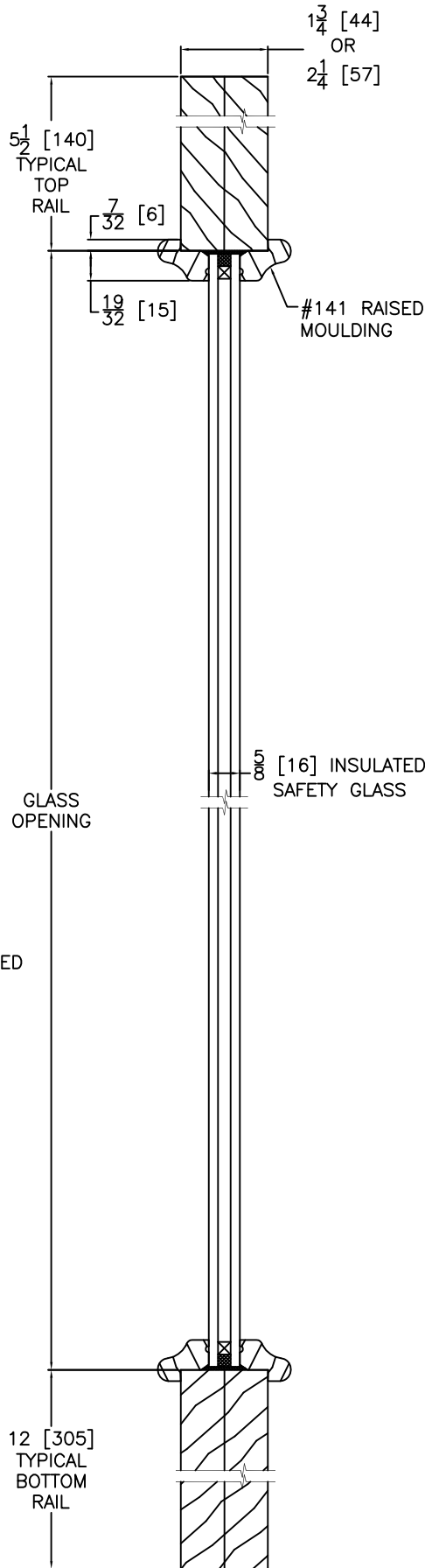
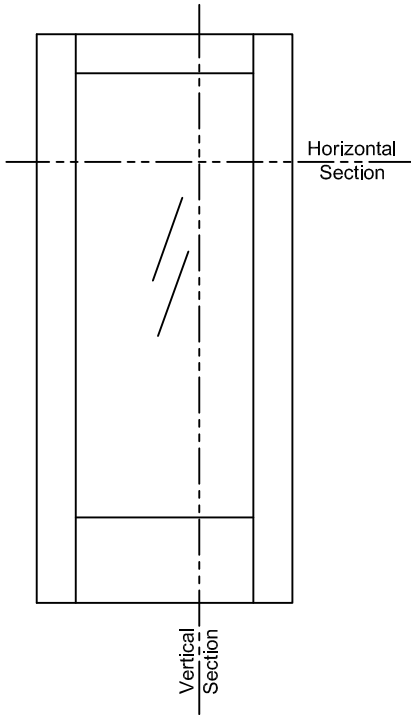

VERTICAL DOOR/SIDELIGHT CROSS SECTION
For INSET Grille Application
(Florence & Rustic Grilles are Stile-Mounted)

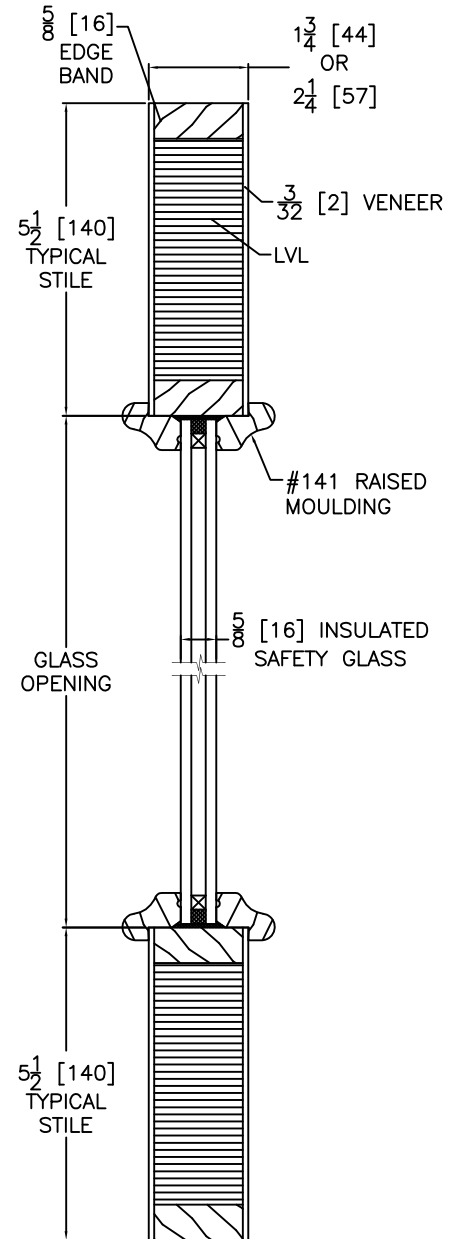

Notes:
Stile, Rail, Panel & Glass
vary by Size & Model of Door.
Typical Sizes are Shown.

VERTICAL DOOR/SIDELIGHT CROSS SECTION
Insulated Glass

HORIZONTAL DOOR CROSS SECTION
Engineered Stile Option
(Upon Request or Doors > 3'-6" X 8'-0")

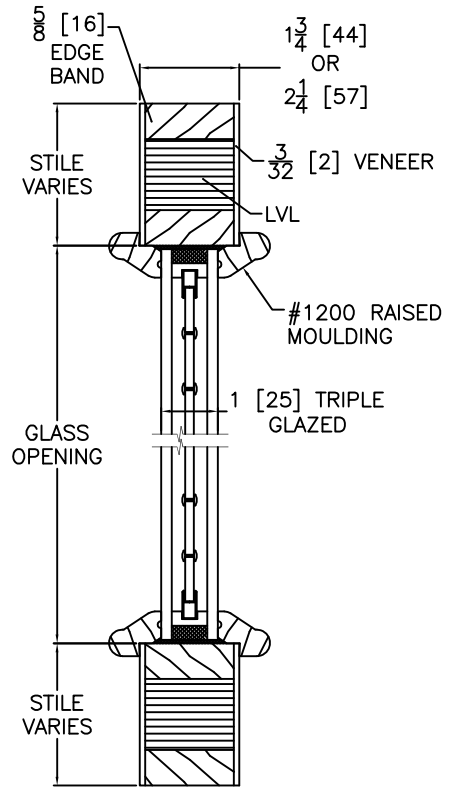
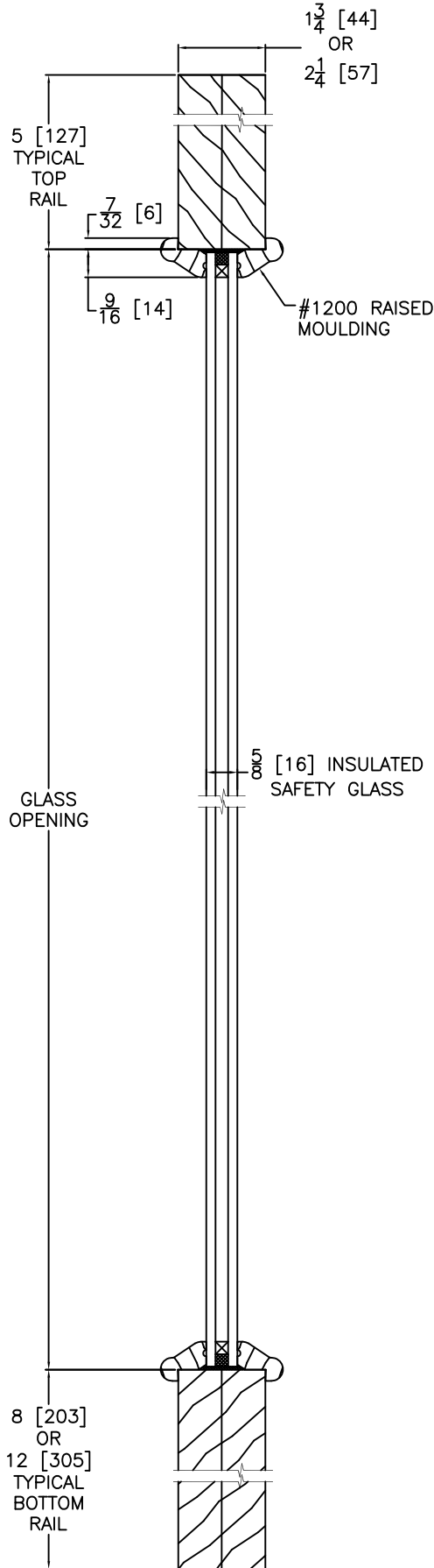
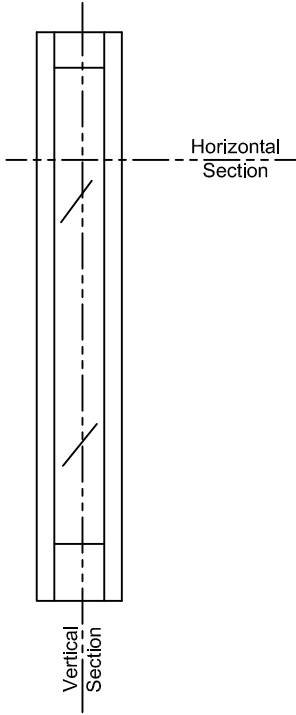

HORIZONTAL SIDELIGHT CROSS SECTION
Triple Glazed
Engineered Stile Option
(Upon Request or Doors >3'-6" X 8'-0")

VERTICAL SIDELIGHT CROSS SECTION
Insulated Glass

Notes:
Stile, Rail, Panel & Glass
vary by Size & Model of Door.
Typical Sizes are Shown.