

---

**TABLE OF CONTENTS**

---

Specifications .....	4-2
Quick Spec Guide .....	4-4
Elevations/Sizes: 1/4" Scale .....	4-6
Awning .....	4-8
Glazing Options: 3" Scale .....	4-19
Trim Options: 3" Scale .....	4-21
Jamb Options: 3" Scale .....	4-22
Standard Mullion Options .....	4-23
Lite Cut Information .....	4-24
Vent Projections .....	4-27
Unit Sizing, Rough Openings & Masonry Openings .....	4-28
Section Details: 6" Scale .....	4-29

**PRODUCT SPECIFICATIONS****EXTERIOR FINISH**

All exterior surfaces completely covered with factory-applied latex primer. Natural exterior (no primer) available as an option.

**AURALAST® WOOD**

AuraLast® wood is fundamentally different from wood resulting from traditional millwork preservation processes in that it uses a proprietary vacuum/pressure process to provide protection throughout the wood parts used to make windows and doors. AuraLast® wood is distinguished from wood using the current preservation methods by its unique ability to achieve greater penetration of the active ingredients into the wood parts, with a penetration of the treatment being a minimum of 92%.

**INTERIOR FINISH**

All interior surfaces are unfinished clear pine ready for on site finishing. Primed and pre-finished interiors are available in paint: Pure White, Extra White, Natural Choice, Moderate White; in stain: Wheat, Cherry, Fruitwood, Cordovan, Cider and Clear Lacquer.

**FRAME**

Frame is assembled from select kiln dried pine using AuraLast® wood on all exterior parts. Frame thickness is 1-5/32" (29.4mm) at head and side jamb and 1-5/32" (29.4mm) at sill. Basic jamb width is 3-3/4" (95.2mm). Standard jamb width is 4-9/16" (116mm). Frame features machine clamped assembly, which insures accurate squaring of unit, and frame corners are tightly secured with metal fasteners and adhesive. Finished frame includes all exterior casing.

**SASH**

Sash is 1-7/16" (36.5mm) thick with select kiln-dried pine using AuraLast® wood. Stiles and rails are mortise and tenoned, machine clamped for squareness and secured with metal fasteners.

**GLAZING**

3/4" (19mm) thick sealed insulating glass is constructed from two panes of glass, utilizing a continuous roll formed stainless steel spacer with dual seal sealant. The glass is mounted into the sash using a silicone-glazing compound and secured with interior applied profiled wood stops. All insulating glass units comply with the performance requirements of IGCC in accordance with either ASTM E774 or E2190.

**GLAZING OPTIONS**

3/4" insulating glass available in Low-E with Argon, Low-E, Low-E 366, Clear, Neat Glass, reflective, tinted, or obscure, tempered or other specialty glass as specified. Preserve® film is a 0.003" thick polyethylene film with a low tack acrylic adhesive applied to the glass for protection during shipping and installation. 4,000 foot elevations and higher require a capillary tube to equalize environmental stress (otherwise known as High Altitude glazing). High Altitude glazing does not allow the use of Argon as listed under glazing options.

**WEATHER-STRIPPING**

Engineered system combines a flexible, lined weather-strip applied to the full perimeter of the sash and thermoplastic rubber bulb applied to the full perimeter of the frame.

**HARDWARE**

Sash pivot on concealed hinges with sliding steel reinforced nylon shoes in an integral frame track. Stainless steel concealed locking system is standard. EntryGard awning dual arm roto-operator has removable polycarbonate cover, die cast zinc bash and hardened steel worm gears and arms. Hinges and roto-operator arms feature stainless steel. Two die cast locking levers are located on the side jambs at the lower corners of the window and have molded bezel covers that snap over the routs on the side stops. Units under 20" wide will feature a dyad operator. Color choices for locks and operator covers are White, Chestnut Bronze, Desert Sand or optional Bright Brass, Antique Brass, Polished Brass, Brushed Chrome or Imitation Oil Rubbed Bronze.

**INTERIOR INSECT SCREENS**

Charcoal fiberglass screen cloth (18x16 mesh) set in painted roll formed aluminum frame fitted to the inside of the window with all necessary hardware, in White, Chestnut Bronze, Desert Sand or optional Bright Brass, Antique Brass, Polished Brass, Brushed Chrome or Imitation Oil Rubbed Bronze. Aluminum mesh and Phantom screens are also available. Insect screens are intended to allow air and light in and to keep insects out. They are not intended to keep anyone or anything from falling through an open window. For safety screens or other security devices contact your local building supply retailer.

**GRILLES**

**SDL** (Simulated Divided Lites) - wood muntins permanently applied to the exterior of the insulating glass unit (not available on textured glass) in 7/8" (22mm), 1-1/8" (28.5mm), or 1-3/8" (34.9mm) widths, and a putty profile in 5/8" (15.9mm), 7/8" (22mm) and 1-1/8" (28.5mm) widths only. SDL is standard with a light bronze internal shadow bar to give a true divided lite appearance. As an option, SDL may be ordered with a silver shadow bar. Clear wood interior muntin bars match the exterior muntin width and are permanently bonded to the interior of the glass. Also available is a 2-5/16" (59mm) SDL bar, which simulates a double-hung checkrail.

**Full Surround Wood Grilles** - Rectangular unfinished clear pine wood grilles in 7/8" (22mm), 1-1/8" (28.6mm) and 1-3/8" (35mm) are available in patterns selected by the owner.

**GBG** (Grilles between the Glass) - 5/8" (15.9mm) flat and 23/32" or 1" contour mounted between the glass panes suspended within the air cavity.

**EXTERIOR TRIM**

1-3/32" (27.8mm) x 2" (50.8mm) brickmould with 1-1/16" (27mm) x 1-3/4" (44.5mm) nosing is standard. Flat casing is available as 1-3/32" (27.8mm) x 2" (50.8mm), 1-3/32" (27.8mm) x 3-1/2" (89mm), 1-3/32" (27.8mm) x 4-1/2" (114.3mm), and 1-3/32" (27.8mm) x 5-1/2" (139.7mm). The following profiled casings are available: RB-3 and Adams as 1-1/16" x 3-1/2" (89mm), and Williamsburg 1-3/16" x 3-1/4".

---

**PRODUCT SPECIFICATIONS**

---

**EXTENSION JAMBS**

Extension jambs are factory applied to the interior on all four sides of the frame and are 4/4 standard thick pine to accommodate wall depths up to 8-1/2" with one piece, and up to 12" with two pieces. 9/16" (14.2mm) and 5/4 option also available.

**INSTALLATION**

Installation per JELD-WEN Installation Method for Wood Windows JII003 or JII012. See [www.jeld-wen.com/resources](http://www.jeld-wen.com/resources) for instructions.

**PERFORMANCE**

**NFRC Certified** - (Rated and labeled in accordance with NFRC)

WDMA Hallmark Certified -  
In accordance with **AAMA/NWWDA/101/I.S.2-97**

**QUICK SPEC GUIDE**

SPECIFICATION	STANDARD FEATURES	OPTIONAL FEATURES <i>Some options may require additional lead times. Consult your JELD-WEN Sales Representative.</i>		
<b>FRAME</b>	<ul style="list-style-type: none"> <li>Fingerjoint Wood</li> </ul>			
<b>EXTERIOR FINISH</b>	<ul style="list-style-type: none"> <li>Primed</li> </ul>	<ul style="list-style-type: none"> <li>Natural</li> </ul>		
<b>EXTERIOR TRIM</b>	<ul style="list-style-type: none"> <li>1-3/32" Brickmould</li> <li>Vinyl Drip Cap</li> <li>Wood Sill Nose</li> </ul>	<ul style="list-style-type: none"> <li>Flat Casing: 1-3/32" x 2", 3-1/2", 4-1/2", and 5-1/2"</li> <li>Williamsburg Casing: 1-3/16" x 3-1/4"</li> <li>Adams Casing: 1-1/16" x 3-1/2"</li> <li>RB3 Casing: 1-1/16" x 3-1/2"</li> <li>1-7/32 x 4-1/2 Backband</li> <li>No Brickmould Option</li> <li>Historical Sill Nose</li> </ul>		
<b>INTERIOR FINISH</b>	<ul style="list-style-type: none"> <li>Natural</li> </ul>	<ul style="list-style-type: none"> <li>Priming Available</li> </ul> <p>Pre-finished Interior Options are:</p> <ul style="list-style-type: none"> <li>Paint - Pure White, Extra White, Natural Choice, Moderate White</li> <li>Stain - Wheat, Fruitwood, Cherry, Cordovan, Cider</li> <li>Clear Lacquer</li> </ul>		
<b>SIZE</b>	<ul style="list-style-type: none"> <li>Width: Operators 18, 20, 24, 28, 30, 32, 36, 42, 48, 54, 60</li> <li>Height: Operators 18, 20, 24, 28, 30, 36, 42, 48</li> <li>For RO, add 3/4"</li> </ul>	<ul style="list-style-type: none"> <li>Operator - Any Width: 18" to 60"</li> <li>Stationary - Enter as Casement</li> </ul> <ul style="list-style-type: none"> <li>Operator - Any Height: 18" to 48"</li> <li>Stationary - Enter as Casement</li> </ul> <p>For 54, 60 max Height is 36"</p> <p>Clad Awning under 28" wide use a special narrow roto-operator</p> <ul style="list-style-type: none"> <li>For RO, add 3/4"</li> </ul>		
<b>GLAZING</b>	<ul style="list-style-type: none"> <li>Low-E Insulating Glass</li> <li>Preserve® Protective Film</li> </ul>	<table border="0"> <tr> <td> <ul style="list-style-type: none"> <li>Clear</li> <li>Obscure</li> <li>Bronze</li> <li>Low-E 366</li> <li>Neat Glass</li> <li>Dual Low-E</li> <li>Reflective</li> </ul> </td> <td> <ul style="list-style-type: none"> <li>Tempered</li> <li>Decorative Glass                             <ul style="list-style-type: none"> <li>o Craftsman</li> <li>o Classic</li> <li>o Contemporary</li> <li>o Estate</li> </ul> </li> <li>Custom Design Capability</li> </ul> </td> </tr> </table> <ul style="list-style-type: none"> <li>High Altitude</li> </ul>	<ul style="list-style-type: none"> <li>Clear</li> <li>Obscure</li> <li>Bronze</li> <li>Low-E 366</li> <li>Neat Glass</li> <li>Dual Low-E</li> <li>Reflective</li> </ul>	<ul style="list-style-type: none"> <li>Tempered</li> <li>Decorative Glass                             <ul style="list-style-type: none"> <li>o Craftsman</li> <li>o Classic</li> <li>o Contemporary</li> <li>o Estate</li> </ul> </li> <li>Custom Design Capability</li> </ul>
<ul style="list-style-type: none"> <li>Clear</li> <li>Obscure</li> <li>Bronze</li> <li>Low-E 366</li> <li>Neat Glass</li> <li>Dual Low-E</li> <li>Reflective</li> </ul>	<ul style="list-style-type: none"> <li>Tempered</li> <li>Decorative Glass                             <ul style="list-style-type: none"> <li>o Craftsman</li> <li>o Classic</li> <li>o Contemporary</li> <li>o Estate</li> </ul> </li> <li>Custom Design Capability</li> </ul>			
<b>GRILLES</b>		<ul style="list-style-type: none"> <li>5/8" Flat, 23/32" or 1" Contour GBG</li> <li>7/8", 1-1/8", 1-3/8" Full Surround Wood Grilles</li> </ul> <p>SDL Bead Profile:</p> <ul style="list-style-type: none"> <li>7/8", 1-1/8", 1-3/8", 2-5/16" with Light Bronze Shadow Bar</li> <li>7/8", 1-1/8", 1-3/8", 2-5/16" with Silver Shadow Bar</li> </ul> <p>SDL Putty Profile:</p> <ul style="list-style-type: none"> <li>5/8", 7/8", 1-1/8" with Light Bronze Shadow Bar</li> <li>5/8", 7/8", 1-1/8" with Silver Shadow Bar</li> </ul>		

*Continued on next page*

**QUICK SPEC GUIDE**

SPECIFICATION	STANDARD FEATURES	OPTIONAL FEATURES
<b>HARDWARE</b>	<ul style="list-style-type: none"> <li>• Standard Folding Nesting Handle</li> <li>• Concealed Locking System</li> </ul>	<ul style="list-style-type: none"> <li>• T-Handle</li> <li>• Round Knob</li> </ul>
<b>HARDWARE COLOR</b>	<ul style="list-style-type: none"> <li>• White</li> <li>• Desert Sand</li> <li>• Chestnut Bronze</li> </ul>	<ul style="list-style-type: none"> <li>• Antique Brass</li> <li>• Polished Brass</li> <li>• Brushed Chrome</li> <li>• Oil Rubbed Bronze</li> </ul>
<b>JAMB</b>	<ul style="list-style-type: none"> <li>• 4-9/16"</li> </ul>	<ul style="list-style-type: none"> <li>• Minimum: 3-3/4"</li> <li>• Maximum: 8-1/2" (one piece)</li> <li>• Maximum: 12" (two piece)</li> </ul>
<b>SCREENS</b>	<ul style="list-style-type: none"> <li>• BetterVue™</li> </ul>	<ul style="list-style-type: none"> <li>• Aluminum Mesh available</li> <li>• Phantom Screen - Limitations apply, factory-applied</li> <li>• UltraVue™</li> </ul>
<b>SCREEN FRAME COLOR</b>	<ul style="list-style-type: none"> <li>• Brilliant White</li> <li>• Desert Sand</li> <li>• Chestnut Bronze</li> </ul>	

---

**GENERAL INFORMATION**

---

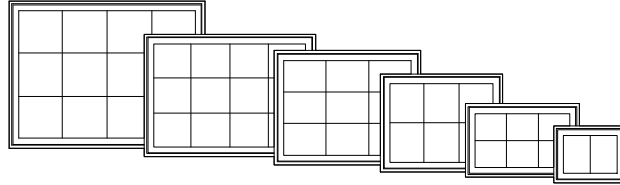
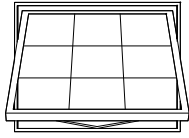

**DIMENSIONAL WINDOWS**

Wood awning windows may be specified as "dimensional" by adjusting the desired rough opening width or height in 1/4" increments from standard.

Wood awning windows are available as operating or stationary (non - venting). Operating mechanism includes corrosion resistant steel hinges and roto type operators for venting units. Sash locks are concealed unison type with an exposed locking lever and escutcheon plate. There are several interior hardware finish options. Refer to the Specifications for finish options.

**MULTIPLE ASSEMBLIES**

Wood awning windows may be mullied above, below, or beside other wood awning windows, or other wood window products. Factory assembled mulls are limited in height (100"), width (150"), and a total area (75 square feet).

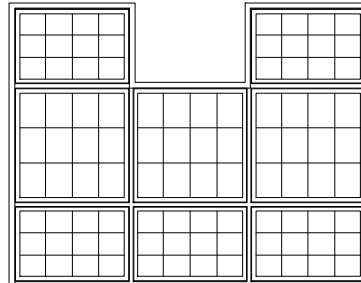
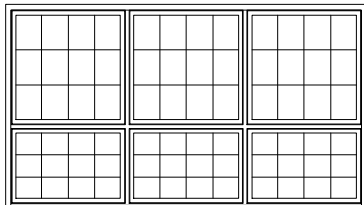
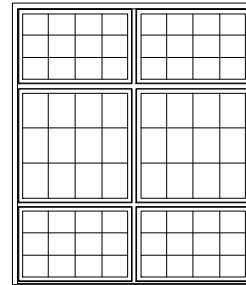
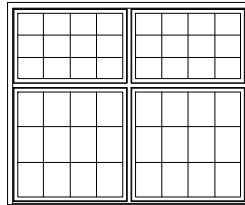
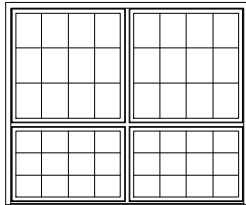

**ELEVATION NOTES**

ELEVATION DRAWINGS UTILIZE A LIMITED NUMBER OF PROJECTED LINES TO PRODUCE A RUDIMENTARY DRAWING INTENDED TO BE USED IN A SMALL GRAPHICAL SCALE. ELEVATIONS ARE VIEWED PERPENDICULAR FROM THE EXTERIOR OF THE STRUCTURE. IF MORE DIMENSIONS ARE NEEDED, USE THE SECTION DRAWINGS FOR MORE COMPLETE DEPICTIONS.

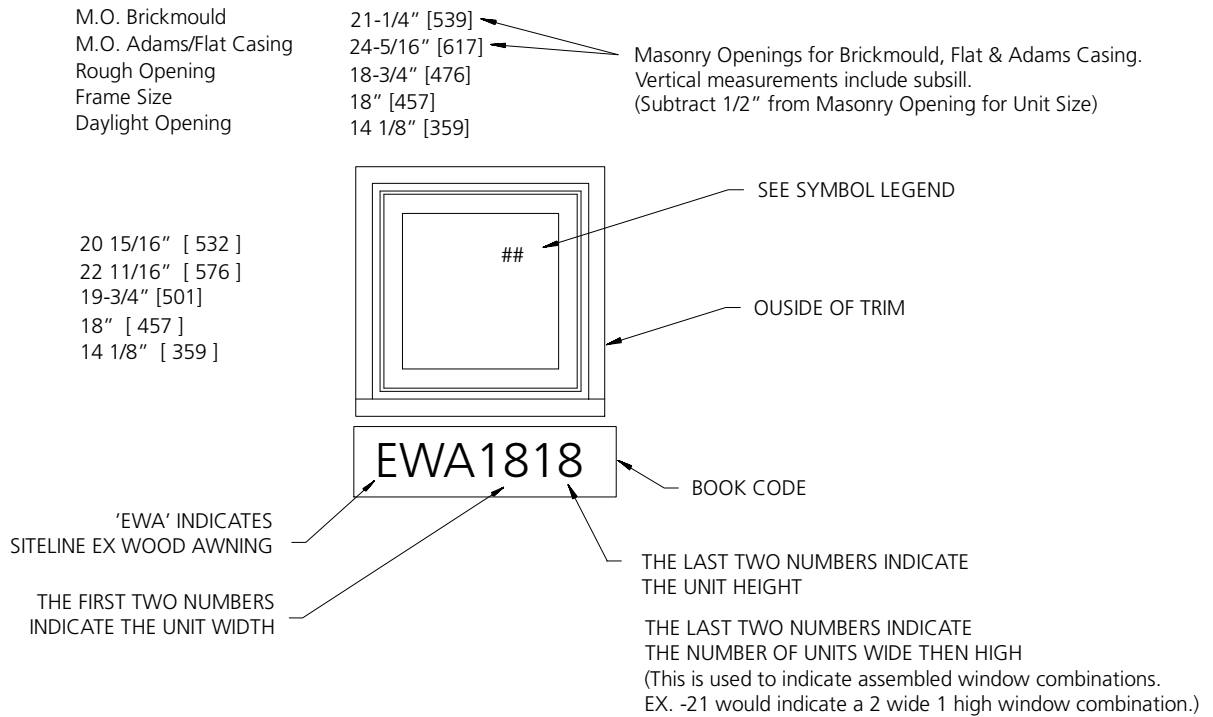

**GENERAL AWNING NOTES**

1. SITELINE EX WOOD AWNING (EWA) UNITS ARE AVAILABLE AS OPERATING OR STATIONARY UNITS.
2. UNIT ELEVATIONS ARE SHOWN WITH BRICKMOULDED AND SUBSILL.
3. DIMENSIONAL VALUES IN PARENTHESES ARE MILLIMETER CONVERSIONS.

**WOOD AWNING PICTURE COMBINATIONS**

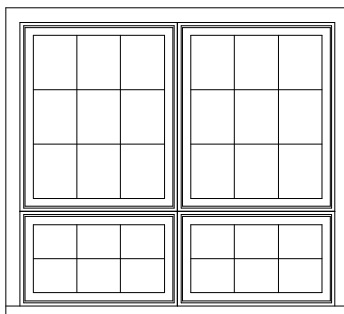

EWA303618

























































THE THIRD AND FOURTH NUMBERS OF THE BOOK CODE INDICATE THE PICTURE UNIT HEIGHT.

**ELEVATION SYMBOL LEGEND:**

- M.O.** MASONRY OPENING
- E** BASIC UNIT CLEAR OPENING EXCEEDS 20" IN WIDTH, 24" IN HEIGHT & A MINIMUM OF 5.7 SQ. FT.
- S** AVAILABLE AS STATIONARY ONLY.
- ##\*** NUMBER INDICATES DESIGN PRESSURE (DP) RATING WITH STANDARD GLAZING ON OPERATING OR STATIONARY UNITS. OPERATING UNITS UTILIZE A CONCEALED LOCKING SYSTEM FOR DP RATINGS.
- ##\*\*** NUMBER INDICATES OPTIONAL DESIGN PRESSURE (DP) RATING ON OPERATING OR STATIONARY UNITS.

**1-WIDE UNITS**

<b>M.O. BRICKMOULD</b>	21 1/2"(546)	23 1/2"(597)	27 1/2"(699)	31 1/2"(800)	33 1/2"(851)	35 1/2"(902)	39 1/2"(1003)
<b>M.O. ADAMS/FLAT CASING</b>	24 1/2"(645)	26 1/2"(673)	30 1/2"(775)	34 1/2"(876)	36 1/2"(927)	38 1/2"(978)	42 1/2"(1080)
<b>ROUGH OPENING</b>	18 3/4"(476)	20 3/4"(527)	24 3/4"(629)	28 3/4"(730)	30 3/4"(781)	32 3/4"(832)	36 3/4"(933)
<b>FRAME SIZE</b>	18"(457)	20"(508)	24"(610)	28"(711)	30"(762)	32"(813)	36"(914)
<b>DAYLIGHT OPENING</b>	12 3/32"(307)	14 3/32"(358)	18 3/32"(460)	22 3/32"(561)	24 3/32"(612)	26 3/32"(663)	30 3/32"(764)

19 15/16"(506) 22 1/16"(570) 18 3/4"(476) 12 3/32"(307)	 EWCA1818	 EWCA2018	 EWCA2418	 EWCA2818	 EWCA3018	 EWCA3218	 EWCA3618
22 15/16"(683) 24 1/16"(621) 20 3/4"(527) 14 3/32"(358)	 EWCA1820	 EWCA2020	 EWCA2420	 EWCA2820	 EWCA3020	 EWCA3220	 EWCA3620
26 15/16"(684) 28 1/16"(722) 24 3/4"(629) 18 3/32"(460)	 EWCA1824	 EWCA2024	 EWCA2424	 EWCA2824	 EWCA3024	 EWCA3224	 EWCA3624
30 15/16"(786) 32 1/16"(824) 28 3/4"(730) 22 3/32"(561)	 EWCA1828	 EWCA2028	 EWCA2428	 EWCA2828	 EWCA3028	 EWCA3228	 EWCA3628
32 15/16"(837) 34 1/16"(875) 30 3/4"(730) 24 3/32"(612)	 EWCA1830	 EWCA2030	 EWCA2430	 EWCA2830	 EWCA3030	 EWCA3230	 EWCA3630
38 15/16"(989) 40 1/16"(927) 36 3/4"(832) 30 3/32"(764)	 EWCA1836	 EWCA2036	 EWCA2436	 EWCA2836	 EWCA3036	 EWCA3236	 EWCA3636
44 15/16"(1141) 46 1/16"(1080) 42 3/4"(1080) 36 3/32"(917)	 EWCA1842	 EWCA2042	 EWCA2442	 EWCA2842	 EWCA3042	 EWCA3242	 EWCA3642
50 15/16"(1294) 52 1/16"(1232) 48 3/4"(1232) 42 3/32"(1070)	 EWCA1848	 EWCA2048	 EWCA2448	 EWCA2848	 EWCA3048	 EWCA3248	 EWCA3648

**ELEVATION SYMBOL LEGEND:**  
**M.O.** = MASONRY OPENING  
 VALUES IN ( ) ARE IN MILLIMETER CONVERSIONS  
 \*\*\* INDICATES DESIGN PRESSURE (DP) RATING WITH STANDARD GLAZING  
 \*\*\*\* INDICATES OPTIONAL DESIGN PRESSURE (DP) RATING

Note: Elevations shown DO NOT have exterior trim. Subtract 1/2" (12.7) from M.O. (Masonry Opening) for Unit Sizes. Masonry Openings above include Sill Nose, see Trim Options page for Sill Nose specifications. For other Trim Options refer to the Unit Sizing, Rough Opening & Masonry Openings page.

SCALE 1/4" = 1'



**1-WIDE UNITS**

<b>M.O. BRICKMOULD</b>	21 1/2" (546)	23 1/2" (597)	27 1/2" (699)	31 1/2" (800)	33 1/2" (851)	35 1/2" (902)	39 1/2" (1003)
<b>M.O. ADAMS/FLAT CASING</b>	24 1/2" (645)	26 1/2" (673)	30 1/2" (775)	34 1/2" (876)	36 1/2" (927)	38 1/2" (978)	42 1/2" (1080)
<b>ROUGH OPENING</b>	18 3/4" (476)	20 3/4" (527)	24 3/4" (629)	28 3/4" (730)	30 3/4" (781)	32 3/4" (832)	36 3/4" (933)
<b>FRAME SIZE</b>	18" (457)	20" (508)	24" (610)	28" (711)	30" (762)	32" (813)	36" (914)
<b>DAYLIGHT OPENING</b>	12 3/32" (307)	14 3/32" (358)	18 3/32" (460)	22 3/32" (561)	24 3/32" (612)	26 3/32" (663)	30 3/32" (764)

56 15/16" (1446)  
58 7/16" (1484)  
54 3/4" (1391)  
54" (1372)  
48 3/32" (1222)

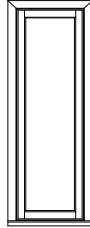

EWCA1854

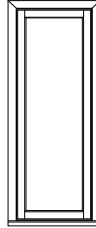

EWCA2054

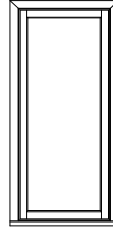

EWCA2454

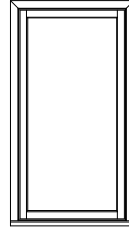

EWCA2854

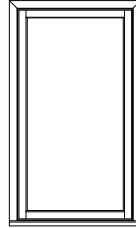

EWCA3054

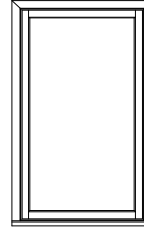

EWCA3254

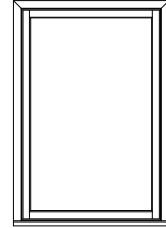

EWCA3654

62 15/16" (1599)  
64 7/16" (1637)  
60 3/4" (1543)  
60" (1524)  
54 3/32" (1374)



EWCA1860



EWCA2060

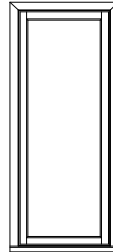

EWCA2460

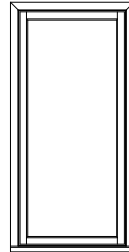

EWCA2860

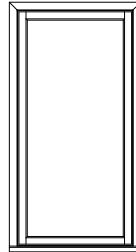

EWCA3060

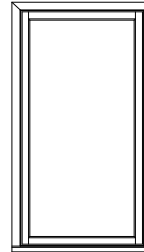

EWCA3260

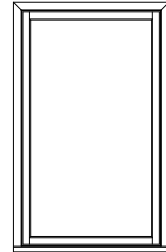

EWCA3660

**ELEVATION SYMBOL LEGEND:**

**M.O.** = MASONRY OPENING  
VALUES IN ( ) ARE IN MILLIMETER CONVERSIONS

Note: Elevations shown DO NOT have exterior trim. Subtract 1/2" (12.7) from M.O. (Masonry Opening) for Unit Sizes. Masonry Openings above include Sill Nose, see Trim Options page for Sill Nose specifications. For other Trim Options refer to the Unit Sizing, Rough Opening & Masonry Openings page.

SCALE 1/4" = 1'

**1-WIDE UNITS**





**M.O. BRICKMOULD**  
**M.O. ADAMS/FLAT CASING**  
**ROUGH OPENING**  
**FRAME SIZE**  
**DAYLIGHT OPENING**

45 1/2"(1156)  
48 1/2"(1232)  
42 3/4"(1086)  
42"(1067)  
36 3/32"(917)

51 1/2"(1308)  
54 1/2"(1384)  
48 3/4"(1238)  
48"(1219)  
42 3/32"(1070)

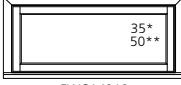
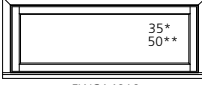
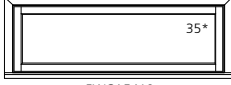
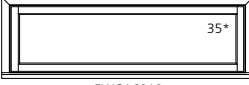
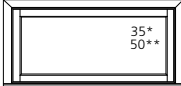
57 1/2"(1448)  
60 1/2"(1537)  
54 3/4"(1391)  
54"(1372)  
48 3/32"(1222)

63 1/2"(1613)  
66 1/2"(1689)  
60 3/4"(1543)  
60"(1524)  
54 3/32"(1374)

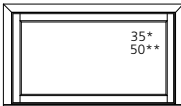
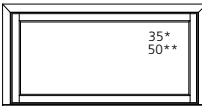
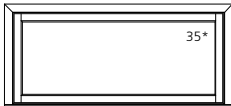
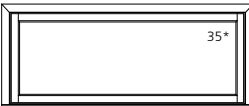
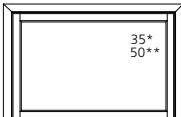
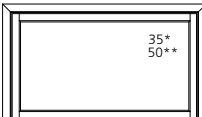
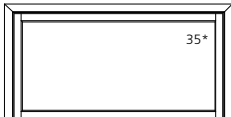
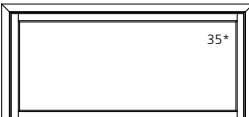
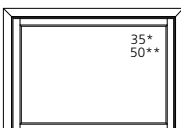
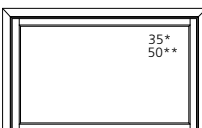
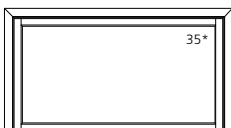
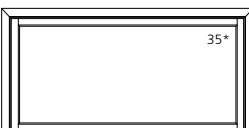
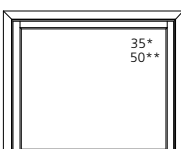
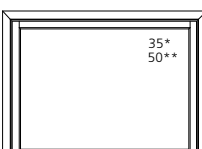
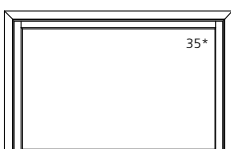
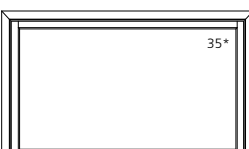
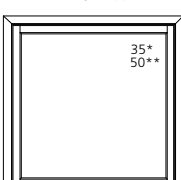
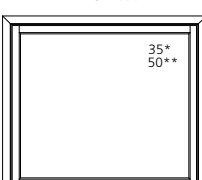
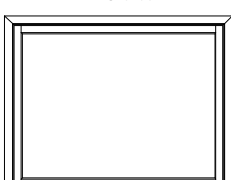
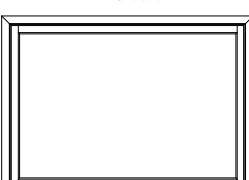
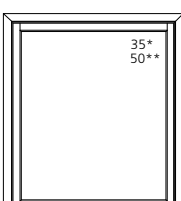
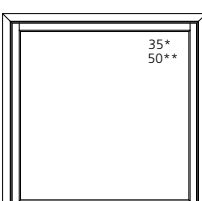
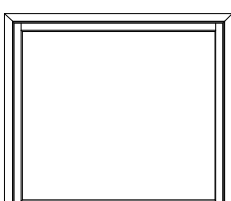
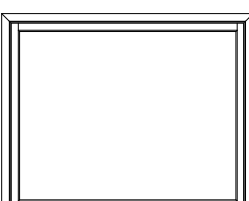
19 15/16"(506) 22 1/16"(570) 18 3/8"(467) 12 3/32"(307)				
22 15/16"(583) 24 1/16"(621) 20 3/8"(508) 14 3/32"(358)				
26 15/16"(694) 28 1/16"(722) 24 3/8"(629) 18 3/32"(460)				
30 15/16"(786) 32 1/16"(824) 28 3/8"(711) 22 3/32"(561)				
32 15/16"(837) 34 1/16"(875) 30 3/8"(781) 24 3/32"(612)				
38 15/16"(989) 40 1/16"(1027) 36 3/8"(914) 30 3/32"(764)				
44 15/16"(1141) 46 1/16"(1180) 42 3/8"(1067) 36 3/32"(917)				
50 15/16"(1294) 52 1/16"(1332) 48 3/8"(1238) 42 3/32"(1070)				

**ELEVATION SYMBOL LEGEND:**

**M.O.** = MASONRY OPENING  
VALUES IN ( ) ARE IN MILLIMETER CONVERSIONS  
##\* INDICATES DESIGN PRESSURE (DP) RATING WITH STANDARD GLAZING  
###\* INDICATES OPTIONAL DESIGN PRESSURE (DP) RATING

Note: Elevations shown DO NOT have exterior trim. Subtract 1/2" (12.7) from M.O. (Masonry Opening) for Unit Sizes. Masonry Openings above include Sill Nose, see Trim Options page for Sill Nose specifications. For other Trim Options refer to the Unit Sizing, Rough Opening & Masonry Openings page.

SCALE 1/4" = 1'

**1-WIDE UNITS**

<b>M.O. BRICKMOULD</b>	45 1/2"(1156)	51 1/2"(1308)	57 1/2"(1448)
<b>M.O. ADAMS/FLAT CASING</b>	48 1/2"(1232)	54 1/2"(1384)	60 1/2"(1537)
<b>ROUGH OPENING</b>	42 3/4"(1086)	48 3/4"(1238)	54 3/4"(1391)
<b>FRAME SIZE</b>	42"(1067)	48"(1219)	54"(1372)
<b>DAYLIGHT OPENING</b>	36 3/32"(917)	42 3/32"(1070)	48 3/32"(1222)

56 15/16"(1446)  
58 7/16"(1484)  
54 3/4"(1391)  
54"(1372)  
48 3/32"(1222)

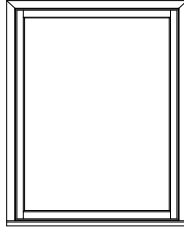

EWCA4254

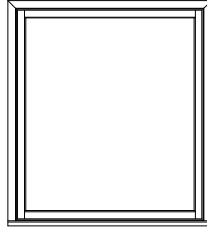

EWCA4854

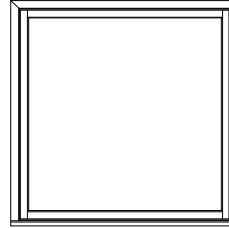

EWCA5454

62 15/16"(1599)  
64 7/16"(1637)  
60 3/4"(1543)  
60"(1524)  
54 3/32"(1374)

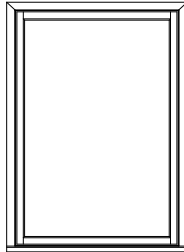

EWCA4260

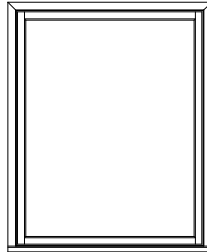

EWCA4860

**ELEVATION SYMBOL LEGEND:**  
M.O. = MASONRY OPENING  
VALUES IN () ARE IN MILLIMETER CONVERSIONS

Note: Elevations shown DO NOT have exterior trim. Subtract 1/2" (12.7) from M.O. (Masonry Opening) for Unit Sizes. Masonry Openings above include Sill Nose, see Trim Options page for Sill Nose specifications. For other Trim Options refer to the Unit Sizing, Rough Opening & Masonry Openings page.

SCALE 1/4" = 1'

**2-WIDE UNITS**











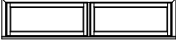





	39 1/2"(1003)	43 1/2"(1105)	51 1/2"(1308)	59 1/2"(1511)	63 1/2"(1613)	67 1/2"(1715)	75 1/2"(1918)
<b>MO BRICKMOULD</b>							
<b>MO FLAT CASING</b>	42 1/2"(1080)	46 1/2"(1181)	54 1/2"(1384)	62 1/2"(1588)	66 1/2"(1689)	70 1/2"(1791)	78 1/2"(1994)
<b>ROUGH OPENING</b>	36 3/4"(933)	40 3/4"(1035)	48 3/4"(1238)	56 3/4"(1441)	60 3/4"(1543)	64 3/4"(1645)	72 3/4"(1848)
<b>FRAME SIZE</b>	36"(914)	40"(1016)	48"(1219)	56"(1422)	60"(1524)	64"(1626)	72"(1829)
<b>DAYLIGHT OPENING</b>	12 3/32"(307)[2]	14 3/32"(358)[2]	18 3/32"(460)[2]	22 3/32"(561)[2]	24 3/32"(612)[2]	26 3/32"(663)[2]	30 3/32"(764)[2]
20 15/16"(532) 22 7/16"(570) 18 3/4"(476) 18"(457) 12 3/32"(307)							
22 15/16"(583) 24 7/16"(621) 20 3/4"(527) 20"(508) 14 3/32"(358)							
26 15/16"(684) 28 7/16"(722) 24 3/4"(629) 24"(610) 18 3/32"(460)							
30 15/16"(786) 32 7/16"(824) 28 3/4"(730) 28"(711) 22 3/32"(561)							
32 15/16"(837) 34 7/16"(875) 30 3/4"(781) 30"(762) 24 3/32"(612)							
38 15/16"(989) 40 7/16"(1027) 36 3/4"(933) 36"(914) 30 3/32"(764)							
44 15/16"(1141) 46 7/16"(1180) 42 3/4"(1086) 42"(1067) 36 3/32"(917)							
50 15/16"(1294) 52 7/16"(1332) 48 3/4"(1238) 48"(1219) 42 3/32"(1070)							

**ELEVATION SYMBOL LEGEND:**  
**M.O.** = MASONRY OPENING  
 VALUES IN ( ) ARE IN MILLIMETER CONVERSIONS  
 VALUES IN [ ] ARE NUMBER OF DAYLIGHT OPENINGS PER UNIT

Note: Elevations shown DO NOT have exterior trim. Subtract 1/2" (12.7) from M.O. (Masonry Opening) for Unit Sizes. Masonry Openings above include Sill Nose, see Trim Options page for Sill Nose specifications. For other Trim Options refer to the Unit Sizing, Rough Opening & Masonry Openings page.

SCALE 1/4" = 1'

**2-WIDE UNITS**

MO BRICKMOULD MO FLAT CASING ROUGH OPENING FRAME SIZE DAYLIGHT OPENING	87 1/2" (2223) 90 1/2" (2299) 84 3/4" (2153) 84" (2134) 36 3/32" (917)[2]	99 1/2" (2527) 102 1/2" (2604) 96 3/4" (2457) 96" (2438) 42 3/32" (1070)[2]
20 15/16" (532) 22 7/16" (570) 18 1/4" (457) 12 3/32" (307)		
22 15/16" (583) 24 1/4" (621) 20 3/4" (527) 19 1/4" (498) 14 3/32" (358)		
26 15/16" (684) 28 7/16" (722) 24 1/4" (625) 24 1/4" (610) 18 3/32" (460)		
30 15/16" (786) 32 1/4" (824) 28 3/4" (730) 28 3/4" (711) 22 3/32" (561)		
32 15/16" (837) 34 1/4" (875) 30 3/4" (781) 30 3/4" (763) 24 3/32" (612)		
38 15/16" (989) 40 7/16" (1027) 36 3/4" (933) 35 9/16" (914) 30 3/32" (764)		
44 15/16" (1141) 46 7/16" (1180) 42 3/4" (1086) 42 3/4" (1067) 36 3/32" (917)		
50 15/16" (1294) 52 7/16" (1332) 48 3/4" (1238) 48 3/4" (1219) 42 3/32" (1070)		

**ELEVATION SYMBOL LEGEND:**

M.O. = MASONRY OPENING  
VALUES IN ( ) ARE IN MILLIMETER CONVERSIONS  
VALUES IN [ ] ARE NUMBER OF DAYLIGHT OPENINGS PER UNIT

Note: Elevations shown DO NOT have exterior trim. Subtract 1/2" (12.7) from M.O. (Masonry Opening) for Unit Sizes. Masonry Openings above include Sill Nose, see Trim Options page for Sill Nose specifications. For other Trim Options refer to the Unit Sizing, Rough Opening & Masonry Openings page.

SCALE 1/4" = 1'

**3-WIDE UNITS**

**MO BRICKMOULD**  
**MO FLAT CASING**  
**ROUGH OPENING**  
**FRAME SIZE**  
**DAYLIGHT OPENING**

57 1/2"(1448)  
60 1/2"(1537)  
54 3/4"(1391)  
54"(1372)  
12 3/32"(307)[3]

63 1/2"(1613)  
66 1/2"(1689)  
60 3/4"(1543)  
60"(1524)  
14 3/32"(358)[3]

75 1/2"(1918)  
78 1/2"(1994)  
72 3/4"(1848)  
72"(1829)  
18 3/32"(460)[3]

87 1/2"(2223)  
90 1/2"(2299)  
84 3/4"(2153)  
84"(2134)  
22 3/32"(561)[3]

93 1/2"(2380)  
96 1/2"(2451)  
90 3/4"(2305)  
90"(2286)  
24 3/32"(612)[3]

99 1/2"(2527)  
102 1/2"(2604)  
96 3/4"(2457)  
96"(2438)  
26 3/32"(663)[3]

20 15/16"(532)  
22 7/16"(570)  
18 3/4"(476)  
18"(457)  
12 3/32"(307)



EWCA1818-3



EWCA2018-3



EWCA2418-3



EWCA2818-3



EWCA3018-3



EWCA3218-3

22 15/16"(583)  
24 7/16"(621)  
20 3/4"(527)  
20"(508)  
14 3/32"(358)



EWCA1820-3



EWCA2020-3



EWCA2420-3



EWCA2820-3



EWCA3020-3



EWCA3220-3

26 15/16"(684)  
28 7/16"(722)  
24 3/4"(629)  
24"(610)  
18 3/32"(460)



EWCA1824-3



EWCA2024-3



EWCA2424-3



EWCA2824-3



EWCA3024-3



EWCA3224-3

30 15/16"(786)  
32 7/16"(824)  
28 3/4"(730)  
28"(711)  
22 3/32"(561)



EWCA1828-3



EWCA2028-3



EWCA2428-3



EWCA2828-3



EWCA3028-3



EWCA3228-3

32 15/16"(837)  
34 7/16"(875)  
30 3/4"(781)  
30"(762)  
24 3/32"(612)



EWCA1830-3



EWCA2030-3



EWCA2430-3



EWCA2830-3



EWCA3030-3

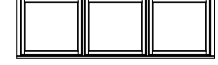

EWCA3230-3

38 15/16"(989)  
40 7/16"(1027)  
36 3/4"(933)  
36"(914)  
30 3/32"(764)



EWCA1836-3



EWCA2036-3



EWCA2436-3



EWCA2836-3



EWCA3036-3



EWCA3236-3

44 15/16"(1141)  
46 7/16"(1180)  
42 3/4"(1086)  
42"(1067)  
36 3/32"(917)



EWCA1842-3



EWCA2042-3



EWCA2442-3



EWCA2842-3



EWCA3042-3



EWCA3242-3

50 15/16"(1294)  
52 7/16"(1332)  
48 3/4"(1238)  
48"(1219)  
42 3/32"(1070)

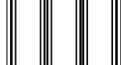

EWCA1848-3



EWCA2048-3

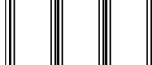

EWCA2448-3



EWCA2848-3

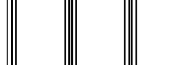

EWCA3048-3



EWCA3248-3

**ELEVATION SYMBOL LEGEND:**

**M.O.** = MASONRY OPENING  
VALUES IN ( ) ARE IN MILLIMETER CONVERSIONS  
VALUES IN [ ] ARE NUMBER OF DAYLIGHT OPENINGS PER UNIT

Note: Elevations shown DO NOT have exterior trim. Subtract 1/2" (12.7) from M.O. (Masonry Opening) for Unit Sizes. Masonry Openings above include Sill Nose, see Trim Options page for Sill Nose specifications. For other Trim Options refer to the Unit Sizing, Rough Opening & Masonry Openings page.

SCALE 1/4" = 1'



















**3-WIDE UNITS**

**MO BRICKMOULD**  
**MO FLAT CASING**  
**ROUGH OPENING**  
**FRAME SIZE**  
**DAYLIGHT OPENING**

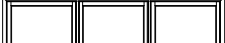
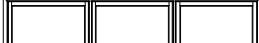
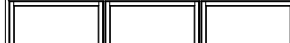
111 1/2"(2832)  
114 1/2"(2908)  
108 3/4"(2762)  
108"(2743)  
30 3/32"(764)[3]

129 1/2"(3289)  
132 1/2"(3366)  
126 3/4"(3219)  
126"(3200)  
36 3/32"(917)[3]

147 1/2"(3747)  
150 1/2"(3823)  
144 3/4"(3677)  
144"(3658)  
42 3/32"(1070)[3]

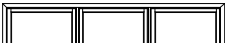
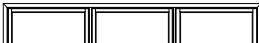
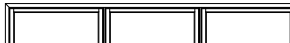
20 15/16"(532) 22 7/16"(570) 18 3/4"(476) 18"(457) 12 3/32"(307)			
EWCA3618-3	EWCA4218-3	EWCA4818-3	
22 15/16"(583) 24 7/16"(621) 20 3/4"(527) 20"(508) 14 3/32"(358)			
EWCA3620-3	EWCA4220-3	EWCA4820-3	
26 15/16"(684) 28 7/16"(722) 24 3/4"(629) 24"(610) 18 3/32"(460)			
EWCA3624-3	EWCA4224-3	EWCA4824-3	
30 15/16"(786) 32 7/16"(824) 28 3/4"(730) 28"(711) 22 3/32"(561)			
EWCA3628-3	EWCA4228-3	EWCA4828-3	
32 15/16"(837) 34 7/16"(875) 30 3/4"(781) 30"(762) 24 3/32"(612)			
EWCA3630-3	EWCA4230-3	EWCA4830-3	
38 15/16"(989) 40 7/16"(1027) 36 3/4"(933) 36"(914) 30 3/32"(764)			
EWCA3636-3	EWCA4236-3	EWCA4836-3	
44 15/16"(1141) 46 7/16"(1180) 42 3/4"(1086) 42"(1067) 36 3/32"(917)			
EWCA3642-3	EWCA4242-3	EWCA4842-3	
50 15/16"(1294) 52 7/16"(1332) 48 3/4"(1238) 48"(1219) 42 3/32"(1070)			
EWCA3648-3	EWCA4248-3	EWCA4848-3	

**ELEVATION SYMBOL LEGEND:**

**M.O.** = MASONRY OPENING  
VALUES IN ( ) ARE IN MILLIMETER CONVERSIONS  
VALUES IN [ ] ARE NUMBER OF DAYLIGHT OPENINGS PER UNIT

Note: Elevations shown DO NOT have exterior trim. Subtract 1/2" (12.7) from M.O. (Masonry Opening) for Unit Sizes. Masonry Openings above include Sill Nose, see Trim Options page for Sill Nose specifications. For other Trim Options refer to the Unit Sizing, Rough Opening & Masonry Openings page.

SCALE 1/4" = 1'

**PICTURE UNITS**

M.O. BRICKMOLD 39 1/2" (1003)  
M.O. ADAMS/FLAT CASING 42 1/2" (1080)  
ROUGH OPENING 36 3/4" (933)  
FRAME SIZE 36" (914)  
DAYLIGHT OPENING 30 3/32" (764)

45 1/2" (1156)  
48 1/2" (1232)  
42 3/4" (1086)  
42" (1067)  
36 3/32" (917)

51 1/2" (1308)  
54 1/2" (1384)  
48 3/4" (1238)  
48" (1219)  
42 3/32" (1070)

63 1/2" (1613)  
66 1/2" (1689)  
60 3/4" (1543)  
60" (1524)  
54 3/32" (1374)

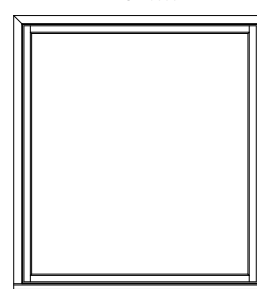
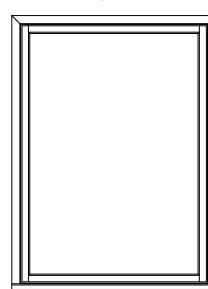
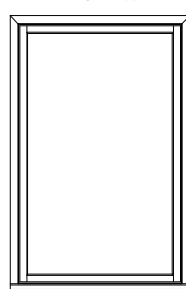
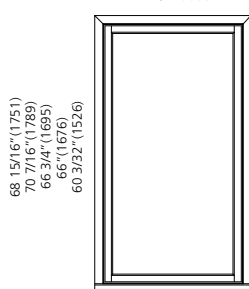
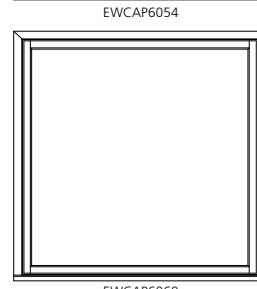
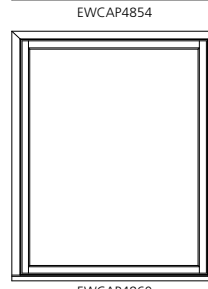
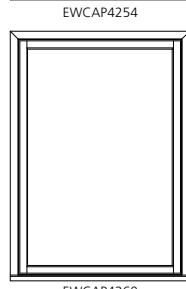
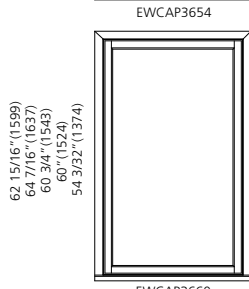
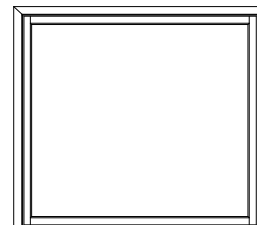
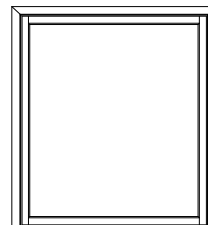
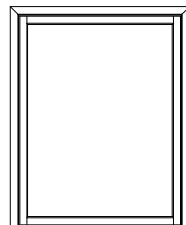
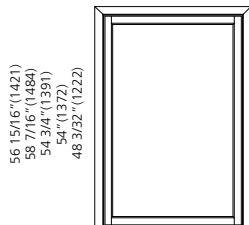
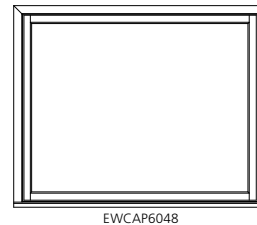
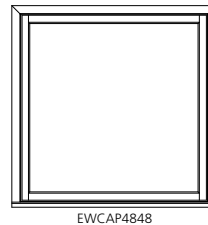
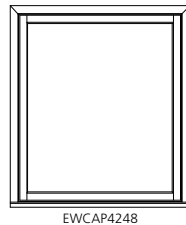
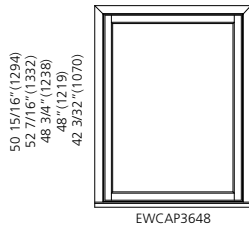
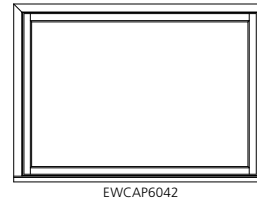
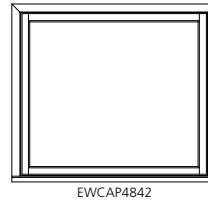
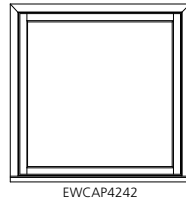
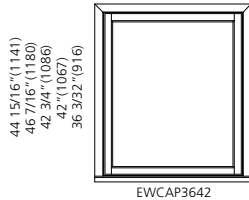
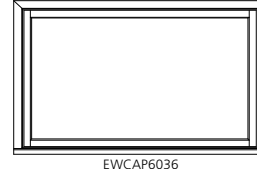
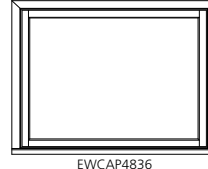
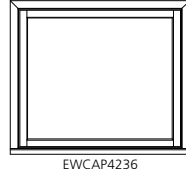
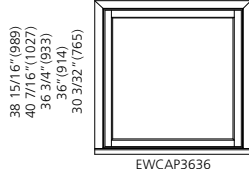

**ELEVATION SYMBOL LEGEND:**

M.O. = MASONRY OPENING  
VALUES IN ( ) ARE IN MILLIMETER CONVERSIONS

Note: Elevations shown DO NOT have exterior trim. Subtract 1/2" (12.7) from M.O. (Masonry Opening) for Unit Sizes. Masonry Openings above include Sill Nose, see Trim Options page for Sill Nose specifications. For other Trim Options refer to the Unit Sizing, Rough Opening & Masonry Openings page.

SCALE 1/4" = 1'



**PICTURE UNITS**

<b>M.O. BRICKMOULD</b>	39 1/2"(1003)	45 1/2"(1156)	51 1/2"(1308)	63 1/2"(1613)
<b>M.O. ADAMS/FLAT CASING</b>	42 1/2"(1080)	48 1/2"(1232)	54 1/2"(1384)	66 1/2"(1689)
<b>ROUGH OPENING</b>	36 3/4"(933)	42 3/4"(1086)	48 3/4"(1238)	60 3/4"(1543)
<b>FRAME SIZE</b>	36"(914)	42"(1067)	48"(1219)	60"(1524)
<b>DAYLIGHT OPENING</b>	30 3/32"(764)	36 3/32"(917)	42 3/32"(1070)	54 3/32"(1374)

74 15/16"(1903)  
76 7/16"(1922)  
77 3/8"(1948)  
77 1/2"(1929)  
66 3/32"(1679)

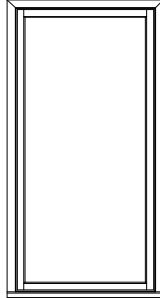

EWCAP3672

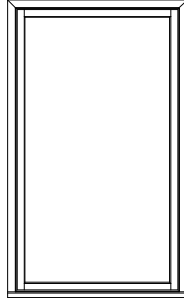

EWCAP4272

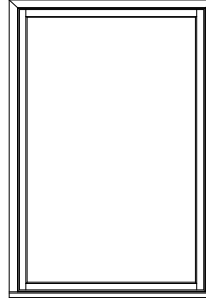

EWCAP4872

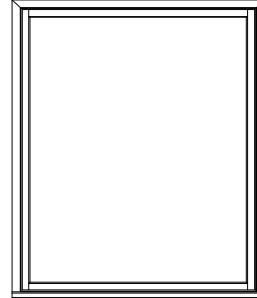

EWCAP6072

**ELEVATION SYMBOL LEGEND:**

**M.O.** = MASONRY OPENING  
VALUES IN ( ) ARE IN MILLIMETER CONVERSIONS

Note: Elevations shown DO NOT have exterior trim. Subtract 1/2" (12.7) from M.O. (Masonry Opening) for Unit Sizes. Masonry Openings above include Sill Nose, see Trim Options page for Sill Nose specifications. For other Trim Options refer to the Unit Sizing, Rough Opening & Masonry Openings page.

SCALE 1/4" = 1'

**PICTURE UNITS**

**M.O. BRICKMOULD  
M.O. ADAMS/FLAT CASING  
ROUGH OPENING  
FRAME SIZE  
DAYLIGHT OPENING**

75 1/2"(1918)  
78 1/2"(1994)  
72 3/4"(1848)  
72"(1829)  
66 3/32"(1679)

38 15/16"(989)  
40 7/16"(1027)  
36 3/4"(933)  
36"(914)  
30 3/32"(765)



EWCAP7236

44 15/16"(1141)  
46 7/16"(1180)  
42 3/4"(1086)  
42"(1067)  
36 3/32"(916)



EWCAP7242

50 15/16"(1294)  
52 7/16"(1332)  
48 3/4"(1238)  
48"(1219)  
42 3/32"(1070)



EWCAP7248

56 15/16"(1421)  
58 7/16"(1484)  
54 3/4"(1391)  
54"(1372)  
48 3/32"(1222)



EWCAP7254

62 15/16"(1599)  
64 7/16"(1637)  
60 3/4"(1543)  
60"(1524)  
54 3/32"(1374)



EWCAP7260

68 15/16"(1751)  
70 7/16"(1789)  
66 3/4"(1695)  
66"(1676)  
60 3/32"(1526)

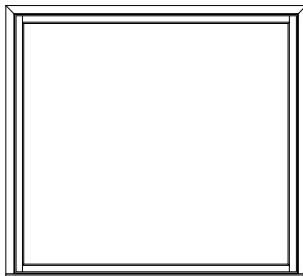

EWCAP7266

**M.O. BRICKMOULD  
M.O. ADAMS/FLAT CASING  
ROUGH OPENING  
FRAME SIZE  
DAYLIGHT OPENING**

75 1/2"(1918)  
78 1/2"(1994)  
72 3/4"(1848)  
72"(1829)  
66 3/32"(1679)

74 15/16"(1903)  
76 7/16"(1942)  
72 3/4"(1848)  
72"(1829)  
66 3/32"(1679)

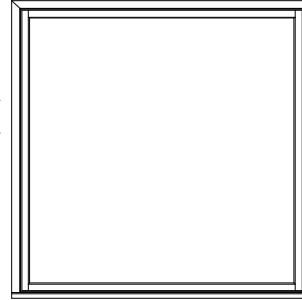

EWCAP7272

**ELEVATION SYMBOL LEGEND:**  
M.O. = MASONRY OPENING  
VALUES IN ( ) ARE IN MILLIMETER CONVERSIONS

Note: Elevations shown DO NOT have exterior trim. Subtract 1/2" (12.7) from M.O. (Masonry Opening) for Unit Sizes. Masonry Openings above include Sill Nose, see Trim Options page for Sill Nose specifications. For other Trim Options refer to the Unit Sizing, Rough Opening & Masonry Openings page.

SCALE 1/4" = 1'

---

**SASH GLAZING OPTIONS**

---

**INTERIOR GLAZING OPTIONS**

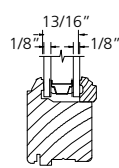

**AWNING &  
PICTURE**  
5/DS//5/DS

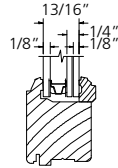

**AWNING &  
PICTURE**  
5/DS//7.0L

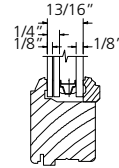

**AWNING &  
PICTURE**  
7.0L//5/DS

SCALE 3" = 1'

**DIRECT SET GLAZING OPTIONS**

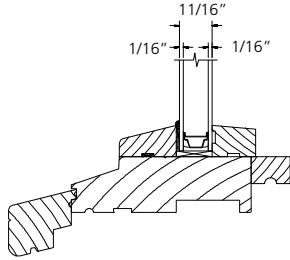

**STANDARD INSULATED GLASS**

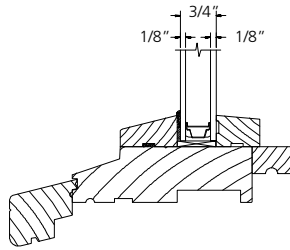

**STANDARD INSULATED GLASS**

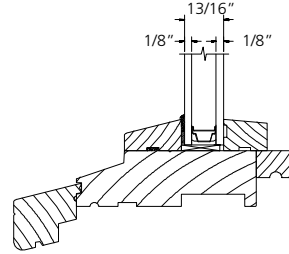

**STANDARD INSULATED GLASS**

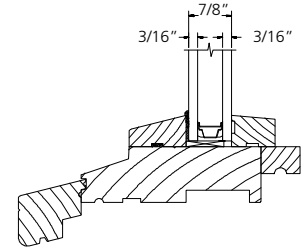

**STANDARD INSULATED GLASS**

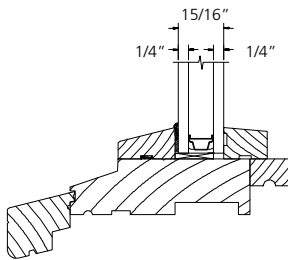

**STANDARD INSULATED GLASS**

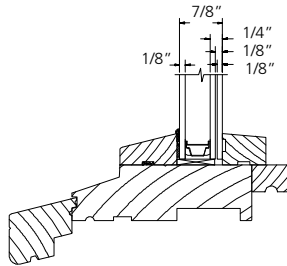

**LAMINATED INSULATED CLEAR OR LOW E GLASS**

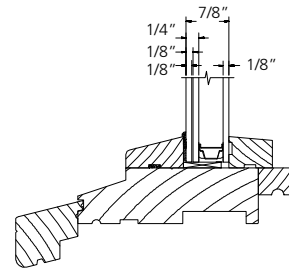

**LAMINATED INSULATED TINTED GLASS**

**NOTES:**

GLAZING OPTIONS SHOWN ARE AVAILABLE IN CLAD GEOMETRIC DIRECT SET WINDOWS WITH FRAME AS SHOWN AND ALSO IN CLAD RADIUS DIRECT GLAZED WINDOWS AND WOOD GEOMETRIC AND RADIUS DIRECT GLAZED WINDOWS. SEE DRAWING EXCladRadiusDSet FOR CLAD RADIUS WINDOW FRAME AND DRAWING EXWoodDirectSet FOR WOOD GEOMETRIC AND RADIUS FRAME DETAILS.

DUAL PANE AND TRI PANE IG SHOWN WITH STAINLESS STEEL WARM EDGE SPACER MAY ALSO BE BUILT WITH ALUMINUM BOX SPACER DEPENDING ON SHAPE, GLASS TYPE, OR SPECIAL GRILLE BAR PATTERN.

**TRIM OPTIONS**

**WOOD EXTERIOR TRIM**

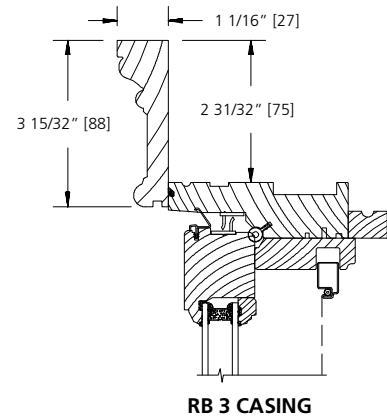
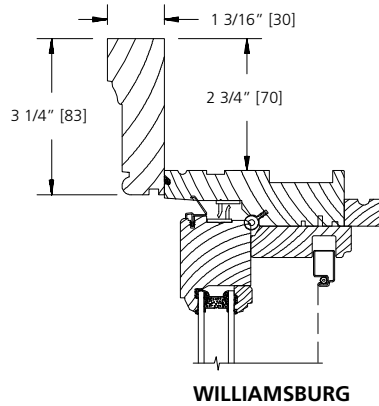
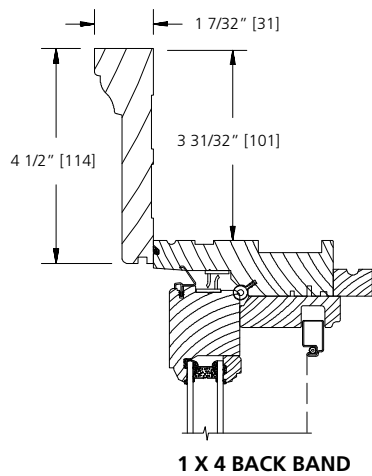
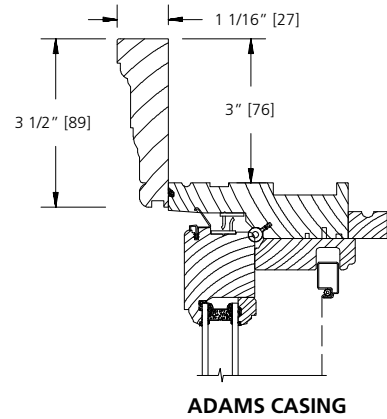
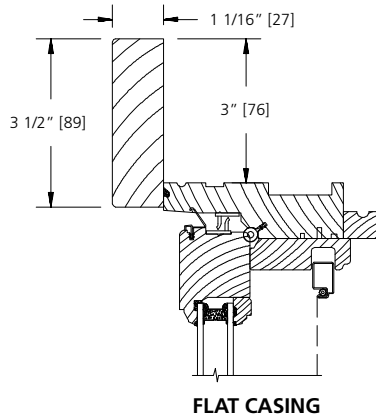
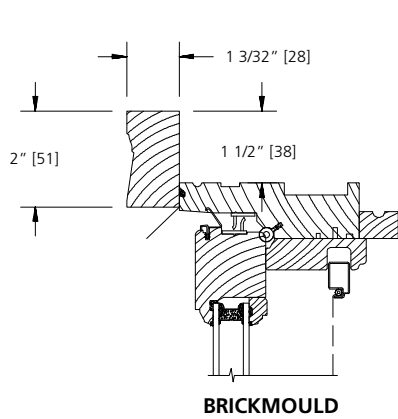

**WOOD SUBSILL OPTIONS**

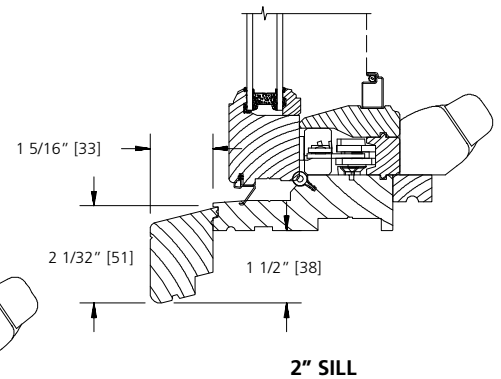
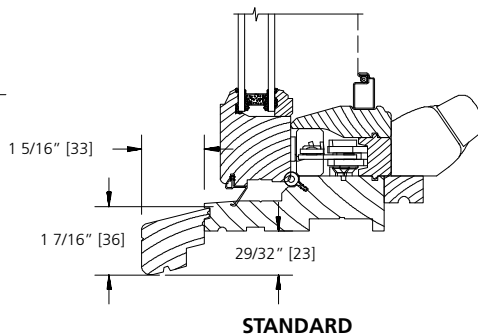
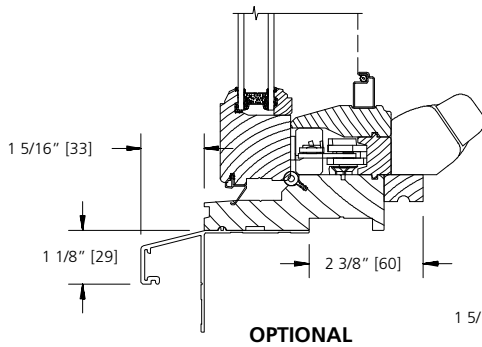

SCALE: 3" = 1'

**JAMB EXTENDER  
& STUCCO TRIM OPTIONS**

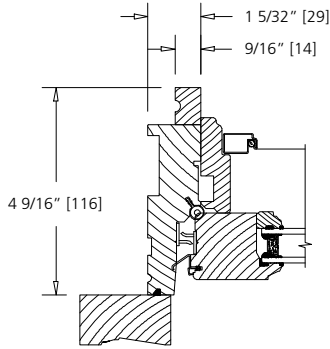

**4 9/16" WALL**  
9/16" JAMB THICKNESS (OPTION)

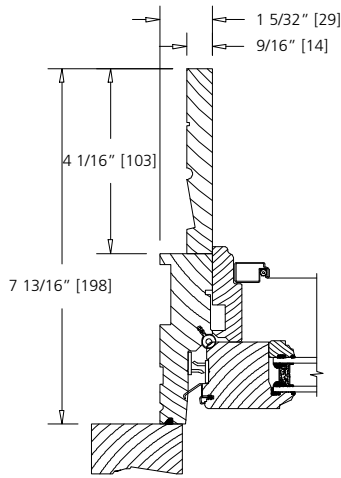

**7 13/16" WALL**

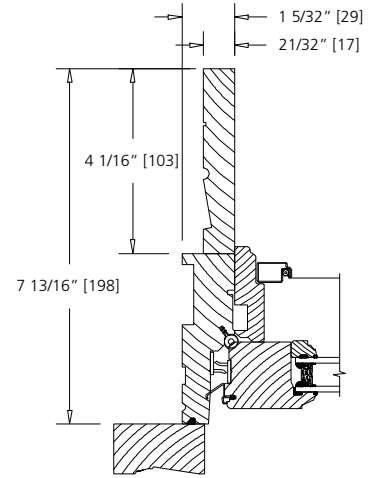

**7 13/16" WALL**  
4/4 JAMB THICKNESS (STANDARD)

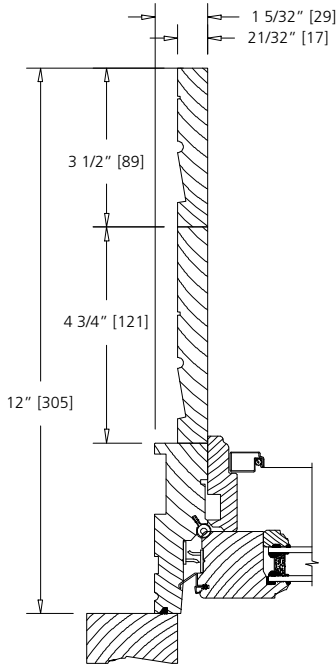

**12" WALL**  
4/4 JAMB THICKNESS (STANDARD)  
2 PC JAMB EXTENSION SHOWN

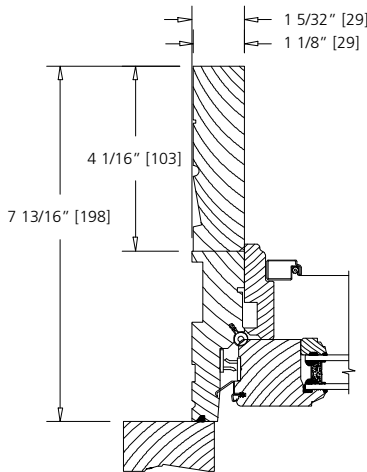

**7 13/16" WALL**  
5/4 JAMB THICKNESS (OPTION)

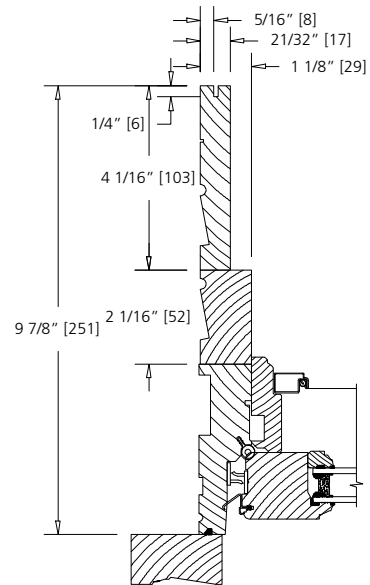

**9 7/8" WALL**  
5/4-4/4 STACKED KERFED  
JAMB OPTION

**Notes:**

Jamb Extension (9/16" thick) only available on jambs up to 6-9/16".  
Jambs over 6-9/16" will only have a 4/4 or 5/4 option.  
Jambs over 8-1/2" up to 12" will be 2 layers.  
Kerfed Jamb Extension only available on 4/4 or 5/4 options.

SCALE: 3" = 1'

STANDARD MULLION OPTIONS

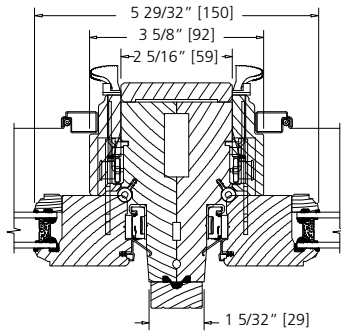

TWIN AWNING

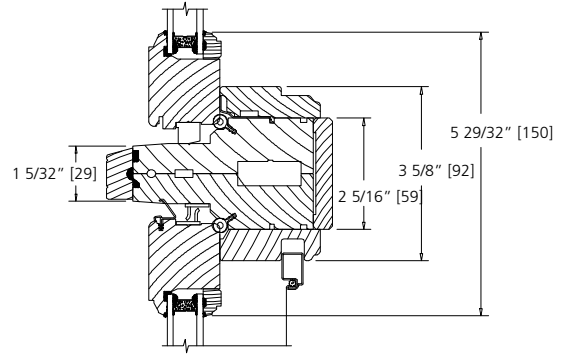

OPERATING AWNING WITH  
FIXED UNIT

**LITE CUT INFORMATION**

Wood awning windows are available with removable grilles in 7/8", 1-1/8" and 1-3/8" widths, Airspace ( between the panes) grilles, and Simulated Divided Lites. Standard lite cuts are rectangular.

**LITE CUT OPTIONS**

Special lite cut patterns can include a wide variety of straight line and radius patterns. The illustrations shown here represent just a few of the possibilities. Rectangular, horizontal, vertical and Prairie lite patterns are available in all standard size wood casement windows. Uneven, diamond, radius and Gothic lite cuts are available, subject to approval. Approvals are based on the ability to fulfill the design requirement while maintaining the construction integrity of the finished product.

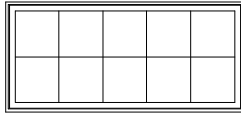

RECTANGULAR

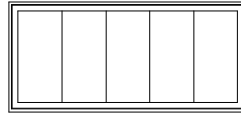

VERTICAL

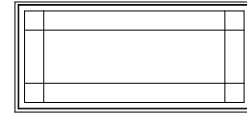

PRAIRIE

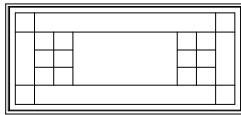

UNEVEN

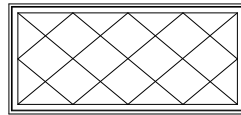

DIAMOND

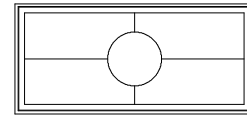

RADIUS

**BAR ALIGNMENT**

Alignment of divided lite muntin bars from one window to the next is often required by fine architectural design. Wood grilles, Airspace grilles, and Simulated Divided Lites may be specified with muntin bars aligned.

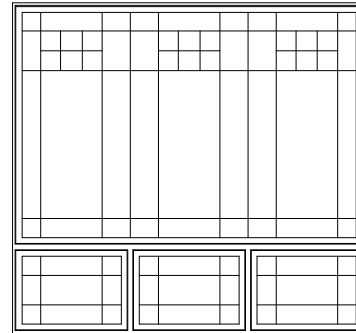



**DIVIDED LITE OPTIONS**

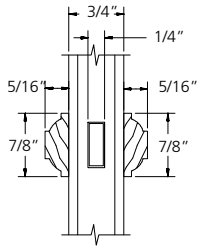

**7/8" SDL**

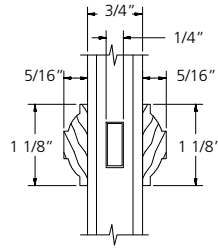

**1 1/8" SDL**

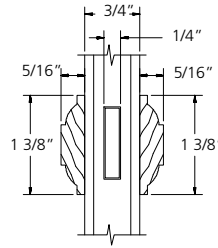

**1 3/8" SDL**

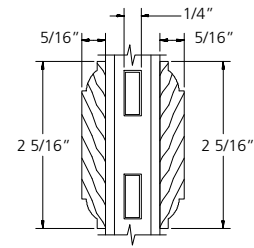

**2 5/16" SDL**

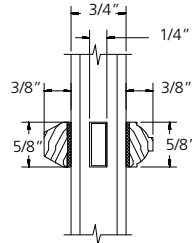

**5/8" PUTTY/BEAD SDL**

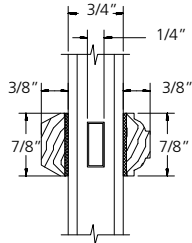

**7/8" PUTTY/BEAD SDL**

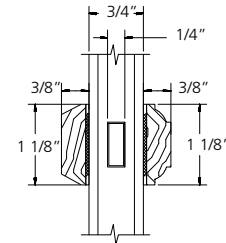

**1 1/8" PUTTY/BEAD SDL**

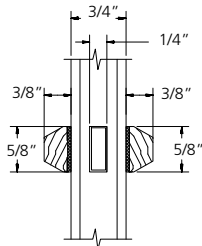

**5/8" PUTTY/PUTTY SDL**

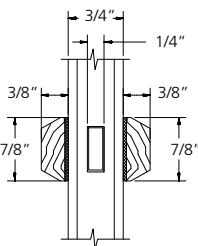

**7/8" PUTTY/PUTTY SDL**

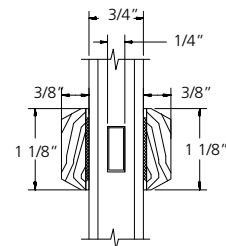

**1 1/8" PUTTY/PUTTY SDL**

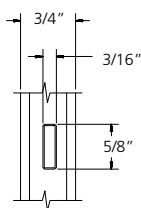

**5/8" GRILLE**

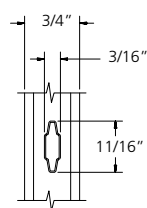

**23/32" GRILLE**

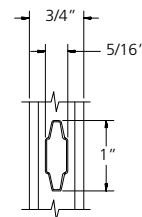

**1" GRILLE**

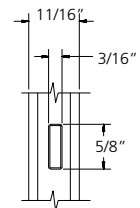

**5/8" GRILLE**

**GRILLES MEETING**

NFRC 3mm RULE

**GRILLE PROFILES:**

3/16" x 5/8"	ALLMETAL 1021101018XX140
3/16" x 1"	ALLMETAL 1020101018XX164
1/4" x 5/8"	ALLMETAL 1020102018XX140
1/4" x 1"	ALLMETAL 1020102018XX164
5.5mm x 18mm CONTOUR	ALLMETAL 1020301010XX255
8mm x 25mm CONTOUR	ALLMETAL 1020301018XX380

SCALE: NTS

**DIRECT SET DIVIDED LITE OPTIONS**

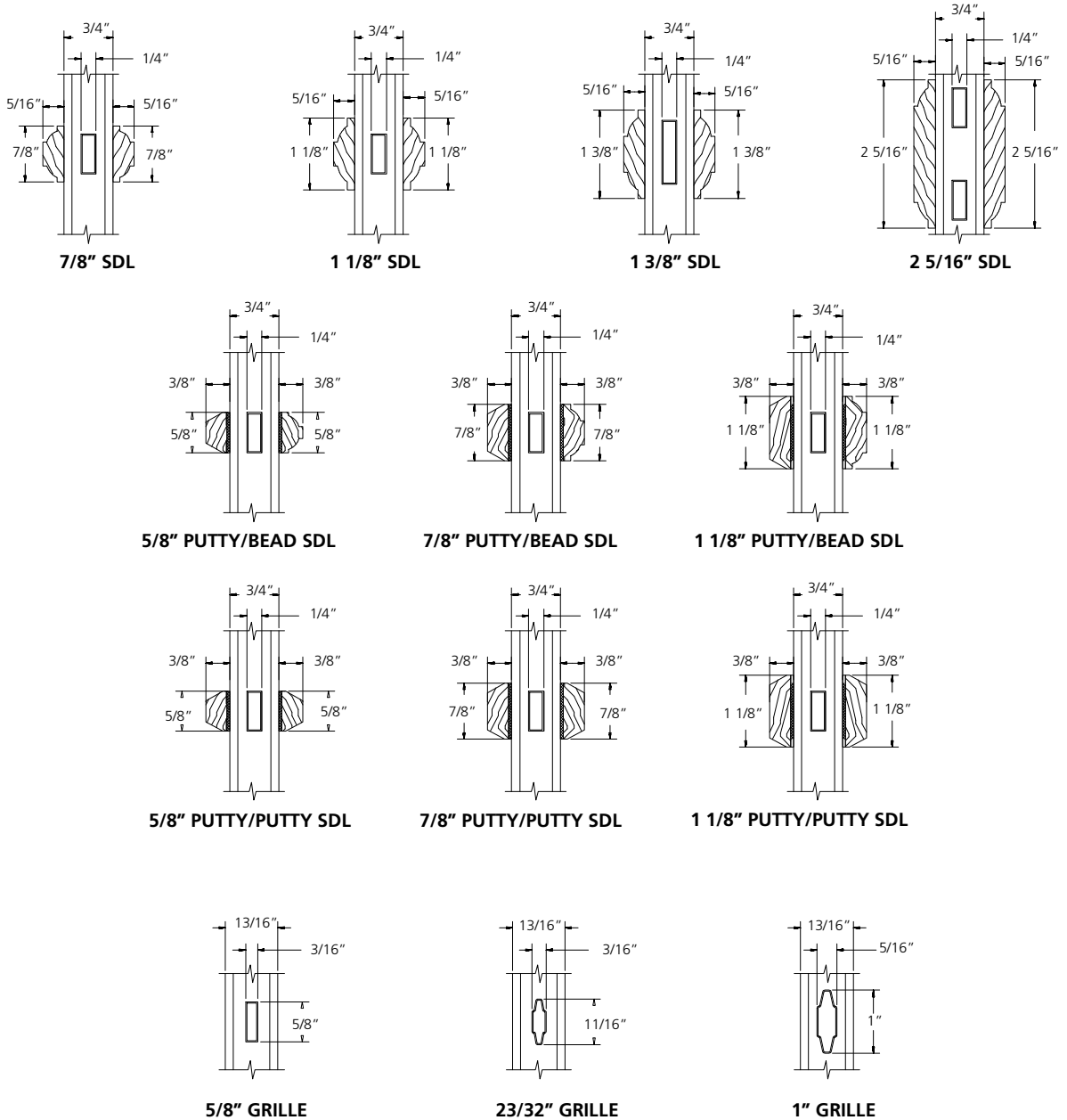

**GRILLES MEETING**

NFRC 3mm RULE

**GRILLE PROFILES:**

- 3/16" x 5/8" ALLMETAL 1021101018XX140
- 1/4" x 5/8" ALLMETAL 1020102018XX140
- 1/4" x 1" ALLMETAL 1020102018XX164
- .325" x 5/8" ALLMETAL 1020102018XX140
- .325" x 1" ALLMETAL 1020102018XX164
- 5.5mm x 18mm CONTOUR ALLMETAL 1020301010XX255
- 8mm x 25mm CONTOUR ALLMETAL 1020301018XX380

SCALE: NTS

**VENT PROJECTIONS**

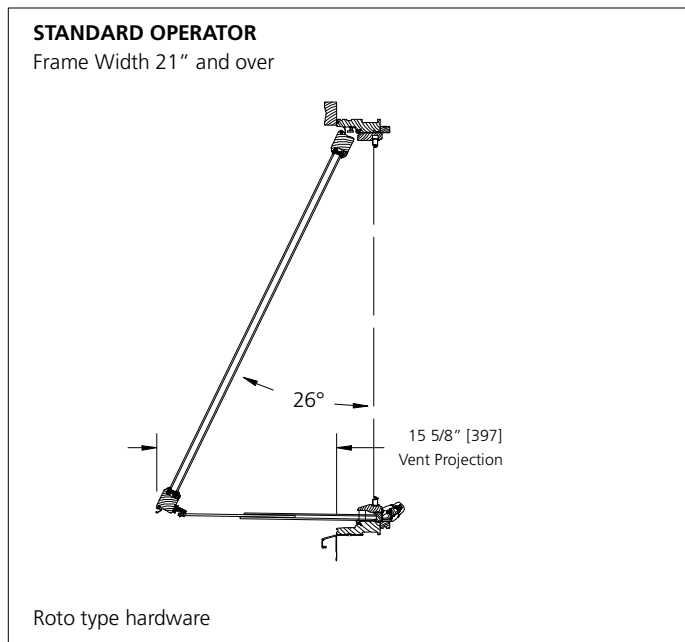
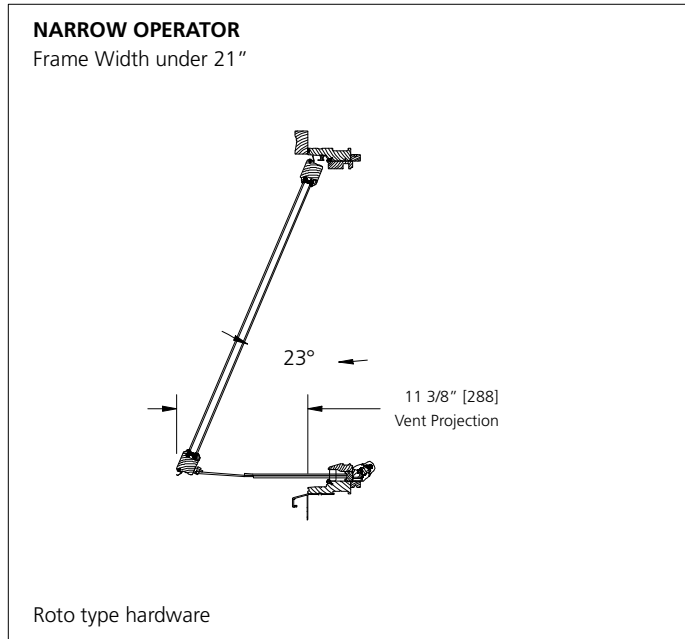

**AWNING VENT PROJECTION**

The drawings above reflect full operation. Dimensions and angles above are approximate and will vary due to frame height.

**UNIT SIZING, ROUGH OPENINGS  
& MASONRY OPENINGS**

**GENERAL NOTES:**

UNITS WITH NO TRIM AND SUBSILL:  
UNIT SIZE = FRAME SIZE

UNIT SIZE IS ALWAYS THE  
EXTREME SIZE OF THE WINDOW  
WITH OR WITHOUT TRIM

**MASONRY OPENING:**  
MASONRY OPENING IS ALWAYS 1/2" OVER  
THE UNIT SIZE OF THE WINDOW

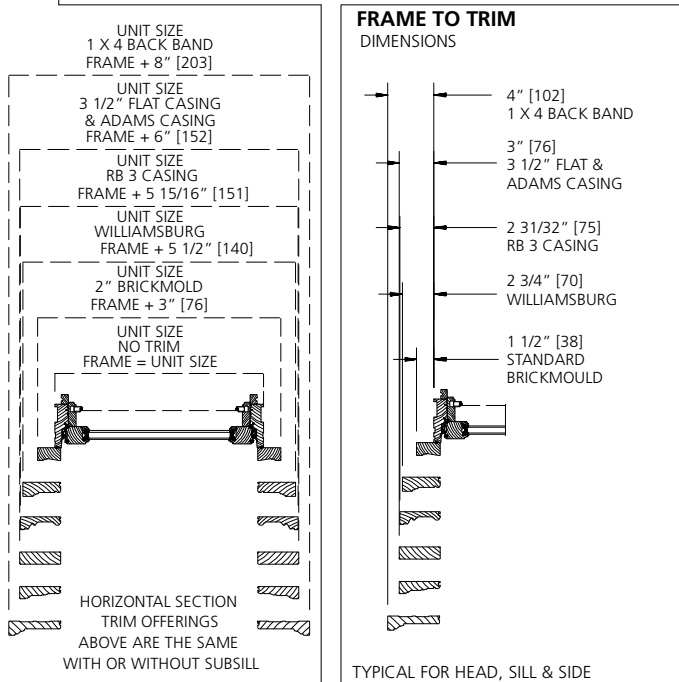
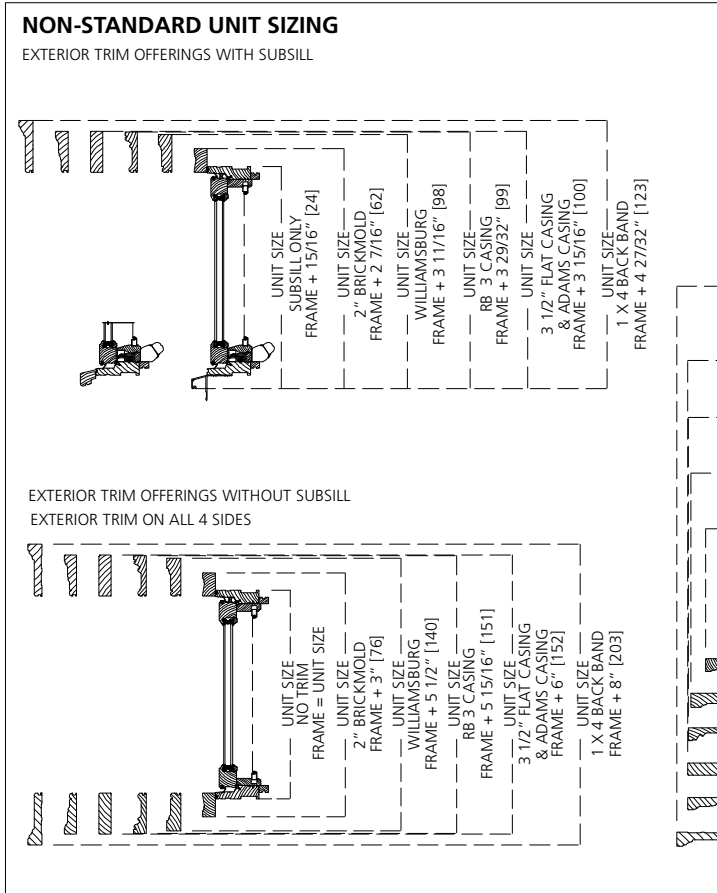
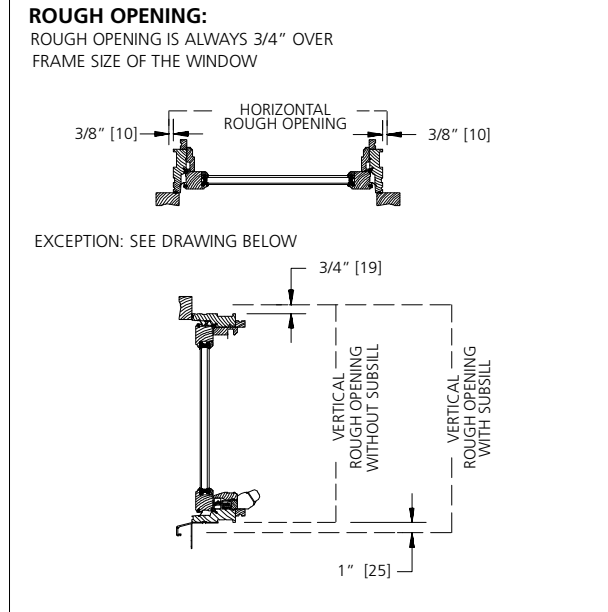
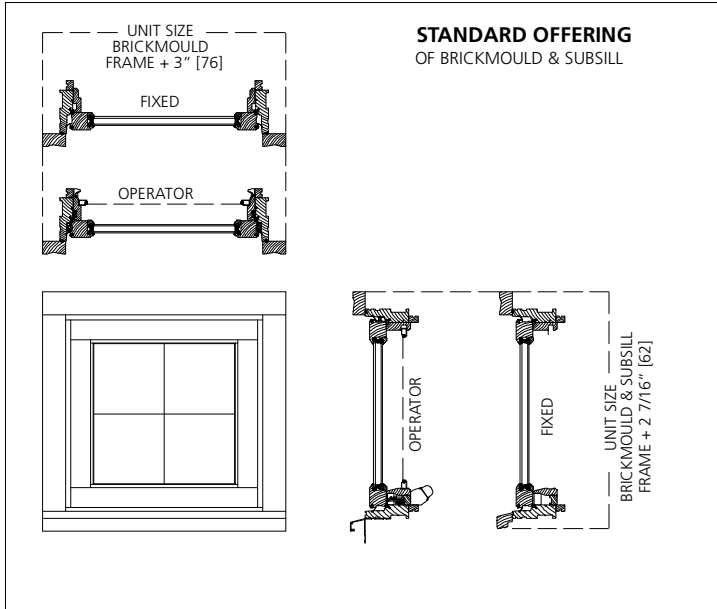

**1-WIDE UNIT**

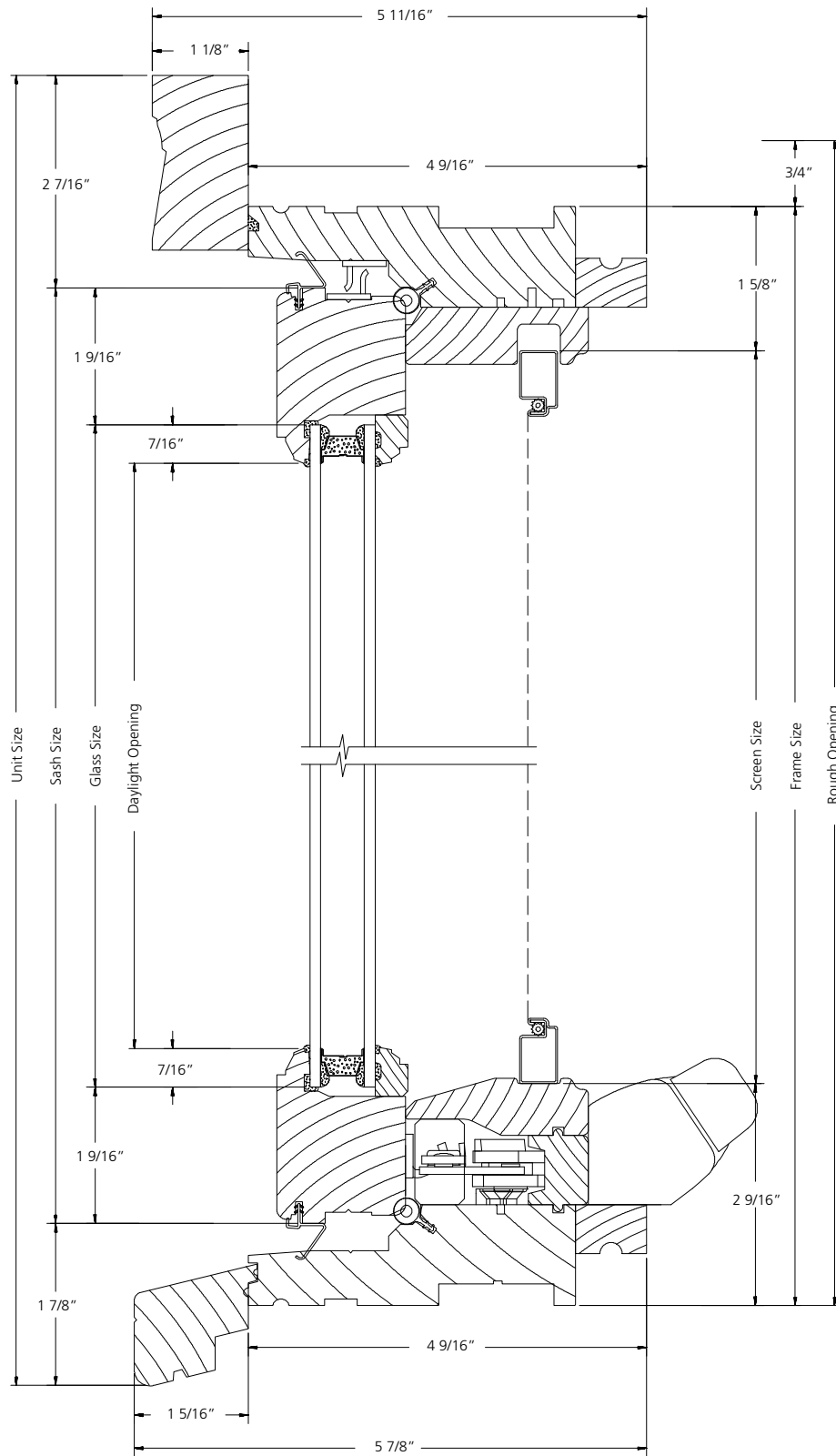

**VERTICAL SECTION**

SCALE: 6" = 1'

**1-WIDE UNIT**

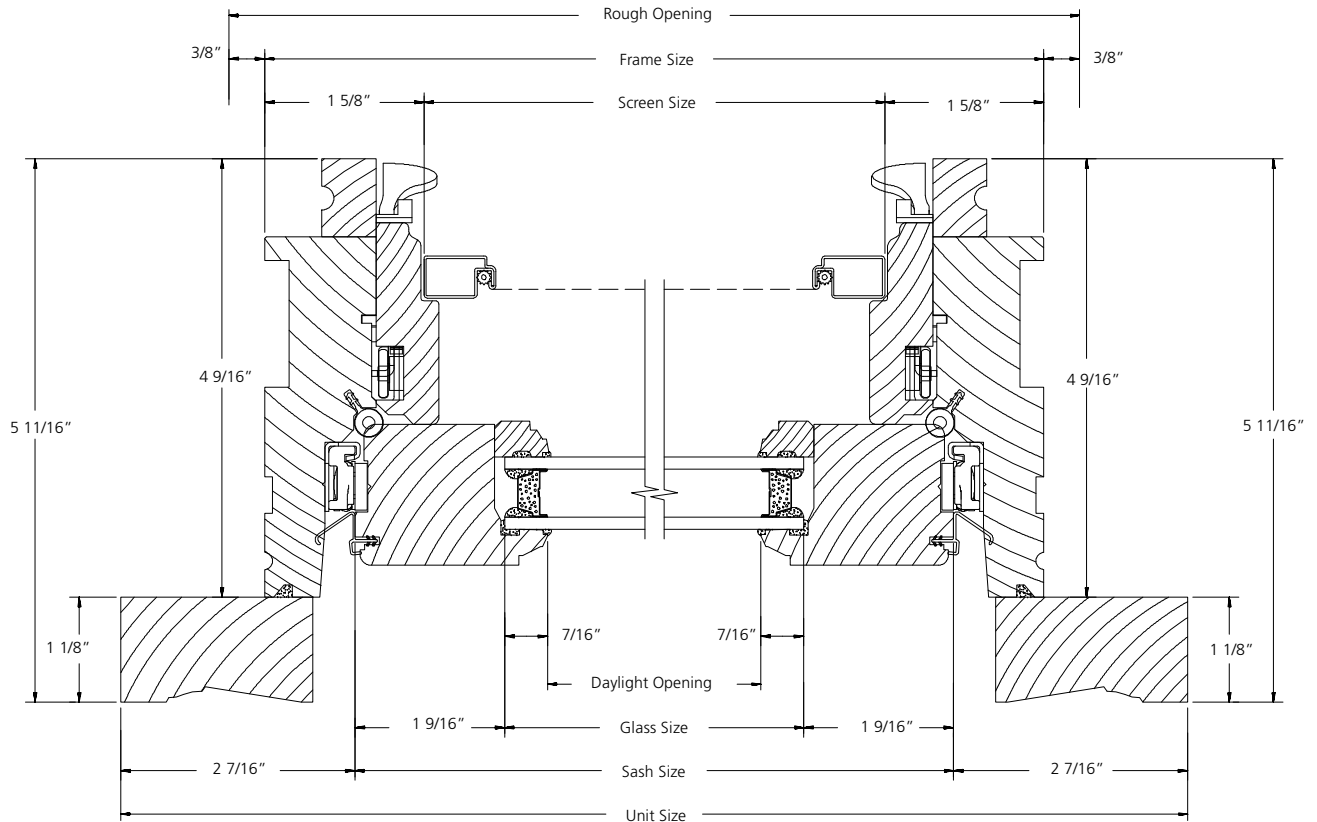

**HORIZONTAL SECTION**

SCALE: 6" = 1'

**PICTURE UNIT**

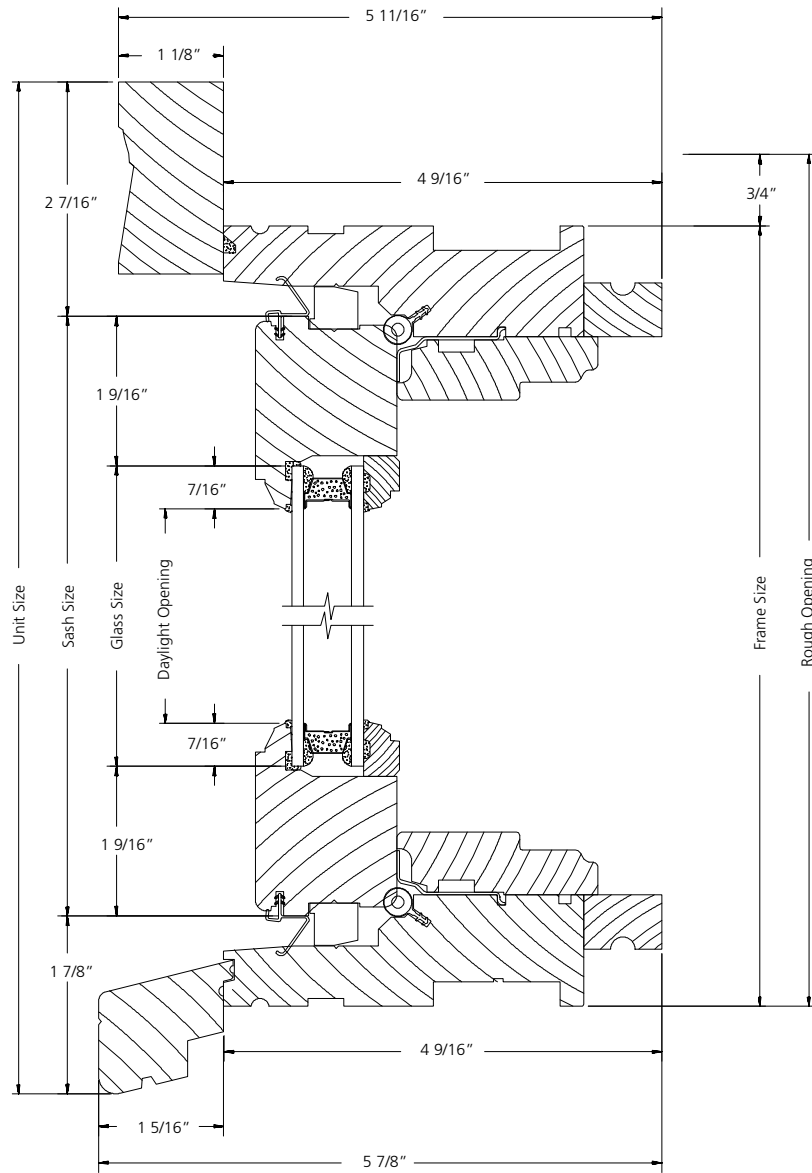

**VERTICAL SECTION**

SCALE: 6" = 1'

**PICTURE UNIT**

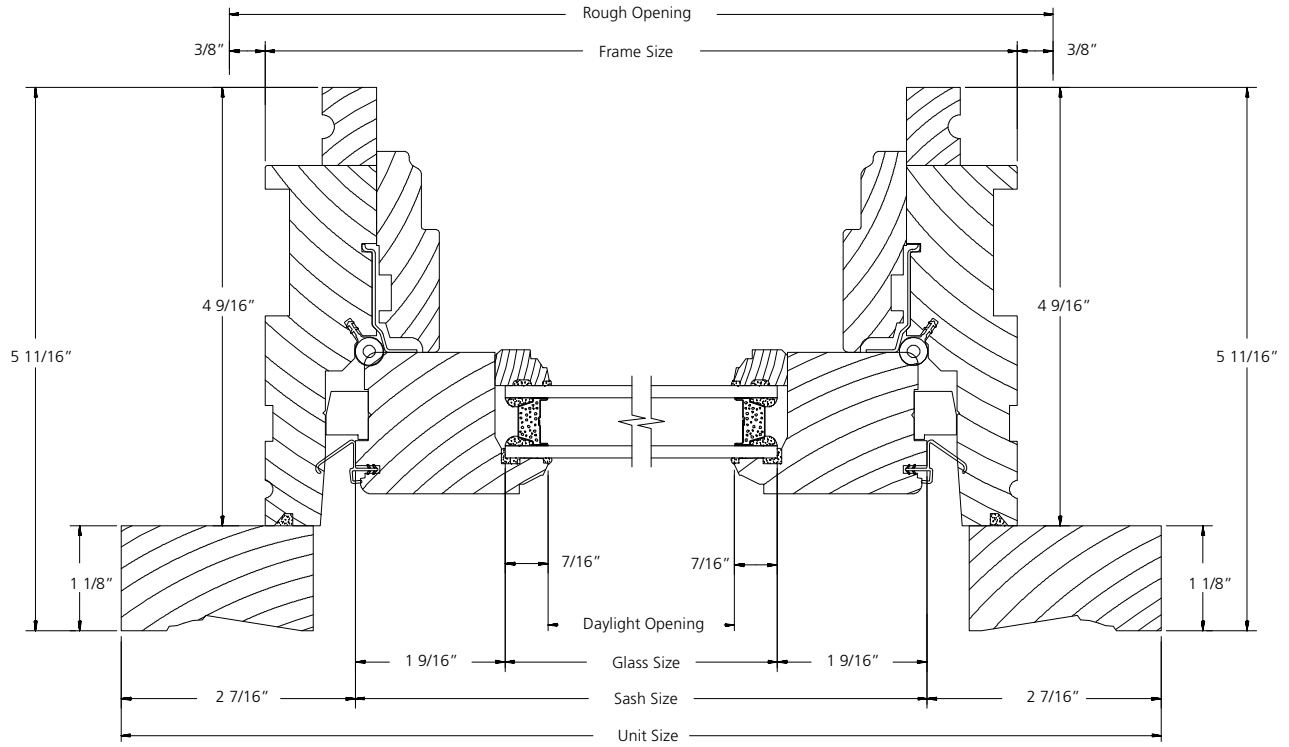

**HORIZONTAL SECTION**

SCALE: 6" = 1'