

TABLE OF CONTENTS

Specifications	5-2
Quick Spec Guide	5-4
Elevations/Sizes: 1/4" Scale	5-6
Double-Hung	5-9
Double-Hung Picture	5-20
Double-Hung Picture with Flankers	5-30
Sector Top	5-32
Full Radius	5-45
Transoms	5-54
Sash Glazing Options: 3" Scale	5-56
Trim Options: 3" Scale	5-57
Jamb Options: 3" Scale	5-59
Standard Mullion Options	5-60
Lite Cut Information	5-62
Unit Sizing, Rough Openings & Masonry Openings	5-64
Section Details: 6" Scale	5-66
Angle Bay Specification and Rough Opening Information	5-84
Section Details: 3" Scale (Angle Bay)	5-86

PRODUCT SPECIFICATIONS**EXTERIOR FINISH**

Exterior aluminum surfaces are low maintenance extruded aluminum coated with a thermo set polyester finish that meets or exceeds the AAMA 2603 performance standards. Standard colors include Brilliant White, Chestnut Bronze, Desert Sand, French Vanilla, Hartford Green, Mesa Red, Black, Arctic Silver and Dark Chocolate.

AURALAST® WOOD

AuraLast® wood is fundamentally different from wood resulting from traditional millwork preservation processes in that it uses a proprietary vacuum/pressure process to provide protection throughout the wood parts used to make windows and doors. AuraLast® wood is distinguished from wood using the current preservation methods by its unique ability to achieve greater penetration of the active ingredients into the wood parts, with a penetration of the treatment being a minimum of 92%.

INTERIOR FINISH

All interior surfaces are unfinished clear pine ready for on site finishing. Primed and pre-finished interiors are available in paint: Pure White, Extra White, Natural Choice, Moderate White; in stain: Wheat, Cherry, Fruitwood, Cordovan, Cider and Clear Lacquer. Optional interior wood species include mixed grain Douglas Fir and Knotty Alder.

FRAME

Frame is assembled from select kiln dried pine using AuraLast® wood on all exterior parts. Exterior surface is covered with .050 (1.27mm) extruded aluminum cladding. Frame corners at head are mechanically fastened over a silicone injected nylon corner key. Sill corner joints are tightly sealed with a foam gasket and reinforced with screw boss construction. Frame thickness is 11/16" (17.5mm) at head, side jamb and sill. Basic jamb width is 4-9/16" (116mm) and may be extended for different wall depths. Integral nailing fin is part of extrusion on all four sides. Assembled frame includes all weather-stripping and hardware installed. Exterior of frame extrusion is grooved to accept accessories.

SASH

Sash is 1-7/16" (36.5mm) thick and combines an extruded aluminum exterior with select kiln-dried pine using AuraLast® wood. Corner joints are mortise and tenoned, machine clamped for squareness and secured with metal fasteners. Exterior surfaces are covered with .045 (1.2mm) extruded aluminum, corners are clamped and sealed with silicone. Sash operate in a non-compression ivory colored jamb liner that allows both top and bottom sash to tilt inside for easy cleaning and removal without the use of tools. No finger plow sash available on venting units.

GLAZING

3/4" (19mm) thick sealed insulating glass is constructed from two panes of glass, utilizing a continuous roll formed stainless steel spacer with dual seal sealant. The glass is mounted into the sash using a silicone-glazing compound and secured with interior applied profiled wood stops. All insulating glass units comply with the performance requirements of IGCC in accordance with either ASTM E774 or E2190.

GLAZING OPTIONS

3/4" insulating glass available in Low-E with Argon, Low-E, Low-E 366, Clear, Neat Glass, reflective, tinted, or obscure, tempered or other specialty glass as specified. Preserve® film is a 0.003" thick polyethylene film with a low tack acrylic adhesive applied to the glass for protection during shipping and installation. 4,000 foot elevations and higher require a capillary tube to equalize environmental stress (otherwise known as High Altitude glazing). High Altitude glazing does not allow the use of Argon as listed under glazing options.

WEATHER-STRIPPING

Engineered system combines PVC ivory jamb liner with dual bulb weather-stripping at head. Checkrail features thermoplastic rubber bulb and recessed cam action sash lock for secure closure. Rigid vinyl water stops at sill provide additional restraint against weather.

HARDWARE

Sash operate by means of a dual block and tackle balance system with nylon roller pulleys and high-tension coil springs. Balance system gauged to sash weight and uses pre-stretched dacron cords attached to clutch mechanisms to insure smooth, operation and compliance with operating force requirements. Jamb liners are Ivory (White is optional). Recessed cam action sash lock is available in White, Chestnut Bronze, Desert Sand or optional Bright Brass, Antique Brass, Polished Brass, Brushed Chrome or Imitation Oil Rubbed Bronze. 28" glass width and larger units have two sash locks. Optional Lexan sash lift available for no finger plow sash.

EXTERIOR INSECT SCREENS

Charcoal fiberglass screen cloth (18x16 mesh) set in painted roll formed aluminum frame with color to match cladding - choice of Brilliant White, Chestnut Bronze, Desert Sand, French Vanilla, Hartford Green, Mesa Red, Black, Arctic Silver or Dark Chocolate, installed in channel on frame extrusion and held in place with spring loaded plungers at the top and sides of screen. Aluminum mesh and Phantom screen also available. Insect screens are intended to allow air and light in and to keep insects out. They are not intended to keep anyone or anything from falling through an open window. For safety screens or other security devices contact your local building supply retailer.

GRILLES

SDL (Simulated Divided Lites) - extruded aluminum muntins permanently applied to the exterior of the insulating glass unit (not available on textured glass) in 7/8" (22mm), 1-1/8" (28.5mm), or 1-3/8" (34.9mm) widths, and a putty profile in 5/8" (15.9mm), 7/8" (22mm) and 1-1/8" (28.5mm) widths only. SDL is standard with a light bronze internal shadow bar to give a true divided lite appearance. As an option, SDL may be ordered with a silver shadow bar. Clear wood interior muntin bars match the exterior muntin width and are permanently bonded to the interior of the glass. Also available is a 2-5/16" (59mm) SDL bar, which simulates a double-hung checkrail.

Full Surround Wood Grilles - Rectangular unfinished clear pine wood grilles in 7/8" (22mm), 1-1/8" (28.6mm) and 1-3/8" (35mm) are available in patterns selected by the owner.

GBG (Grilles between the Glass) - 5/8" (15.9mm) flat and 23/32" or 1" contour mounted between the glass panes suspended within the air cavity.

EXTERIOR TRIM

1-5/8" (41mm) wide aluminum brickmould or Adams casing with an integral nailing fin is available factory applied. Also available is 3-1/2" (88.5mm) flat casing with an integral nailing fin. All of the accessories are .050" (1.3mm) extruded aluminum. Two sizes of frame expander, 1-7/8" (48mm) and 3-1/4" (83mm) may be used alone or in conjunction with a 2-1/8" (54mm) mull expander. Standard 5/16" (8mm) clad mull cover used for joining windows together. Windows may also be joined with 1" (25.4mm), 2" (51mm), or 4" (102mm) mull covers. Color and finish match exterior finish specs above.

Continued on next page

PRODUCT SPECIFICATIONS

EXTENSION JAMBS

Extension jambs are factory applied to the interior on all four sides of the frame and are 4/4 standard thick pine to accommodate wall depths up to 9-5/16" with one piece, and up to 12" with two pieces. 9/16" (14.2mm) option also available.

INSTALLATION

Installation per JELD-WEN Installation Method for Metal Clad Windows JII002 or JII013. See www.jeld-wen.com/resources for instructions.

PERFORMANCE

NFRC Certified - (Rated and labeled in accordance with NFRC)

WDMA Hallmark Certified -
In accordance with **AAMA/NWWDA/101/I.S.2-97**

QUICK SPEC GUIDE

SPECIFICATION	STANDARD FEATURES	OPTIONAL FEATURES <i>Some options may require additional lead times. Consult your JELD-WEN Sales Representative.</i>
EXTERIOR FINISH	<ul style="list-style-type: none"> • Brilliant White • Chestnut Bronze • Desert Sand • French Vanilla • Mesa Red • Hartford Green • Black • Arctic Silver • Dark Chocolate 	<ul style="list-style-type: none"> • Bronze • Heirloom White • Bone White • Dark Buckskin • Smoke • Mocha Cream • Hunter Green • Sage Brown • Redwood • Sea Foam • Ivory • Cascade
EXTERIOR TRIM	<ul style="list-style-type: none"> • Nailing Fin • Vinyl Drip Cap 	<ul style="list-style-type: none"> • Aluminum 1-5/8" Brickmould with integral nailing fin • 3-1/2" Flat Casing with integral nailing fin • Adams Clad Brickmould with integral nailing fin • Clad Metal Drip Cap
INTERIOR WOOD	<ul style="list-style-type: none"> • Western Pine 	<ul style="list-style-type: none"> • Knotty Alder • Mixed Grain Douglas Fir
INTERIOR FINISH	<ul style="list-style-type: none"> • Natural 	<ul style="list-style-type: none"> • Priming Available <p>Pre-finished Interior Options are:</p> <ul style="list-style-type: none"> • Paint - Pure White, Extra White, Natural Choice, Moderate White • Stain - Wheat, Fruitwood, Cherry, Cordovan, Cider • Clear Lacquer
SIZE	<ul style="list-style-type: none"> • Width: Venting Double-Hung: 21-3/8, 25-3/8, 29-3/8, 31-3/8, 33-3/8, 37-3/8, 41-3/8, 45-3/8 Picture Double-Hung: 21-3/8, 25-3/8, 29-3/8, 31-3/8, 33-3/8, 37-3/8, 41-3/8, 45-3/8, 49-3/8, 53-3/8, 61-3/8, 69-3/8, 77-3/8 • Height: Venting Double-Hung: 32, 36, 40, 44, 48, 52, 56, 60, 64, 68, 72, 76, 80, 88, 92 Picture Double-Hung: 15, 18, 24, 32, 36, 40, 44, 48, 52, 56, 60, 64, 68, 72, 76, 80, 88, 92 • For RO, add 3/4" 	<ul style="list-style-type: none"> • Width: Venting Double-Hung: Minimum: 16" Maximum: 45-3/8" Picture Double-Hung: Minimum: 16" Maximum: 77-3/8" Fixed Units over 49-3/8" wide can be up to 80" high Fixed Units up to 49-3/8" wide can be up to 92" high • Height: Venting Double-Hung: Minimum: 28" Maximum: 92" * * glass can't exceed 42" high Picture Double-Hung: Minimum: 15" Maximum: 92" Fixed Units over 49-3/8" wide can be up to 80" high Fixed Units up to 49-3/8" wide can be up to 92" high • For RO, add 3/4"
GLAZING	<ul style="list-style-type: none"> • Low-E Insulating Glass • Preserve® Protective Film 	<ul style="list-style-type: none"> • Clear • Obscure • Bronze • Low-E 366 • Neat Glass • Dual Low-E • Reflective • Tempered
		<ul style="list-style-type: none"> • Commercial Grade Kynar 500® Resin System • High Altitude

Continued on next page

QUICK SPEC GUIDE

SPECIFICATION	STANDARD FEATURES	OPTIONAL FEATURES <i>Some options may require additional lead times. Consult your JELD-WEN Sales Representative.</i>
GRILLES		<ul style="list-style-type: none"> • 5/8" Flat, 23/32" or 1" Contour GBG • 7/8", 1-1/8", 1-3/8" Full Surround Wood Grilles SDL Bead Profile: <ul style="list-style-type: none"> • 7/8", 1-1/8", 1-3/8", 2-5/16" with Light Bronze Shadow Bar • 7/8", 1-1/8", 1-3/8", 2-5/16" with Silver Shadow Bar SDL Putty Profile: <ul style="list-style-type: none"> • 5/8", 7/8", 1-1/8" with Light Bronze Shadow Bar • 5/8", 7/8", 1-1/8" with Silver Shadow Bar
HARDWARE	<ul style="list-style-type: none"> • Balance: Dual Block and Tackle • Cam Locks • Ivory Jamb Liners (standard) 	<ul style="list-style-type: none"> • White
HARDWARE COLOR	<ul style="list-style-type: none"> • White • Desert Sand • Chestnut Bronze 	<ul style="list-style-type: none"> <li style="width: 50%;">• Antique Brass <li style="width: 50%;">• Brushed Chrome <li style="width: 50%;">• Polished Brass <li style="width: 50%;">• Oil Rubbed Bronze
JAMB	<ul style="list-style-type: none"> • 4-9/16" 	<ul style="list-style-type: none"> • Minimum: 4-9/16" • Maximum: 9-5/16" (one piece) • Maximum: 12" (two piece)
SCREENS	<ul style="list-style-type: none"> • BetterVue™ 	<ul style="list-style-type: none"> • Aluminum Mesh available • Phantom Screen - Limitations apply, factory-applied • UltraVue™
SCREEN FRAME COLOR	<ul style="list-style-type: none"> <li style="width: 50%;">• Brilliant White <li style="width: 50%;">• Hartford Green <li style="width: 50%;">• Chestnut Bronze <li style="width: 50%;">• Black <li style="width: 50%;">• Desert Sand <li style="width: 50%;">• Arctic Silver <li style="width: 50%;">• French Vanilla <li style="width: 50%;">• Dark Chocolate <li style="width: 50%;">• Mesa Red 	<ul style="list-style-type: none"> <li style="width: 50%;">• Bronze <li style="width: 50%;">• Hunter Green <li style="width: 50%;">• Heirloom White <li style="width: 50%;">• Sage Brown <li style="width: 50%;">• Bone White <li style="width: 50%;">• Redwood <li style="width: 50%;">• Dark Buckskin <li style="width: 50%;">• Sea Foam <li style="width: 50%;">• Smoke <li style="width: 50%;">• Ivory <li style="width: 50%;">• Mocha Cream <li style="width: 50%;">• Cascade <ul style="list-style-type: none"> • Commercial Grade Kynar 500® Resin System

GENERAL INFORMATION
DOUBLE-HUNG

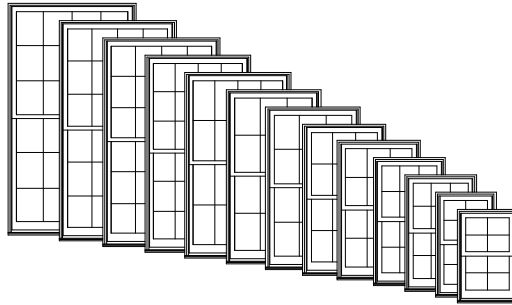

DIMENSIONAL WINDOWS

Clad double-hung windows may be specified as "dimensional" by adjusting the the desired rough opening width or height in 1/4" increments from standard.

Clad double-hung windows feature fully operating upper and lower sash. Counterbalancing is achieved with block and tackle spring extension systems hidden in weatherable PVC jamb liners. Operating units are supplied with cam-type sash locks installed. Die-cast lower sash lifts supplied for field installation are an option. Recessed sash retainers provide simple sash installation and removal. There are several hardware finish options. Refer to the Specifications for available finish options.

MULTIPLE ASSEMBLIES

Clad double-hung windows may be mullied beside other clad double-hungs or clad picture windows, or below clad transom windows, to fulfill a wide variety of needs. Factory assembled mulls are limited in height (100"), width (114"), and a total area (75 square feet).

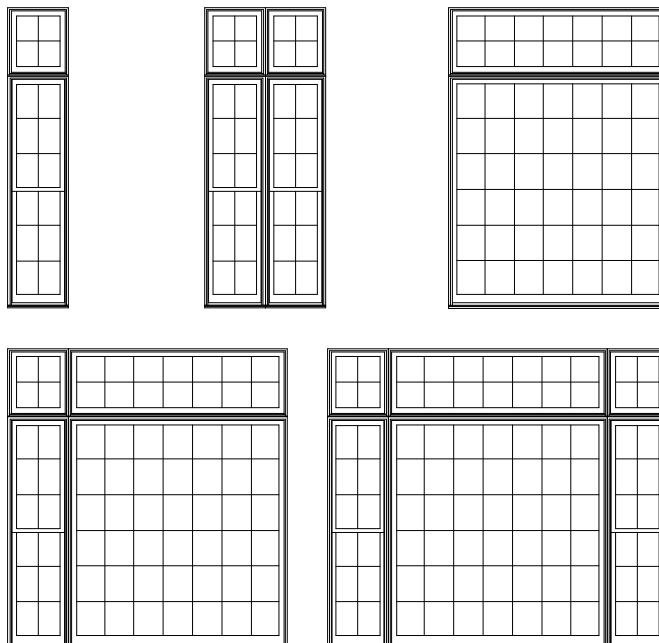

**HANDING & OPERATION
DOUBLE-HUNG**

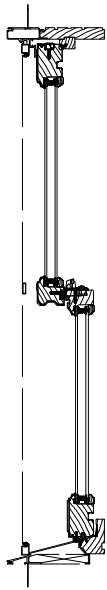

DOUBLE-HUNG OPERATION:
When the sash are locked at the check rails the sash are closed and sealed in the sash opening of the frame.

When the sash are unlocked the lower sash travels vertically to any position desired. The upper sash can also be positioned as desired.

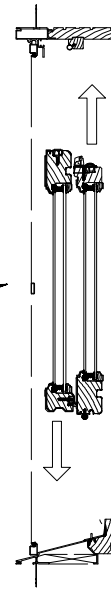

SASH TILTING FOR WASHING

The Custom Double-Hung window will allow the sash to be tilted or removed for easy cleaning.

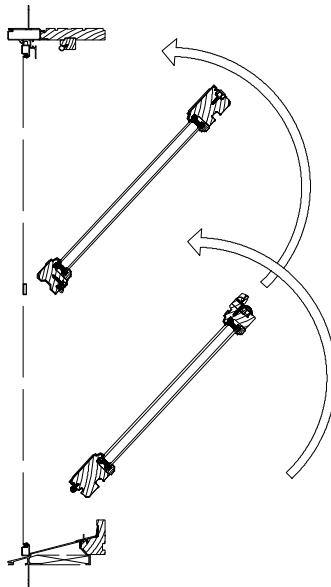

ELEVATION NOTES
DOUBLE-HUNG

ELEVATION DRAWINGS UTILIZE A LIMITED NUMBER OF PROJECTED LINES TO PRODUCE A RUDIMENTARY DRAWING INTENDED TO BE USED IN A SMALL GRAPHICAL SCALE. ELEVATIONS ARE VIEWED PERPENDICULAR FROM THE EXTERIOR OF THE STRUCTURE. IF MORE DIMENSIONS ARE NEEDED, USE THE SECTION DRAWINGS FOR MORE COMPLETE DEPICTIONS.

M.O. Brickmould
M.O. Adams/Flat Casing
Rough Opening
Frame Size
Daylight Opening

24 7/8" (632)
27 7/8" (708)
22 1/8" (562)
21 3/8" (543)
14 13/16" (376)

Masonry Openings for Brickmould, Flat & Adams Casing.
Vertical measurements include sillnose.
(Subtract 1/2" from Masonry Opening for Unit Size)

42 5/16" (1075)
43 13/16" (1113)
40 3/4" (1035)
40" (1016)
15 1/16" (383)[2]

DAYLIGHT OPENING

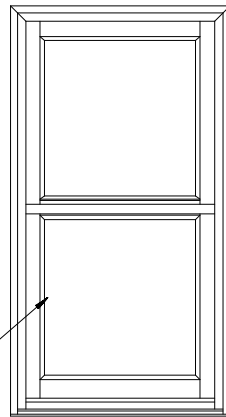

OUTSIDE OF FRAME

COTTAGE STYLE WINDOWS
BOOK CODES

ECD2168C

UNIT WIDTH
UNIT HEIGHT
C = COTTAGE

ECD2140

'ECD' INDICATES
SITELINE EX CLAD DOUBLE-HUNG

BOOK CODE

THE FIRST TWO NUMBERS
INDICATE THE UNIT WIDTH

THE LAST TWO NUMBERS INDICATE
THE UNIT HEIGHT

GENERAL DOUBLE-HUNG NOTES

1. ALL UNITS SHOWN ARE AVAILABLE AS OPERATORS ONLY.
2. UNIT ELEVATIONS ARE SHOWN WITHOUT EXTERIOR TRIM.
3. ALL OPERATING SASH ARE INSTALLED WITH VINYL JAMB LINERS AND OPERATED WITH AN INTERNAL BLOCK AND TACKLE SPRING SYSTEM.
4. DIMENSIONAL VALUES IN PARENTHESES ARE MILLIMETER CONVERSIONS.
5. VALUES IN BRACKETS ARE NUMBER OF DAYLIGHT OPENINGS.

ELEVATION SYMBOL LEGEND:

MO MASONRY OPENING

1-WIDE UNITS

M.O. BRICKMOLD
M.O. ADAMS/FLAT CASING
ROUGH OPENING
FRAME SIZE
DAYLIGHT OPENING

24 7/8"(632)
27 7/8"(708)
22 1/8"(562)
21 3/8"(543)
14 13/16"(376)

28 7/8"(733)
31 7/8"(810)
26 1/8"(664)
25 3/8"(645)
18 13/16"(478)

32 7/8"(835)
35 7/8"(911)
30 1/8"(765)
29 3/8"(746)
22 13/16"(579)

34 7/8"(886)
37 7/8"(962)
32 1/8"(816)
31 3/8"(797)
24 13/16"(630)

36 7/8"(937)
39 7/8"(1013)
34 1/8"(867)
33 3/8"(848)
26 13/16"(681)

40 7/8"(1038)
43 7/8"(1114)
38 1/8"(968)
37 3/8"(949)
30 13/16"(783)

44 7/8"(1140)
47 7/8"(1216)
42 1/8"(1070)
41 3/8"(1051)
34 13/16"(884)

34 5/16"(872)
35 13/16"(910)
32 3/4"(832)
32"(813)
11 1/16"(281) [2]

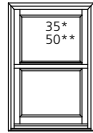

ECD2132

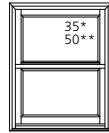

ECD2532

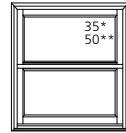

ECD2932

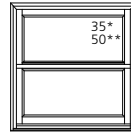

ECD3132

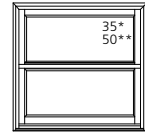

ECD3332

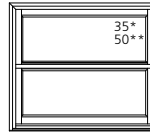

ECD3732

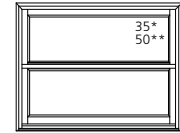

ECD4132

38 5/16"(973)
39 13/16"(1011)
36 3/4"(933)
36"(914)
13 1/16"(332) [2]

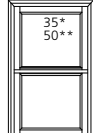

ECD2136

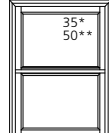

ECD2536

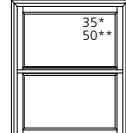

ECD2936

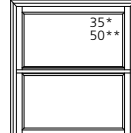

ECD3136

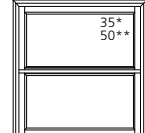

ECD3336

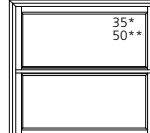

ECD3736

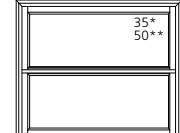

ECD4136

42 5/16"(1075)
43 13/16"(1113)
40 3/4"(1035)
40"(1016)
15 1/16"(388) [2]

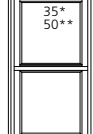

ECD2140

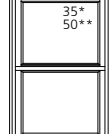

ECD2540

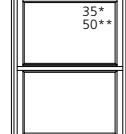

ECD2940

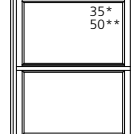

ECD3140

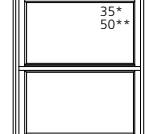

ECD3340

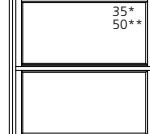

ECD3740

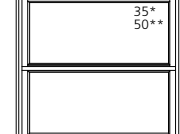

ECD4140

46 5/16"(1176)
47 13/16"(1214)
44 3/4"(1137)
44"(1118)
17 1/16"(433) [2]

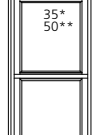

ECD2144

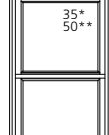

ECD2544

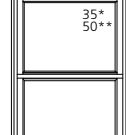

ECD2944

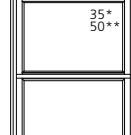

ECD3144

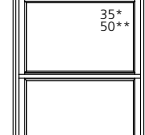

ECD3344

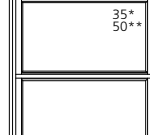

ECD3744

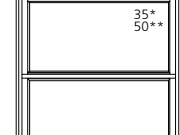

ECD4144

50 5/16"(1278)
51 13/16"(1316)
48 3/4"(1238)
48"(1219)
19 1/16"(484) [2]

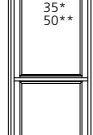

ECD2148

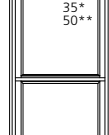

ECD2548

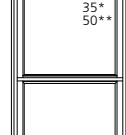

ECD2948

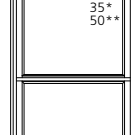

ECD3148

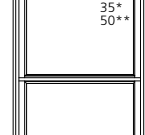

ECD3348

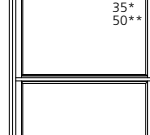

ECD3748

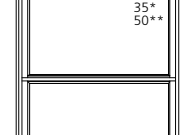

ECD4148

54 5/16"(1380)
55 13/16"(1418)
52 3/4"(1340)
52"(1321)
21 1/16"(535) [2]

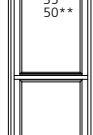

ECD2152

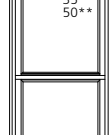

ECD2552

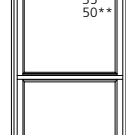

ECD2952

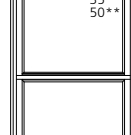

ECD3152

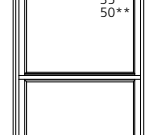

ECD3352

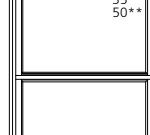

ECD3752

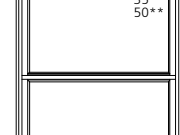

ECD4152

58 5/16"(1481)
59 13/16"(1519)
56 3/4"(1441)
56"(1422)
23 1/16"(586) [2]

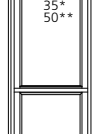

ECD2156

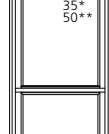

ECD2556

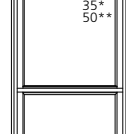

ECD2956

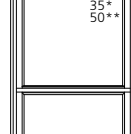

ECD3156

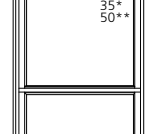

ECD3356

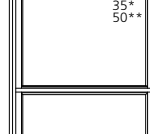

ECD3756

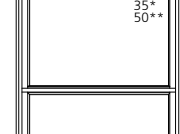

ECD4156

ELEVATION SYMBOL LEGEND:

M.O. = MASONRY OPENING
VALUES IN () ARE IN MILLIMETER CONVERSIONS
VALUES IN [] ARE NUMBER OF DAYLIGHT OPENINGS PER UNIT

E UNIT MEETS EGRESS REQUIREMENTS FOR IRC CODE. STATE AND LOCAL CODES MAY DIFFER. ALWAYS REFER TO LOCAL BUILDING CODES FOR COMPLETE REQUIREMENTS.
CHECK WITH LOCAL OFFICIALS TO ENSURE COMPLIANCE BEFORE INSTALLING THE UNIT.

INDICATES DESIGN PRESSURE (DP) RATING WITH STANDARD GLAZING

###* INDICATES OPTIONAL DESIGN PRESSURE (DP) RATING

Note: Elevations shown DO NOT have exterior trim. Subtract 1/2" (12.7) from M.O. (Masonry Opening) for Unit Sizes. Masonry Openings above include Sill Nose, see Trim Options page for Sill Nose specifications. For other Trim Options refer to the Unit Sizing, Rough Opening & Masonry Openings page.

SCALE 1/4" = 1'

1-WIDE UNITS

M.O. BRICKMOULD
M.O. ADAMS/FLAT CASING
ROUGH OPENING
FRAME SIZE
DAYLIGHT OPENING

24 7/8" (632)	28 7/8" (733)	32 7/8" (835)	34 7/8" (886)	36 7/8" (937)	40 7/8" (1038)	44 7/8" (1140)
27 7/8" (708)	31 7/8" (810)	35 7/8" (911)	37 7/8" (962)	39 7/8" (1013)	43 7/8" (1114)	47 7/8" (1216)
22 1/8" (562)	26 1/8" (664)	30 1/8" (765)	32 1/8" (816)	34 1/8" (867)	38 1/8" (968)	42 1/8" (1070)
21 3/8" (543)	25 3/8" (645)	29 3/8" (746)	31 3/8" (797)	33 3/8" (848)	37 3/8" (949)	41 3/8" (1051)
14 13/16" (376)	18 13/16" (478)	22 13/16" (579)	24 13/16" (630)	26 13/16" (681)	30 13/16" (783)	34 13/16" (884)

62 5/16" (1583)
63 13/16" (1621)
60 3/4" (1543)
60" (1524)
25 1/16" (637)(2)

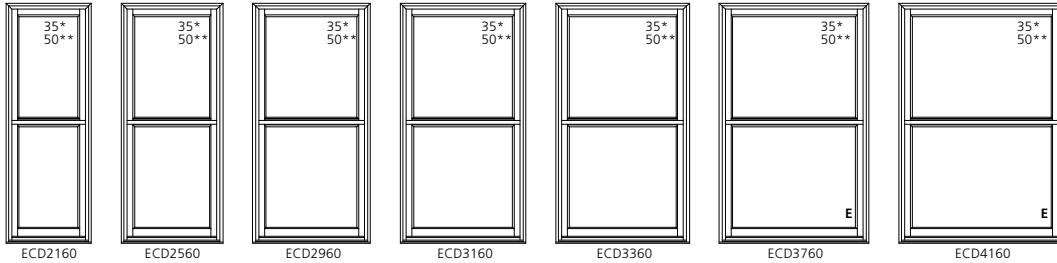

66 5/16" (1684)
67 13/16" (1722)
64 3/4" (1645)
64" (1626)
27 1/16" (687)(2)

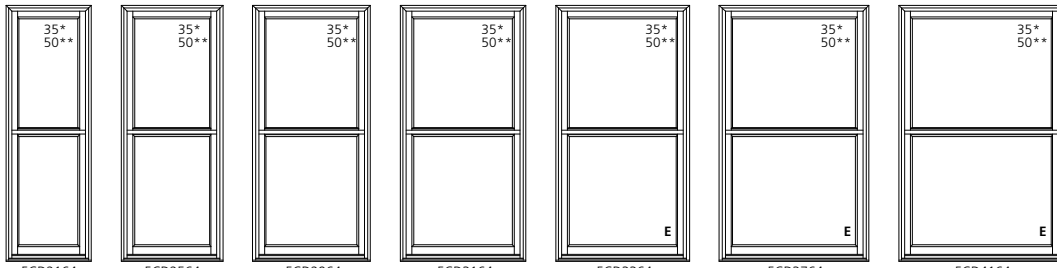

70 5/16" (1786)
71 13/16" (1824)
68 3/4" (1746)
68" (1727)
29 1/16" (738)(2)

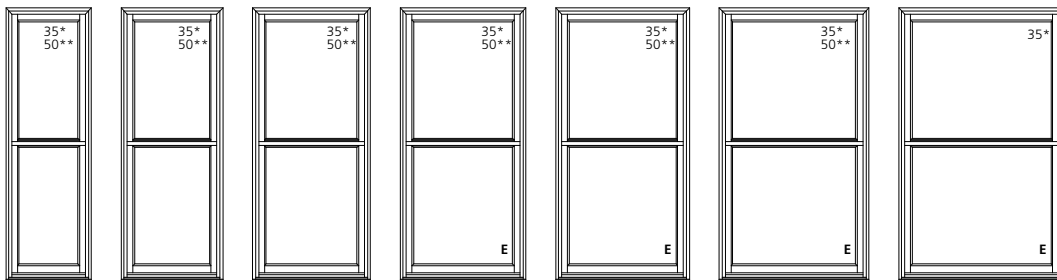

70 5/16" (1786)
71 13/16" (1824)
68 3/4" (1746)
68" (1727)
35 1/16" (891) 23 1/16" (586)

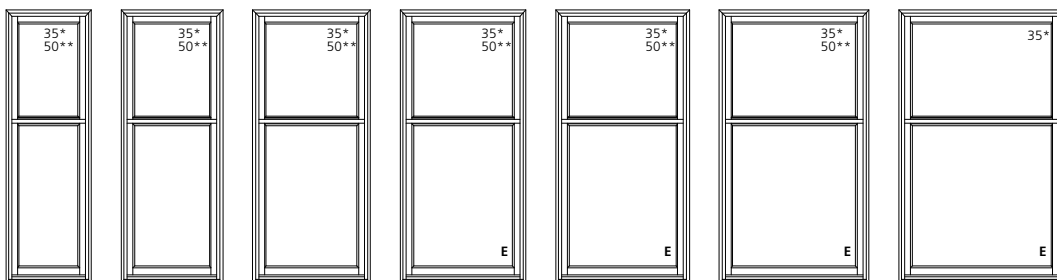

74 5/16" (1888)
75 13/16" (1926)
72 3/4" (1848)
72" (1829)
31 1/16" (789)(2)

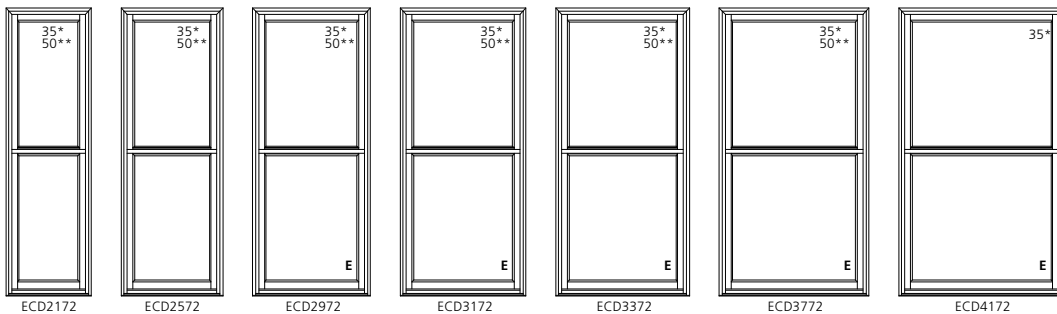

ELEVATION SYMBOL LEGEND:

M.O. = MASONRY OPENING
VALUES IN () ARE IN MILLIMETER CONVERSIONS
VALUES IN [] ARE NUMBER OF DAYLIGHT OPENINGS PER UNIT

E UNIT MEETS EGRESS REQUIREMENTS FOR IRC CODE. STATE AND LOCAL CODES MAY DIFFER. ALWAYS REFER TO LOCAL BUILDING CODES FOR COMPLETE REQUIREMENTS.
CHECK WITH LOCAL OFFICIALS TO ENSURE COMPLIANCE BEFORE INSTALLING THE UNIT.

INDICATES DESIGN PRESSURE (DP) RATING WITH STANDARD GLAZING

###* INDICATES OPTIONAL DESIGN PRESSURE (DP) RATING

Note: Elevations shown DO NOT have exterior trim. Subtract 1/2" (12.7) from M.O. (Masonry Opening) for Unit Sizes. Masonry Openings above include Sill
Nose, see Trim Options page for Sill Nose specifications. For other Trim Options refer to the Unit Sizing, Rough Opening & Masonry Openings page.

1-WIDE UNITS

M.O. BRICKMOULD
M.O. ADAMS/FLAT CASING
ROUGH OPENING
FRAME SIZE
DAYLIGHT OPENING

24 7/8"(632)	28 7/8"(733)	32 7/8"(835)	34 7/8"(886)	36 7/8"(937)	40 7/8"(1038)	44 7/8"(1140)
27 7/8"(708)	31 7/8"(810)	35 7/8"(911)	37 7/8"(962)	39 7/8"(1013)	43 7/8"(1114)	47 7/8"(1216)
22 1/8"(562)	26 1/8"(664)	30 1/8"(765)	32 1/8"(816)	34 1/8"(867)	38 1/8"(968)	42 1/8"(1070)
21 3/8"(543)	25 3/8"(645)	29 3/8"(746)	31 3/8"(797)	33 3/8"(848)	37 3/8"(949)	41 3/8"(1051)
14 13/16"(376)	18 13/16"(478)	22 13/16"(579)	24 13/16"(630)	26 13/16"(681)	30 13/16"(783)	34 13/16"(884)

78 5/16"(1989)
79 13/16"(2027)
76 3/4"(1949)
76"(1930)
33 1/16"(840)[2]

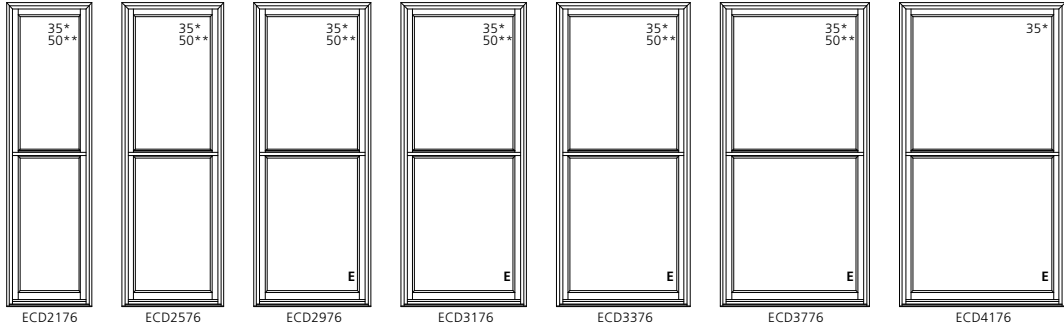

82 5/16"(2091)
83 13/16"(2129)
80 3/4"(2051)
80"(2032)
80"(2032)
35 1/16"(891)[2]

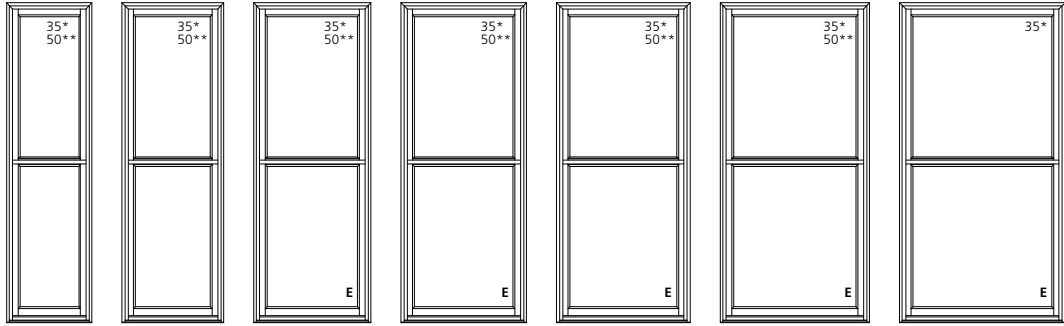

90 5/16"(2294)
91 13/16"(2332)
88 3/4"(2254)
88"(2235)
39 1/16"(992)[2]

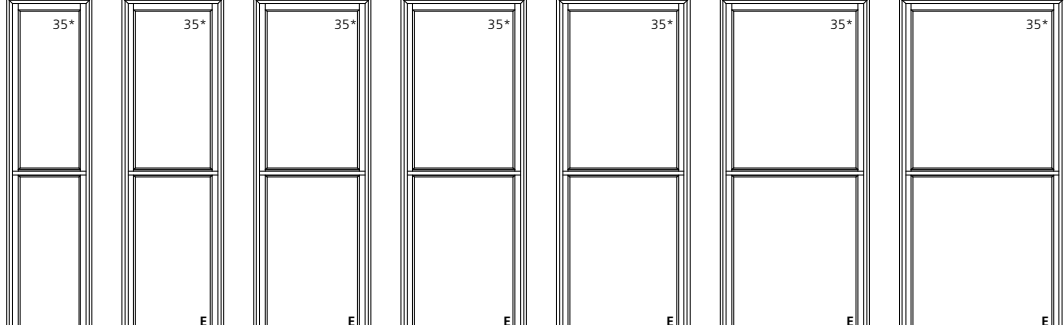

94 5/16"(2396)
95 13/16"(2434)
92 3/4"(2356)
92"(2337)
41 1/16"(1043)[2]

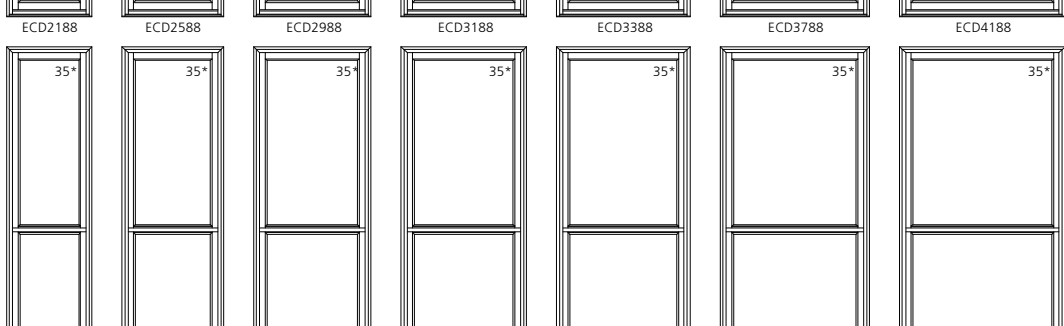

ELEVATION SYMBOL LEGEND:

M.O. = MASONRY OPENING

VALUES IN () ARE IN MILLIMETER CONVERSIONS

VALUES IN [] ARE NUMBER OF DAYLIGHT OPENINGS PER UNIT

E UNIT MEETS EGRESS REQUIREMENTS FOR IRC CODE. STATE AND LOCAL CODES MAY DIFFER. ALWAYS REFER TO LOCAL BUILDING CODES FOR COMPLETE REQUIREMENTS. CHECK WITH LOCAL OFFICIALS TO ENSURE COMPLIANCE BEFORE INSTALLING THE UNIT.

##* INDICATES DESIGN PRESSURE (DP) RATING WITH STANDARD GLAZING

##** INDICATES OPTIONAL DESIGN PRESSURE (DP) RATING

Note: Elevations shown DO NOT have exterior trim. Subtract 1/2" (12.7) from M.O. (Masonry Opening) for Unit Sizes. Masonry Openings above include Sill Nose, see Trim Options page for Sill Nose specifications. For other Trim Options refer to the Unit Sizing, Rough Opening & Masonry Openings page.

SCALE 1/4" = 1'

1-WIDE UNITS

M.O. BRICKMOULD
M.O. ADAMS/FLAT CASING
ROUGH OPENING
FRAME SIZE
DAYLIGHT OPENING

48 7/8" (1241)
51 7/8" (1318)
46 1/8" (1172)
45 3/8" (1153)
38 13/16" (986)

34 5/16" (872)
35 13/16" (910)
32 3/4" (832)
32" (813)
11 1/16" (281) [2]

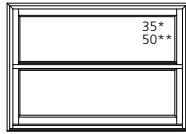

ECD4532

38 5/16" (973)
39 13/16" (1011)
36 3/4" (933)
36" (914)
13 1/16" (332) [2]

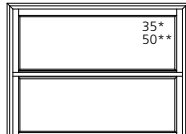

ECD4536

42 5/16" (1075)
43 13/16" (1113)
40 3/4" (1035)
40" (1016)
15 1/16" (383) [2]

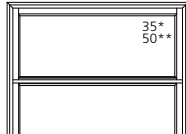

ECD4540

46 5/16" (1176)
47 13/16" (1214)
44 3/4" (1137)
44" (1118)
17 1/16" (433) [2]

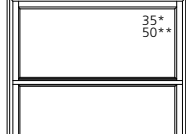

ECD4544

50 5/16" (1278)
51 13/16" (1316)
48 3/4" (1238)
48" (1219)
19 1/16" (484) [2]

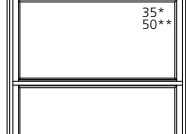

ECD4548

54 5/16" (1380)
55 13/16" (1418)
52 3/4" (1340)
52" (1321)
21 1/16" (535) [2]

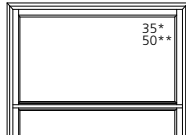

ECD4552

58 5/16" (1481)
59 13/16" (1519)
56 3/4" (1441)
56" (1422)
23 1/16" (586) [2]

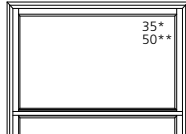

ECD4556

M.O. BRICKMOULD
M.O. ADAMS/FLAT CASING
ROUGH OPENING
FRAME SIZE
DAYLIGHT OPENING

48 7/8" (1241)
51 7/8" (1318)
46 1/8" (1172)
45 3/8" (1153)
38 13/16" (986)

62 5/16" (1583)
63 13/16" (1621)
60 3/4" (1543)
60" (1524)
25 1/16" (637) [2]

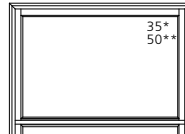

ECD4560

66 5/16" (1684)
67 13/16" (1722)
64 3/4" (1645)
64" (1626)
27 1/16" (687) [2]



ECD4564

70 5/16" (1786)
71 13/16" (1824)
68 3/4" (1746)
68" (1727)
29 1/16" (738) [2]



ECD4568

74 5/16" (1786)
75 13/16" (1824)
72 3/4" (1746)
72" (1727)
35 1/16" (891) 23 1/16" (586)



ECD4568C36

74 5/16" (1888)
75 13/16" (1926)
72 3/4" (1848)
72" (1829)
31 1/16" (789) [2]

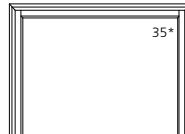

ECD4572

M.O. BRICKMOULD
M.O. ADAMS/FLAT CASING
ROUGH OPENING
FRAME SIZE
DAYLIGHT OPENING

48 7/8" (1241)
51 7/8" (1318)
46 1/8" (1172)
45 3/8" (1153)
38 13/16" (986)

78 5/16" (1989)
79 13/16" (2027)
76 3/4" (1949)
76" (1930)
33 1/16" (840) [2]

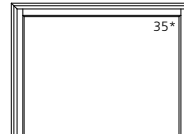

ECD4576

82 5/16" (2091)
83 13/16" (2129)
80 3/4" (2051)
80" (2032)
35 1/16" (891) [2]

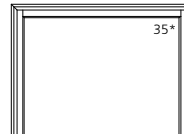

ECD4580

90 5/16" (2294)
91 13/16" (2332)
88 3/4" (2254)
88" (2235)
39 1/16" (992) [2]

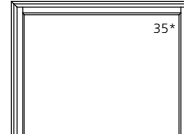

ECD4588

94 5/16" (2396)
95 13/16" (2434)
92 3/4" (2356)
92" (2337)
41 1/16" (1043) [2]



ECD4592

ELEVATION SYMBOL LEGEND:

M.O. = MASONRY OPENING
VALUES IN () ARE IN MILLIMETER CONVERSIONS
VALUES IN [] ARE NUMBER OF DAYLIGHT OPENINGS PER UNIT

E UNIT MEETS EGRESS REQUIREMENTS FOR IRC CODE. STATE AND LOCAL CODES MAY DIFFER. ALWAYS REFER TO LOCAL BUILDING CODES FOR COMPLETE REQUIREMENTS. CHECK WITH LOCAL OFFICIALS TO ENSURE COMPLIANCE BEFORE INSTALLING THE UNIT.

##* INDICATES DESIGN PRESSURE (DP) RATING WITH STANDARD GLAZING

##** INDICATES OPTIONAL DESIGN PRESSURE (DP) RATING

Note: Elevations shown DO NOT have exterior trim. Subtract 1/2" (12.7) from M.O. (Masonry Opening) for Unit Sizes. Masonry Openings above include Sill Nose, see Trim Options page for Sill Nose specifications. For other Trim Options refer to the Unit Sizing, Rough Opening & Masonry Openings page.

SCALE 1/4" = 1'

2-WIDE UNITS

**M.O. BRICKMOLD
M.O. ADAMS/FLAT CASING
ROUGH OPENING
FRAME SIZE
DAYLIGHT OPENING**

46 1/4" (1175)	54 1/4" (1378)	62 1/4" (1581)	66 1/4" (1683)	70 1/4" (1784)	78 1/4" (1988)	86 1/4" (2191)
49 1/4" (1251)	57 1/4" (1454)	65 1/4" (1657)	69 1/4" (1759)	73 1/4" (1861)	81 1/4" (2064)	89 1/4" (2267)
43 1/2" (1105)	51 1/2" (1308)	59 1/2" (1511)	63 1/2" (1613)	67 1/2" (1715)	75 1/2" (1918)	83 1/2" (2121)
42 3/4" (1086)	50 3/4" (1289)	58 3/4" (1492)	62 3/4" (1594)	66 3/4" (1695)	74 3/4" (1899)	82 3/4" (2102)
14 13/16" (376)[2]	18 13/16" (478)[2]	22 13/16" (579)[2]	24 13/16" (630)[2]	26 13/16" (681)[2]	30 13/16" (783)[2]	34 13/16" (884)[2]

34 5/16" (872)
35 1/16" (910)
32 3/4" (832)
32" (813)
38 5/16" (973)
39 13/16" (1011)
36 3/4" (933)
36" (914)
42 5/16" (1075)
43 13/16" (1113)
40 3/4" (1035)
40" (1016)
46 5/16" (1176)
47 13/16" (1214)
44 3/4" (1137)
44" (1118)
50 5/16" (1278)
51 13/16" (1316)
48 3/4" (1238)
48" (1219)
54 5/16" (1380)
55 13/16" (1418)
52 3/4" (1340)
52" (1321)
58 5/16" (1481)
59 13/16" (1519)
56 3/4" (1441)
56" (1422)
62 5/16" (1583)
63 13/16" (1621)
60 3/4" (1543)
60" (1524)
66 5/16" (1684)
67 13/16" (1722)
64 3/4" (1645)
64" (1626)
70 5/16" (1786)
71 13/16" (1824)
68 3/4" (1746)
68" (1727)
29 1/16" (738)[2]

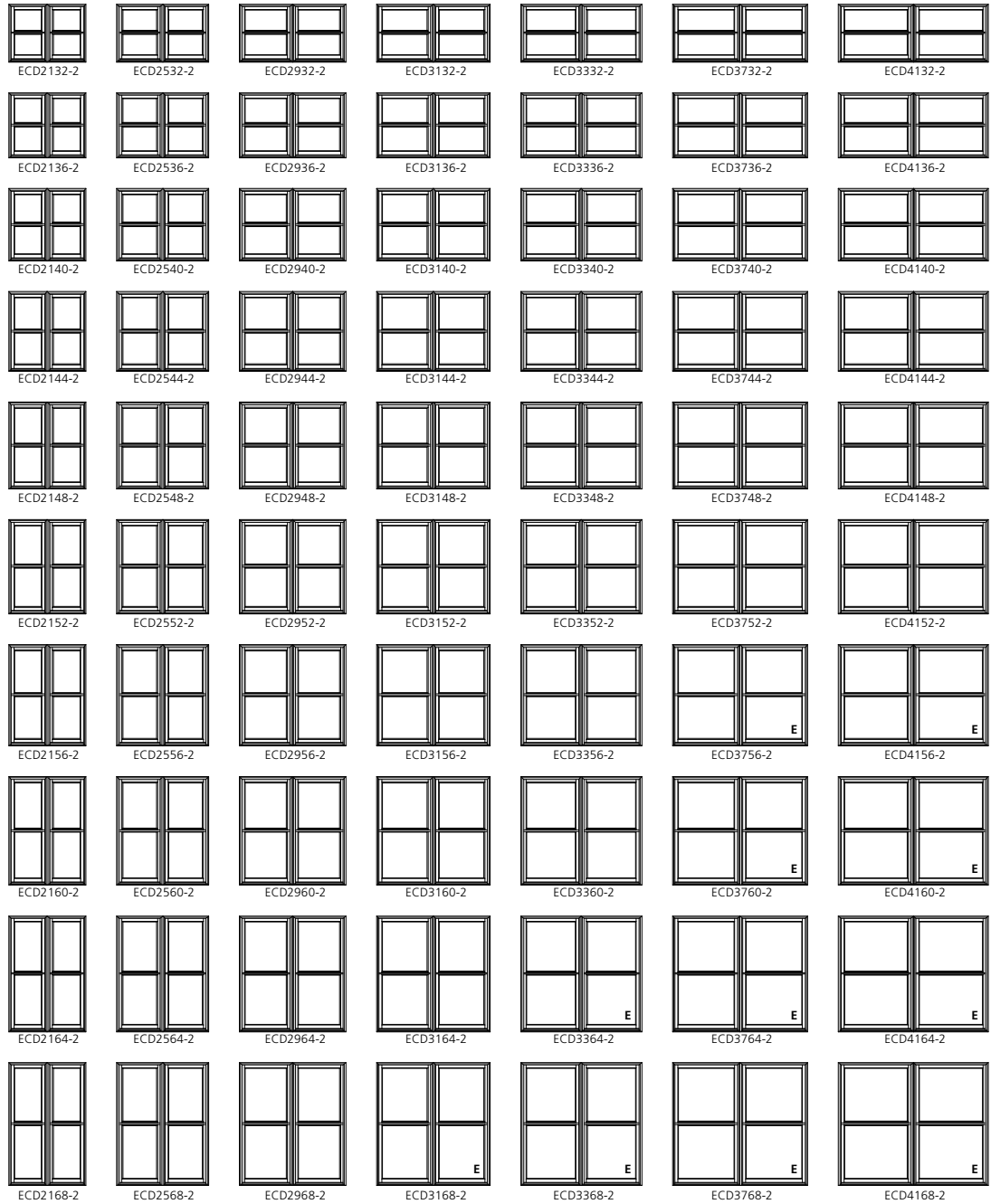

ELEVATION SYMBOL LEGEND:
M.O. = MASONRY OPENING
 VALUES IN () ARE IN MILLIMETER CONVERSIONS
 VALUES IN [] ARE NUMBER OF DAYLIGHT OPENINGS PER UNIT
E UNIT MEETS EGRESS REQUIREMENTS FOR IRC CODE. STATE AND LOCAL CODES MAY DIFFER. ALWAYS REFER TO LOCAL BUILDING CODES FOR COMPLETE REQUIREMENTS. CHECK WITH LOCAL OFFICIALS TO ENSURE COMPLIANCE BEFORE INSTALLING THE UNIT.
 Note: Elevations shown DO NOT have exterior trim. Subtract 1/2" (12.7) from M.O. (Masonry Opening) for Unit Sizes. Masonry Openings above include Sill Nose, see Trim Options page for Sill Nose specifications. For other Trim Options refer to the Unit Sizing, Rough Opening & Masonry Openings page.

SCALE 1/8" = 1'

2-WIDE UNITS

M.O. BRICKMOULD
M.O. ADAMS/FLAT CASING
ROUGH OPENING
FRAME SIZE
DAYLIGHT OPENING

46 1/4" (1175)	54 1/4" (1378)	62 1/4" (1581)	66 1/4" (1683)	70 1/4" (1784)	78 1/4" (1988)	86 1/4" (2191)
49 1/4" (1251)	57 1/4" (1454)	65 1/4" (1657)	69 1/4" (1759)	73 1/4" (1861)	81 1/4" (2064)	89 1/4" (2267)
43 1/2" (1105)	51 1/2" (1308)	59 1/2" (1511)	63 1/2" (1613)	67 1/2" (1715)	75 1/2" (1918)	83 1/2" (2121)
42 3/4" (1086)	50 3/4" (1289)	58 3/4" (1492)	62 3/4" (1594)	66 3/4" (1695)	74 3/4" (1899)	82 3/4" (2102)
14 13/16" (376)[2]	18 13/16" (478)[2]	22 13/16" (579)[2]	24 13/16" (630)[2]	26 13/16" (681)[2]	30 13/16" (783)[2]	34 13/16" (884)[2]

70 5/16" (1786)
71 13/16" (1824)
68 3/4" (1746)
68" (1727)
35 1/16" (738) 23 1/16" (586)

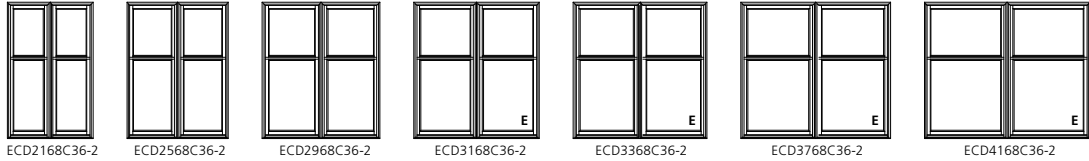

74 5/16" (1888)
75 13/16" (1926)
72 3/4" (1848)
72" (1829)
31 1/16" (789)[2]

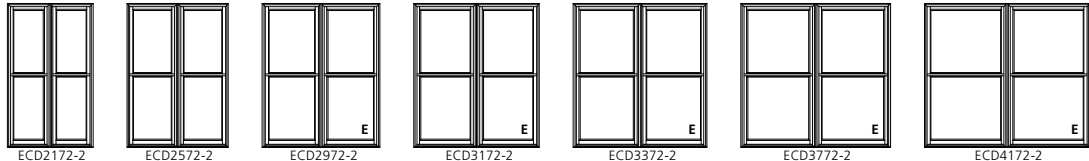

78 5/16" (1989)
79 13/16" (2027)
76 3/4" (1949)
76" (1930)
33 1/16" (840)[2]

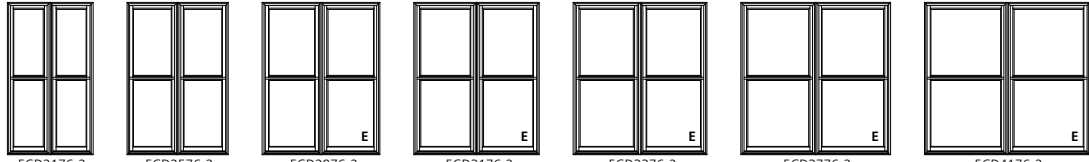

82 5/16" (2091)
83 13/16" (2129)
80 3/4" (2051)
80" (2032)
35 1/16" (891)[2]

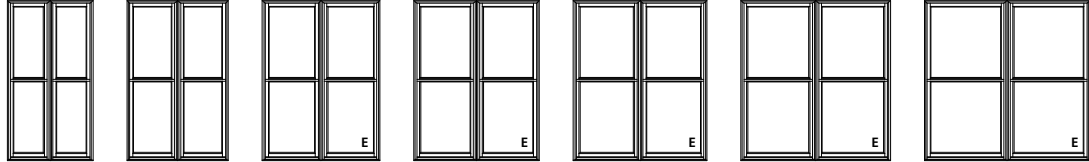

90 5/16" (2294)
91 13/16" (2332)
88 3/4" (2254)
88" (2235)
39 1/16" (992)[2]

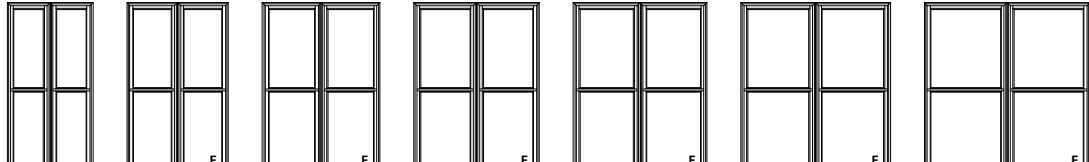

94 5/16" (2396)
95 13/16" (2434)
92 3/4" (2356)
92" (2337)
41 1/16" (1043)[2]

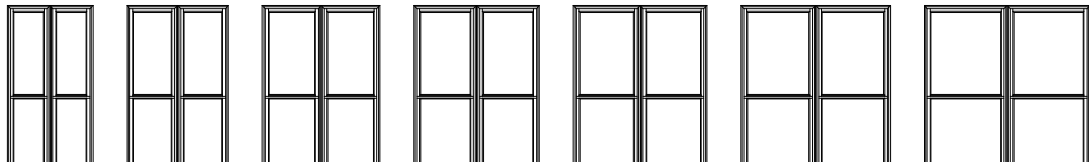

ELEVATION SYMBOL LEGEND:

M.O. = MASONRY OPENING
VALUES IN () ARE IN MILLIMETER CONVERSIONS
VALUES IN [] ARE NUMBER OF DAYLIGHT OPENINGS PER UNIT
E UNIT MEETS EGRESS REQUIREMENTS FOR IRC CODE. STATE AND LOCAL CODES MAY DIFFER. ALWAYS REFER TO LOCAL BUILDING CODES FOR COMPLETE REQUIREMENTS.
CHECK WITH LOCAL OFFICIALS TO ENSURE COMPLIANCE BEFORE INSTALLING THE UNIT.

Note: Elevations shown DO NOT have exterior trim. Subtract 1/2" (12.7) from M.O. (Masonry Opening) for Unit Sizes. Masonry Openings above include Sill Nose, see Trim Options page for Sill Nose specifications. For other Trim Options refer to the Unit Sizing, Rough Opening & Masonry Openings page.

SCALE 1/8" = 1'

2-WIDE UNITS

**M.O. BRICKMOULD
M.O. ADAMS/FLAT CASING
ROUGH OPENING
FRAME SIZE
DAYLIGHT OPENING**

94 1/4" (2394)
97 1/4" (2470)
91 1/2" (2324)
90 3/4" (2305)
38 13/16" (986) [2]

34 5/16" (872)
35 1/2" (910)
33 3/4" (832)
33 7/8" (813)
38 5/16" (973)
39 3/16" (1011)
39 3/4" (993)
36 3/4" (930)
36 5/8" (910)
42 5/16" (1075)
43 1/2" (1113)
40 3/4" (1035)
40" (1016)
46 5/16" (1176)
44 3/16" (1124)
44 3/4" (1127)
44" (1118)
50 5/16" (1278)
51 3/16" (1316)
48 3/4" (1238)
48" (1219)
54 5/16" (1380)
55 1/2" (1418)
52 3/4" (1340)
52" (1321)
58 5/16" (1481)
58 3/16" (1459)
56 3/4" (1441)
56" (1422)
63 5/16" (1583)
63 1/2" (1621)
60 3/4" (1543)
60" (1524)
66 5/16" (1684)
67 1/2" (1722)
64 3/4" (1645)
64" (1626)
70 5/16" (1786)
71 1/2" (1824)
68 3/4" (1746)
68" (1727)
70 5/16" (1786)
71 1/2" (1824)
68 3/4" (1746)
68" (1727)
35 1/16" (738) 23 1/16" (586)



ECD4532-2



ECD4536-2



ECD4540-2



ECD4544-2



ECD4548-2



ECD4552-2



ECD4556-2



ECD4560-2



ECD4564-2



ECD4568-2



ECD4568C-2

**M.O. BRICKMOULD
M.O. ADAMS/FLAT CASING
ROUGH OPENING
FRAME SIZE
DAYLIGHT OPENING**

94 1/4" (2394)
97 1/4" (2470)
91 1/2" (2324)
90 3/4" (2305)
38 13/16" (986) [2]

74 5/16" (1888)
75 13/16" (1926)
72 3/4" (1848)
72" (1829)
31 1/16" (789) [2]
78 5/16" (1989)
79 1/2" (2027)
76 3/4" (1949)
76" (1930)
33 1/16" (840) [2]
82 5/16" (2091)
83 1/2" (2129)
80 3/4" (2051)
80" (2032)
35 1/16" (889) [2]
80 5/16" (2094)
91 13/16" (2332)
88 3/4" (2254)
88" (2235)
39 1/16" (992) [2]
94 5/16" (2396)
95 1/2" (2434)
92 3/4" (2356)
92" (2337)
41 1/16" (1043) [2]



ECD4572-2



ECD4576-2



ECD4580-2



ECD4588-2



ECD4592-2

ELEVATION SYMBOL LEGEND:







































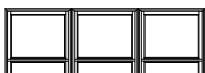









M.O. = MASONRY OPENING
VALUES IN () ARE IN MILLIMETER CONVERSIONS
VALUES IN [] ARE NUMBER OF DAYLIGHT OPENINGS PER UNIT
E UNIT MEETS EGRESS REQUIREMENTS FOR IRC CODE. STATE AND LOCAL CODES MAY DIFFER. ALWAYS REFER TO LOCAL BUILDING CODES FOR COMPLETE REQUIREMENTS. CHECK WITH LOCAL OFFICIALS TO ENSURE COMPLIANCE BEFORE INSTALLING THE UNIT.

Note: Elevations shown DO NOT have exterior trim. Subtract 1/2" (12.7) from M.O. (Masonry Opening) for Unit Sizes. Masonry Openings above include Sill Nose, see Trim Options page for Sill Nose specifications. For other Trim Options refer to the Unit Sizing, Rough Opening & Masonry Openings page.

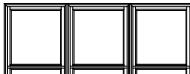
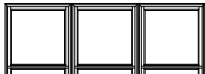
SCALE 1/8" = 1'

3-WIDE UNITS

**M.O. BRICKMOULD
M.O. ADAMS/PLAT CASING
ROUGH OPENING
FRAME SIZE
DAYLIGHT OPENING**

67 5/8" (1718) 70 5/8" (1794) 64 7/8" (1648) 64 1/8" (1629) 14 13/16" (376)[3]	79 5/8" (2022) 82 5/8" (2099) 76 7/8" (1953) 76 1/8" (1934) 18 13/16" (478)[3]	91 5/8" (2327) 94 5/8" (2403) 88 7/8" (2257) 88 1/8" (2238) 22 13/16" (579)[3]	97 5/8" (2480) 100 5/8" (2556) 94 7/8" (2410) 94 1/8" (2391) 24 13/16" (630)[3]	103 5/8" (2632) 106 5/8" (2708) 100 7/8" (2562) 100 1/8" (2543) 26 13/16" (681)[3]	 ECD2132-3	 ECD2532-3	 ECD2932-3	 ECD3132-3	 ECD3332-3
34 5/16" (872) 35 13/16" (910) 32 3/4" (832) 32 (813) 32 (813) 11 1/16" (281)[2]	38 5/16" (973) 39 13/16" (1011) 36 3/4" (933) 36 (914) 36 (914) 13 1/16" (332)[2]	42 5/16" (1075) 43 13/16" (1113) 40 3/4" (1035) 40 (1016) 40 (1016) 15 1/16" (383)[2]	46 5/16" (1176) 47 13/16" (1214) 44 3/4" (1137) 44 (1118) 44 (1118) 17 1/16" (433)[2]	50 5/16" (1278) 51 13/16" (1316) 48 3/4" (1238) 48 (1219) 48 (1219) 19 1/16" (484)[2]	 ECD2136-3	 ECD2536-3	 ECD2936-3	 ECD3136-3	 ECD3336-3
46 5/16" (1176) 47 13/16" (1214) 44 3/4" (1137) 44 (1118) 44 (1118) 17 1/16" (433)[2]	50 5/16" (1278) 51 13/16" (1316) 48 3/4" (1238) 48 (1219) 48 (1219) 19 1/16" (484)[2]	54 5/16" (1380) 55 13/16" (1418) 52 3/4" (1340) 52 (1321) 52 (1321) 2 11/16" (535)[2]	58 5/16" (1481) 59 13/16" (1519) 56 3/4" (1441) 56 (1422) 56 (1422) 23 1/16" (586)[2]	62 5/16" (1583) 63 13/16" (1621) 60 3/4" (1543) 60 (1524) 60 (1524) 25 1/16" (637)[2]	 ECD2140-3	 ECD2540-3	 ECD2940-3	 ECD3140-3	 ECD3340-3
46 5/16" (1176) 47 13/16" (1214) 44 3/4" (1137) 44 (1118) 44 (1118) 17 1/16" (433)[2]	50 5/16" (1278) 51 13/16" (1316) 48 3/4" (1238) 48 (1219) 48 (1219) 19 1/16" (484)[2]	54 5/16" (1380) 55 13/16" (1418) 52 3/4" (1340) 52 (1321) 52 (1321) 2 11/16" (535)[2]	58 5/16" (1481) 59 13/16" (1519) 56 3/4" (1441) 56 (1422) 56 (1422) 23 1/16" (586)[2]	62 5/16" (1583) 63 13/16" (1621) 60 3/4" (1543) 60 (1524) 60 (1524) 25 1/16" (637)[2]	 ECD2144-3	 ECD2544-3	 ECD2944-3	 ECD3144-3	 ECD3344-3
50 5/16" (1278) 51 13/16" (1316) 48 3/4" (1238) 48 (1219) 48 (1219) 19 1/16" (484)[2]	54 5/16" (1380) 55 13/16" (1418) 52 3/4" (1340) 52 (1321) 52 (1321) 2 11/16" (535)[2]	58 5/16" (1481) 59 13/16" (1519) 56 3/4" (1441) 56 (1422) 56 (1422) 23 1/16" (586)[2]	62 5/16" (1583) 63 13/16" (1621) 60 3/4" (1543) 60 (1524) 60 (1524) 25 1/16" (637)[2]	66 5/16" (1684) 67 13/16" (1722) 64 3/4" (1645) 64 (1626) 64 (1626) 27 1/16" (687)[2]	 ECD2148-3	 ECD2548-3	 ECD2948-3	 ECD3148-3	 ECD3348-3
54 5/16" (1380) 55 13/16" (1418) 52 3/4" (1340) 52 (1321) 52 (1321) 2 11/16" (535)[2]	58 5/16" (1481) 59 13/16" (1519) 56 3/4" (1441) 56 (1422) 56 (1422) 23 1/16" (586)[2]	62 5/16" (1583) 63 13/16" (1621) 60 3/4" (1543) 60 (1524) 60 (1524) 25 1/16" (637)[2]	66 5/16" (1684) 67 13/16" (1722) 64 3/4" (1645) 64 (1626) 64 (1626) 27 1/16" (687)[2]	70 5/16" (1786) 71 13/16" (1824) 68 3/4" (1746) 68 (1727) 68 (1727) 29 1/16" (738)[2]	 ECD2152-3	 ECD2552-3	 ECD2952-3	 ECD3152-3	 ECD3352-3
58 5/16" (1481) 59 13/16" (1519) 56 3/4" (1441) 56 (1422) 56 (1422) 23 1/16" (586)[2]	62 5/16" (1583) 63 13/16" (1621) 60 3/4" (1543) 60 (1524) 60 (1524) 25 1/16" (637)[2]	66 5/16" (1684) 67 13/16" (1722) 64 3/4" (1645) 64 (1626) 64 (1626) 27 1/16" (687)[2]	70 5/16" (1786) 71 13/16" (1824) 68 3/4" (1746) 68 (1727) 68 (1727) 29 1/16" (738)[2]	74 5/16" (1888) 75 13/16" (1926) 72 3/4" (1848) 72 (1829) 72 (1829) 31 1/16" (793)[2]	 ECD2156-3	 ECD2556-3	 ECD2956-3	 ECD3156-3	 ECD3356-3
62 5/16" (1583) 63 13/16" (1621) 60 3/4" (1543) 60 (1524) 60 (1524) 25 1/16" (637)[2]	66 5/16" (1684) 67 13/16" (1722) 64 3/4" (1645) 64 (1626) 64 (1626) 27 1/16" (687)[2]	70 5/16" (1786) 71 13/16" (1824) 68 3/4" (1746) 68 (1727) 68 (1727) 29 1/16" (738)[2]	74 5/16" (1888) 75 13/16" (1926) 72 3/4" (1848) 72 (1829) 72 (1829) 31 1/16" (793)[2]	78 5/16" (1990) 79 13/16" (2028) 76 3/4" (1948) 76 (1929) 76 (1929) 33 1/16" (844)[2]	 ECD2160-3	 ECD2560-3	 ECD2960-3	 ECD3160-3	 ECD3360-3
66 5/16" (1684) 67 13/16" (1722) 64 3/4" (1645) 64 (1626) 64 (1626) 27 1/16" (687)[2]	70 5/16" (1786) 71 13/16" (1824) 68 3/4" (1746) 68 (1727) 68 (1727) 29 1/16" (738)[2]	74 5/16" (1888) 75 13/16" (1926) 72 3/4" (1848) 72 (1829) 72 (1829) 31 1/16" (793)[2]	78 5/16" (1990) 79 13/16" (2028) 76 3/4" (1948) 76 (1929) 76 (1929) 33 1/16" (844)[2]	82 5/16" (2092) 83 13/16" (2130) 80 3/4" (2048) 80 (2029) 80 (2029) 35 1/16" (895)[2]	 ECD2164-3	 ECD2564-3	 ECD2964-3	 ECD3164-3	 ECD3364-3
70 5/16" (1786) 71 13/16" (1824) 68 3/4" (1746) 68 (1727) 68 (1727) 29 1/16" (738)[2]	74 5/16" (1888) 75 13/16" (1926) 72 3/4" (1848) 72 (1829) 72 (1829) 31 1/16" (793)[2]	78 5/16" (1990) 79 13/16" (2028) 76 3/4" (1948) 76 (1929) 76 (1929) 33 1/16" (844)[2]	82 5/16" (2092) 83 13/16" (2130) 80 3/4" (2048) 80 (2029) 80 (2029) 35 1/16" (895)[2]	86 5/16" (2194) 87 13/16" (2232) 84 3/4" (2148) 84 (2129) 84 (2129) 37 1/16" (946)[2]	 ECD2168-3	 ECD2568-3	 ECD2968-3	 ECD3168-3	 ECD3368-3

ELEVATION SYMBOL LEGEND:

M.O. = MASONRY OPENING

VALUES IN () ARE IN MILLIMETER CONVERSIONS

VALUES IN [] ARE NUMBER OF DAYLIGHT OPENINGS PER UNIT

E UNIT MEETS EGRESS REQUIREMENTS FOR IRC CODE. STATE AND LOCAL CODES MAY DIFFER. ALWAYS REFER TO LOCAL BUILDING CODES FOR COMPLETE REQUIREMENTS. CHECK WITH LOCAL OFFICIALS TO ENSURE COMPLIANCE BEFORE INSTALLING THE UNIT.

Note: Elevations shown DO NOT have exterior trim. Subtract 1/2" (12.7) from M.O. (Masonry Opening) for Unit Sizes. Masonry Openings above include Sill Nose, see Trim Options page for Sill Nose specifications. For other Trim Options refer to the Unit Sizing, Rough Opening & Masonry Openings page.

SCALE 1/8" = 1'

3-WIDE UNITS

M.O. BRICKMOULD	67 5/8" (1718)	79 5/8" (2022)	91 5/8" (2327)	97 5/8" (2480)	103 5/8" (2632)
M.O. ADAMS FLAT CASING	70 5/8" (1794)	82 5/8" (2099)	94 5/8" (2403)	100 5/8" (2556)	106 5/8" (2708)
ROUGH OPENING	64 7/8" (1648)	76 7/8" (1953)	88 7/8" (2257)	94 7/8" (2410)	100 7/8" (2562)
FRAME SIZE	64 1/8" (1629)	76 1/8" (1934)	88 1/8" (2238)	94 1/8" (2391)	100 1/8" (2543)
DAYLIGHT OPENING	14 13/16" (376)[3]	18 13/16" (478)[3]	22 13/16" (579)[3]	24 13/16" (630)[3]	26 13/16" (681)[3]
70 5/16" (1786) 71 13/16" (1824) 68 3/4" (1746) 68" (1727) 35 1/16" (738) 23 1/16" (586)					
74 5/16" (1888) 75 13/16" (1926) 72 3/4" (1848) 72" (1829) 31 1/16" (789)[2]					
78 5/16" (1989) 79 13/16" (2027) 76 3/4" (1949) 76" (1930) 33 1/16" (840)[2]					
82 5/16" (2091) 83 13/16" (2129) 80 3/4" (2051) 80" (2032) 35 1/16" (891)[2]					
90 5/16" (2294) 91 13/16" (2332) 88 3/4" (2254) 88" (2235) 39 1/16" (992)[2]					
94 5/16" (2396) 95 13/16" (2434) 92 3/4" (2356) 92" (2337) 41 1/16" (1043)[2]					

ELEVATION SYMBOL LEGEND:

- M.O.** = MASONRY OPENING
- VALUES IN () ARE IN MILLIMETER CONVERSIONS
- VALUES IN [] ARE NUMBER OF DAYLIGHT OPENINGS PER UNIT
- E** UNIT MEETS EGRESS REQUIREMENTS FOR IRC CODE. STATE AND LOCAL CODES MAY DIFFER. ALWAYS REFER TO LOCAL BUILDING CODES FOR COMPLETE REQUIREMENTS. CHECK WITH LOCAL OFFICIALS TO ENSURE COMPLIANCE BEFORE INSTALLING THE UNIT.

Note: Elevations shown DO NOT have exterior trim. Subtract 1/2" (12.7) from M.O. (Masonry Opening) for Unit Sizes. Masonry Openings above include Sill Nose, see Trim Options page for Sill Nose specifications. For other Trim Options refer to the Unit Sizing, Rough Opening & Masonry Openings page.

SCALE 1/8" = 1'

3-WIDE UNITS

M.O. BRICKMOUND
M.O. ADAMS/FLAT CASING
ROUGH OPENING
FRAME SIZE
DAYLIGHT OPENING

115 5/8" (2937) 118 5/8" (3013) 112 7/8" (2867) 112 1/8" (2848) 30 13/16" (783)[3]	127 5/8" (3242) 130 5/8" (3318) 124 7/8" (3171) 124 1/8" (3153) 34 13/16" (884)[3]	139 5/8" (3546) 142 5/8" (3623) 136 7/8" (3477) 136 1/8" (3458) 38 13/16" (986)[3]
34 5/16" (872) 35 13/16" (910) 32 3/4" (832) 32" (813) 37" (914)		
38 5/16" (973) 39 13/16" (1011) 36 3/4" (933) 36" (914)		
42 5/16" (1075) 43 13/16" (1113) 40 3/4" (1035) 40" (1016)		
46 5/16" (1176) 47 13/16" (1214) 44 3/4" (1137) 44" (1118)		
50 5/16" (1278) 51 13/16" (1316) 48 3/4" (1238) 48" (1219)		
54 5/16" (1380) 55 13/16" (1418) 52 3/4" (1340) 52" (1321)		
58 5/16" (1481) 59 13/16" (1519) 56 3/4" (1441) 56" (1422)		
62 5/16" (1583) 63 13/16" (1621) 60 3/4" (1543) 60" (1524)		
66 5/16" (1684) 67 13/16" (1722) 64 3/4" (1645) 64" (1626)		
70 5/16" (1786) 71 13/16" (1824) 68 3/4" (1746) 68" (1727)		
13 1/16" (332)[2] 11 1/16" (281)[2]		
ECD3732-3	ECD4132-3	ECD4532-3
ECD3736-3	ECD4136-3	ECD4536-3
ECD3740-3	ECD4140-3	ECD4540-3
ECD3744-3	ECD4144-3	ECD4544-3
ECD3748-3	ECD4148-3	ECD4548-3
ECD3752-3	ECD4152-3	ECD4552-3
ECD3756-3	ECD4156-3	ECD4556-3
ECD3760-3	ECD4160-3	ECD4560-3
ECD3764-3	ECD4164-3	ECD4564-3
ECD3768-3	ECD4168-3	ECD4568-3

ELEVATION SYMBOL LEGEND:

M.O. = MASONRY OPENING
VALUES IN () ARE IN MILLIMETER CONVERSIONS
VALUES IN [] ARE NUMBER OF DAYLIGHT OPENINGS PER UNIT

E UNIT MEETS EGRESS REQUIREMENTS FOR IRC CODE. STATE AND LOCAL CODES MAY DIFFER. ALWAYS REFER TO LOCAL BUILDING CODES FOR COMPLETE REQUIREMENTS. CHECK WITH LOCAL OFFICIALS TO ENSURE COMPLIANCE BEFORE INSTALLING THE UNIT.

Note: Elevations shown DO NOT have exterior trim. Subtract 1/2" (12.7) from M.O. (Masonry Opening) for Unit Sizes. Masonry Openings above include Sill Nose, see Trim Options page for Sill Nose specifications. For other Trim Options refer to the Unit Sizing, Rough Opening & Masonry Openings page.

SCALE 1/8" = 1'

3-WIDE UNITS

M.O. BRICKMOULD
M.O. ADAMS/FLAT CASING
ROUGH OPENING
FRAME SIZE
DAYLIGHT OPENING

115 5/8" (2937)
118 5/8" (3013)
112 7/8" (2867)
112 1/8" (2848)
30 13/16" (783)[3]

127 5/8" (3242)
130 5/8" (3318)
124 7/8" (3171)
124 1/8" (3153)
34 13/16" (884)[3]

139 5/8" (3546)
142 5/8" (3623)
136 7/8" (3477)
136 1/8" (3458)
38 13/16" (986)[3]

70 5/16" (1786)
71 13/16" (1824)
68 3/4" (1746)
68" (1727)
35 1/16" (738); 23 1/16" (586)

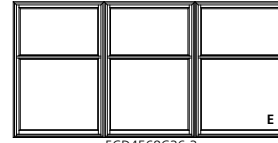
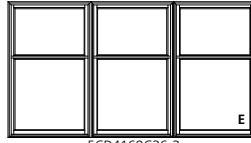
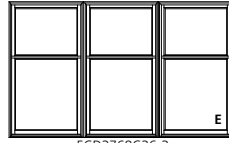

74 5/16" (1888)
75 13/16" (1926)
72 3/4" (1848)
72" (1829)
31 1/16" (789)[2]

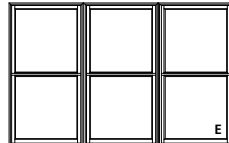

78 5/16" (1989)
79 13/16" (2027)
76 3/4" (1949)
76" (1930)
33 1/16" (840)[2]

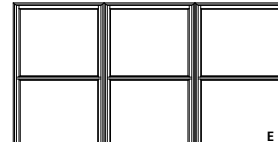
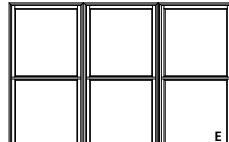

82 5/16" (2091)
83 13/16" (2129)
80 3/4" (2051)
80" (2032)
35 1/16" (891)[2]

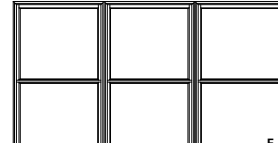
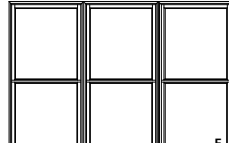

90 5/16" (2294)
91 13/16" (2332)
88 3/4" (2254)
88" (2235)
39 1/16" (992)[2]

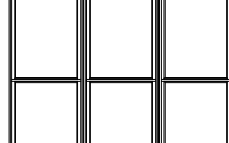

94 5/16" (2396)
95 13/16" (2434)
92 3/4" (2356)
92" (2337)
41 1/16" (1043)[2]

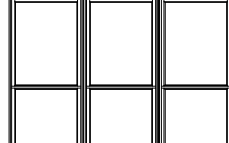

ELEVATION SYMBOL LEGEND:

M.O. = MASONRY OPENING

VALUES IN () ARE IN MILLIMETER CONVERSIONS

VALUES IN [] ARE NUMBER OF DAYLIGHT OPENINGS PER UNIT

E UNIT MEETS EGRESS REQUIREMENTS FOR IRC CODE. STATE AND LOCAL CODES MAY DIFFER. ALWAYS REFER TO LOCAL BUILDING CODES FOR COMPLETE REQUIREMENTS. CHECK WITH LOCAL OFFICIALS TO ENSURE COMPLIANCE BEFORE INSTALLING THE UNIT.

Note: Elevations shown DO NOT have exterior trim. Subtract 1/2" (12.7) from M.O. (Masonry Opening) for Unit Sizes. Masonry Openings above include Sill Nose, see Trim Options page for Sill Nose specifications. For other Trim Options refer to the Unit Sizing, Rough Opening & Masonry Openings page.

SCALE 1/8" = 1'

ELEVATION NOTES
DOUBLE-HUNG PICTURE

ELEVATION DRAWINGS UTILIZE A LIMITED NUMBER OF PROJECTED LINES TO PRODUCE A RUDIMENTARY DRAWING INTENDED TO BE USED IN A SMALL GRAPHICAL SCALE. ELEVATIONS ARE VIEWED PERPENDICULAR FROM THE EXTERIOR OF THE STRUCTURE. IF MORE DIMENSIONS ARE NEEDED, USE THE SECTION DRAWINGS FOR MORE COMPLETE DEPICTIONS.

M.O. Brickmould
M.O. Adams/Flat Casing
Rough Opening
Frame Size
Daylight Opening

44 7/8" (1140)
47 7/8" (1216)
42 1/8" (1070)
41 3/8" (1051)
34 13/16" (884)

Masonry Openings for Brickmould, Flat & Adams Casing.
Vertical measurements include sillnose.
(Subtract 1/2" from Masonry Opening for Unit Size)

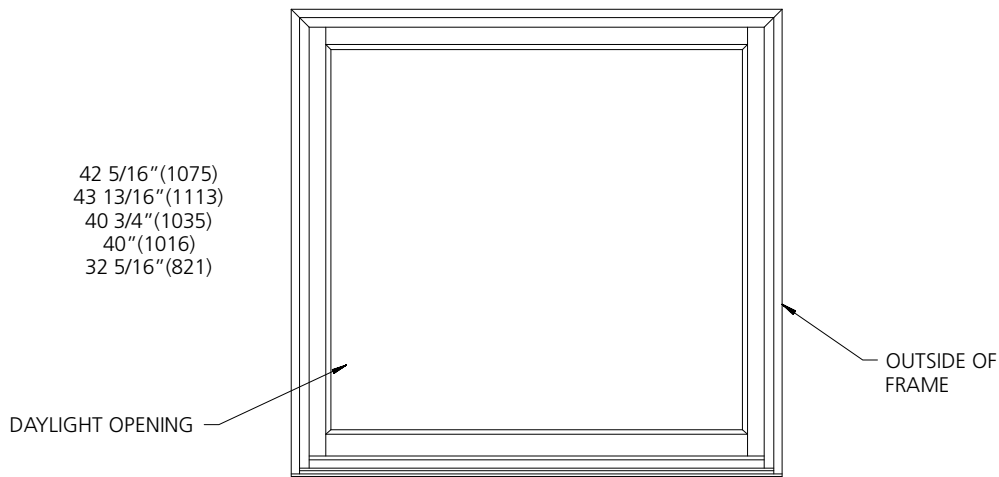

ECDP4140

'ECDP' INDICATES
SITELINE EX CLAD DOUBLE-HUNG PICTURE

THE FIRST TWO NUMBERS
INDICATE THE UNIT WIDTH

BOOK CODE

THE LAST TWO NUMBERS INDICATE
THE UNIT HEIGHT











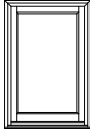
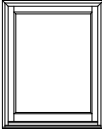
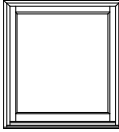
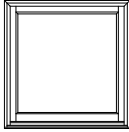
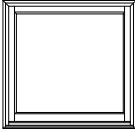
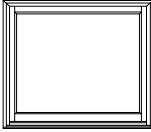
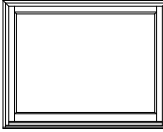
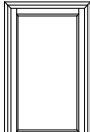
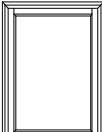
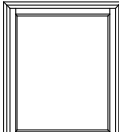
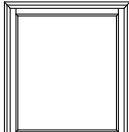
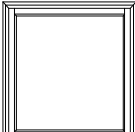
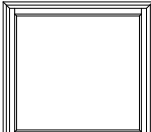
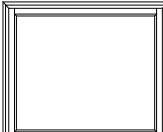
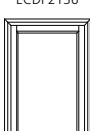
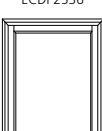
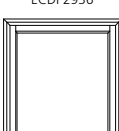
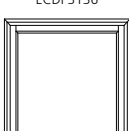
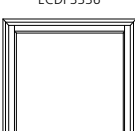
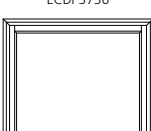
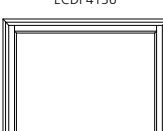
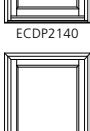

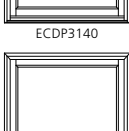
GENERAL DOUBLE-HUNG PICTURE NOTES

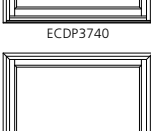
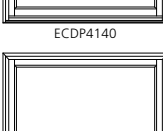
1. ALL UNITS SHOWN ARE AVAILABLE AS STATIONARY ONLY.
2. UNIT ELEVATIONS ARE SHOWN WITHOUT EXTERIOR TRIM.
3. DIMENSIONAL VALUES IN BRACKETS ARE MILLIMETER CONVERSIONS.

ELEVATION SYMBOL LEGEND:

MO MASONRY OPENING

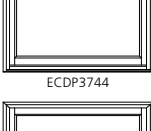
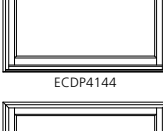
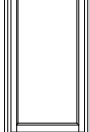
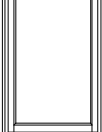
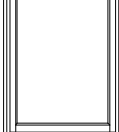
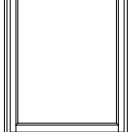
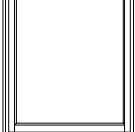
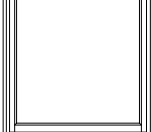
PICTURE UNITS

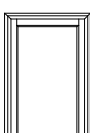
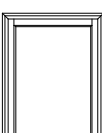
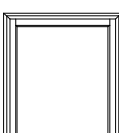
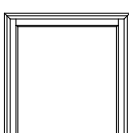
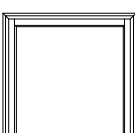
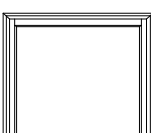
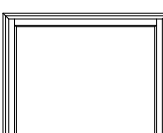
M.O. BRICKMOULD	24 7/8" (632)	28 7/8" (733)	32 7/8" (835)	34 7/8" (886)	36 7/8" (937)	40 7/8" (1038)	44 7/8" (1140)
M.O. ADAMS/FLAT CASING	27 7/8" (708)	31 7/8" (810)	35 7/8" (911)	37 7/8" (962)	39 7/8" (1013)	43 7/8" (1114)	47 7/8" (1216)
ROUGH OPENING	22 1/8" (562)	26 1/8" (664)	30 1/8" (765)	32 1/8" (816)	34 1/8" (867)	38 1/8" (968)	42 1/8" (1070)
FRAME SIZE	21 3/8" (543)	25 3/8" (645)	29 3/8" (746)	31 3/8" (797)	33 3/8" (848)	37 3/8" (949)	41 3/8" (1051)
DAYLIGHT OPENING	14 13/16" (376)	18 13/16" (478)	22 13/16" (579)	24 13/16" (630)	26 13/16" (681)	30 13/16" (783)	34 13/16" (884)
34 5/16" (872) 35 13/16" (910) 32 3/4" (832) 32 1/2" (813) 24 5/16" (618)							
	ECDP2132	ECDP2532	ECDP2932	ECDP3132	ECDP3332	ECDP3732	ECDP4132
38 5/16" (973) 39 13/16" (1011) 36 3/4" (933) 36 (914) 28 5/16" (719)							
	ECDP2136	ECDP2536	ECDP2936	ECDP3136	ECDP3336	ECDP3736	ECDP4136
42 5/16" (1075) 43 13/16" (1113) 40 3/4" (1035) 40 (1016) 32 5/16" (821)							
	ECDP2140	ECDP2540	ECDP2940	ECDP3140	ECDP3340	ECDP3740	ECDP4140
46 5/16" (1176) 47 13/16" (1214) 44 3/4" (1137) 44 (1118) 36 5/16" (922)							
	ECDP2144	ECDP2544	ECDP2944	ECDP3144	ECDP3344	ECDP3744	ECDP4144
50 5/16" (1278) 51 13/16" (1316) 48 3/4" (1238) 48 (1219) 40 5/16" (1024)							
	ECDP2148	ECDP2548	ECDP2948	ECDP3148	ECDP3348	ECDP3748	ECDP4148
54 5/16" (1380) 55 13/16" (1418) 52 3/4" (1340) 52 (1321) 44 5/16" (1126)							
	ECDP2152	ECDP2552	ECDP2952	ECDP3152	ECDP3352	ECDP3752	ECDP4152
58 5/16" (1481) 59 13/16" (1519) 56 3/4" (1441) 56 (1422) 48 5/16" (1227)							
	ECDP2156	ECDP2556	ECDP2956	ECDP3156	ECDP3356	ECDP3756	ECDP4156

ELEVATION SYMBOL LEGEND:

M.O. = MASONRY OPENING
VALUES IN () ARE IN MILLIMETER CONVERSIONS

Note: Elevations shown DO NOT have exterior trim. Subtract 1/2" (12.7) from M.O. (Masonry Opening) for Unit Sizes. Masonry Openings above include Sill Nose, see Trim Options page for Sill Nose specifications. For other Trim Options refer to the Unit Sizing, Rough Opening & Masonry Openings page.

SCALE 1/4" = 1'

PICTURE UNITS

M.O. BRICKMOULD	24 7/8" (632)	28 7/8" (733)	32 7/8" (835)	34 7/8" (886)	36 7/8" (937)	40 7/8" (1038)	44 7/8" (1140)
M.O. ADAMS/FLAT CASING	27 7/8" (708)	31 7/8" (810)	35 7/8" (911)	37 7/8" (962)	39 7/8" (1013)	43 7/8" (1114)	47 7/8" (1216)
ROUGH OPENING	22 1/8" (562)	26 1/8" (664)	30 1/8" (765)	32 1/8" (816)	34 1/8" (867)	38 1/8" (968)	42 1/8" (1070)
FRAME SIZE	21 3/8" (543)	25 3/8" (645)	29 3/8" (746)	31 3/8" (797)	33 3/8" (848)	37 3/8" (949)	41 3/8" (1051)
DAYLIGHT OPENING	14 13/16" (376)	18 13/16" (478)	22 13/16" (579)	24 13/16" (630)	26 13/16" (681)	30 13/16" (783)	34 13/16" (884)

62 5/16" (1583)
63 13/16" (1621)
60 3/4" (1543)
60" (1524)
52 5/16" (1329)

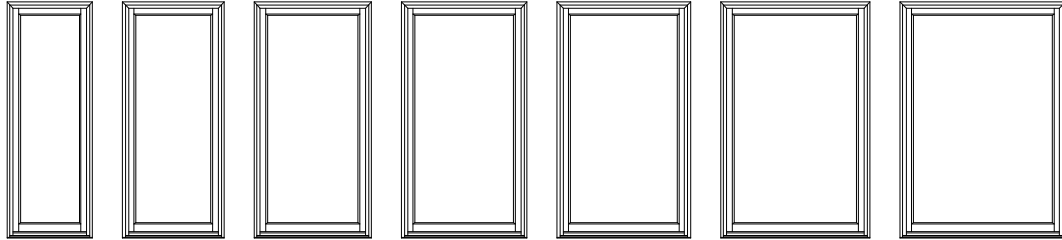

ECDP2160 ECDP2560 ECDP2960 ECDP3160 ECDP3360 ECDP3760 ECDP4160

66 5/16" (1684)
69 13/16" (1773)
64 3/4" (1645)
64" (1626)
56 5/16" (1430)

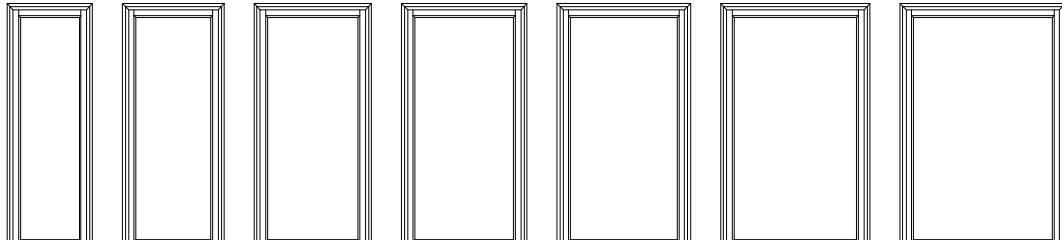

ECDP2164 ECDP2564 ECDP2964 ECDP3164 ECDP3364 ECDP3764 ECDP4164

70 5/16" (1786)
71 13/16" (1824)
68 3/4" (1746)
68" (1727)
60 5/16" (1532)

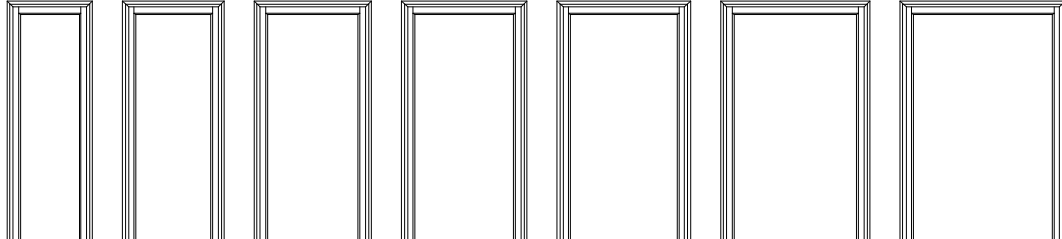

ECDP2168 ECDP2568 ECDP2968 ECDP3168 ECDP3368 ECDP3768 ECDP4168

74 5/16" (1888)
75 13/16" (1926)
72 3/4" (1848)
72" (1829)
64 5/16" (1634)

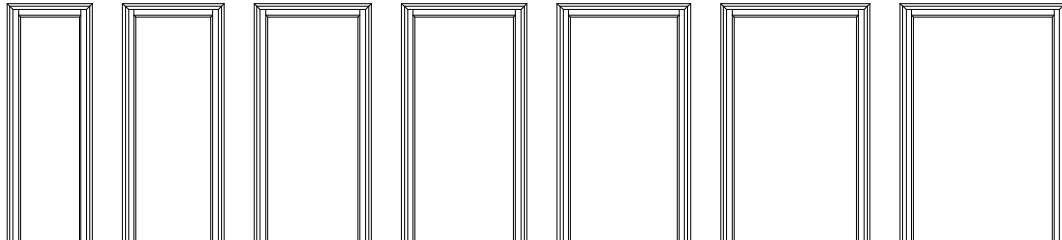

ECDP2172 ECDP2572 ECDP2972 ECDP3172 ECDP3372 ECDP3772 ECDP4172

78 5/16" (1989)
79 13/16" (2027)
76 3/4" (1949)
76" (1930)
68 5/16" (1735)

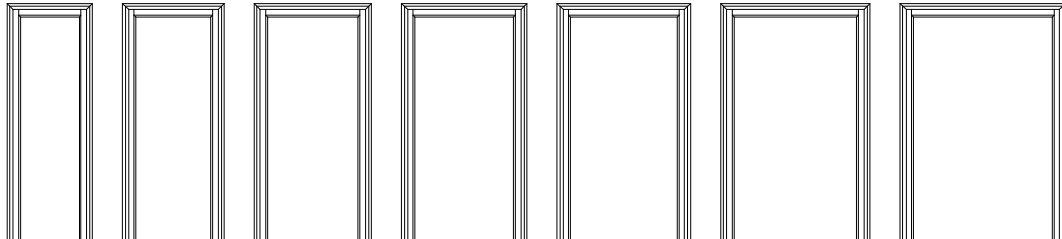

ECDP2176 ECDP2576 ECDP2976 ECDP3176 ECDP3376 ECDP3776 ECDP4176

ELEVATION SYMBOL LEGEND:
M.O. = MASONRY OPENING
VALUES IN () ARE IN MILLIMETER CONVERSIONS

Note: Elevations shown DO NOT have exterior trim. Subtract 1/2" (12.7) from M.O. (Masonry Opening) for Unit Sizes. Masonry Openings above include Sill Nose, see Trim Options page for Sill Nose specifications. For other Trim Options refer to the Unit Sizing, Rough Opening & Masonry Openings page.

SCALE 1/4" = 1'

PICTURE UNITS

M.O. BRICKMOULD
M.O. ADAMS/FLAT CASING
ROUGH OPENING
FRAME SIZE
DAYLIGHT OPENING

24 7/8" (632)	28 7/8" (733)	32 7/8" (835)	34 7/8" (886)	36 7/8" (937)	40 7/8" (1038)	44 7/8" (1140)
27 7/8" (708)	31 7/8" (810)	35 7/8" (911)	37 7/8" (962)	39 7/8" (1013)	43 7/8" (1114)	47 7/8" (1216)
22 1/8" (562)	26 1/8" (664)	30 1/8" (765)	32 1/8" (816)	34 1/8" (867)	38 1/8" (968)	42 1/8" (1070)
21 3/8" (543)	25 3/8" (645)	29 3/8" (746)	31 3/8" (797)	33 3/8" (848)	37 3/8" (949)	41 3/8" (1051)
14 13/16" (376)	18 13/16" (478)	22 13/16" (579)	24 13/16" (630)	26 13/16" (681)	30 13/16" (783)	34 13/16" (884)

82 5/16" (2091)
83 13/16" (2129)
80 3/4" (2051)
80 (2032)
72 5/16" (1837)

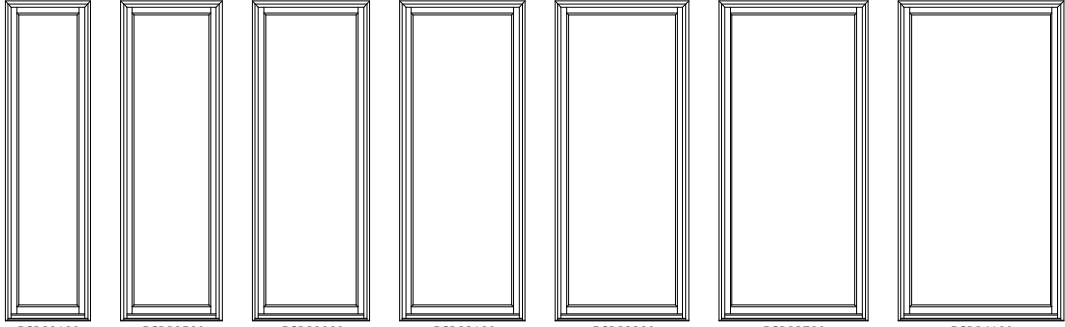

90 5/16" (2294)
91 13/16" (2332)
88 3/4" (2254)
88 (2235)
80 5/16" (2040)

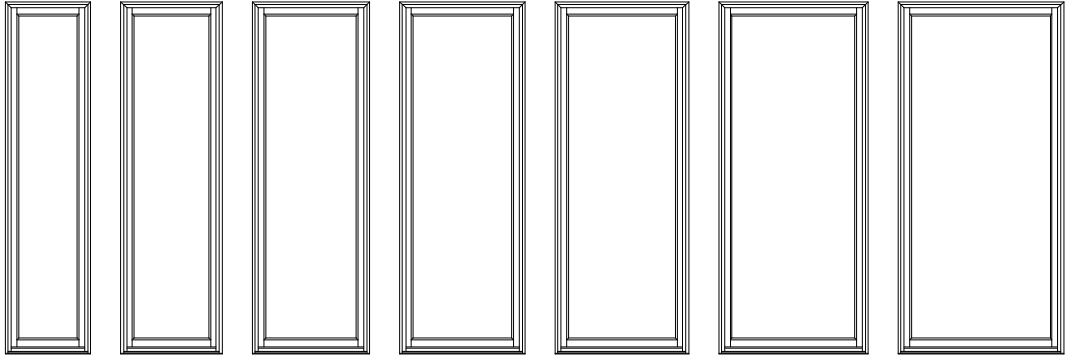

94 5/16" (2396)
95 13/16" (2434)
92 3/4" (2356)
92 (2337)
84 5/16" (2142)

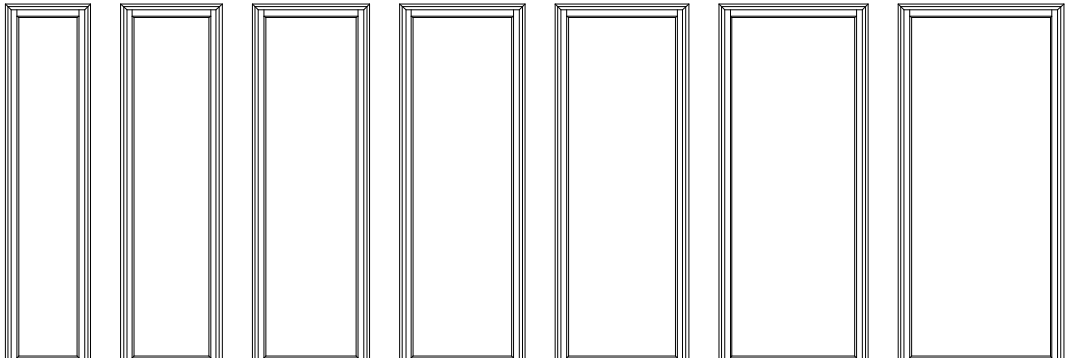

ELEVATION SYMBOL LEGEND:

M.O. = MASONRY OPENING
VALUES IN () ARE IN MILLIMETER CONVERSIONS

Note: Elevations shown DO NOT have exterior trim. Subtract 1/2" (12.7) from M.O. (Masonry Opening) for Unit Sizes. Masonry Openings above include Sill Nose, see Trim Options page for Sill Nose specifications. For other Trim Options refer to the Unit Sizing, Rough Opening & Masonry Openings page.

SCALE 1/4" = 1'

PICTURE UNITS

**M.O. BRICKMOULD
M.O. ADAMS/FLAT CASING
ROUGH OPENING
FRAME SIZE
DAYLIGHT OPENING**

34 5/16" (872) 35 13/16" (910) 32 3/4" (832) 32" (813) 24 5/16" (618)	48 7/8" (1241) 51 7/8" (1318) 46 1/8" (1172) 45 3/8" (1153) 38 13/16" (986)	52 7/8" (1343) 55 7/8" (1419) 50 1/8" (1273) 49 3/8" (1254) 42 13/16" (1087)	56 7/8" (1445) 59 7/8" (1581) 54 1/8" (1375) 53 3/8" (1356) 46 13/16" (1189)	64 7/8" (1648) 67 7/8" (1724) 62 1/8" (1578) 61 3/8" (1559) 54 13/16" (1392)
	ECDP4532	ECDP4932	ECDP5332	ECDP6132
38 5/16" (973) 39 13/16" (1011) 36 3/4" (933) 36" (914) 28 5/16" (719)				
	ECDP4536	ECDP4936	ECDP5336	ECDP6136
42 5/16" (1075) 43 13/16" (1113) 40 3/4" (1035) 40" (1016) 32 5/16" (821)				
	ECDP4540	ECDP4940	ECDP5340	ECDP6140
46 5/16" (1176) 47 13/16" (1214) 44 3/4" (1137) 44" (1118) 36 5/16" (922)				
	ECDP4544	ECDP4944	ECDP5344	ECDP6144
50 5/16" (1278) 51 13/16" (1316) 48 3/4" (1238) 48" (1219) 40 5/16" (1024)				
	ECDP4548	ECDP4948	ECDP5348	ECDP6148
54 5/16" (1380) 55 13/16" (1418) 52 3/4" (1340) 52" (1321) 44 5/16" (1126)				
	ECDP4552	ECDP4952	ECDP5352	ECDP6152
58 5/16" (1481) 59 13/16" (1519) 56 3/4" (1441) 56" (1422) 48 5/16" (1227)				
	ECDP4556	ECDP4956	ECDP5356	ECDP6156

ELEVATION SYMBOL LEGEND:

M.O. = MASONRY OPENING
VALUES IN () ARE IN MILLIMETER CONVERSIONS

Note: Elevations shown DO NOT have exterior trim. Subtract 1/2" (12.7) from M.O. (Masonry Opening) for Unit Sizes. Masonry Openings above include Sill Nose, see Trim Options page for Sill Nose specifications. For other Trim Options refer to the Unit Sizing, Rough Opening & Masonry Openings page.

SCALE 1/4" = 1'

PICTURE UNITS

M.O. BRICKMOULD
M.O. ADAMS/FLAT CASING
ROUGH OPENING
FRAME SIZE
DAYLIGHT OPENING

48 7/8" (1241)
51 7/8" (1318)
46 1/8" (1172)
45 3/8" (1153)
38 13/16" (986)

52 7/8" (1343)
55 7/8" (1419)
50 1/8" (1273)
49 3/8" (1254)
42 13/16" (1087)

56 7/8" (1445)
59 7/8" (1581)
54 1/8" (1375)
53 3/8" (1356)
46 13/16" (1189)

64 7/8" (1648)
67 7/8" (1724)
62 1/8" (1578)
61 3/8" (1559)
54 13/16" (1392)

62 5/16" (1583)
63 13/16" (1621)
60 3/4" (1543)
60" (1524)
52 5/16" (1329)

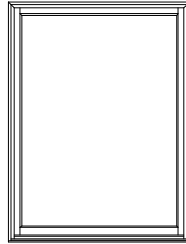

ECDP4560

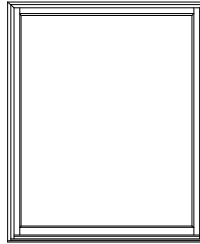

ECDP4960

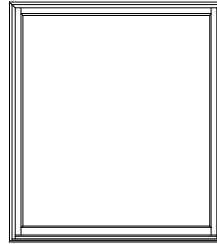

ECDP5360

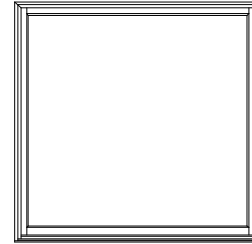

ECDP6160

66 5/16" (1684)
69 13/16" (1773)
64 3/4" (1645)
64" (1626)
56 5/16" (1430)

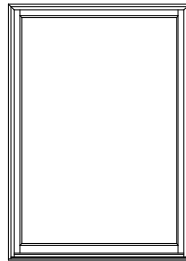

ECDP4564

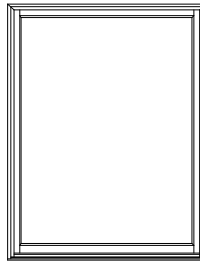

ECDP4964

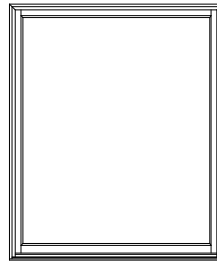

ECDP5364

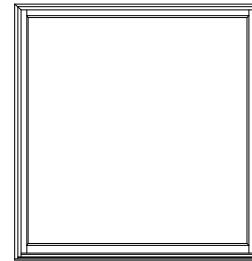

ECDP6164

70 5/16" (1786)
71 13/16" (1824)
68 3/4" (1746)
68" (1727)
60 5/16" (1532)

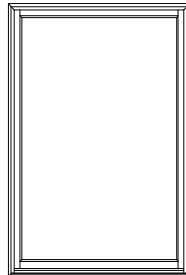

ECDP4568

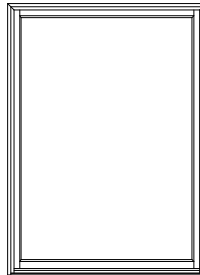

ECDP4968

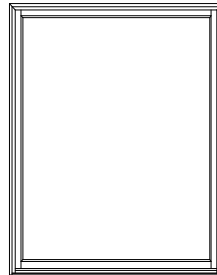

ECDP5368

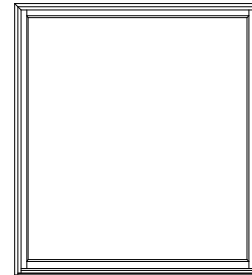

ECDP6168

74 5/16" (1888)
75 13/16" (1926)
72 3/4" (1848)
72" (1829)
64 5/16" (1634)

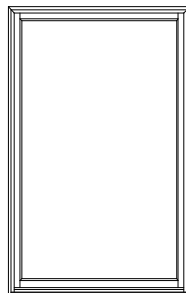

ECDP4572

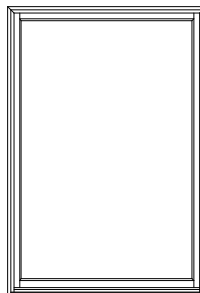

ECDP4972

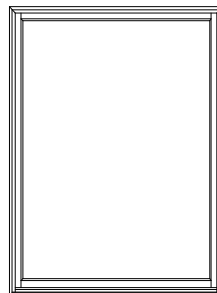

ECDP5372

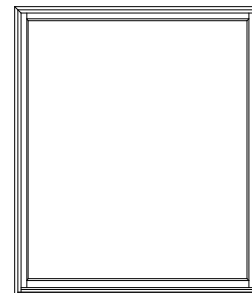

ECDP6172

78 5/16" (1989)
79 13/16" (2027)
76 3/4" (1949)
76" (1930)
68 5/16" (1735)

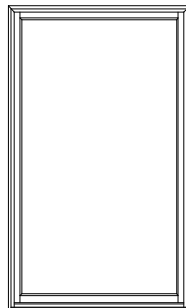

ECDP4576

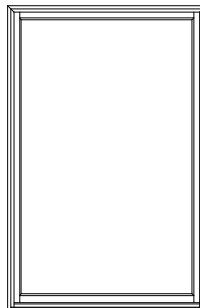

ECDP4976

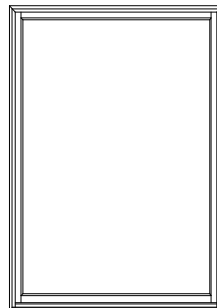

ECDP5376

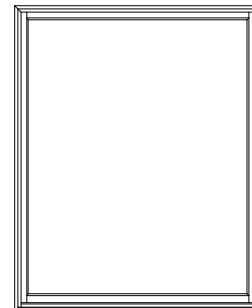

ECDP6176

ELEVATION SYMBOL LEGEND:

M.O. = MASONRY OPENING
VALUES IN () ARE IN MILLIMETER CONVERSIONS

Note: Elevations shown DO NOT have exterior trim. Subtract 1/2" (12.7) from M.O. (Masonry Opening) for Unit Sizes. Masonry Openings above include Sill Nose, see Trim Options page for Sill Nose specifications. For other Trim Options refer to the Unit Sizing, Rough Opening & Masonry Openings page.

SCALE 1/4" = 1'

PICTURE UNITS

M.O. BRICKMOULD
M.O. ADAMS/FLAT CASING
ROUGH OPENING
FRAME SIZE
DAYLIGHT OPENING

48 7/8" (1241)
51 7/8" (1318)
46 1/8" (1172)
45 3/8" (1153)
38 13/16" (986)

52 7/8" (1343)
55 7/8" (1419)
50 1/8" (1273)
49 3/8" (1254)
42 13/16" (1087)

56 7/8" (1445)
59 7/8" (1581)
54 1/8" (1375)
53 3/8" (1356)
46 13/16" (1189)

64 7/8" (1648)
67 7/8" (1724)
62 1/8" (1578)
61 3/8" (1559)
54 13/16" (1392)

82 5/16" (2091)
83 13/16" (2129)
80 3/4" (2051)
80" (2032)
72 5/16" (1837)

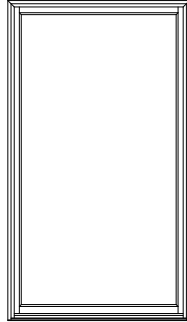

ECDP4580

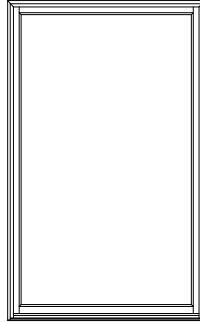

ECDP4980

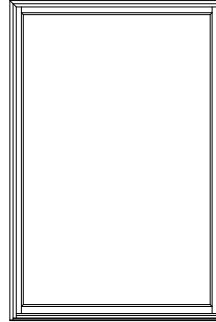

ECDP5380

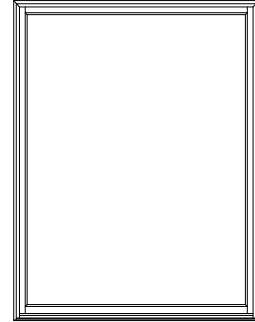

ECDP6180

90 5/16" (2294)
91 13/16" (2332)
88 3/4" (2254)
88" (2235)
80 5/16" (2040)

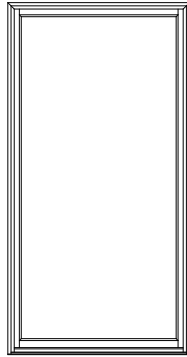

ECDP4588

94 5/16" (2396)
95 13/16" (2434)
92 3/4" (2356)
92" (2337)
84 5/16" (2142)

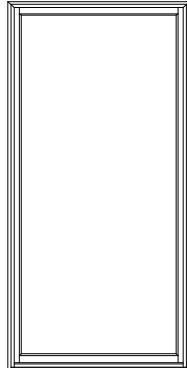

ECDP4592

ELEVATION SYMBOL LEGEND:
M.O. = MASONRY OPENING
VALUES IN () ARE IN MILLIMETER CONVERSIONS

Note: Elevations shown DO NOT have exterior trim. Subtract 1/2" (12.7) from M.O. (Masonry Opening) for Unit Sizes. Masonry Openings above include Sill Nose, see Trim Options page for Sill Nose specifications. For other Trim Options refer to the Unit Sizing, Rough Opening & Masonry Openings page.

SCALE 1/4" = 1'

PICTURE UNITS

**M.O. BRICKMOUND
M.O. ADAMS/FLAT CASING
ROUGH OPENING
FRAME SIZE
DAYLIGHT OPENING**

72 7/8"(1851)
75 7/8"(1927)
70 1/8"(1781)
69 3/8"(1762)
62 13/16"(1595)

80 7/8"(2054)
83 7/8"(2130)
78 1/8"(1984)
77 3/8"(1965)
70 13/16"(1799)

34 5/16"(872)
35 13/16"(910)
32 3/4"(832)
32"(813)
24 5/16"(618)



ECDP6932



ECDP7732

38 5/16"(973)
39 13/16"(1011)
36 3/4"(933)
36"(914)
28 5/16"(719)



ECDP6936



ECDP7736

42 5/16"(1075)
43 13/16"(1113)
40 3/4"(1035)
40"(1016)
32 5/16"(821)



ECDP6940



ECDP7740

46 5/16"(1176)
47 13/16"(1214)
44 3/4"(1137)
44"(1118)
36 5/16"(922)

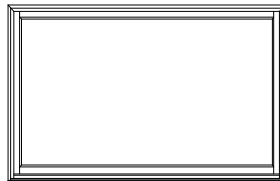

ECDP6944

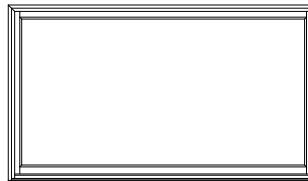

ECDP7744

50 5/16"(1278)
51 13/16"(1316)
48 3/4"(1238)
48"(1219)
40 5/16"(1024)

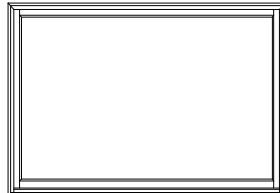

ECDP6948

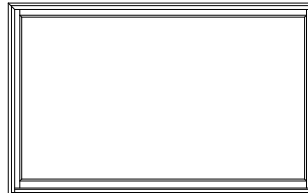

ECDP7748

54 5/16"(1380)
55 13/16"(1418)
52 3/4"(1340)
52"(1321)
44 5/16"(1126)

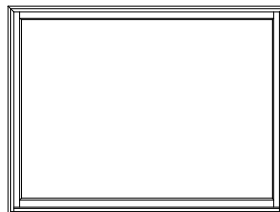

ECDP6952

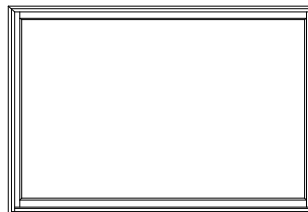

ECDP7752

58 5/16"(1481)
59 13/16"(1519)
56 3/4"(1441)
56"(1422)
48 5/16"(1227)

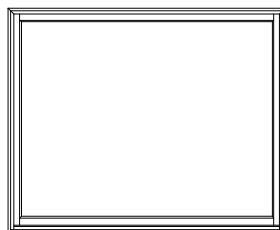

ECDP6956

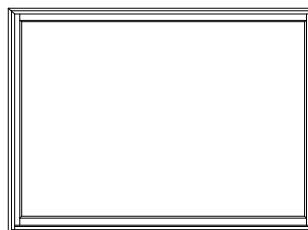

ECDP7756

ELEVATION SYMBOL LEGEND:

M.O. = MASONRY OPENING
VALUES IN () ARE IN MILLIMETER CONVERSIONS

Note: Elevations shown DO NOT have exterior trim. Subtract 1/2" (12.7) from M.O. (Masonry Opening) for Unit Sizes. Masonry Openings above include Sill Nose, see Trim Options page for Sill Nose specifications. For other Trim Options refer to the Unit Sizing, Rough Opening & Masonry Openings page.

SCALE 1/4" = 1'

PICTURE UNITS

M.O. BRICKMOULD
M.O. ADAMS/FLAT CASING
ROUGH OPENING
FRAME SIZE
DAYLIGHT OPENING

72 7/8" (1851)
75 7/8" (1927)
70 1/8" (1781)
69 3/8" (1762)
62 13/16" (1595)

80 7/8" (2054)
83 7/8" (2130)
78 1/8" (1984)
77 3/8" (1965)
70 13/16" (1799)

62 5/16" (1583)
63 13/16" (1621)
60 3/4" (1543)
60" (1524)
52 5/16" (1329)

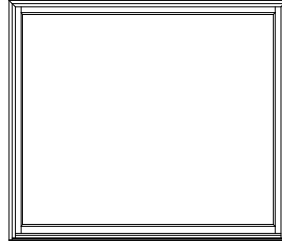

ECDP6960

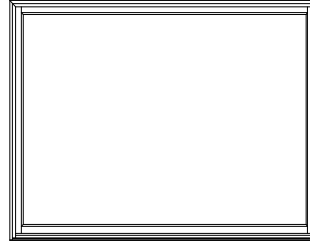

ECDP7760

66 5/16" (1684)
69 13/16" (1773)
64 3/4" (1645)
64" (1626)
56 5/16" (1430)

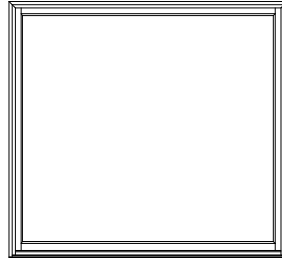

ECDP6964

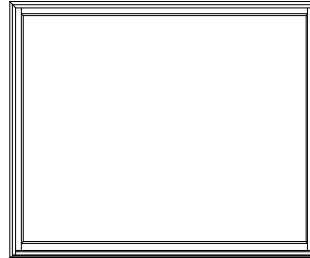

ECDP7764

70 5/16" (1786)
71 13/16" (1824)
68 3/4" (1746)
68" (1727)
60 5/16" (1532)

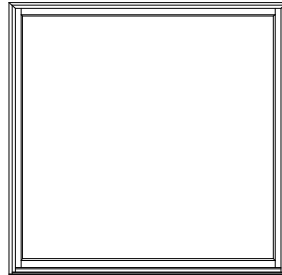

ECDP6968

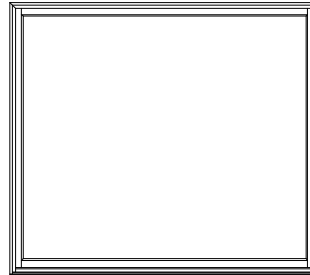

ECDP7768

74 5/16" (1888)
75 13/16" (1926)
72 3/4" (1848)
72" (1829)
64 5/16" (1634)

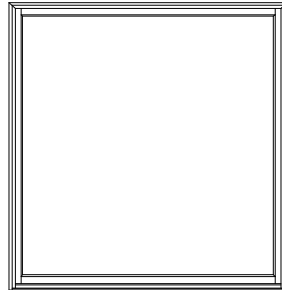

ECDP6972

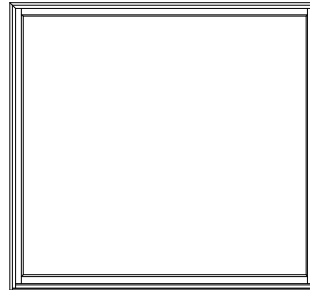

ECDP7772

78 5/16" (1989)
79 13/16" (2027)
76 3/4" (1949)
76" (1930)
68 5/16" (1735)

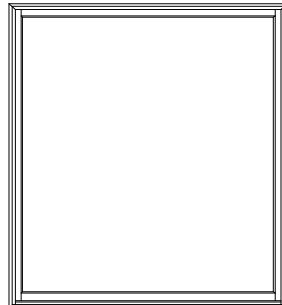

ECDP6976

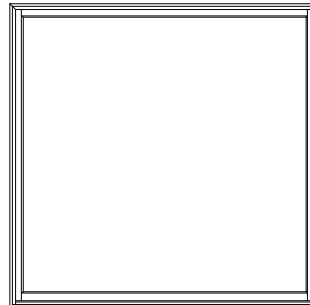

ECDP7776

ELEVATION SYMBOL LEGEND:

M.O. = MASONRY OPENING
VALUES IN () ARE IN MILLIMETER CONVERSIONS

Note: Elevations shown DO NOT have exterior trim. Subtract 1/2" (12.7) from M.O. (Masonry Opening) for Unit Sizes. Masonry Openings above include Sill Nose, see Trim Options page for Sill Nose specifications. For other Trim Options refer to the Unit Sizing, Rough Opening & Masonry Openings page.

SCALE 1/4" = 1'

PICTURE UNITS

M.O. BRICKMOULD
M.O. ADAMS/FLAT CASING
ROUGH OPENING
FRAME SIZE
DAYLIGHT OPENING

72 7/8" (1851)
75 7/8" (1927)
70 1/8" (1781)
69 3/8" (1762)
62 13/16" (1595)

80 7/8" (2054)
83 7/8" (2130)
78 1/8" (1984)
77 3/8" (1965)
70 13/16" (1799)

82 5/16" (2091)
83 13/16" (2129)
80 3/4" (2051)
80" (2032)
72 5/16" (1837)

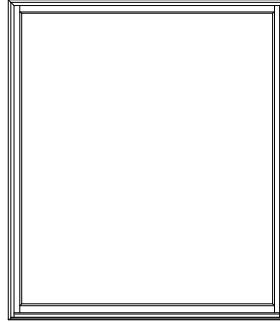

ECDP6980

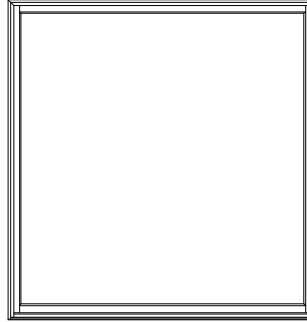





ECDP7780

ELEVATION SYMBOL LEGEND:
M.O. = MASONRY OPENING
VALUES IN () ARE IN MILLIMETER CONVERSIONS

Note: Elevations shown DO NOT have exterior trim. Subtract 1/2" (12.7) from M.O. (Masonry Opening) for Unit Sizes. Masonry Openings above include Sill Nose, see Trim Options page for Sill Nose specifications. For other Trim Options refer to the Unit Sizing, Rough Opening & Masonry Openings page.

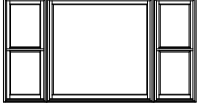
SCALE 1/4" = 1'

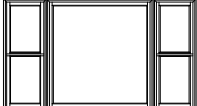

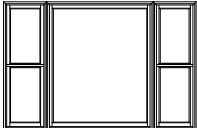
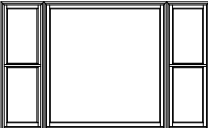



PICTURE UNITS WITH 16" FLANKERS

M.O. BRICKMOULD	99 5/8" (2530)	107 5/8" (2734)
M.O. ADAMS/FLAT CASING	102 5/8" (2607)	110 5/8" (2810)
ROUGH OPENING	96 7/8" (2461)	104 7/8" (2664)
FRAME SIZE	96 1/8" (2442)	104 1/8" (2645)
DAYLIGHT OPENING	14 13/16" (376) [2] 46 13/16" (1189)	14 13/16" (376) [2] 54 13/16" (1392)
54 5/16" (1380) 55 13/16" (1418) 52 3/4" (1340) 52" (1321) 21 1/16" (535) [2] 44 5/16" (1126)		
	ECD5352-16	ECD6152-16
58 5/16" (1481) 59 13/16" (1519) 56 3/4" (1441) 56" (1422) 23 1/16" (586) [2] 48 5/16" (1227)		
	ECD5356-16	ECD6156-16
66 5/16" (1684) 67 13/16" (1722) 64 3/4" (1645) 64" (1626) 27 1/16" (687) [2] 56 5/16" (1430)		
	ECD5364-16	ECD6164-16

ELEVATION SYMBOL LEGEND:
M.O. = MASONRY OPENING
 VALUES IN () ARE IN MILLIMETER CONVERSIONS
 VALUES IN [] ARE NUMBER OF DAYLIGHT OPENINGS PER UNIT

Note: Elevations shown DO NOT have exterior trim. Subtract 1/2" (12.7) from M.O. (Masonry Opening) for Unit Sizes. Masonry Openings above include Sill Nose, see Trim Options page for Sill Nose specifications. For other Trim Options refer to the Unit Sizing, Rough Opening & Masonry Openings page.

PICTURE UNITS WITH 20" FLANKERS

M.O. BRICKMOULD	107 5/8" (2734)	115 5/8" (2937)
M.O. ADAMS/FLAT CASING	110 5/8" (2810)	118 5/8" (3013)
ROUGH OPENING	104 7/8" (2664)	112 7/8" (2867)
FRAME SIZE	104 1/8" (2645)	112 1/8" (2848)
DAYLIGHT OPENING	18 13/16" (478)[2] 54 13/16" (1392)	18 13/16" (478)[2] 62 13/16" (1595)
54 5/16" (1380) 55 13/16" (1418) 52 3/4" (1340) 52" (1321) 21 1/16" (535)[2] 44 5/16" (1126)	 ECD6152-20	 ECD6952-20
58 5/16" (1481) 59 13/16" (1519) 56 3/4" (1441) 56" (1422) 23 1/16" (586)[2] 48 5/16" (1227)	 ECD6156-20	 ECD6956-20
66 5/16" (1684) 67 13/16" (1722) 64 3/4" (1645) 64" (1626) 27 1/16" (687)[2] 56 5/16" (1430)	 ECD6164-20	 ECD6964-20

ELEVATION SYMBOL LEGEND:

M.O. = MASONRY OPENING
VALUES IN () ARE IN MILLIMETER CONVERSIONS
VALUES IN [] ARE NUMBER OF DAYLIGHT OPENINGS PER UNIT

Note: Elevations shown DO NOT have exterior trim. Subtract 1/2" (12.7) from M.O. (Masonry Opening) for Unit Sizes. Masonry Openings above include Sill Nose, see Trim Options page for Sill Nose specifications. For other Trim Options refer to the Unit Sizing, Rough Opening & Masonry Openings page.

GENERAL INFORMATION
SECTOR TOP SINGLE-HUNG UNITS

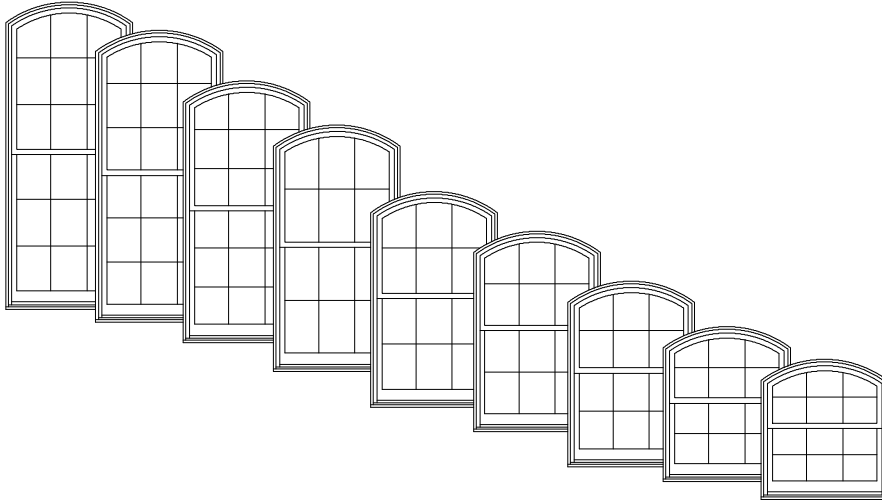
**DIMENSIONAL WINDOWS**

Clad sector top single-hung windows may be specified as "dimensional" by adjusting the desired rough opening width or height in 1/4" increments from standard.

Clad sector top single-hung windows feature stationary (fixed) upper sash and an operating lower sash. Counterbalancing is achieved with block and tackle spring extension systems hidden in weatherable PVC jamb liners. Operating units are supplied with cam-type sash locks installed. Die-cast lower sash lifts supplied for field installation are an option. Recessed sash retainers provide simple sash installation and removal. There are several hardware finish options. Refer to the Specifications for available finish options.

SITELINE EX CLAD SECTOR TOP SINGLE-HUNG WINDOWS utilize some of the same options as SITELINE EX CLAD DOUBLE-HUNG WINDOWS. Those options have not been repeated here in this sub-section.

See the SITELINE EX CLAD DOUBLE-HUNG section for:
Jamb Extender Options.

HANDING & OPERATION
SECTOR TOP SINGLE-HUNG UNITS

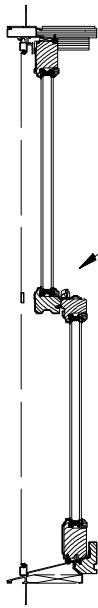

SINGLE-HUNG OPERATION:
When the sash are locked at the check rails the sash are closed and sealed in the sash opening of the frame.

When the sash are unlocked the lower sash travels vertically to any position desired. The upper sash is fixed.

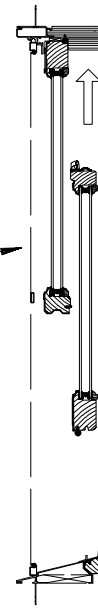

SASH TILTING FOR WASHING

The Clad Single-Hung window will allow the lower sash to be tilted or removed for easy cleaning.

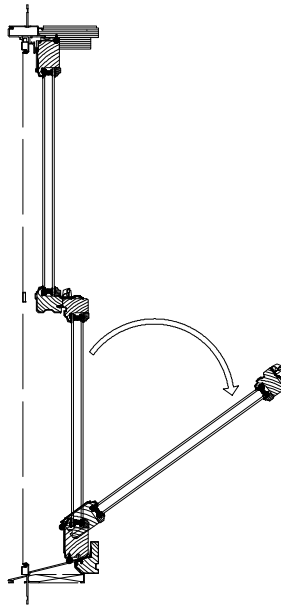

ELEVATION NOTES
SECTOR TOP SINGLE-HUNG UNITS

ELEVATION DRAWINGS UTILIZE A LIMITED NUMBER OF PROJECTED LINES TO PRODUCE A RUDIMENTARY DRAWING INTENDED TO BE USED IN A SMALL GRAPHICAL SCALE. ELEVATIONS ARE VIEWED PERPENDICULAR FROM THE EXTERIOR OF THE STRUCTURE. IF MORE DIMENSIONS ARE NEEDED, USE THE SECTION DRAWINGS FOR MORE COMPLETE DEPICTIONS.

M.O. Brickmould
M.O. Adams/Flat Casing
Rough Opening
Frame Size
Daylight Opening

28 7/8"(733)
31 7/8"(810)
26 1/8"(664)
25 3/8"(645)
18 13/16"(478)

Masonry Openings for Brickmould, Flat & Adams Casing.
Vertical measurements include sillnose.
(Subtract 1/2" from Masonry Opening for Unit Size)

58 5/16"(1481)
59 13/16"(1519)
56 3/4"(1441)
56"(1422)
23 1/16"(586) 23 5/16"(592)

DAYLIGHT OPENING

OUTSIDE OF FRAME

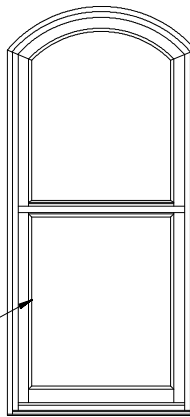

ECDS2556

BOOK CODE

'ECDS' INDICATES
SITELINE EX CLAD SECTOR TOP SINGLE-HUNG

THE FIRST TWO NUMBERS
INDICATE THE UNIT WIDTH

THE LAST TWO NUMBERS INDICATE
THE UNIT HEIGHT

GENERAL SINGLE-HUNG NOTES

1. ALL UNITS SHOWN ARE AVAILABLE AS OPERATORS ONLY.
2. UNIT ELEVATIONS ARE SHOWN WITHOUT EXTERIOR TRIM.
3. ALL OPERATING SASH ARE INSTALLED WITH VINYL JAMB LINERS AND OPERATED WITH AN INTERNAL BLOCK AND TACKLE SPRING SYSTEM.
4. DIMENSIONAL VALUES IN PARENTHESES ARE MILLIMETER CONVERSIONS.
5. VALUES IN BRACKETS ARE NUMBER OF DAYLIGHT OPENINGS.

ELEVATION SYMBOL LEGEND:

MO MASONRY OPENING

SECTOR TOP UNITS - 1-WIDE

M.O. BRICKMOULD
M.O. ADAMS/FLAT CASING
ROUGH OPENING
FRAME SIZE
DAYLIGHT OPENING

28 7/8" (733)	32 7/8" (835)	34 7/8" (886)	36 7/8" (937)	40 7/8" (1038)	44 7/8" (1140)	48 7/8" (1241)
31 7/8" (810)	35 7/8" (911)	37 7/8" (962)	39 7/8" (1013)	43 7/8" (1114)	47 7/8" (1216)	51 7/8" (1318)
26 1/8" (664)	30 1/8" (765)	32 1/8" (816)	34 1/8" (867)	38 1/8" (968)	42 1/8" (1070)	46 1/8" (1172)
25 3/8" (645)	29 3/8" (746)	31 3/8" (797)	33 3/8" (848)	37 3/8" (949)	41 3/8" (1051)	45 3/8" (1153)
18 13/16" (478)	22 13/16" (579)	24 13/16" (630)	26 13/16" (681)	30 13/16" (783)	34 13/16" (884)	38 13/16" (986)

34 5/16" (872)
35 13/16" (910)
32 3/4" (832)
32" (813)
11 1/16" (281) [2]



38 5/16" (973)
39 13/16" (1011)
36 3/4" (933)
36" (914)
13 1/16" (332) [2]



42 5/16" (1075)
43 13/16" (1113)
40 3/4" (1035)
40" (1016)
15 1/16" (383) [2]

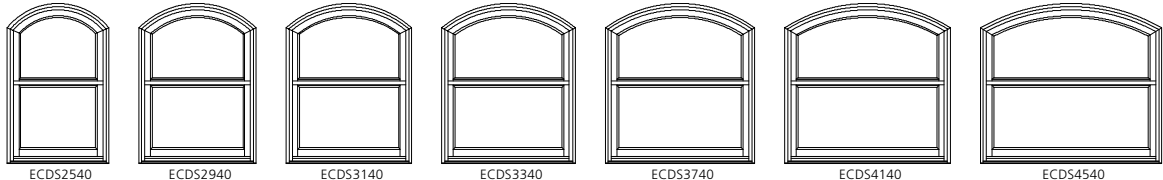

46 5/16" (1176)
47 13/16" (1214)
44 3/4" (1137)
44" (1118)
17 1/16" (433) [2]

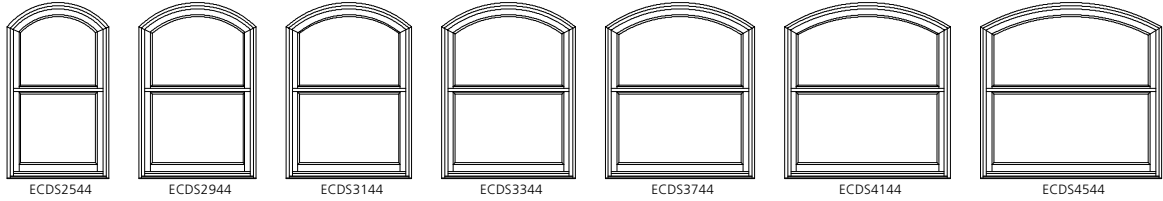

50 5/16" (1278)
51 13/16" (1316)
48 3/4" (1238)
48" (1219)
19 1/16" (484) [2]

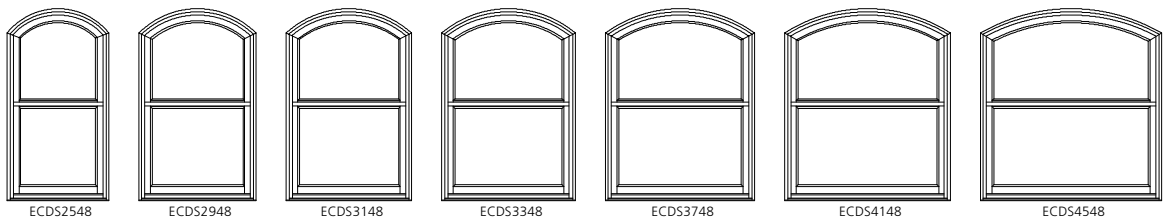

54 5/16" (1380)
55 13/16" (1418)
52 3/4" (1340)
52" (1321)
21 1/16" (535) [2]

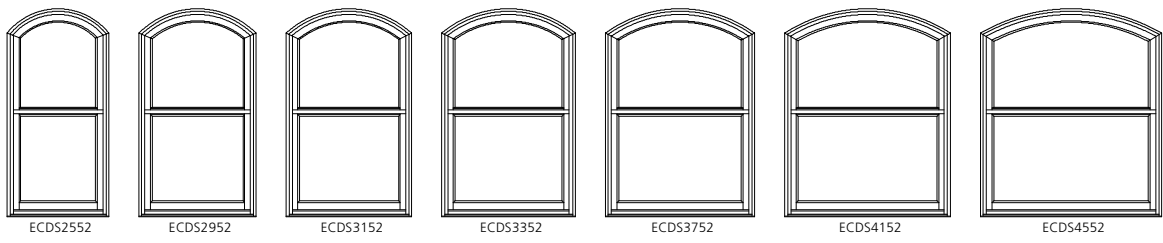

58 5/16" (1481)
59 13/16" (1519)
56 3/4" (1441)
56" (1422)
23 1/16" (586) [2]

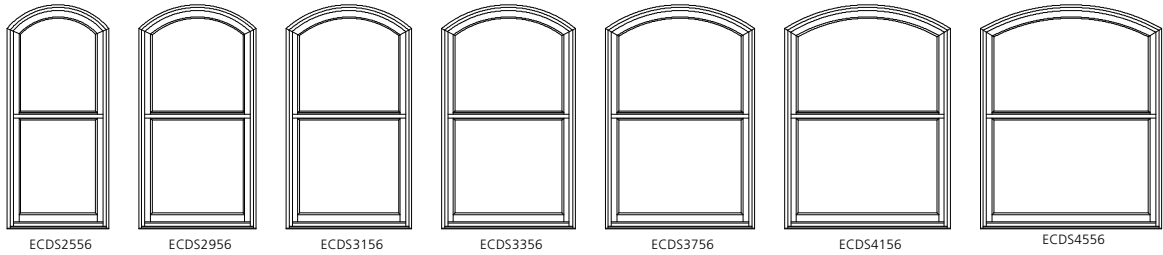











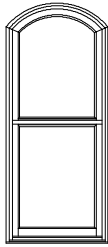
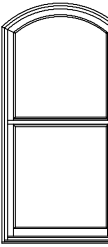

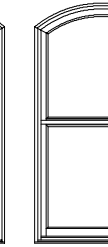



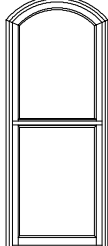
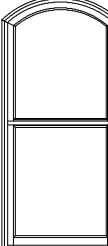

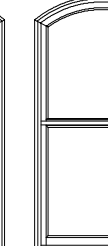



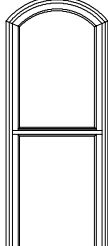

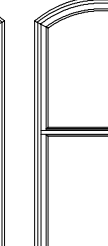
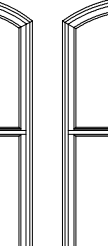
ELEVATION SYMBOL LEGEND:
M.O. = MASONRY OPENING
VALUES IN () ARE IN MILLIMETER CONVERSIONS
VALUES IN [] ARE NUMBER OF DAYLIGHT OPENINGS PER UNIT

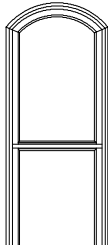
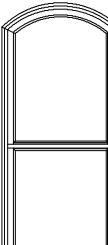
Note: Elevations shown DO NOT have exterior trim. Subtract 1/2" (12.7) from M.O. (Masonry Opening) for Unit Sizes. Masonry Openings above include Sill Nose, see Trim Options page for Sill Nose specifications. For other Trim Options refer to the Unit Sizing, Rough Opening & Masonry Openings page.

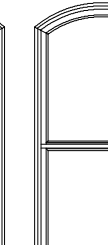
SCALE 1/4" = 1'

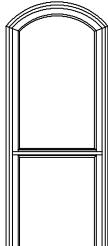
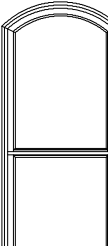
SECTOR TOP UNITS - 1-WIDE

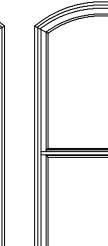
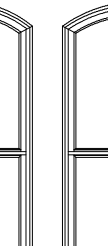
M.O. BRICKMOULD	28 7/8" (733)	32 7/8" (835)	34 7/8" (886)	36 7/8" (937)	40 7/8" (1038)	44 7/8" (1140)	48 7/8" (1241)
M.O. ADAMS/FLAT CASING	31 7/8" (810)	35 7/8" (911)	37 7/8" (962)	39 7/8" (1013)	43 7/8" (1114)	47 7/8" (1216)	51 7/8" (1318)
ROUGH OPENING	26 1/8" (664)	30 1/8" (765)	32 1/8" (816)	34 1/8" (867)	38 1/8" (968)	42 1/8" (1070)	46 1/8" (1172)
FRAME SIZE	25 3/8" (645)	29 3/8" (746)	31 3/8" (797)	33 3/8" (848)	37 3/8" (949)	41 3/8" (1051)	45 3/8" (1153)
DAYLIGHT OPENING	18 13/16" (478)	22 13/16" (579)	24 13/16" (630)	26 13/16" (681)	30 13/16" (783)	34 13/16" (884)	38 13/16" (986)

<p>62 5/16" (1583) 63 13/16" (1621) 60 3/4" (1543) 60" (1524) 25 1/16" (637) 2 </p>									
	ECDS2560	ECDS2960	ECDS3160	ECDS3360	ECDS3760	ECDS4160	ECDS4560		
	<p>66 5/16" (1684) 67 13/16" (1722) 64 3/4" (1645) 64" (1626) 27 1/16" (687) 2 </p>								
		ECDS2564	ECDS2964	ECDS3164	ECDS3364	ECDS3764	ECDS4164	ECDS4564	
		<p>70 5/16" (1786) 71 13/16" (1824) 68 3/4" (1746) 68" (1727) 29 1/16" (738) 2 </p>							
			ECDS2568	ECDS2968	ECDS3168	ECDS3368	ECDS3768	ECDS4168	ECDS4568
			<p>74 5/16" (1888) 75 13/16" (1926) 72 3/4" (1848) 72" (1829) 31 1/16" (789) 2 </p>						
ECDS2572				ECDS2972	ECDS3172	ECDS3372	ECDS3772	ECDS4172	ECDS4572
<p>78 5/16" (1989) 79 13/16" (2027) 76 3/4" (1949) 76" (1930) 33 1/16" (840) 2 </p>									
	ECDS2576			ECDS2976	ECDS3176	ECDS3376	ECDS3776	ECDS4176	ECDS4576

ELEVATION SYMBOL LEGEND:
M.O. = MASONRY OPENING
 VALUES IN () ARE IN MILLIMETER CONVERSIONS
 VALUES IN | | ARE NUMBER OF DAYLIGHT OPENINGS PER UNIT

Note: Elevations shown DO NOT have exterior trim. Subtract 1/2" (12.7) from M.O. (Masonry Opening) for Unit Sizes. Masonry Openings above include Sill Nose, see Trim Options page for Sill Nose specifications. For other Trim Options refer to the Unit Sizing, Rough Opening & Masonry Openings page.

SCALE 1/4" = 1'

SECTOR TOP UNITS - 1-WIDE

M.O. BRICKMOULD	28 7/8" (733)	32 7/8" (835)	34 7/8" (886)	36 7/8" (937)	40 7/8" (1038)	44 7/8" (1140)	48 7/8" (1241)
M.O. ADAMS/FLAT CASING	31 7/8" (810)	35 7/8" (911)	37 7/8" (962)	39 7/8" (1013)	43 7/8" (1114)	47 7/8" (1216)	51 7/8" (1318)
ROUGH OPENING	26 1/8" (664)	30 1/8" (765)	32 1/8" (816)	34 1/8" (867)	38 1/8" (968)	42 1/8" (1070)	46 1/8" (1172)
FRAME SIZE	25 3/8" (645)	29 3/8" (746)	31 3/8" (797)	33 3/8" (848)	37 3/8" (949)	41 3/8" (1051)	45 3/8" (1153)
DAYLIGHT OPENING	18 13/16" (478)	22 13/16" (579)	24 13/16" (630)	26 13/16" (681)	30 13/16" (783)	34 13/16" (884)	38 13/16" (986)

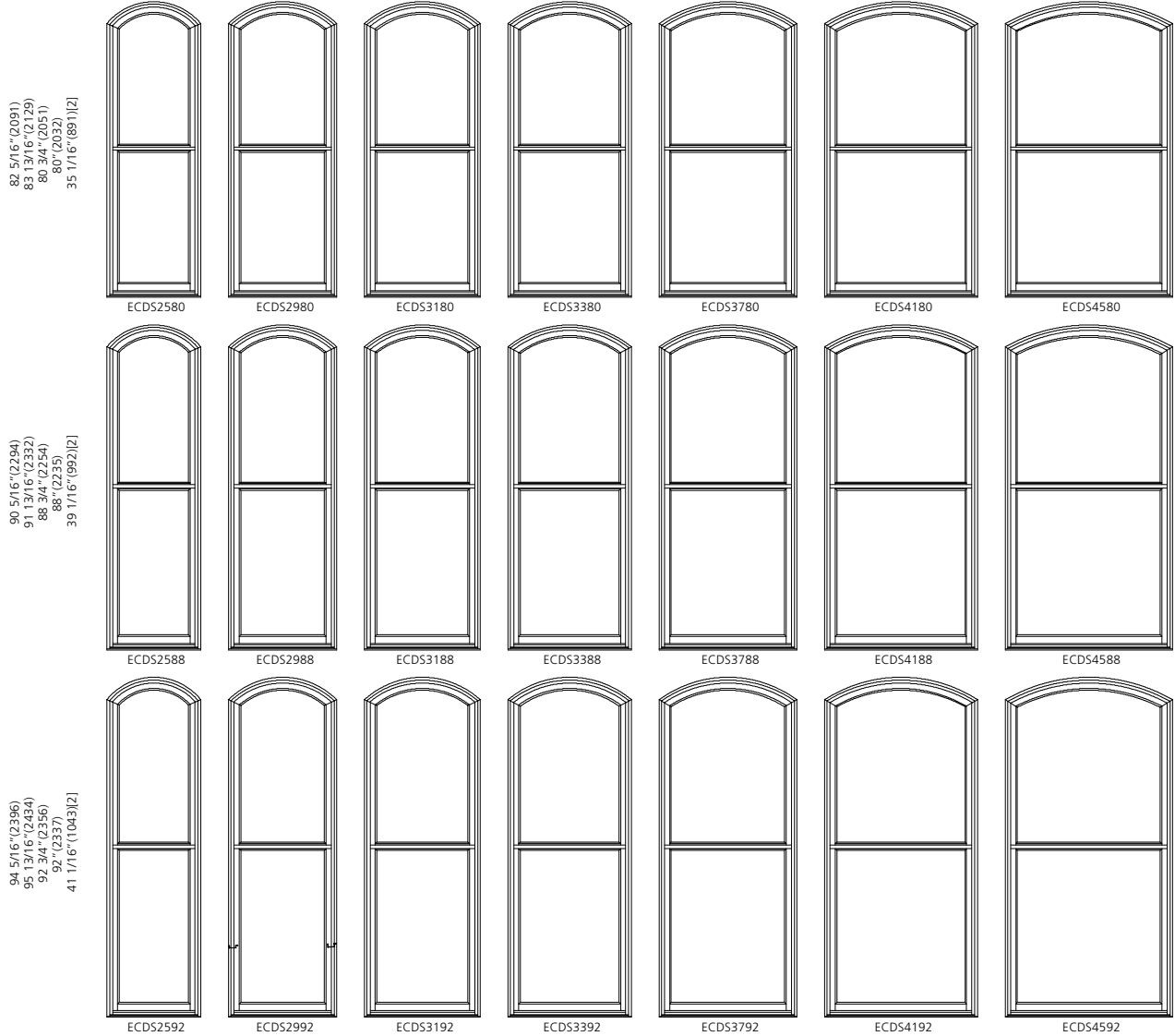





























































ELEVATION SYMBOL LEGEND:

M.O. = MASONRY OPENING
VALUES IN () ARE IN MILLIMETER CONVERSIONS
VALUES IN [] ARE NUMBER OF DAYLIGHT OPENINGS PER UNIT

Note: Elevations shown DO NOT have exterior trim. Subtract 1/2" (12.7) from M.O. (Masonry Opening) for Unit Sizes. Masonry Openings above include Sill Nose, see Trim Options page for Sill Nose specifications. For other Trim Options refer to the Unit Sizing, Rough Opening & Masonry Openings page.

SCALE 1/4" = 1'

SECTOR TOP UNITS - 2-WIDE





M.O. BRICKMOULD	54 1/4" (1378)	62 1/4" (1581)	66 1/4" (1683)	70 1/4" (1784)	78 1/4" (1988)	86 1/4" (2191)
M.O. ADAMS/FLAT CASING	57 1/4" (1454)	65 1/4" (1657)	69 1/4" (1759)	73 1/4" (1861)	81 1/4" (2064)	89 1/4" (2267)
ROUGH OPENING	51 1/2" (1308)	59 1/2" (1511)	63 1/2" (1613)	67 1/2" (1715)	75 1/2" (1918)	83 1/2" (2121)
FRAME SIZE	50 3/4" (1289)	58 3/4" (1492)	62 3/4" (1594)	66 3/4" (1695)	74 3/4" (1899)	82 3/4" (2102)
DAYLIGHT OPENING	18 13/16" (478) [2]	22 13/16" (579) [2]	24 13/16" (630) [2]	26 13/16" (681) [2]	30 13/16" (783) [2]	34 13/16" (884) [2]
34 5/16" (872) 35 13/16" (910) 32 3/4" (832) 32" (813) 36" (914) 13 1/16" (332) [2] 11 1/16" (281) [2]	 ECDS2532-2	 ECDS2932-2	 ECDS3132-2	 ECDS3332-2	 ECDS3732-2	 ECDS4132-2
38 5/16" (973) 39 13/16" (1011) 36 3/4" (933) 36" (914) 13 1/16" (332) [2]	 ECDS2536-2	 ECDS2936-2	 ECDS3136-2	 ECDS3336-2	 ECDS3736-2	 ECDS4136-2
42 5/16" (1075) 43 13/16" (1113) 40 3/4" (1035) 40" (1016) 15 1/16" (385) [2]	 ECDS2540-2	 ECDS2940-2	 ECDS3140-2	 ECDS3340-2	 ECDS3740-2	 ECDS4140-2
46 5/16" (1176) 47 13/16" (1214) 44 3/4" (1137) 44" (1118) 17 1/16" (433) [2]	 ECDS2544-2	 ECDS2944-2	 ECDS3144-2	 ECDS3344-2	 ECDS3744-2	 ECDS4144-2
50 5/16" (1278) 51 13/16" (1316) 48 3/4" (1238) 48" (1219) 19 1/16" (484) [2]	 ECDS2548-2	 ECDS2948-2	 ECDS3148-2	 ECDS3348-2	 ECDS3748-2	 ECDS4148-2
54 5/16" (1380) 55 13/16" (1418) 52 3/4" (1340) 52" (1321) 21 1/16" (535) [2]	 ECDS2552-2	 ECDS2952-2	 ECDS3152-2	 ECDS3352-2	 ECDS3752-2	 ECDS4152-2
58 5/16" (1481) 59 13/16" (1519) 56 3/4" (1441) 56" (1422) 23 1/16" (586) [2]	 ECDS2556-2	 ECDS2956-2	 ECDS3156-2	 ECDS3356-2	 ECDS3756-2	 ECDS4156-2
62 5/16" (1583) 63 13/16" (1621) 60 3/4" (1543) 60" (1524) 25 1/16" (637) [2]	 ECDS2560-2	 ECDS2960-2	 ECDS3160-2	 ECDS3360-2	 ECDS3760-2	 ECDS4160-2
66 5/16" (1684) 67 13/16" (1722) 64 3/4" (1645) 64" (1626) 27 1/16" (687) [2]	 ECDS2564-2	 ECDS2964-2	 ECDS3164-2	 ECDS3364-2	 ECDS3764-2	 ECDS4164-2
70 5/16" (1786) 71 13/16" (1824) 68 3/4" (1746) 68" (1727) 29 1/16" (738) [2]	 ECDS2568-2	 ECDS2968-2	 ECDS3168-2	 ECDS3368-2	 ECDS3768-2	 ECDS4168-2

ELEVATION SYMBOL LEGEND:
M.O. = MASONRY OPENING
VALUES IN () ARE IN MILLIMETER CONVERSIONS
VALUES IN [] ARE NUMBER OF DAYLIGHT OPENINGS PER UNIT

Note: Elevations shown DO NOT have exterior trim. Subtract 1/2" (12.7) from M.O. (Masonry Opening) for Unit Sizes. Masonry Openings above include Sill Nose, see Trim Options page for Sill Nose specifications. For other Trim Options refer to the Unit Sizing, Rough Opening & Masonry Openings page.

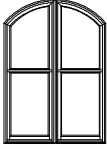
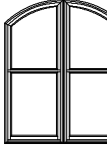
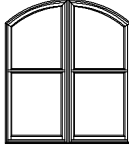
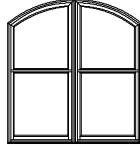
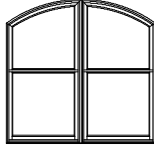
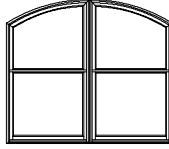
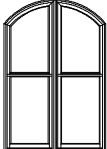
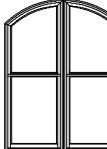
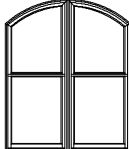
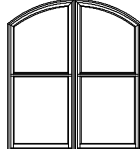
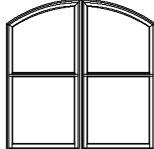
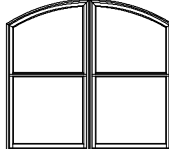
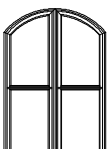
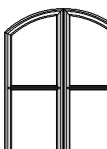
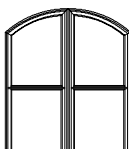
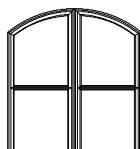
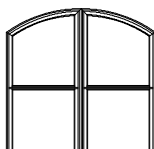
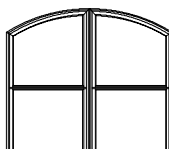
SCALE 1/4" = 1'

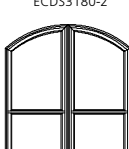
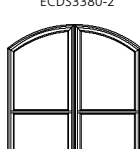
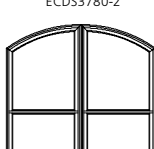
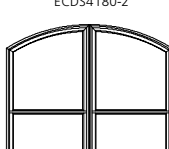
SECTOR TOP UNITS - 2-WIDE

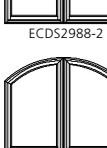
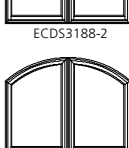
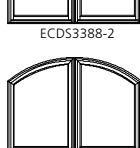
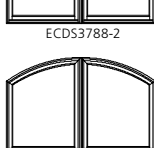
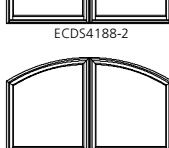
M.O. BRICKMOUND	54 1/4"(1378)	62 1/4"(1581)	66 1/4"(1683)	70 1/4"(1784)	78 1/4"(1988)	86 1/4"(2191)
M.O. ADAMS/FLAT CASING	57 1/4"(1454)	65 1/4"(1657)	69 1/4"(1759)	73 1/4"(1861)	81 1/4"(2064)	89 1/4"(2267)
ROUGH OPENING	51 1/2"(1308)	59 1/2"(1511)	63 1/2"(1613)	67 1/2"(1715)	75 1/2"(1918)	83 1/2"(2121)
FRAME SIZE	50 3/4"(1289)	58 3/4"(1492)	62 3/4"(1594)	66 3/4"(1695)	74 3/4"(1899)	82 3/4"(2102)
DAYLIGHT OPENING	18 13/16"(478)[2]	22 13/16"(579)[2]	24 13/16"(630)[2]	26 13/16"(681)[2]	30 13/16"(783)[2]	34 13/16"(884)[2]
74 5/16"(1888) 75 13/16"(1926) 72 3/4"(1848) 72"(1829) 31 1/16"(789)[2]						
	ECDS2572-2	ECDS2972-2	ECDS3172-2	ECDS3372-2	ECDS3772-2	ECDS4172-2
78 5/16"(1989) 79 13/16"(2027) 76 3/4"(1949) 76"(1930) 33 1/16"(840)[2]						
	ECDS2576-2	ECDS2976-2	ECDS3176-2	ECDS3376-2	ECDS3776-2	ECDS4176-2
82 5/16"(2091) 83 13/16"(2129) 80 3/4"(2051) 80"(2032) 35 1/16"(891)[2]						
	ECDS2580-2	ECDS2980-2	ECDS3180-2	ECDS3380-2	ECDS3780-2	ECDS4180-2
90 5/16"(2294) 91 13/16"(2332) 88 3/4"(2254) 88"(2235) 39 1/16"(992)[2]						
	ECDS2588-2	ECDS2988-2	ECDS3188-2	ECDS3388-2	ECDS3788-2	ECDS4188-2
94 5/16"(2396) 95 13/16"(2434) 92 3/4"(2356) 92"(2337) 41 1/16"(1043)[2]						
	ECDS2592-2	ECDS2992-2	ECDS3192-2	ECDS3392-2	ECDS3792-2	ECDS4192-2

ELEVATION SYMBOL LEGEND:
M.O. = MASONRY OPENING
VALUES IN () ARE IN MILLIMETER CONVERSIONS
VALUES IN [] ARE NUMBER OF DAYLIGHT OPENINGS PER UNIT

Note: Elevations shown DO NOT have exterior trim. Subtract 1/2" (12.7) from M.O. (Masonry Opening) for Unit Sizes. Masonry Openings above include Sill Nose, see Trim Options page for Sill Nose specifications. For other Trim Options refer to the Unit Sizing, Rough Opening & Masonry Openings page.

SCALE 1/4" = 1'

SECTOR TOP UNITS - 2-WIDE

**M.O. BRICKMOUND
M.O. ADAMS/FLAT CASING
ROUGH OPENING
FRAME SIZE
DAYLIGHT OPENING**

94 1/4" (2394)
97 1/4" (2470)
91 1/2" (2324)
90 3/4" (2305)
38 13/16" (986)[2]

34 5/16" (872) 35 13/16" (910) 32 3/4" (832) 32" (813) 11 1/16" (281)[2]		ECDS4532-2
38 5/16" (973) 39 13/16" (1011) 36 3/4" (933) 36" (914) 13 1/16" (332)[2]		ECDS4536-2
42 5/16" (1075) 43 13/16" (1113) 40 3/4" (1035) 40" (1016) 15 1/16" (383)[2]		ECDS4540-2
46 5/16" (1176) 47 13/16" (1214) 44 3/4" (1137) 44" (1118) 17 1/16" (433)[2]		ECDS4544-2
50 5/16" (1278) 51 13/16" (1316) 48 3/4" (1238) 48" (1219) 19 1/16" (484)[2]		ECDS4548-2
54 5/16" (1380) 55 13/16" (1418) 52 3/4" (1340) 52" (1321) 21 1/16" (535)[2]		ECDS4552-2
58 5/16" (1481) 59 13/16" (1519) 56 3/4" (1441) 56" (1422) 23 1/16" (586)[2]		ECDS4556-2
62 5/16" (1583) 63 13/16" (1621) 60 3/4" (1543) 60" (1524) 25 1/16" (637)[2]		ECDS4560-2
66 5/16" (1684) 67 13/16" (1722) 64 3/4" (1645) 64" (1626) 27 1/16" (687)[2]		ECDS4564-2
70 5/16" (1786) 71 13/16" (1824) 68 3/4" (1746) 68" (1727) 29 1/16" (738)[2]		ECDS4568-2

**M.O. BRICKMOUND
M.O. ADAMS/FLAT CASING
ROUGH OPENING
FRAME SIZE
DAYLIGHT OPENING**

94 1/4" (2394)
97 1/4" (2470)
91 1/2" (2324)
90 3/4" (2305)
38 13/16" (986)[2]

74 5/16" (1888) 75 13/16" (1926) 72 3/4" (1848) 72" (1829) 31 1/16" (789)[2]		ECDS4572-2
78 5/16" (1989) 79 13/16" (2027) 76 3/4" (1949) 76" (1930) 33 1/16" (840)[2]		ECDS4576-2
82 5/16" (2091) 83 13/16" (2129) 80 3/4" (2051) 80" (2032) 35 1/16" (891)[2]		ECDS4580-2
90 5/16" (2294) 91 13/16" (2332) 88 3/4" (2254) 88" (2235) 39 1/16" (992)[2]		ECDS4588-2
94 5/16" (2396) 95 13/16" (2434) 92 3/4" (2356) 92" (2337) 41 1/16" (1043)[2]		ECDS4592-2

ELEVATION SYMBOL LEGEND:
M.O. = MASONRY OPENING
VALUES IN () ARE IN MILLIMETER CONVERSIONS
VALUES IN [] ARE NUMBER OF DAYLIGHT OPENINGS PER UNIT

Note: Elevations shown DO NOT have exterior trim. Subtract 1/2" (12.7) from M.O. (Masonry Opening) for Unit Sizes. Masonry Openings above include Sill Nose, see Trim Options page for Sill Nose specifications. For other Trim Options refer to the Unit Sizing, Rough Opening & Masonry Openings page.

SCALE 1/4" = 1'

SECTOR TOP UNITS - 3-WIDE

M.O. BRICKMOULD
M.O. ADAMS/FLAT CASING
ROUGH OPENING
FRAME SIZE
DAYLIGHT OPENING

79 5/8" (2022)	91 5/8" (2327)	97 5/8" (2480)	103 5/8" (2632)	115 5/8" (2937)
82 5/8" (2099)	94 5/8" (2403)	100 5/8" (2556)	106 5/8" (2708)	118 5/8" (3013)
76 7/8" (1953)	88 7/8" (2257)	94 7/8" (2410)	100 7/8" (2562)	112 7/8" (2867)
76 1/8" (1934)	88 1/8" (2238)	94 1/8" (2391)	100 1/8" (2543)	112 1/8" (2848)
18 13/16" (478)[3]	22 13/16" (579)[3]	24 13/16" (630)[3]	26 13/16" (681)[3]	30 13/16" (783)[3]

34 5/16" (872) 35 13/16" (910) 32 3/4" (832) 32" (813) 11 1/16" (281)[2]					
38 5/16" (973) 39 13/16" (1011) 36 3/4" (933) 36" (914) 13 1/16" (332)[2]					
42 5/16" (1075) 43 13/16" (1113) 40 3/4" (1035) 40" (1016) 15 1/16" (383)[2]					
46 5/16" (1176) 47 13/16" (1214) 44 3/4" (1137) 44" (1118) 17 1/16" (433)[2]					
50 5/16" (1278) 51 13/16" (1316) 48 3/4" (1238) 48" (1219) 19 1/16" (484)[2]					
54 5/16" (1380) 55 13/16" (1418) 52 3/4" (1340) 52" (1321) 21 1/16" (535)[2]					
58 5/16" (1481) 59 13/16" (1519) 56 3/4" (1441) 56" (1422) 23 1/16" (586)[2]					
62 5/16" (1583) 63 13/16" (1621) 60 3/4" (1543) 60" (1524) 25 1/16" (637)[2]					
66 5/16" (1684) 67 13/16" (1722) 64 3/4" (1645) 64" (1626) 27 1/16" (687)[2]					
70 5/16" (1786) 71 13/16" (1824) 68 3/4" (1746) 68" (1727) 29 1/16" (738)[2]					

ELEVATION SYMBOL LEGEND:
M.O. = MASONRY OPENING
VALUES IN () ARE IN MILLIMETER CONVERSIONS
VALUES IN [] ARE NUMBER OF DAYLIGHT OPENINGS PER UNIT

Note: Elevations shown DO NOT have exterior trim. Subtract 1/2" (12.7) from M.O. (Masonry Opening) for Unit Sizes. Masonry Openings above include Sill Nose, see Trim Options page for Sill Nose specifications. For other Trim Options refer to the Unit Sizing, Rough Opening & Masonry Openings page.

SCALE 1/4" = 1'

SECTOR TOP UNITS - 3-WIDE

	79 5/8" (2022)	91 5/8" (2327)	97 5/8" (2480)	103 5/8" (2632)	115 5/8" (2937)
M.O. BRICKMOLD	82 5/8" (2099)	94 5/8" (2403)	100 5/8" (2556)	106 5/8" (2708)	118 5/8" (3013)
M.O. ADAMS/FLAT CASING	76 7/8" (1953)	88 7/8" (2257)	94 7/8" (2410)	100 7/8" (2562)	112 7/8" (2867)
ROUGH OPENING	76 1/8" (1934)	88 1/8" (2238)	94 1/8" (2391)	100 1/8" (2543)	112 1/8" (2848)
FRAME SIZE	18 13/16" (478)[3]	22 13/16" (579)[3]	24 13/16" (630)[3]	26 13/16" (681)[3]	30 13/16" (783)[3]
DAYLIGHT OPENING					
74 5/16" (1888)					
75 13/16" (1926)					
72 3/4" (1848)					
72 (1829)					
31 1/16" (789)[2]					
78 5/16" (1989)					
79 13/16" (2027)					
76 3/4" (1949)					
76 (1930)					
33 1/16" (840)[2]					
82 5/16" (2091)					
83 13/16" (2129)					
80 3/4" (2051)					
80 (2032)					
35 1/16" (891)[2]					
90 5/16" (2294)					
91 13/16" (2332)					
88 3/4" (2254)					
88 (2235)					
39 1/16" (992)[2]					
94 5/16" (2396)					
95 13/16" (2434)					
92 3/4" (2356)					
92 (2337)					
41 1/16" (1043)[2]					

ELEVATION SYMBOL LEGEND:
M.O. = MASONRY OPENING
 VALUES IN () ARE IN MILLIMETER CONVERSIONS
 VALUES IN [] ARE NUMBER OF DAYLIGHT OPENINGS PER UNIT

Note: Elevations shown DO NOT have exterior trim. Subtract 1/2" (12.7) from M.O. (Masonry Opening) for Unit Sizes. Masonry Openings above include Sill Nose, see Trim Options page for Sill Nose specifications. For other Trim Options refer to the Unit Sizing, Rough Opening & Masonry Openings page.

SCALE 1/4" = 1'

SECTOR TOP UNITS - 3-WIDE

M.O. BRICKMOULD
M.O. ADAMS/FLAT CASING
ROUGH OPENING
FRAME SIZE
DAYLIGHT OPENING

127 5/8" (3242)
130 5/8" (3318)
124 7/8" (3171)
124 1/8" (3153)
34 13/16" (884)[3]

139 5/8" (3546)
142 5/8" (3623)
136 7/8" (3477)
136 1/8" (3458)
38 13/16" (986)[3]

34 5/16" (872)
35 13/16" (910)
32 3/4" (832)
32" (813)
32" (813)
38 5/16" (973)
38 5/16" (973)
39 13/16" (1011)
36 3/4" (933)
36" (914)
42 5/16" (1075)
43 13/16" (1113)
40 3/4" (1035)
40" (1016)
40" (1016)
46 5/16" (1176)
47 13/16" (1214)
44 3/4" (1137)
44" (1118)
44" (1118)
50 5/16" (1278)
51 13/16" (1316)
48 3/4" (1238)
48" (1219)
19 1/16" (484)[2]
54 5/16" (1380)
55 13/16" (1418)
52 3/4" (1340)
52" (1321)
2 11/16" (535)[2]
58 5/16" (1481)
59 13/16" (1519)
56 3/4" (1441)
56" (1422)
23 1/16" (586)[2]
62 5/16" (1583)
63 13/16" (1621)
60 3/4" (1543)
60" (1524)
25 1/16" (637)[2]
66 5/16" (1684)
67 13/16" (1722)
64 3/4" (1645)
64" (1626)
27 1/16" (687)[2]
70 5/16" (1786)
71 13/16" (1824)
68 3/4" (1746)
68" (1727)
29 1/16" (738)[2]



ECDS4132-3



ECDS4532-3



ECDS4136-3

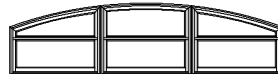

ECDS4536-3

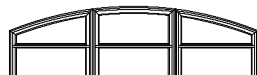

ECDS4140-3



ECDS4540-3

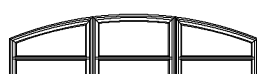

ECDS4144-3

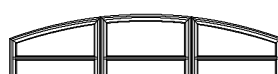

ECDS4544-3



ECDS4148-3



ECDS4548-3



ECDS4152-3



ECDS4552-3



ECDS4156-3



ECDS4556-3



ECDS4160-3



ECDS4560-3



ECDS4164-3



ECDS4564-3



ECDS4168-3



ECDS4568-3

ELEVATION SYMBOL LEGEND:
M.O. = MASONRY OPENING
VALUES IN () ARE IN MILLIMETER CONVERSIONS
VALUES IN [] ARE NUMBER OF DAYLIGHT OPENINGS PER UNIT

Note: Elevations shown DO NOT have exterior trim. Subtract 1/2" (12.7) from M.O. (Masonry Opening) for Unit Sizes. Masonry Openings above include Sill Nose, see Trim Options page for Sill Nose specifications. For other Trim Options refer to the Unit Sizing, Rough Opening & Masonry Openings page.

SCALE 1/4" = 1'

SECTOR TOP UNITS - 3-WIDE

M.O. BRICKMOULD
M.O. ADAMS/FLAT CASING
ROUGH OPENING
FRAME SIZE
DAYLIGHT OPENING

127 5/8" (3242)
130 5/8" (3318)
124 7/8" (3171)
124 1/8" (3153)
34 13/16" (884)[3]

139 5/8" (3546)
142 5/8" (3623)
136 7/8" (3477)
136 1/8" (3458)
38 13/16" (986)[3]

74 5/16" (1888)
75 13/16" (1926)
72 3/4" (1846)
72 (1829)
31 1/16" (789)[2]

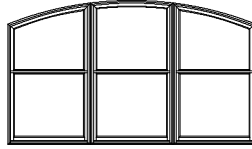

ECDS4172-3

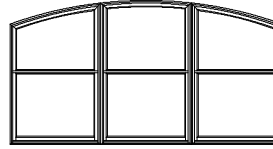

ECDS4572-3

78 5/16" (1989)
79 13/16" (2027)
76 3/4" (1949)
76 (1930)
33 7/16" (840)[2]

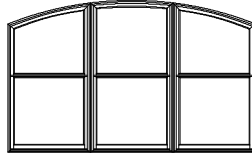

ECDS4176-3

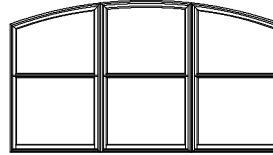

ECDS4576-3

82 5/16" (2091)
83 13/16" (2129)
80 3/4" (2051)
80 (2032)
35 1/16" (891)[2]

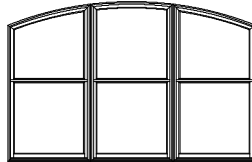

ECDS4180-3

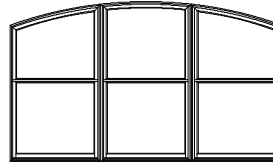

ECDS4580-3

90 5/16" (2294)
91 13/16" (2332)
88 3/4" (2254)
88 (2235)
39 1/16" (992)[2]

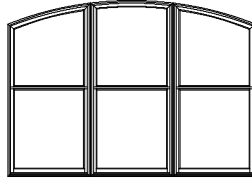

ECDS4188-3

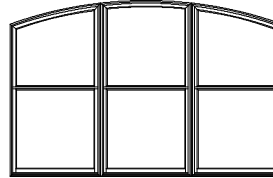

ECDS4588-3

94 5/16" (2396)
95 13/16" (2434)
92 3/4" (2356)
92 (2337)
41 1/16" (1043)[2]

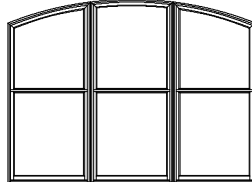

ECDS4192-3

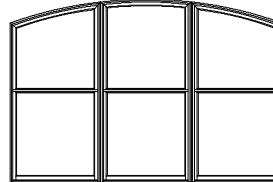

ECDS4592-3

ELEVATION SYMBOL LEGEND:

M.O. = MASONRY OPENING
VALUES IN () ARE IN MILLIMETER CONVERSIONS
VALUES IN [] ARE NUMBER OF DAYLIGHT OPENINGS PER UNIT

Note: Elevations shown DO NOT have exterior trim. Subtract 1/2" (12.7) from M.O. (Masonry Opening) for Unit Sizes. Masonry Openings above include Sill Nose, see Trim Options page for Sill Nose specifications. For other Trim Options refer to the Unit Sizing, Rough Opening & Masonry Openings page.

SCALE 1/4" = 1'

FULL RADIUS UNITS

M.O. BRICKMOULD
M.O. ADAMS/FLAT CASING
ROUGH OPENING
FRAME SIZE
DAYLIGHT OPENING

32 7/8" (835)
35 7/8" (911)
30 1/8" (765)
29 3/8" (746)
22 13/16" (579)

34 7/8" (886)
37 7/8" (962)
32 1/8" (816)
31 3/8" (797)
24 13/16" (630)

36 7/8" (937)
39 7/8" (1013)
34 1/8" (867)
33 3/8" (848)
26 13/16" (681)

40 7/8" (1038)
43 7/8" (1114)
38 1/8" (968)
37 3/8" (949)
30 13/16" (783)

44 7/8" (1140)
47 7/8" (1216)
42 1/8" (1070)
41 3/8" (1051)
34 13/16" (884)

48 7/8" (1241)
51 7/8" (1318)
46 1/8" (1172)
45 3/8" (1153)
38 13/16" (986)

54 5/16" (1380)
55 13/16" (1418)
52 3/4" (1340)
52" (1321)
21 1/16" (535) [2]

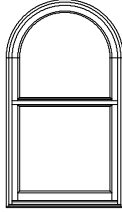

ECDH2952

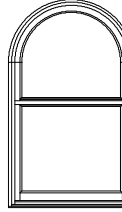

ECDH3152

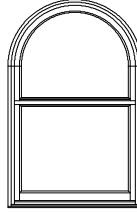

ECDH3352

58 5/16" (1481)
59 13/16" (1519)
56 3/4" (1441)
56" (1422)
23 1/16" (586) [2]

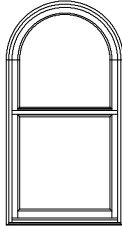

ECDH2956

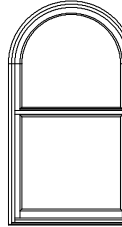

ECDH3156

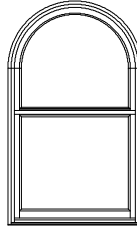

ECDH3356

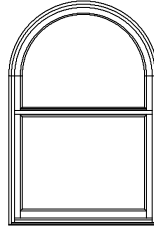

ECDH3756

62 5/16" (1583)
63 13/16" (1621)
60 3/4" (1543)
60" (1524)
25 1/16" (637) [2]

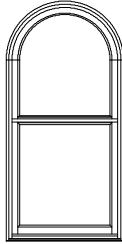

ECDH2960

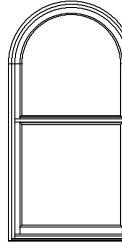

ECDH3160

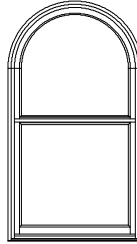

ECDH3360

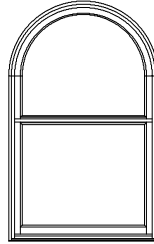

ECDH3760

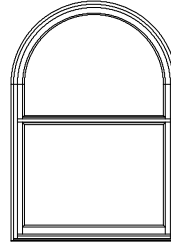

ECDH4160

66 5/16" (1684)
67 13/16" (1722)
64 3/4" (1645)
64" (1626)
27 1/16" (687) [2]

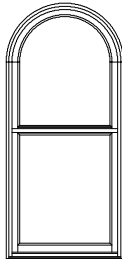

ECDH2964

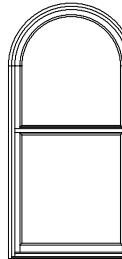

ECDH3164

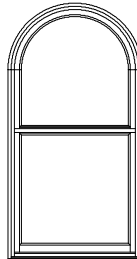

ECDH3364

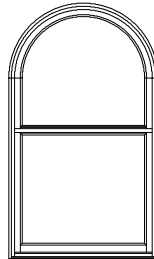

ECDH3764

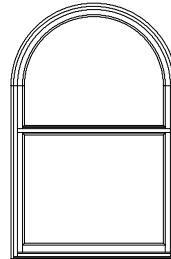

ECDH4164

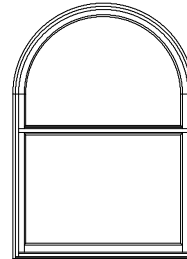

ECDH4564

70 5/16" (1786)
71 13/16" (1824)
68 3/4" (1746)
68" (1727)
29 1/16" (738) [2]

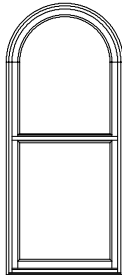

ECDH2968

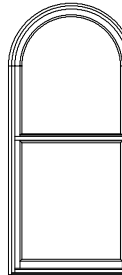

ECDH3168

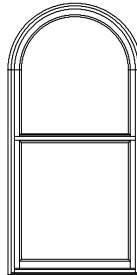

ECDH3368

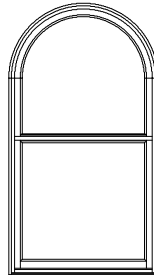

ECDH3768

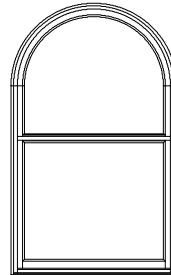

ECDH4168

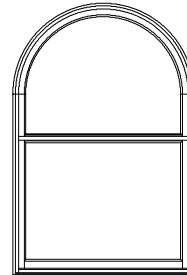

ECDH4568

ELEVATION SYMBOL LEGEND:

M.O. = MASONRY OPENING
VALUES IN () ARE IN MILLIMETER CONVERSIONS
VALUES IN [] ARE NUMBER OF DAYLIGHT OPENINGS PER UNIT

Note: Elevations shown DO NOT have exterior trim. Subtract 1/2" (12.7) from M.O. (Masonry Opening) for Unit Sizes. Masonry Openings above include Sill Nose, see Trim Options page for Sill Nose specifications. For other Trim Options refer to the Unit Sizing, Rough Opening & Masonry Openings page.

SCALE 1/4" = 1'

FULL RADIUS UNITS

M.O. BRICKMOUND
M.O. ADAMS/FLAT CASING
ROUGH OPENING
FRAME SIZE
DAYLIGHT OPENING

32 7/8" (835)	34 7/8" (886)	36 7/8" (937)	40 7/8" (1038)	44 7/8" (1140)	48 7/8" (1241)
35 7/8" (911)	37 7/8" (962)	39 7/8" (1013)	43 7/8" (1114)	47 7/8" (1216)	51 7/8" (1318)
30 1/8" (765)	32 1/8" (816)	34 1/8" (867)	38 1/8" (968)	42 1/8" (1070)	46 1/8" (1172)
29 3/8" (746)	31 3/8" (797)	33 3/8" (848)	37 3/8" (949)	41 3/8" (1051)	45 3/8" (1153)
22 13/16" (579)	24 13/16" (630)	26 13/16" (681)	30 13/16" (783)	34 13/16" (884)	38 13/16" (986)

74 5/16" (1888)
75 13/16" (1926)
72 3/4" (1848)
72" (1829)
31 1/16" (789)[2]

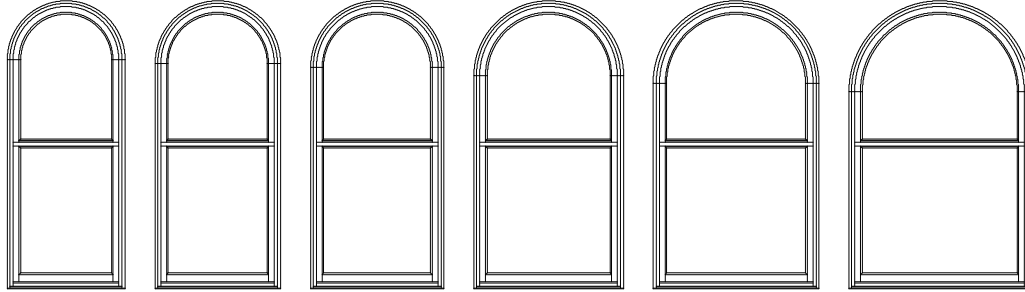

ECDH2972 ECDH3172 ECDH3372 ECDH3772 ECDH4172 ECDH4572

78 5/16" (1989)
79 13/16" (2027)
76 3/4" (1949)
76" (1930)
33 1/16" (840)[2]

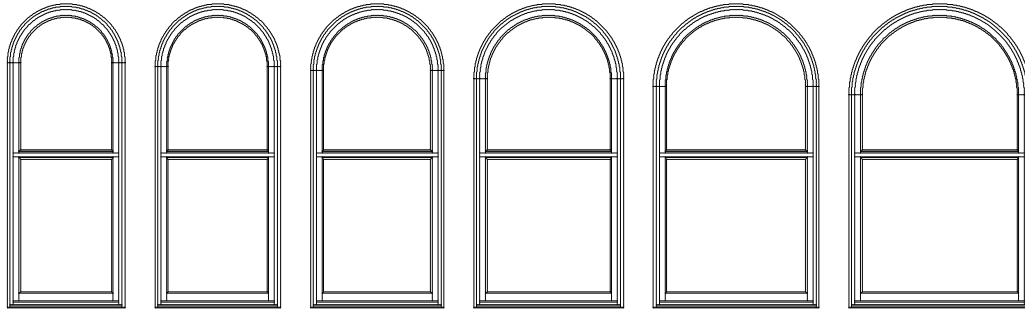

ECDH2976 ECDH3176 ECDH3376 ECDH3776 ECDH4176 ECDH4576

82 5/16" (2091)
83 13/16" (2129)
80 3/4" (2051)
80" (2032)
35 1/16" (891)[2]

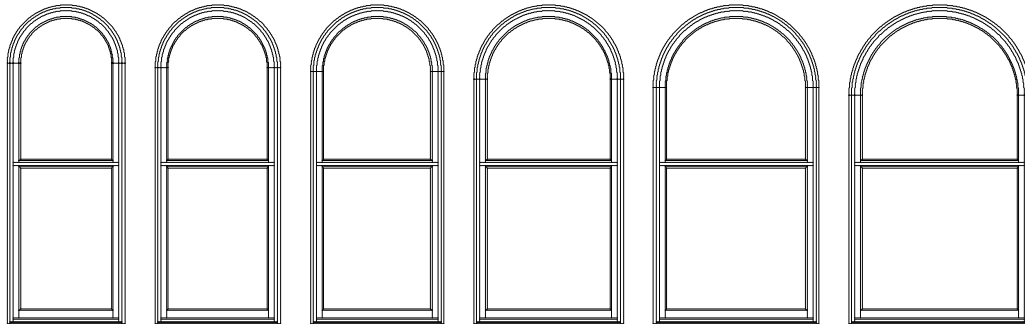

ECDH2980 ECDH3180 ECDH3380 ECDH3780 ECDH4180 ECDH4580

90 5/16" (2294)
91 13/16" (2332)
88 3/4" (2254)
88" (2235)
39 1/16" (992)[2]

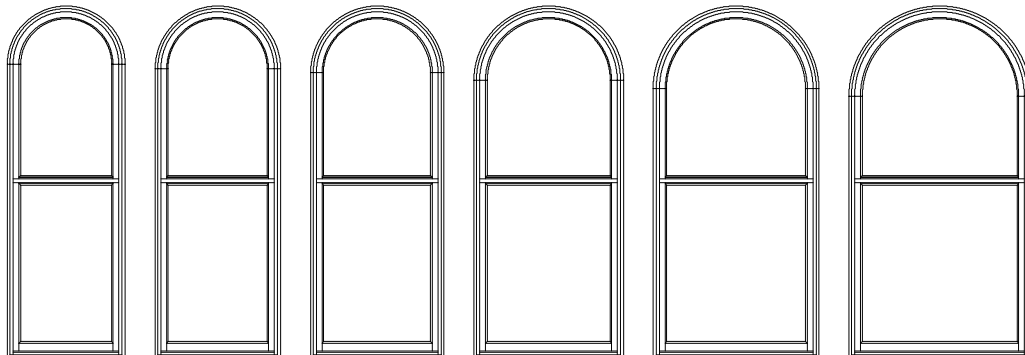

ECDH2988 ECDH3188 ECDH3388 ECDH3788 ECDH4188 ECDH4588

ELEVATION SYMBOL LEGEND:

M.O. = MASONRY OPENING
VALUES IN () ARE IN MILLIMETER CONVERSIONS
VALUES IN [] ARE NUMBER OF DAYLIGHT OPENINGS PER UNIT

Note: Elevations shown DO NOT have exterior trim. Subtract 1/2" (12.7) from M.O. (Masonry Opening) for Unit Sizes. Masonry Openings above include Sill Nose, see Trim Options page for Sill Nose specifications. For other Trim Options refer to the Unit Sizing, Rough Opening & Masonry Openings page.

SCALE 1/4" = 1'

FULL RADIUS UNITS

M.O. BRICKMOULD
M.O. ADAMS/FLAT CASING
ROUGH OPENING
FRAME SIZE
DAYLIGHT OPENING

32 7/8" (835)	34 7/8" (886)	36 7/8" (937)	40 7/8" (1038)	44 7/8" (1140)	48 7/8" (1241)
35 7/8" (911)	37 7/8" (962)	39 7/8" (1013)	43 7/8" (1114)	47 7/8" (1216)	51 7/8" (1318)
30 1/8" (765)	32 1/8" (816)	34 1/8" (867)	38 1/8" (968)	42 1/8" (1070)	46 1/8" (1172)
29 3/8" (746)	31 3/8" (797)	33 3/8" (848)	37 3/8" (949)	41 3/8" (1051)	45 3/8" (1153)
22 13/16" (579)	24 13/16" (630)	26 13/16" (681)	30 13/16" (783)	34 13/16" (884)	38 13/16" (986)

94 5/16" (2396)
95 1/16" (2434)
92 3/4" (2366)
92" (2337)
41 1/16" (1043)(2)

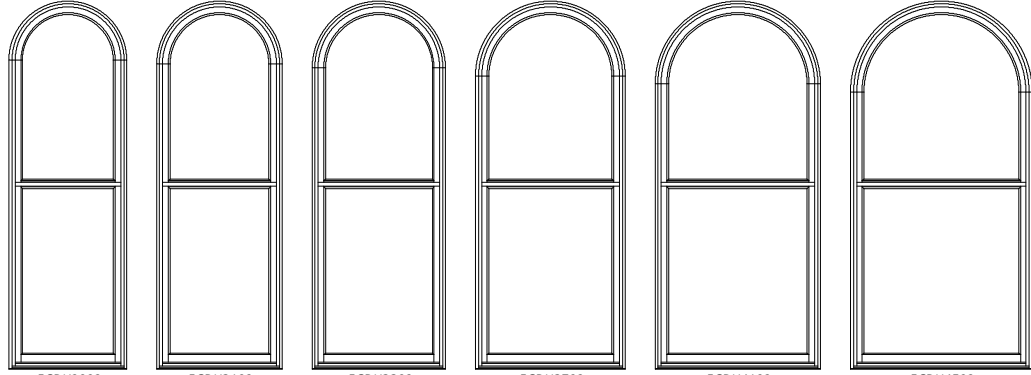

ELEVATION SYMBOL LEGEND:

M.O. = MASONRY OPENING
VALUES IN () ARE IN MILLIMETER CONVERSIONS
VALUES IN [] ARE NUMBER OF DAYLIGHT OPENINGS PER UNIT

Note: Elevations shown DO NOT have exterior trim. Subtract 1/2" (12.7) from M.O. (Masonry Opening) for Unit Sizes. Masonry Openings above include Sill Nose, see Trim Options page for Sill Nose specifications. For other Trim Options refer to the Unit Sizing, Rough Opening & Masonry Openings page.

SCALE 1/4" = 1'

FULL RADIUS PICTURE UNITS

M.O. BRICKMOULD
M.O. ADAMS/FLAT CASING
ROUGH OPENING
FRAME SIZE
DAYLIGHT OPENING

32 7/8" (835)	34 7/8" (886)	36 7/8" (937)	40 7/8" (1038)	44 7/8" (1140)	48 7/8" (1241)
35 7/8" (911)	37 7/8" (962)	39 7/8" (1013)	43 7/8" (1114)	47 7/8" (1216)	51 7/8" (1318)
30 1/8" (765)	32 1/8" (816)	34 1/8" (867)	38 1/8" (968)	42 1/8" (1070)	46 1/8" (1172)
29 3/8" (746)	31 3/8" (797)	33 3/8" (848)	37 3/8" (949)	41 3/8" (1051)	45 3/8" (1153)
22 13/16" (579)	24 13/16" (630)	26 13/16" (681)	30 13/16" (783)	34 13/16" (884)	38 13/16" (986)

54 5/16" (1380) 52 3/16" (1340) 52 3/4" (1340) 52" (1321) 44 5/16" (1126)						
58 5/16" (1481) 59 3/16" (1519) 56 3/4" (1441) 56" (1422) 48 5/16" (1227)						
62 5/16" (1583) 62 3/16" (1621) 60 3/4" (1543) 60" (1524) 52 5/16" (1329)						
66 5/16" (1684) 68 3/16" (1723) 64 3/4" (1645) 64" (1626) 56 5/16" (1430)						
70 5/16" (1786) 71 3/16" (1824) 68 3/4" (1746) 68" (1727) 60 5/16" (1532)						

ELEVATION SYMBOL LEGEND:
M.O. = MASONRY OPENING
VALUES IN () ARE IN MILLIMETER CONVERSIONS

Note: Elevations shown DO NOT have exterior trim. Subtract 1/2" (12.7) from M.O. (Masonry Opening) for Unit Sizes. Masonry Openings above include Sill Nose, see Trim Options page for Sill Nose specifications. For other Trim Options refer to the Unit Sizing, Rough Opening & Masonry Openings page.

SCALE 1/4" = 1'

FULL RADIUS PICTURE UNITS

M.O. BRICKMOULD
M.O. ADAMS/FLAT CASING
ROUGH OPENING
FRAME SIZE
DAYLIGHT OPENING

32 7/8" (835)	34 7/8" (886)	36 7/8" (937)	40 7/8" (1038)	44 7/8" (1140)	48 7/8" (1241)
35 7/8" (911)	37 7/8" (962)	39 7/8" (1013)	43 7/8" (1114)	47 7/8" (1216)	51 7/8" (1318)
30 1/8" (765)	32 1/8" (816)	34 1/8" (867)	38 1/8" (968)	42 1/8" (1070)	46 1/8" (1172)
29 3/8" (746)	31 3/8" (797)	33 3/8" (848)	37 3/8" (949)	41 3/8" (1051)	45 3/8" (1153)
22 13/16" (579)	24 13/16" (630)	26 13/16" (681)	30 13/16" (783)	34 13/16" (884)	38 13/16" (986)

74 5/16" (1888)
75 13/16" (1926)
72 3/4" (1848)
72" (1829)
64 5/16" (1634)

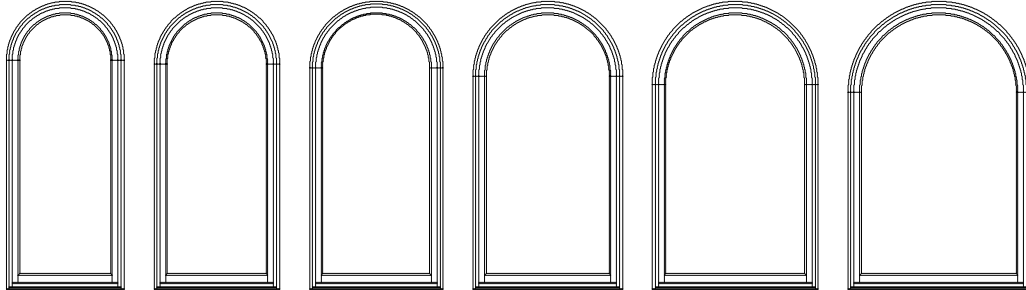

ECDHP2972 ECDHP3172 ECDHP3372 ECDHP3772 ECDHP4172 ECDHP4572

78 5/16" (1989)
79 13/16" (2027)
76 3/4" (1949)
76" (1930)
68 5/16" (1735)

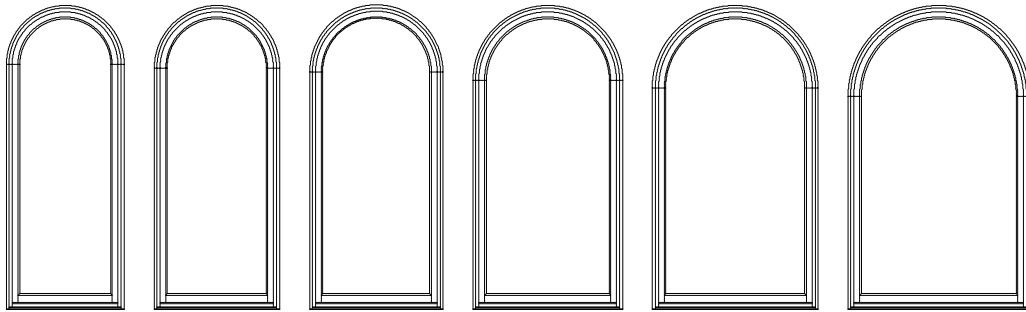

ECDHP2976 ECDHP3176 ECDHP3376 ECDHP3776 ECDHP4176 ECDHP4576

82 5/16" (2091)
83 13/16" (2129)
80 3/4" (2051)
80" (2032)
72 5/16" (1837)

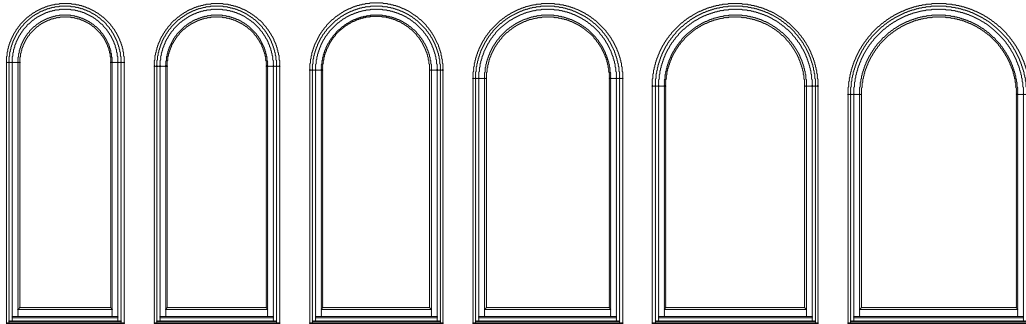

ECDHP2980 ECDHP3180 ECDHP3380 ECDHP3780 ECDHP4180 ECDHP4580

90 5/16" (2294)
91 13/16" (2332)
88 3/4" (2254)
88" (2235)
80 5/16" (2040)

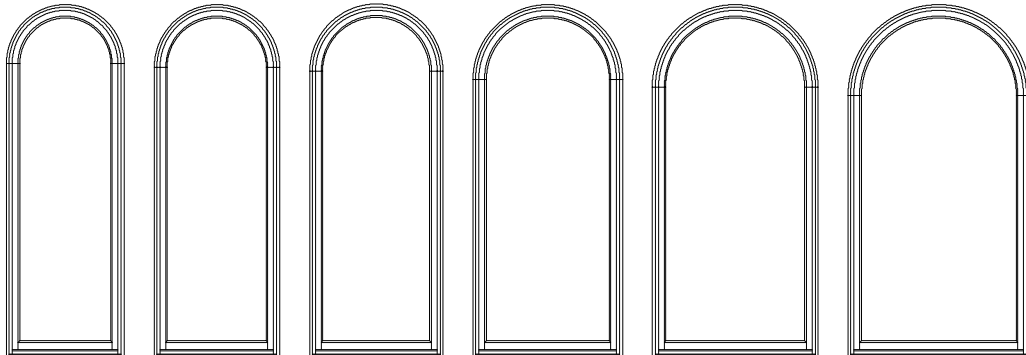

ECDHP2988 ECDHP3188 ECDHP3388 ECDHP3788 ECDHP4188 ECDHP4588

ELEVATION SYMBOL LEGEND:
M.O. = MASONRY OPENING
VALUES IN () ARE IN MILLIMETER CONVERSIONS

Note: Elevations shown DO NOT have exterior trim. Subtract 1/2" (12.7) from M.O. (Masonry Opening) for Unit Sizes. Masonry Openings above include Sill Nose, see Trim Options page for Sill Nose specifications. For other Trim Options refer to the Unit Sizing, Rough Opening & Masonry Openings page.

SCALE 1/4" = 1'

FULL RADIUS PICTURE UNITS

M.O. BRICKMOULD	32 7/8"(835)	34 7/8"(886)	36 7/8"(937)	40 7/8"(1038)	44 7/8"(1140)	48 7/8"(1241)
M.O. ADAMS/FLAT CASING	35 7/8"(911)	37 7/8"(962)	39 7/8"(1013)	43 7/8"(1114)	47 7/8"(1216)	51 7/8"(1318)
ROUGH OPENING	30 1/8"(765)	32 1/8"(816)	34 1/8"(867)	38 1/8"(968)	42 1/8"(1070)	46 1/8"(1172)
FRAME SIZE	29 3/8"(746)	31 3/8"(797)	33 3/8"(848)	37 3/8"(949)	41 3/8"(1051)	45 3/8"(1153)
DAYLIGHT OPENING	22 13/16"(579)	24 13/16"(630)	26 13/16"(681)	30 13/16"(783)	34 13/16"(884)	38 13/16"(986)

94 5/16"(2396)
95 13/16"(2434)
92 3/4"(2356)
92"(2337)
84 5/16"(2142)

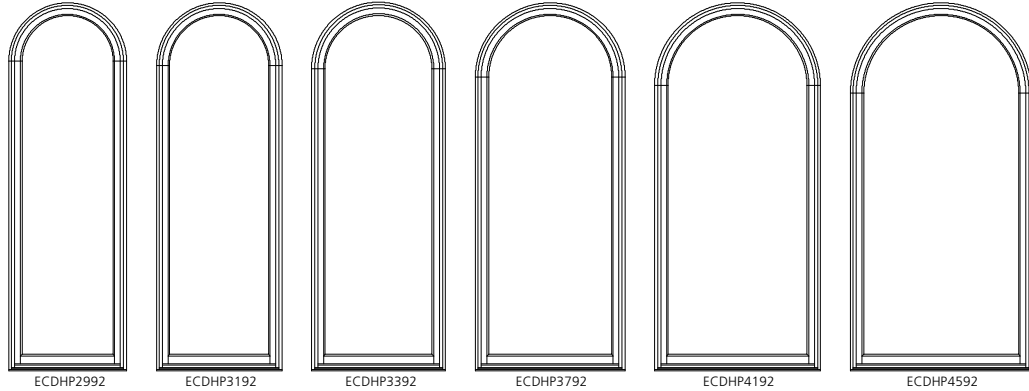

ELEVATION SYMBOL LEGEND:
M.O. = MASONRY OPENING
VALUES IN () ARE IN MILLIMETER CONVERSIONS

Note: Elevations shown DO NOT have exterior trim. Subtract 1/2" (12.7) from M.O. (Masonry Opening) for Unit Sizes. Masonry Openings above include Sill Nose, see Trim Options page for Sill Nose specifications. For other Trim Options refer to the Unit Sizing, Rough Opening & Masonry Openings page.

SCALE 1/4" = 1'

FULL RADIUS PICTURE UNITS

M.O. BRICKMOULD
M.O. ADAMS/FLAT CASING
ROUGH OPENING
FRAME SIZE
DAYLIGHT OPENING

52 7/8" (1343)
55 7/8" (1419)
50 1/8" (1273)
49 3/8" (1254)
42 13/16" (1087)

56 7/8" (1445)
59 7/8" (1581)
54 1/8" (1375)
53 3/8" (1356)
46 13/16" (1189)

64 7/8" (1648)
67 7/8" (1724)
62 1/8" (1578)
61 3/8" (1559)
54 13/16" (1392)

72 7/8" (1851)
75 7/8" (1927)
70 1/8" (1781)
69 3/8" (1762)
62 13/16" (1595)

54 5/16" (1380)
55 13/16" (1418)
52 3/4" (1340)
52 (1321)
44 5/16" (1126)

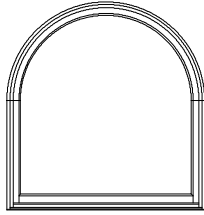

ECDHP4952

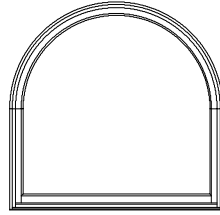

ECDHP5352

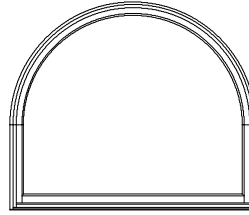

ECDHP6152

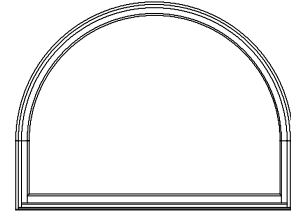

ECDHP6952

58 5/16" (1481)
59 13/16" (1519)
56 3/4" (1441)
56 (1422)
48 5/16" (1227)

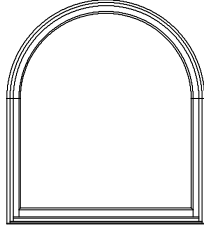

ECDHP4956

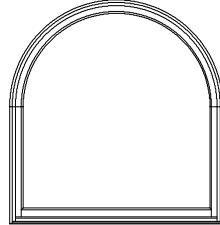

ECDHP5356

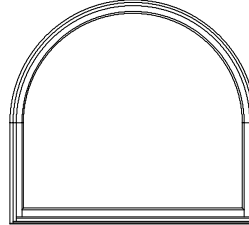

ECDHP6156

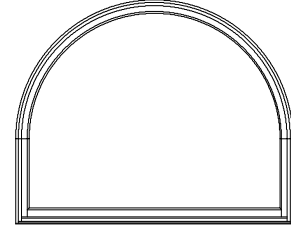

ECDHP6956

62 5/16" (1583)
63 13/16" (1621)
60 3/4" (1543)
60 (1524)
52 5/16" (1329)

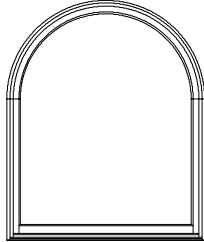

ECDHP4960

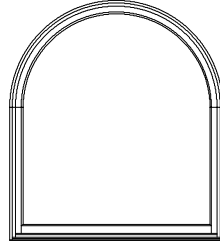

ECDHP5360

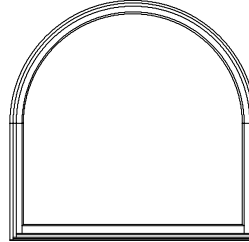

ECDHP6160

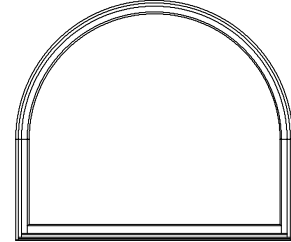

ECDHP6960

66 5/16" (1684)
69 13/16" (1773)
64 3/4" (1645)
64 (1626)
56 5/16" (1430)

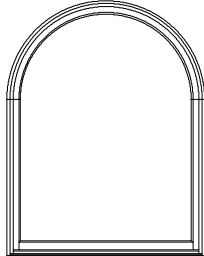

ECDHP4964

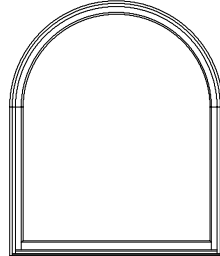

ECDHP5364

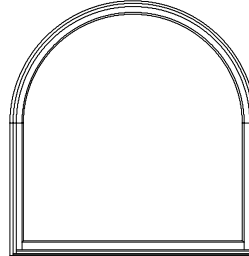

ECDHP6164

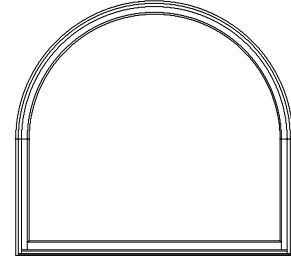

ECDHP6964

70 5/16" (1786)
71 13/16" (1824)
68 3/4" (1746)
68 (1727)
60 5/16" (1532)

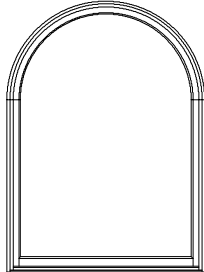

ECDHP4968

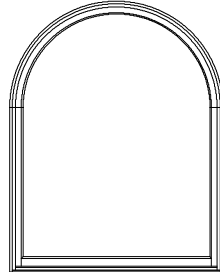

ECDHP5368

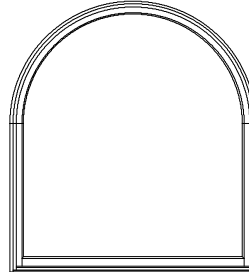

ECDHP6168

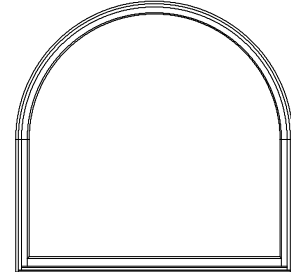

ECDHP6968

74 5/16" (1888)
75 13/16" (1926)
72 3/4" (1848)
72 (1829)
64 5/16" (1634)

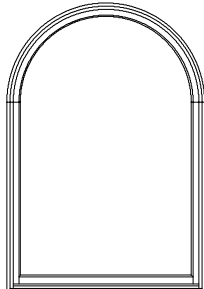

ECDHP4972

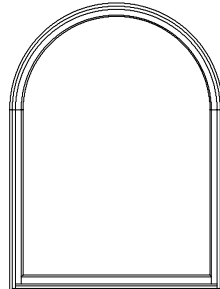

ECDHP5372

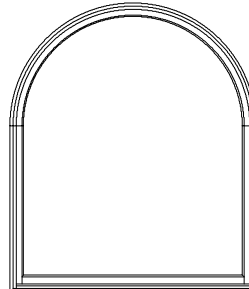

ECDHP6172

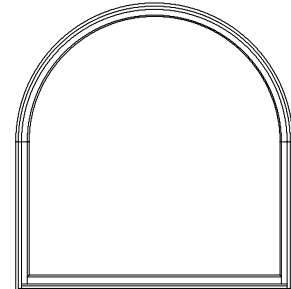

ECDHP6972

SCALE 1/4" = 1'

FULL RADIUS PICTURE UNITS

M.O. BRICKMOULD
M.O. ADAMS/FLAT CASING
ROUGH OPENING
FRAME SIZE
DAYLIGHT OPENING

52 7/8" (1343)
55 7/8" (1419)
50 1/8" (1273)
49 3/8" (1254)
42 13/16" (1087)

56 7/8" (1445)
59 7/8" (1531)
54 1/8" (1375)
53 3/8" (1356)
46 13/16" (1189)

64 7/8" (1648)
67 7/8" (1724)
62 1/8" (1578)
61 3/8" (1559)
54 13/16" (1392)

72 7/8" (1851)
75 7/8" (1927)
70 1/8" (1781)
69 3/8" (1762)
62 13/16" (1595)

78 5/16" (1989)
79 13/16" (2027)
76 3/4" (1949)
76" (1930)
68 5/16" (1735)

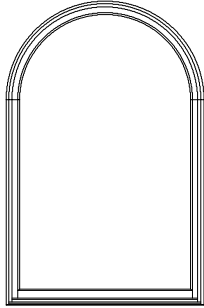

ECDHP4976

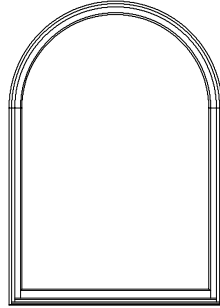

ECDHP5376

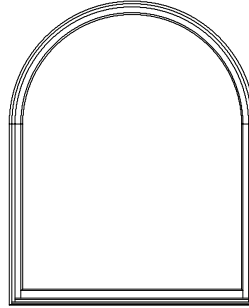

ECDHP6176

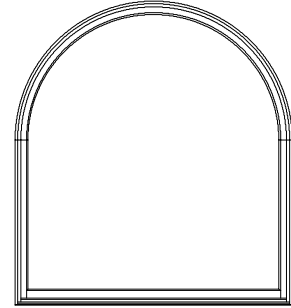

ECDHP6976

82 5/16" (2091)
83 13/16" (2129)
80 3/4" (2051)
80" (2032)
72 5/16" (1837)

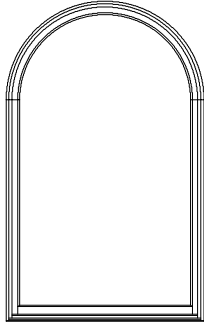

ECDHP4980

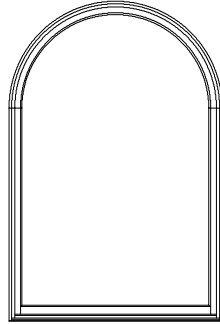

ECDHP5380

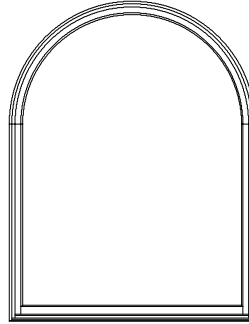

ECDHP6180

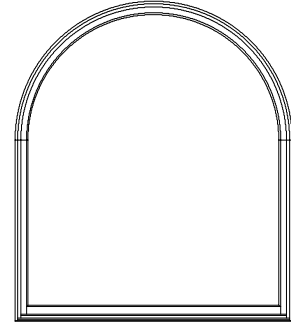

ECDHP6980

90 5/16" (2294)
91 13/16" (2332)
88 3/4" (2254)
88" (2235)
80 5/16" (2040)

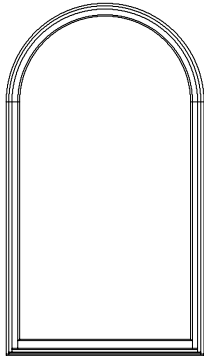

ECDHP4988

94 5/16" (2396)
95 13/16" (2434)
92 3/4" (2356)
92" (2337)
84 5/16" (2142)

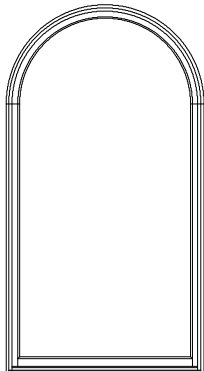

ECDHP4992

ELEVATION SYMBOL LEGEND:
M.O. = MASONRY OPENING

VALUES IN () ARE IN MILLIMETER CONVERSIONS

Note: Elevations shown DO NOT have exterior trim. Subtract 1/2" (12.7) from M.O. (Masonry Opening) for Unit Sizes. Masonry Openings above include Sill Nose, see Trim Options page for Sill Nose specifications. For other Trim Options refer to the Unit Sizing, Rough Opening & Masonry Openings page.

SCALE 1/4" = 1'

FULL RADIUS PICTURE UNITS

M.O. BRICKMOULD
M.O. ADAMS/FLAT CASING
ROUGH OPENING
FRAME SIZE
DAYLIGHT OPENING

80 7/8" (2054)
83 7/8" (2130)
78 1/8" (1984)
77 3/8" (1965)
70 13/16" (1799)

54 5/16" (1380)
55 13/16" (1418)
52 3/4" (1340)
52" (1321)
44 5/16" (1126)

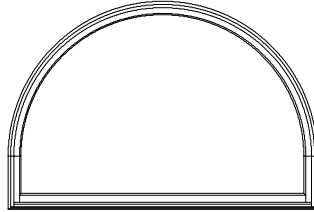

ECDHP7752

58 5/16" (1481)
59 13/16" (1519)
56 3/4" (1441)
56" (1422)
48 5/16" (1227)

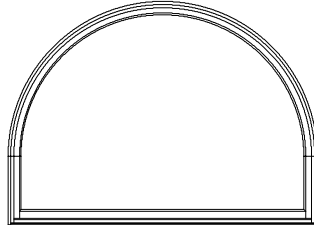

ECDHP7756

62 5/16" (1583)
63 13/16" (1621)
60 3/4" (1543)
60" (1524)
52 5/16" (1329)

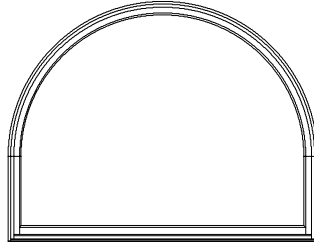

ECDHP7760

66 5/16" (1684)
69 13/16" (1773)
64 3/4" (1645)
64" (1626)
56 5/16" (1430)

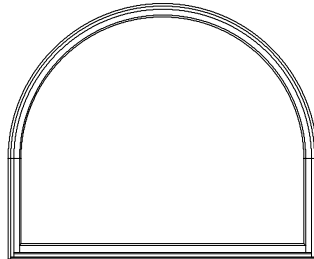

ECDHP7764

70 5/16" (1786)
71 13/16" (1824)
68 3/4" (1746)
68" (1727)
60 5/16" (1532)

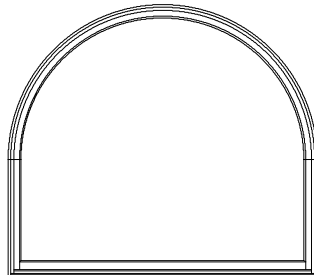

ECDHP7768

M.O. BRICKMOULD
M.O. ADAMS/FLAT CASING
ROUGH OPENING
FRAME SIZE
DAYLIGHT OPENING

80 7/8" (2054)
83 7/8" (2130)
78 1/8" (1984)
77 3/8" (1965)
70 13/16" (1799)

74 5/16" (1888)
75 13/16" (1926)
72 3/4" (1848)
72" (1829)
64 5/16" (1634)

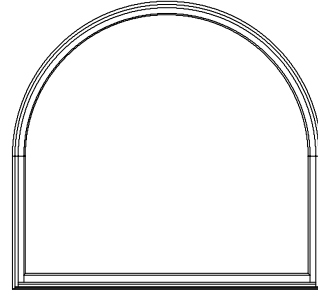

ECDHP7772

78 5/16" (1989)
79 13/16" (2027)
76 3/4" (1949)
76" (1930)
68 5/16" (1735)

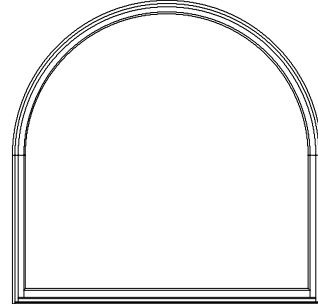

ECDHP7776

82 5/16" (2091)
83 13/16" (2129)
80 3/4" (2051)
80" (2032)
72 5/16" (1837)

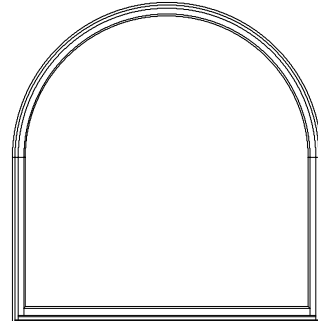

ECDHP7780

ELEVATION SYMBOL LEGEND:

M.O. = MASONRY OPENING
VALUES IN () ARE IN MILLIMETER CONVERSIONS

Note: Elevations shown DO NOT have exterior trim. Subtract 1/2" (12.7) from M.O. (Masonry Opening) for Unit Sizes. Masonry Openings above include Sill Nose, see Trim Options page for Sill Nose specifications. For other Trim Options refer to the Unit Sizing, Rough Opening & Masonry Openings page.

SCALE 1/4" = 1'

ELEVATION NOTES
DOUBLE-HUNG TRANSOM

ELEVATION DRAWINGS UTILIZE A LIMITED NUMBER OF PROJECTED LINES TO PRODUCE A RUDIMENTARY DRAWING INTENDED TO BE USED IN A SMALL GRAPHICAL SCALE. ELEVATIONS ARE VIEWED PERPENDICULAR FROM THE EXTERIOR OF THE STRUCTURE. IF MORE DIMENSIONS ARE NEEDED, USE THE SECTION DRAWINGS FOR MORE COMPLETE DEPICTIONS.

M.O. Brickmould	24 7/8" (632)	Masonry Openings for Brickmould, Flat & Adams Casing. Vertical measurements include sillnose. (Subtract 1/2" from Masonry Opening for Unit Size)
M.O. Adams/Flat Casing	27 7/8" (708)	
Rough Opening	22 1/8" (562)	
Frame Size	21 3/8" (543)	
Daylight Opening	14 13/16" (376)	

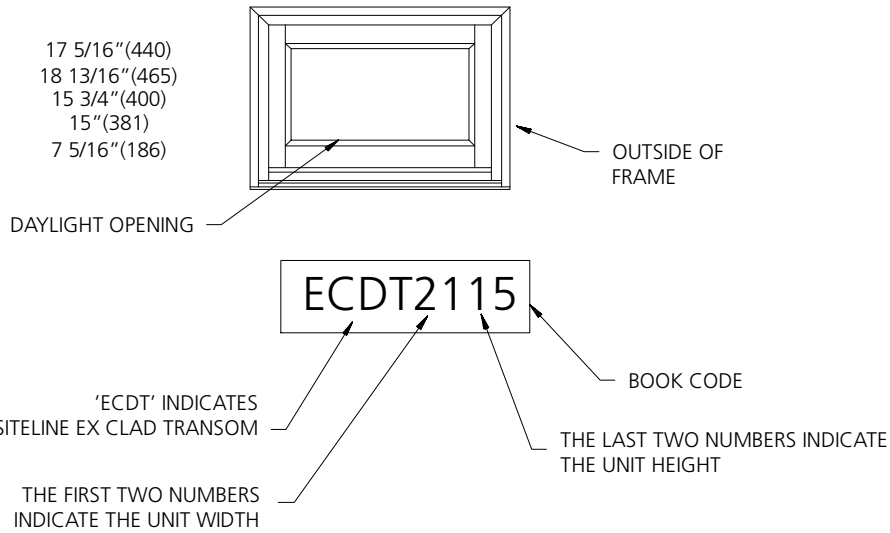











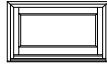









GENERAL DOUBLE-HUNG TRANSOM NOTES









1. ALL UNITS SHOWN ARE AVAILABLE AS STATIONARY ONLY.
2. UNIT ELEVATIONS ARE SHOWN WITHOUT EXTERIOR TRIM.
3. DIMENSIONAL VALUES IN PARENTHESES ARE MILLIMETER CONVERSIONS.



ELEVATION SYMBOL LEGEND:

MO MASONRY OPENING

TRANSOM UNITS

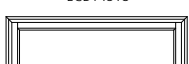
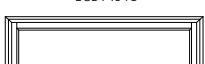
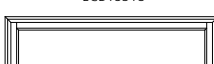
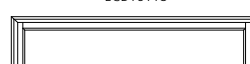
M.O. BRICKMOULD	24 7/8"(632)	28 7/8"(733)	32 7/8"(835)	34 7/8"(886)	36 7/8"(937)	40 7/8"(1038)	44 7/8"(1140)
M.O. ADAMS/FLAT CASING	27 7/8"(708)	31 7/8"(810)	35 7/8"(911)	37 7/8"(962)	39 7/8"(1013)	43 7/8"(1114)	47 7/8"(1216)
ROUGH OPENING	22 1/8"(562)	26 1/8"(664)	30 1/8"(765)	32 1/8"(816)	34 1/8"(867)	38 1/8"(968)	42 1/8"(1070)
FRAME SIZE	21 3/8"(543)	25 3/8"(645)	29 3/8"(746)	31 3/8"(797)	33 3/8"(848)	37 3/8"(949)	41 3/8"(1051)
DAYLIGHT OPENING	14 13/16"(376)	18 13/16"(478)	22 13/16"(579)	24 13/16"(630)	26 13/16"(681)	30 13/16"(783)	34 13/16"(884)
17 5/16"(440)							
18 13/16"(478)							
15 3/4"(400)							
15"(381)							
7 5/16"(186)							
20 5/16"(515)							
21 13/16"(554)							
18 3/4"(476)							
18"(457)							
10 5/16"(262)							
26 5/16"(668)							
27 13/16"(706)							
24 3/4"(629)							
24"(610)							
16 5/16"(414)							

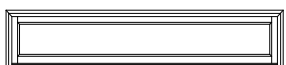
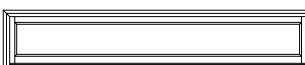
M.O. BRICKMOULD	48 7/8"(1241)	52 7/8"(1343)	56 7/8"(1445)	64 7/8"(1648)
M.O. ADAMS/FLAT CASING	51 7/8"(1318)	55 7/8"(1419)	59 7/8"(1581)	67 7/8"(1724)
ROUGH OPENING	46 1/8"(1172)	50 1/8"(1273)	54 1/8"(1375)	62 1/8"(1578)
FRAME SIZE	45 3/8"(1153)	49 3/8"(1254)	53 3/8"(1356)	61 3/8"(1559)
DAYLIGHT OPENING	38 13/16"(986)	42 13/16"(1087)	46 13/16"(1189)	54 13/16"(1392)
17 5/16"(440)				
18 13/16"(478)				
15 3/4"(400)				
15"(381)				
7 5/16"(186)				
20 5/16"(515)				
21 13/16"(554)				
18 3/4"(476)				
18"(457)				
10 5/16"(262)				
26 5/16"(668)				
27 13/16"(706)				
24 3/4"(629)				
24"(610)				
16 5/16"(414)				

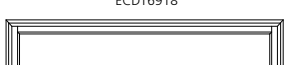
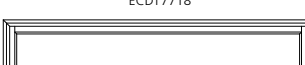
M.O. BRICKMOULD	72 7/8"(1851)	80 7/8"(2054)
M.O. ADAMS/FLAT CASING	75 7/8"(1927)	83 7/8"(2130)
ROUGH OPENING	70 1/8"(1781)	78 1/8"(1984)
FRAME SIZE	69 3/8"(1762)	77 3/8"(1965)
DAYLIGHT OPENING	62 13/16"(1595)	70 13/16"(1799)
17 5/16"(440)		
18 13/16"(478)		
15 3/4"(400)		
15"(381)		
7 5/16"(186)		
20 5/16"(515)		
21 13/16"(554)		
18 3/4"(476)		
18"(457)		
10 5/16"(262)		
26 5/16"(668)		
27 13/16"(706)		
24 3/4"(629)		
24"(610)		
16 5/16"(414)		

ELEVATION SYMBOL LEGEND:
M.O. = MASONRY OPENING
VALUES IN () ARE IN MILLIMETER CONVERSIONS

Note: Elevations shown DO NOT have exterior trim. Subtract 1/2" (12.7) from M.O. (Masonry Opening) for Unit Sizes. Masonry Openings above include Sill Nose, see Trim Options page for Sill Nose specifications. For other Trim Options refer to the Unit Sizing, Rough Opening & Masonry Openings page.

SCALE 1/4" = 1'

SASH GLAZING OPTIONS

INTERIOR GLAZING OPTIONS

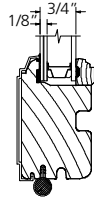

DOUBLE-HUNG
3.5L/SS

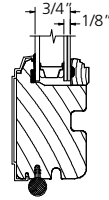

DOUBLE-HUNG
SS/3.5L

**TRIM & SILL OPTIONS
DOUBLE-HUNG**

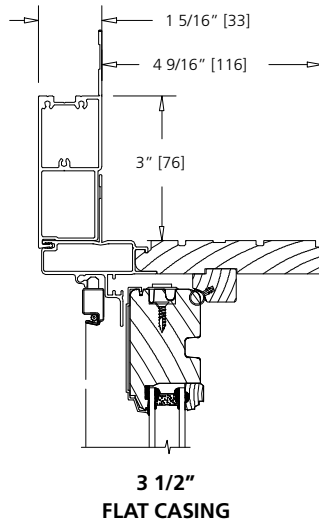
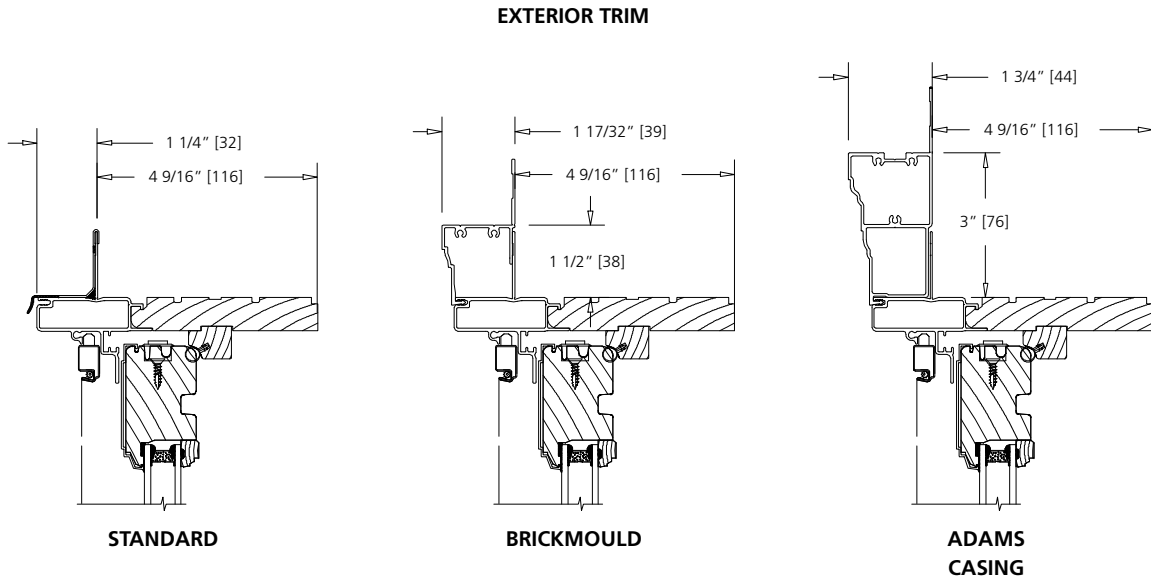

SILL OPTIONS

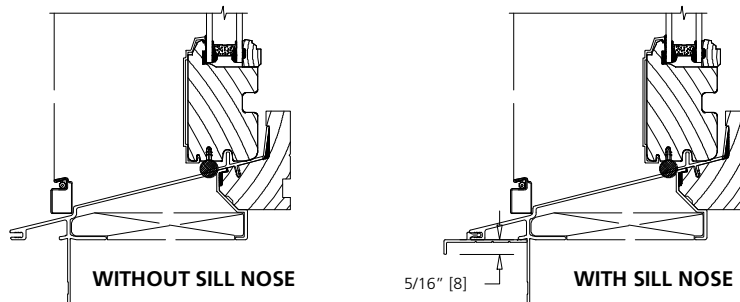

SCALE: 3" = 1'

**TRIM OPTIONS
SECTOR TOP SINGLE-HUNG**

EXTERIOR TRIM

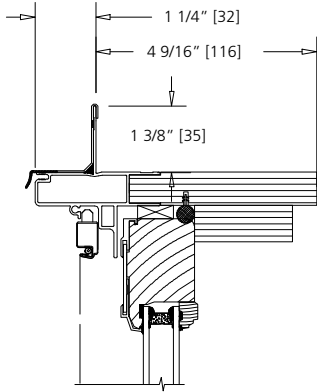

STANDARD

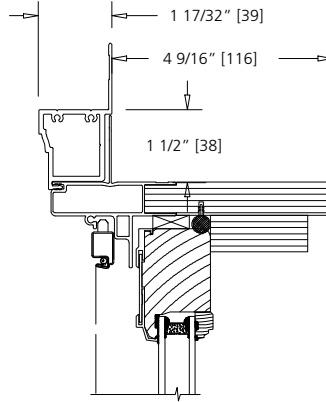

BRICKMOULD

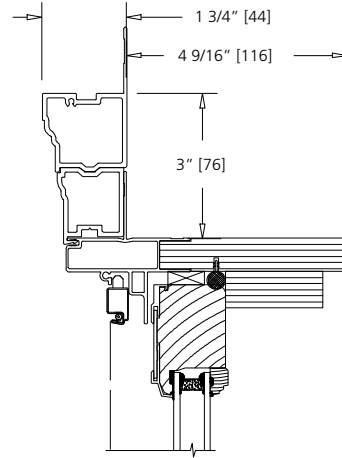

**ADAMS
CASING**

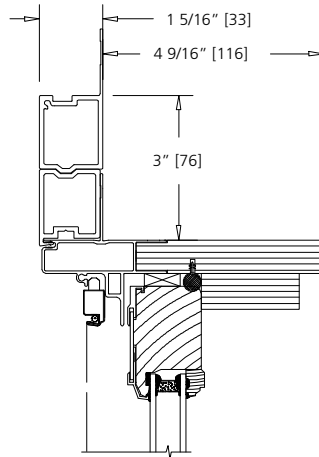

**3 1/2\"/>
FLAT CASING**

SILL OPTIONS

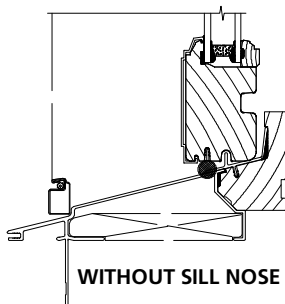

WITHOUT SILL NOSE

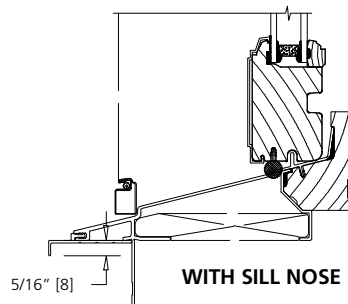

WITH SILL NOSE

SCALE: 3" = 1'

JAMB EXTENDER & STOOL OPTIONS

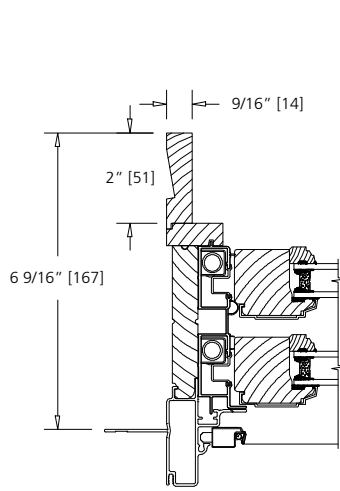

6 9/16" WALL
9/16" JAMB THICKNESS (OPTION)

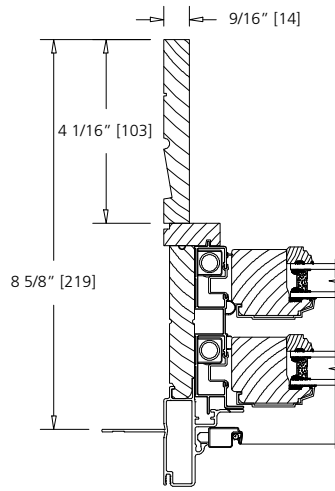

8 5/8" WALL

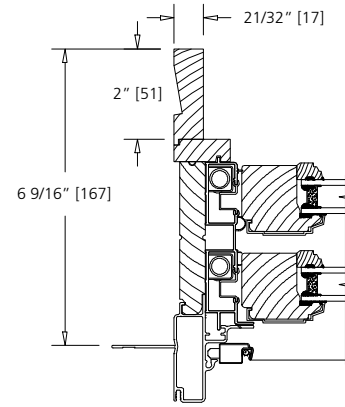

6 9/16" WALL
4/4 JAMB THICKNESS (STANDARD)

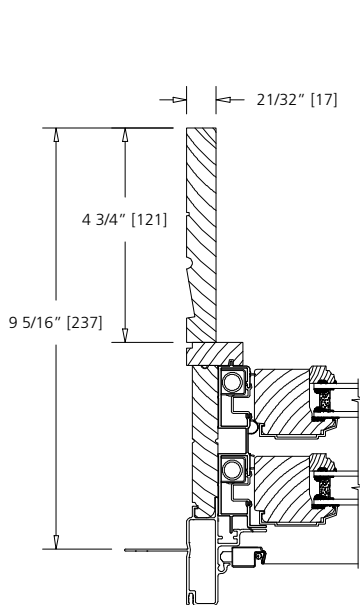

9 5/16" WALL
MAX 1-PC JAMB EXTENDER

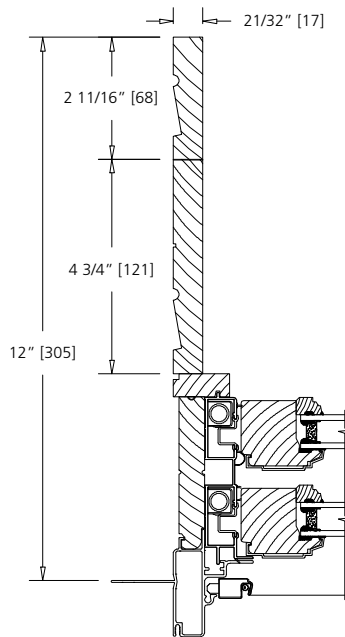

12" WALL
4/4 JAMB THICKNESS (STANDARD)
2 PC JAMB EXTENSION SHOWN

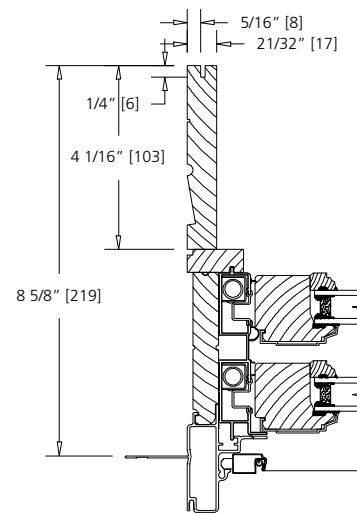

8 5/8" WALL
4/4 JAMB THICKNESS (STANDARD)
KERFED EXTENSION SHOWN

Notes:

Double-Hung units to have standard (4/4 thick) extension option.
Double-Hung units to have 9/16" thickness option & 4/4 kerfed option.

SCALE: 3" = 1'

STANDARD MULLION OPTIONS

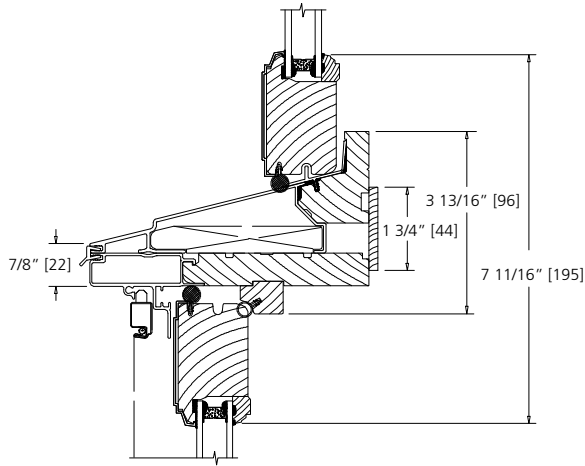

**OPERATING DOUBLE-HUNG
WITH FIXED TRANSOM**

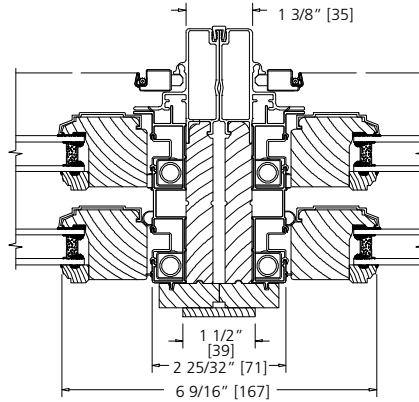

TWIN OPERATING DOUBLE-HUNG

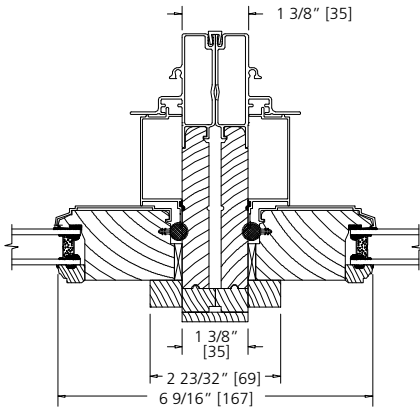

**DOUBLE-HUNG PICTURE
WITH DOUBLE-HUNG PICTURE**

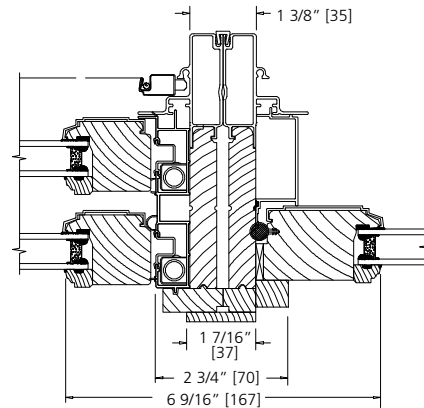

**TWIN OPERATING DOUBLE-HUNG
WITH PICTURE FLANKERS**

STANDARD MULLION OPTIONS

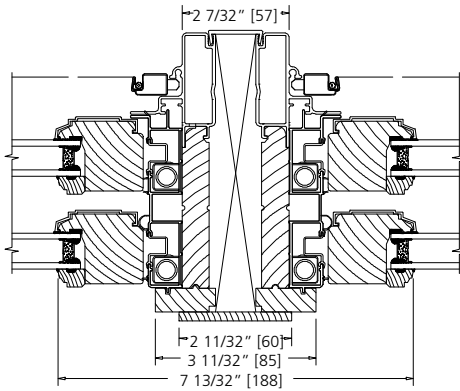

**TWIN OPERATING DOUBLE-HUNG
WITH 1" SOLID SPREAD MULLION**

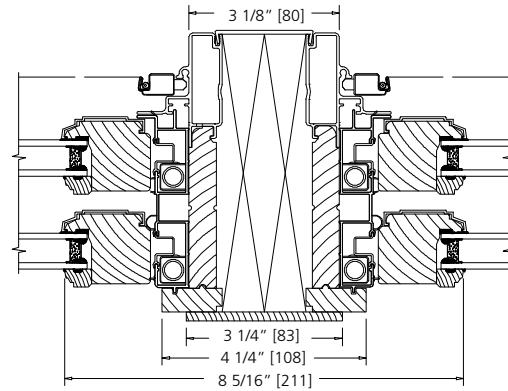

**TWIN OPERATING DOUBLE-HUNG
WITH 2" SOLID SPREAD MULLION**

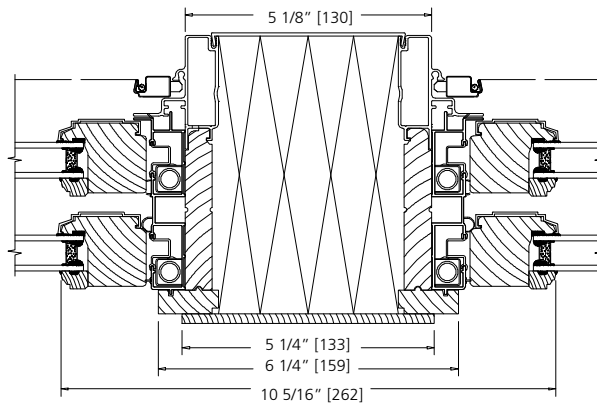

**TWIN OPERATING DOUBLE-HUNG
WITH 4" SOLID SPREAD MULLION**

LITE CUT INFORMATION

Clad double-hung windows are available in 7/8", 1-1/8" and 1-3/8" widths for SDL (Simulated Divided Lites); 5/8" Flat, 23/32" and 1" Contour GBG (Grilles between the Glass); and 7/8", 1-1/8" and 1-3/8" Full Surround removable grilles. Standard lite cuts are rectangular.

LITE CUT OPTIONS

Special lite cut patterns can include a wide variety of straight line and radius patterns. The illustrations shown here represent just a few of the possibilities. Rectangular, horizontal, vertical and Prairie lite patterns are available in all standard size clad double-hung windows. Uneven, diamond, radius and Gothic lite cuts are available, subject to approval. Approvals are based on the ability to fulfill the design requirement while maintaining the construction integrity of the finished product.

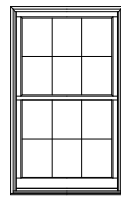

RECTANGULAR

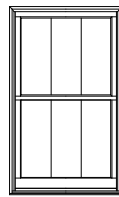

VERTICAL

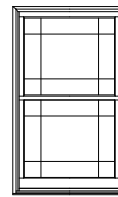

PRAIRIE

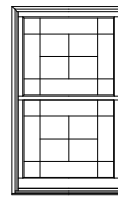

UNEVEN

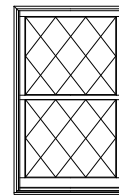

DIAMOND

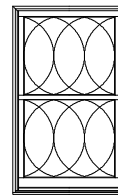

RADIUS

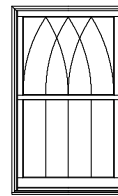

GOTHIC

BAR ALIGNMENT

Alignment of divided lite muntin bars from one window to the next is often required by fine architectural design. Wood grilles, GBG (Grilles between the Glass), and Simulated Divided lites may be specified with muntin bars aligned.

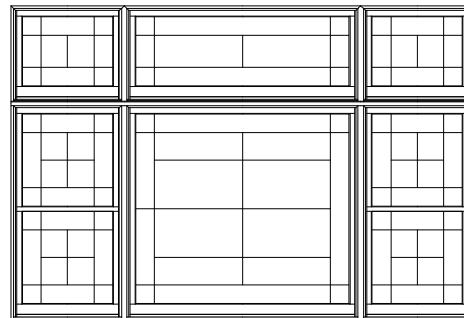

DIVIDED LITE OPTIONS

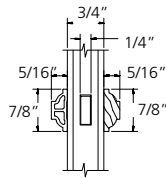

7/8" SDL

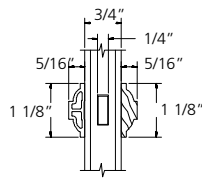

1 1/8" SDL

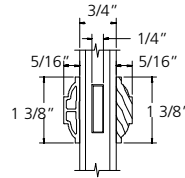

1 3/8" SDL

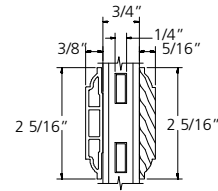

2 5/16" SDL

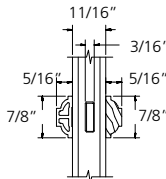

7/8" SDL

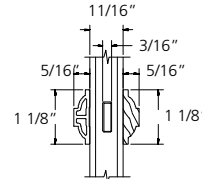

1 1/8" SDL

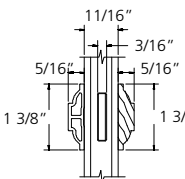

1 3/8" SDL

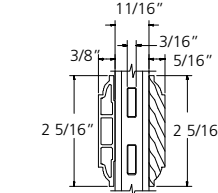

2 5/16" SDL

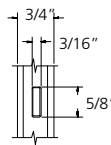

5/8" GRILLE

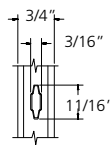

23/32" GRILLE

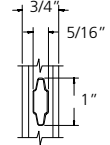

1" GRILLE

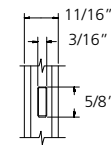

5/8" GRILLE

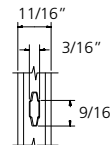

23/32" GRILLE

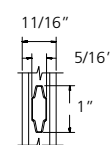

1" GRILLE

GRILLES MEETING

NFRC 3mm RULE

GRILLE PROFILES:

3/16" x 5/8"	ALLMETAL 1021101018XX140
3/16" x 1"	ALLMETAL 1020101018XX164
1/4" x 5/8"	ALLMETAL 1020102018XX140
1/4" x 1"	ALLMETAL 1020102018XX164
5.5mm x 18mm CONTOUR	ALLMETAL 1020301010XX255
8mm x 25mm CONTOUR	ALLMETAL 1020301018XX380

Note: All glass and airspace dimensions per current cardinal glass specs. Lites with shapes, angles or radii outside the Liscac Bender capabilities for stainless steel warm edge spacer will have aluminum box spacer with the same airspace dimension shown here.

SCALE 3" = 1'

**UNIT SIZING, ROUGH OPENINGS
& MASONRY OPENINGS
DOUBLE-HUNG**

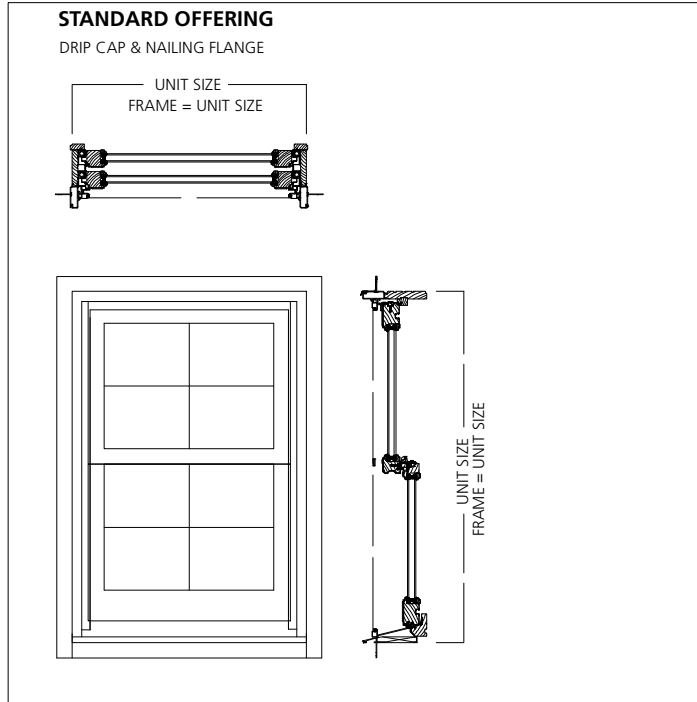

GENERAL NOTES:

UNITS WITH NO TRIM AND SILL NOSE:
UNIT SIZE = FRAME SIZE

UNIT SIZE IS ALWAYS THE
EXTREME SIZE OF THE WINDOW
WITH OR WITHOUT TRIM
(DRIP CAP & NAILING FLANGE ARE
NOT ADDED TO ANY UNIT SIZING)

MASONRY OPENING:
MASONRY OPENING IS ALWAYS 1/2" OVER
THE UNIT SIZE OF THE WINDOW

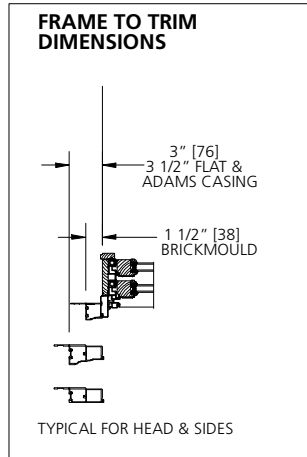
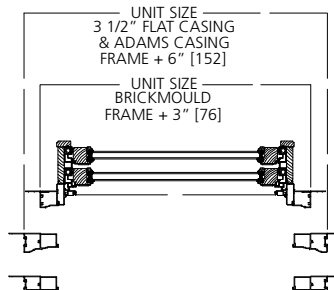
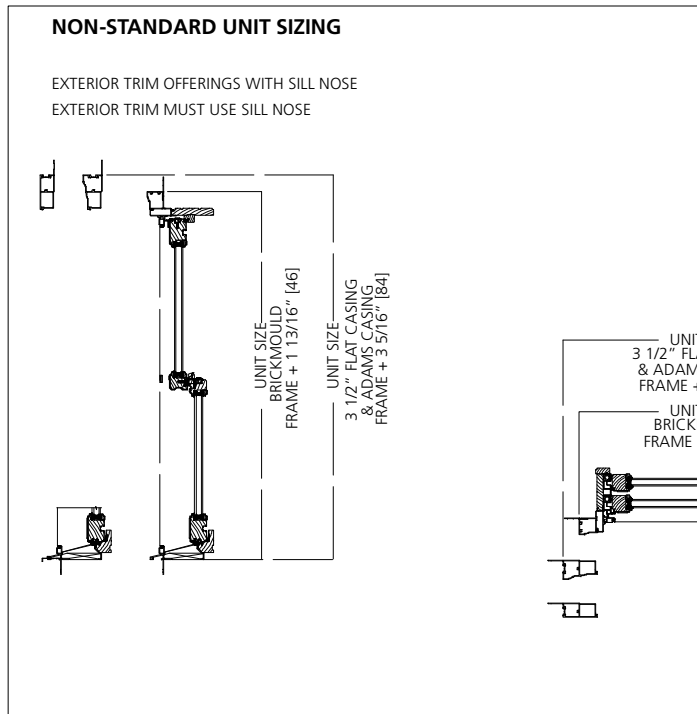
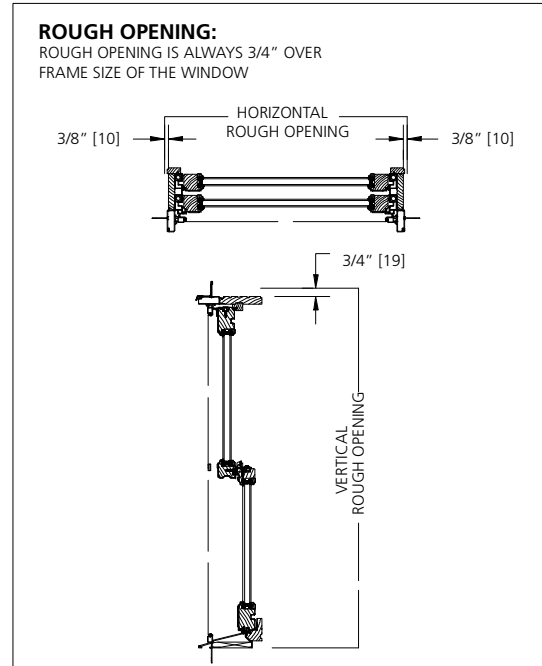

**UNIT SIZING, ROUGH OPENINGS
& MASONRY OPENINGS
SECTOR TOP SINGLE-HUNG**

**STANDARD OFFERING
DRIP CAP & NAILING FLANGE**

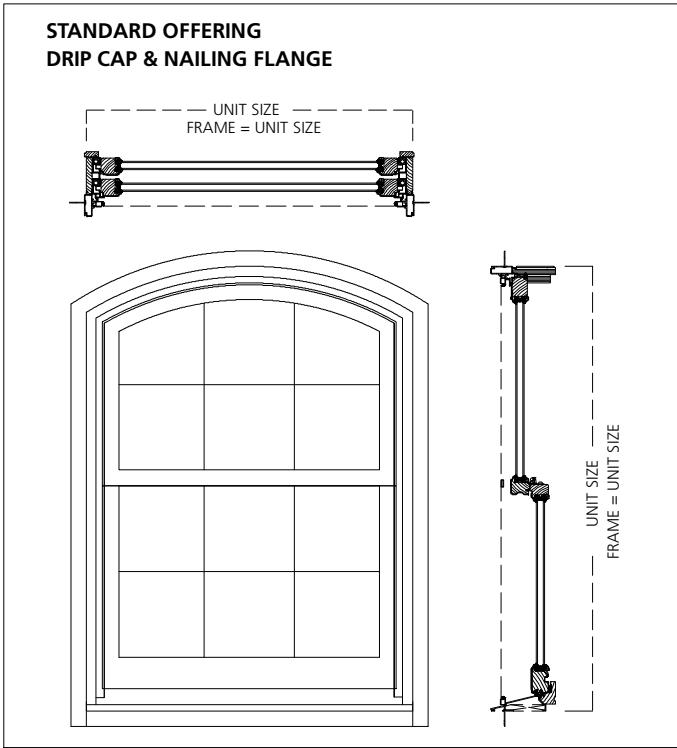

GENERAL NOTES:

UNITS WITH NO TRIM AND SILL NOSE:
UNIT SIZE = FRAME SIZE

UNIT SIZE IS ALWAYS THE
EXTREME SIZE OF THE WINDOW
WITH OR WITHOUT TRIM
(DRIP CAP & NAILING FLANGE ARE
NOT ADDED TO ANY UNIT SIZING)

MASONRY OPENING:
MASONRY OPENING IS ALWAYS 1/2" OVER
THE UNIT SIZE OF THE WINDOW

ROUGH OPENING:

ROUGH OPENING IS ALWAYS 3/4" OVER
FRAME SIZE OF THE WINDOW

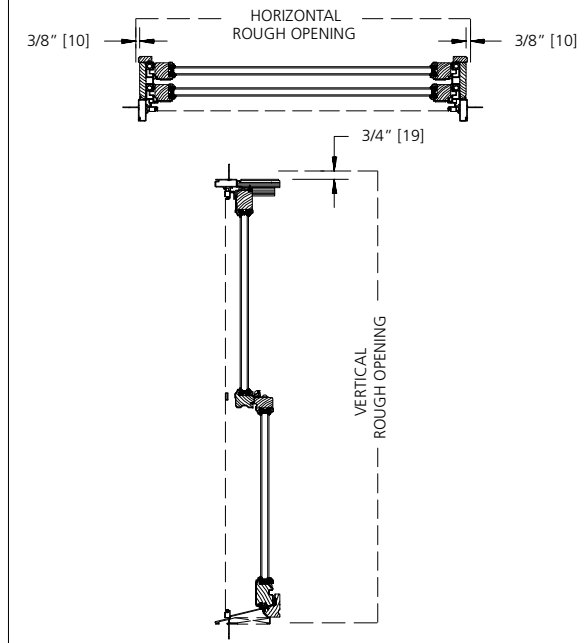

NON-STANDARD UNIT SIZING

EXTERIOR TRIM OFFERINGS WITH SILL NOSE
EXTERIOR TRIM MUST USE SILL NOSE

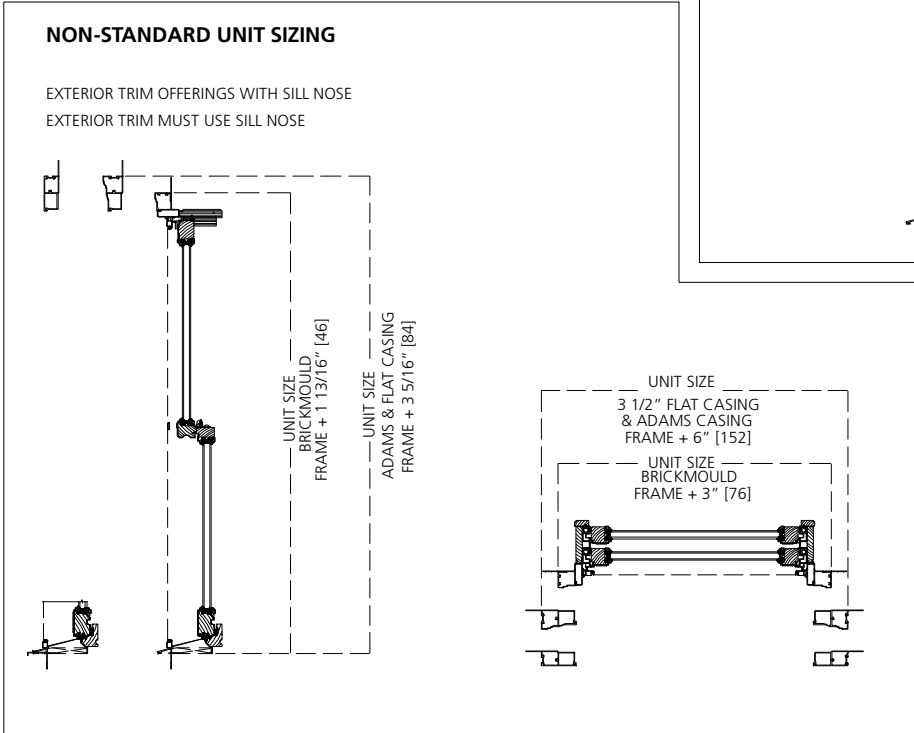

**FRAME TO TRIM
DIMENSIONS**

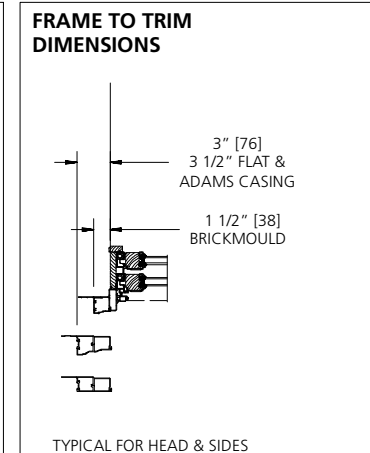

1-WIDE UNIT
DP35

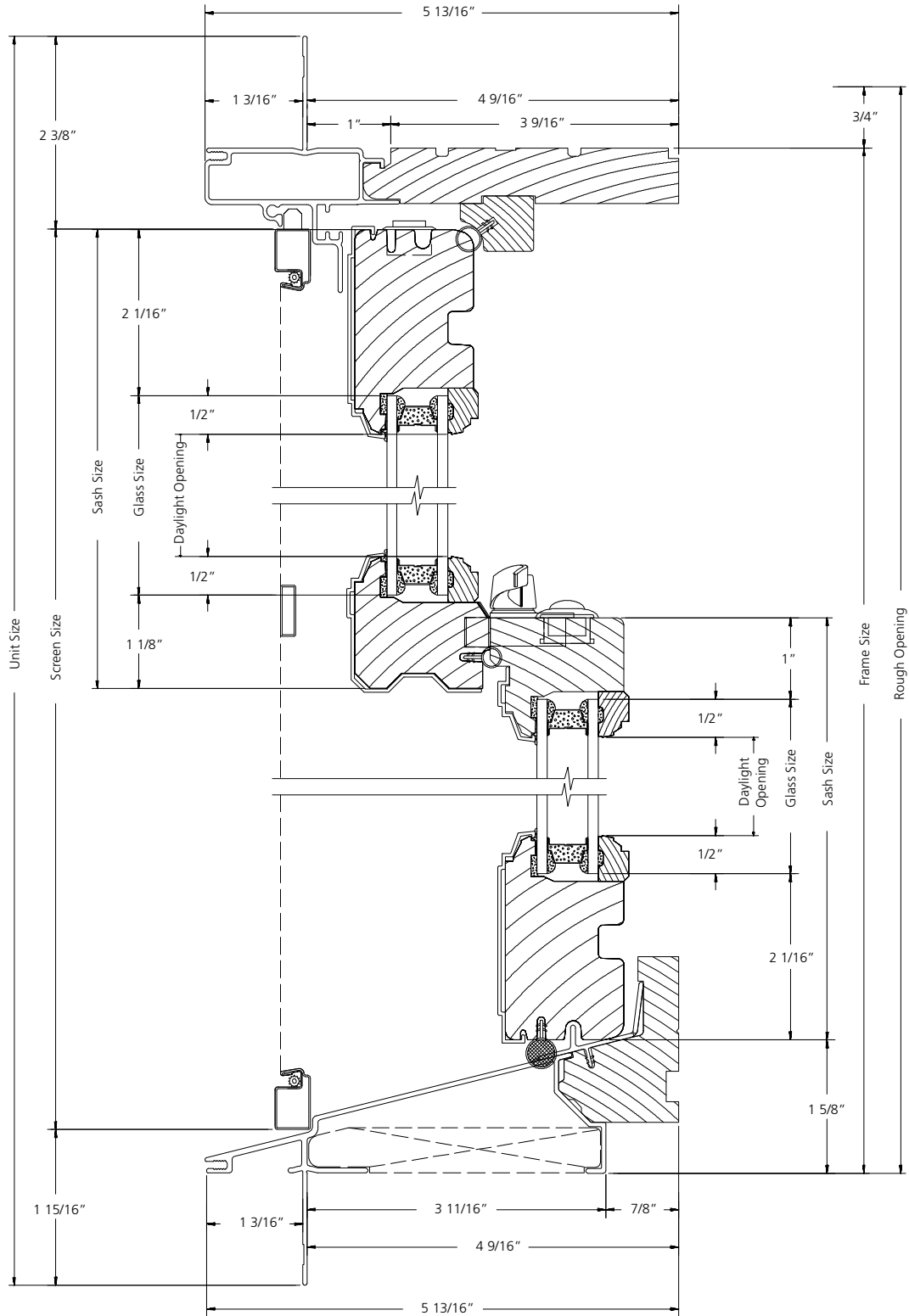

VERTICAL SECTION

SCALE: 6" = 1'

1-WIDE UNIT
DP50

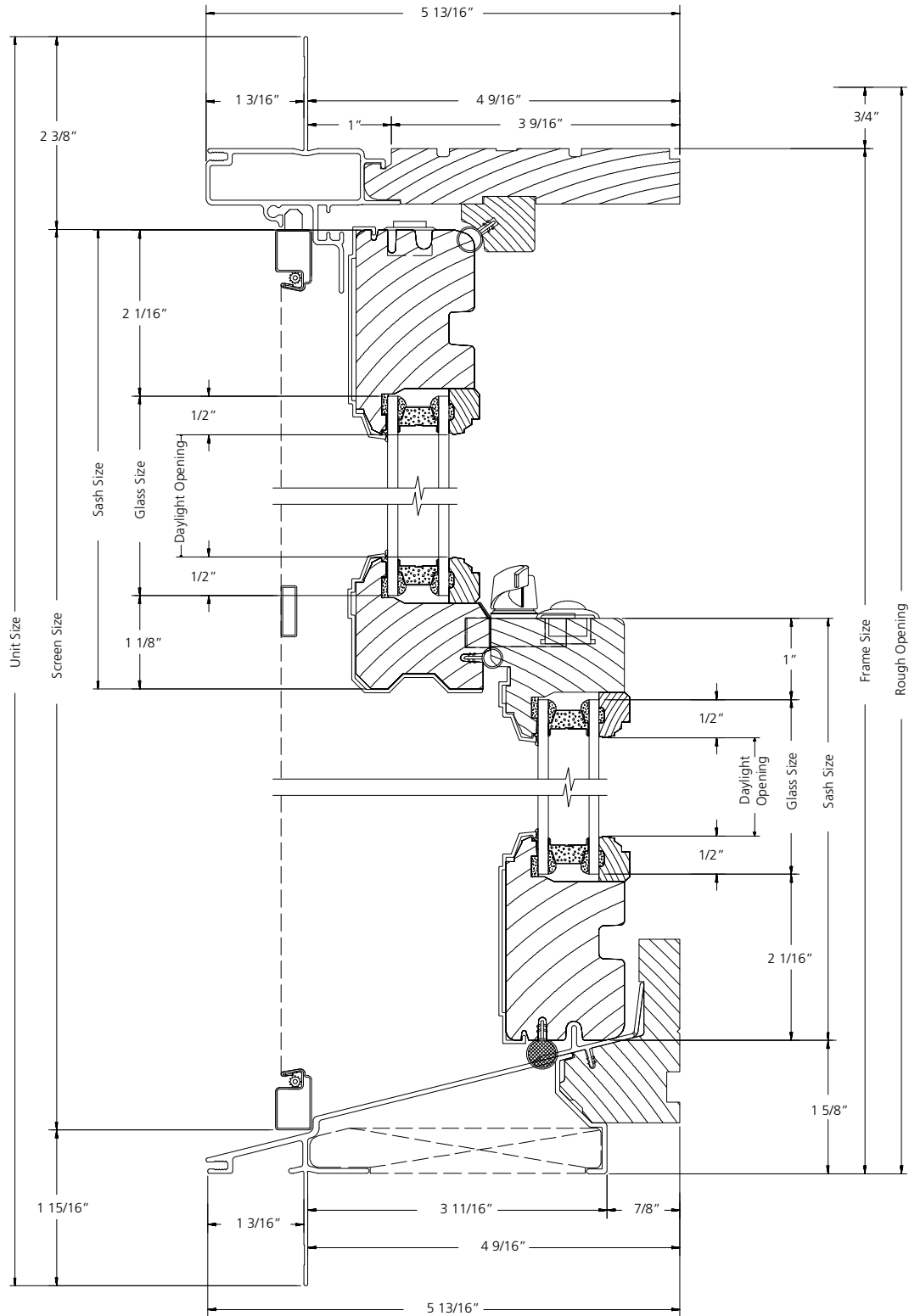

VERTICAL SECTION

SCALE: 6" = 1'

1-WIDE UNIT

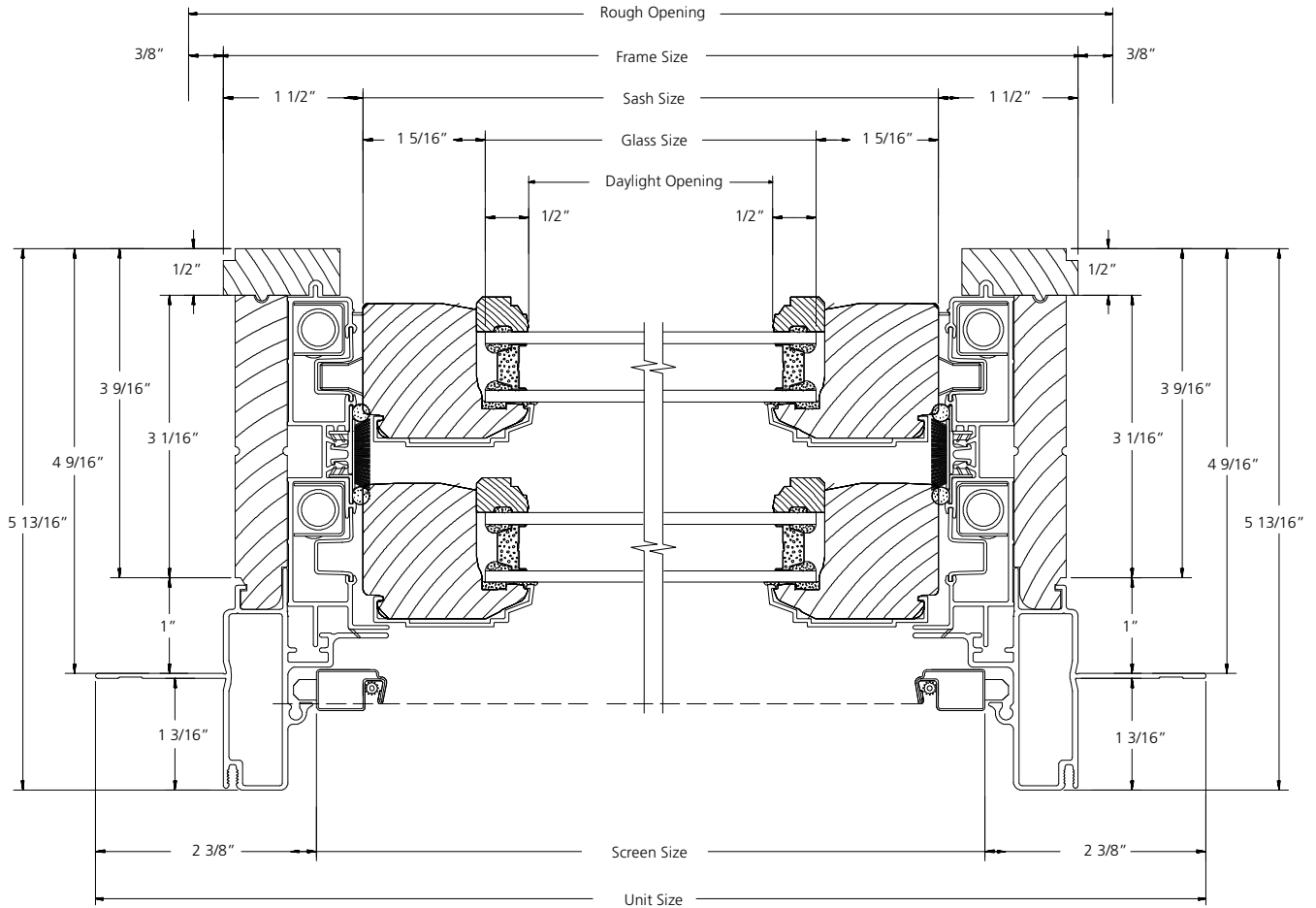

HORIZONTAL SECTION

SCALE: 6" = 1'

2-WIDE UNIT
DP35

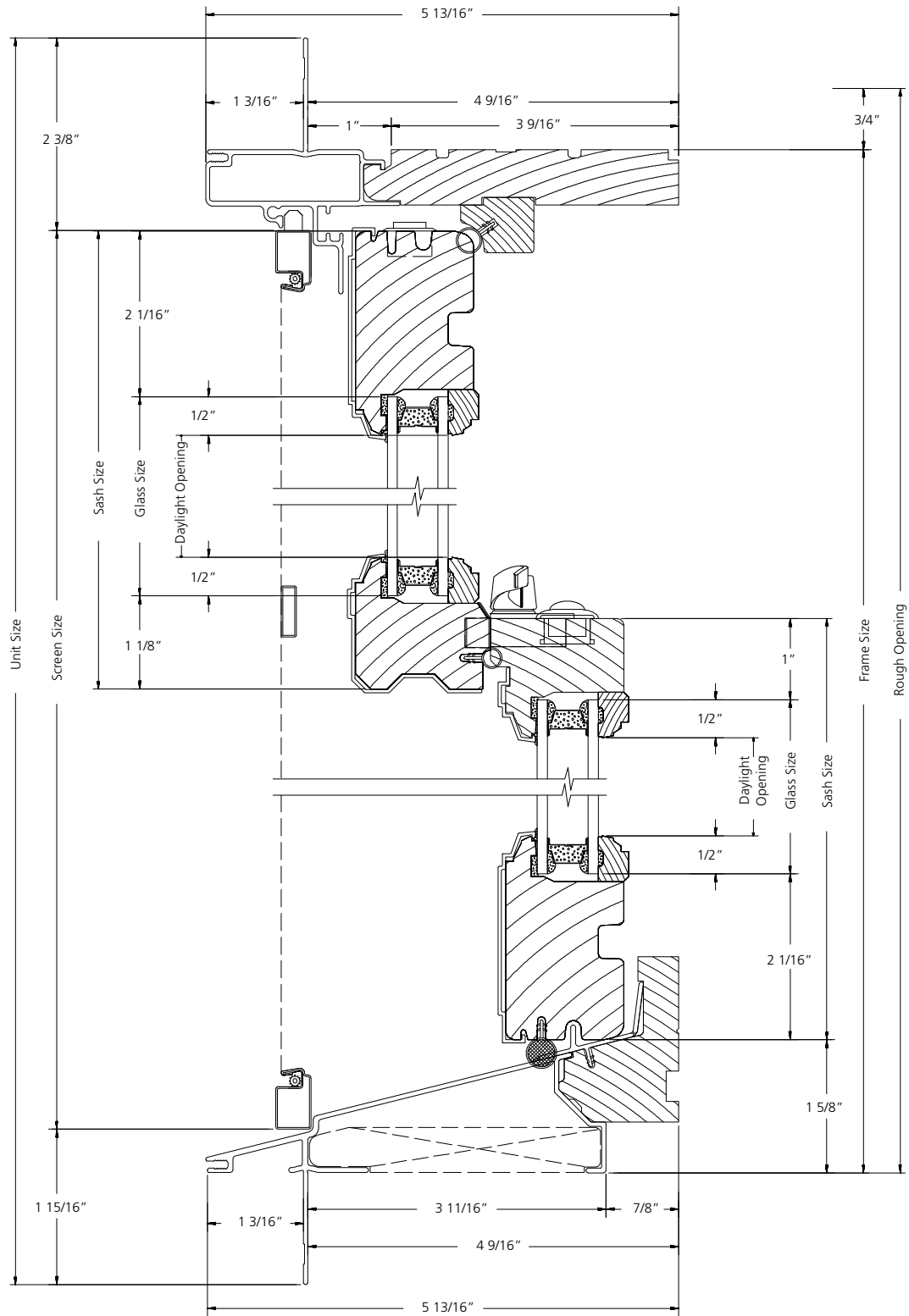

VERTICAL SECTION

SCALE: 6" = 1'

2-WIDE UNIT
DP50

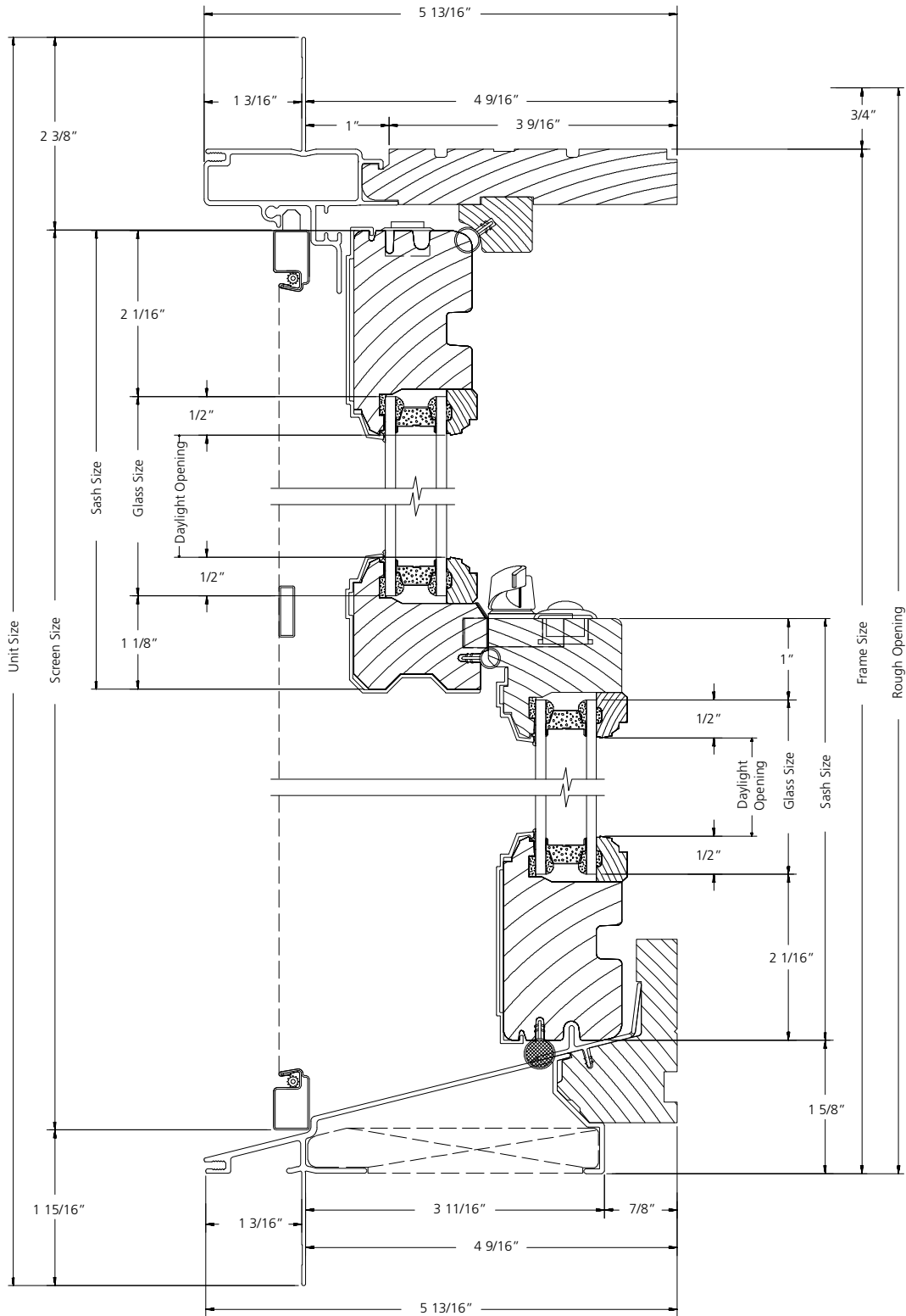

VERTICAL SECTION

SCALE: 6" = 1'

2-WIDE UNIT

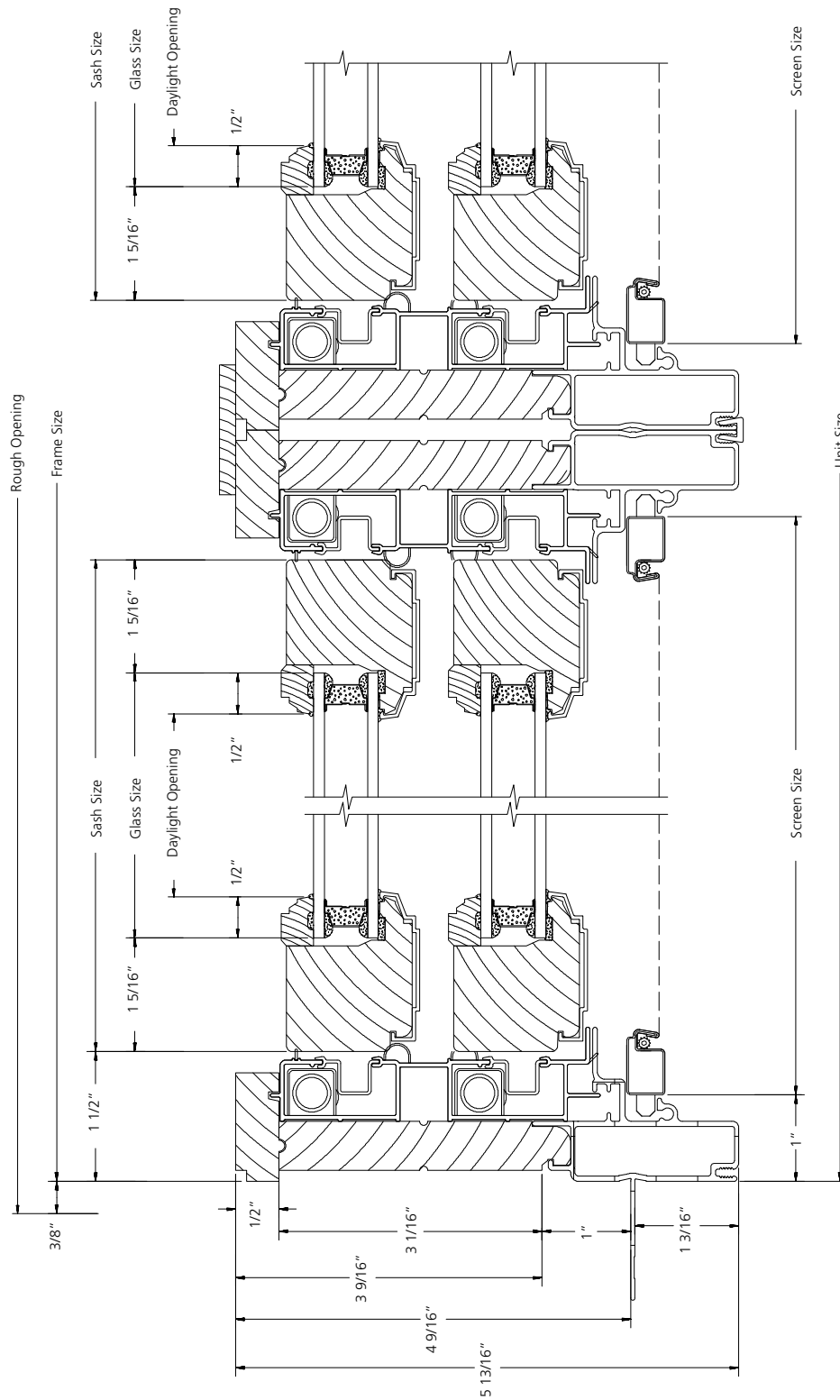

HORIZONTAL SECTION

SCALE: 6" = 1'

**PICTURE UNIT
DP35**

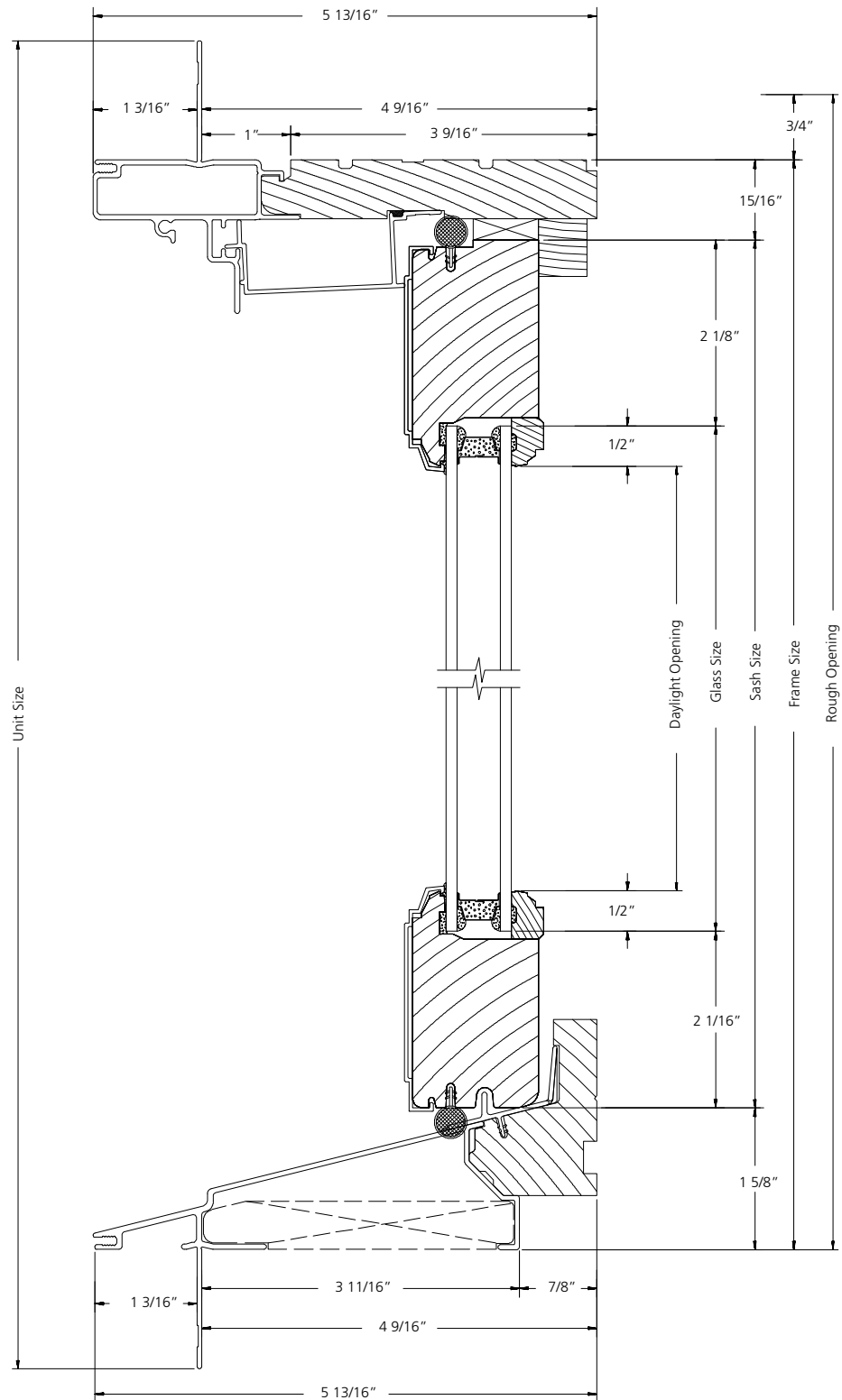

VERTICAL SECTION

SCALE: 6" = 1'

PICTURE UNIT
DP50

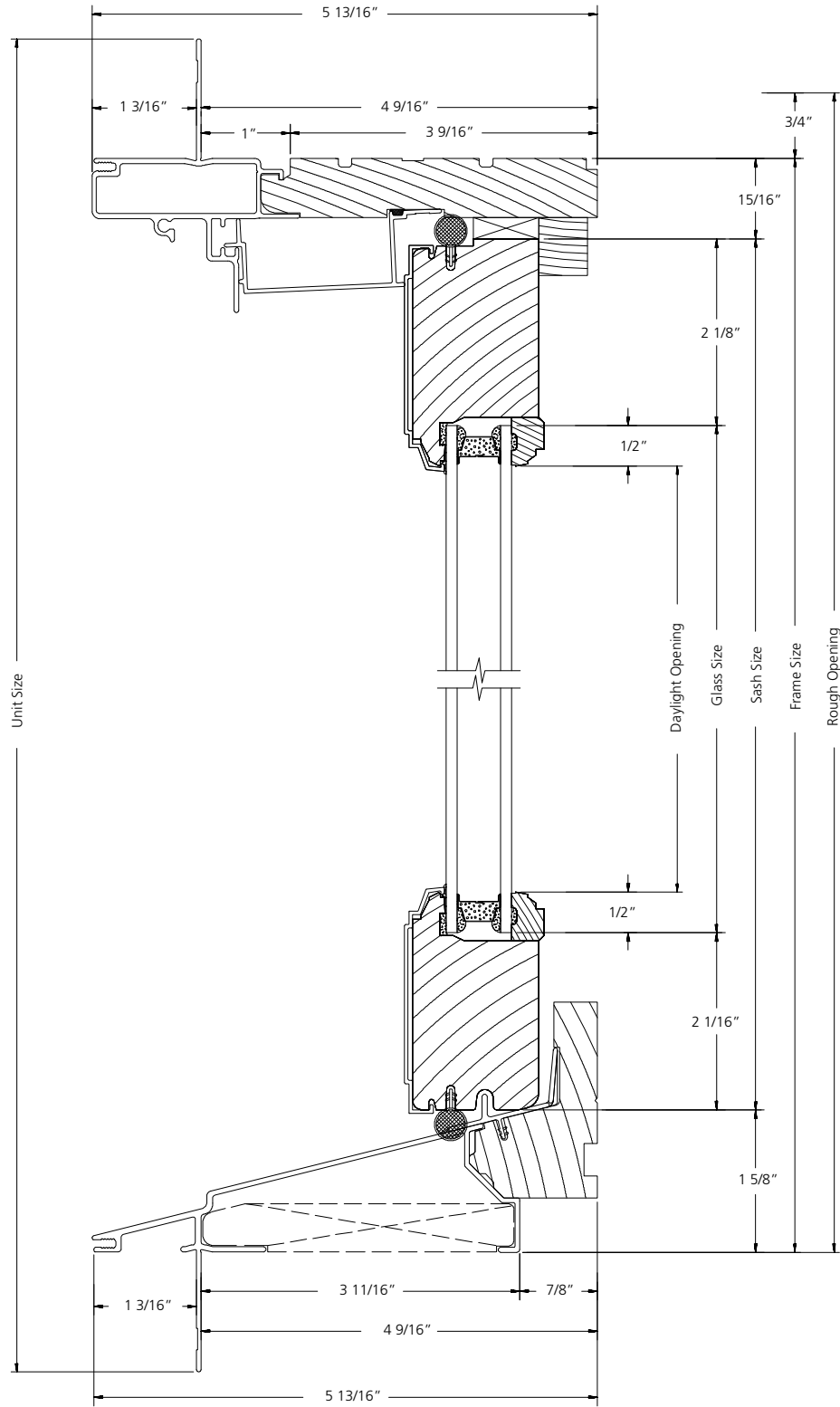

VERTICAL SECTION

SCALE: 6" = 1'

PICTURE UNIT

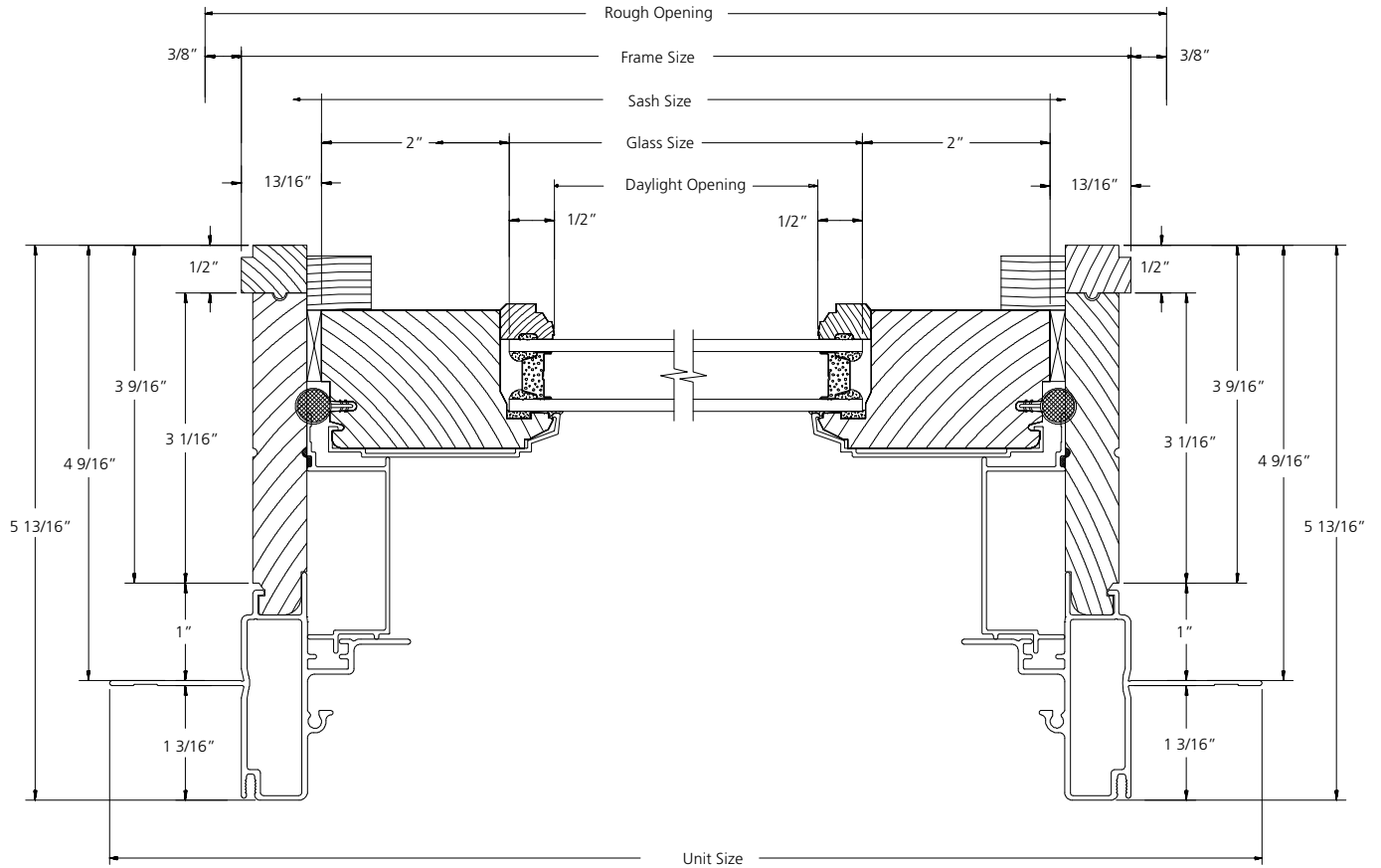

HORIZONTAL SECTION

SCALE: 6" = 1'

**PICTURE UNIT WITH FLANKER
DP35**

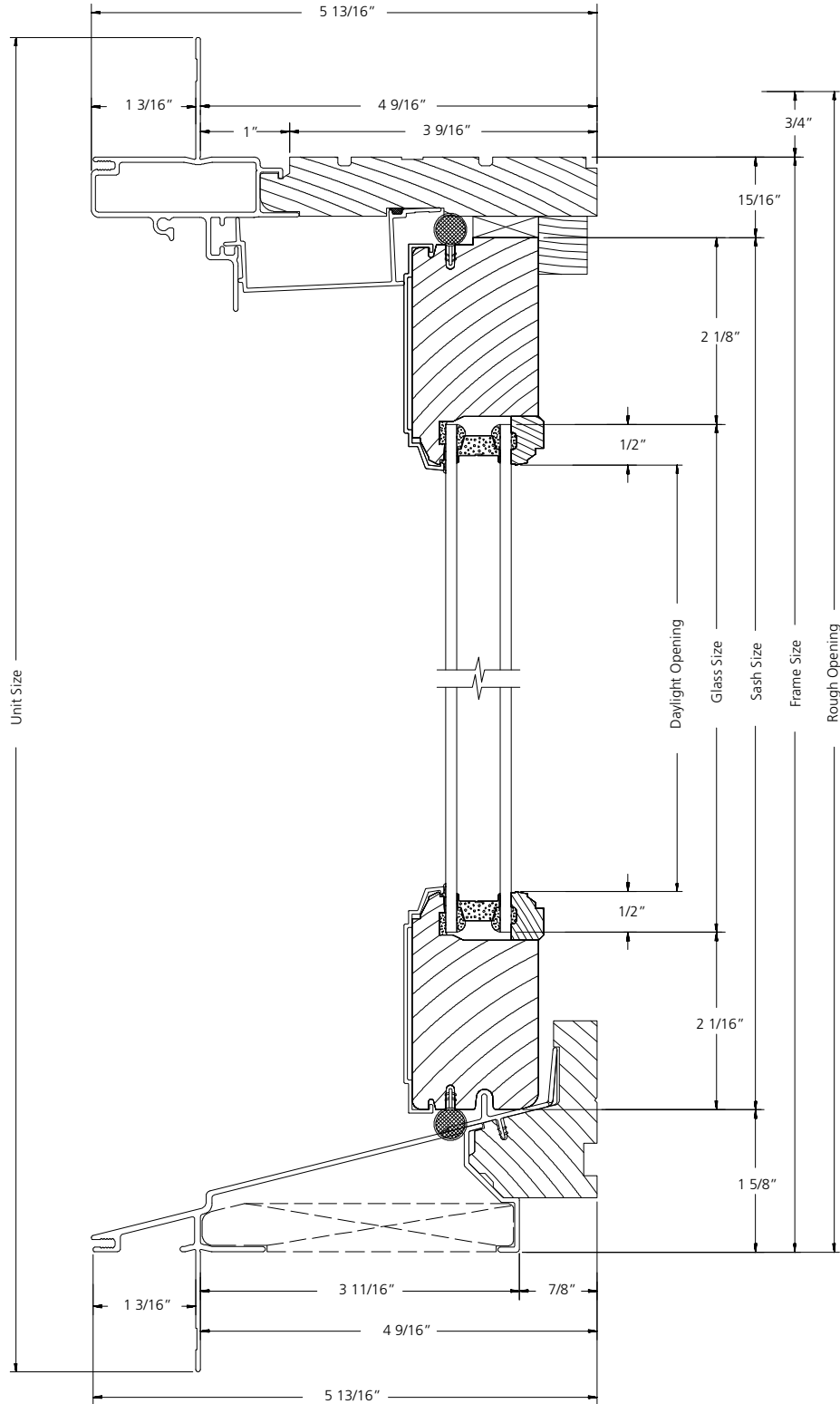

VERTICAL SECTION

SCALE: 6" = 1'

**PICTURE UNIT WITH FLANKER
DP50**

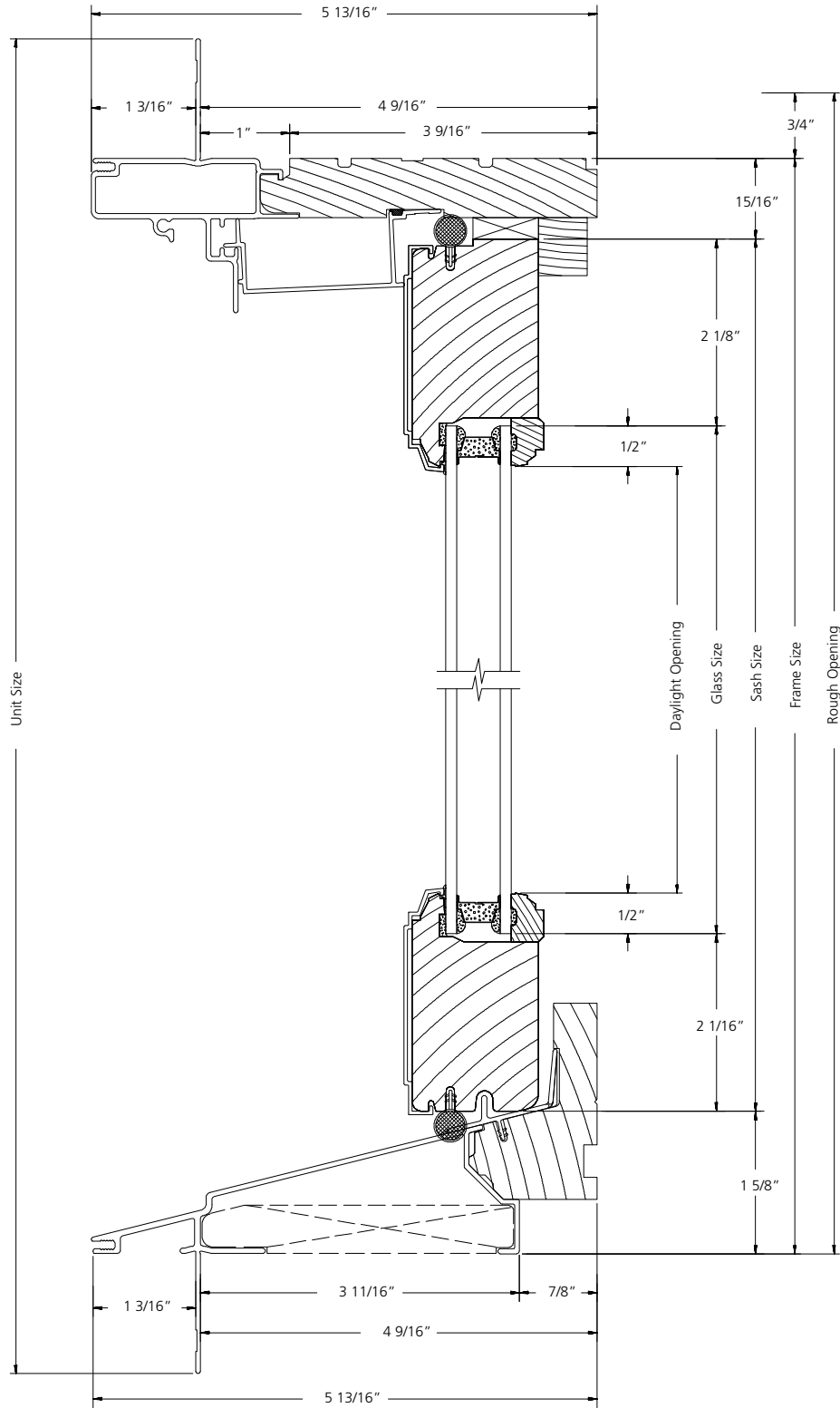

VERTICAL SECTION

SCALE: 6" = 1'

PICTURE UNIT WITH FLANKER

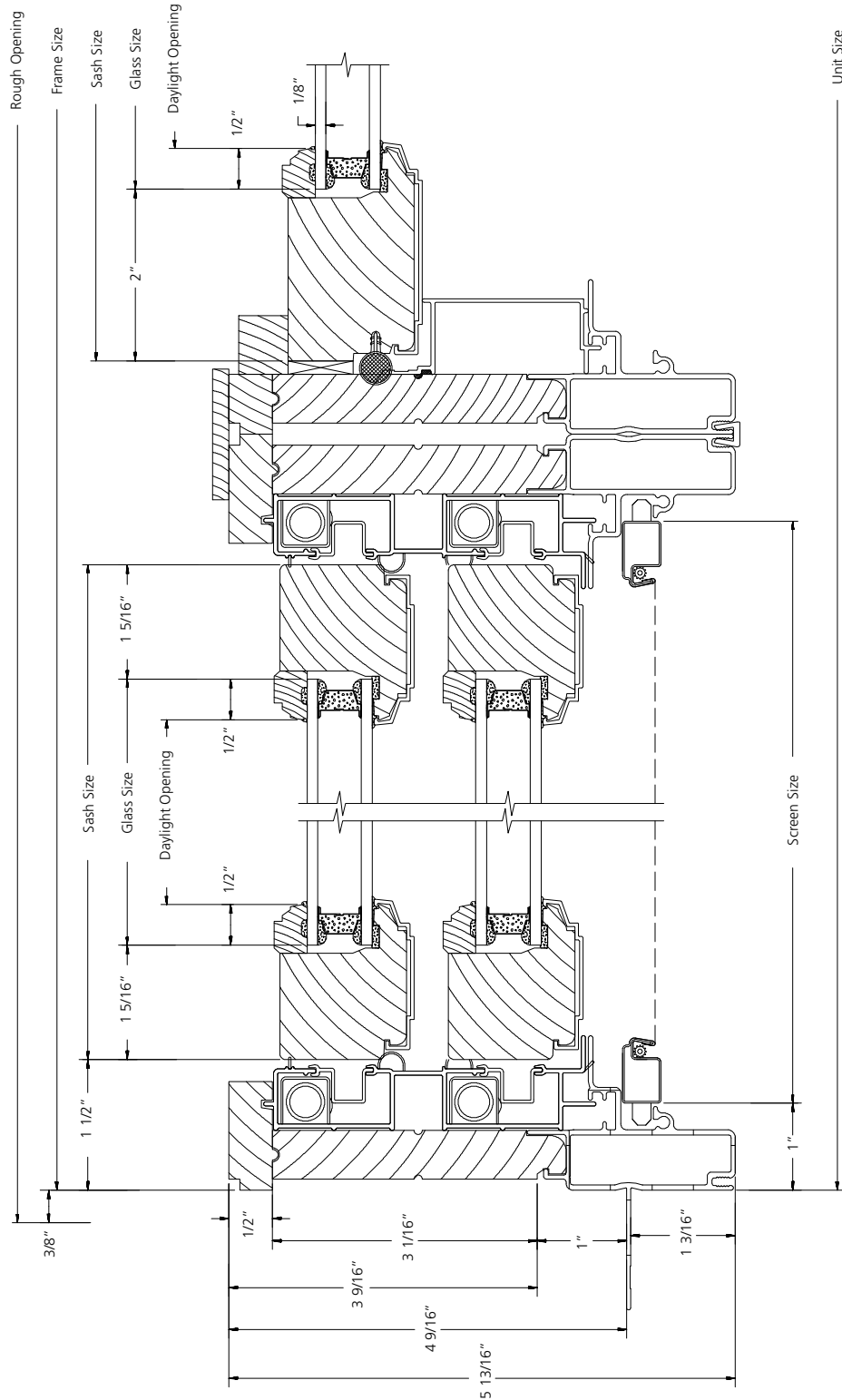

HORIZONTAL SECTION

SCALE: 6" = 1'

SECTOR TOP UNIT

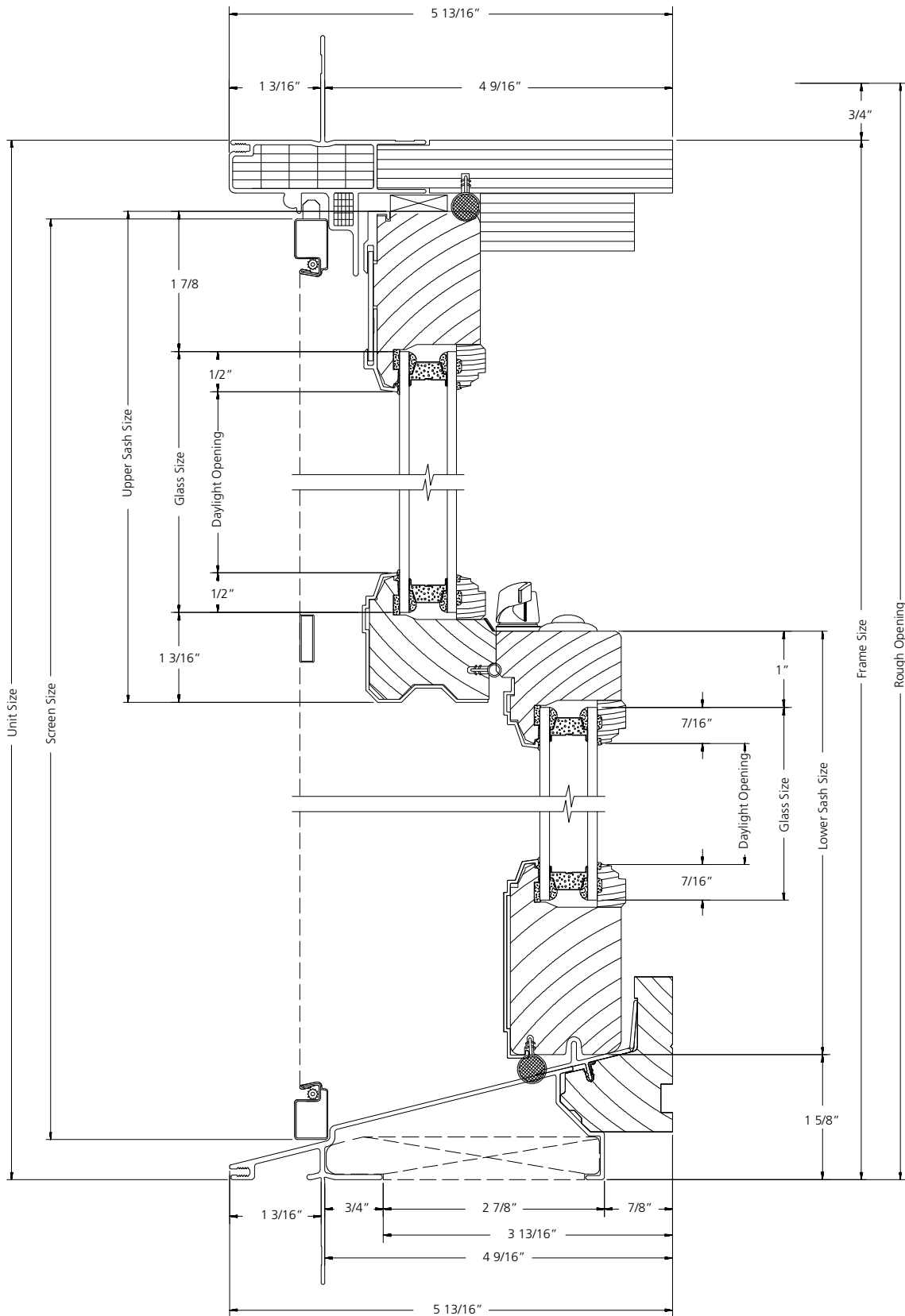

VERTICAL SECTION

SCALE: 6" = 1'

SECTOR TOP UNIT

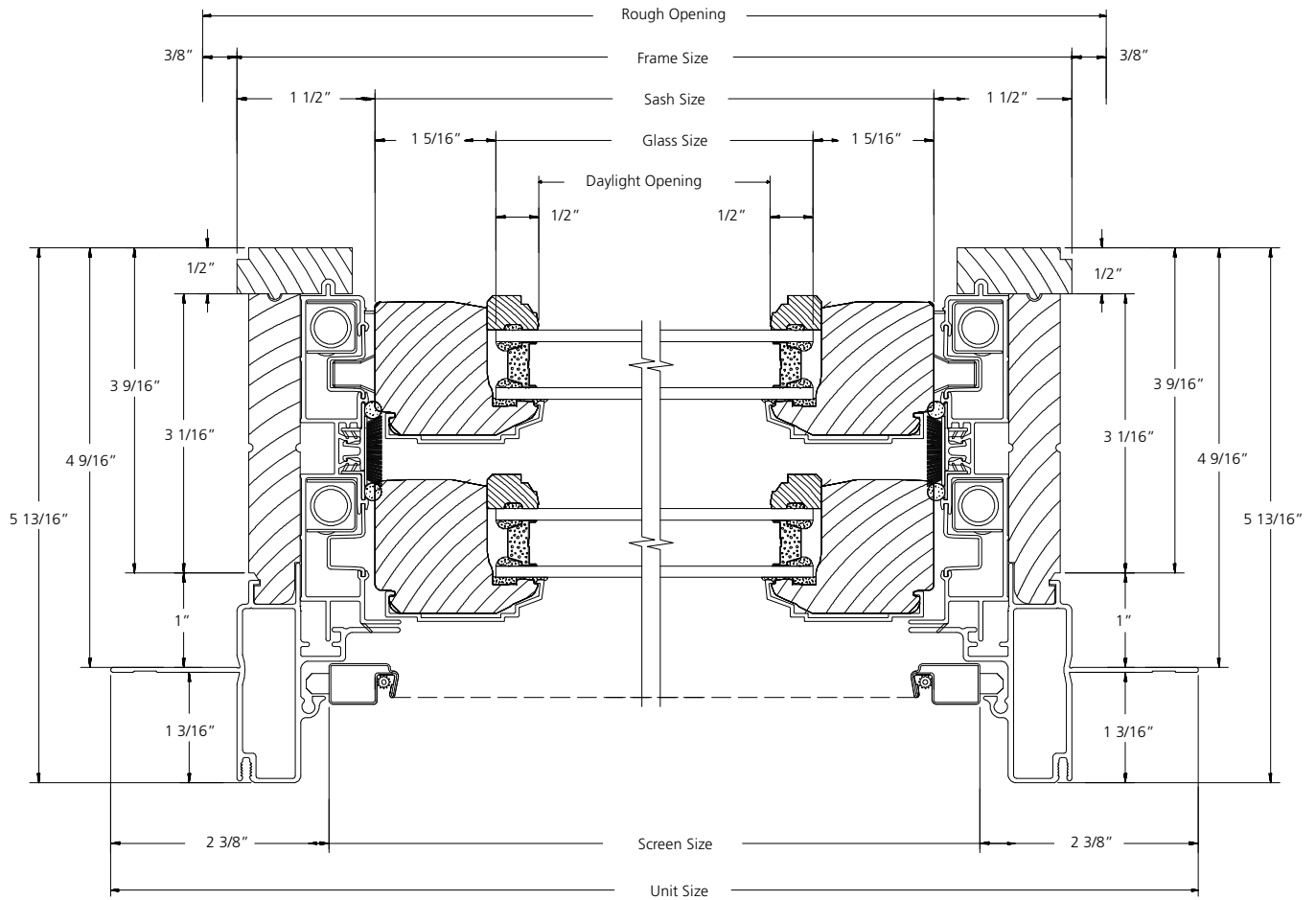

HORIZONTAL SECTION

SCALE: 6" = 1'

FULL RADIUS UNIT

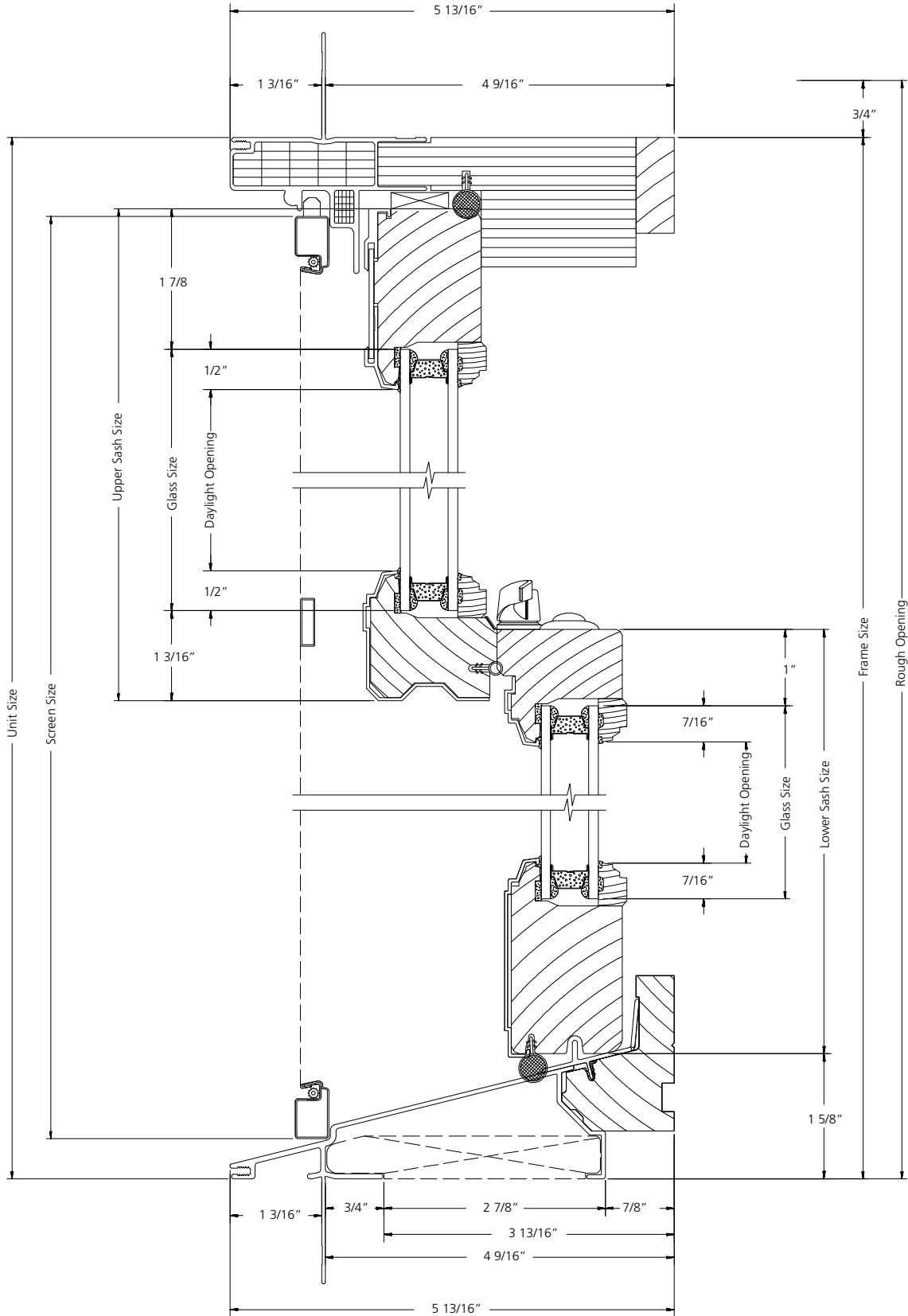

VERTICAL SECTION

SCALE: 6" = 1'

FULL RADIUS UNIT

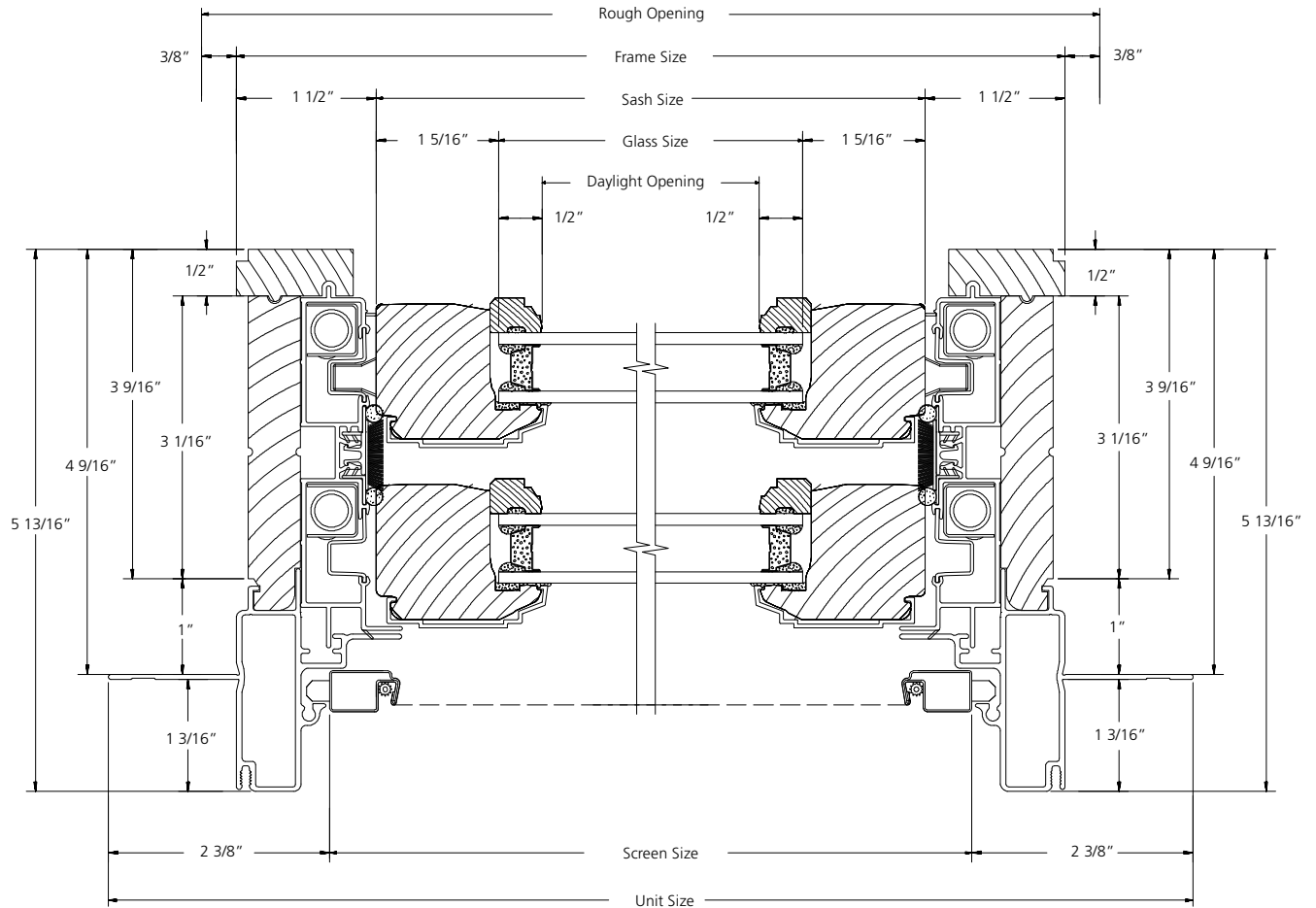

HORIZONTAL SECTION

SCALE: 6" = 1'

TRANSOM UNIT

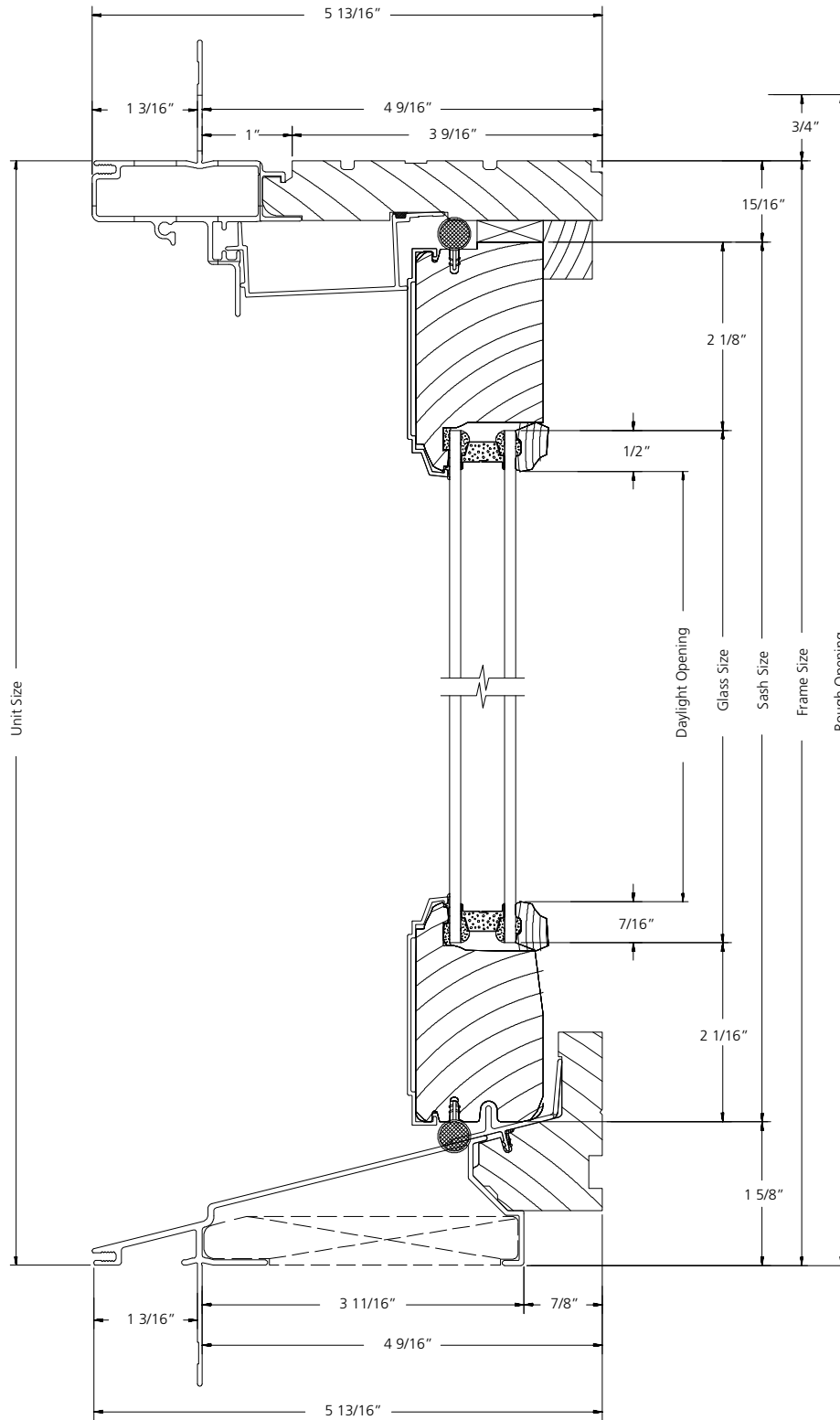

VERTICAL SECTION

SCALE: 6" = 1'

TRANSOM UNIT

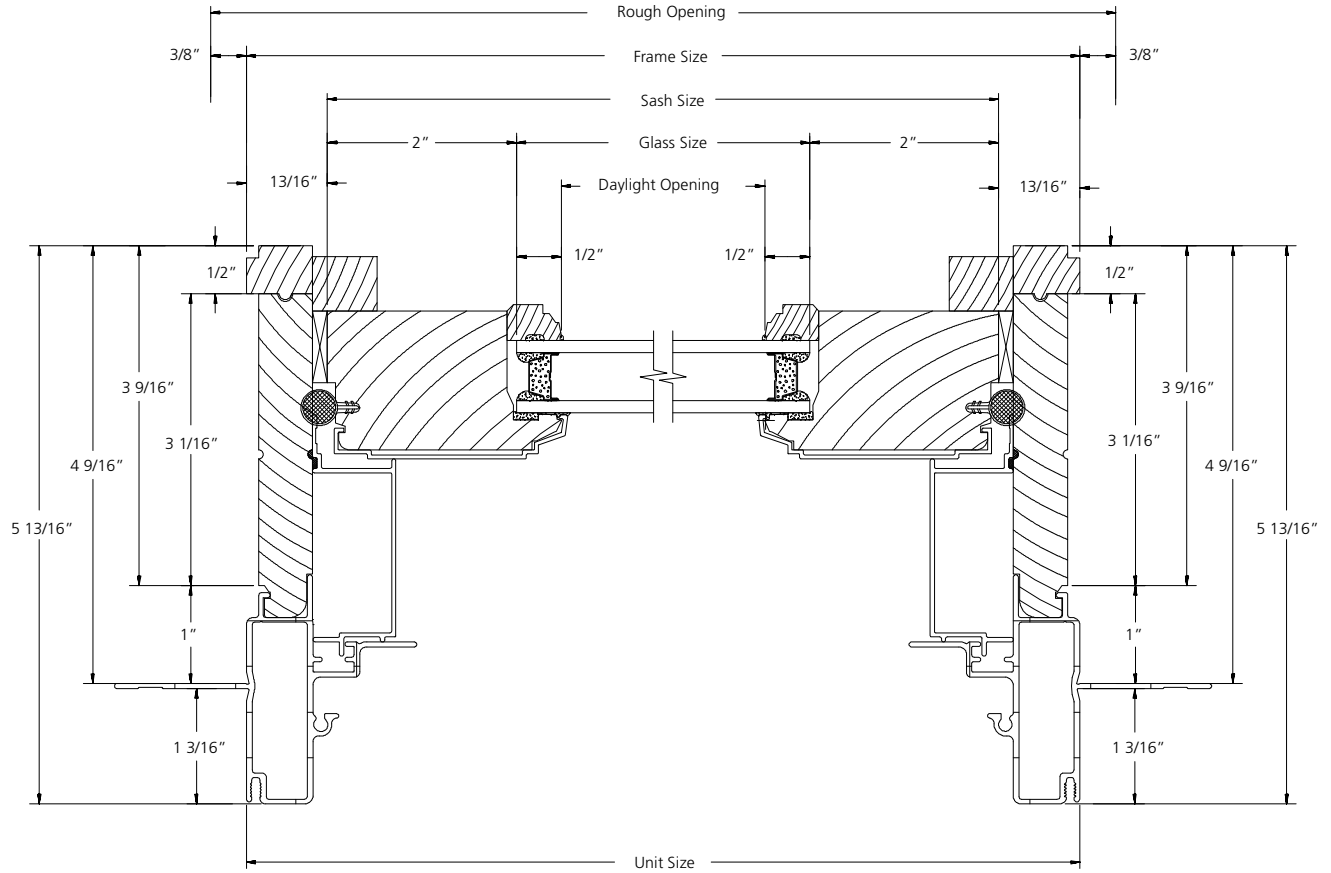

HORIZONTAL SECTION

SCALE: 6" = 1'

BAY WINDOW HORIZONTAL SPECIFICATION TABLES

30° ANGLE BAY

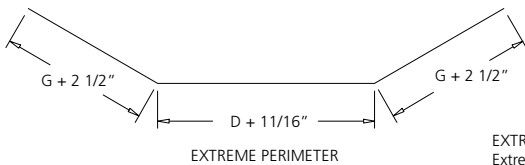
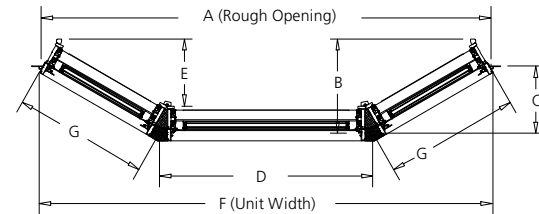

EXTREME PERIMETER
Extreme Perimeter is the distance around the face of the bay, beginning at the exterior sheathing and continuing around the assembly along the extreme face of the basic unit frame.

45° ANGLE BAY

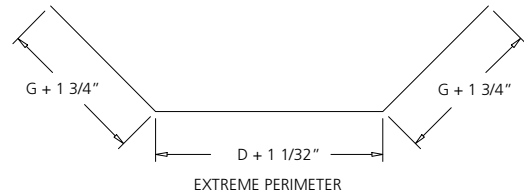
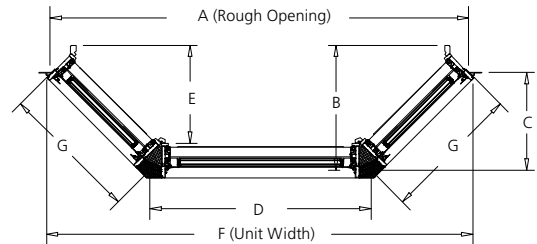

EXTREME PERIMETER

30° BAY								
Flanker Width (Call Size)	Center Width (Call Size)	A Rough Opening	F Overall Unit Width	B Overall Projection*	C Projection Exterior Wall	E Seating Depth*	D Outside Mull to Mull	G Outside Mull to Unit
21	21	63 11/16	64 5/16	15 7/8	11 5/16	11 5/16	23 13/16	22 5/8
21	41	83 11/16	84 5/16	15 7/8	11 5/16	11 5/16	43 13/16	22 5/8
21	49	91 11/16	92 5/16	15 7/8	11 5/16	11 5/16	51 13/16	22 5/8
21	53	95 11/16	96 5/16	15 7/8	11 5/16	11 5/16	55 13/16	22 5/8
21	61	103 11/16	104 5/16	15 7/8	11 5/16	11 5/16	63 13/16	22 5/8
21	69	111 11/16	112 5/16	15 7/8	11 5/16	11 5/16	71 13/16	22 5/8
25	25	74 5/8	75 1/4	17 7/8	13 5/16	13 5/16	27 13/16	26 5/8
25	41	90 5/8	91 1/4	17 7/8	13 5/16	13 5/16	43 13/16	26 5/8
25	49	98 5/8	99 1/4	17 7/8	13 5/16	13 5/16	51 13/16	26 5/8
25	53	102 5/8	103 1/4	17 7/8	13 5/16	13 5/16	55 13/16	26 5/8
25	61	110 5/8	111 1/4	17 7/8	13 5/16	13 5/16	63 13/16	26 5/8
25	69	118 5/8	119 1/4	17 7/8	13 5/16	13 5/16	71 13/16	26 5/8
29	29	85 9/16	86 3/16	19 7/8	15 5/16	15 5/16	31 13/16	30 5/8
29	41	97 9/16	98 3/16	19 7/8	15 5/16	15 5/16	43 13/16	30 5/8
29	49	105 9/16	106 3/16	19 7/8	15 5/16	15 5/16	51 13/16	30 5/8
29	53	109 9/16	110 3/16	19 7/8	15 5/16	15 5/16	55 13/16	30 5/8
29	61	117 9/16	118 3/16	19 7/8	15 5/16	15 5/16	63 13/16	30 5/8
29	69	125 9/16	126 3/16	19 7/8	15 5/16	15 5/16	71 13/16	30 5/8

45° BAY								
Flanker Width (Call Size)	Center Width (Call Size)	A Rough Opening	F Overall Unit Width	B Overall Projection*	C Projection Exterior Wall	E Seating Depth*	D Outside Mull to Mull	G Outside Mull to Unit
21	21	58 13/16	59 15/16	21	16 7/16	16 7/16	25 1/8	23 1/4
21	41	78 13/16	79 15/16	21	16 7/16	16 7/16	45 1/8	23 1/4
21	49	86 13/16	87 15/16	21	16 7/16	16 7/16	53 1/8	23 1/4
21	53	90 13/16	91 15/16	21	16 7/16	16 7/16	57 1/8	23 1/4
21	61	98 13/16	99 15/16	21	16 7/16	16 7/16	65 1/8	23 1/4
21	69	106 13/16	107 15/16	21	16 7/16	16 7/16	73 1/8	23 1/4
25	25	68 1/2	69 9/16	24	19 1/4	19 1/4	29 1/8	27 1/4
25	41	84 1/2	85 9/16	24	19 1/4	19 1/4	45 1/8	29 1/4
25	49	92 1/2	93 9/16	24	19 1/4	19 1/4	53 1/8	29 1/4
25	53	96 1/2	97 9/16	24	19 1/4	19 1/4	57 1/8	29 1/4
25	61	104 1/2	105 9/16	24	19 1/4	19 1/4	65 1/8	29 1/4
25	69	112 1/2	113 9/16	24	19 1/4	19 1/4	73 1/8	29 1/4
29	29	78	79 1/4	27	22 1/8	22 1/8	33 1/8	31 1/4
29	41	90	91 1/4	27	22 1/8	22 1/8	45 1/8	31 1/4
29	49	98	99 1/4	27	22 1/8	22 1/8	53 1/8	31 1/4
29	53	102	103 1/4	27	22 1/8	22 1/8	57 1/8	31 1/4
29	61	110	111 1/4	27	22 1/8	22 1/8	65 1/8	31 1/4
29	69	118	119 1/4	27	22 1/8	22 1/8	73 1/8	31 1/4

The tables above reflect a 4 9/16" wall application. To convert to a 6 9/16" wall application, add 2" to the figures in the columns which shown an asterisk (*), B and E. ROUGH OPENING data reflects FRAME + 3/4".

BAY WINDOW ROUGH OPENINGS

BAY WINDOW TRIM OPTIONS

The standard offerings for clad double hung bay windows is 'frame only' and brickmould and sillnose. Other trim options subject to approval.

VERTICAL ROUGH OPENING

Rough Opening typical for all Units

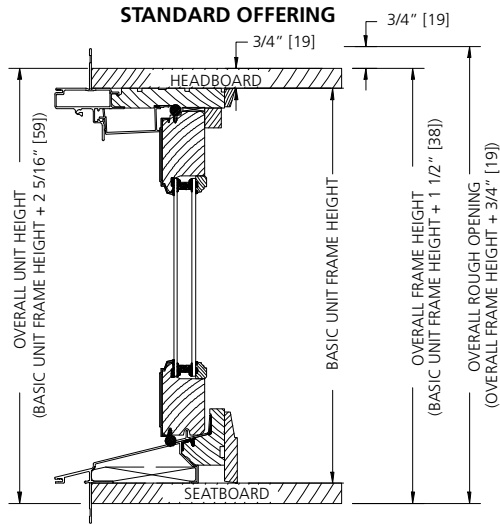

Vertical Masonry Opening will be 1/2" [13] larger than the Overall Unit Height.

HORIZONTAL ROUGH OPENING

Rough Opening typical for all Units

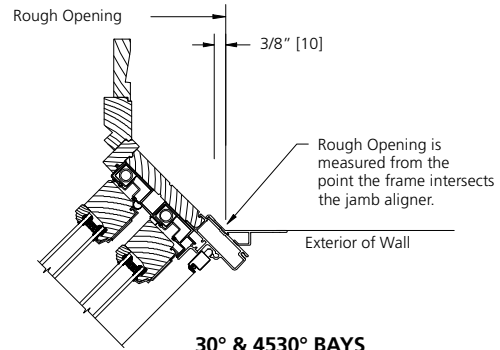

30° & 4530° BAYS
45° Bay Shown
without trim

30° ANGLE BAY UNIT
NO TRIM

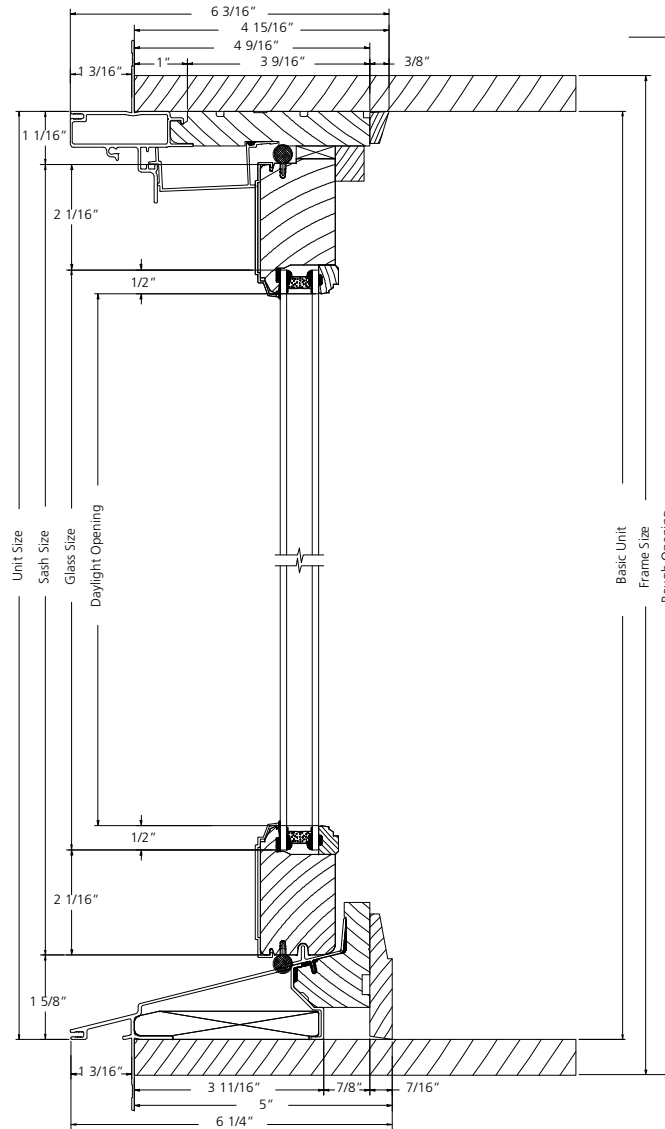

VERTICAL SECTION

SCALE: 3" = 1'

**30° ANGLE BAY UNIT
WITH STATIONARY CENTER**

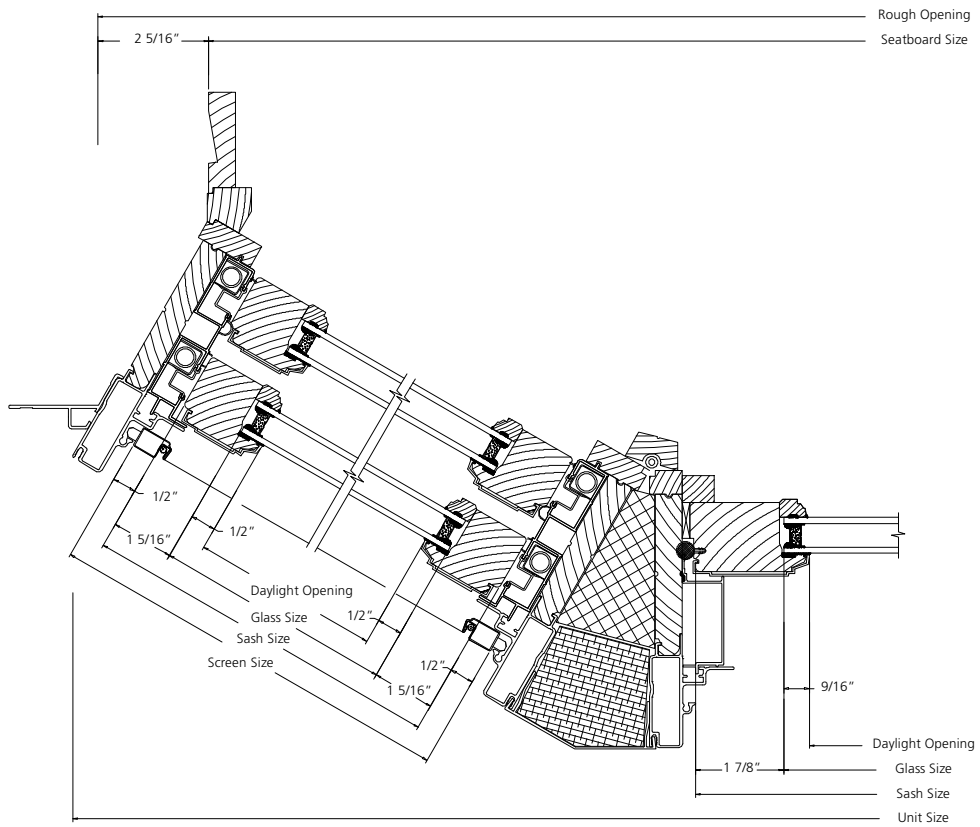

HORIZONTAL SECTION

SCALE: 3" = 1'

**30° ANGLE BAY UNIT
WITH OPERABLE CENTER**

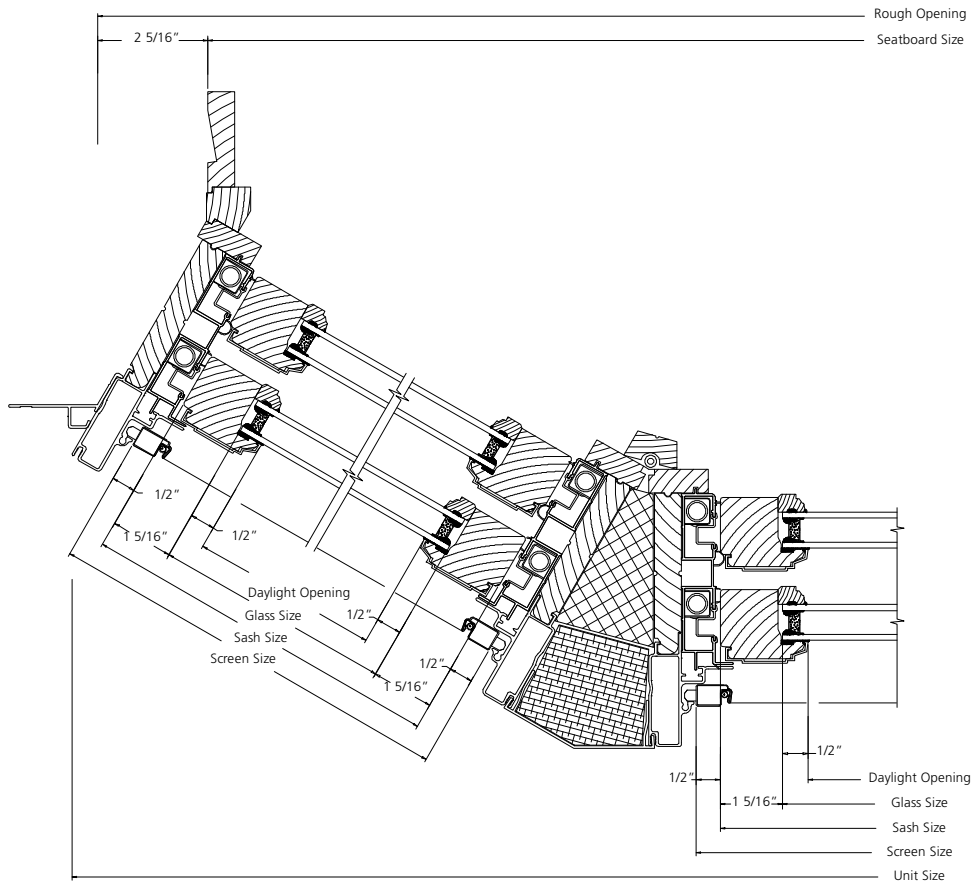

HORIZONTAL SECTION

SCALE: 3" = 1'

45° ANGLE BAY UNIT
NO TRIM

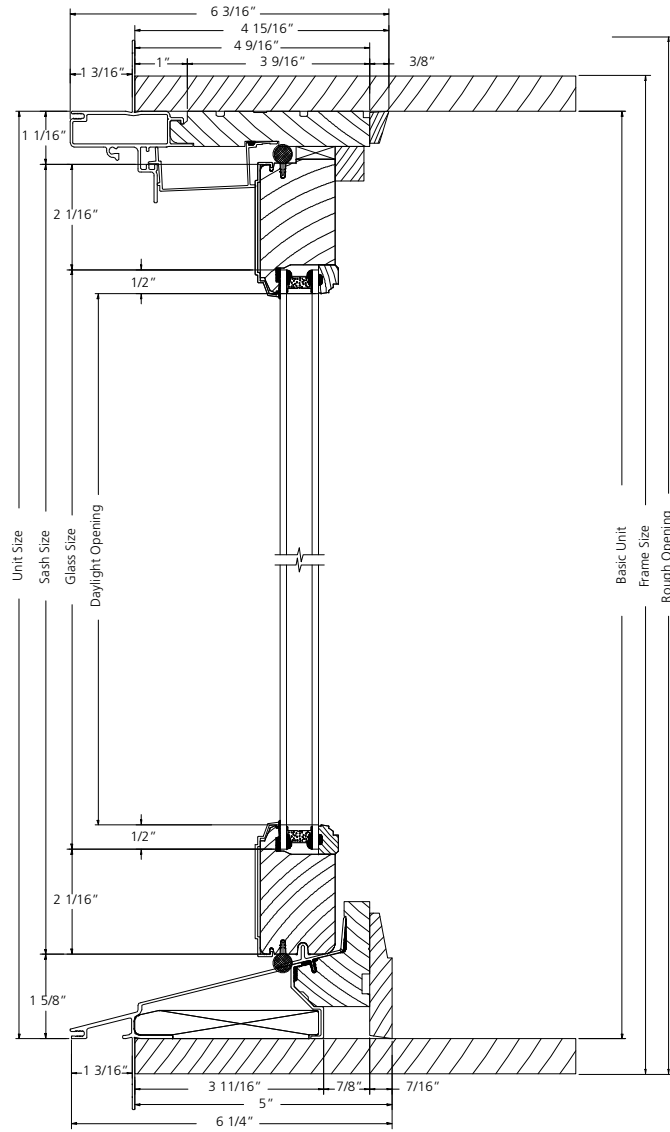

VERTICAL SECTION

SCALE: 3" = 1'

**45° ANGLE BAY UNIT
WITH STATIONARY CENTER**

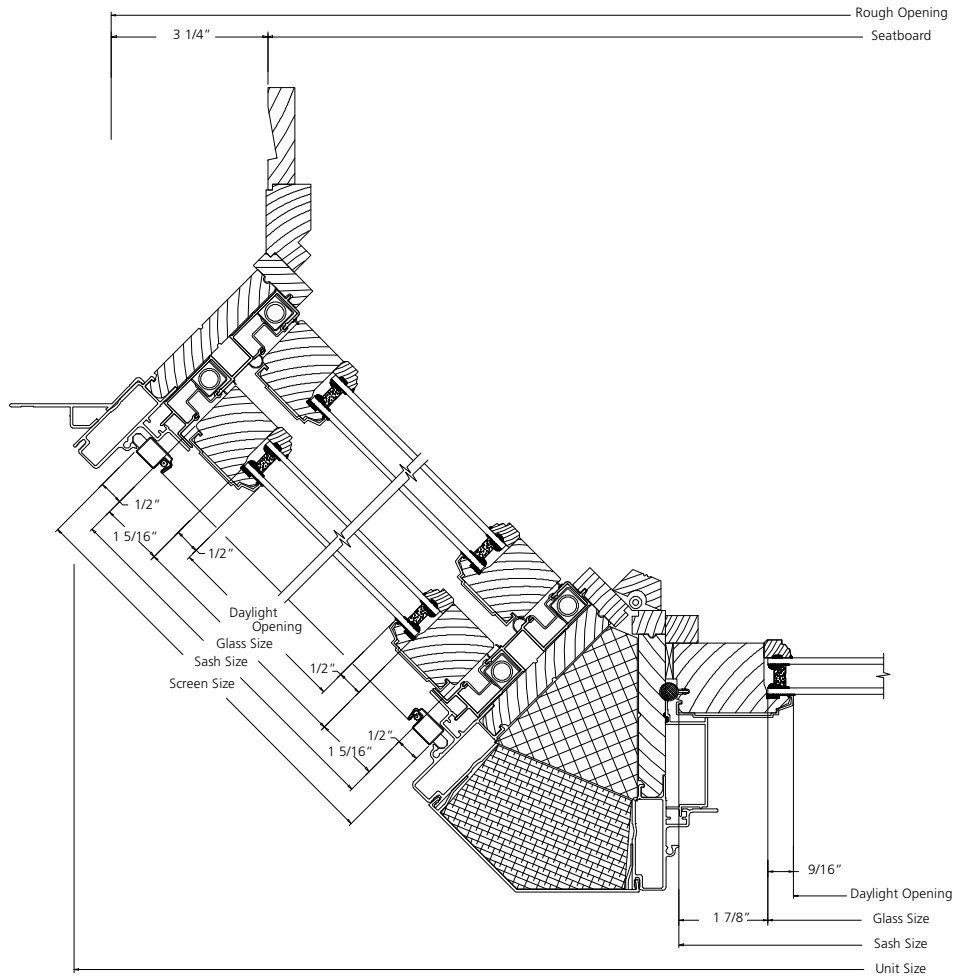

HORIZONTAL SECTION

SCALE: 3" = 1'

**45° ANGLE BAY UNIT
WITH OPERABLE CENTER**

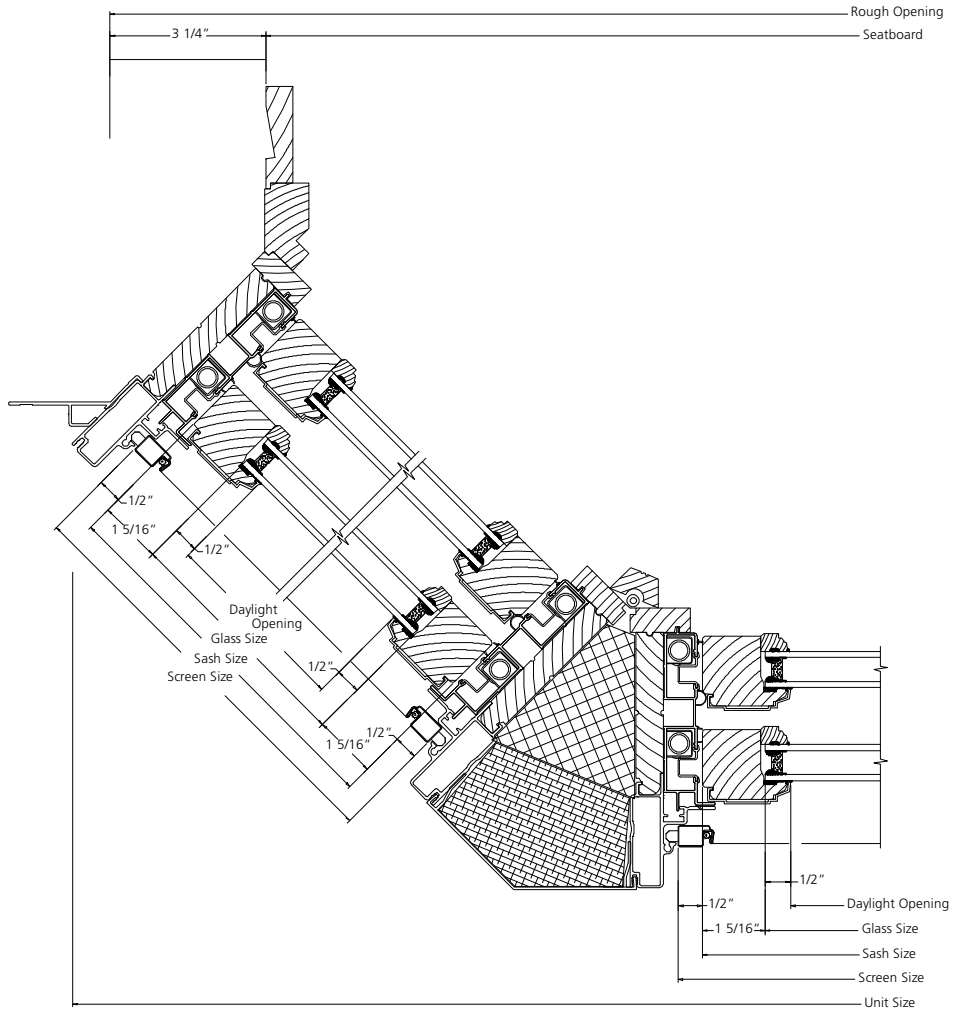

HORIZONTAL SECTION

SCALE: 3" = 1'