TABLE OF CONTENTS

Specifications	6-2
Quick Spec Guide	6-4
Elevations/Sizes: 1/4" Scale	6-6
Double-Hung	6-9
Double-Hung Picture	6-20
Double-Hung Picture with Flankers	6-30
Sector Top	6-32
Full Radius	6-46
Transoms	6-56
Sash Glazing Options: 3" Scale	6-58
Trim & Sill Options: 3" Scale	6-59
Jamb Options: 3" Scale	6-61
Standard Mullion Options	6-62
Lite Cut Information	6-64
Unit Sizing, Rough Openings & Masonry Openings	6-66
Section Details: 6" Scale	6-68
Angle Bay Specifications and Rough Opening Information	6-86
Section Details: 3" Scale (Angle Bay)	6-88

PRODUCT SPECIFICATIONS**EXTERIOR FINISH**

All exterior surfaces are covered with a factory-applied latex primer.

AURALAST® WOOD

AuraLast® wood is fundamentally different from wood resulting from traditional millwork preservation processes in that it uses a proprietary vacuum/pressure process to provide protection throughout the wood parts used to make windows and doors. AuraLast® wood is distinguished from wood using the current preservation methods by its unique ability to achieve greater penetration of the active ingredients into the wood parts, with a penetration of the treatment being a minimum of 92%.

INTERIOR FINISH

All interior surfaces are unfinished clear pine ready for on site finishing. Primed and pre-finished interiors are available in paint: Pure White, Extra White, Natural Choice, Moderate White; in stain: Wheat, Cherry, Fruitwood, Cordovan, Cider and Clear Lacquer.

FRAME

Frame is assembled from select kiln dried pine using AuraLast® wood on all exterior parts. Frame corner joints are tightly secured with metal fasteners and adhesive. Frame thickness is 1 1/16" (17.5mm) at head, side jamb and sill. Basic jamb width is 4-9/16" (116mm) and may be extended for different wall depths. Finished frame has exterior casing, sill nosing, weather-stripping, hardware, and interior stops applied.

SASH

Sash is 1-7/16" (36.5mm) thick select kiln-dried pine using AuraLast® wood. Stiles and rails are mortise and tenoned, machine clamped for squareness and secured with metal fasteners. The glass is mounted into the sash using a silicone-glazing compound on the exterior and acrylic sealant on the interior, then secured with interior applied profiled wood stops. Sash operate in a non-compression ivory colored jamb liner that allows both top and bottom sash to tilt inside for easy cleaning and removal without the use of tools. No finger plow sash available on venting units.

GLAZING

3/4" (19mm) thick sealed insulating glass is constructed from two panes of glass, utilizing a continuous roll formed stainless steel spacer with dual seal sealant. The glass is mounted into the sash using a silicone-glazing compound and secured with interior applied profiled wood stops. All insulating glass units comply with the performance requirements of IGCC in accordance with either ASTM E774 or E2190.

GLAZING OPTIONS

3/4" insulating glass available in Low-E with Argon, Low-E, Low-E 366, Clear, Neat Glass, reflective, tinted, or obscure, tempered or other specialty glass as specified. Preserve® film is a 0.003" thick polyethylene film with a low tack acrylic adhesive applied to the glass for protection during shipping and installation. 4,000 foot elevations and higher require a capillary tube to equalize environmental stress (otherwise known as High Altitude glazing). High Altitude glazing does not allow the use of Argon as listed under glazing options.

WEATHER-STRIPPING

Engineered system combines PVC ivory jamb liner with dual bulb weather-stripping at head. Checkrail features thermoplastic rubber bulb and recessed cam action sash lock for secure closure. Rigid vinyl water stops at sill provide additional restraint against weather.

HARDWARE

Sash operate by means of a dual block and tackle balance system with nylon roller pulleys and high-tension coil springs. Balance system gauged to sash weight and uses pre-stretched dacron cords attached to clutch mechanisms to insure smooth, operation and compliance with operating force requirements. Jamb liners are Ivory (White is optional). Recessed cam action sash lock is available in White, Chestnut Bronze, Desert Sand or optional Bright Brass, Antique Brass, Polished Brass, Brushed Chrome or Imitation Oil Rubbed Bronze. 28" glass width and larger units have two sash locks. Optional Lexan sash lift available for no finger plow sash.

EXTERIOR INSECT SCREENS

Charcoal fiberglass screen cloth (18x16 mesh) set in painted roll formed aluminum frame with color to match cladding - choice of Brilliant White, Chestnut Bronze, Desert Sand, French Vanilla, Hartford Green, Mesa Red, Black, Arctic Silver or Dark Chocolate, installed in channel on frame extrusion and held in place with spring loaded plungers at the top and sides of screen. Aluminum mesh and Phantom screen also available. Insect screens are intended to allow air and light in and to keep insects out. They are not intended to keep anyone or anything from falling through an open window. For safety screens or other security devices contact your local building supply retailer.

GRILLES

SDL (Simulated Divided Lites) - wood muntins permanently applied to the exterior of the insulating glass unit (not available on textured glass) in 7/8" (22mm), 1-1/8" (28.5mm), or 1-3/8" (34.9mm) widths, and a putty profile in 5/8" (15.9mm), 7/8" (22mm) and 1-1/8" (28.5mm) widths only. SDL is standard with a light bronze internal shadow bar to give a true divided lite appearance. As an option, SDL may be ordered with a silver shadow bar. Clear wood interior muntin bars match the exterior muntin width and are permanently bonded to the interior of the glass. Also available is a 2-5/16" (59mm) SDL bar, which simulates a double-hung checkrail.

Full Surround Wood Grilles - Rectangular unfinished clear pine wood grilles in 7/8" (22mm), 1-1/8" (28.6mm) and 1-3/8" (35mm) are available in patterns selected by the owner.

GBG (Grilles between the Glass) - 5/8" (15.9mm) flat and 23/32" or 1" contour mounted between the glass panes suspended within the air cavity.

EXTERIOR TRIM

1-3/32" (27.8mm) x 2" (50.8mm) brickmould with 1-1/16" (27mm) x 1-3/4" (44.5mm) nosing is standard. Flat casing is available as 1-3/32" (27.8mm) x 2" (50.8mm), 1-3/32" (27.8mm) x 3-1/2" (89mm), 1-3/32" (27.8mm) x 4-1/2" (114.3mm), and 1-3/32" (27.8mm) x 5-1/2" (139.7mm). The following profiled casings are available: RB-3 and Adams as 1-1/16" x 3-1/2" (89mm), and Williamsburg 1-3/16" x 3-1/4". Historical wood sill nosing 1-3/4" (44.5mm) and 2-13/16" (71.4mm) is also available.

Continued on next page

PRODUCT SPECIFICATIONS

EXTENSION JAMBS

Extension jambs are factory applied to the interior on all four sides of the frame and are 4/4 standard thick pine to accommodate wall depths up to 9-5/16" with one piece, and up to 12" with two pieces. 9/16" (14.2mm) option also available.

INSTALLATION

Installation per JELD-WEN Installation Method for Wood Windows JII003 or JII012. See www.jeld-wen.com/resources for instructions.

PERFORMANCE

NFRC Certified - (Rated and labeled in accordance with NFRC)

WDMA Hallmark Certified -
In accordance with **AAMA/NWWDA/101/I.S.2-97**

QUICK SPEC GUIDE

SPECIFICATION	STANDARD FEATURES	OPTIONAL FEATURES <i>Some options may require additional lead times. Consult your JELD-WEN Sales Representative.</i>
FRAME	<ul style="list-style-type: none"> Fingerjoint Wood 	
EXTERIOR FINISH	<ul style="list-style-type: none"> Primed 	<ul style="list-style-type: none"> Natural
EXTERIOR TRIM	<ul style="list-style-type: none"> 1-3/32" Brickmould Wood Sill Nose Drip Cap 	<ul style="list-style-type: none"> Flat Casing: 1-3/32" x 2", 3-1/2", 4-1/2", and 5-1/2" Heritage Casing: 1-3/16" x 3-1/4" Adams Casing: 1-1/16" x 3-1/2" RB3 Casing: 1-1/16" x 3-1/12" 1-7/32" x 4-1/2" Backband No Brickmould Option Historical Sill Nose Clad Metal Drip Cap (White only)
INTERIOR FINISH	<ul style="list-style-type: none"> Natural 	<ul style="list-style-type: none"> Priming Available <p>Pre-finished Interior Options are:</p> <ul style="list-style-type: none"> Paint - Pure White, Extra White, Natural Choice, Moderate White Stain - Wheat, Fruitwood, Cherry, Cordovan, Cider Clear Lacquer
SIZE	<ul style="list-style-type: none"> Width: Venting Double-Hung: 21-3/8, 25-3/8, 29-3/8, 31-3/8, 33-3/8, 37-3/8, 41-3/8, 45-3/8 Picture Double-Hung: 21-3/8, 25-3/8, 29-3/8, 31-3/8, 33-3/8, 37-3/8, 41-3/8, 45-3/8, 49-3/8, 53-3/8, 61-3/8, 69-3/8, 77-3/8 Height: Venting Double-Hung: 32, 36, 40, 44, 48, 52, 56, 60, 64, 68, 72, 76, 80, 88, 92 Picture Double-Hung: 15, 18, 24, 32, 36, 40, 44, 48, 52, 56, 60, 64, 68, 72, 76, 80, 88, 92 For RO, add 3/4" 	<ul style="list-style-type: none"> Width: Venting Double-Hung: Minimum: 16" Maximum: 45-3/8" Picture Double-Hung: Minimum: 16" Maximum: 77-3/8" Fixed Units over 49-3/8" wide can be up to 80" high Fixed Units up to 49-3/8" wide can be up to 92" high Height: Venting Double-Hung: Minimum: 28" Maximum: 92" * * glass can't exceed 42" high Picture Double-Hung: Minimum: 15" Maximum: 92" Fixed Units over 49-3/8" wide can be up to 80" high Fixed Units up to 49-3/8" wide can be up to 92" high For RO, add 3/4"
GLAZING	<ul style="list-style-type: none"> Low-E Insulating Glass Preserve® Protective Film 	<ul style="list-style-type: none"> Clear Obscure Bronze Low-E 366 Neat Glass Dual Low-E Reflective Tempered
		<ul style="list-style-type: none"> High Altitude

Continued on next page

QUICK SPEC GUIDE

SPECIFICATION	STANDARD FEATURES	OPTIONAL FEATURES <i>Some options may require additional lead times. Consult your JELD-WEN Sales Representative.</i>
GRILLES		<ul style="list-style-type: none"> • 5/8" Flat, 23/32" or 1" Contour GBG • 7/8", 1-1/8", 1-3/8" Full Surround Wood Grilles SDL Bead Profile: <ul style="list-style-type: none"> • 7/8", 1-1/8", 1-3/8", 2-5/16" with Light Bronze Shadow Bar • 7/8", 1-1/8", 1-3/8", 2-5/16" with Silver Shadow Bar SDL Putty Profile: <ul style="list-style-type: none"> • 5/8", 7/8", 1-1/8" with Light Bronze Shadow Bar • 5/8", 7/8", 1-1/8" with Silver Shadow Bar
HARDWARE	<ul style="list-style-type: none"> • Balance: Dual Block and Tackle • Cam Locks • Ivory Jamb Liners (standard) 	<ul style="list-style-type: none"> • White
HARDWARE COLOR	<ul style="list-style-type: none"> • White • Desert Sand • Chestnut Bronze 	<ul style="list-style-type: none"> <li style="width: 50%;">• Antique Brass <li style="width: 50%;">• Brushed Chrome <li style="width: 50%;">• Polished Brass <li style="width: 50%;">• Oil Rubbed Bronze
JAMB	<ul style="list-style-type: none"> • 4-9/16" 	<ul style="list-style-type: none"> • Minimum: 4-9/16" • Maximum: 9-5/16" (one piece) • Maximum: 12" (two piece)
SCREENS	<ul style="list-style-type: none"> • BetterVue™ 	<ul style="list-style-type: none"> • Aluminum Mesh available • Phantom Screen - Limitations apply, factory-applied • UltraVue™
SCREEN FRAME COLOR	<ul style="list-style-type: none"> <li style="width: 50%;">• Brilliant White <li style="width: 50%;">• Hartford Green <li style="width: 50%;">• Chestnut Bronze <li style="width: 50%;">• Black <li style="width: 50%;">• Desert Sand <li style="width: 50%;">• Arctic Silver <li style="width: 50%;">• French Vanilla <li style="width: 50%;">• Dark Chocolate <li style="width: 50%;">• Mesa Red 	<ul style="list-style-type: none"> <li style="width: 50%;">• Bronze <li style="width: 50%;">• Hunter Green <li style="width: 50%;">• Heirloom White <li style="width: 50%;">• Sage Brown <li style="width: 50%;">• Bone White <li style="width: 50%;">• Redwood <li style="width: 50%;">• Dark Buckskin <li style="width: 50%;">• Sea Foam <li style="width: 50%;">• Smoke <li style="width: 50%;">• Ivory <li style="width: 50%;">• Mocha Cream <li style="width: 50%;">• Cascade

GENERAL INFORMATION
DOUBLE-HUNG

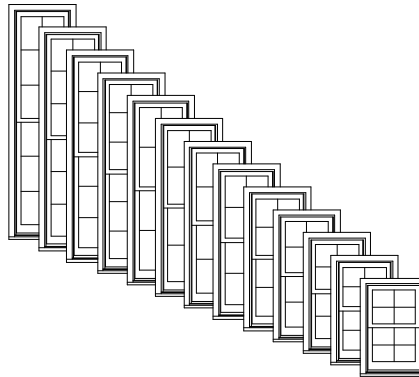

DIMENSIONAL WINDOWS

Wood double-hung windows may be specified as "dimensional" by adjusting the desired rough opening width or height in 1/4" increments from standard.

Wood double-hung windows feature fully operating upper and lower sash. Counterbalancing is achieved with block and tackle spring extension systems hidden in weatherable PVC jamb liners. Operating units are supplied with cam-type sash locks installed. Die-cast lower sash lifts supplied for field installation are an option. Recessed sash retainers provide simple sash installation and removal. There are several hardware finish options. Refer to the Specifications for available finish options.

MULTIPLE ASSEMBLIES

Wood double-hung windows may be mullied beside other wood double-hungs or wood picture windows, or below wood transom windows, to fulfill a wide variety of needs. Factory assembled mulls are limited in height (100"), width (114"), and a total area (75 square feet).

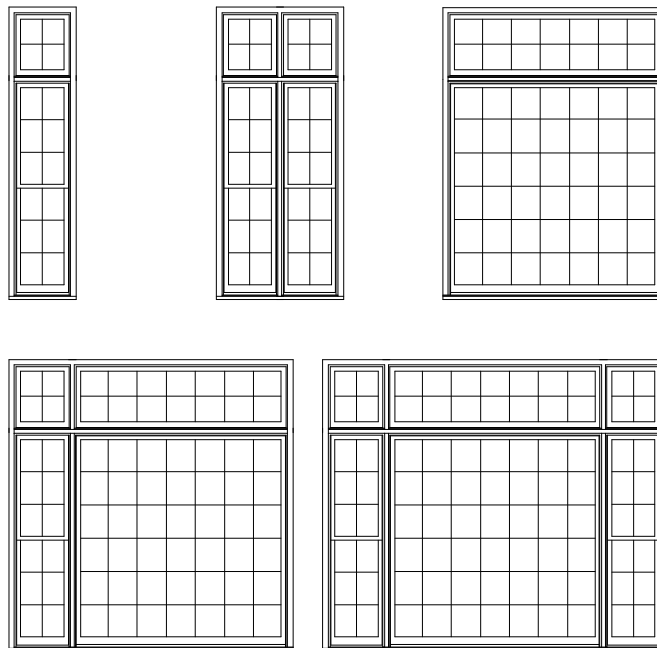

HANDING & OPERATION
DOUBLE-HUNG

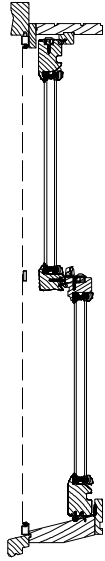

DOUBLE-HUNG OPERATION:
When the sash are locked at the check rails the sash are closed and sealed in the sash opening of the frame.

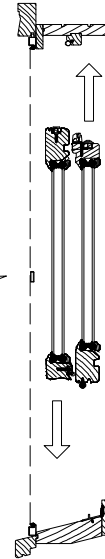

When the sash are unlocked the lower sash travels vertically to any position desired. The upper sash can also be positioned as desired.

SASH TILTING FOR WASHING

The Custom Double-Hung window will allow the sash to be tilted or removed for easy cleaning.

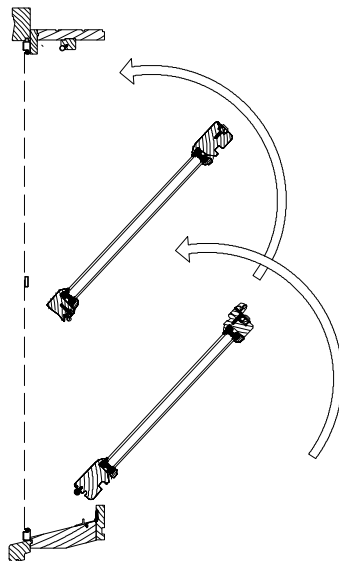

ELEVATION NOTES
DOUBLE-HUNG

ELEVATION DRAWINGS UTILIZE A LIMITED NUMBER OF PROJECTED LINES TO PRODUCE A RUDIMENTARY DRAWING INTENDED TO BE USED IN A SMALL GRAPHICAL SCALE. ELEVATIONS ARE VIEWED PERPENDICULAR FROM THE EXTERIOR OF THE STRUCTURE. IF MORE DIMENSIONS ARE NEEDED, USE THE SECTION DRAWINGS FOR MORE COMPLETE DEPICTIONS.

M.O. Brickmould
M.O. Adams/Flat Casing
Rough Opening
Frame Size
Daylight Opening

24 1/2" (622)
27 1/2" (699)
22 1/8" (562)
21 3/8" (543)
14 13/16" (376)

Masonry Openings for Brickmould, Flat & Adams Casing.
Vertical measurements include sillnose.
(Subtract 1/2" from Masonry Opening for Unit Size)

34 11/16" (881)
36 3/16" (919)
32 3/4" (832)
32" (813)
11 1/16" (281)[2]

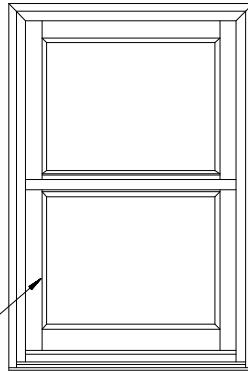

OUTSIDE OF EXTERIOR TRIM

DAYLIGHT OPENING

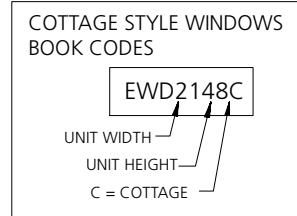

EWD2132

'EWD' INDICATES SITELINE EX WOOD DOUBLE-HUNG

BOOK CODE

THE FIRST TWO NUMBERS INDICATE THE UNIT WIDTH

THE LAST TWO NUMBERS INDICATE THE UNIT HEIGHT

GENERAL WOOD DOUBLE-HUNG NOTES

1. ALL UNITS SHOWN ARE AVAILABLE AS OPERATORS ONLY.
2. UNIT ELEVATIONS ARE SHOWN WITH BRICKMOULD & SILL NOSE.
3. ALL OPERATING SASH ARE INSTALLED WITH VINYL JAMB LINERS AND OPERATED WITH AN INTERNAL BLOCK AND TACKLE SPRING SYSTEM.
4. DIMENSIONAL VALUES IN PARENTHESES ARE MILLIMETER CONVERSIONS.
5. VALUES IN BRACKETS ARE NUMBER OF DAYLIGHT OPENINGS.

ELEVATION SYMBOL LEGEND:

MO MASONRY OPENING

1-WIDE UNITS

M.O. BRICKMOULD	24 1/2" (622)	28 1/2" (724)	32 1/2" (826)	34 1/2" (876)	36 1/2" (927)	40 1/2" (1029)	44 1/2" (1130)
M.O. ADAMS/FLAT CASING	27 1/2" (699)	31 1/2" (800)	35 1/2" (902)	37 1/2" (953)	39 1/2" (1003)	43 1/2" (1105)	47 1/2" (1207)
ROUGH OPENING	22 1/8" (562)	26 1/8" (664)	30 1/8" (765)	32 1/8" (816)	34 1/8" (867)	38 1/8" (968)	42 1/8" (1070)
FRAME SIZE	21 3/8" (543)	25 3/8" (645)	29 3/8" (746)	31 3/8" (797)	33 3/8" (848)	37 3/8" (949)	41 3/8" (1051)
DAYLIGHT OPENING	14 13/16" (376)	18 13/16" (478)	22 13/16" (579)	24 13/16" (630)	26 13/16" (681)	30 13/16" (783)	34 13/16" (884)
34 11/16" (881) 36 3/16" (919) 32 3/4" (832) 32" (813) 11 1/16" (281) 2							
38 11/16" (983) 40 3/16" (1021) 36 3/4" (933) 36" (914) 13 1/16" (332) 2							
42 11/16" (1084) 44 3/16" (1122) 40 3/4" (1035) 40" (1016) 15 1/16" (383) 2							
46 11/16" (1186) 48 3/16" (1224) 44 3/4" (1137) 44" (1118) 17 1/16" (433) 2							
50 11/16" (1287) 52 3/16" (1326) 48 3/4" (1238) 48" (1219) 19 1/16" (484) 2							
54 11/16" (1389) 56 3/16" (1427) 52 3/4" (1340) 52" (1321) 21 1/16" (535) 2							
58 11/16" (1491) 60 3/16" (1529) 56 3/4" (1441) 56" (1422) 23 1/16" (586) 2							

ELEVATION SYMBOL LEGEND:

M.O. = MASONRY OPENING
 VALUES IN () ARE IN MILLIMETER CONVERSIONS
 VALUES IN [] ARE NUMBER OF DAYLIGHT OPENINGS PER UNIT
 E UNIT MEETS EGRESS REQUIREMENTS FOR IRC CODE. STATE AND LOCAL CODES MAY DIFFER. ALWAYS REFER TO LOCAL BUILDING CODES FOR COMPLETE REQUIREMENTS. CHECK WITH LOCAL OFFICIALS TO ENSURE COMPLIANCE BEFORE INSTALLING THE UNIT.
 ### INDICATES DESIGN PRESSURE (DP) RATING WITH STANDARD GLAZING
 ###* INDICATES OPTIONAL DESIGN PRESSURE (DP) RATING

Note: Elevations shown DO NOT have exterior trim. Subtract 1/2" (12.7) from M.O. (Masonry Opening) for Unit Sizes. Masonry Openings above include Sill Nose, see Trim Options page for Sill Nose specifications. For other Trim Options refer to the Unit Sizing, Rough Opening & Masonry Openings page.

SCALE 1/4" = 1'

1-WIDE UNITS

M.O. BRICKMOULD
M.O. ADAMS/FLAT CASING
ROUGH OPENING
FRAME SIZE
DAYLIGHT OPENING

24 1/2" (622)
27 1/2" (699)
22 1/8" (562)
21 3/8" (543)
14 13/16" (376)

28 1/2" (724)
31 1/2" (800)
26 1/8" (664)
25 3/8" (645)
18 13/16" (478)

32 1/2" (826)
35 1/2" (902)
30 1/8" (765)
29 3/8" (746)
22 13/16" (579)

34 1/2" (876)
37 1/2" (953)
32 1/8" (816)
31 3/8" (797)
24 13/16" (630)

36 1/2" (927)
39 1/2" (1003)
34 1/8" (867)
33 3/8" (848)
26 13/16" (681)

40 1/2" (1029)
43 1/2" (1105)
38 1/8" (968)
37 3/8" (949)
30 13/16" (783)

44 1/2" (1130)
47 1/2" (1207)
42 1/8" (1070)
41 3/8" (1051)
34 13/16" (884)

62 11/16" (1592)
64 3/16" (1630)
60 3/4" (1543)
60" (1524)
25 1/16" (637)|2|

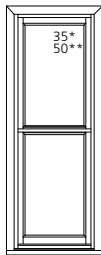

EWD2160

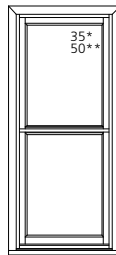

EWD2560

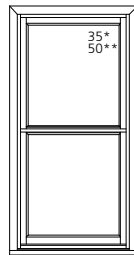

EWD2960

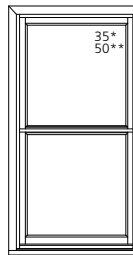

EWD3160



EWD3360



EWD3760



EWD4160

66 11/16" (1694)
68 3/16" (1732)
64 3/4" (1645)
64" (1626)
27 1/16" (687)|2|

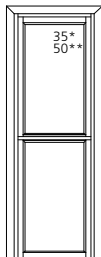

EWD2164

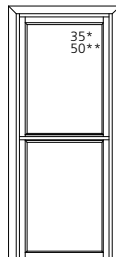

EWD2564

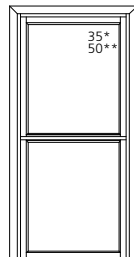

EWD2964

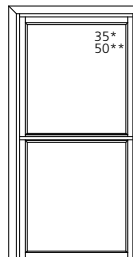

EWD3164

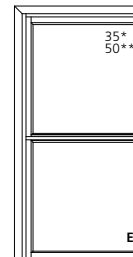

EWD3364

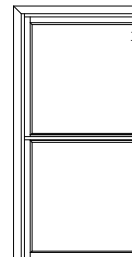

EWD3764

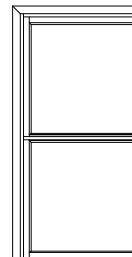

EWD4164

70 11/16" (1795)
72 3/16" (1834)
68 3/4" (1746)
68" (1727)
29 1/16" (738)|2|

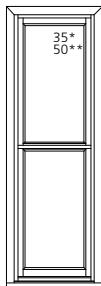

EWD2168

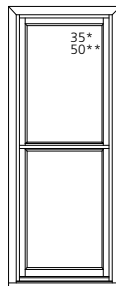

EWD2568

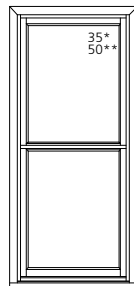

EWD2968

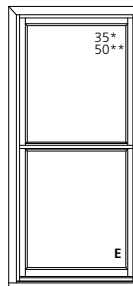

EWD3168

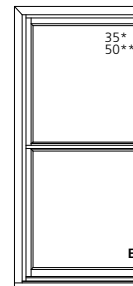

EWD3368

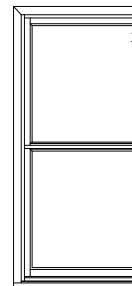

EWD3768

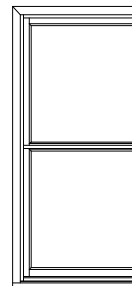

EWD4168

70 11/16" (1795)
72 3/16" (1834)
68 3/4" (1746)
68" (1727)
35 1/16" (891) 23 1/16" (586)

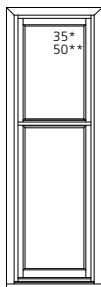

EWD2168C

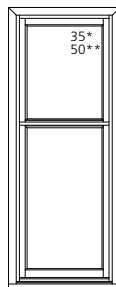

EWD2568C

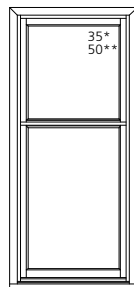

EWD2968C

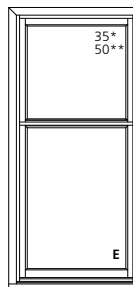

EWD3168C

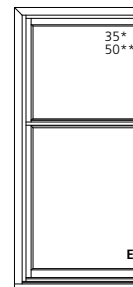

EWD3368C

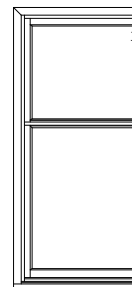

EWD3768C

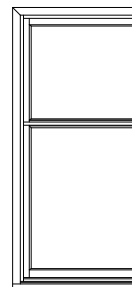

EWD4168C

74 11/16" (1897)
76 3/16" (1935)
72 3/4" (1848)
72" (1829)
31 1/16" (789)|2|

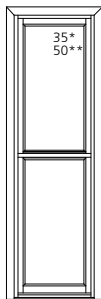

EWD2172

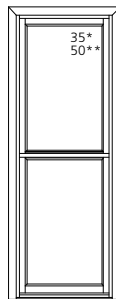

EWD2572

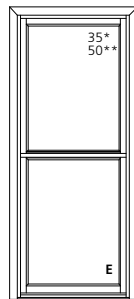

EWD2972

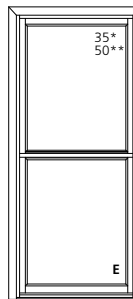

EWD3172



EWD3372



EWD3772

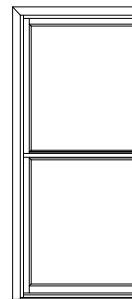

EWD4172

ELEVATION SYMBOL LEGEND:

M.O. = MASONRY OPENING
VALUES IN () ARE IN MILLIMETER CONVERSIONS
VALUES IN || ARE NUMBER OF DAYLIGHT OPENINGS PER UNIT
E UNIT MEETS EGRESS REQUIREMENTS FOR IRC CODE. STATE AND LOCAL CODES MAY DIFFER.
ALWAYS REFER TO LOCAL BUILDING CODES FOR COMPLETE REQUIREMENTS. CHECK WITH LOCAL OFFICIALS TO ENSURE COMPLIANCE BEFORE INSTALLING THE UNIT.
INDICATES DESIGN PRESSURE (DP) RATING WITH STANDARD GLAZING
###* INDICATES OPTIONAL DESIGN PRESSURE (DP) RATING

Note: Elevations shown DO NOT have exterior trim. Subtract 1/2" (12.7) from M.O. (Masonry Opening) for Unit Sizes. Masonry Openings above include Sill Nose, see Trim Options page for Sill Nose specifications. For other Trim Options refer to the Unit Sizing, Rough Opening & Masonry Openings page.

SCALE 1/4" = 1'

1-WIDE UNITS

M.O. BRICKMOULD
M.O. ADAMS/FLAT CASING
ROUGH OPENING
FRAME SIZE
DAYLIGHT OPENING

24 1/2"(622)
27 1/2"(699)
22 1/8"(562)
21 3/8"(543)
14 13/16"(376)

28 1/2"(724)
31 1/2"(800)
26 1/8"(664)
25 3/8"(645)
18 13/16"(478)

32 1/2"(826)
35 1/2"(902)
30 1/8"(765)
29 3/8"(746)
22 13/16"(579)

34 1/2"(876)
37 1/2"(953)
32 1/8"(816)
31 3/8"(797)
24 13/16"(630)

36 1/2"(927)
39 1/2"(1003)
34 1/8"(867)
33 3/8"(848)
26 13/16"(681)

40 1/2"(1029)
43 1/2"(1105)
38 1/8"(968)
37 3/8"(949)
30 13/16"(783)

44 1/2"(1130)
47 1/2"(1207)
42 1/8"(1070)
41 3/8"(1051)
34 13/16"(884)

78 11/16"(1959)
80 3/16"(2037)
76 3/4"(1949)
76"(1930)
33 1/16"(840)[2]

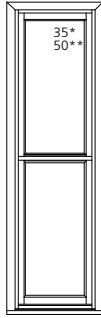

EWD2176

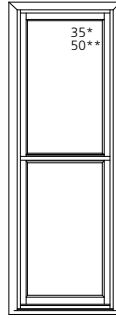

EWD2576

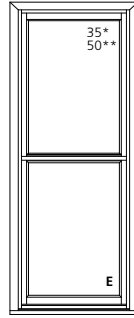

EWD2976

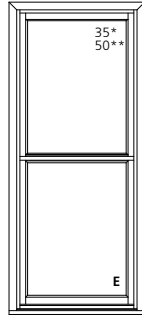

EWD3176

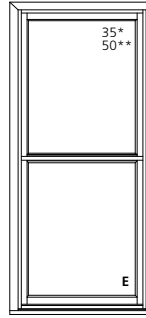

EWD3376

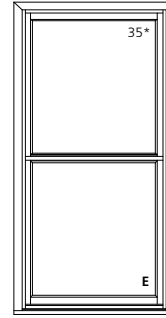

EWD3776

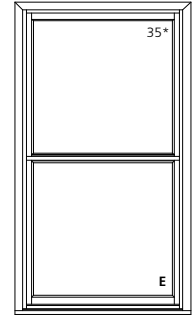

EWD4176

82 1/16"(2100)
84 3/16"(2138)
80 3/4"(2051)
80"(2032)
35 1/16"(891)[2]

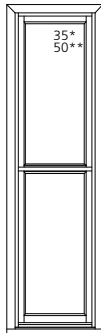

EWD2180

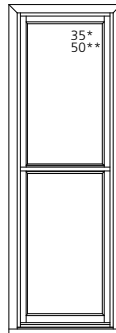

EWD2580

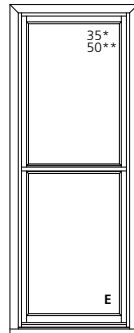

EWD2980

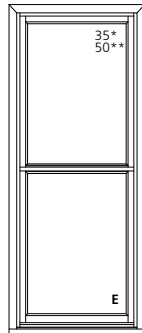

EWD3180

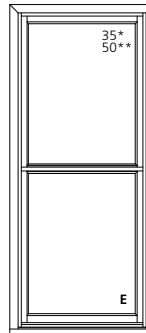

EWD3380

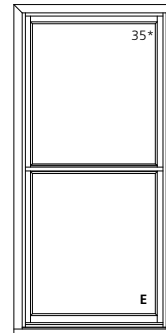

EWD3780

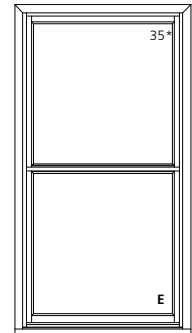

EWD4180

90 11/16"(2303)
92 3/16"(2342)
88 3/4"(2254)
88"(2235)
39 1/16"(992)[2]

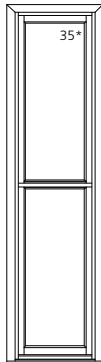

EWD2188

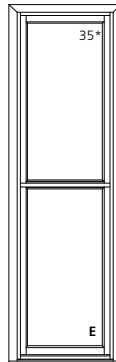

EWD2588

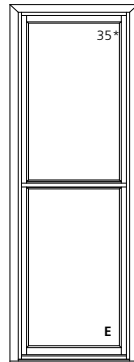

EWD2988

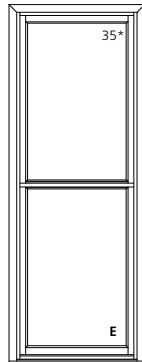

EWD3188

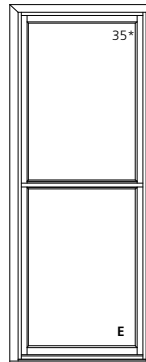

EWD3388

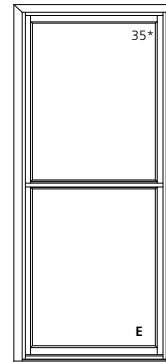

EWD3788

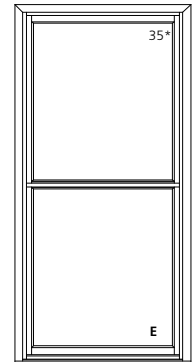

EWD4188

94 11/16"(2405)
96 3/16"(2443)
92 3/4"(2356)
92"(2337)
41 1/16"(1043)[2]

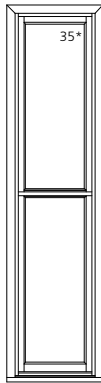

EWD2192

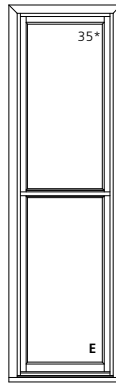

EWD2592

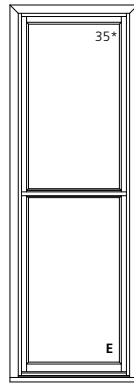

EWD2992

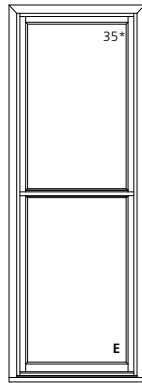

EWD3192

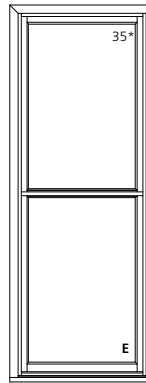

EWD3392

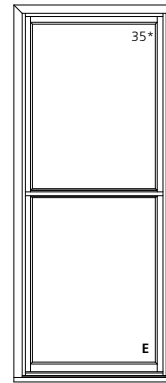

EWD3792

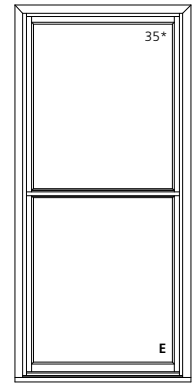

EWD4192

ELEVATION SYMBOL LEGEND:

M.O. = MASONRY OPENING
VALUES IN () ARE IN MILLIMETER CONVERSIONS
VALUES IN [] ARE NUMBER OF DAYLIGHT OPENINGS PER UNIT
E UNIT MEETS EGRESS REQUIREMENTS FOR IRC CODE. STATE AND LOCAL CODES MAY DIFFER.
ALWAYS REFER TO LOCAL BUILDING CODES FOR COMPLETE REQUIREMENTS. CHECK WITH LOCAL OFFICIALS TO ENSURE COMPLIANCE BEFORE INSTALLING THE UNIT.
##* INDICATES DESIGN PRESSURE (DP) RATING WITH STANDARD GLAZING
##** INDICATES OPTIONAL DESIGN PRESSURE (DP) RATING

Note: Elevations shown DO NOT have exterior trim. Subtract 1/2" (12.7) from M.O. (Masonry Opening) for Unit Sizes. Masonry Openings above include Sill Nose, see Trim Options page for Sill Nose specifications. For other Trim Options refer to the Unit Sizing, Rough Opening & Masonry Openings page.

SCALE 1/4" = 1'

1-WIDE UNITS

**M.O. BRICKMOULD
M.O. ADAMS/FLAT CASING
ROUGH OPENING
FRAME SIZE
DAYLIGHT OPENING**

48 1/2" (1232)
51 1/2" (1308)
46 1/8" (1172)
45 3/8" (1153)
38 13/16" (986)

34 11/16" (881)
36 3/16" (915)
37 1/2" (932)
37 1/8" (932)
11 1/16" (281/2)

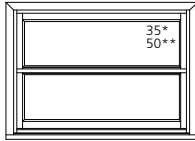

EWD4532

38 11/16" (983)
40 3/16" (1021)
39 5/8" (993)
39 5/8" (993)
13 1/16" (332/2)

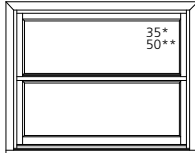

EWD4536

42 11/16" (1084)
44 3/16" (1122)
43 3/4" (1095)
40 7/16" (1016)
15 1/16" (383/2)

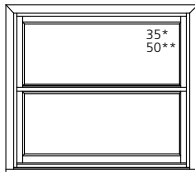

EWD4540

46 11/16" (1186)
48 3/16" (1224)
47 3/4" (1197)
44 1/8" (1118)
17 1/16" (433/2)

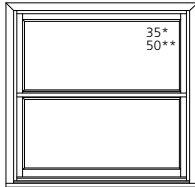

EWD4544

50 11/16" (1287)
52 3/16" (1326)
48 3/8" (1238)
48 3/8" (1238)
19 1/16" (484/2)

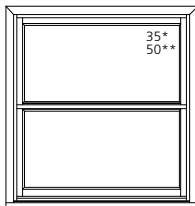

EWD4548

54 11/16" (1389)
56 3/16" (1427)
53 3/8" (1340)
52 1/2" (1321)
21 1/16" (535/2)

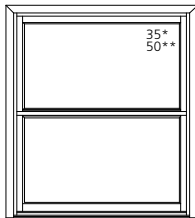

EWD4552

58 11/16" (1491)
60 3/16" (1529)
58 3/8" (1441)
56 5/8" (1422)
23 1/16" (586/2)

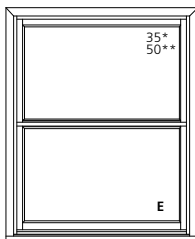

EWD4556

**M.O. BRICKMOULD
M.O. ADAMS/FLAT CASING
ROUGH OPENING
FRAME SIZE
DAYLIGHT OPENING**

48 1/2" (1232)
51 1/2" (1308)
46 1/8" (1172)
45 3/8" (1153)
38 13/16" (986)

62 11/16" (1592)
64 3/16" (1630)
60 3/4" (1543)
60" (1524)
25 1/16" (637/2)

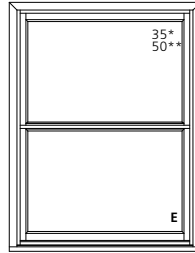

EWD4560

66 11/16" (1694)
68 3/16" (1732)
64 3/4" (1645)
64" (1626)
27 1/16" (687/2)

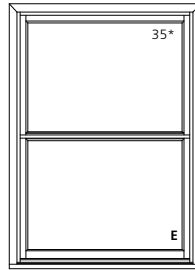

EWD4564

70 11/16" (1795)
72 3/16" (1834)
68 3/4" (1746)
68" (1727)
29 1/16" (738/2)

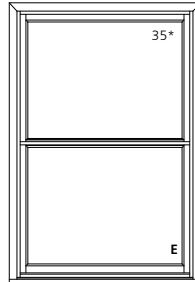

EWD4568

70 11/16" (1795)
72 3/16" (1834)
68 3/4" (1746)
68" (1727)
35 1/16" (891) 23 1/16" (586)

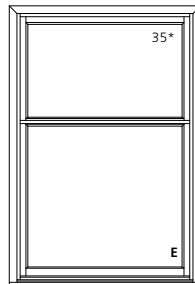

EWD4568C

74 11/16" (1897)
76 3/16" (1935)
72 3/4" (1848)
72" (1829)
31 1/16" (789/2)

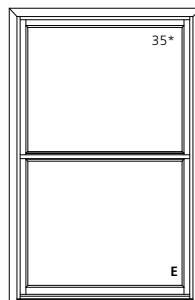

EWD4572

**M.O. BRICKMOULD
M.O. ADAMS/FLAT CASING
ROUGH OPENING
FRAME SIZE
DAYLIGHT OPENING**

48 1/2" (1232)
51 1/2" (1308)
46 1/8" (1172)
45 3/8" (1153)
38 13/16" (986)

78 11/16" (1999)
80 3/16" (2037)
76 3/4" (1949)
76" (1930)
33 1/16" (840/2)

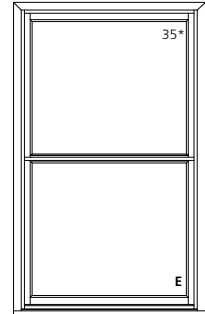

EWD4576

82 11/16" (2100)
84 3/16" (2138)
80 3/4" (2051)
80" (2032)
35 1/16" (891/2)

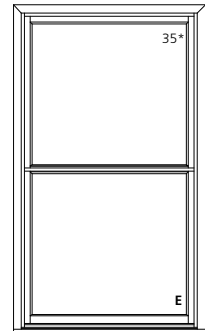

EWD4580

90 11/16" (2303)
92 3/16" (2342)
88 3/4" (2254)
88" (2235)
39 1/16" (992/2)

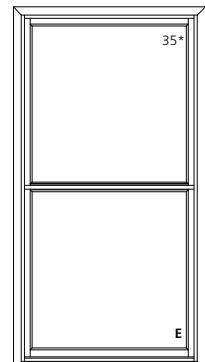

EWD4588

94 11/16" (2405)
96 3/16" (2443)
92 3/4" (2356)
92" (2337)
41 1/16" (1043/2)

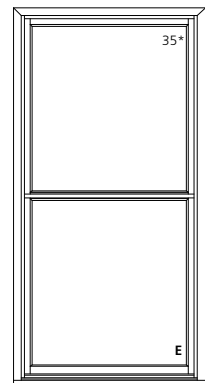

EWD4592

ELEVATION SYMBOL LEGEND:

M.O. = MASONRY OPENING
VALUES IN () ARE IN MILLIMETER CONVERSIONS
VALUES IN [] ARE NUMBER OF DAYLIGHT OPENINGS PER UNIT
E UNIT MEETS EGRESS REQUIREMENTS FOR IRC CODE. STATE AND LOCAL CODES MAY DIFFER. ALWAYS REFER TO LOCAL BUILDING CODES FOR COMPLETE REQUIREMENTS. CHECK WITH LOCAL OFFICIALS TO ENSURE COMPLIANCE BEFORE INSTALLING THE UNIT.
##* INDICATES DESIGN PRESSURE (DP) RATING WITH STANDARD GLAZING
##** INDICATES OPTIONAL DESIGN PRESSURE (DP) RATING

Note: Elevations shown DO NOT have exterior trim. Subtract 1/2" (12.7) from M.O. (Masonry Opening) for Unit Sizes. Masonry Openings above include Sill Nose, see Trim Options page for Sill Nose specifications. For other Trim Options refer to the Unit Sizing, Rough Opening & Masonry Openings page.

SCALE 1/4" = 1'

2-WIDE UNITS

M.O. BRICKMOULD M.O. ADAMS/FLAT CASING ROUGH OPENING FRAME SIZE DAYLIGHT OPENING	46 1/4" (1175) 49 1/4" (1251) 43 1/2" (1105) 42 3/4" (1086)	54 1/4" (1378) 57 1/4" (1454) 51 1/2" (1308) 50 3/4" (1289)	62 1/4" (1581) 65 1/4" (1657) 59 1/2" (1511) 58 3/4" (1492)	66 1/4" (1683) 69 1/4" (1759) 63 1/2" (1613) 62 3/4" (1594)	70 1/4" (1784) 73 1/4" (1861) 67 1/2" (1715) 66 3/4" (1695)	78 1/4" (1988) 81 1/4" (2064) 75 1/2" (1918) 74 3/4" (1899)	86 1/4" (2191) 89 1/4" (2267) 83 1/2" (2121) 82 3/4" (2102) 34 13/16" (884)[2]
34 11/16" (881) 36 3/16" (919) 33 3/4" (832) 37" (813) 11 1/16" (281)[2]							
EWD2132-2	EWD2532-2	EWD2932-2	EWD3132-2	EWD3332-2	EWD3732-2	EWD4132-2	
38 11/16" (983) 40 3/16" (1021) 36 3/4" (933) 36" (914) 13 1/16" (332)[2]							
EWD2136-2	EWD2536-2	EWD2936-2	EWD3136-2	EWD3336-2	EWD3736-2	EWD4136-2	
42 11/16" (1084) 44 3/16" (1122) 40 3/4" (1035) 40" (1016) 15 1/16" (383)[2]							
EWD2140-2	EWD2540-2	EWD2940-2	EWD3140-2	EWD3340-2	EWD3740-2	EWD4140-2	
46 11/16" (1186) 48 3/16" (1224) 44 3/4" (1137) 44" (1118) 17 1/16" (433)[2]							
EWD2144-2	EWD2544-2	EWD2944-2	EWD3144-2	EWD3344-2	EWD3744-2	EWD4144-2	
50 11/16" (1287) 52 3/16" (1325) 48 3/4" (1238) 48" (1219) 19 1/16" (484)[2]							
EWD2148-2	EWD2548-2	EWD2948-2	EWD3148-2	EWD3348-2	EWD3748-2	EWD4148-2	
54 11/16" (1389) 56 3/16" (1427) 52 3/4" (1340) 52" (1321) 21 1/16" (535)[2]							
EWD2152-2	EWD2552-2	EWD2952-2	EWD3152-2	EWD3352-2	EWD3752-2	EWD4152-2	
58 11/16" (1491) 60 3/16" (1529) 56 3/4" (1441) 56" (1422) 23 1/16" (586)[2]							
EWD2156-2	EWD2556-2	EWD2956-2	EWD3156-2	EWD3356-2	EWD3756-2	EWD4156-2	
62 11/16" (1592) 64 3/16" (1630) 60 3/4" (1543) 60" (1524) 25 1/16" (637)[2]							
EWD2160-2	EWD2560-2	EWD2960-2	EWD3160-2	EWD3360-2	EWD3760-2	EWD4160-2	
66 11/16" (1694) 68 3/16" (1732) 64 3/4" (1645) 64" (1626) 27 1/16" (687)[2]							
EWD2164-2	EWD2564-2	EWD2964-2	EWD3164-2	EWD3364-2	EWD3764-2	EWD4164-2	
70 11/16" (1795) 72 3/16" (1833) 68 3/4" (1746) 68" (1727) 29 1/16" (738)[2]							
EWD2168-2	EWD2568-2	EWD2968-2	EWD3168-2	EWD3368-2	EWD3768-2	EWD4168-2	

ELEVATION SYMBOL LEGEND:

M.O. = MASONRY OPENING
 VALUES IN () ARE IN MILLIMETER CONVERSIONS
 VALUES IN [] ARE NUMBER OF DAYLIGHT OPENINGS PER UNIT
E UNIT MEETS EGRESS REQUIREMENTS FOR IRC CODE. STATE AND LOCAL CODES MAY DIFFER.
 ALWAYS REFER TO LOCAL BUILDING CODES FOR COMPLETE REQUIREMENTS. CHECK WITH
 LOCAL OFFICIALS TO ENSURE COMPLIANCE BEFORE INSTALLING THE UNIT.

Note: Elevations shown DO NOT have exterior trim. Subtract 1/2" (12.7) from M.O. (Masonry Opening) for Unit Sizes. Masonry Openings above include Sill Nose, see Trim Options page for Sill Nose specifications. For other Trim Options refer to the Unit Sizing, Rough Opening & Masonry Openings page.

SCALE: 1/8" = 1'

2-WIDE UNITS

M.O. BRICKMOULD
M.O. ADAMS/FLAT CASING
ROUGH OPENING
FRAME SIZE
DAYLIGHT OPENING

46 1/4" (1175)	54 1/4" (1378)	62 1/4" (1581)	66 1/4" (1683)	70 1/4" (1784)	78 1/4" (1988)	86 1/4" (2191)
49 1/4" (1251)	57 1/4" (1454)	65 1/4" (1657)	69 1/4" (1759)	73 1/4" (1861)	81 1/4" (2064)	89 1/4" (2267)
43 1/2" (1105)	51 1/2" (1308)	59 1/2" (1511)	63 1/2" (1613)	67 1/2" (1715)	75 1/2" (1918)	83 1/2" (2121)
42 3/4" (1086)	50 3/4" (1289)	58 3/4" (1492)	62 3/4" (1594)	66 3/4" (1695)	74 3/4" (1899)	82 3/4" (2102)
14 13/16" (376)[2]	18 13/16" (478)[2]	22 13/16" (579)[2]	24 13/16" (630)[2]	26 13/16" (681)[2]	30 13/16" (783)[2]	34 13/16" (884)[2]

70 11/16" (1795)
72 3/16" (1834)
68 3/4" (1746)
68" (1727)
35 1/16" (891) 23 1/16" (586)

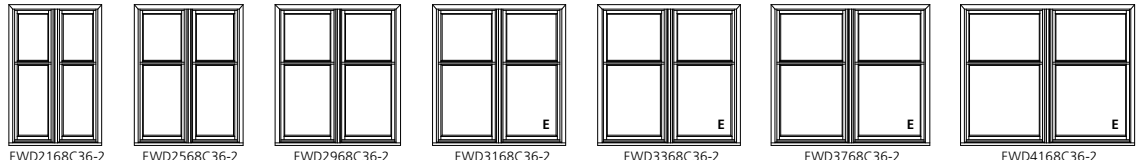

74 11/16" (1897)
76 3/16" (1935)
72 3/4" (1848)
72" (1829)
31 1/16" (789)[2]

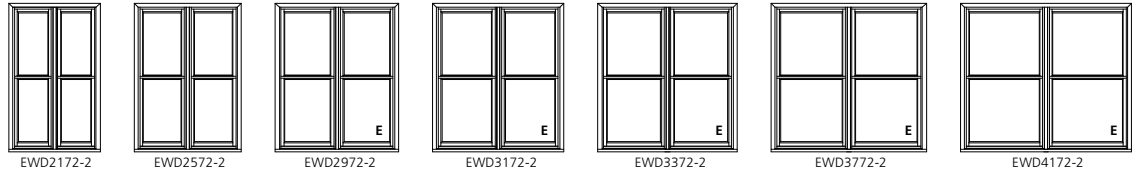

78 11/16" (1999)
80 3/16" (2037)
76 3/4" (1949)
76" (1930)
33 1/16" (840)[2]

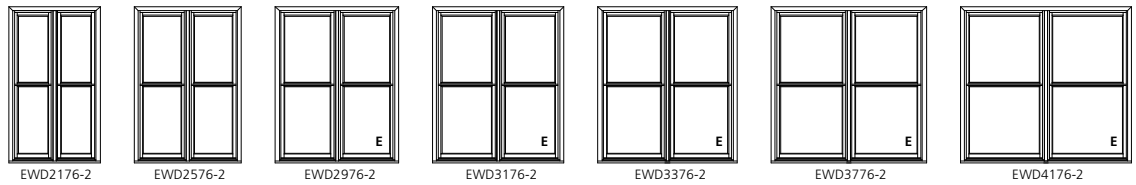

82 11/16" (2100)
84 3/16" (2138)
80 3/4" (2051)
80" (2032)
35 1/16" (891)[2]

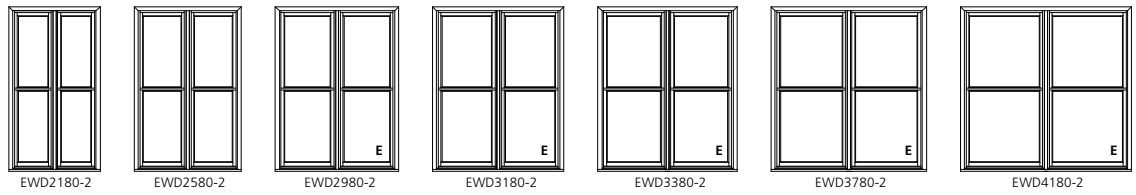

90 11/16" (2303)
92 3/16" (2342)
88 3/4" (2254)
88" (2235)
39 1/16" (992)[2]

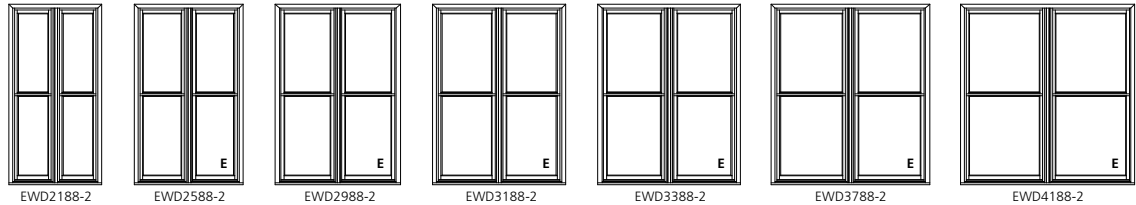

94 11/16" (2405)
96 3/16" (2443)
92 3/4" (2356)
92" (2337)
41 1/16" (1043)[2]

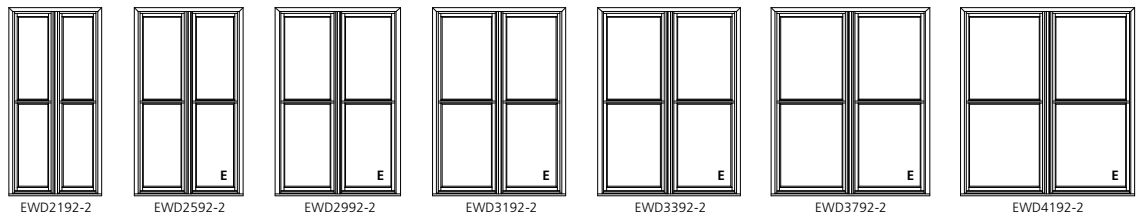

ELEVATION SYMBOL LEGEND:

M.O. = MASONRY OPENING
VALUES IN () ARE IN MILLIMETER CONVERSIONS
VALUES IN [] ARE NUMBER OF DAYLIGHT OPENINGS PER UNIT
E UNIT MEETS EGRESS REQUIREMENTS FOR IRC CODE. STATE AND LOCAL CODES MAY DIFFER.
ALWAYS REFER TO LOCAL BUILDING CODES FOR COMPLETE REQUIREMENTS. CHECK WITH LOCAL OFFICIALS TO ENSURE COMPLIANCE BEFORE INSTALLING THE UNIT.

Note: Elevations shown DO NOT have exterior trim. Subtract 1/2" (12.7) from M.O. (Masonry Opening) for Unit Sizes. Masonry Openings above include Sill Nose, see Trim Options page for Sill Nose specifications. For other Trim Options refer to the Unit Sizing, Rough Opening & Masonry Openings page.

SCALE: 1/8" = 1'

2-WIDE UNITS

M.O. BRICKMOULD
M.O. ADAMS/FLAT CASING
ROUGH OPENING
FRAME SIZE
DAYLIGHT OPENING

94 1/4" (2394)
97 1/4" (2470)
91 1/2" (2324)
90 3/4" (2305)
38 13/16" (986) [2]

34 11/16" (881)
36 3/16" (919)
32 3/4" (832)
32" (813)
36" (914)
38 11/16" (983)
40 3/16" (1021)
36 3/4" (933)
36" (914)
42 11/16" (1084)
44 3/16" (1122)
40 3/4" (1035)
40" (1016)
46 11/16" (1186)
48 3/16" (1224)
44 3/4" (1137)
44" (1118)
50 11/16" (1287)
52 3/16" (1325)
48 3/4" (1238)
48" (1219)
54 11/16" (1389)
56 3/16" (1427)
52 3/4" (1340)
52" (1321)
58 11/16" (1491)
60 3/16" (1529)
56 3/4" (1441)
56" (1422)
62 11/16" (1592)
64 3/16" (1630)
60 3/4" (1543)
60" (1524)
66 11/16" (1694)
68 3/16" (1732)
64 3/4" (1645)
64" (1626)
70 11/16" (1795)
72 3/16" (1834)
68 3/4" (1746)
68" (1727)
29 1/16" (738) [2]

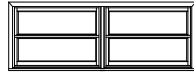

EWD4532-2



EWD4536-2



EWD4540-2



EWD4544-2



EWD4548-2



EWD4552-2



EWD4556-2



EWD4560-2



EWD4564-2



EWD4568-2



EWD4572-2



EWD4576-2



EWD4580-2

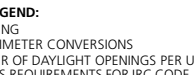

EWD4584-2

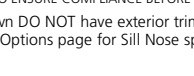

EWD4588-2



EWD4592-2

M.O. BRICKMOULD
M.O. ADAMS/FLAT CASING
ROUGH OPENING
FRAME SIZE
DAYLIGHT OPENING

94 1/4" (2394)
97 1/4" (2470)
91 1/2" (2324)
90 3/4" (2305)
38 13/16" (986) [2]

70 11/16" (1795)
72 3/16" (1834)
68 3/4" (1746)
68" (1727)
35 1/16" (891) 23 1/16" (586)
74 11/16" (1897)
76 3/16" (1935)
72 3/4" (1848)
72" (1829)
31 1/16" (789) [2]
78 11/16" (1999)
80 3/16" (2037)
76 3/4" (1949)
76" (1930)
33 1/16" (840) [2]
82 11/16" (2100)
84 3/16" (2138)
80 3/4" (2051)
80" (2032)
35 1/16" (891) [2]
90 11/16" (2303)
92 3/16" (2342)
88 3/4" (2254)
88" (2235)
39 1/16" (992) [2]
94 11/16" (2405)
96 3/16" (2443)
92 3/4" (2356)
92" (2337)
41 1/16" (1043) [2]

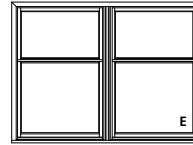

EWD4568C36-2

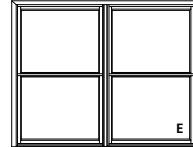

EWD4572-2

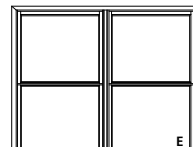

EWD4576-2

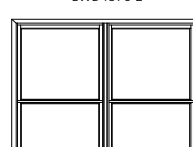

EWD4580-2

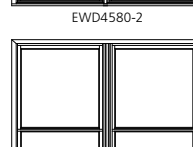

EWD4584-2



EWD4588-2

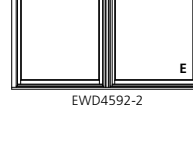

EWD4592-2

ELEVATION SYMBOL LEGEND:

M.O. = MASONRY OPENING
VALUES IN () ARE IN MILLIMETER CONVERSIONS
VALUES IN [] ARE NUMBER OF DAYLIGHT OPENINGS PER UNIT
E UNIT MEETS EGRESS REQUIREMENTS FOR IRC CODE. STATE AND LOCAL CODES MAY DIFFER.
ALWAYS REFER TO LOCAL BUILDING CODES FOR COMPLETE REQUIREMENTS. CHECK WITH LOCAL OFFICIALS TO ENSURE COMPLIANCE BEFORE INSTALLING THE UNIT.

Note: Elevations shown DO NOT have exterior trim. Subtract 1/2" (12.7) from M.O. (Masonry Opening) for Unit Sizes. Masonry Openings above include Sill Nose, see Trim Options page for Sill Nose specifications. For other Trim Options refer to the Unit Sizing, Rough Opening & Masonry Openings page.

SCALE: 1/8" = 1'

3-WIDE UNITS

M.O. BRICKMOUND M.O. ADAMS/FLAT CASING ROUGH OPENING FRAME SIZE DAYLIGHT OPENING	67 5/8" (1718) 70 5/8" (1794) 64 7/8" (1648) 64 1/4" (1632) 14 13/16" (376)[3]	79 5/8" (2022) 82 5/8" (2099) 76 7/8" (1953) 76 1/4" (1937) 18 13/16" (478)[3]	91 5/8" (2327) 94 5/8" (2403) 88 7/8" (2257) 88 1/4" (2242) 22 13/16" (579)[3]	97 5/8" (2480) 100 5/8" (2556) 94 7/8" (2410) 94 1/4" (2394) 24 13/16" (630)[3]	103 5/8" (2632) 106 5/8" (2708) 100 7/8" (2562) 100 1/4" (2546) 26 13/16" (681)[3]
34 11/16" (881) 36 3/16" (919) 32 3/4" (832) 32" (813) 11 1/16" (281)[2]					
38 11/16" (983) 40 3/16" (1021) 36 3/4" (933) 36" (914) 13 1/16" (332)[2]					
42 11/16" (1084) 44 3/16" (1122) 40 3/4" (1035) 40" (1016) 15 1/16" (383)[2]					
46 11/16" (1186) 48 3/16" (1224) 44 3/4" (1137) 44" (1118) 17 1/16" (433)[2]					
50 11/16" (1287) 52 3/16" (1326) 48 3/4" (1238) 48" (1219) 19 1/16" (484)[2]					
54 11/16" (1389) 56 3/16" (1427) 52 3/4" (1340) 52" (1321) 21 1/16" (535)[2]					
58 11/16" (1491) 60 3/16" (1529) 56 3/4" (1441) 56" (1422) 23 1/16" (586)[2]					
62 11/16" (1592) 64 3/16" (1630) 60 3/4" (1543) 60" (1524) 25 1/16" (637)[2]					
66 11/16" (1694) 68 3/16" (1732) 64 3/4" (1645) 64" (1626) 27 1/16" (687)[2]					
70 11/16" (1795) 72 3/16" (1834) 68 3/4" (1746) 68" (1727) 29 1/16" (738)[2]					

ELEVATION SYMBOL LEGEND:

- M.O.** = MASONRY OPENING
- VALUES IN () ARE IN MILLIMETER CONVERSIONS
- VALUES IN [] ARE NUMBER OF DAYLIGHT OPENINGS PER UNIT
- E** UNIT MEETS EGRESS REQUIREMENTS FOR IRC CODE. STATE AND LOCAL CODES MAY DIFFER. ALWAYS REFER TO LOCAL BUILDING CODES FOR COMPLETE REQUIREMENTS. CHECK WITH LOCAL OFFICIALS TO ENSURE COMPLIANCE BEFORE INSTALLING THE UNIT.

Note: Elevations shown DO NOT have exterior trim. Subtract 1/2" (12.7) from M.O. (Masonry Opening) for Unit Sizes. Masonry Openings above include Sill Nose, see Trim Options page for Sill Nose specifications. For other Trim Options refer to the Unit Sizing, Rough Opening & Masonry Openings page.

SCALE: 1/8" = 1'

3-WIDE UNITS

M.O. BRICKMOUND
M.O. ADAMS/FLAT CASING
ROUGH OPENING
FRAME SIZE
DAYLIGHT OPENING

67 5/8" (1718)
70 5/8" (1794)
64 7/8" (1648)
64 1/4" (1632)
14 13/16" (376)[3]

79 5/8" (2022)
82 5/8" (2099)
76 7/8" (1953)
76 1/4" (1937)
18 13/16" (478)[3]

91 5/8" (2327)
94 5/8" (2403)
88 7/8" (2257)
88 1/4" (2242)
22 13/16" (579)[3]

97 5/8" (2480)
100 5/8" (2556)
94 7/8" (2410)
94 1/4" (2394)
24 13/16" (630)[3]

103 5/8" (2632)
106 5/8" (2708)
100 7/8" (2562)
100 1/4" (2546)
26 13/16" (681)[3]

70 11/16" (1795)
72 3/16" (1834)
68 3/4" (1746)
68" (1727)
35 1/16" (891) 23 1/16" (586)

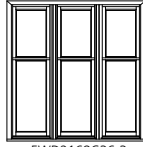

EWD2168C36-3

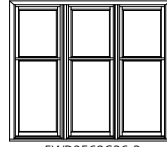

EWD2568C36-3

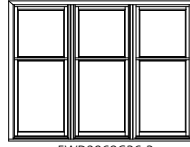

EWD2968C36-3

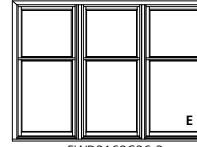

EWD3168C36-3

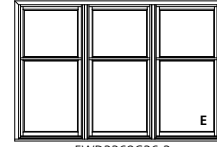

EWD3368C36-3

74 11/16" (1897)
76 3/16" (1935)
72 3/4" (1848)
72" (1829)
31 1/16" (789)[2]

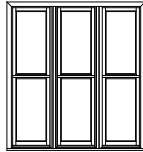

EWD2172-3

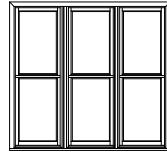

EWD2572-3

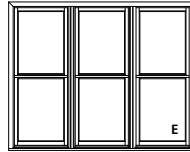

EWD2972-3

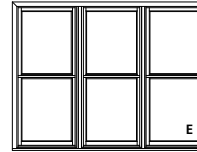

EWD3172-3

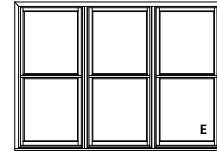

EWD3372-3

78 11/16" (1999)
80 3/16" (2037)
76 3/4" (1949)
76" (1930)
33 1/16" (840)[2]

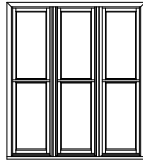

EWD2176-3

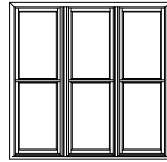

EWD2576-3

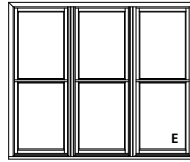

EWD2976-3

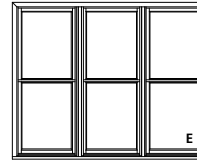

EWD3176-3

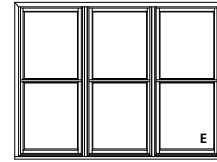

EWD3376-3

82 11/16" (2100)
84 3/16" (2138)
80 3/4" (2051)
80" (2032)
35 1/16" (891)[2]

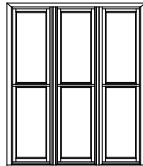

EWD2180-3

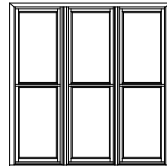

EWD2580-3

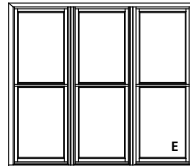

EWD2980-3

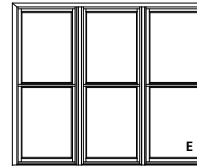

EWD3180-3

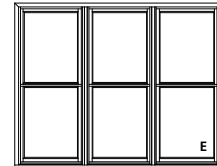

EWD3380-3

90 11/16" (2303)
92 3/16" (2342)
88 3/4" (2254)
88" (2235)
39 1/16" (992)[2]

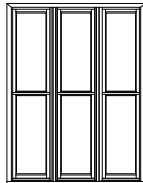

EWD2188-3

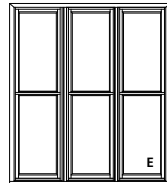

EWD2588-3

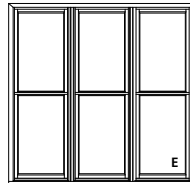

EWD2988-3

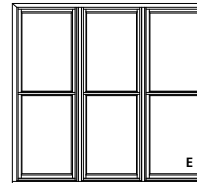

EWD3188-3

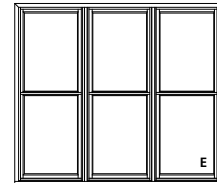

EWD3388-3

94 11/16" (2405)
96 3/16" (2443)
92 3/4" (2356)
92" (2337)
41 1/16" (1043)[2]

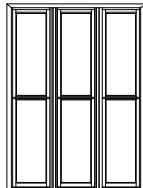

EWD2192-3

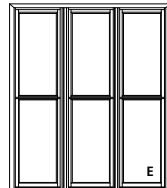

EWD2592-3

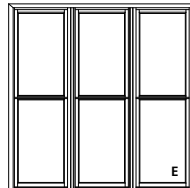

EWD2992-3

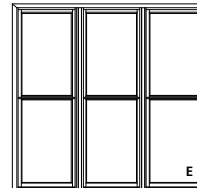

EWD3192-3

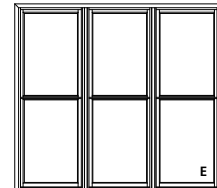

EWD3392-3

ELEVATION SYMBOL LEGEND:

M.O. = MASONRY OPENING
VALUES IN () ARE IN MILLIMETER CONVERSIONS
VALUES IN [] ARE NUMBER OF DAYLIGHT OPENINGS PER UNIT
E UNIT MEETS EGRESS REQUIREMENTS FOR IRC CODE. STATE AND LOCAL CODES MAY DIFFER. ALWAYS REFER TO LOCAL BUILDING CODES FOR COMPLETE REQUIREMENTS. CHECK WITH LOCAL OFFICIALS TO ENSURE COMPLIANCE BEFORE INSTALLING THE UNIT.

Note: Elevations shown DO NOT have exterior trim. Subtract 1/2" (12.7) from M.O. (Masonry Opening) for Unit Sizes. Masonry Openings above include Sill Nose, see Trim Options page for Sill Nose specifications. For other Trim Options refer to the Unit Sizing, Rough Opening & Masonry Openings page.

SCALE: 1/8" = 1'

3-WIDE UNITS

M.O. BRICKMOULD
M.O. ADAMS/FLAT CASING
ROUGH OPENING
FRAME SIZE
DAYLIGHT OPENING

115 5/8" (2937)
118 5/8" (3013)
112 7/8" (2867)
112 1/4" (2851)
30 13/16" (783)[3]

127 5/8" (3242)
130 5/8" (3318)
124 7/8" (3172)
124 1/4" (3156)
34 13/16" (884)[3]

139 5/8" (3546)
142 5/8" (3623)
136 7/8" (3477)
136 1/4" (3461)
38 13/16" (986)[23]

34 11/16" (881) 36 3/16" (915) 32 3/4" (832) 32 7/8" (813)
38 11/16" (983) 40 3/16" (1021) 36 3/4" (933) 36 (914) 13 1/16" (332)[2] 11 1/16" (281)[2]
42 11/16" (1084) 44 3/16" (1122) 40 3/4" (1035) 40 (1016) 15 1/16" (383)[2]
46 11/16" (1186) 48 3/16" (1224) 44 3/4" (1137) 44 (1118) 17 1/16" (435)[2]
50 11/16" (1287) 52 3/16" (1326) 48 3/4" (1238) 48 (1219) 19 1/16" (489)[2]
54 11/16" (1389) 56 3/16" (1427) 52 3/4" (1340) 52 (1321) 21 1/16" (535)[2]
58 11/16" (1491) 60 3/16" (1529) 56 3/4" (1441) 56 (1422) 23 1/16" (586)[2]
62 11/16" (1592) 64 3/16" (1630) 60 3/4" (1543) 60 (1524) 25 1/16" (637)[2]
66 11/16" (1694) 68 3/16" (1732) 64 3/4" (1645) 64 (1626) 27 1/16" (687)[2]
70 11/16" (1795) 72 3/16" (1834) 68 3/4" (1746) 68 (1727) 29 1/16" (738)[2]

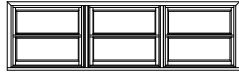

EWD3732-3

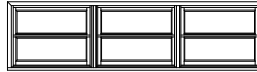

EWD4132-3

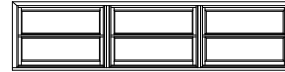

EWD4532-3



EWD3736-3



EWD4136-3



EWD4536-3



EWD3740-3



EWD4140-3



EWD4540-3



EWD3744-3

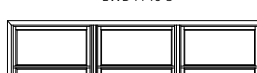

EWD4144-3



EWD4544-3



EWD3748-3

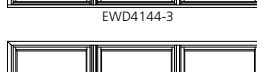

EWD4148-3



EWD4548-3

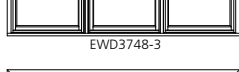

EWD3752-3

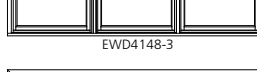

EWD4152-3



EWD4552-3



EWD3756-3



EWD4156-3



EWD4556-3



EWD3760-3

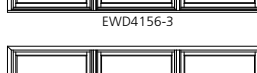

EWD4160-3



EWD4560-3



EWD3764-3



EWD4164-3



EWD4564-3



EWD3768-3



EWD4168-3



EWD4568-3

ELEVATION SYMBOL LEGEND:

M.O. = MASONRY OPENING
VALUES IN () ARE IN MILLIMETER CONVERSIONS
VALUES IN [] ARE NUMBER OF DAYLIGHT OPENINGS PER UNIT
E UNIT MEETS EGRESS REQUIREMENTS FOR IRC CODE. STATE AND LOCAL CODES MAY DIFFER. ALWAYS REFER TO LOCAL BUILDING CODES FOR COMPLETE REQUIREMENTS. CHECK WITH LOCAL OFFICIALS TO ENSURE COMPLIANCE BEFORE INSTALLING THE UNIT.

Note: Elevations shown DO NOT have exterior trim. Subtract 1/2" (12.7) from M.O. (Masonry Opening) for Unit Sizes. Masonry Openings above include Sill Nose, see Trim Options page for Sill Nose specifications. For other Trim Options refer to the Unit Sizing, Rough Opening & Masonry Openings page.

SCALE: 1/8" = 1'

3-WIDE UNITS

M.O. BRICKMOUND
M.O. ADAMS/FLAT CASING
ROUGH OPENING
FRAME SIZE
DAYLIGHT OPENING

115 5/8" (2937)
118 5/8" (3013)
112 7/8" (2867)
112 1/4" (2851)
30 13/16" (783)[3]

127 5/8" (3242)
130 5/8" (3318)
124 7/8" (3172)
124 1/4" (3156)
34 13/16" (884)[3]

139 5/8" (3546)
142 5/8" (3623)
136 7/8" (3477)
136 1/4" (3461)
38 13/16" (986)[23]

70 11/16" (1795)
72 3/16" (1834)
68 3/4" (1746)
68" (1727)
35 1/16" (891) 23 1/16" (586)

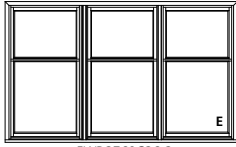

EWD3768C36-3

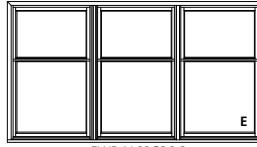

EWD4168C36-3

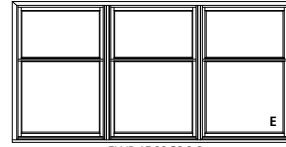

EWD4568C36-3

74 11/16" (1887)
76 3/16" (1935)
72 3/4" (1848)
72" (1829)
31 1/16" (789)[2]

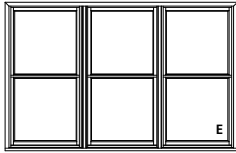

EWD3772-3

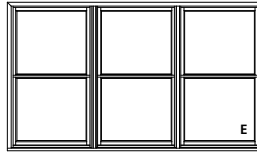

EWD4172-3

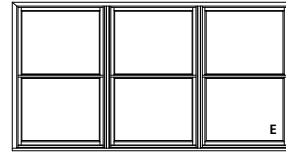

EWD4572-3

78 11/16" (1999)
80 3/16" (2037)
76 3/4" (1949)
76" (1930)
33 1/16" (840)[2]

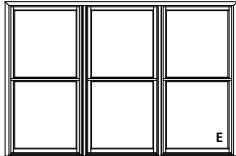

EWD3776-3

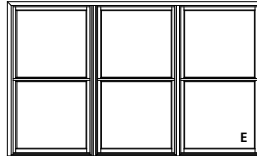

EWD4176-3

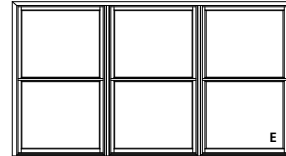

EWD4576-3

82 11/16" (2100)
84 3/16" (2138)
80 3/4" (2051)
80" (2032)
35 1/16" (891)[2]

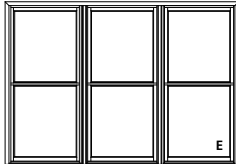

EWD3780-3

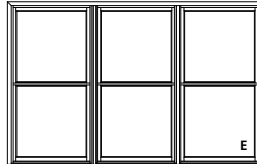

EWD4180-3

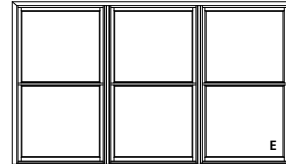

EWD4580-3

90 11/16" (2303)
92 3/16" (2342)
88 3/4" (2254)
88" (2235)
39 1/16" (992)[2]

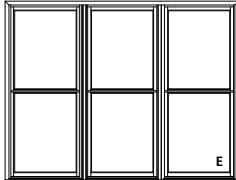

EWD3788-3

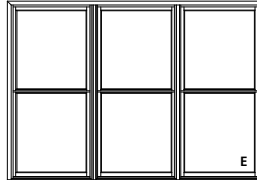

EWD4188-3

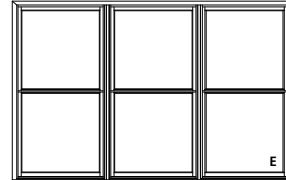

EWD4588-3

94 11/16" (2405)
96 3/16" (2443)
92 3/4" (2356)
92" (2337)
41 1/16" (1043)[2]

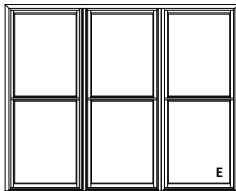

EWD3792-3

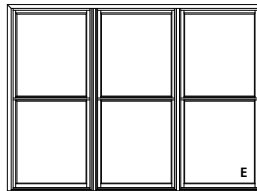

EWD4192-3

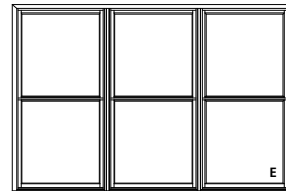

EWD4592-3

ELEVATION SYMBOL LEGEND:

M.O. = MASONRY OPENING
VALUES IN () ARE IN MILLIMETER CONVERSIONS
VALUES IN [] ARE NUMBER OF DAYLIGHT OPENINGS PER UNIT
E UNIT MEETS EGRESS REQUIREMENTS FOR IRC CODE. STATE AND LOCAL CODES MAY DIFFER.
ALWAYS REFER TO LOCAL BUILDING CODES FOR COMPLETE REQUIREMENTS. CHECK WITH LOCAL OFFICIALS TO ENSURE COMPLIANCE BEFORE INSTALLING THE UNIT.

Note: Elevations shown DO NOT have exterior trim. Subtract 1/2" (12.7) from M.O. (Masonry Opening) for Unit Sizes. Masonry Openings above include Sill Nose, see Trim Options page for Sill Nose specifications. For other Trim Options refer to the Unit Sizing, Rough Opening & Masonry Openings page.

SCALE: 1/8" = 1'

ELEVATION NOTES
DOUBLE-HUNG PICTURE

ELEVATION DRAWINGS UTILIZE A LIMITED NUMBER OF PROJECTED LINES TO PRODUCE A RUDIMENTARY DRAWING INTENDED TO BE USED IN A SMALL GRAPHICAL SCALE. ELEVATIONS ARE VIEWED PERPENDICULAR FROM THE EXTERIOR OF THE STRUCTURE. IF MORE DIMENSIONS ARE NEEDED, USE THE SECTION DRAWINGS FOR MORE COMPLETE DEPICTIONS.

M.O. Brickmould
M.O. Adams/Flat Casing
Rough Opening
Frame Size
Daylight Opening

36 1/2" (927)
39 1/2" (1003)
34 1/8" (867)
33 3/8" (848)
26 13/16" (681)

Masonry Openings for Brickmould, Flat & Adams Casing.
Vertical measurements include sillnose.
(Subtract 1/2" from Masonry Opening for Unit Size)

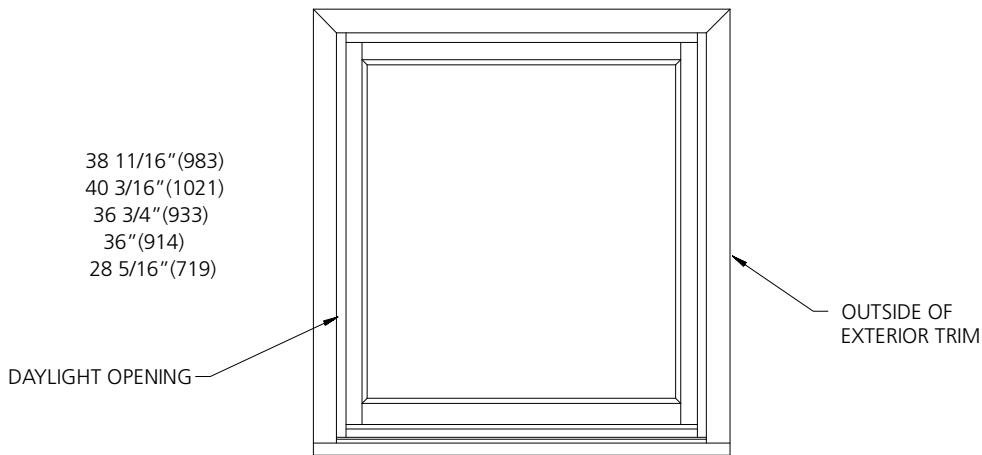

EWDP3336

'EWDP' INDICATES
SITELINE EX WOOD DH PICTURE

BOOK CODE

THE FIRST TWO NUMBERS
INDICATE THE UNIT WIDTH

THE LAST TWO NUMBERS INDICATE
THE UNIT HEIGHT











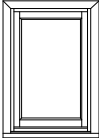
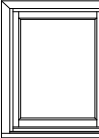





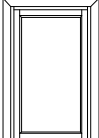
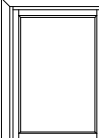
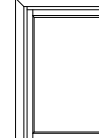

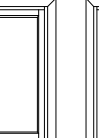
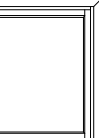
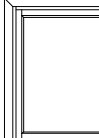
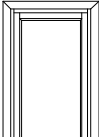
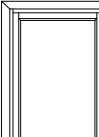
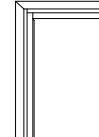

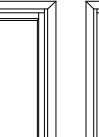
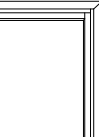
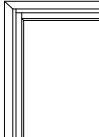
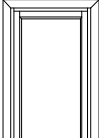
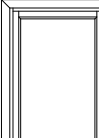
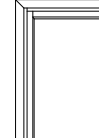

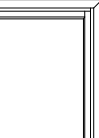

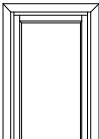
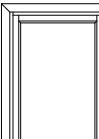





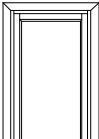
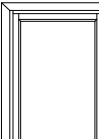

GENERAL DOUBLE-HUNG PICTURE NOTES

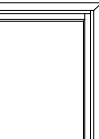
1. ALL UNITS SHOWN ARE AVAILABLE AS OPERATORS ONLY.
2. UNIT ELEVATIONS ARE SHOWN WITH BRICKMOULD & SILL NOSE.
3. DIMENSIONAL VALUES IN PARENTHESES ARE MILLIMETER CONVERSIONS.

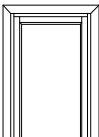
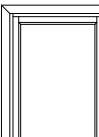
ELEVATION SYMBOL LEGEND:

MO MASONRY OPENING

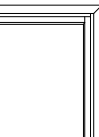
PICTURE UNITS

M.O. BRICKMOULD	24 1/2" (622)	28 1/2" (724)	32 1/2" (826)	34 1/2" (876)	36 1/2" (927)	40 1/2" (1029)	44 1/2" (1130)
M.O. ADAMS/FLAT CASING	27 1/2" (699)	31 1/2" (800)	35 1/2" (902)	37 1/2" (953)	39 1/2" (1003)	43 1/2" (1105)	47 1/2" (1207)
ROUGH OPENING	22 1/8" (562)	26 1/8" (664)	30 1/8" (765)	32 1/8" (816)	34 1/8" (867)	38 1/8" (968)	42 1/8" (1070)
FRAME SIZE	21 3/8" (543)	25 3/8" (645)	29 3/8" (746)	31 3/8" (797)	33 3/8" (848)	37 3/8" (949)	41 3/8" (1051)
DAYLIGHT OPENING	14 13/16" (376)	18 13/16" (478)	22 13/16" (579)	24 13/16" (630)	26 13/16" (681)	30 13/16" (783)	34 13/16" (884)
34 11/16" (881) 36 3/16" (919) 32 3/4" (832) 32" (813) 24 5/16" (618)							
EWDP2132	EWDP2532	EWDP2932	EWDP3132	EWDP3332	EWDP3732	EWDP4132	
38 11/16" (983) 40 3/16" (1021) 36 3/4" (933) 36" (914) 28 5/16" (719)							
EWDP2136	EWDP2536	EWDP2936	EWDP3136	EWDP3336	EWDP3736	EWDP4136	
42 11/16" (1084) 44 3/16" (1122) 40 3/4" (1035) 40" (1016) 32 5/16" (821)							
EWDP2140	EWDP2540	EWDP2940	EWDP3140	EWDP3340	EWDP3740	EWDP4140	
46 11/16" (1186) 48 3/16" (1224) 44 3/4" (1137) 44" (1118) 36 5/16" (922)							
EWDP2144	EWDP2544	EWDP2944	EWDP3144	EWDP3344	EWDP3744	EWDP4144	
50 11/16" (1287) 52 3/16" (1326) 48 3/4" (1238) 48" (1219) 40 5/16" (1024)							
EWDP2148	EWDP2548	EWDP2948	EWDP3148	EWDP3348	EWDP3748	EWDP4148	
54 11/16" (1389) 56 3/16" (1427) 52 3/4" (1340) 52" (1321) 44 5/16" (1126)							
EWDP2152	EWDP2552	EWDP2952	EWDP3152	EWDP3352	EWDP3752	EWDP4152	
58 11/16" (1491) 60 3/16" (1529) 56 3/4" (1441) 56" (1422) 48 5/16" (1227)							
EWDP2156	EWDP2556	EWDP2956	EWDP3156	EWDP3356	EWDP3756	EWDP4156	

ELEVATION SYMBOL LEGEND:
M.O. = MASONRY OPENING
VALUES IN () ARE IN MILLIMETER CONVERSIONS

Note: Elevations shown DO NOT have exterior trim. Subtract 1/2" (12.7) from M.O. (Masonry Opening) for Unit Sizes. Masonry Openings above include Sill Nose, see Trim Options page for Sill Nose specifications. For other Trim Options refer to the Unit Sizing, Rough Opening & Masonry Openings page.

SCALE 1/4" = 1'

PICTURE UNITS

M.O. BRICKMOULD
M.O. ADAMS/FLAT CASING
ROUGH OPENING
FRAME SIZE
DAYLIGHT OPENING

24 1/2" (622)	28 1/2" (724)	32 1/2" (826)	34 1/2" (876)	36 1/2" (927)	40 1/2" (1029)	44 1/2" (1130)
27 1/2" (699)	31 1/2" (800)	35 1/2" (902)	37 1/2" (953)	39 1/2" (1003)	43 1/2" (1105)	47 1/2" (1207)
22 1/8" (562)	26 1/8" (664)	30 1/8" (765)	32 1/8" (816)	34 1/8" (867)	38 1/8" (968)	42 1/8" (1070)
21 3/8" (543)	25 3/8" (645)	29 3/8" (746)	31 3/8" (797)	33 3/8" (848)	37 3/8" (949)	41 3/8" (1051)
14 13/16" (376)	18 13/16" (478)	22 13/16" (579)	24 13/16" (630)	26 13/16" (681)	30 13/16" (783)	34 13/16" (884)

62 11/16" (1592)
64 3/16" (1630)
60 3/4" (1543)
60" (1524)
52 5/16" (1329)

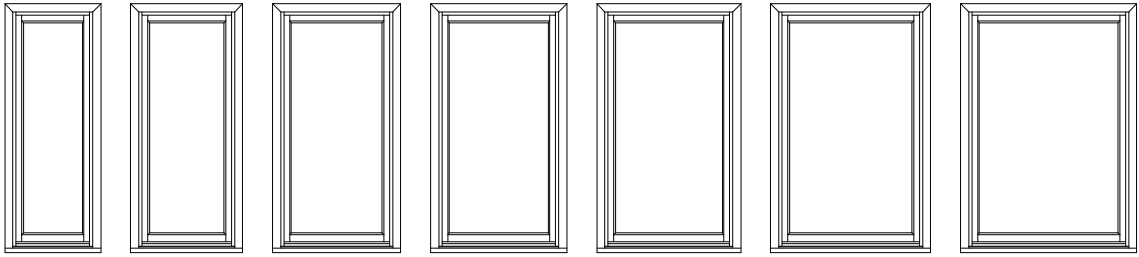

EWDP2160 EWDP2560 EWDP2960 EWDP3160 EWDP3360 EWDP3760 EWDP4160

66 11/16" (1694)
68 3/16" (1732)
64 3/4" (1645)
64" (1626)
56 5/16" (1430)

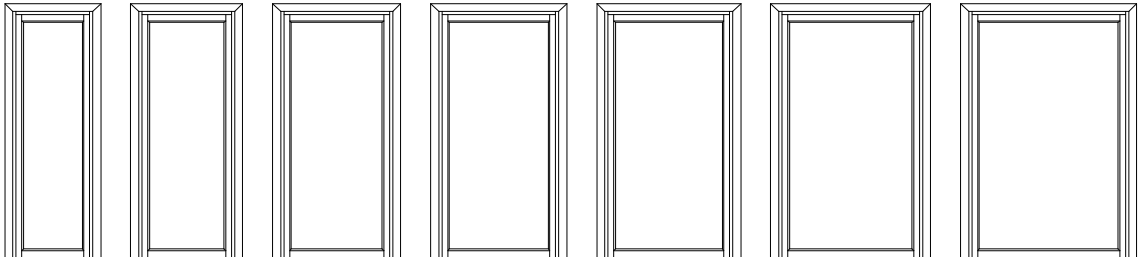

EWDP2164 EWDP2564 EWDP2964 EWDP3164 EWDP3364 EWDP3764 EWDP4164

70 11/16" (1795)
72 3/16" (1834)
68 3/4" (1746)
68" (1727)
60 5/16" (1532)

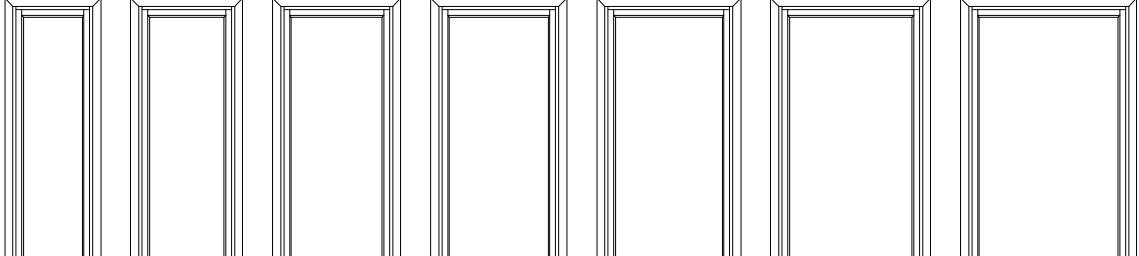

EWDP2168 EWDP2568 EWDP2968 EWDP3168 EWDP3368 EWDP3768 EWDP4168

74 11/16" (1897)
76 3/16" (1935)
72 3/4" (1848)
72" (1829)
64 5/16" (1634)

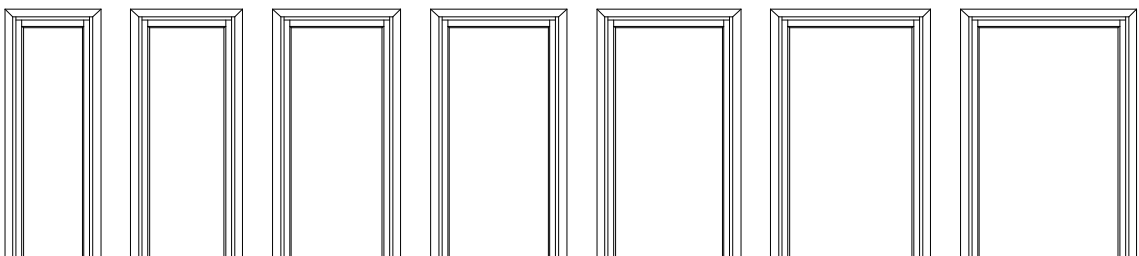

EWDP2172 EWDP2572 EWDP2972 EWDP3172 EWDP3372 EWDP3772 EWDP4172

78 11/16" (1999)
80 3/16" (2037)
76 3/4" (1949)
76" (1930)
68 5/16" (1735)



EWDP2176 EWDP2576 EWDP2976 EWDP3176 EWDP3376 EWDP3776 EWDP4176

ELEVATION SYMBOL LEGEND:
M.O. = MASONRY OPENING
VALUES IN () ARE IN MILLIMETER CONVERSIONS

Note: Elevations shown DO NOT have exterior trim. Subtract 1/2" (12.7) from M.O. (Masonry Opening) for Unit Sizes. Masonry Openings above include Sill Nose, see Trim Options page for Sill Nose specifications. For other Trim Options refer to the Unit Sizing, Rough Opening & Masonry Openings page.

SCALE 1/4" = 1'

PICTURE UNITS

M.O. BRICKMOULD	24 1/2" (622)	28 1/2" (724)	32 1/2" (826)	34 1/2" (876)	36 1/2" (927)	40 1/2" (1029)	44 1/2" (1130)
M.O. ADAMS/FLAT CASING	27 1/2" (699)	31 1/2" (800)	35 1/2" (902)	37 1/2" (953)	39 1/2" (1003)	43 1/2" (1105)	47 1/2" (1207)
ROUGH OPENING	22 1/8" (562)	26 1/8" (664)	30 1/8" (765)	32 1/8" (816)	34 1/8" (867)	38 1/8" (968)	42 1/8" (1070)
FRAME SIZE	21 3/8" (543)	25 3/8" (645)	29 3/8" (746)	31 3/8" (797)	33 3/8" (848)	37 3/8" (949)	41 3/8" (1051)
DAYLIGHT OPENING	14 13/16" (376)	18 13/16" (478)	22 13/16" (579)	24 13/16" (630)	26 13/16" (681)	30 13/16" (783)	34 13/16" (884)

82 11/16" (2100)
84 3/16" (2138)
80 3/4" (2031)
80" (2032)
72 5/16" (1837)

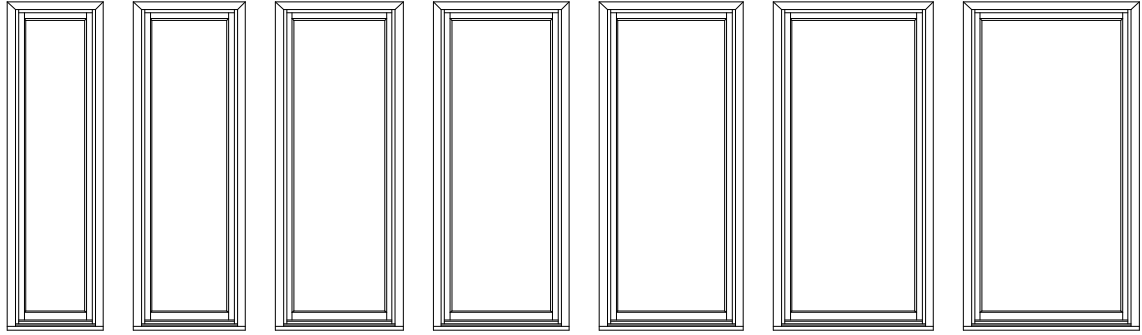

EWDP2180 EWDP2580 EWDP2980 EWDP3180 EWDP3380 EWDP3780 EWDP4180

90 11/16" (2303)
92 3/16" (2342)
88 3/4" (2254)
88" (2235)
80 5/16" (2040)

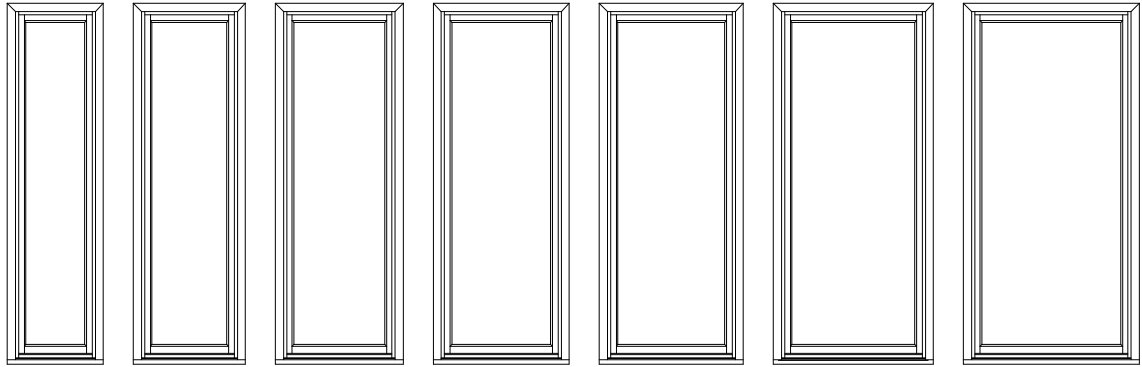

EWDP2188 EWDP2588 EWDP2988 EWDP3188 EWDP3388 EWDP3788 EWDP4188

94 11/16" (2405)
96 3/16" (2443)
92 3/4" (2355)
92" (2337)
84 5/16" (2142)

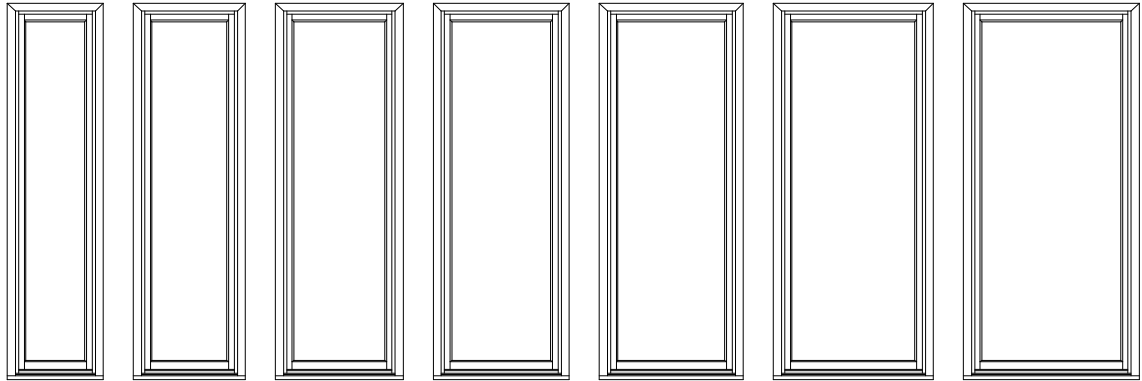

EWDP2192 EWDP2592 EWDP2992 EWDP3192 EWDP3392 EWDP3792 EWDP4192











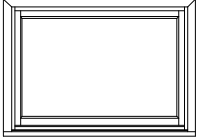
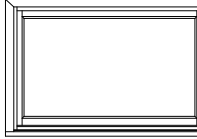
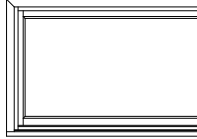
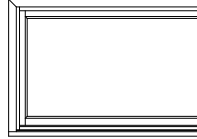
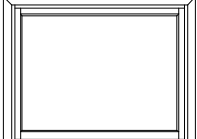
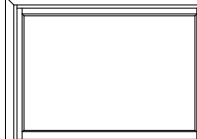
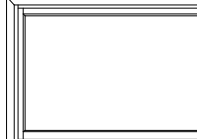
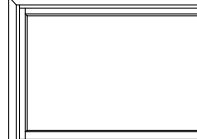









ELEVATION SYMBOL LEGEND:
M.O. = MASONRY OPENING
VALUES IN () ARE IN MILLIMETER CONVERSIONS

Note: Elevations shown DO NOT have exterior trim. Subtract 1/2" (12.7) from M.O. (Masonry Opening) for Unit Sizing. Masonry Openings above include Sill Nose, see Trim Options page for Sill Nose specifications. For other Trim Options refer to the Unit Sizing, Rough Opening & Masonry Openings page.

SCALE 1/4" = 1'

PICTURE UNITS

M.O. BRICKMOULD
M.O. ADAMS/FLAT CASING
ROUGH OPENING
FRAME SIZE
DAYLIGHT OPENING

34 11/16" (881) 36 3/16" (919) 32 7/16" (832) 24 5/16" (618)	48 1/2" (1232) 51 1/2" (1308) 46 1/8" (1172) 45 3/8" (1153) 38 13/16" (986)	52 1/2" (1334) 55 1/2" (1410) 50 1/8" (1273) 49 3/8" (1254) 42 13/16" (1087)	56 1/2" (1435) 59 1/2" (1511) 54 1/8" (1375) 53 3/8" (1356) 46 13/16" (1189)	64 1/2" (1638) 67 1/2" (1715) 62 1/8" (1578) 61 3/8" (1559) 54 13/16" (1392)
				
	EWDP4532	EWDP4932	EWDP5332	EWDP6132
38 11/16" (983) 40 3/16" (1021) 36 3/4" (933) 36 (914) 28 5/16" (719)				
				
	EWDP4536	EWDP4936	EWDP5336	EWDP6136
42 11/16" (1084) 44 3/16" (1122) 40 3/4" (1035) 40 (1016) 32 5/16" (821)				
				
	EWDP4540	EWDP4940	EWDP5340	EWDP6140
46 11/16" (1186) 48 3/16" (1224) 44 3/4" (1137) 44 (1118) 36 5/16" (922)				
				
	EWDP4544	EWDP4944	EWDP5344	EWDP6144
50 11/16" (1287) 52 3/16" (1326) 48 3/4" (1238) 48 (1219) 40 5/16" (1024)				
				
	EWDP4548	EWDP4948	EWDP5348	EWDP6148
54 11/16" (1389) 56 3/16" (1427) 52 3/4" (1340) 52 (1321) 44 5/16" (1126)				
				
	EWDP4552	EWDP4952	EWDP5352	EWDP6152
58 11/16" (1491) 60 3/16" (1529) 56 3/4" (1441) 56 (1422) 48 5/16" (1227)				
				
	EWDP4556	EWDP4956	EWDP5356	EWDP6156

ELEVATION SYMBOL LEGEND:
M.O. = MASONRY OPENING
VALUES IN () ARE IN MILLIMETER CONVERSIONS

Note: Elevations shown DO NOT have exterior trim. Subtract 1/2" (12.7) from M.O. (Masonry Opening) for Unit Sizes. Masonry Openings above include Sill Nose, see Trim Options page for Sill Nose specifications. For other Trim Options refer to the Unit Sizing, Rough Opening & Masonry Openings page.

SCALE 1/4" = 1'

PICTURE UNITS

M.O. BRICKMOULD
M.O. ADAMS/FLAT CASING
ROUGH OPENING
FRAME SIZE
DAYLIGHT OPENING

48 1/2" (1232)
51 1/2" (1308)
46 1/8" (1172)
45 3/8" (1153)
38 13/16" (986)

52 1/2" (1334)
55 1/2" (1410)
50 1/8" (1273)
49 3/8" (1254)
42 13/16" (1087)

56 1/2" (1435)
59 1/2" (1511)
54 1/8" (1375)
53 3/8" (1356)
46 13/16" (1189)

64 1/2" (1638)
67 1/2" (1715)
62 1/8" (1578)
61 3/8" (1559)
54 13/16" (1392)

62 11/16" (1592)
64 3/16" (1630)
60 3/4" (1543)
60" (1524)
52 5/16" (1329)

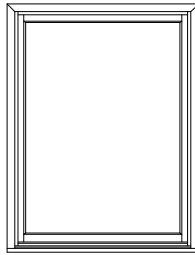

EWDP4560

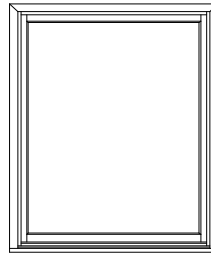

EWDP4960

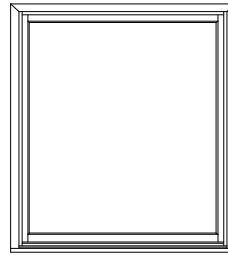

EWDP5360

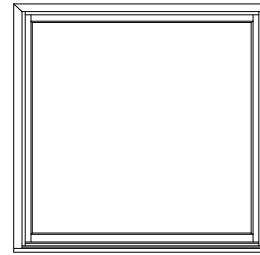

EWDP6160

66 11/16" (1694)
68 3/16" (1732)
64 3/4" (1645)
64" (1626)
56 5/16" (1430)

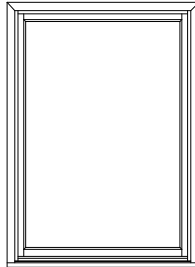

EWDP4564

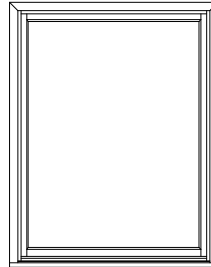

EWDP4964

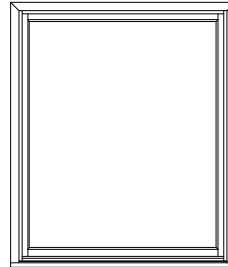

EWDP5364

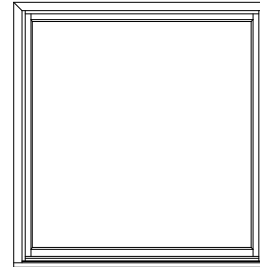

EWDP6164

70 11/16" (1795)
72 3/16" (1834)
68 3/4" (1746)
68" (1727)
60 5/16" (1532)

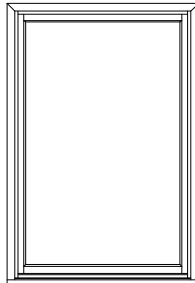

EWDP4568

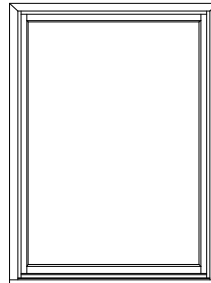

EWDP4968

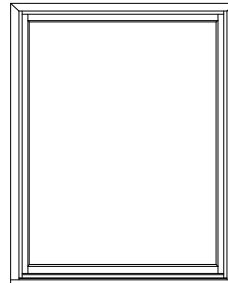

EWDP5368

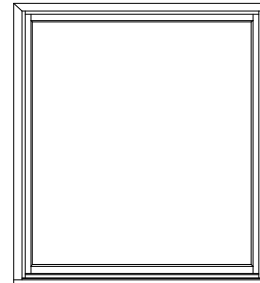

EWDP6168

74 11/16" (1897)
76 3/16" (1935)
72 3/4" (1848)
72" (1829)
64 5/16" (1634)

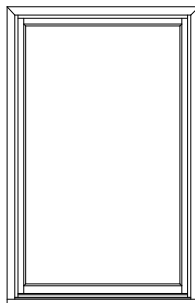

EWDP4572

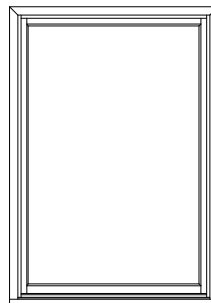

EWDP4972

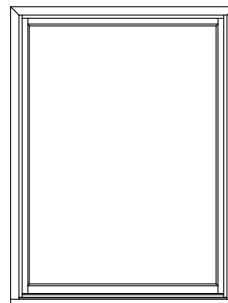

EWDP5372

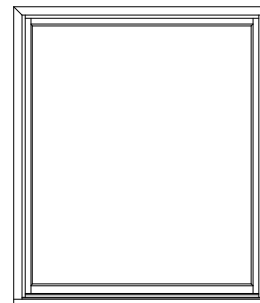

EWDP6172

78 11/16" (1999)
80 3/16" (2037)
76 3/4" (1949)
76" (1930)
68 5/16" (1735)

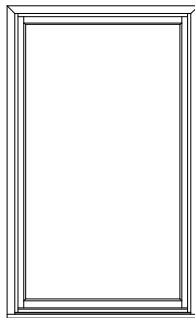

EWDP4576

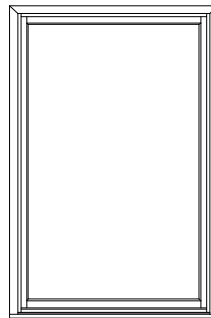

EWDP4976

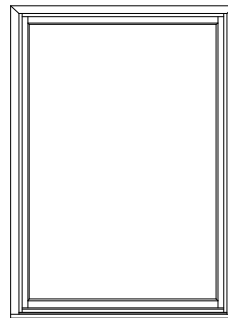

EWDP5376

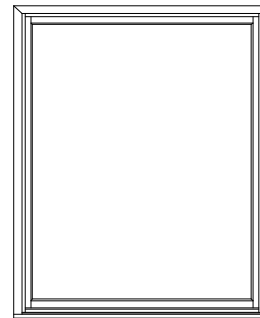

EWDP6176

ELEVATION SYMBOL LEGEND:
M.O. = MASONRY OPENING
VALUES IN () ARE IN MILLIMETER CONVERSIONS

Note: Elevations shown DO NOT have exterior trim. Subtract 1/2" (12.7) from M.O. (Masonry Opening) for Unit Sizes. Masonry Openings above include Sill Nose, see Trim Options page for Sill Nose specifications. For other Trim Options refer to the Unit Sizing, Rough Opening & Masonry Openings page.

SCALE 1/4" = 1'

PICTURE UNITS

M.O. BRICKMOULD
M.O. ADAMS/FLAT CASING
ROUGH OPENING
FRAME SIZE
DAYLIGHT OPENING

48 1/2" (1232)
51 1/2" (1308)
46 1/8" (1172)
45 3/8" (1153)
38 13/16" (986)

52 1/2" (1334)
55 1/2" (1410)
50 1/8" (1273)
49 3/8" (1254)
42 13/16" (1087)

56 1/2" (1435)
59 1/2" (1511)
54 1/8" (1375)
53 3/8" (1356)
46 13/16" (1189)

64 1/2" (1638)
67 1/2" (1715)
62 1/8" (1578)
61 3/8" (1559)
54 13/16" (1392)

82 11/16" (2100)
84 3/16" (2138)
80 3/4" (2051)
80" (2032)
72 5/16" (1837)

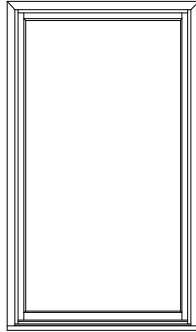

EWDP4580

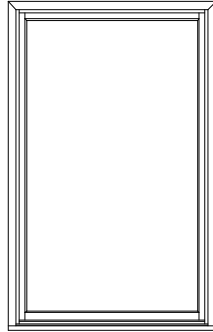

EWDP4980

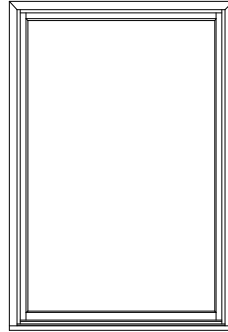

EWDP5380

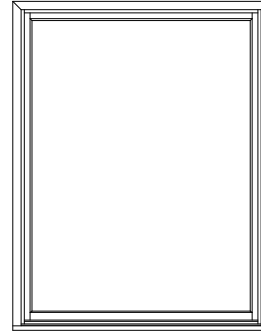

EWDP6180

90 11/16" (2303)
92 3/16" (2342)
88 3/4" (2254)
88" (2235)
80 5/16" (2040)

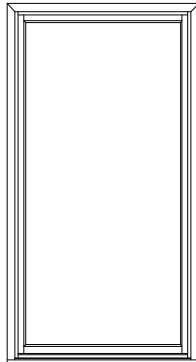

EWDP4588

94 11/16" (2405)
96 3/16" (2443)
92 3/4" (2356)
92" (2337)
84 5/16" (2142)

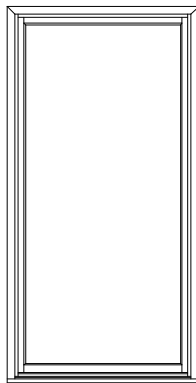

EWDP4592

ELEVATION SYMBOL LEGEND:

M.O. = MASONRY OPENING
VALUES IN () ARE IN MILLIMETER CONVERSIONS

Note: Elevations shown DO NOT have exterior trim. Subtract 1/2" (12.7) from M.O. (Masonry Opening) for Unit Sizes. Masonry Openings above include Sill Nose, see Trim Options page for Sill Nose specifications. For other Trim Options refer to the Unit Sizing, Rough Opening & Masonry Openings page.

SCALE 1/4" = 1'

PICTURE UNITS

**M.O. BRICKMOULD
M.O. ADAMS/FLAT CASING
ROUGH OPENING
FRAME SIZE
DAYLIGHT OPENING**

72 1/2" (1842)
75 1/2" (1918)
70 1/8" (1781)
69 3/8" (1762)
62 13/16" (1595)

80 1/2" (2045)
83 1/2" (2121)
78 1/8" (1984)
77 3/8" (1965)
70 13/16" (1799)

34 11/16" (881)
36 3/16" (919)
32 3/4" (832)
32 (813)
24 5/16" (618)

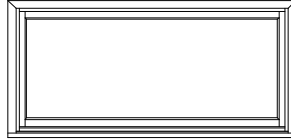

EWDP6932

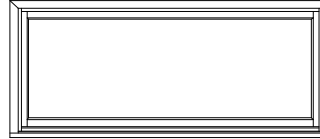

EWDP7732

38 11/16" (983)
40 3/16" (1021)
36 3/4" (933)
36 (914)
28 5/16" (719)

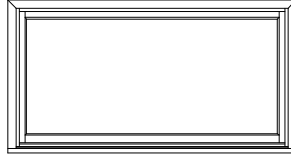

EWDP6936

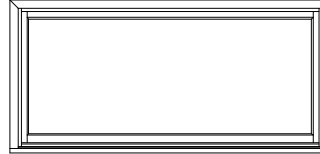

EWDP7736

42 11/16" (1084)
44 3/16" (1122)
40 3/4" (1035)
40 (1016)
32 5/16" (821)

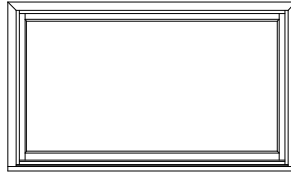

EWDP6940

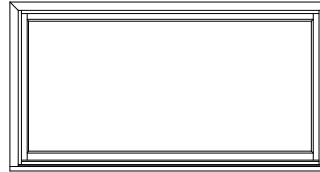

EWDP7740

46 11/16" (1186)
48 3/16" (1224)
44 3/4" (1137)
44 (1118)
36 5/16" (922)



EWDP6944

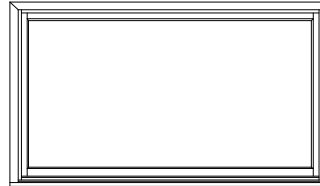

EWDP7744

50 11/16" (1287)
52 3/16" (1326)
48 3/4" (1238)
48 (1219)
40 5/16" (1024)

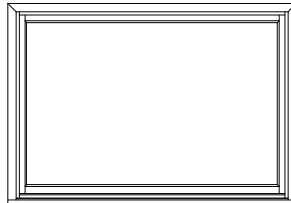

EWDP6948

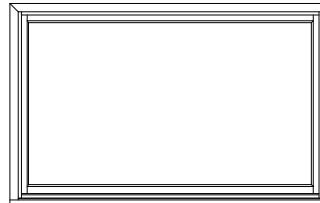

EWDP7748

54 11/16" (1389)
56 3/16" (1427)
52 3/4" (1340)
52 (1321)
44 5/16" (1126)

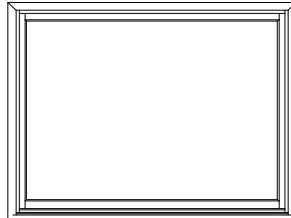

EWDP6952

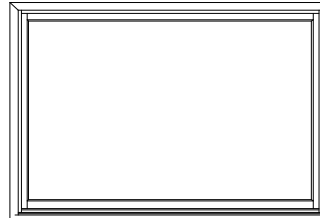

EWDP7752

58 11/16" (1491)
60 3/16" (1529)
56 3/4" (1441)
56 (1422)
48 5/16" (1227)



EWDP6956



EWDP7756

ELEVATION SYMBOL LEGEND:
M.O. = MASONRY OPENING
VALUES IN () ARE IN MILLIMETER CONVERSIONS

Note: Elevations shown DO NOT have exterior trim. Subtract 1/2" (12.7) from M.O. (Masonry Opening) for Unit Sizes. Masonry Openings above include Sill Nose, see Trim Options page for Sill Nose specifications. For other Trim Options refer to the Unit Sizing, Rough Opening & Masonry Openings page.

SCALE 1/4" = 1'

PICTURE UNITS

M.O. BRICKMOULD
M.O. ADAMS/FLAT CASING
ROUGH OPENING
FRAME SIZE
DAYLIGHT OPENING

72 1/2" (1842)
75 1/2" (1918)
70 1/8" (1781)
69 3/8" (1762)
62 13/16" (1595)

80 1/2" (2045)
83 1/2" (2121)
78 1/8" (1984)
77 3/8" (1965)
70 13/16" (1799)

62 11/16" (1592)
64 3/16" (1630)
60 3/4" (1543)
60" (1524)
52 5/16" (1329)

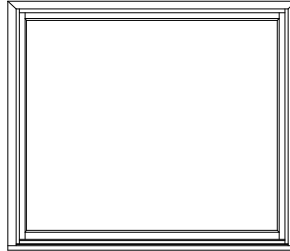

EWDP6960

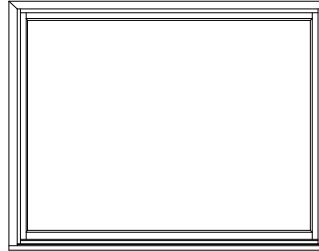

EWDP7760

66 11/16" (1694)
68 3/16" (1732)
64 3/4" (1645)
64" (1626)
56 5/16" (1430)

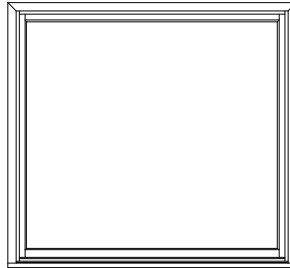

EWDP6964

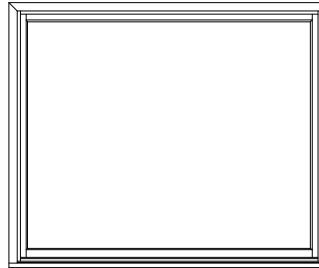

EWDP7764

70 11/16" (1795)
72 3/16" (1834)
68 3/4" (1746)
68" (1727)
60 5/16" (1532)

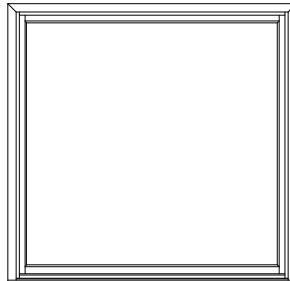

EWDP6968

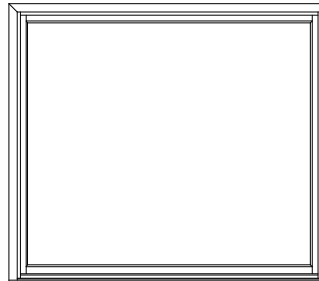

EWDP7768

74 11/16" (1897)
76 3/16" (1935)
72 3/4" (1848)
72" (1829)
64 5/16" (1634)

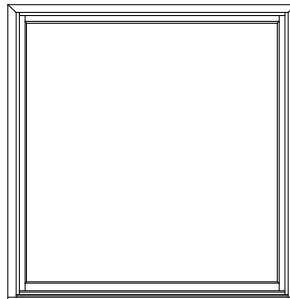

EWDP6972

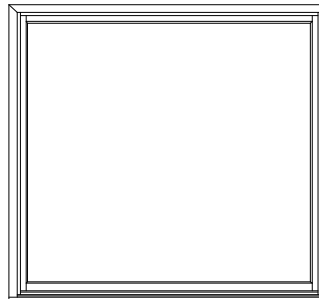

EWDP7772

78 11/16" (1999)
80 3/16" (2037)
76 3/4" (1949)
76" (1930)
68 5/16" (1735)

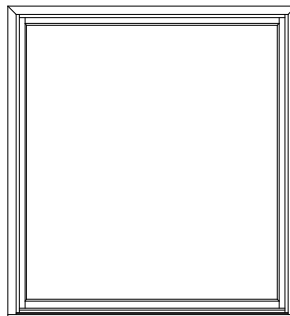

EWDP6976

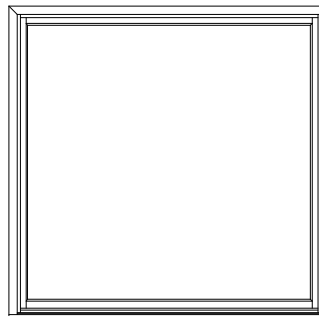

EWDP7776

ELEVATION SYMBOL LEGEND:
M.O. = MASONRY OPENING
VALUES IN () ARE IN MILLIMETER CONVERSIONS

Note: Elevations shown DO NOT have exterior trim. Subtract 1/2" (12.7) from M.O. (Masonry Opening) for Unit Sizes. Masonry Openings above include Sill Nose, see Trim Options page for Sill Nose specifications. For other Trim Options refer to the Unit Sizing, Rough Opening & Masonry Openings page.

SCALE 1/4" = 1'

PICTURE UNITS

M.O. BRICKMOULD
M.O. ADAMS/FLAT CASING
ROUGH OPENING
FRAME SIZE
DAYLIGHT OPENING

72 1/2" (1842)
75 1/2" (1918)
70 1/8" (1781)
69 3/8" (1762)
62 13/16" (1595)

80 1/2" (2045)
83 1/2" (2121)
78 1/8" (1984)
77 3/8" (1965)
70 13/16" (1799)

82 11/16" (2100)
84 3/16" (2138)
80 3/4" (2051)
80" (2032)
72 5/16" (1837)

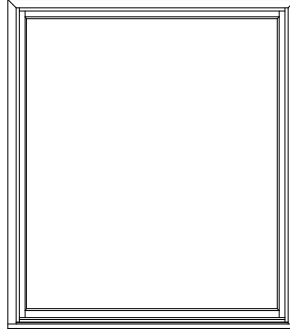

EWDP6980

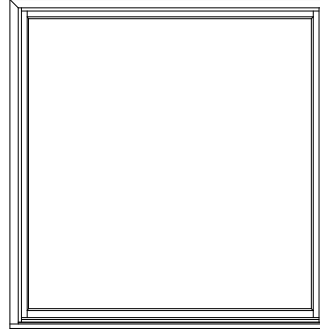

EWDP7780

ELEVATION SYMBOL LEGEND:

M.O. = MASONRY OPENING
VALUES IN () ARE IN MILLIMETER CONVERSIONS

Note: Elevations shown DO NOT have exterior trim. Subtract 1/2" (12.7) from M.O. (Masonry Opening) for Unit Sizes. Masonry Openings above include Sill Nose, see Trim Options page for Sill Nose specifications. For other Trim Options refer to the Unit Sizing, Rough Opening & Masonry Openings page.

PICTURE UNITS WITH 16" FLANKERS

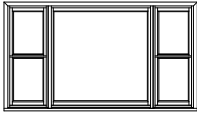
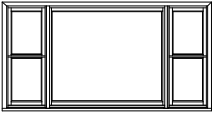
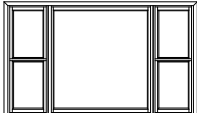
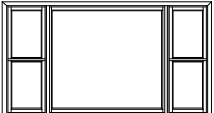
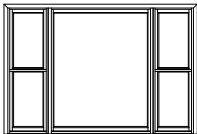
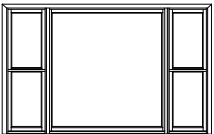
M.O. BRICKMOULD	99 1/4" (2521)	107 1/4" (2724)
M.O. ADAMS/FLAT CASING	102 1/4" (2597)	110 1/4" (2800)
ROUGH OPENING	96 7/8" (2461)	104 7/8" (2664)
FRAME SIZE	96 1/8" (2442)	104 1/8" (2645)
DAYLIGHT OPENING	14 13/16" (376)[2] 46 13/16" (1189)	14 13/16" (376)[2] 54 13/16" (1392)
54 11/16" (1389) 56 3/16" (1427) 52 3/4" (1340) 52 (1321) 21 1/16" (535)[2] 44 5/16" (1126)		
	EWD5352-16	EWD6152-16
58 11/16" (1491) 60 3/16" (1529) 56 3/4" (1441) 56 (1422) 23 1/16" (586)[2] 48 5/16" (1227)		
	EWD5356-16	EWD6156-16
66 11/16" (1694) 68 3/16" (1732) 64 3/4" (1646) 64 (1626) 27 1/16" (687)[2] 56 5/16" (1430)		
	EWD5364-16	EWD6164-16

ELEVATION SYMBOL LEGEND:

M.O. = MASONRY OPENING
VALUES IN () ARE IN MILLIMETER CONVERSIONS
VALUES IN [] ARE NUMBER OF DAYLIGHT OPENINGS PER UNIT

Note: Elevations shown DO NOT have exterior trim. Subtract 1/2" (12.7) from M.O. (Masonry Opening) for Unit Sizes. Masonry Openings above include Sill Nose, see Trim Options page for Sill Nose specifications. For other Trim Options refer to the Unit Sizing, Rough Opening & Masonry Openings page.

PICTURE UNITS WITH 20" FLANKERS

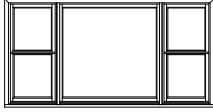
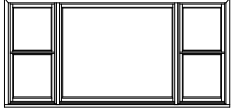
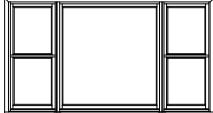
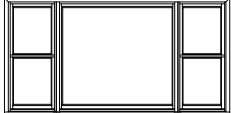
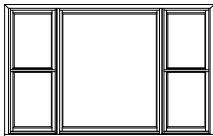
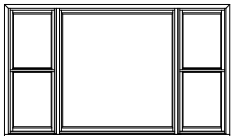
M.O. BRICKMOULD	107 1/4" (2724)	115 1/4" (2927)
M.O. ADAMS/FLAT CASING	110 1/4" (2800)	118 1/4" (3004)
ROUGH OPENING	104 7/8" (2664)	112 7/8" (2867)
FRAME SIZE	104 1/8" (2645)	112 1/8" (2848)
DAYLIGHT OPENING	18 13/16" (478) [2] 54 13/16" (1392)	18 13/16" (478) [2] 62 13/16" (1595)
54 11/16" (1389) 56 3/16" (1427) 52 3/4" (1340) 52" (1321) 21 1/16" (535) [2] 44 5/16" (1126)		
	EWD6152-20	EWD6952-20
58 11/16" (1491) 60 3/16" (1529) 56 3/4" (1441) 56" (1422) 23 1/16" (586) [2] 48 5/16" (1227)		
	EWD6156-20	EWD6956-20
66 11/16" (1694) 68 3/16" (1732) 64 3/4" (1645) 64" (1626) 27 1/16" (687) [2] 56 5/16" (1430)		
	EWD6164-20	EWD6964-20

ELEVATION SYMBOL LEGEND:

M.O. = MASONRY OPENING
VALUES IN () ARE IN MILLIMETER CONVERSIONS
VALUES IN [] ARE NUMBER OF DAYLIGHT OPENINGS PER UNIT

Note: Elevations shown DO NOT have exterior trim. Subtract 1/2" (12.7) from M.O. (Masonry Opening) for Unit Sizes. Masonry Openings above include Sill Nose, see Trim Options page for Sill Nose specifications. For other Trim Options refer to the Unit Sizing, Rough Opening & Masonry Openings page.

GENERAL INFORMATION
SECTOR TOP SINGLE-HUNG UNITS

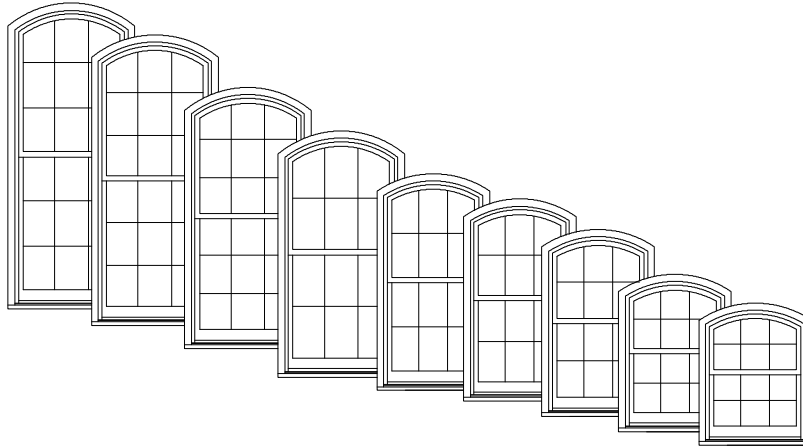
**DIMENSIONAL WINDOWS**

Wood sector top single-hung windows may be specified as "dimensional" by adjusting the desired rough opening width or height in 1/4" increments from standard.

Wood sector top single-hung windows feature stationary (fixed) upper sash and an operating lower sash. Counterbalancing is achieved with block and tackle spring extension systems hidden in weatherable PVC jamb liners. Operating units are supplied with cam-type sash locks installed. Die-cast lower sash lifts supplied for field installation are an option. Recessed sash retainers provide simple sash installation and removal. There are several hardware finish options. Refer to the Specifications for available finish options.

SITELINE EX SECTOR TOP SINGLE-HUNG WINDOWS utilize some of the same options as SITELINE EX DOUBLE-HUNG. These options have not been repeated here in this sub-section.

See the SITELINE EX DOUBLE-HUNG section for:
Trim Options (all wood exterior trim is available as radius trim)
and Jamb Extender Options.

HANDING & OPERATION
SECTOR TOP SINGLE-HUNG UNITS

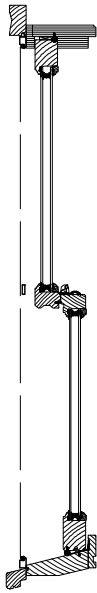

SINGLE-HUNG OPERATION:
When the sash are locked at the check rails the sash are closed and sealed in the sash opening of the frame.

When the sash are unlocked the lower sash travels vertically to any position desired. The upper sash is fixed.

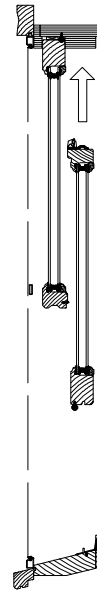

SASH TILTING FOR WASHING

The Custom Wood Single-Hung window will allow the lower sash to be tilted or removed for easy cleaning.

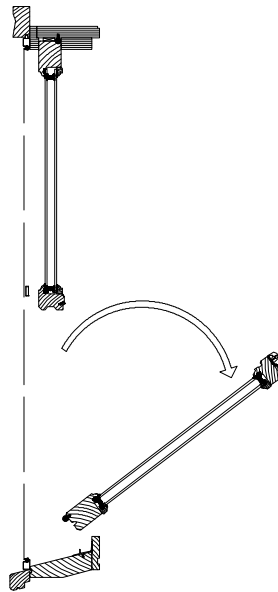

ELEVATION NOTES
SECTOR TOP SINGLE-HUNG UNITS

ELEVATION DRAWINGS UTILIZE A LIMITED NUMBER OF PROJECTED LINES TO PRODUCE A RUDIMENTARY DRAWING INTENDED TO BE USED IN A SMALL GRAPHICAL SCALE. ELEVATIONS ARE VIEWED PERPENDICULAR FROM THE EXTERIOR OF THE STRUCTURE. IF MORE DIMENSIONS ARE NEEDED, USE THE SECTION DRAWINGS FOR MORE COMPLETE DEPICTIONS.

M.O. Brickmould	28 1/2" (724)	Masonry Openings for Brickmould, Flat & Adams Casing. Vertical measurements include sillnose. (Subtract 1/2" from Masonry Opening for Unit Size)
M.O. Adams/Flat Casing	31 1/2" (800)	
Rough Opening	26 1/8" (664)	
Frame Size	25 3/8" (645)	
Daylight Opening	18 13/16" (478)	

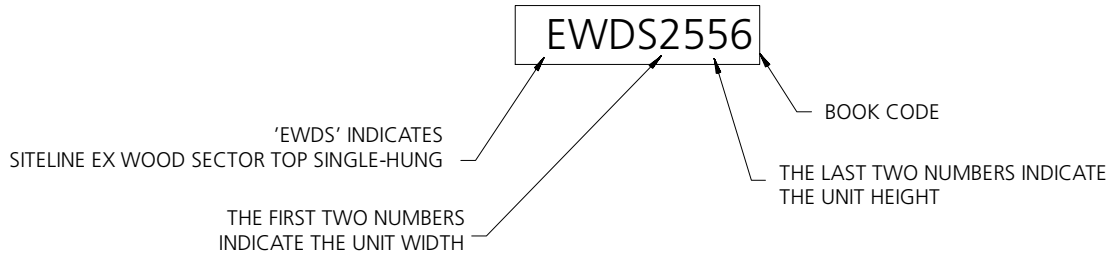
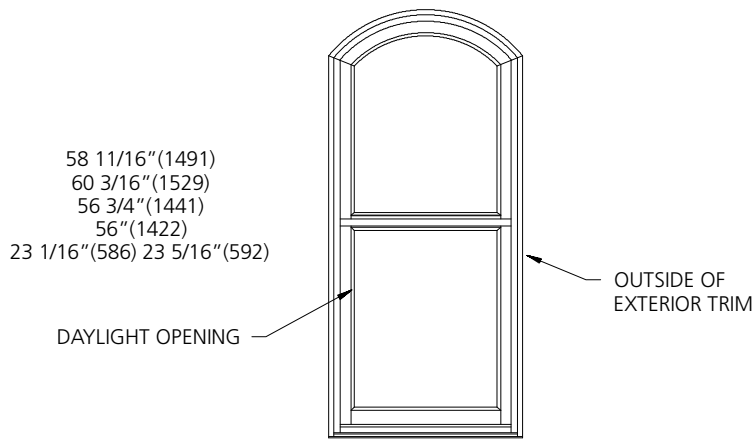

GENERAL WOOD SINGLE-HUNG NOTES

1. ALL UNITS SHOWN ARE AVAILABLE AS OPERATORS ONLY.
2. UNIT ELEVATIONS ARE SHOWN WITH BRICKMOULD & SUBSILL.
3. ALL OPERATING SASH ARE INSTALLED WITH VINYL JAMB LINERS AND OPERATED WITH AN INTERNAL BLOCK AND TACKLE SPRING SYSTEM.
4. DIMENSIONAL VALUES IN PARENTHESES ARE MILLIMETER CONVERSIONS.

ELEVATION SYMBOL LEGEND:

MO MASONRY OPENING

SECTOR TOP UNITS - 1-WIDE

M.O. BRICKMOLD
M.O. ADAMS/FLAT CASING
ROUGH OPENING
FRAME SIZE
DAYLIGHT OPENING

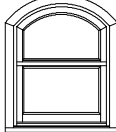
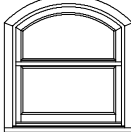
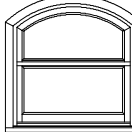
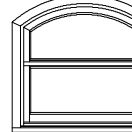
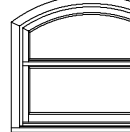
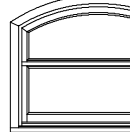
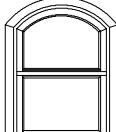
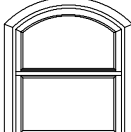
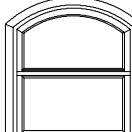
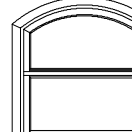
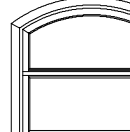
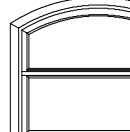
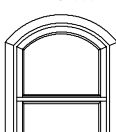
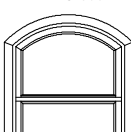
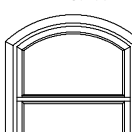
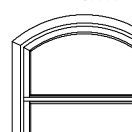
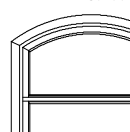
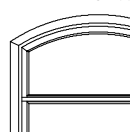
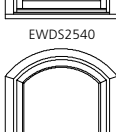
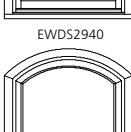
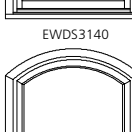
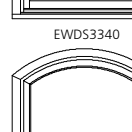
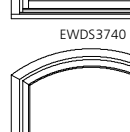
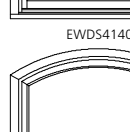
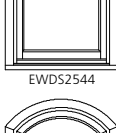
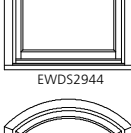
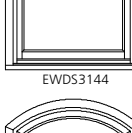
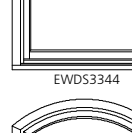
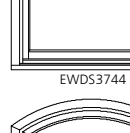
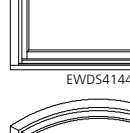
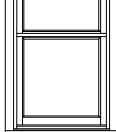
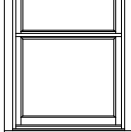
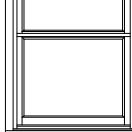
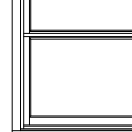
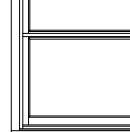
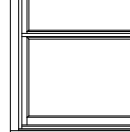
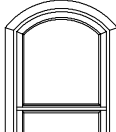
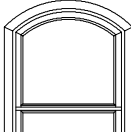
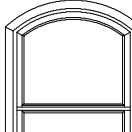
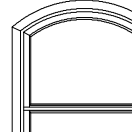
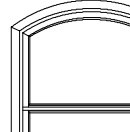
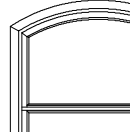
28 1/2" (724) 31 1/2" (800) 26 1/8" (664) 25 3/8" (645) 18 13/16" (478)	32 1/2" (826) 35 1/2" (902) 30 1/8" (765) 29 3/8" (746) 22 13/16" (579)	34 1/2" (876) 37 1/2" (953) 32 1/8" (816) 31 3/8" (797) 24 13/16" (630)	36 1/2" (927) 39 1/2" (1003) 34 1/8" (867) 33 3/8" (848) 26 13/16" (681)	40 1/2" (1029) 43 1/2" (1105) 38 1/8" (968) 37 3/8" (949) 30 13/16" (783)	44 1/2" (1130) 47 1/2" (1207) 42 1/8" (1070) 41 3/8" (1051) 34 13/16" (884)	
34 11/16" (881) 36 3/16" (919) 32 3/4" (832) 32" (813) 11 1/16" (281) 2]						
EWDS2532	EWDS2932	EWDS3132	EWDS3332	EWDS3732	EWDS4132	
38 11/16" (983) 40 3/16" (1021) 36 3/4" (933) 36" (914) 13 1/16" (332) 2]						
EWDS2536	EWDS2936	EWDS3136	EWDS3336	EWDS3736	EWDS4136	
42 11/16" (1084) 44 3/16" (1122) 40 3/4" (1035) 40" (1016) 15 1/16" (383) 2]						
EWDS2540	EWDS2940	EWDS3140	EWDS3340	EWDS3740	EWDS4140	
46 11/16" (1186) 48 3/16" (1224) 44 3/4" (1137) 44" (1118) 17 1/16" (433) 2]						
EWDS2544	EWDS2944	EWDS3144	EWDS3344	EWDS3744	EWDS4144	
50 11/16" (1287) 52 3/16" (1326) 48 3/4" (1238) 48" (1219) 19 1/16" (484) 2]						
EWDS2548	EWDS2948	EWDS3148	EWDS3348	EWDS3748	EWDS4148	
54 11/16" (1389) 56 3/16" (1427) 52 3/4" (1340) 52" (1321) 21 1/16" (535) 2]						
EWDS2552	EWDS2952	EWDS3152	EWDS3352	EWDS3752	EWDS4152	
58 11/16" (1491) 60 3/16" (1529) 56 3/4" (1441) 56" (1422) 23 1/16" (586) 2]						
EWDS2556	EWDS2956	EWDS3156	EWDS3356	EWDS3756	EWDS4156	

ELEVATION SYMBOL LEGEND:

M.O. = MASONRY OPENING
VALUES IN () ARE IN MILLIMETER CONVERSIONS
VALUES IN [] ARE NUMBER OF DAYLIGHT OPENINGS PER UNIT

Note: Elevations shown DO NOT have exterior trim. Subtract 1/2" (12.7) from M.O. (Masonry Opening) for Unit Sizes. Masonry Openings above include Sill Nose, see Trim Options page for Sill Nose specifications. For other Trim Options refer to the Unit Sizing, Rough Opening & Masonry Openings page.

SCALE 1/4" = 1'

SECTOR TOP UNITS - 1-WIDE

**M.O. BRICKMOUND
M.O. ADAMS/FLAT CASING
ROUGH OPENING
FRAME SIZE
DAYLIGHT OPENING**

28 1/2" (724)	32 1/2" (826)	34 1/2" (876)	36 1/2" (927)	40 1/2" (1029)	44 1/2" (1130)
31 1/2" (800)	35 1/2" (902)	37 1/2" (953)	39 1/2" (1003)	43 1/2" (1105)	47 1/2" (1207)
26 1/8" (664)	30 1/8" (765)	32 1/8" (816)	34 1/8" (867)	38 1/8" (968)	42 1/8" (1070)
25 3/8" (645)	29 3/8" (746)	31 3/8" (797)	33 3/8" (848)	37 3/8" (949)	41 3/8" (1051)
18 13/16" (478)	22 13/16" (579)	24 13/16" (630)	26 13/16" (681)	30 13/16" (783)	34 13/16" (884)

63 11/16" (1592)
64 3/16" (1630)
60 3/4" (1543)
60" (1524)
25 1/16" (637) [2]

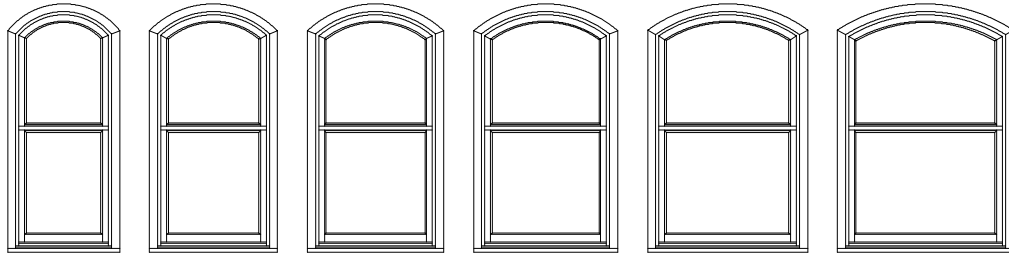

66 11/16" (1694)
68 3/16" (1732)
64 3/4" (1645)
64" (1626)
27 1/16" (687) [2]

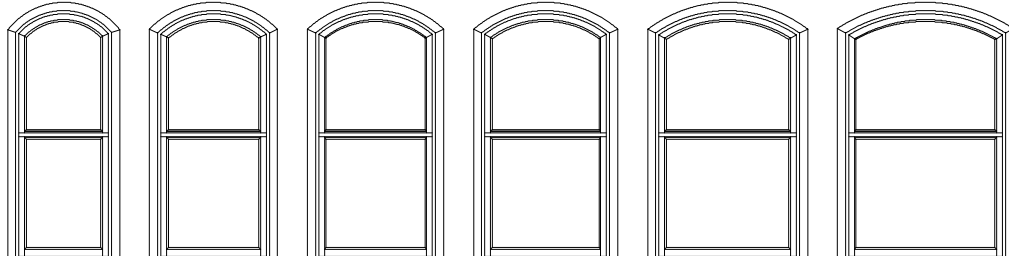

70 11/16" (1795)
72 3/16" (1833)
68 3/4" (1746)
68" (1727)
29 1/16" (738) [2]

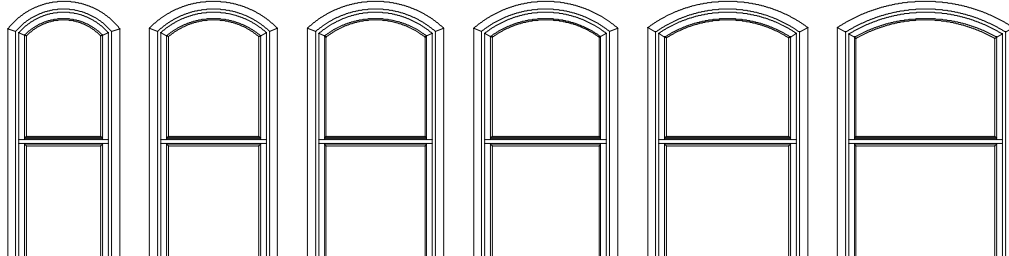

74 11/16" (1897)
76 3/16" (1935)
72 3/4" (1848)
72" (1829)
31 1/16" (789) [2]

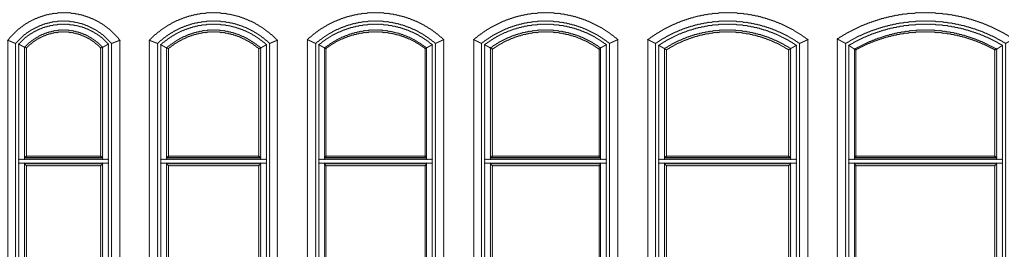

78 11/16" (1999)
80 3/16" (2037)
76 3/4" (1949)
76" (1930)
33 1/16" (840) [2]

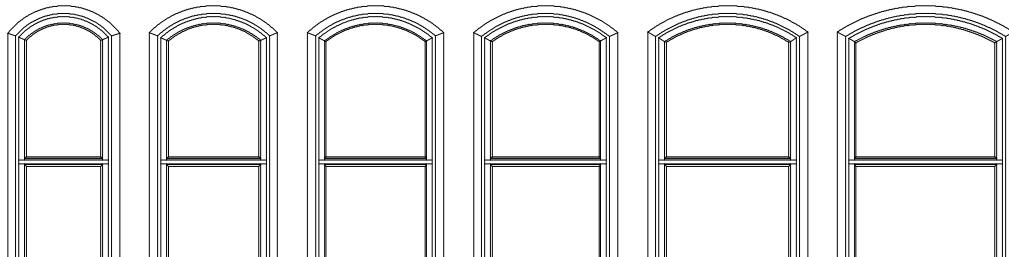

ELEVATION SYMBOL LEGEND:

M.O. = MASONRY OPENING
VALUES IN () ARE IN MILLIMETER CONVERSIONS
VALUES IN [] ARE NUMBER OF DAYLIGHT OPENINGS PER UNIT

Note: Elevations shown DO NOT have exterior trim. Subtract 1/2" (12.7) from M.O. (Masonry Opening) for Unit Sizes. Masonry Openings above include Sill Nose, see Trim Options page for Sill Nose specifications. For other Trim Options refer to the Unit Sizing, Rough Opening & Masonry Openings page.

SCALE 1/4" = 1'

SECTOR TOP UNITS - 1-WIDE

M.O. BRICKMOUND
M.O. ADAMS/FLAT CASING
ROUGH OPENING
FRAME SIZE
DAYLIGHT OPENING

28 1/2"(724)
31 1/2"(800)
26 1/8"(664)
25 3/8"(645)
18 13/16"(478)

32 1/2"(826)
35 1/2"(902)
30 1/8"(765)
29 3/8"(746)
22 13/16"(579)

34 1/2"(876)
37 1/2"(953)
32 1/8"(816)
31 3/8"(797)
24 13/16"(630)

36 1/2"(927)
39 1/2"(1003)
34 1/8"(867)
33 3/8"(848)
26 13/16"(681)

40 1/2"(1029)
43 1/2"(1105)
38 1/8"(968)
37 3/8"(949)
30 13/16"(783)

44 1/2"(1130)
47 1/2"(1207)
42 1/8"(1070)
41 3/8"(1051)
34 13/16"(884)

82 11/16"(2100)
84 3/16"(2138)
80 3/4"(2051)
80"(2032)
35 1/16"(891)|2|

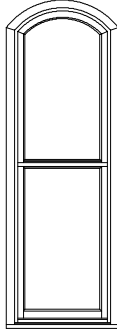

EWDS2580

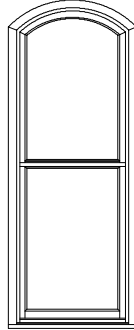

EWDS2980

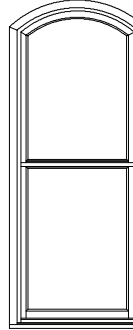

EWDS3180

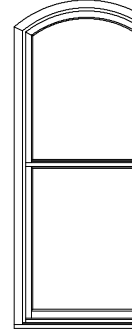

EWDS3380

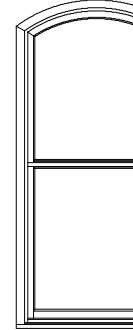

EWDS3780

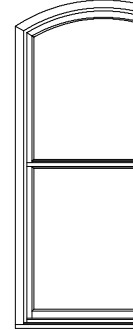

EWDS4180

90 11/16"(2303)
92 3/16"(2342)
88 3/4"(2254)
88"(2235)
39 1/16"(992)|2|

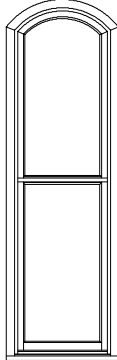

EWDS2588

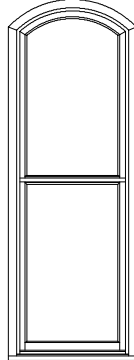

EWDS2988

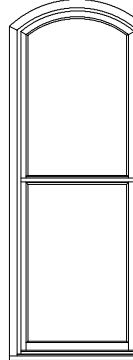

EWDS3188

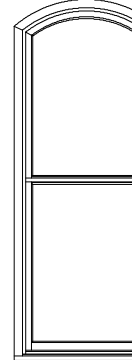

EWDS3388

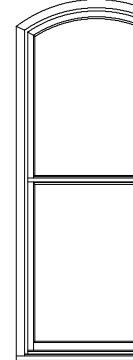

EWDS3788



EWDS4188

94 11/16"(2405)
96 3/16"(2443)
92 3/4"(2356)
92"(2337)
41 1/16"(1043)|2|

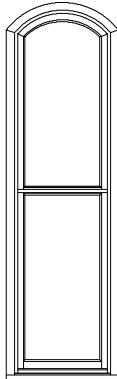

EWDS2592

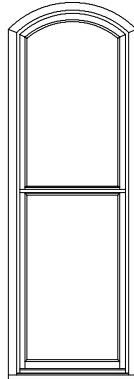

EWDS2992

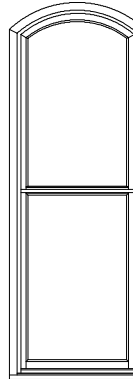

EWDS3192

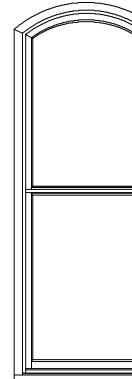

EWDS3392

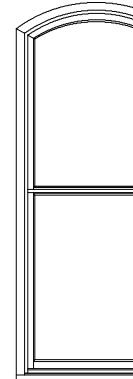

EWDS3792



EWDS4192

ELEVATION SYMBOL LEGEND:

M.O. = MASONRY OPENING

VALUES IN () ARE IN MILLIMETER CONVERSIONS

VALUES IN [] ARE NUMBER OF DAYLIGHT OPENINGS PER UNIT

Note: Elevations shown DO NOT have exterior trim. Subtract 1/2" (12.7) from M.O. (Masonry Opening) for Unit Sizes. Masonry Openings above include Sill Nose, see Trim Options page for Sill Nose specifications. For other Trim Options refer to the Unit Sizing, Rough Opening & Masonry Openings page.

SCALE 1/4" = 1'

SECTOR TOP UNITS - 1-WIDE

M.O. BRICKMOULD
M.O. ADAMS/FLAT CASING
ROUGH OPENING
FRAME SIZE
DAYLIGHT OPENING

48 1/2" (1232)
51 1/2" (1308)
46 1/8" (1172)
45 3/8" (1153)
38 13/16" (986)

34 11/16" (881)
36 3/16" (919)
32 3/4" (832)
32 (813)
11 1/16" (281) [2]



EWDS4532

38 11/16" (983)
40 3/16" (1021)
36 3/4" (933)
36 (914)
13 1/16" (332) [2]

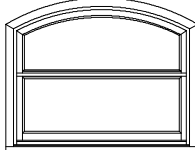

EWDS4536

42 11/16" (1084)
44 3/16" (1122)
40 3/4" (1035)
40 (1016)
15 1/16" (383) [2]

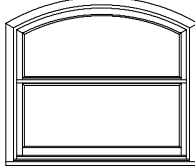

EWDS4540

46 11/16" (1186)
48 3/16" (1224)
44 3/4" (1137)
44 (1118)
17 1/16" (433) [2]

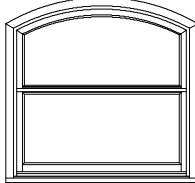

EWDS4544

50 11/16" (1287)
52 3/16" (1326)
48 3/4" (1238)
48 (1219)
19 1/16" (484) [2]

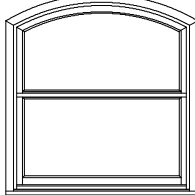

EWDS4548

54 11/16" (1389)
56 3/16" (1427)
52 3/4" (1340)
52 (1321)
21 1/16" (533) [2]

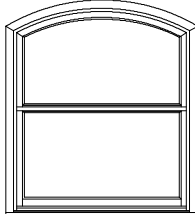

EWDS4552

58 11/16" (1491)
60 3/16" (1529)
56 3/4" (1441)
56 (1422)
23 1/16" (586) [2]

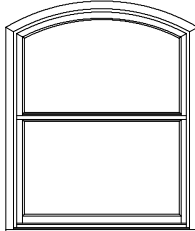

EWDS4556

M.O. BRICKMOULD
M.O. ADAMS/FLAT CASING
ROUGH OPENING
FRAME SIZE
DAYLIGHT OPENING

48 1/2" (1232)
51 1/2" (1308)
46 1/8" (1172)
45 3/8" (1153)
38 13/16" (986)

62 11/16" (1592)
64 3/16" (1630)
60 3/4" (1543)
60 (1524)
25 1/16" (637) [2]

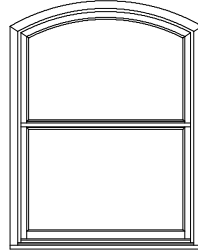

EWDS4560

66 11/16" (1694)
68 3/16" (1732)
64 3/4" (1645)
64 (1626)
27 1/16" (687) [2]

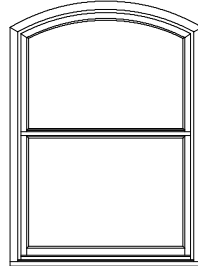

EWDS4564

70 11/16" (1795)
72 3/16" (1833)
68 3/4" (1746)
68 (1727)
29 1/16" (738) [2]

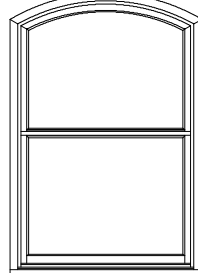

EWDS4568

74 11/16" (1897)
76 3/16" (1935)
72 3/4" (1848)
72 (1829)
31 1/16" (789) [2]

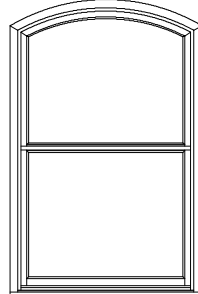

EWDS4572

78 11/16" (1999)
80 3/16" (2037)
76 3/4" (1949)
76 (1930)
33 1/16" (840) [2]

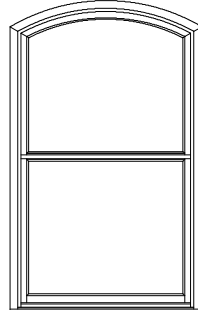

EWDS4576

M.O. BRICKMOULD
M.O. ADAMS/FLAT CASING
ROUGH OPENING
FRAME SIZE
DAYLIGHT OPENING

48 1/2" (1232)
51 1/2" (1308)
46 1/8" (1172)
45 3/8" (1153)
38 13/16" (986)

82 11/16" (2100)
84 3/16" (2138)
80 3/4" (2051)
80 (2032)
35 1/16" (891) [2]

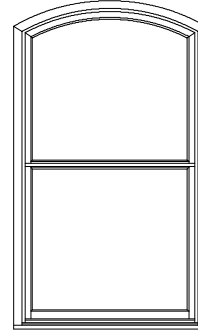

EWDS4580

90 11/16" (2303)
92 3/16" (2342)
88 3/4" (2254)
88 (2235)
39 1/16" (992) [2]

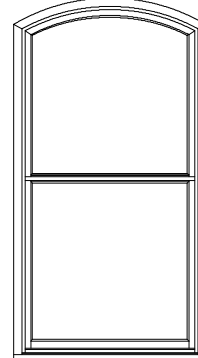

EWDS4588

94 11/16" (2405)
96 3/16" (2443)
92 3/4" (2356)
92 (2337)
41 1/16" (1043) [2]

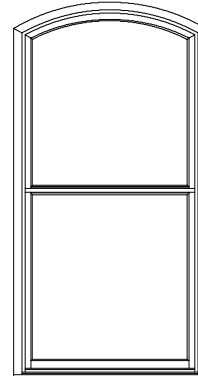

EWDS4592

ELEVATION SYMBOL LEGEND:

M.O. = MASONRY OPENING
VALUES IN () ARE IN MILLIMETER CONVERSIONS
VALUES IN [] ARE NUMBER OF DAYLIGHT OPENINGS PER UNIT

Note: Elevations shown DO NOT have exterior trim. Subtract 1/2" (12.7) from M.O. (Masonry Opening) for Unit Sizes. Masonry Openings above include Sill Nose, see Trim Options page for Sill Nose specifications. For other Trim Options refer to the Unit Sizing, Rough Opening & Masonry Openings page.

SCALE 1/4" = 1'

SECTOR TOP UNITS - 2-WIDE

M.O. BRICKMOULD M.O. ADAMS/FLAT CASING ROUGH OPENING FRAME SIZE DAYLIGHT OPENING	54 1/4" (1378) 57 1/4" (1454) 51 1/2" (1308) 50 3/4" (1289) 18 13/16" (478)[2]	62 1/4" (1581) 65 1/4" (1657) 59 1/2" (1511) 58 3/4" (1492) 22 13/16" (579)[2]	66 1/4" (1683) 69 1/4" (1759) 63 1/2" (1613) 62 3/4" (1594) 24 13/16" (630)[2]	70 1/4" (1784) 73 1/4" (1861) 67 1/2" (1715) 66 3/4" (1695) 26 13/16" (681)[2]	78 1/4" (1988) 81 1/4" (2064) 75 1/2" (1918) 74 3/4" (1899) 30 13/16" (783)[2]	86 1/4" (2191) 89 1/4" (2267) 83 1/2" (2121) 82 3/4" (2102) 34 13/16" (884)[2]
34 1/16" (881) 36 3/16" (919) 32 3/4" (832) 32" (813) 11 1/16" (281)[2]						
38 11/16" (983) 40 3/16" (1021) 36 3/4" (933) 36" (914) 13 1/16" (332)[2]						
42 11/16" (1084) 44 3/16" (1122) 40 3/4" (1095) 40" (1016) 15 1/16" (383)[2]						
46 11/16" (1186) 48 3/16" (1224) 44 3/4" (1137) 44" (1118) 17 1/16" (433)[2]						
50 11/16" (1287) 52 3/16" (1326) 48 3/4" (1238) 48" (1219) 19 1/16" (484)[2]						
54 11/16" (1389) 56 3/16" (1427) 52 3/4" (1340) 52" (1321) 21 1/16" (535)[2]						
58 11/16" (1491) 60 3/16" (1529) 56 3/4" (1441) 56" (1422) 23 1/16" (586)[2]						
62 11/16" (1592) 64 3/16" (1630) 60 3/4" (1543) 60" (1524) 25 1/16" (637)[2]						
66 11/16" (1694) 68 3/16" (1732) 64 3/4" (1645) 64" (1626) 27 1/16" (687)[2]						
70 11/16" (1795) 72 3/16" (1834) 68 3/4" (1746) 68" (1727) 29 1/16" (738)[2]						

ELEVATION SYMBOL LEGEND:
M.O. = MASONRY OPENING
VALUES IN () ARE IN MILLIMETER CONVERSIONS
VALUES IN [] ARE NUMBER OF DAYLIGHT OPENINGS PER UNIT

Note: Elevations shown DO NOT have exterior trim. Subtract 1/2" (12.7) from M.O. (Masonry Opening) for Unit Sizes. Masonry Openings above include Sill Nose, see Trim Options page for Sill Nose specifications. For other Trim Options refer to the Unit Sizing, Rough Opening & Masonry Openings page.

SCALE 1/8" = 1'

SECTOR TOP UNITS - 2-WIDE

M.O. BRICKMOULD
M.O. ADAMS/FLAT CASING
ROUGH OPENING
FRAME SIZE
DAYLIGHT OPENING

54 1/4"(1378)	62 1/4"(1581)	66 1/4"(1683)	70 1/4"(1784)	78 1/4"(1988)	86 1/4"(2191)
57 1/4"(1454)	65 1/4"(1657)	69 1/4"(1759)	73 1/4"(1861)	81 1/4"(2064)	89 1/4"(2267)
51 1/2"(1308)	59 1/2"(1511)	63 1/2"(1613)	67 1/2"(1715)	75 1/2"(1918)	83 1/2"(2121)
50 3/4"(1289)	58 3/4"(1492)	62 3/4"(1594)	66 3/4"(1695)	74 3/4"(1899)	82 3/4"(2102)
18 13/16"(478)[2]	22 13/16"(579)[2]	24 13/16"(630)[2]	26 13/16"(681)[2]	30 13/16"(783)[2]	34 13/16"(884)[2]

74 11/16"(1897)
76 3/16"(1935)
77 3/4"(1948)
77 7/8"(1929)
31 1/16"(789)[2]

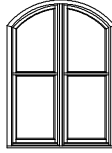

EWDS2572-2

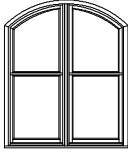

EWDS2972-2

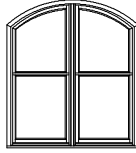

EWDS3172-2

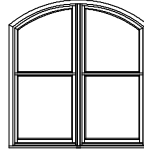

EWDS3372-2

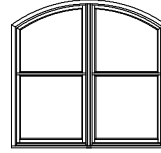

EWDS3772-2

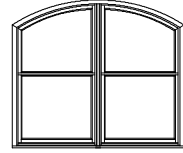

EWDS4172-2

78 11/16"(1989)
80 3/16"(2037)
76 3/4"(1949)
76 7/8"(1930)
33 1/16"(840)[2]

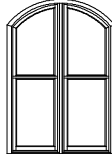

EWDS2576-2

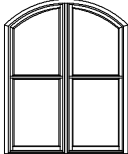

EWDS2976-2

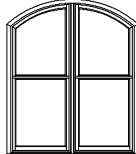

EWDS3176-2

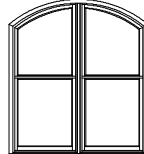

EWDS3376-2

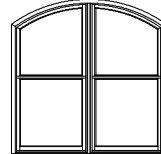

EWDS3776-2

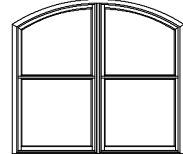

EWDS4176-2

82 11/16"(2100)
84 3/16"(2138)
80 3/4"(2051)
80 7/8"(2032)
35 1/16"(891)[2]

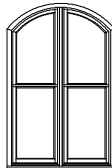

EWDS2580-2

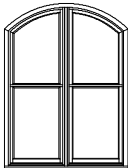

EWDS2980-2

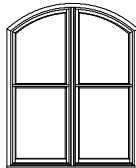

EWDS3180-2

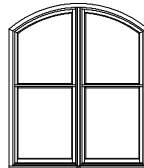

EWDS3380-2

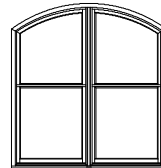

EWDS3780-2

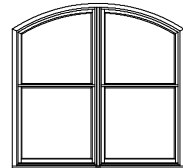

EWDS4180-2

90 11/16"(2303)
92 3/16"(2342)
88 3/4"(2254)
88 7/8"(2235)
39 1/16"(992)[2]

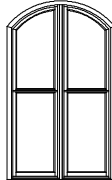

EWDS2588-2

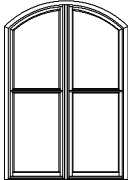

EWDS2988-2

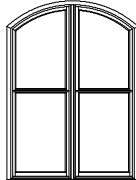

EWDS3188-2

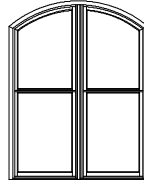

EWDS3388-2

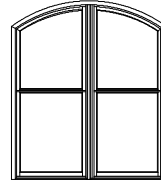

EWDS3788-2

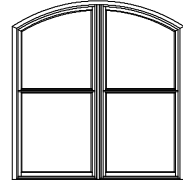

EWDS4188-2

94 11/16"(2405)
96 3/16"(2443)
92 3/4"(2356)
92 7/8"(2337)
41 1/16"(1043)[2]

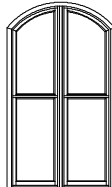

EWDS2592-2

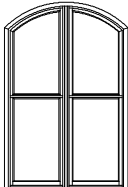

EWDS2992-2

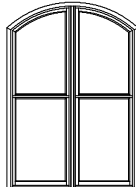

EWDS3192-2

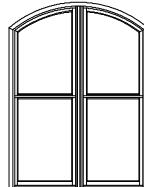

EWDS3392-2

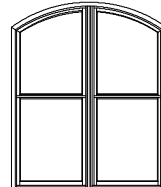

EWDS3792-2

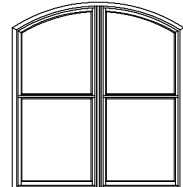

EWDS4192-2

ELEVATION SYMBOL LEGEND:
M.O. = MASONRY OPENING
VALUES IN () ARE IN MILLIMETER CONVERSIONS
VALUES IN [] ARE NUMBER OF DAYLIGHT OPENINGS PER UNIT

Note: Elevations shown DO NOT have exterior trim. Subtract 1/2" (12.7) from M.O. (Masonry Opening) for Unit Sizes. Masonry Openings above include Sill Nose, see Trim Options page for Sill Nose specifications. For other Trim Options refer to the Unit Sizing, Rough Opening & Masonry Openings page.

SCALE 1/8" = 1'











SECTOR TOP UNITS - 2-WIDE

**M.O. BRICKMOULD
M.O. ADAMS/FLAT CASING
ROUGH OPENING
FRAME SIZE
DAYLIGHT OPENING**

94 1/4" (2394)
97 1/4" (2470)
91 1/2" (2324)
90 3/4" (2305)
38 13/16" (986)[2]

**M.O. BRICKMOULD
M.O. ADAMS/FLAT CASING
ROUGH OPENING
FRAME SIZE
DAYLIGHT OPENING**

94 1/4" (2394)
97 1/4" (2470)
91 1/2" (2324)
90 3/4" (2305)
38 13/16" (986)[2]

34 11/16" (881) 36 3/16" (919) 32 3/4" (832) 32" (813)		EWDS4532-2
38 11/16" (983) 40 3/16" (1021) 36 3/4" (933) 36" (914)		EWDS4536-2
42 11/16" (1084) 44 3/16" (1122) 40 3/4" (1035) 40" (1016)		EWDS4540-2
46 11/16" (1186) 48 3/16" (1224) 44 3/4" (1137) 44" (1118)		EWDS4544-2
50 11/16" (1287) 52 3/16" (1326) 48 3/4" (1238) 48" (1219)		EWDS4548-2
54 11/16" (1389) 56 3/16" (1427) 52 3/4" (1340) 52" (1321)		EWDS4552-2
58 11/16" (1491) 60 3/16" (1529) 56 3/4" (1441) 56" (1422)		EWDS4556-2
62 11/16" (1592) 64 3/16" (1630) 60 3/4" (1543) 60" (1524)		EWDS4560-2
66 11/16" (1694) 68 3/16" (1732) 64 3/4" (1645) 64" (1626)		EWDS4564-2
70 11/16" (1795) 72 3/16" (1834) 68 3/4" (1746) 68" (1727)		EWDS4568-2

74 11/16" (1897)
76 3/16" (1935)
72 3/4" (1848)
72" (1829)
31 1/16" (789)[2]

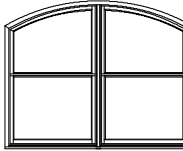
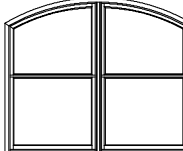
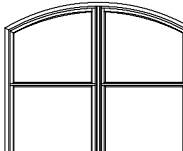
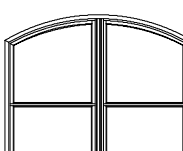
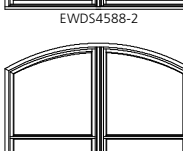
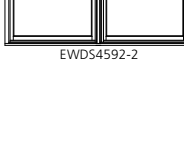
	EWDS4572-2
	EWDS4576-2
	EWDS4580-2
	EWDS4584-2
	EWDS4588-2
	EWDS4592-2

ELEVATION SYMBOL LEGEND:
M.O. = MASONRY OPENING
VALUES IN () ARE IN MILLIMETER CONVERSIONS
VALUES IN [] ARE NUMBER OF DAYLIGHT OPENINGS PER UNIT

Note: Elevations shown DO NOT have exterior trim. Subtract 1/2" (12.7) from M.O. (Masonry Opening) for Unit Sizes. Masonry Openings above include Sill Nose, see Trim Options page for Sill Nose specifications. For other Trim Options refer to the Unit Sizing, Rough Opening & Masonry Openings page.

SCALE 1/8" = 1'

SECTOR TOP UNITS - 3-WIDE

M.O. BRICKMOULD
M.O. ADAMS/FLAT CASING
ROUGH OPENING
FRAME SIZE
DAYLIGHT OPENING

79 5/8" (2022)
82 5/8" (2099)
76 7/8" (1953)
76 1/4" (1937)
18 13/16" (478)[3]

91 5/8" (2327)
94 5/8" (2403)
88 7/8" (2257)
88 1/4" (2242)
22 13/16" (579)[3]

97 5/8" (2480)
100 5/8" (2556)
94 7/8" (2410)
94 1/4" (2394)
24 13/16" (630)[3]

103 5/8" (2632)
106 5/8" (2708)
100 7/8" (2562)
100 1/4" (2546)
26 13/16" (681)[3]

115 5/8" (2937)
118 5/8" (3013)
112 7/8" (2867)
112 1/4" (2851)
30 13/16" (783)[3]

34 11/16" (881)
36 3/16" (919)
32 3/4" (832)
34 1/8" (863)
38 11/16" (983)
40 3/16" (1021)
36 3/4" (933)
36 9/16" (922)
42 11/16" (1084)
44 3/16" (1122)
40 3/4" (1035)
40 1/8" (1018)
46 11/16" (1186)
48 3/16" (1224)
44 3/4" (1137)
44 1/8" (1120)
17 1/16" (433)[2]
50 11/16" (1287)
52 3/16" (1326)
48 3/4" (1238)
48 1/8" (1221)
54 11/16" (1389)
56 3/16" (1427)
52 3/4" (1340)
52 1/8" (1323)
21 1/16" (535)[2]
58 11/16" (1491)
60 3/16" (1529)
56 3/4" (1441)
56 1/8" (1424)
23 1/16" (586)[2]
62 11/16" (1592)
64 3/16" (1630)
60 3/4" (1543)
60 1/8" (1526)
25 1/16" (637)[2]
66 11/16" (1694)
68 3/16" (1732)
64 3/4" (1645)
64 1/8" (1628)
27 1/16" (687)[2]
70 11/16" (1795)
72 3/16" (1834)
68 3/4" (1746)
68 1/8" (1729)
29 1/16" (738)[2]



EWDS2532-3

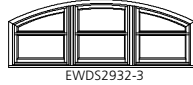

EWDS2932-3



EWDS3132-3



EWDS3332-3



EWDS3732-3



EWDS2536-3



EWDS2936-3



EWDS3136-3



EWDS3336-3



EWDS3736-3



EWDS2540-3



EWDS2940-3

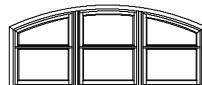

EWDS3140-3



EWDS3340-3



EWDS3740-3



EWDS2544-3



EWDS2944-3



EWDS3144-3



EWDS3344-3

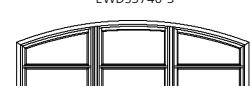

EWDS3744-3



EWDS2548-3



EWDS2948-3



EWDS3148-3



EWDS3348-3



EWDS3748-3



EWDS2552-3



EWDS2952-3



EWDS3152-3



EWDS3352-3



EWDS3752-3



EWDS2556-3



EWDS2956-3



EWDS3156-3



EWDS3356-3



EWDS3756-3



EWDS2560-3



EWDS2960-3



EWDS3160-3



EWDS3360-3



EWDS3760-3



EWDS2564-3



EWDS2964-3



EWDS3164-3



EWDS3364-3



EWDS3764-3



EWDS2568-3



EWDS2968-3



EWDS3168-3



EWDS3368-3



EWDS3768-3

ELEVATION SYMBOL LEGEND:
M.O. = MASONRY OPENING
VALUES IN () ARE IN MILLIMETER CONVERSIONS
VALUES IN [] ARE NUMBER OF DAYLIGHT OPENINGS PER UNIT

Note: Elevations shown DO NOT have exterior trim. Subtract 1/2" (12.7) from M.O. (Masonry Opening) for Unit Sizes. Masonry Openings above include Sill Nose, see Trim Options page for Sill Nose specifications. For other Trim Options refer to the Unit Sizing, Rough Opening & Masonry Openings page.

SCALE 1/8" = 1'

SECTOR TOP UNITS - 3-WIDE

M.O. BRICKMOULD
M.O. ADAMS/FLAT CASING
ROUGH OPENING
FRAME SIZE
DAYLIGHT OPENING

79 5/8" (2022)
82 5/8" (2099)
76 7/8" (1953)
76 1/4" (1937)
18 13/16" (478)[3]

91 5/8" (2327)
94 5/8" (2403)
88 7/8" (2257)
88 1/4" (2242)
22 13/16" (579)[3]

97 5/8" (2480)
100 5/8" (2556)
94 7/8" (2410)
94 1/4" (2394)
24 13/16" (630)[3]

103 5/8" (2632)
106 5/8" (2708)
100 7/8" (2562)
100 1/4" (2546)
26 13/16" (681)[3]

115 5/8" (2937)
118 5/8" (3013)
112 7/8" (2867)
112 1/4" (2851)
30 13/16" (783)[3]

74 11/16" (1897)
76 3/16" (1935)
72 3/4" (1848)
72" (1829)
31 1/16" (789)[2]

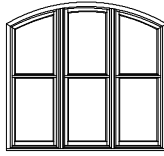

EWDS2572-3

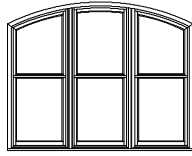

EWDS2972-3

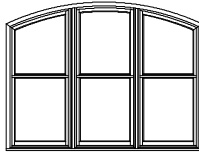

EWDS3172-3

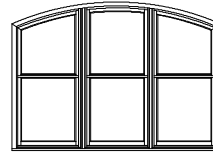

EWDS3372-3

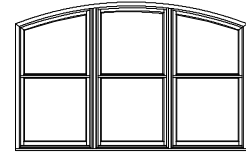

EWDS3772-3

78 11/16" (1999)
80 3/16" (2037)
76 3/4" (1949)
76" (1930)
33 1/16" (840)[2]

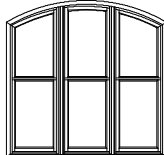

EWDS2576-3

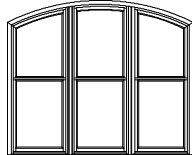

EWDS2976-3

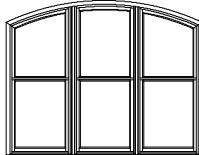

EWDS3176-3

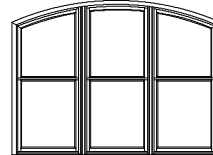

EWDS3376-3

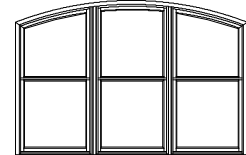

EWDS3776-3

82 11/16" (2100)
84 3/16" (2138)
80 3/4" (2051)
80" (2032)
35 1/16" (891)[2]

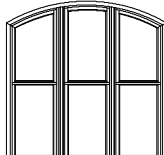

EWDS2580-3

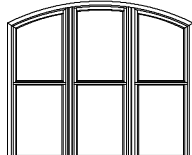

EWDS2980-3

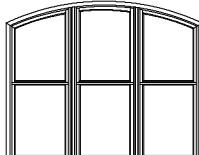

EWDS3180-3

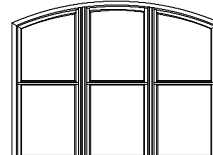

EWDS3380-3

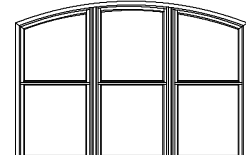

EWDS3780-3

90 11/16" (2303)
92 3/16" (2342)
88 3/4" (2254)
88" (2235)
39 1/16" (992)[2]

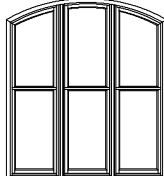

EWDS2588-3

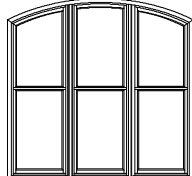

EWDS2988-3

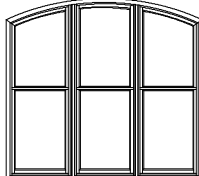

EWDS3188-3

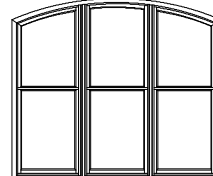

EWDS3388-3

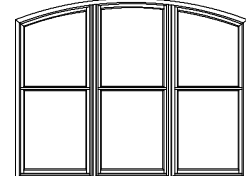

EWDS3788-3

94 11/16" (2405)
96 3/16" (2443)
92 3/4" (2356)
92" (2337)
41 1/16" (1043)[2]

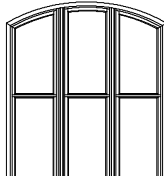

EWDS2592-3

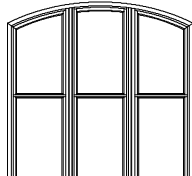

EWDS2992-3

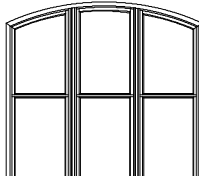

EWDS3192-3

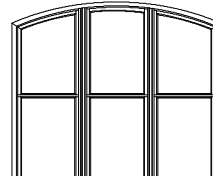

EWDS3392-3

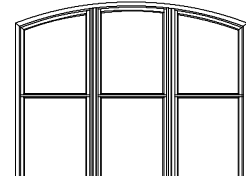

EWDS3792-3

ELEVATION SYMBOL LEGEND:
M.O. = MASONRY OPENING
VALUES IN () ARE IN MILLIMETER CONVERSIONS
VALUES IN [] ARE NUMBER OF DAYLIGHT OPENINGS PER UNIT

Note: Elevations shown DO NOT have exterior trim. Subtract 1/2" (12.7) from M.O. (Masonry Opening) for Unit Sizes. Masonry Openings above include Sill Nose, see Trim Options page for Sill Nose specifications. For other Trim Options refer to the Unit Sizing, Rough Opening & Masonry Openings page.

SCALE 1/8" = 1'

SECTOR TOP UNITS - 3-WIDE

**M.O. BRICKMOULD
M.O. ADAMS/FLAT CASING
ROUGH OPENING
FRAME SIZE
DAYLIGHT OPENING**

127 5/8" (3242)
130 5/8" (3318)
124 7/8" (3172)
124 1/4" (3156)
34 13/16" (884)[3]

139 5/8" (3546)
142 5/8" (3623)
136 7/8" (3477)
136 1/4" (3461)
38 13/16" (986)[3]

34 11/16" (881)
36 3/16" (919)
32 3/4" (832)
32" (813)
11 1/16" (281)[2]

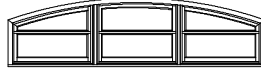

EWDS4132-3

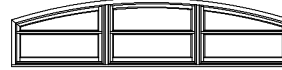

EWDS4532-3

38 11/16" (983)
40 3/16" (1021)
36 3/4" (933)
36" (914)
13 1/16" (332)[2]



EWDS4136-3



EWDS4536-3

42 11/16" (1084)
44 3/16" (1122)
40 3/4" (1035)
40" (1016)
15 1/16" (383)[2]



EWDS4140-3



EWDS4540-3

46 11/16" (1186)
48 3/16" (1224)
44 3/4" (1137)
44" (1118)
17 1/16" (433)[2]



EWDS4144-3



EWDS4544-3

50 11/16" (1287)
52 3/16" (1326)
48 3/4" (1238)
48" (1219)
19 1/16" (484)[2]



EWDS4148-3



EWDS4548-3

54 11/16" (1389)
56 3/16" (1427)
52 3/4" (1340)
52" (1321)
21 1/16" (535)[2]



EWDS4152-3



EWDS4552-3

58 11/16" (1491)
60 3/16" (1529)
56 3/4" (1441)
56" (1422)
23 1/16" (586)[2]



EWDS4156-3



EWDS4556-3

62 11/16" (1592)
64 3/16" (1630)
60 3/4" (1543)
60" (1524)
25 1/16" (637)[2]



EWDS4160-3



EWDS4560-3

66 11/16" (1694)
68 3/16" (1732)
64 3/4" (1645)
64" (1626)
27 1/16" (687)[2]



EWDS4164-3



EWDS4564-3

70 11/16" (1795)
72 3/16" (1834)
68 3/4" (1746)
68" (1727)
29 1/16" (738)[2]



EWDS4168-3



EWDS4568-3

ELEVATION SYMBOL LEGEND:
M.O. = MASONRY OPENING
VALUES IN () ARE IN MILLIMETER CONVERSIONS
VALUES IN [] ARE NUMBER OF DAYLIGHT OPENINGS PER UNIT

Note: Elevations shown DO NOT have exterior trim. Subtract 1/2" (12.7) from M.O. (Masonry Opening) for Unit Sizes. Masonry Openings above include Sill Nose, see Trim Options page for Sill Nose specifications. For other Trim Options refer to the Unit Sizing, Rough Opening & Masonry Openings page.

SCALE 1/8" = 1'

SECTOR TOP UNITS - 3-WIDE

M.O. BRICKMOULD
M.O. ADAMS/FLAT CASING
ROUGH OPENING
FRAME SIZE
DAYLIGHT OPENING

127 5/8" (3242)
130 5/8" (3318)
124 7/8" (3172)
124 1/4" (3156)
34 13/16" (884)[3]

139 5/8" (3546)
142 5/8" (3623)
136 7/8" (3477)
136 1/4" (3461)
38 13/16" (986)[3]

74 11/16" (1897)
76 3/16" (1935)
72 3/4" (1848)
77" (1929)
31 1/16" (789)[2]

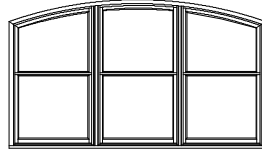

EWDS4172-3

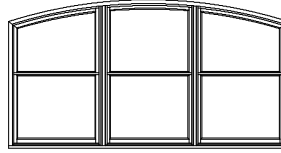

EWDS4572-3

78 11/16" (1999)
80 3/16" (2037)
76 3/4" (1949)
76" (1930)
33 1/16" (840)[2]

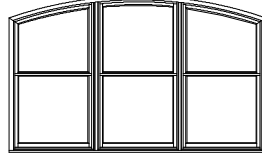

EWDS4176-3

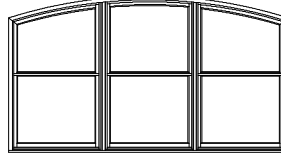

EWDS4576-3

82 11/16" (2100)
84 3/16" (2138)
80 3/4" (2051)
80" (2032)
35 1/16" (891)[2]

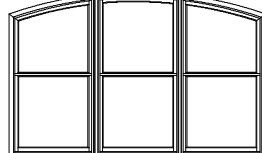

EWDS4180-3

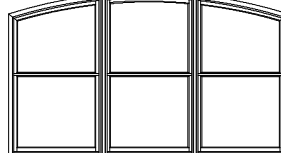

EWDS4580-3

90 11/16" (2303)
92 3/16" (2342)
88 3/4" (2254)
88" (2235)
39 1/16" (992)[2]

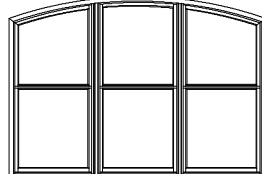

EWDS4188-3

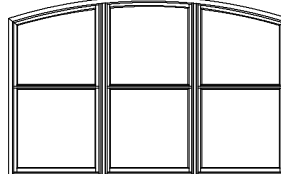

EWDS4588-3

94 11/16" (2405)
96 3/16" (2443)
92 3/4" (2356)
92" (2337)
41 1/16" (1043)[2]

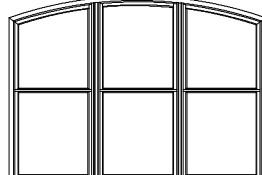

EWDS4192-3

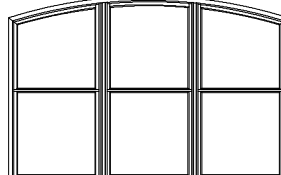

EWDS4592-3

ELEVATION SYMBOL LEGEND:
M.O. = MASONRY OPENING
VALUES IN () ARE IN MILLIMETER CONVERSIONS
VALUES IN [] ARE NUMBER OF DAYLIGHT OPENINGS PER UNIT

Note: Elevations shown DO NOT have exterior trim. Subtract 1/2" (12.7) from M.O. (Masonry Opening) for Unit Sizes. Masonry Openings above include Sill Nose, see Trim Options page for Sill Nose specifications. For other Trim Options refer to the Unit Sizing, Rough Opening & Masonry Openings page.

SCALE 1/8" = 1'

FULL RADIUS UNITS

M.O. BRICKMOULD
M.O. ADAMS/FLAT CASING
ROUGH OPENING
FRAME SIZE
DAYLIGHT OPENING

32 1/2" (826)
35 1/2" (902)
30 1/8" (765)
29 3/8" (746)
22 13/16" (579)

34 1/2" (876)
37 1/2" (953)
32 1/8" (816)
31 3/8" (797)
24 13/16" (630)

36 1/2" (927)
39 1/2" (1003)
34 1/8" (867)
33 3/8" (848)
26 13/16" (681)

40 1/2" (1029)
43 1/2" (1105)
38 1/8" (968)
37 3/8" (949)
30 13/16" (783)

44 1/2" (1130)
47 1/2" (1207)
42 1/8" (1070)
41 3/8" (1051)
34 13/16" (884)

48 1/2" (1232)
51 1/2" (1308)
46 1/8" (1172)
45 3/8" (1153)
38 13/16" (986)

54 11/16" (1389)
55 3/16" (1427)
52 3/4" (1340)
52" (1321)
21 1/16" (535) [2]

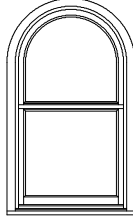

EWDF2952

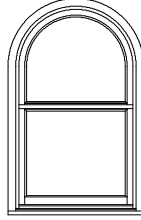

EWDF3152

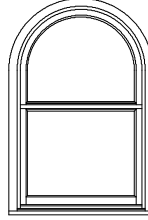

EWDF3352

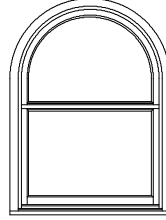

EWDF3752

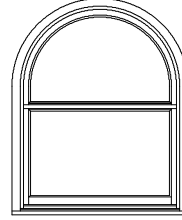

EWDF4152

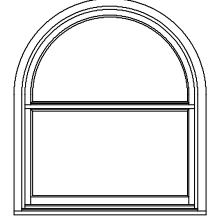

EWDF4552

58 11/16" (1491)
60 3/16" (1529)
56 3/4" (1441)
56" (1422)
23 1/16" (586) 23 5/16" (592)

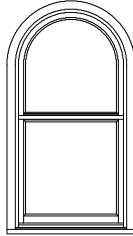

EWDF2956

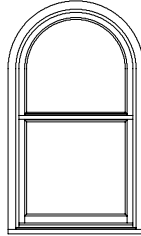

EWDF3156

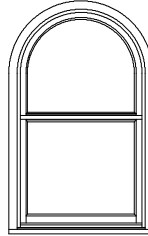

EWDF3356

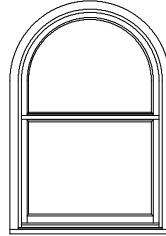

EWDF3756

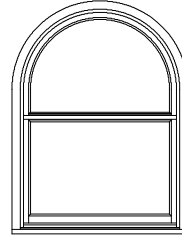

EWDF4156

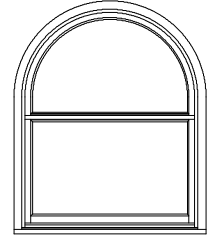

EWDF4556

62 11/16" (1592)
64 3/16" (1630)
60 3/4" (1543)
60" (1524)
25 1/16" (637) 25 5/16" (643)

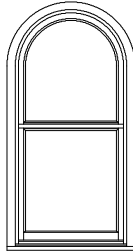

EWDF2960

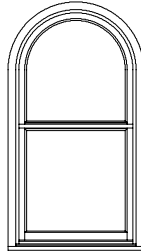

EWDF3160

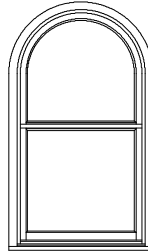

EWDF3360

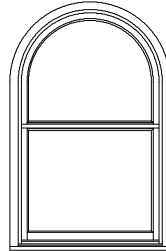

EWDF3760

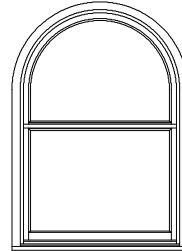

EWDF4160

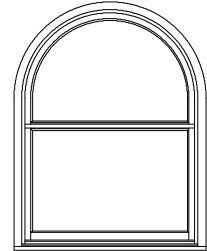

EWDF4560

66 11/16" (1694)
68 3/16" (1732)
64 3/4" (1645)
64" (1626)
27 1/16" (687) 27 5/16" (694)

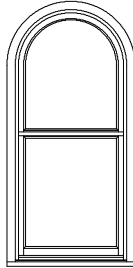

EWDF2964

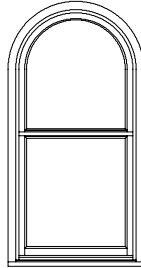

EWDF3164

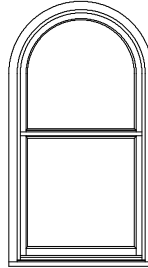

EWDF3364

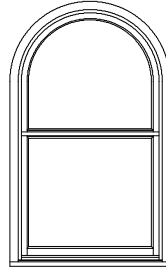

EWDF3764

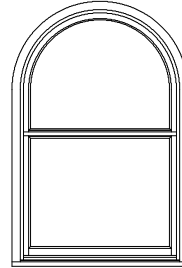

EWDF4164

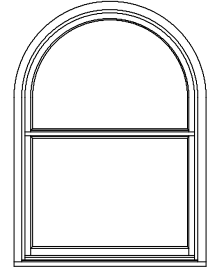

EWDF4564

70 11/16" (1795)
72 3/16" (1834)
68 3/4" (1746)
68" (1727)
29 1/16" (738) 29 5/16" (745)

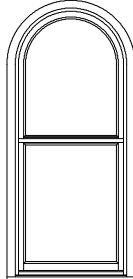

EWDF2968

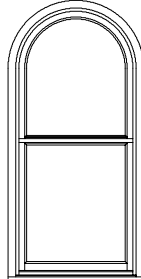

EWDF3168

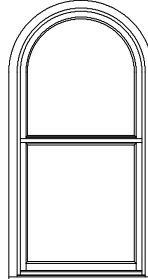

EWDF3368

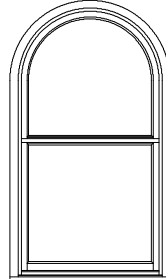

EWDF3768

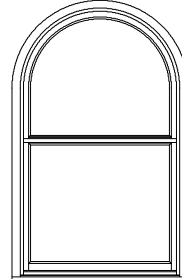

EWDF4168

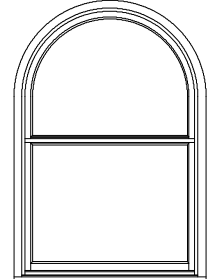

EWDF4568

ELEVATION SYMBOL LEGEND:
M.O. = MASONRY OPENING
VALUES IN () ARE IN MILLIMETER CONVERSIONS
VALUES IN [] ARE NUMBER OF DAYLIGHT OPENINGS PER UNIT

Note: Elevations shown DO NOT have exterior trim. Subtract 1/2" (12.7) from M.O. (Masonry Opening) for Unit Sizes. Masonry Openings above include Sill Nose, see Trim Options page for Sill Nose specifications. For other Trim Options refer to the Unit Sizing, Rough Opening & Masonry Openings page.

SCALE 1/4" = 1'

FULL RADIUS UNITS

M.O. BRICKMOULD	32 1/2" (826)	34 1/2" (876)	36 1/2" (927)	40 1/2" (1029)	44 1/2" (1130)	48 1/2" (1232)
M.O. ADAMS/FLAT CASING	35 1/2" (902)	37 1/2" (953)	39 1/2" (1003)	43 1/2" (1105)	47 1/2" (1207)	51 1/2" (1308)
ROUGH OPENING	30 1/8" (765)	32 1/8" (816)	34 1/8" (867)	38 1/8" (968)	42 1/8" (1070)	46 1/8" (1172)
FRAME SIZE	29 3/8" (746)	31 3/8" (797)	33 3/8" (848)	37 3/8" (949)	41 3/8" (1051)	45 3/8" (1153)
DAYLIGHT OPENING	22 13/16" (579)	24 13/16" (630)	26 13/16" (681)	30 13/16" (783)	34 13/16" (884)	38 13/16" (986)

74 11/16" (1897)
76 3/16" (1935)
72 3/4" (1848)
72" (1829)
31 1/16" (789) 31 5/16" (795)

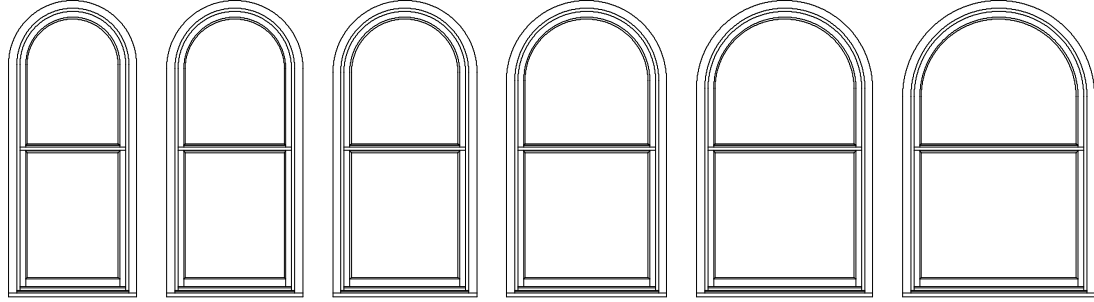

78 11/16" (1999)
80 3/16" (2037)
76 3/4" (1949)
76 5/8" (1930)
33 1/16" (840) [2]

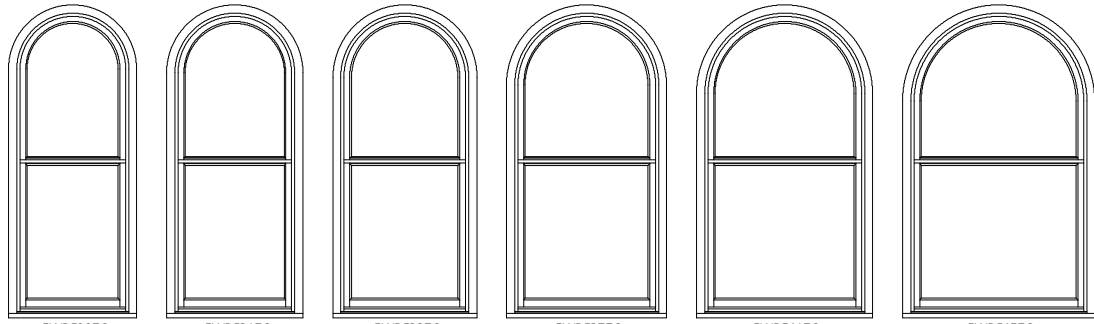

82 11/16" (2100)
84 3/16" (2138)
80 3/4" (2051)
80 1/2" (2032)
35 1/16" (891) [2]

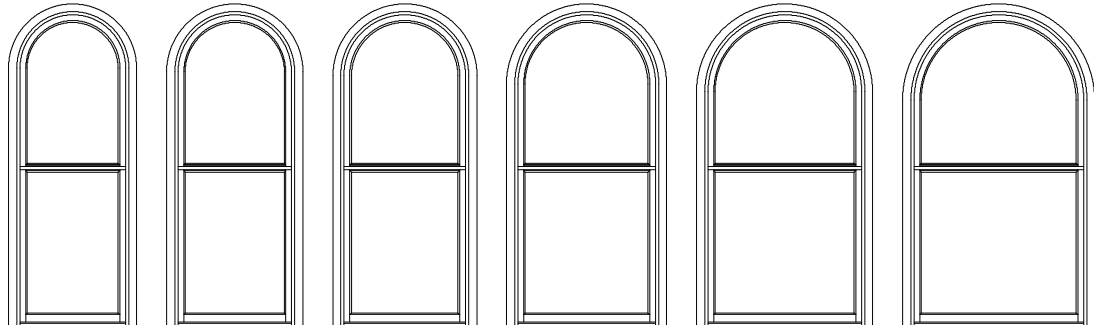

90 11/16" (2303)
92 3/16" (2342)
88 3/4" (2254)
88 5/8" (2235)
39 1/16" (992) [2]

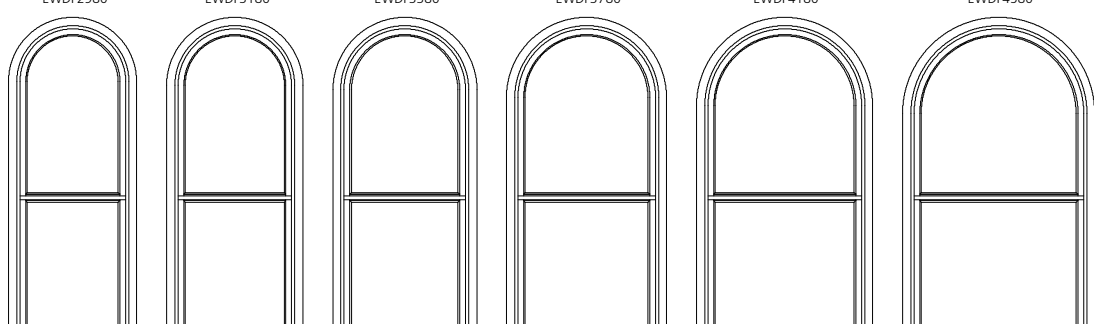

ELEVATION SYMBOL LEGEND:
M.O. = MASONRY OPENING
VALUES IN () ARE IN MILLIMETER CONVERSIONS
VALUES IN [] ARE NUMBER OF DAYLIGHT OPENINGS PER UNIT

Note: Elevations shown DO NOT have exterior trim. Subtract 1/2" (12.7) from M.O. (Masonry Opening) for Unit Sizes. Masonry Openings above include Sill Nose, see Trim Options page for Sill Nose specifications. For other Trim Options refer to the Unit Sizing, Rough Opening & Masonry Openings page.

SCALE 1/4" = 1'

FULL RADIUS UNITS

M.O. BRICKMOULD	32 1/2"(826)	34 1/2"(876)	36 1/2"(927)	40 1/2"(1029)	44 1/2"(1130)	48 1/2"(1232)
M.O. ADAMS/FLAT CASING	35 1/2"(902)	37 1/2"(953)	39 1/2"(1003)	43 1/2"(1105)	47 1/2"(1207)	51 1/2"(1308)
ROUGH OPENING	30 1/8"(765)	32 1/8"(816)	34 1/8"(867)	38 1/8"(968)	42 1/8"(1070)	46 1/8"(1172)
FRAME SIZE	29 3/8"(746)	31 3/8"(797)	33 3/8"(848)	37 3/8"(949)	41 3/8"(1051)	45 3/8"(1153)
DAYLIGHT OPENING	22 13/16"(579)	24 13/16"(630)	26 13/16"(681)	30 13/16"(783)	34 13/16"(884)	38 13/16"(986)

94 11/16"(2405)
96 3/16"(2443)
92 3/4"(2356)
92"(2337)
41 1/16"(1043)[2]

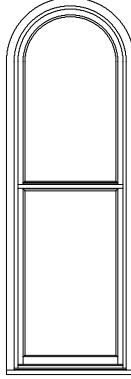

EWDF2992

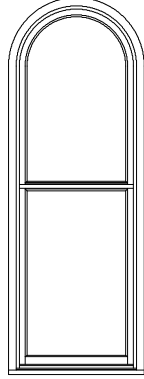

EWDF3192

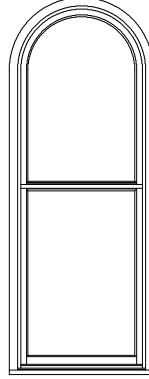

EWDF3392

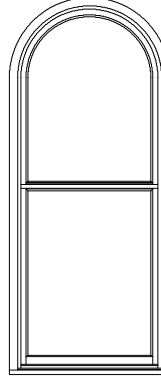

EWDF3792

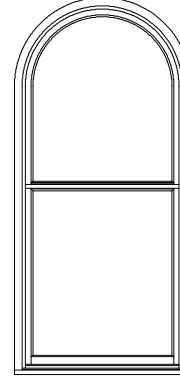

EWDF4192

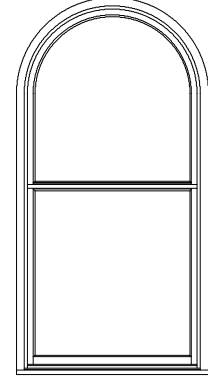

EWDF4592

ELEVATION SYMBOL LEGEND:
M.O. = MASONRY OPENING
VALUES IN () ARE IN MILLIMETER CONVERSIONS
VALUES IN [] ARE NUMBER OF DAYLIGHT OPENINGS PER UNIT

Note: Elevations shown DO NOT have exterior trim. Subtract 1/2" (12.7) from M.O. (Masonry Opening) for Unit Sizes. Masonry Openings above include Sill Nose, see Trim Options page for Sill Nose specifications. For other Trim Options refer to the Unit Sizing, Rough Opening & Masonry Openings page.

SCALE 1/4" = 1'

FULL RADIUS PICTURE UNITS

M.O. BRICKMOULD
M.O. ADAMS/FLAT CASING
ROUGH OPENING
FRAME SIZE
DAYLIGHT OPENING

32 1/2" (826)	34 1/2" (876)	36 1/2" (927)	40 1/2" (1029)	44 1/2" (1130)	48 1/2" (1232)
35 1/2" (902)	37 1/2" (953)	39 1/2" (1003)	43 1/2" (1105)	47 1/2" (1207)	51 1/2" (1308)
30 1/8" (765)	32 1/8" (816)	34 1/8" (867)	38 1/8" (968)	42 1/8" (1070)	46 1/8" (1172)
29 3/8" (746)	31 3/8" (797)	33 3/8" (848)	37 3/8" (949)	41 3/8" (1051)	45 3/8" (1153)
22 13/16" (579)	24 13/16" (630)	26 13/16" (681)	30 13/16" (783)	34 13/16" (884)	38 13/16" (986)

54 11/16" (1389) 56 3/16" (1427) 52 3/4" (1340) 52" (1321) 44 5/16" (1126)						
58 11/16" (1491) 60 3/16" (1529) 56 3/4" (1441) 56" (1422) 48 5/16" (1227)						
62 11/16" (1592) 64 3/16" (1630) 60 3/4" (1543) 60" (1524) 52 5/16" (1329)						
66 11/16" (1694) 68 3/16" (1732) 64 3/4" (1645) 64" (1626) 56 5/16" (1430)						
70 11/16" (1795) 72 3/16" (1834) 68 3/4" (1746) 68" (1727) 60 5/16" (1532)						

ELEVATION SYMBOL LEGEND:
M.O. = MASONRY OPENING
VALUES IN () ARE IN MILLIMETER CONVERSIONS

Note: Elevations shown DO NOT have exterior trim. Subtract 1/2" (12.7) from M.O. (Masonry Opening) for Unit Sizes. Masonry Openings above include Sill Nose, see Trim Options page for Sill Nose specifications. For other Trim Options refer to the Unit Sizing, Rough Opening & Masonry Openings page.

SCALE 1/4" = 1'

FULL RADIUS PICTURE UNITS

M.O. BRICKMOULD	32 1/2" (826)	34 1/2" (876)	36 1/2" (927)	40 1/2" (1029)	44 1/2" (1130)	48 1/2" (1232)
M.O. ADAMS/FLAT CASING	35 1/2" (902)	37 1/2" (953)	39 1/2" (1003)	43 1/2" (1105)	47 1/2" (1207)	51 1/2" (1308)
ROUGH OPENING	30 1/8" (765)	32 1/8" (816)	34 1/8" (867)	38 1/8" (968)	42 1/8" (1070)	46 1/8" (1172)
FRAME SIZE	29 3/8" (746)	31 3/8" (797)	33 3/8" (848)	37 3/8" (949)	41 3/8" (1051)	45 3/8" (1153)
DAYLIGHT OPENING	22 13/16" (579)	24 13/16" (630)	26 13/16" (681)	30 13/16" (783)	34 13/16" (884)	38 13/16" (986)

74 11/16" (1897)
76 3/16" (1935)
72 3/4" (1848)
72" (1829)
64 5/16" (1634)

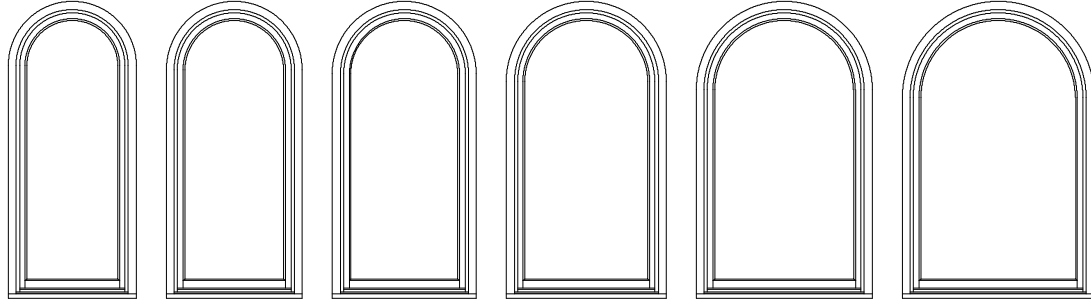

78 11/16" (1999)
80 3/16" (2037)
76 3/4" (1949)
76" (1930)
68 5/16" (1735)

82 11/16" (2100)
84 3/16" (2138)
80 3/4" (2051)
80" (2032)
72 5/16" (1837)

90 11/16" (2303)
92 3/16" (2342)
88 3/4" (2254)
88" (2235)
80 5/16" (2040)

ELEVATION SYMBOL LEGEND:
M.O. = MASONRY OPENING
VALUES IN () ARE IN MILLIMETER CONVERSIONS

Note: Elevations shown DO NOT have exterior trim. Subtract 1/2" (12.7) from M.O. (Masonry Opening) for Unit Sizes. Masonry Openings above include Sill Nose, see Trim Options page for Sill Nose specifications. For other Trim Options refer to the Unit Sizing, Rough Opening & Masonry Openings page.

SCALE 1/4" = 1'

FULL RADIUS PICTURE UNITS

M.O. BRICKMOULD	32 1/2"(826)	34 1/2"(876)	36 1/2"(927)	40 1/2"(1029)	44 1/2"(1130)	48 1/2"(1232)
M.O. ADAMS/FLAT CASING	35 1/2"(902)	37 1/2"(953)	39 1/2"(1003)	43 1/2"(1105)	47 1/2"(1207)	51 1/2"(1308)
ROUGH OPENING	30 1/8"(765)	32 1/8"(816)	34 1/8"(867)	38 1/8"(968)	42 1/8"(1070)	46 1/8"(1172)
FRAME SIZE	29 3/8"(746)	31 3/8"(797)	33 3/8"(848)	37 3/8"(949)	41 3/8"(1051)	45 3/8"(1153)
DAYLIGHT OPENING	22 13/16"(579)	24 13/16"(630)	26 13/16"(681)	30 13/16"(783)	34 13/16"(884)	38 13/16"(986)

94 11/16"(2405)
96 3/16"(2443)
92 3/4"(2356)
92"(2337)
84 5/16"(2142)

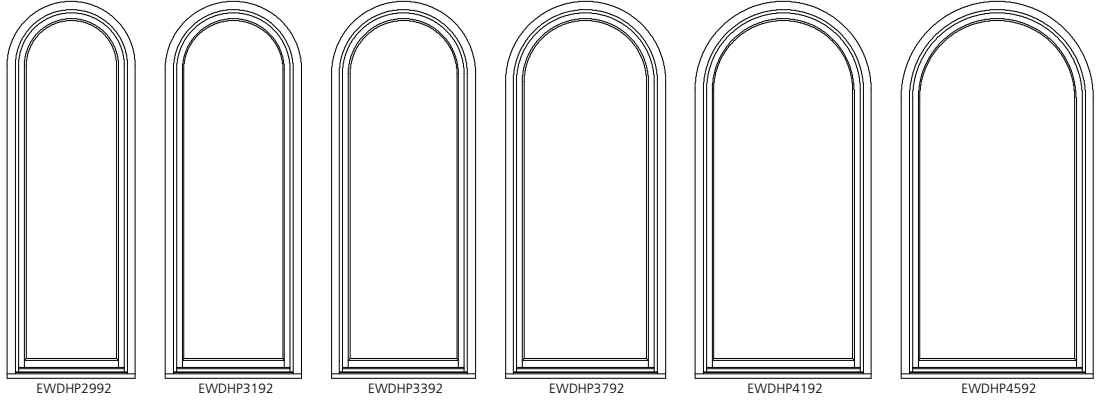

ELEVATION SYMBOL LEGEND:
M.O. = MASONRY OPENING
VALUES IN () ARE IN MILLIMETER CONVERSIONS

Note: Elevations shown DO NOT have exterior trim. Subtract 1/2" (12.7) from M.O. (Masonry Opening) for Unit Sizes. Masonry Openings above include Sill Nose, see Trim Options page for Sill Nose specifications. For other Trim Options refer to the Unit Sizing, Rough Opening & Masonry Openings page.

SCALE 1/4" = 1'

FULL RADIUS PICTURE UNITS

M.O. BRICKMOULD
M.O. ADAMS/FLAT CASING
ROUGH OPENING
FRAME SIZE
DAYLIGHT OPENING

52 1/2"(1334)
55 1/2"(1410)
50 1/8"(1273)
49 3/8"(1254)
42 13/16"(1087)

56 1/2"(1435)
59 1/2"(1511)
54 1/8"(1375)
53 3/8"(1356)
46 13/16"(1189)

64 1/2"(1638)
67 1/2"(1715)
62 1/8"(1578)
61 3/8"(1559)
54 13/16"(1392)

72 1/2"(1842)
75 1/2"(1918)
70 1/8"(1781)
69 3/8"(1762)
62 13/16"(1595)

54 11/16"(1389)
56 3/16"(1427)
52 3/4"(1340)
52"(1321)
44 5/16"(1126)

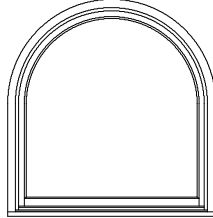

EWDHP4952

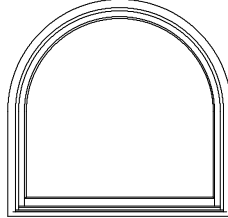

EWDHP5352

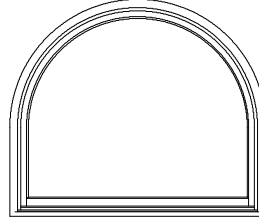

EWDHP6152

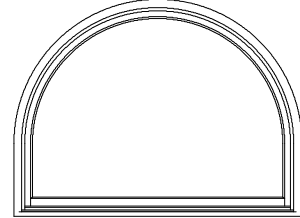

EWDHP6952

58 11/16"(1491)
60 3/16"(1529)
56 3/4"(1441)
56"(1422)
48 5/16"(1227)

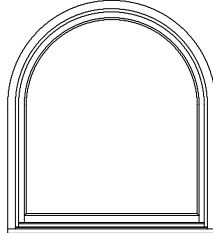

EWDHP4956

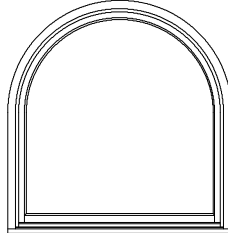

EWDHP5356

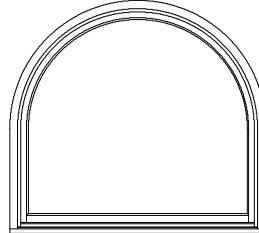

EWDHP6156

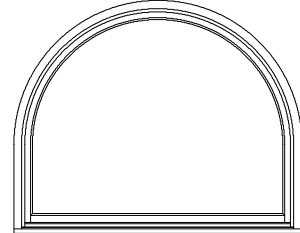

EWDHP6956

62 11/16"(1592)
64 3/16"(1630)
60 3/4"(1543)
60"(1524)
52 5/16"(1329)

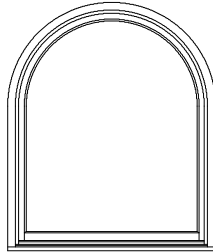

EWDHP4960

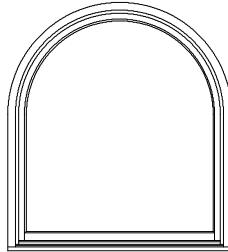

EWDHP5360

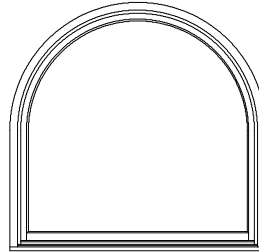

EWDHP6160

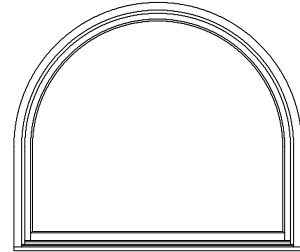

EWDHP6960

66 11/16"(1694)
68 3/16"(1732)
64 3/4"(1645)
64"(1626)
56 5/16"(1430)

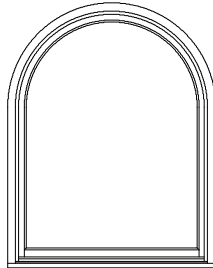

EWDHP4964

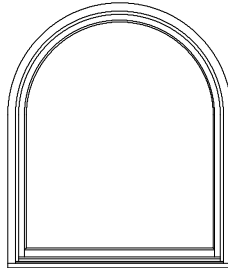

EWDHP5364

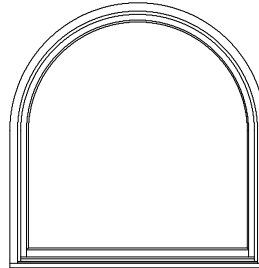

EWDHP6164

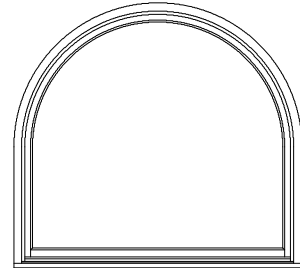

EWDHP6964

70 11/16"(1795)
72 3/16"(1834)
68 3/4"(1746)
68"(1727)
60 5/16"(1532)

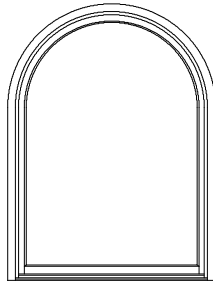

EWDHP4968

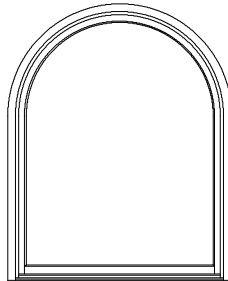

EWDHP5368

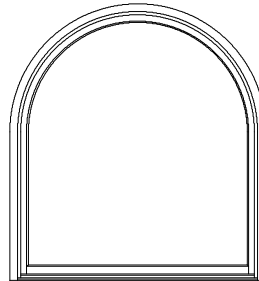

EWDHP6168

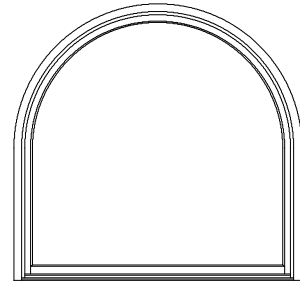

EWDHP6968

ELEVATION SYMBOL LEGEND:
M.O. = MASONRY OPENING
VALUES IN () ARE IN MILLIMETER CONVERSIONS

Note: Elevations shown DO NOT have exterior trim. Subtract 1/2" (12.7) from M.O. (Masonry Opening) for Unit Sizes. Masonry Openings above include Sill Nose, see Trim Options page for Sill Nose specifications. For other Trim Options refer to the Unit Sizing, Rough Opening & Masonry Openings page.

SCALE 1/4" = 1'

FULL RADIUS PICTURE UNITS

M.O. BRICKMOULD
M.O. ADAMS/FLAT CASING
ROUGH OPENING
FRAME SIZE
DAYLIGHT OPENING

52 1/2" (1334)
55 1/2" (1410)
50 1/8" (1273)
49 3/8" (1254)
42 13/16" (1087)

56 1/2" (1435)
59 1/2" (1511)
54 1/8" (1375)
53 3/8" (1356)
46 13/16" (1189)

64 1/2" (1638)
67 1/2" (1715)
62 1/8" (1578)
61 3/8" (1559)
54 13/16" (1392)

72 1/2" (1842)
75 1/2" (1918)
70 1/8" (1781)
69 3/8" (1762)
62 13/16" (1595)

74 11/16" (1897)
76 3/16" (1935)
72 3/4" (1848)
72" (1829)
64 5/16" (1634)

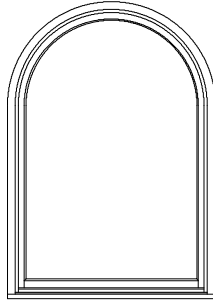

EWDHP4972

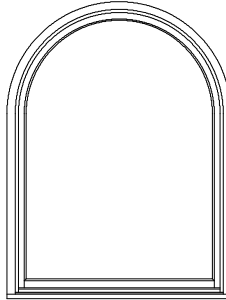

EWDHP5372

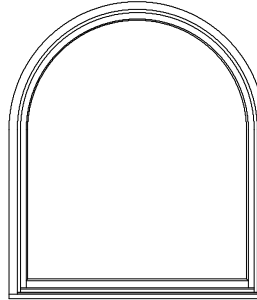

EWDHP6172

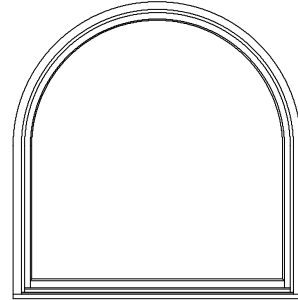

EWDHP6972

78 11/16" (1999)
80 3/16" (2037)
76 3/4" (1949)
76" (1930)
68 5/16" (1735)

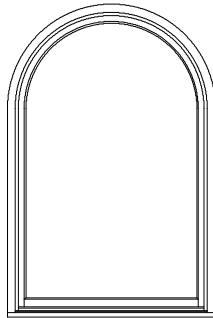

EWDHP4976

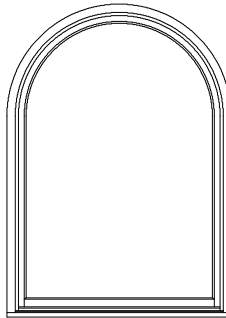

EWDHP5376

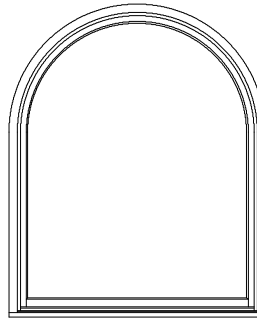

EWDHP6176

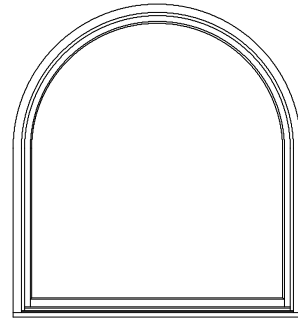

EWDHP6976

82 11/16" (2100)
84 3/16" (2138)
80 3/4" (2051)
80" (2032)
72 5/16" (1837)

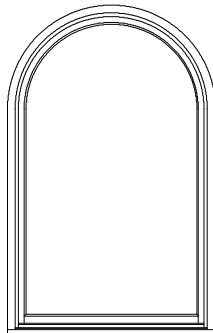

EWDHP4980

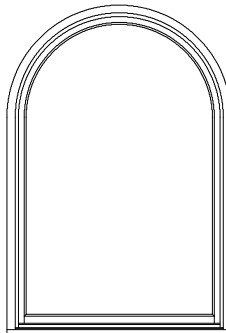

EWDHP5380

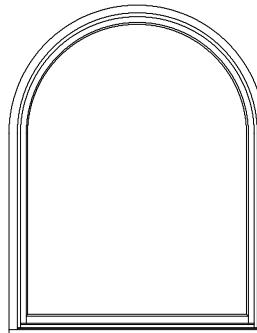

EWDHP6180

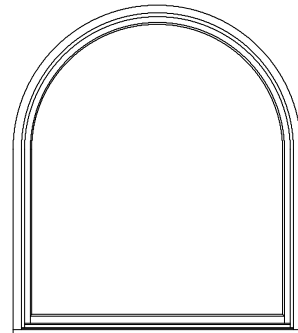

EWDHP6980

90 11/16" (2303)
92 3/16" (2342)
88 3/4" (2254)
88" (2235)
80 5/16" (2040)

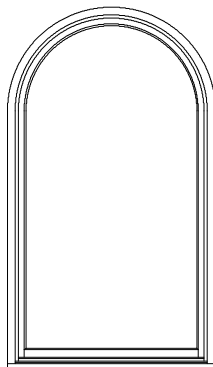

EWDHP4988

ELEVATION SYMBOL LEGEND:
M.O. = MASONRY OPENING
VALUES IN () ARE IN MILLIMETER CONVERSIONS

Note: Elevations shown DO NOT have exterior trim. Subtract 1/2" (12.7) from M.O. (Masonry Opening) for Unit Sizes. Masonry Openings above include Sill Nose, see Trim Options page for Sill Nose specifications. For other Trim Options refer to the Unit Sizing, Rough Opening & Masonry Openings page.

SCALE 1/4" = 1'

FULL RADIUS PICTURE UNITS

M.O. BRICKMOULD	52 1/2" (1334)
M.O. ADAMS/FLAT CASING	55 1/2" (1410)
ROUGH OPENING	50 1/8" (1273)
FRAME SIZE	49 3/8" (1254)
DAYLIGHT OPENING	42 13/16" (1087)

94 11/16" (2405)
96 3/16" (2443)
92 3/4" (2356)
92" (2337)
84 5/16" (2142)

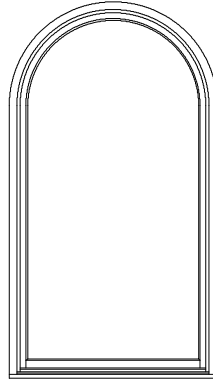

EWDHP4992

ELEVATION SYMBOL LEGEND:
M.O. = MASONRY OPENING
VALUES IN () ARE IN MILLIMETER CONVERSIONS

Note: Elevations shown DO NOT have exterior trim. Subtract 1/2" (12.7) from M.O. (Masonry Opening) for Unit Sizes. Masonry Openings above include Sill Nose, see Trim Options page for Sill Nose specifications. For other Trim Options refer to the Unit Sizing, Rough Opening & Masonry Openings page.

SCALE 1/4" = 1'

FULL RADIUS PICTURE UNITS

M.O. BRICKMOULD
M.O. ADAMS/FLAT CASING
ROUGH OPENING
FRAME SIZE
DAYLIGHT OPENING

80 1/2" (2045)
83 1/2" (2121)
78 1/8" (1984)
77 3/8" (1965)
70 13/16" (1799)

M.O. BRICKMOULD
M.O. ADAMS/FLAT CASING
ROUGH OPENING
FRAME SIZE
DAYLIGHT OPENING

80 1/2" (2045)
83 1/2" (2121)
78 1/8" (1984)
77 3/8" (1965)
70 13/16" (1799)

54 11/16" (1389)
56 3/16" (1427)
52 3/4" (1340)
52" (1321)
44 5/16" (1126)

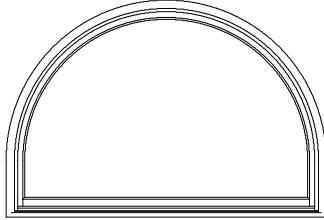

EWDHP7752

58 11/16" (1491)
60 3/16" (1529)
56 3/4" (1441)
56" (1422)
48 5/16" (1227)

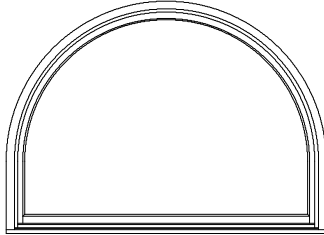

EWDHP7756

62 11/16" (1592)
64 3/16" (1630)
60 3/4" (1543)
60" (1524)
52 5/16" (1329)

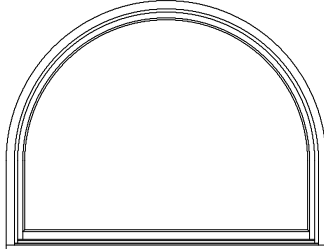

EWDHP7760

66 11/16" (1694)
68 3/16" (1732)
64 3/4" (1645)
64" (1626)
56 5/16" (1430)

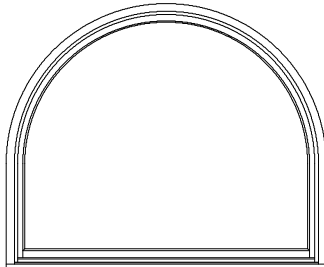

EWDHP7764

70 11/16" (1795)
72 3/16" (1833)
68 3/4" (1746)
68" (1727)
60 5/16" (1532)

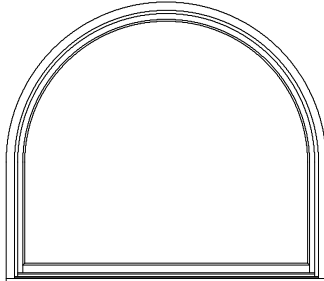

EWDHP7768

74 11/16" (1897)
76 3/16" (1935)
72 3/4" (1848)
72" (1829)
64 5/16" (1634)

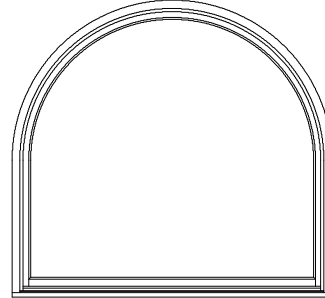

EWDHP7772

78 11/16" (1999)
80 3/16" (2037)
76 3/4" (1949)
76" (1930)
68 5/16" (1735)

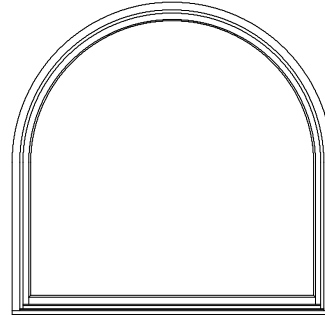

EWDHP7776

82 11/16" (2100)
84 3/16" (2138)
80 3/4" (2051)
80" (2032)
72 5/16" (1837)

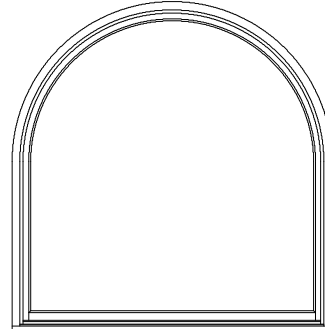

EWDHP7780

ELEVATION SYMBOL LEGEND:
M.O. = MASONRY OPENING
VALUES IN () ARE IN MILLIMETER CONVERSIONS

Note: Elevations shown DO NOT have exterior trim. Subtract 1/2" (12.7) from M.O. (Masonry Opening) for Unit Sizes. Masonry Openings above include Sill Nose, see Trim Options page for Sill Nose specifications. For other Trim Options refer to the Unit Sizing, Rough Opening & Masonry Openings page.

SCALE 1/4" = 1'

ELEVATION NOTES
DOUBLE-HUNG TRANSOM

ELEVATION DRAWINGS UTILIZE A LIMITED NUMBER OF PROJECTED LINES TO PRODUCE A RUDIMENTARY DRAWING INTENDED TO BE USED IN A SMALL GRAPHICAL SCALE. ELEVATIONS ARE VIEWED PERPENDICULAR FROM THE EXTERIOR OF THE STRUCTURE. IF MORE DIMENSIONS ARE NEEDED, USE THE SECTION DRAWINGS FOR MORE COMPLETE DEPICTIONS.

M.O. Brickmould	24 1/2" (645)	 Masonry Openings for Brickmould, Flat & Adams Casing. Vertical measurements include sillnose. (Subtract 1/2" from Masonry Opening for Unit Size)
M.O. Adams/Flat Casing	27 1/2" (699)	
Rough Opening	22 1/8" (562)	
Frame Size	21 3/8" (543)	
Daylight Opening	14 13/16" (376)	

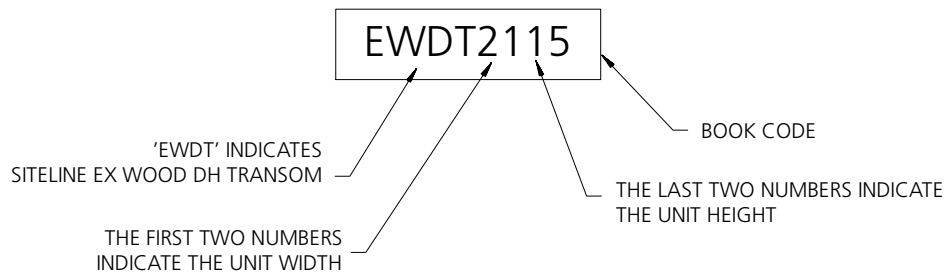
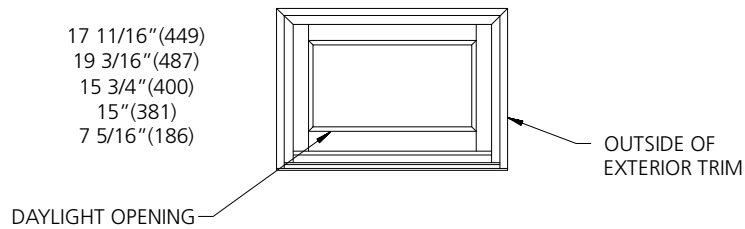

GENERAL DOUBLE HUNG TRANSOM NOTES

1. ALL UNITS SHOWN ARE AVAILABLE AS STATIONARY ONLY.
2. UNIT ELEVATIONS ARE SHOWN WITH BRICKMOULD & SILLNOSE.
3. DIMENSIONAL VALUES IN PARENTHESES ARE MILLIMETER CONVERSIONS.

ELEVATION SYMBOL LEGEND:

MO MASONRY OPENING

TRANSOM UNITS

M.O. BRICKMOULD	24 1/2" (622)	28 1/2" (724)	32 1/2" (826)	34 1/2" (876)	36 1/2" (927)	40 1/2" (1029)	44 1/2" (1130)
M.O. ADAMS/FLAT CASING	27 1/2" (699)	31 1/2" (800)	35 1/2" (902)	37 1/2" (953)	39 1/2" (1003)	43 1/2" (1105)	47 1/2" (1207)
ROUGH OPENING	22 1/8" (562)	26 1/8" (664)	30 1/8" (765)	32 1/8" (816)	34 1/8" (867)	38 1/8" (968)	42 1/8" (1070)
FRAME SIZE	21 3/8" (543)	25 3/8" (645)	29 3/8" (746)	31 3/8" (797)	33 3/8" (848)	37 3/8" (949)	41 3/8" (1051)
DAYLIGHT OPENING	14 13/16" (376)	18 13/16" (478)	22 13/16" (579)	24 13/16" (630)	26 13/16" (681)	30 13/16" (783)	34 13/16" (884)
17 11/16" (449)							
19 3/16" (487)							
15 3/4" (400)							
15" (381)							
7 5/16" (186)							
20 11/16" (525)							
22 3/16" (564)							
18 3/4" (476)							
18" (457)							
10 5/16" (262)							
26 11/16" (678)							
28 3/16" (716)							
24 3/4" (629)							
24" (610)							
16 5/16" (414)							

M.O. BRICKMOULD	48 1/2" (1232)	52 1/2" (1334)	56 1/2" (1435)	64 1/2" (1638)
M.O. ADAMS/FLAT CASING	51 1/2" (1308)	55 1/2" (1410)	59 1/2" (1511)	67 1/2" (1715)
ROUGH OPENING	46 1/8" (1172)	50 1/8" (1273)	54 1/8" (1375)	62 1/8" (1578)
FRAME SIZE	45 3/8" (1153)	49 3/8" (1254)	53 3/8" (1356)	61 3/8" (1559)
DAYLIGHT OPENING	38 13/16" (986)	42 13/16" (1087)	46 13/16" (1189)	54 13/16" (1392)
17 11/16" (449)				
19 3/16" (487)				
15 3/4" (400)				
15" (381)				
7 5/16" (186)				
20 11/16" (525)				
22 3/16" (564)				
18 3/4" (476)				
18" (457)				
10 5/16" (262)				
26 11/16" (678)				
28 3/16" (716)				
24 3/4" (629)				
24" (610)				
16 5/16" (414)				

M.O. BRICKMOULD	72 1/2" (1842)	80 1/2" (2045)
M.O. ADAMS/FLAT CASING	75 1/2" (1918)	83 1/2" (2121)
ROUGH OPENING	70 1/8" (1781)	78 1/8" (1984)
FRAME SIZE	69 3/8" (1762)	77 3/8" (1965)
DAYLIGHT OPENING	62 13/16" (1595)	70 13/16" (1799)
17 11/16" (449)		
19 3/16" (487)		
15 3/4" (400)		
15" (381)		
7 5/16" (186)		
20 11/16" (525)		
22 3/16" (564)		
18 3/4" (476)		
18" (457)		
10 5/16" (262)		
26 11/16" (678)		
28 3/16" (716)		
24 3/4" (629)		
24" (610)		
16 5/16" (414)		

ELEVATION SYMBOL LEGEND:
M.O. = MASONRY OPENING
VALUES IN () ARE IN MILLIMETER CONVERSIONS

Note: Elevations shown DO NOT have exterior trim. Subtract 1/2" (12.7) from M.O. (Masonry Opening) for Unit Sizes. Masonry Openings above include Sill Nose, see Trim Options page for Sill Nose specifications. For other Trim Options refer to the Unit Sizing, Rough Opening & Masonry Openings page.

SCALE 1/4" = 1'

SASH GLAZING OPTIONS

INTERIOR GLAZING OPTIONS

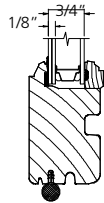

**DOUBLE-HUNG
3.5L//SS**

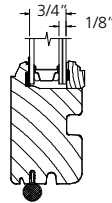

**DOUBLE-HUNG
SS//3.5L**

NOTE: SDL not available on textured glass.

SCALE 3" = 1'

TRIM & SILL OPTIONS
DOUBLE-HUNG

EXTERIOR TRIM

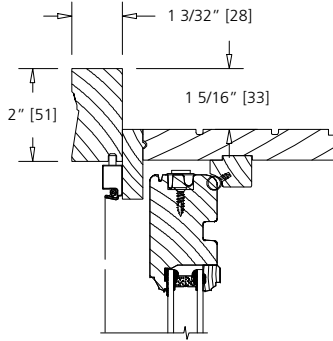

BRICKMOULD

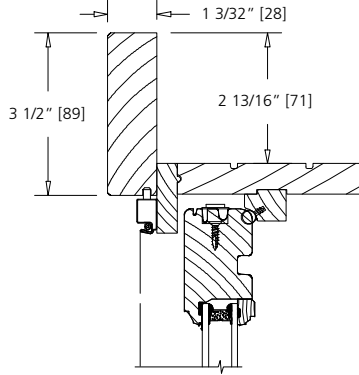

FLAT CASING

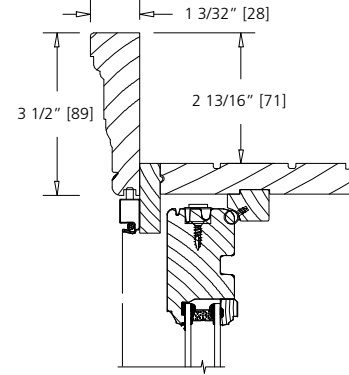

ADAMS CASING

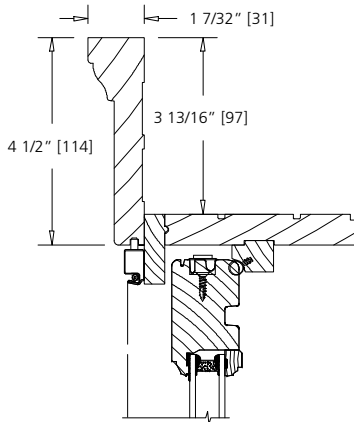

1 X 4 BACKBAND

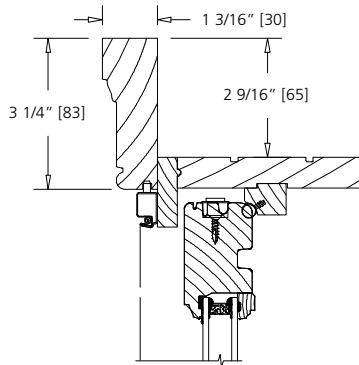

WILLIAMSBURG

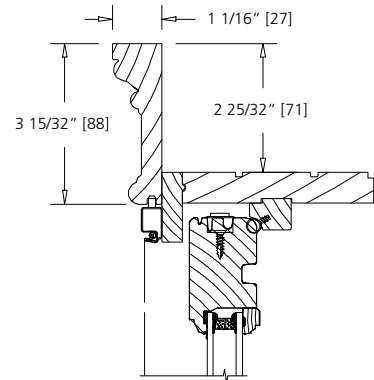

RB 3 CASING

SILL OPTIONS

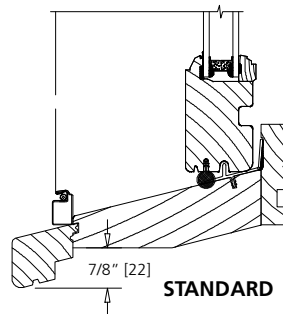

STANDARD

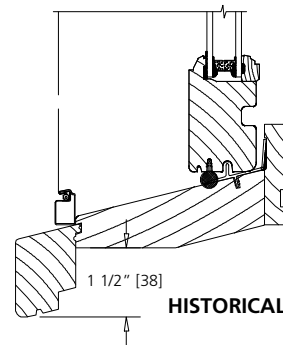

HISTORICAL

SCALE: 3" = 1'

TRIM & SILL OPTIONS
SECTOR TOP SINGLE-HUNG

EXTERIOR TRIM

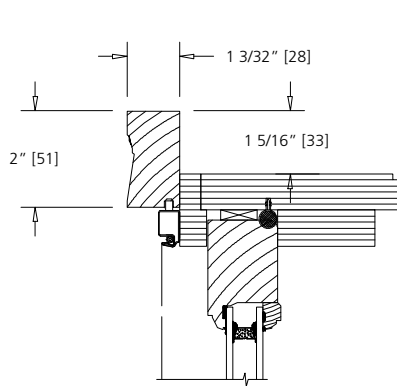

BRICKMOULD

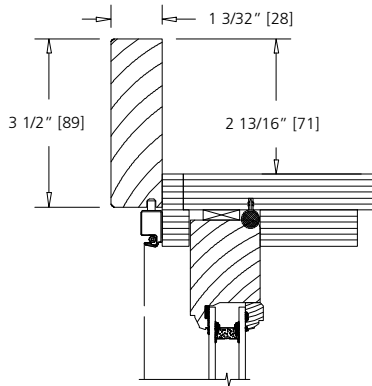

FLAT CASING

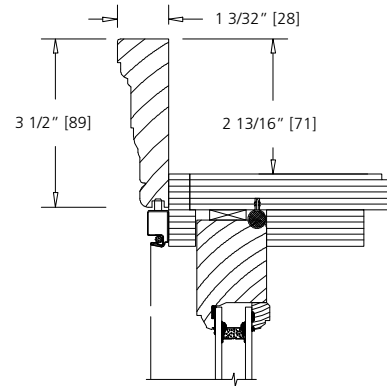

ADAMS CASING

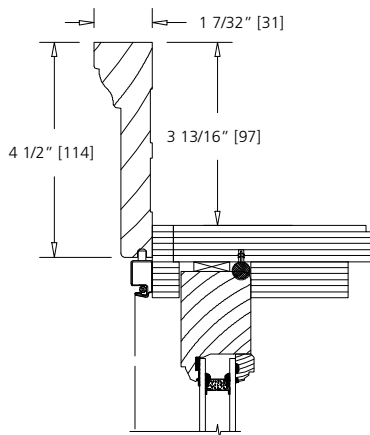

1 X 4 BACKBAND

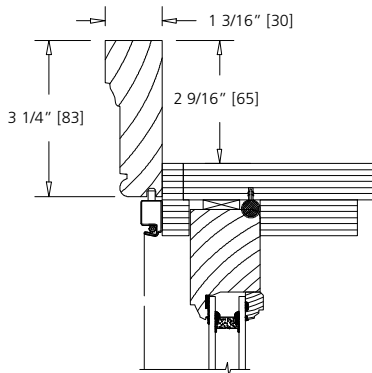

WILLIAMSBURG

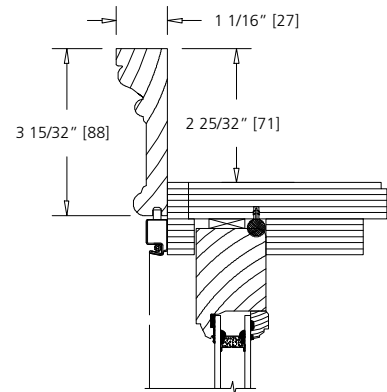

RB 3 CASING

SILL OPTIONS

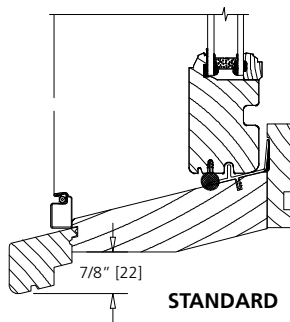

STANDARD

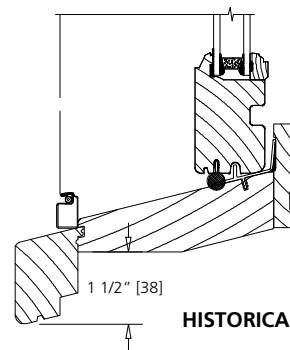

HISTORICAL

SCALE: 3" = 1'

JAMB EXTENDER OPTIONS

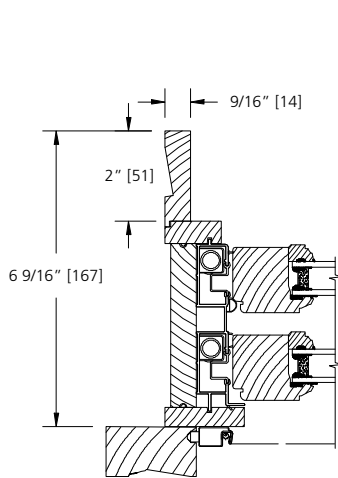

6 9/16" WALL
9/16" JAMB THICKNESS (OPTION)

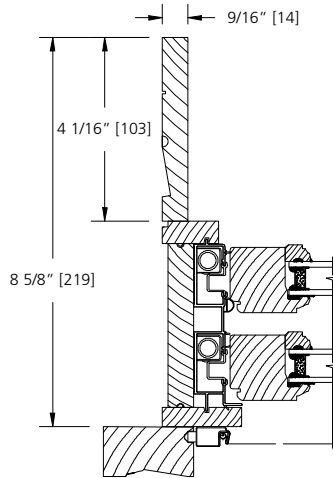

8 5/8" WALL

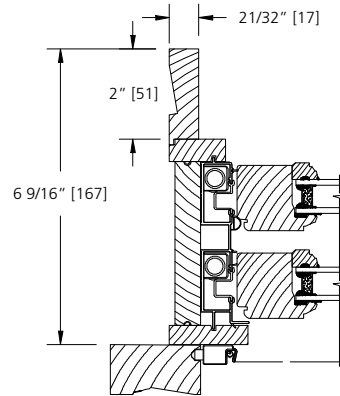

6 9/16" WALL
4/4 JAMB THICKNESS (STANDARD)

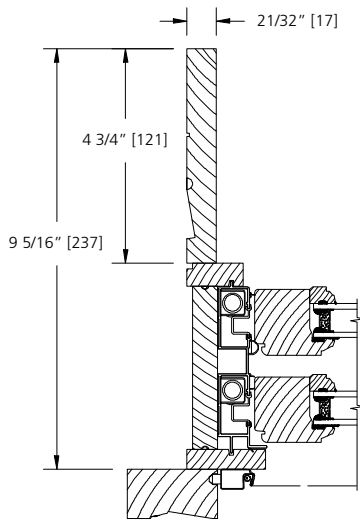

9 5/16" WALL

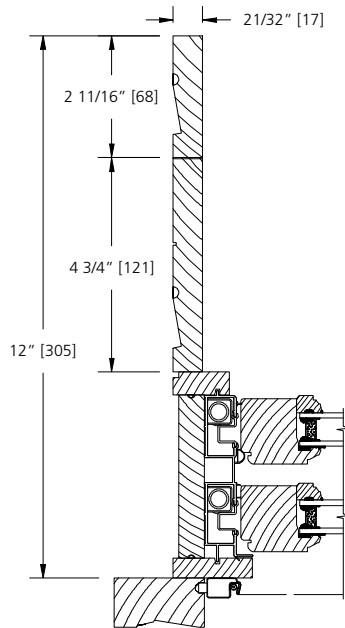

12" WALL
4/4 JAMB THICKNESS (STANDARD)
2 PC JAMB EXTENSION SHOWN

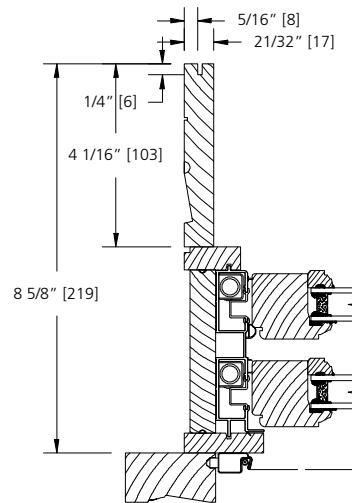

8 5/8" WALL
4/4 JAMB THICKNESS (STANDARD)
KERFED EXTENSION SHOWN

Notes:

Double-Hungs to have standard (4/4 thick) extension option.
Double-Hungs to have 9/16" thickness option & 4/4 kerfed option.

SCALE: 3" = 1'

STANDARD MULLION OPTIONS

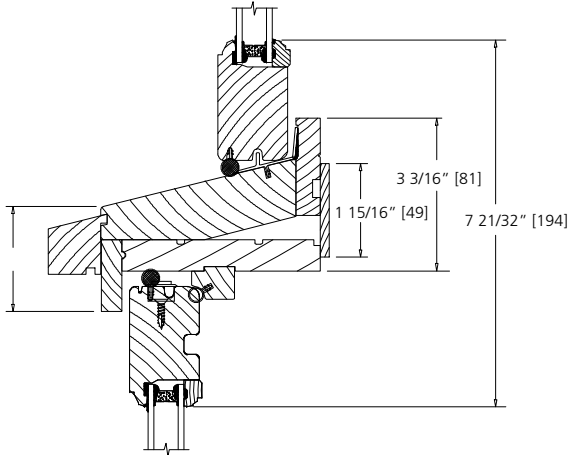

**OPERATING DOUBLE-HUNG
WITH FIXED TRANSOM**

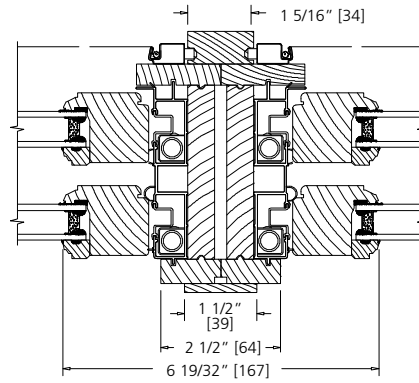

TWIN OPERATING DOUBLE-HUNG

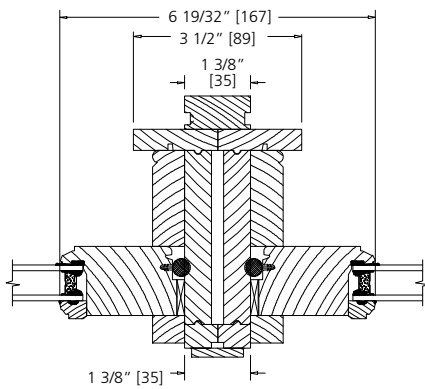

**DOUBLE-HUNG PICTURE
WITH DOUBLE-HUNG PICTURE**

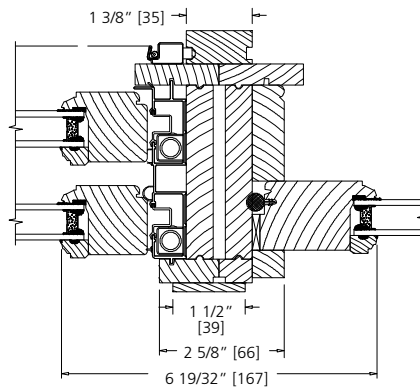

**TWIN OPERATING DOUBLE-HUNG
WITH PICTURE FLANKERS**

STANDARD MULLION OPTIONS

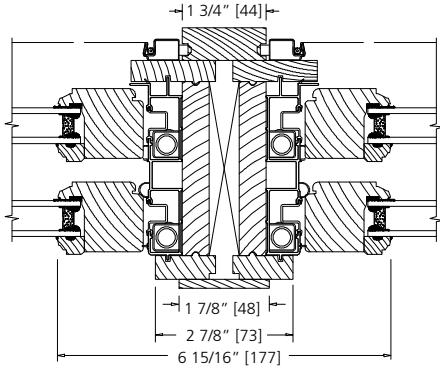

**TWIN OPERATING DOUBLE-HUNG
WITH 1" SOLID SPREAD MULLION**

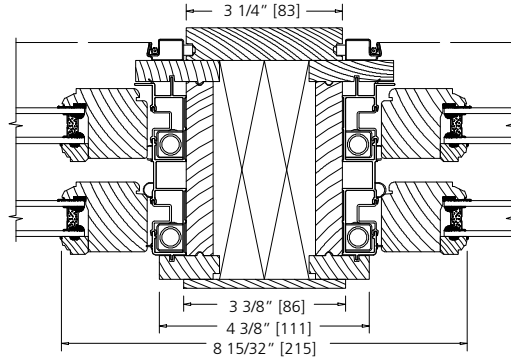

**TWIN OPERATING DOUBLE-HUNG
WITH 2" SOLID SPREAD MULLION**

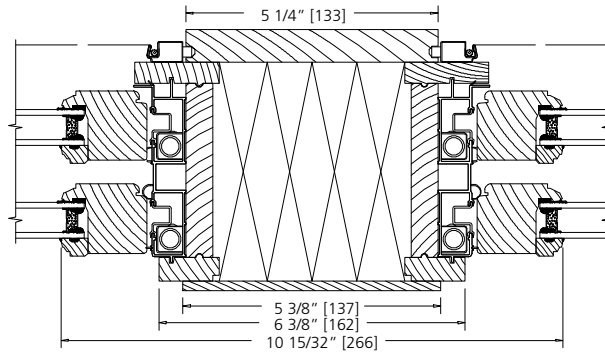

**TWIN OPERATING DOUBLE-HUNG
WITH 4" SOLID SPREAD MULLION**

LITE CUT INFORMATION

Wood double-hung windows are available in 7/8", 1-1/8" and 1-3/8" widths for SDL (Simulated Divided Lites); 5/8" Flat, 23/32" and 1" Contour GBG (Grilles between the Glass); and 7/8", 1-1/8" and 1-3/8" Full Surround removable grilles. Standard lite cuts are rectangular.

LITE CUT OPTIONS

Special lite cut patterns can include a wide variety of straight line and radius patterns. The illustrations shown here represent just a few of the possibilities. Rectangular, horizontal, vertical and Prairie lite patterns are available in all standard size wood double-hung windows. Uneven, diamond, radius and Gothic lite cuts are available, subject to approval. Approvals are based on the ability to fulfill the design requirement while maintaining the construction integrity of the finished product.

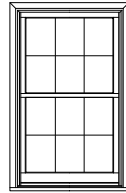

RECTANGULAR

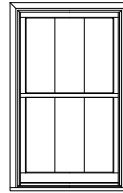

VERTICAL

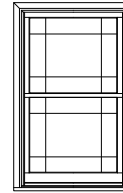

PRAIRIE

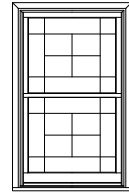

UNEVEN

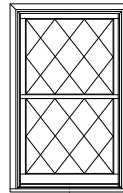

DIAMOND

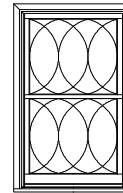

RADIUS

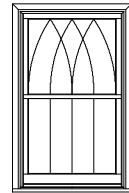

GOTHIC

BAR ALIGNMENT

Alignment of divided lite muntin bars from one window to the next is often required by fine architectural design. Wood grilles, GBG (Grilles between the Glass), and Simulated Divided Lites may be specified with muntin bars aligned.

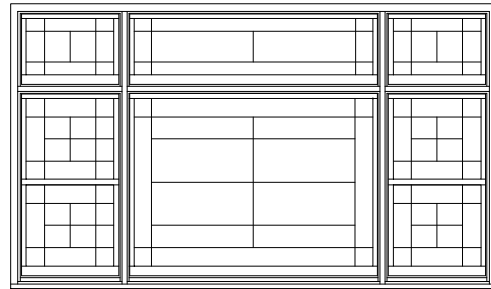

DIVIDED LITE OPTIONS

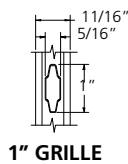
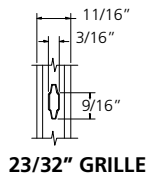
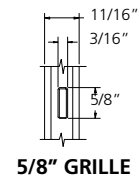
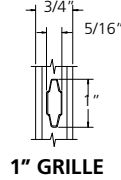
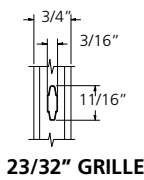
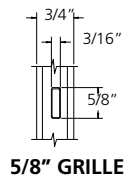
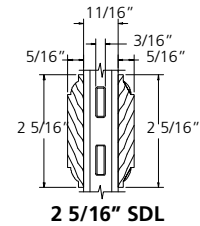
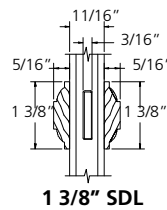
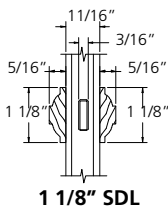
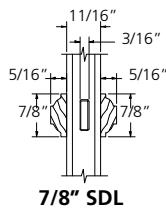
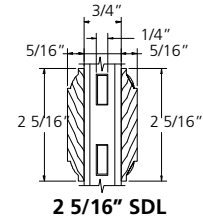
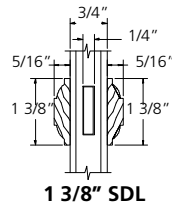
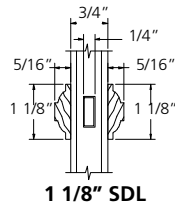
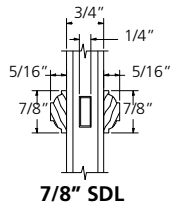

GRILLES MEETING
NFRC 3mm RULE

GRILLE PROFILES:

3/16" x 5/8"	ALLMETAL 1021101018XX140
3/16" x 1"	ALLMETAL 1020101018XX164
1/4" x 5/8"	ALLMETAL 1020102018XX140
1/4" x 1"	ALLMETAL 1020102018XX164
5.5mm x 18mm CONTOUR	ALLMETAL 1020301010XX255
8mm x 25mm CONTOUR	ALLMETAL 1020301018XX380

Note: All glass and airspace dimensions per current cardinal glass specs. Lites with shapes, angles or radii outside the Liscac Bender capabilities for stainless steel warm edge spacer will have aluminum box spacer with the same airspace dimension shown here.

SCALE 3" = 1'

**UNIT SIZING, ROUGH OPENINGS
& MASONRY OPENINGS
DOUBLE-HUNG**

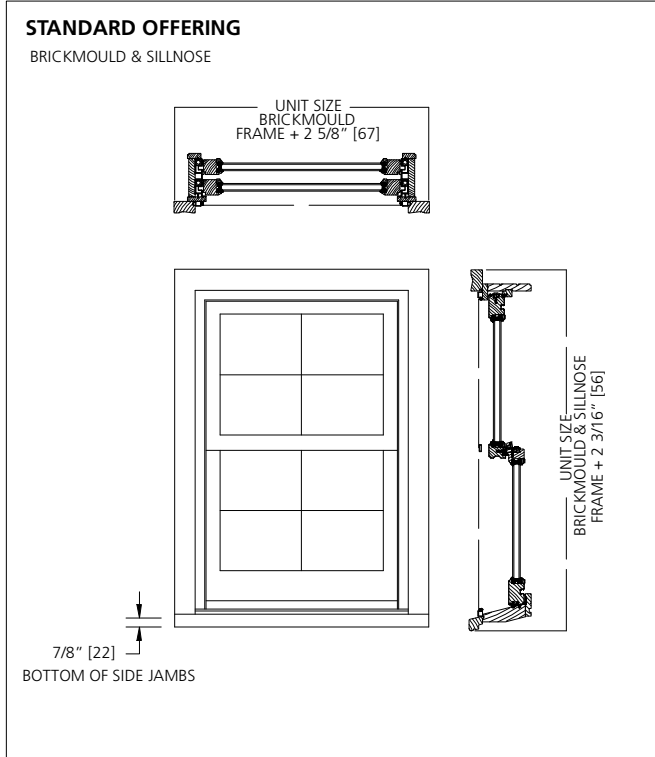

GENERAL NOTES:

UNITS WITH NO TRIM AND SILL NOSE:
UNIT SIZE = FRAME SIZE

UNIT SIZE IS ALWAYS THE
EXTREME SIZE OF THE WINDOW
WITH OR WITHOUT TRIM

MASONRY OPENING:
MASONRY OPENING IS ALWAYS 1/2" OVER
THE UNIT SIZE OF THE WINDOW

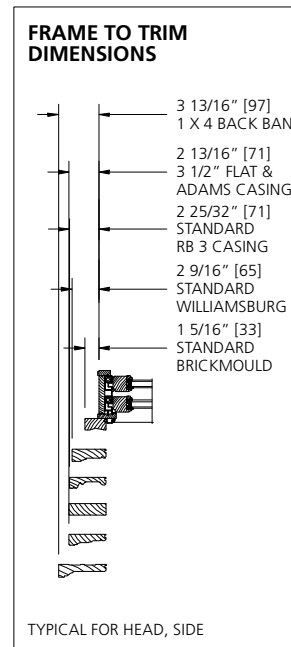
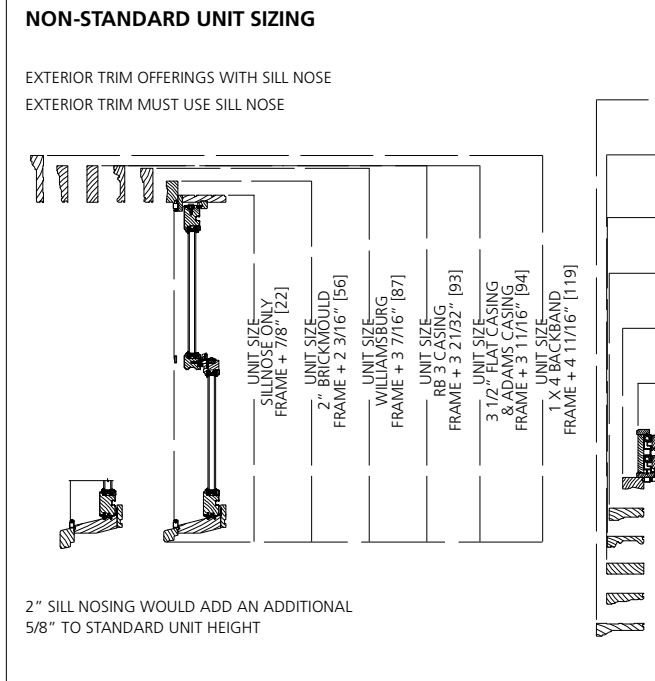
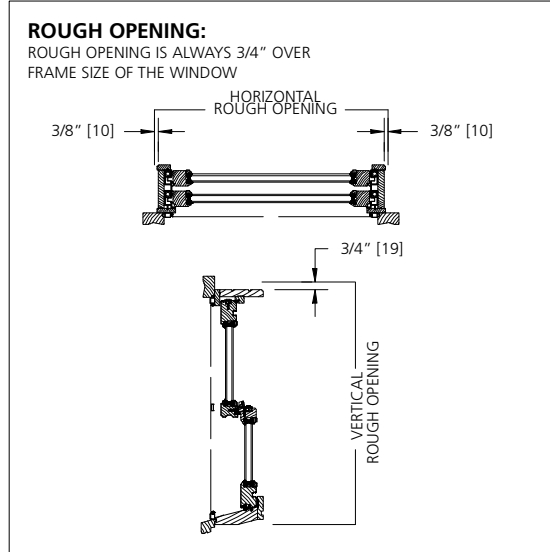

**UNIT SIZING, ROUGH OPENINGS
& MASONRY OPENINGS
SECTOR TOP SINGLE-HUNG**

STANDARD OFFERING

OF BRICKMOULD & SILLNOSE

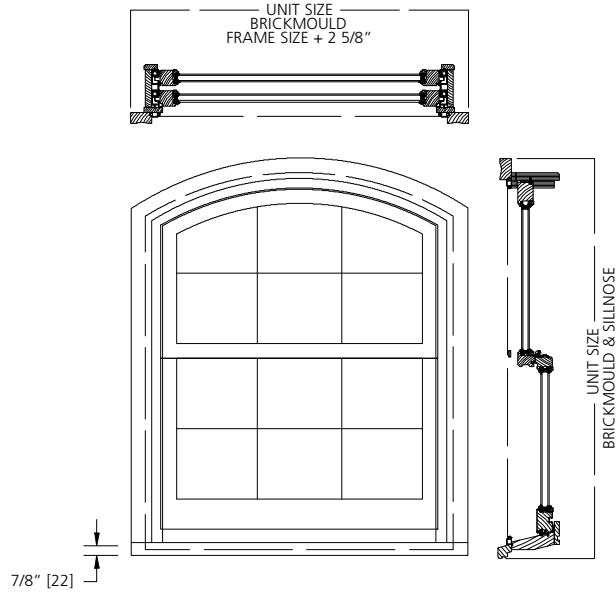

GENERAL NOTES:

UNITS WITH NO TRIM AND SILL NOSE:

UNIT SIZE = FRAME SIZE

UNIT SIZE IS ALWAYS THE
EXTREME SIZE OF THE WINDOW
WITH OR WITHOUT TRIM

MASONRY OPENING:

MASONRY OPENING IS ALWAYS 1/2" OVER
THE UNIT SIZE OF THE WINDOW

ROUGH OPENING:

ROUGH OPENING IS ALWAYS 3/4" OVER
FRAME SIZE OF THE WINDOW

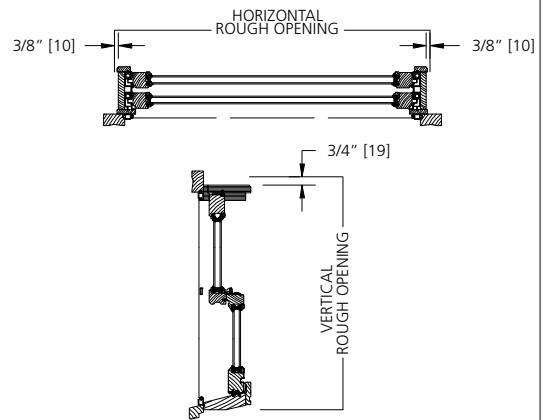

NON-STANDARD UNIT SIZING

EXTERIOR TRIM OFFERINGS WITH SILL NOSE

EXTERIOR TRIM MUST USE SILL NOSE

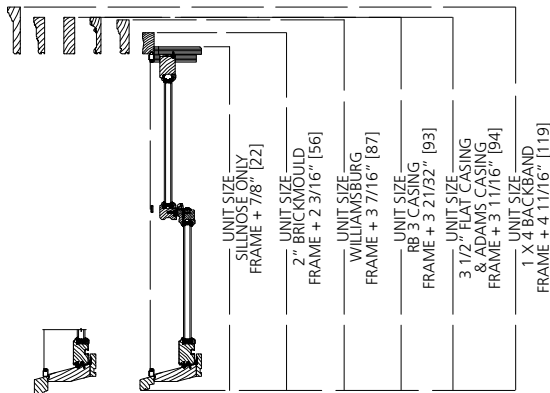

2" SILL NOSING WOULD ADD AN ADDITIONAL
5/8" TO STANDARD UNIT HEIGHT

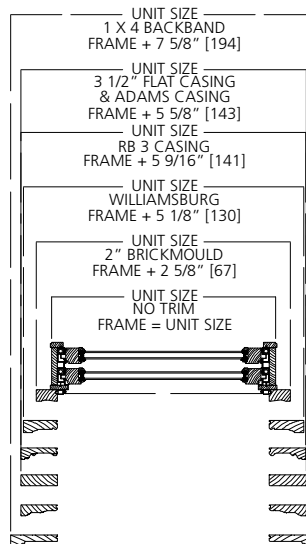

**FRAME TO TRIM
DIMENSIONS**

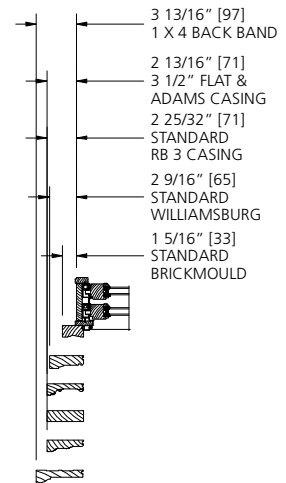

TYPICAL FOR HEAD, SIDE

1-WIDE UNIT
DP35

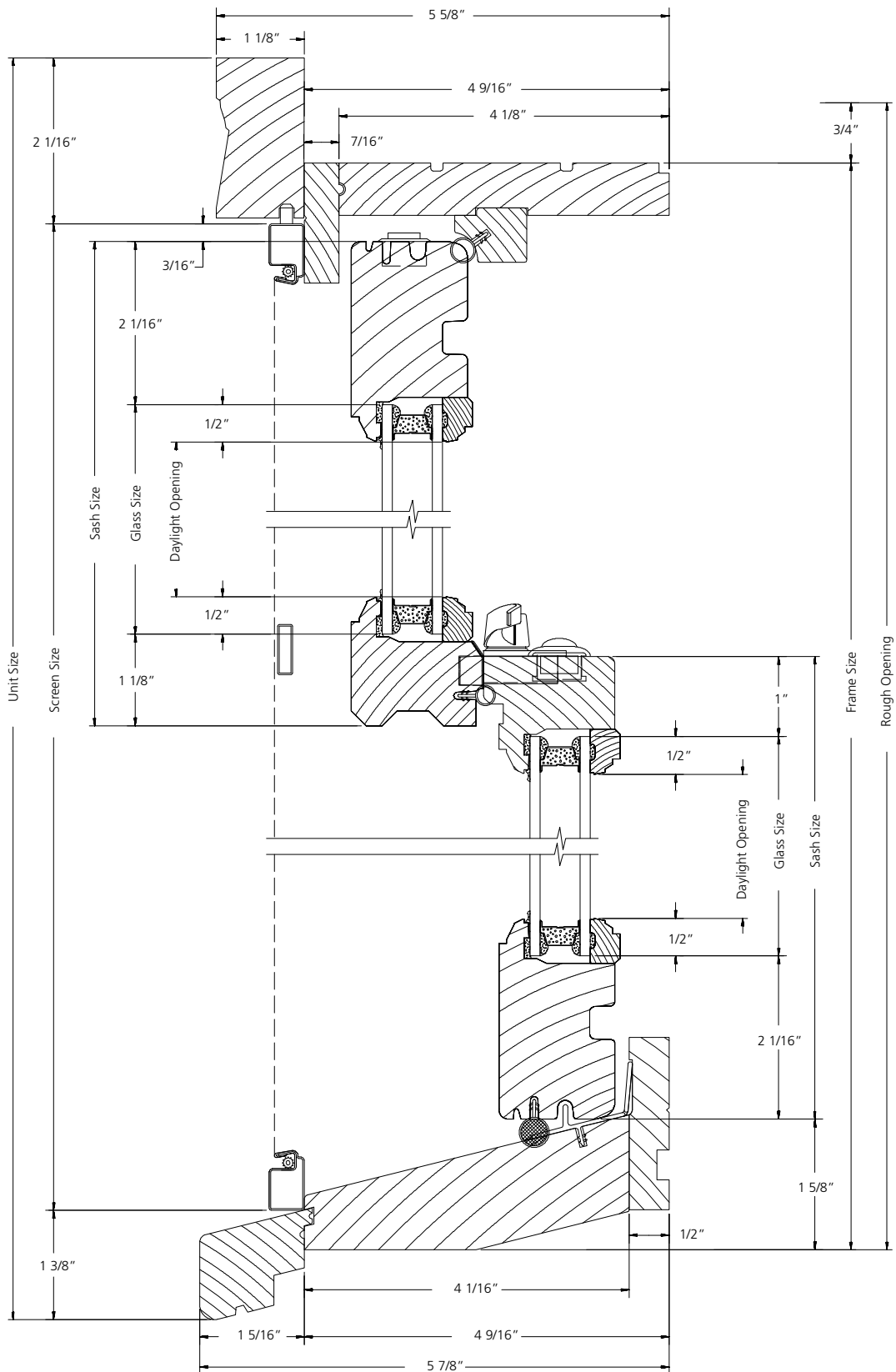

VERTICAL SECTION

SCALE: 6" = 1'

1-WIDE UNIT
DP50

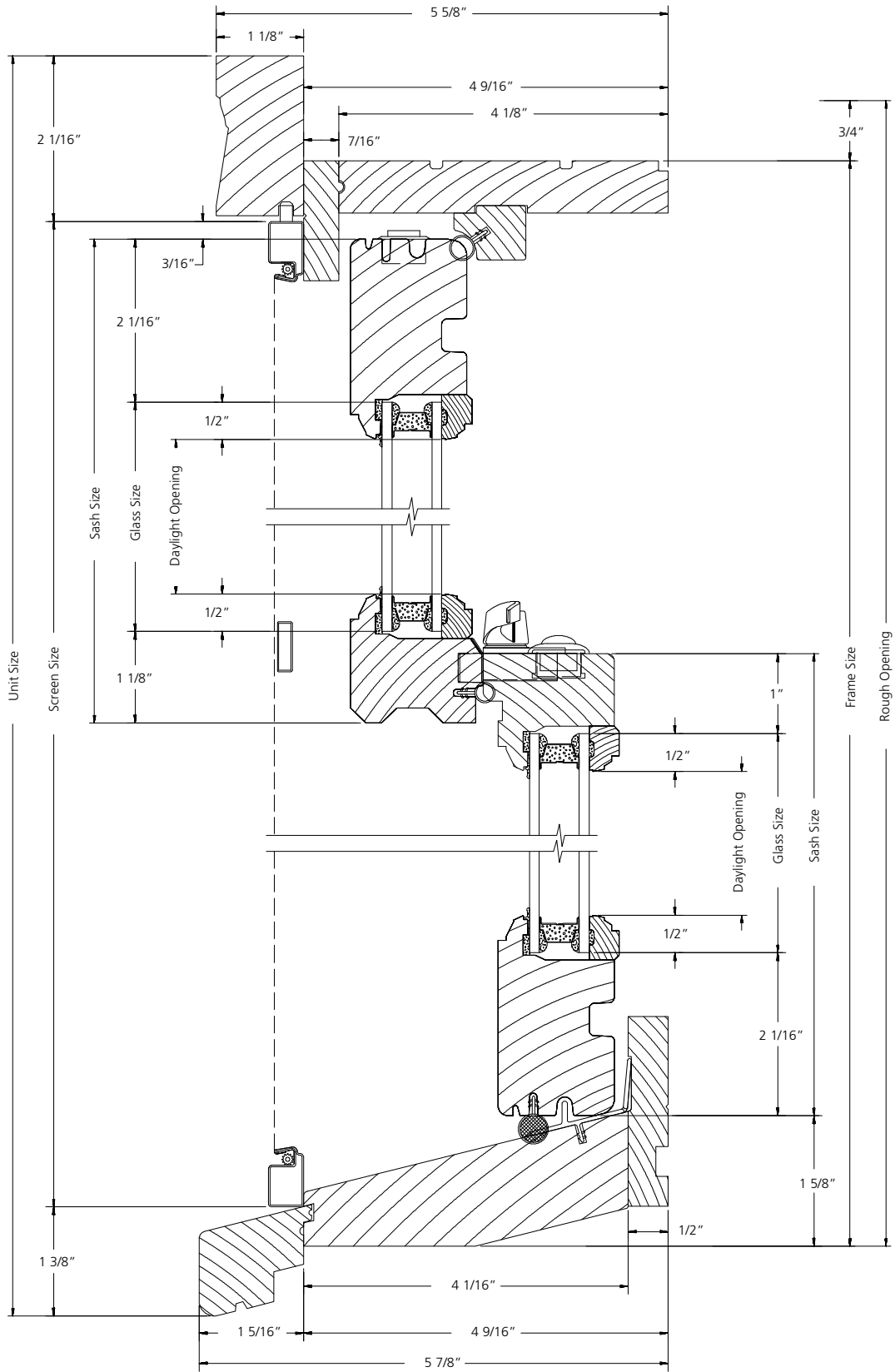

VERTICAL SECTION

SCALE: 6" = 1'

1-WIDE UNIT

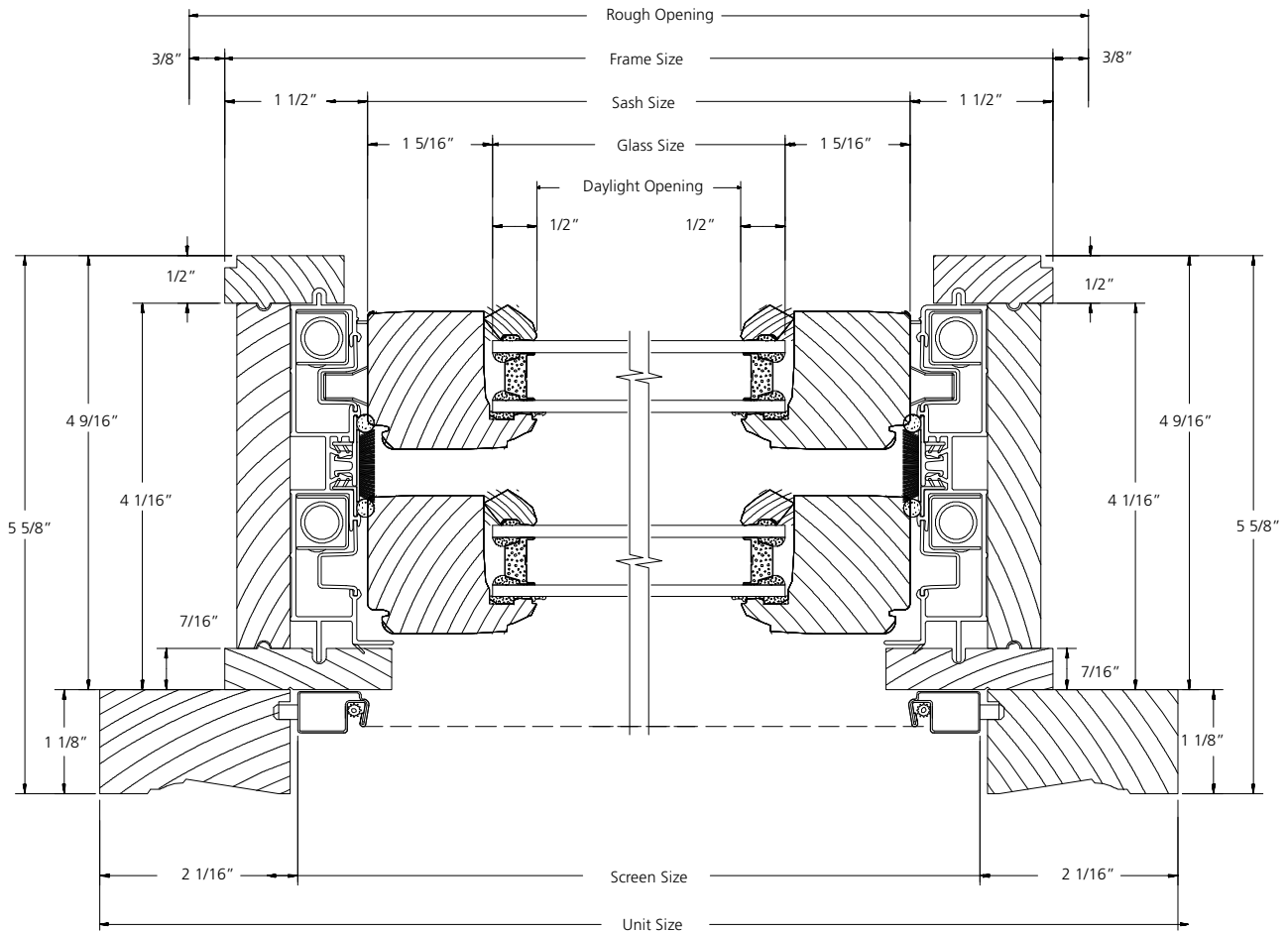

HORIZONTAL SECTION

SCALE: 6" = 1'

**2-WIDE UNIT
DP35**

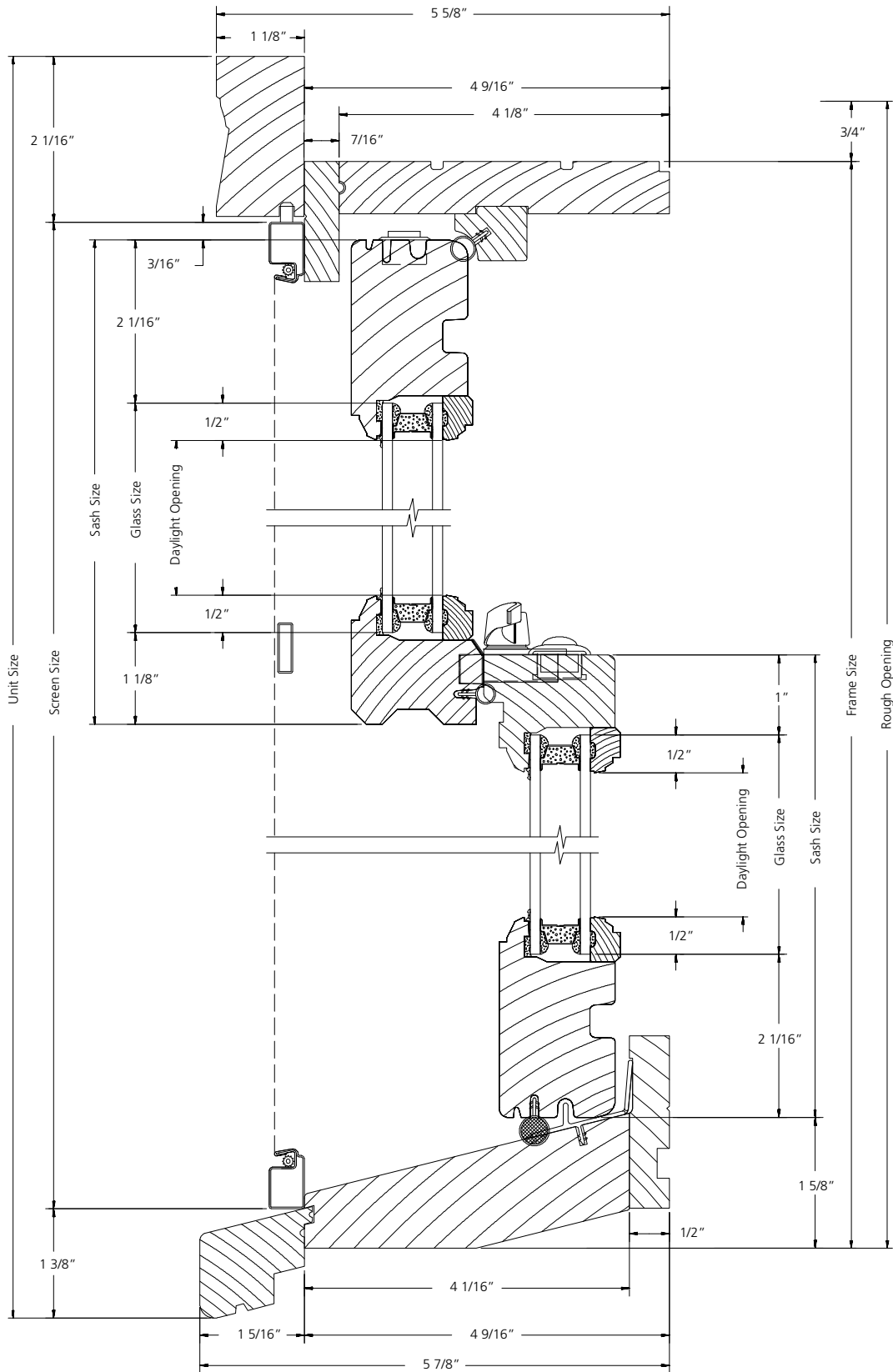

VERTICAL SECTION

SCALE: 6" = 1'

2-WIDE UNIT
DP50

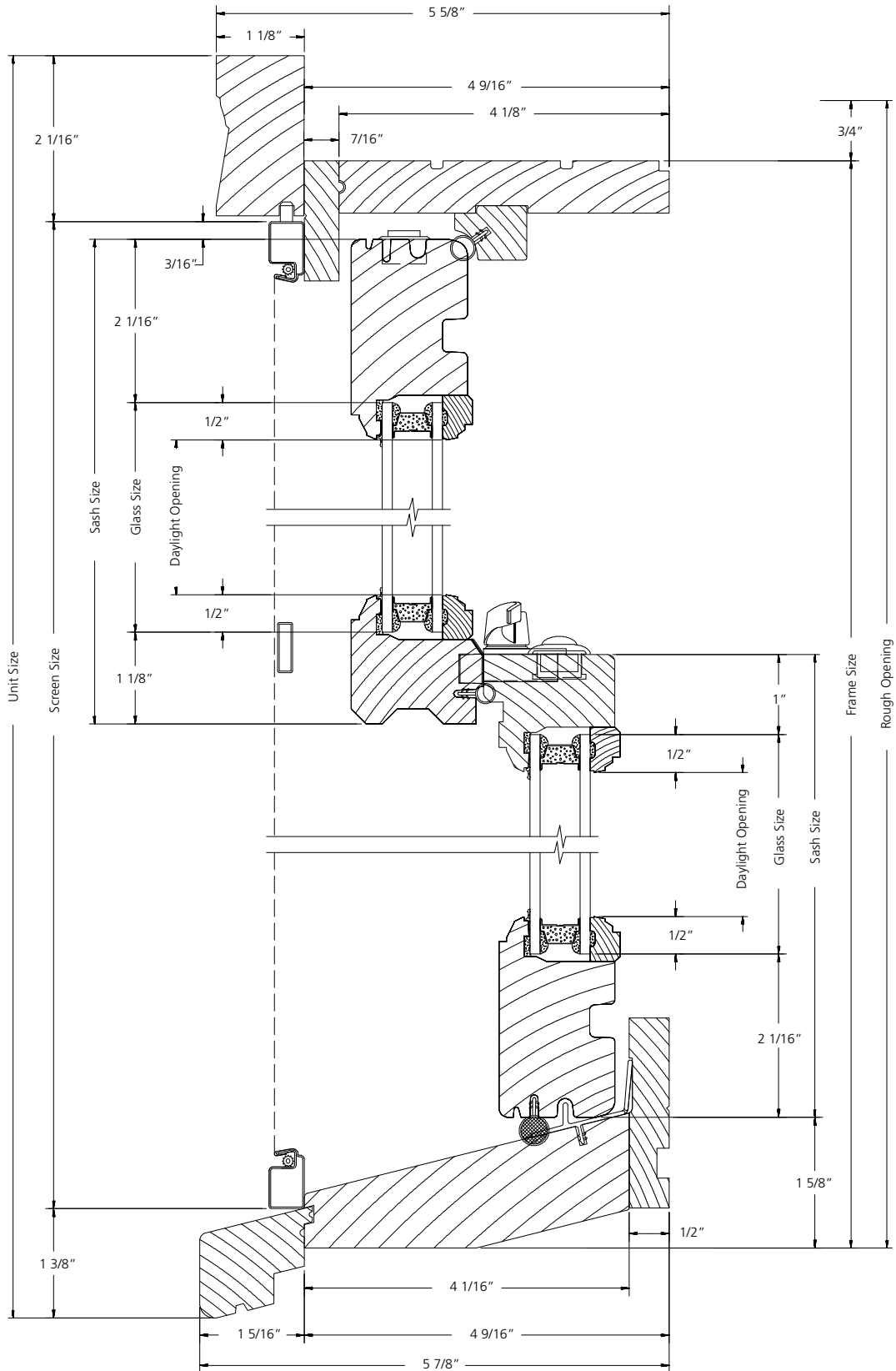

VERTICAL SECTION

SCALE: 6" = 1'

2-WIDE UNIT

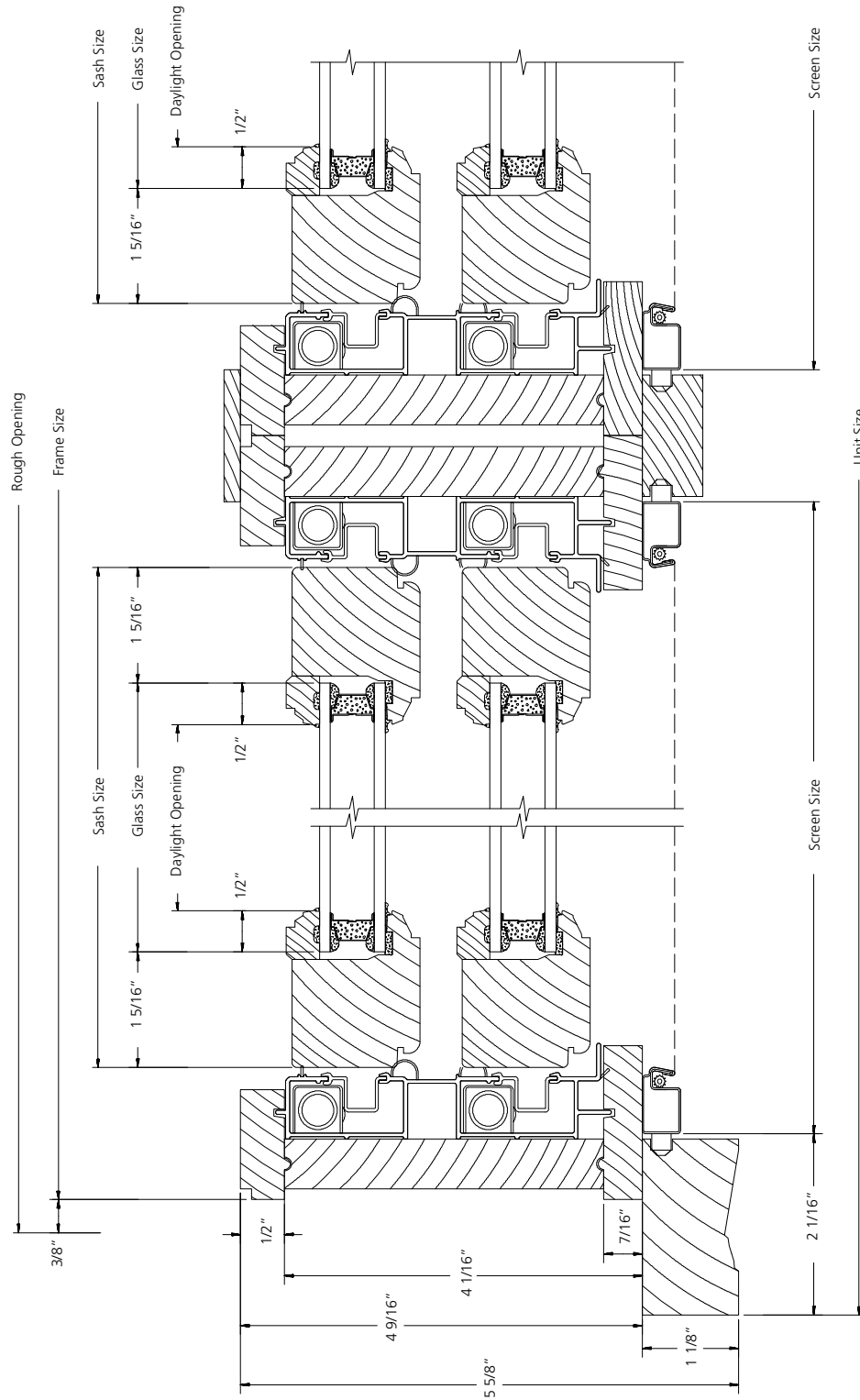

HORIZONTAL SECTION

SCALE: 6" = 1'

PICTURE UNIT
DP35

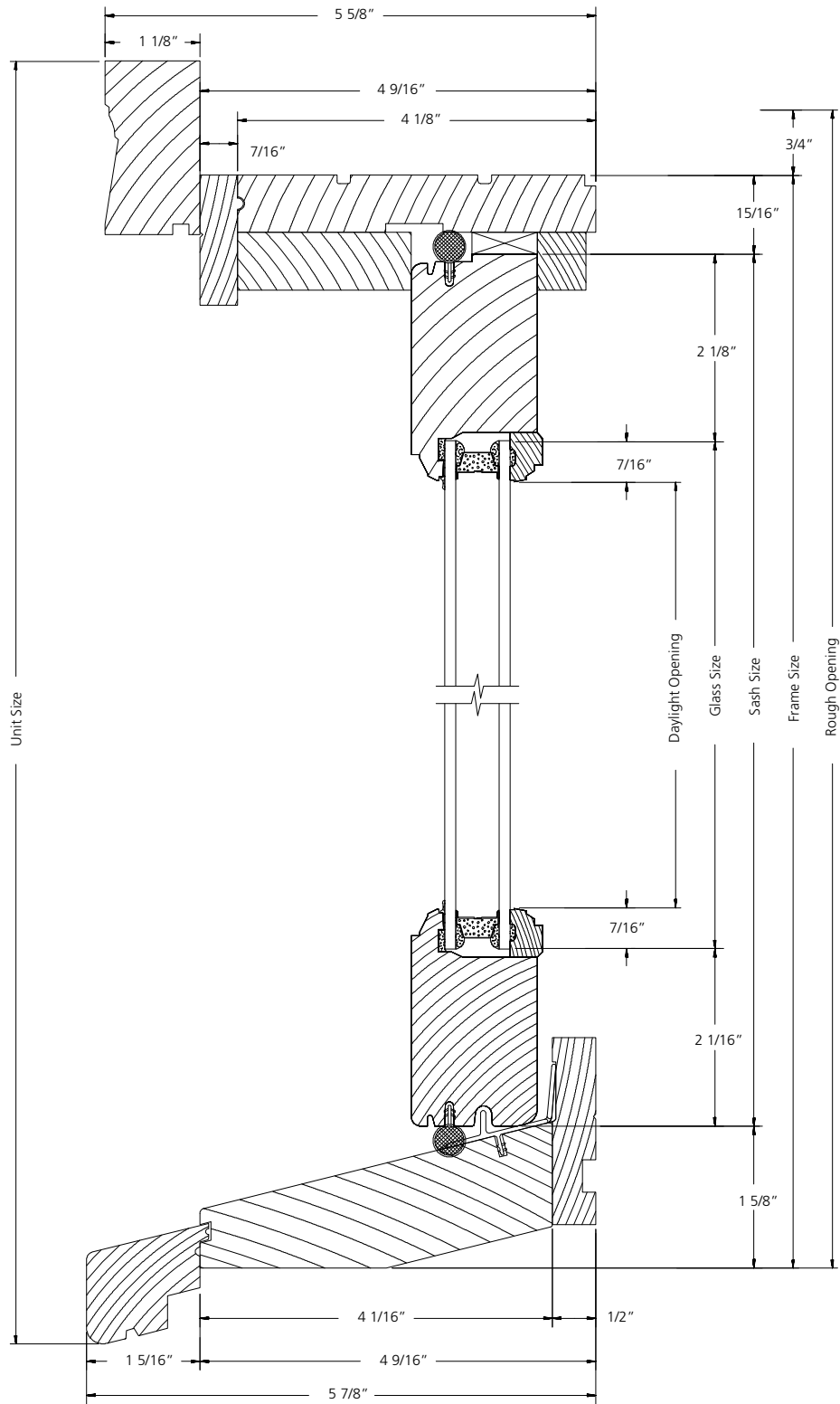

VERTICAL SECTION

SCALE: 6" = 1'

PICTURE UNIT
DP50

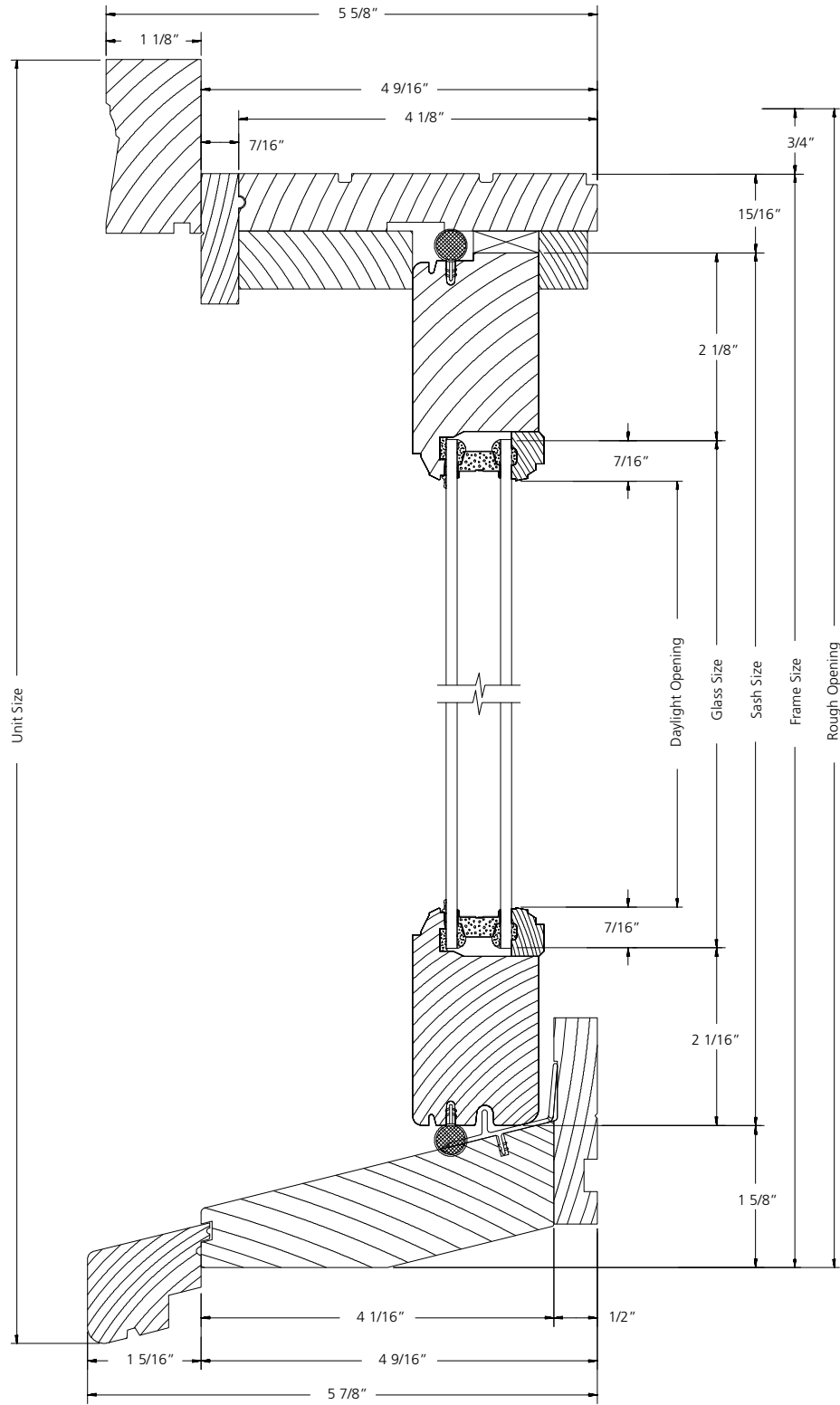

VERTICAL SECTION

SCALE: 6" = 1'

PICTURE UNIT

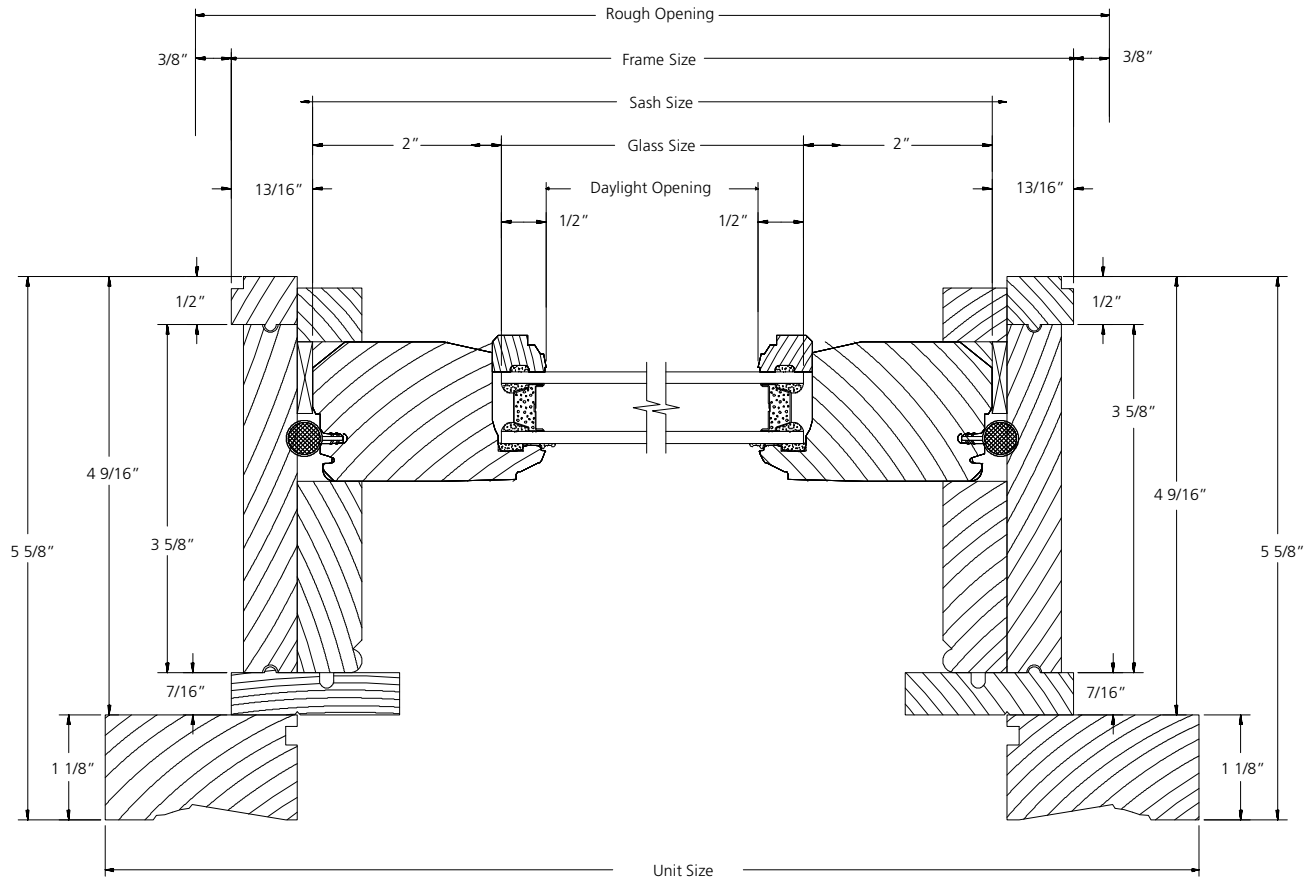

HORIZONTAL SECTION

SCALE: 6" = 1'

PICTURE UNIT WITH FLANKER
DP35

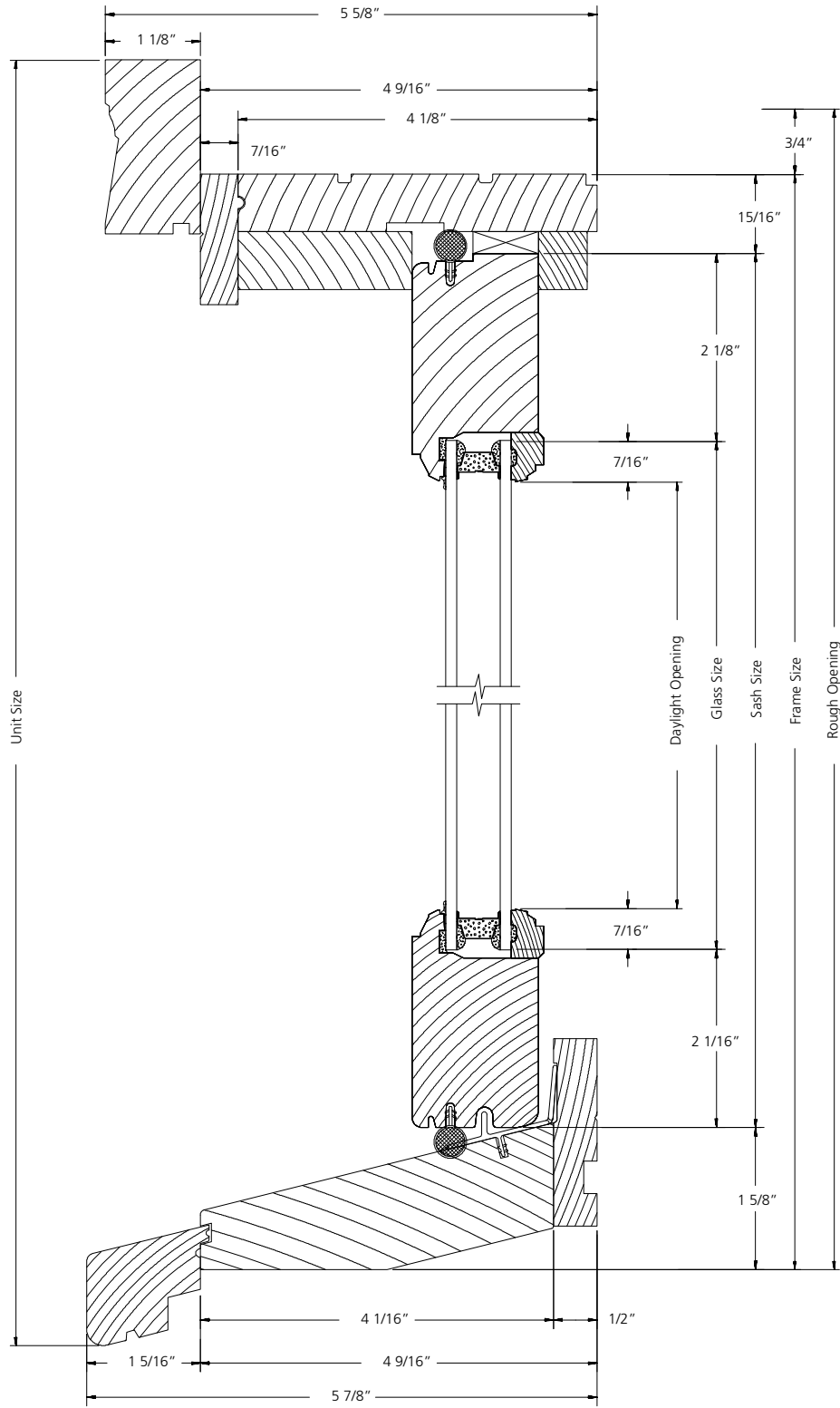

VERTICAL SECTION

SCALE: 6" = 1'

**PICTURE UNIT WITH FLANKER
DP50**

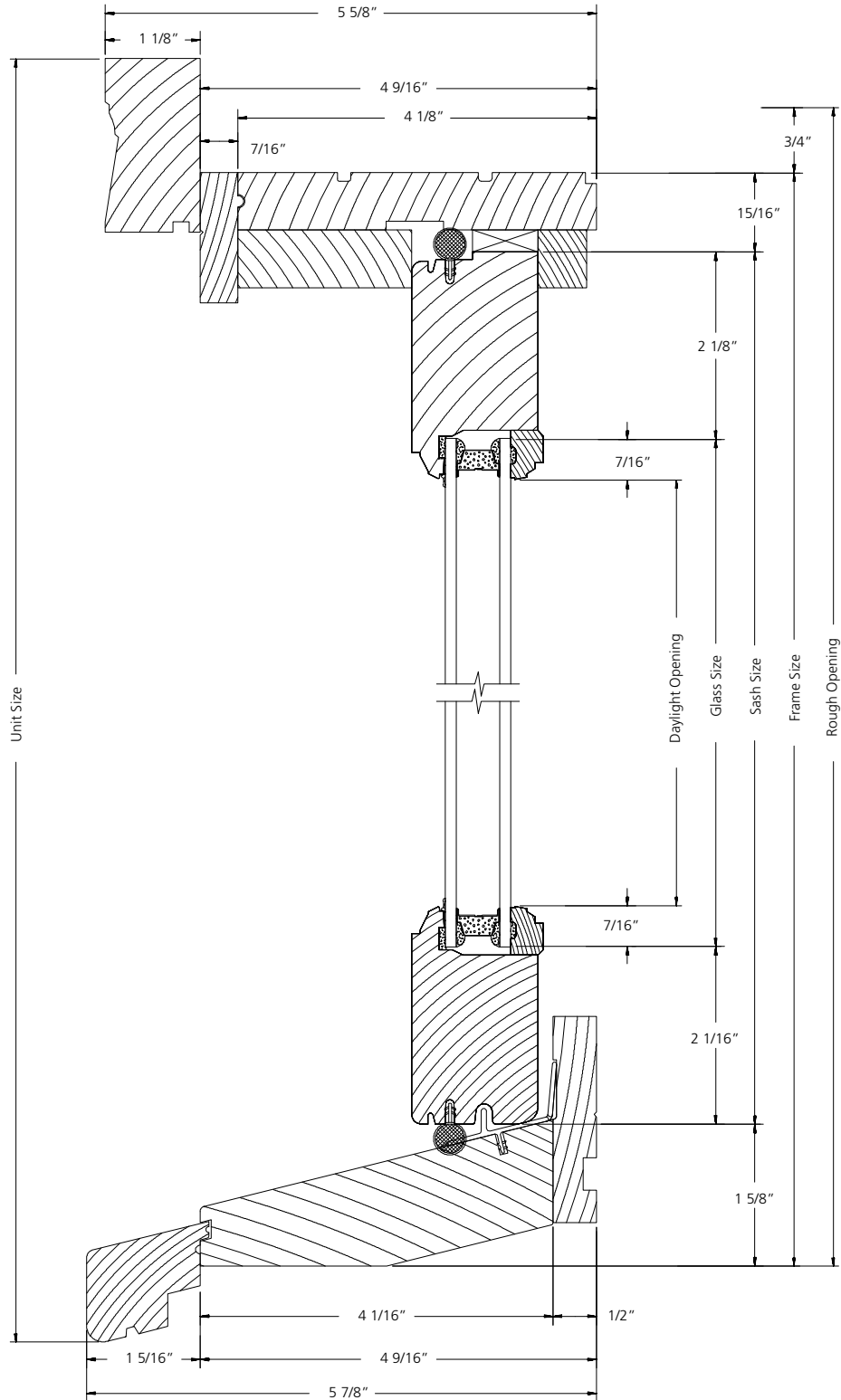

VERTICAL SECTION

SCALE: 6" = 1'

PICTURE UNIT WITH FLANKER

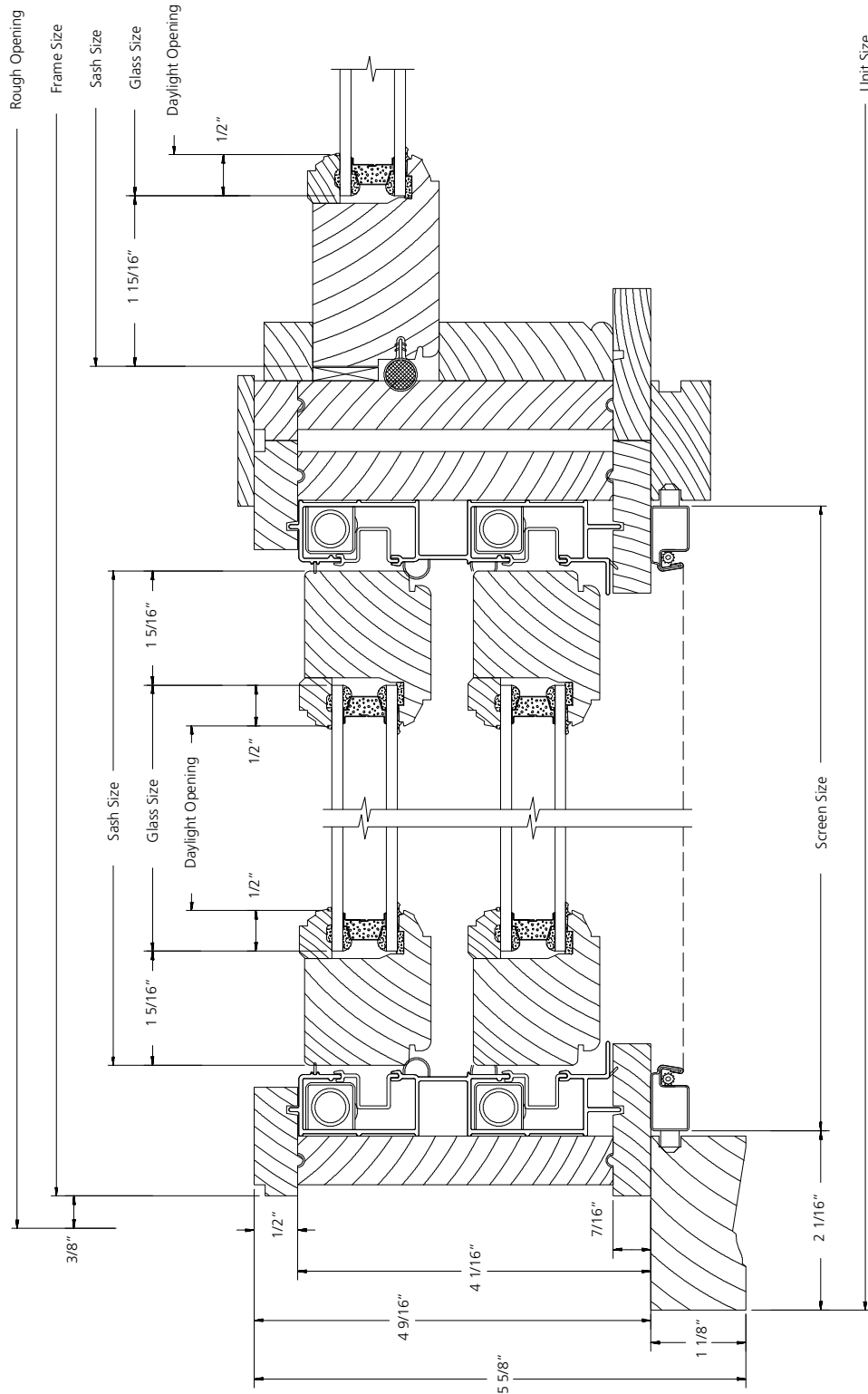

HORIZONTAL SECTION

SCALE: 6" = 1'

SECTOR TOP UNIT

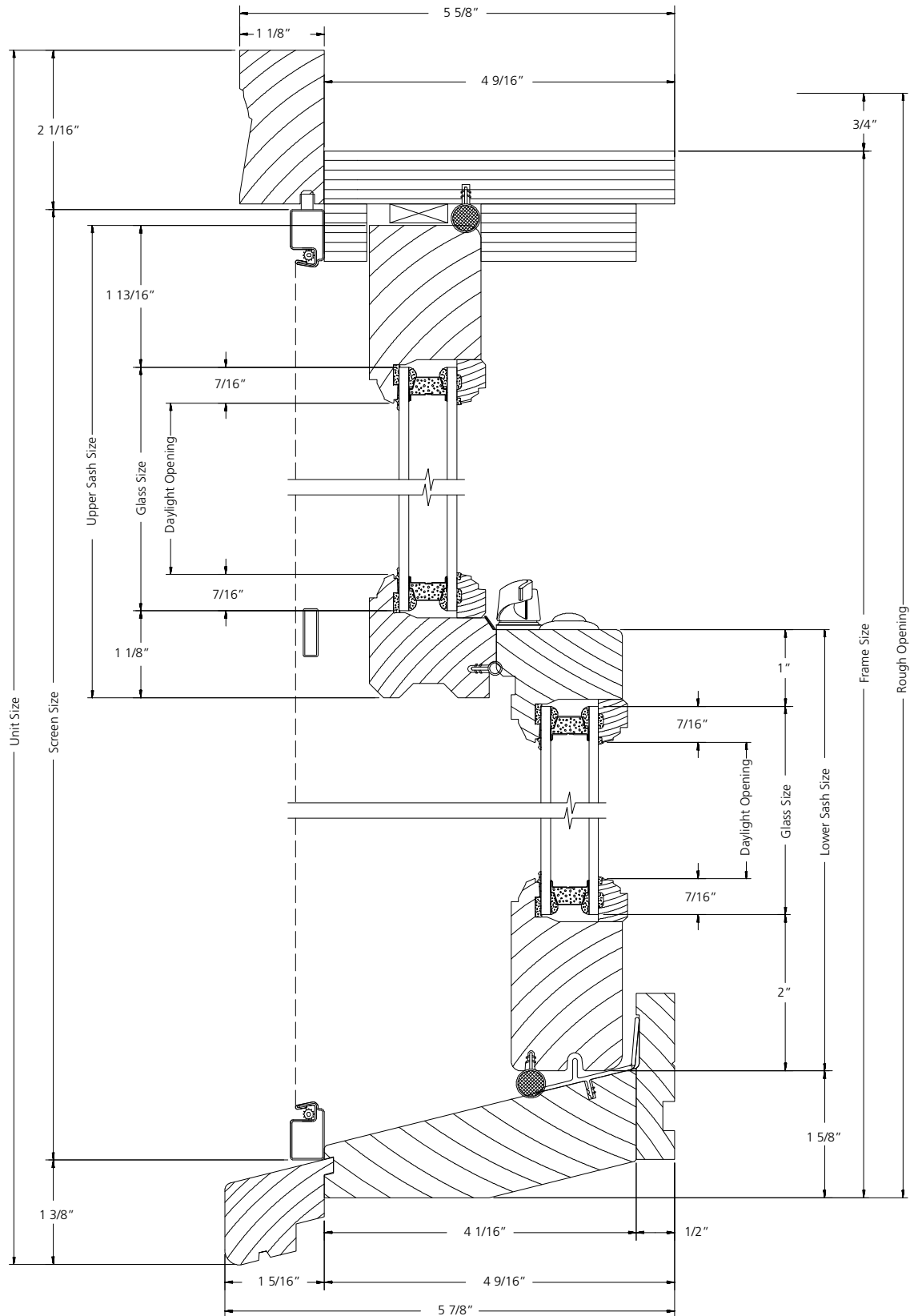

VERTICAL SECTION

SCALE: 6" = 1'

SECTOR TOP UNIT

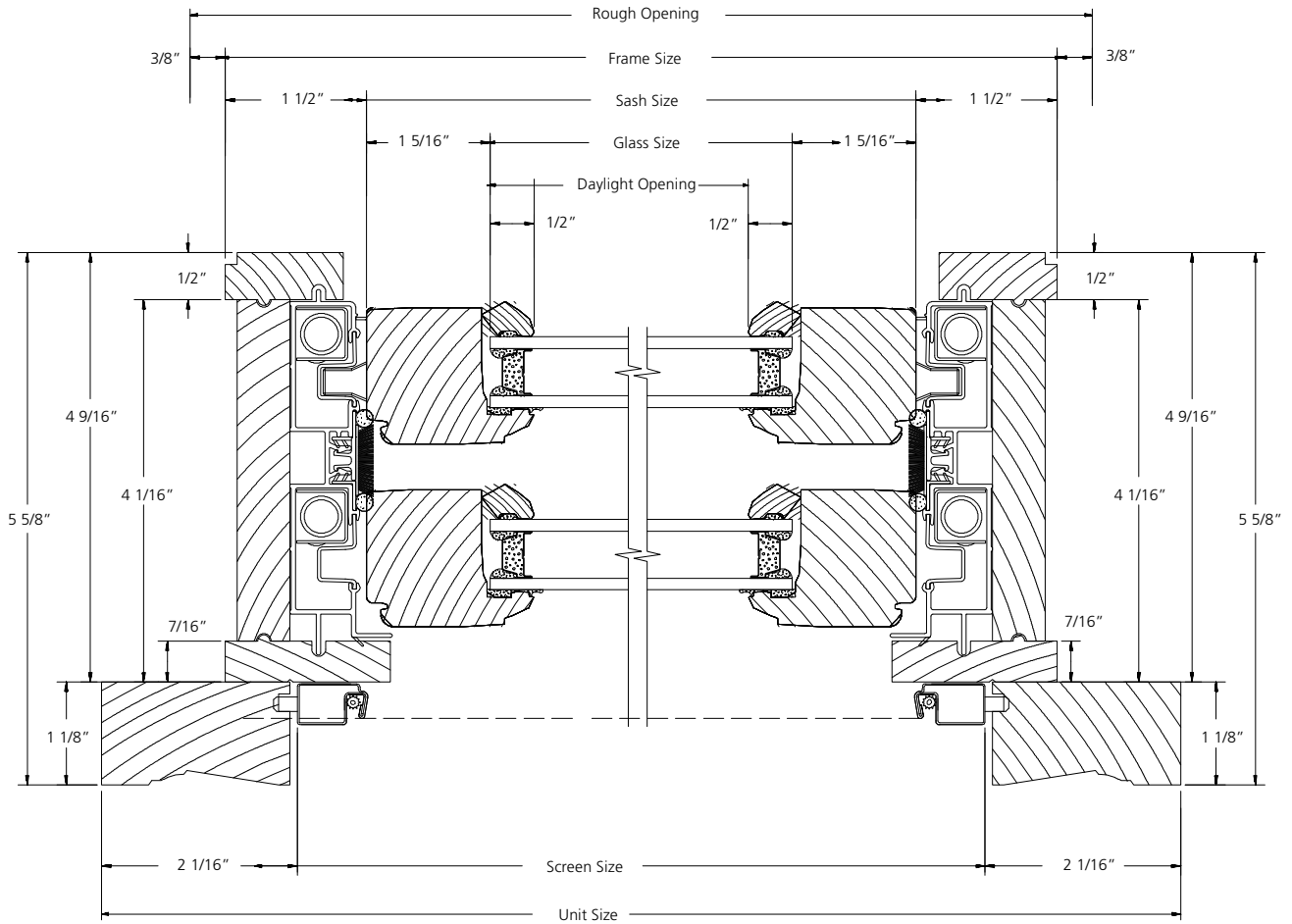

HORIZONTAL SECTION

SCALE: 6" = 1'

FULL RADIUS UNIT

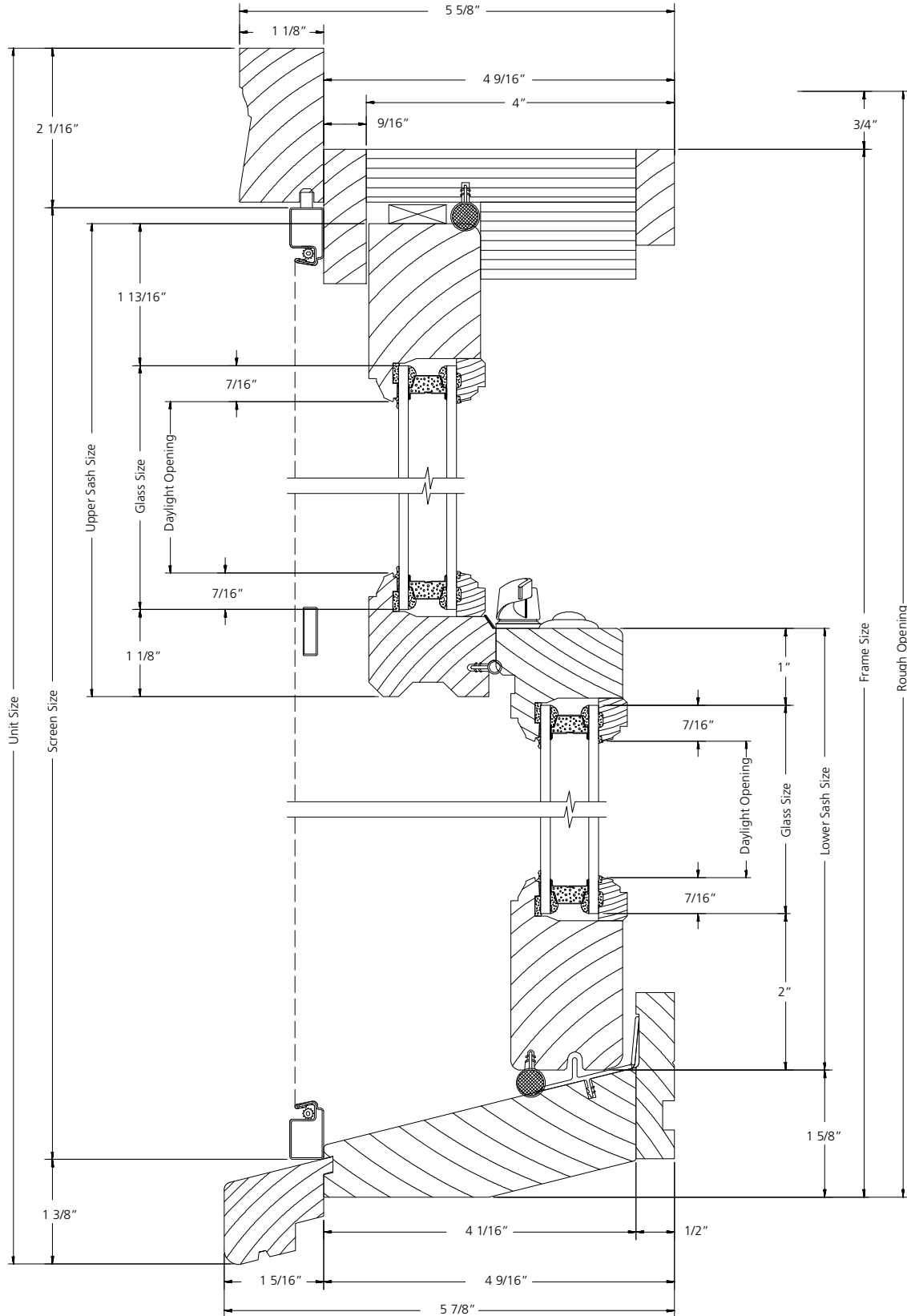

VERTICAL SECTION

SCALE: 6" = 1'

FULL RADIUS UNIT

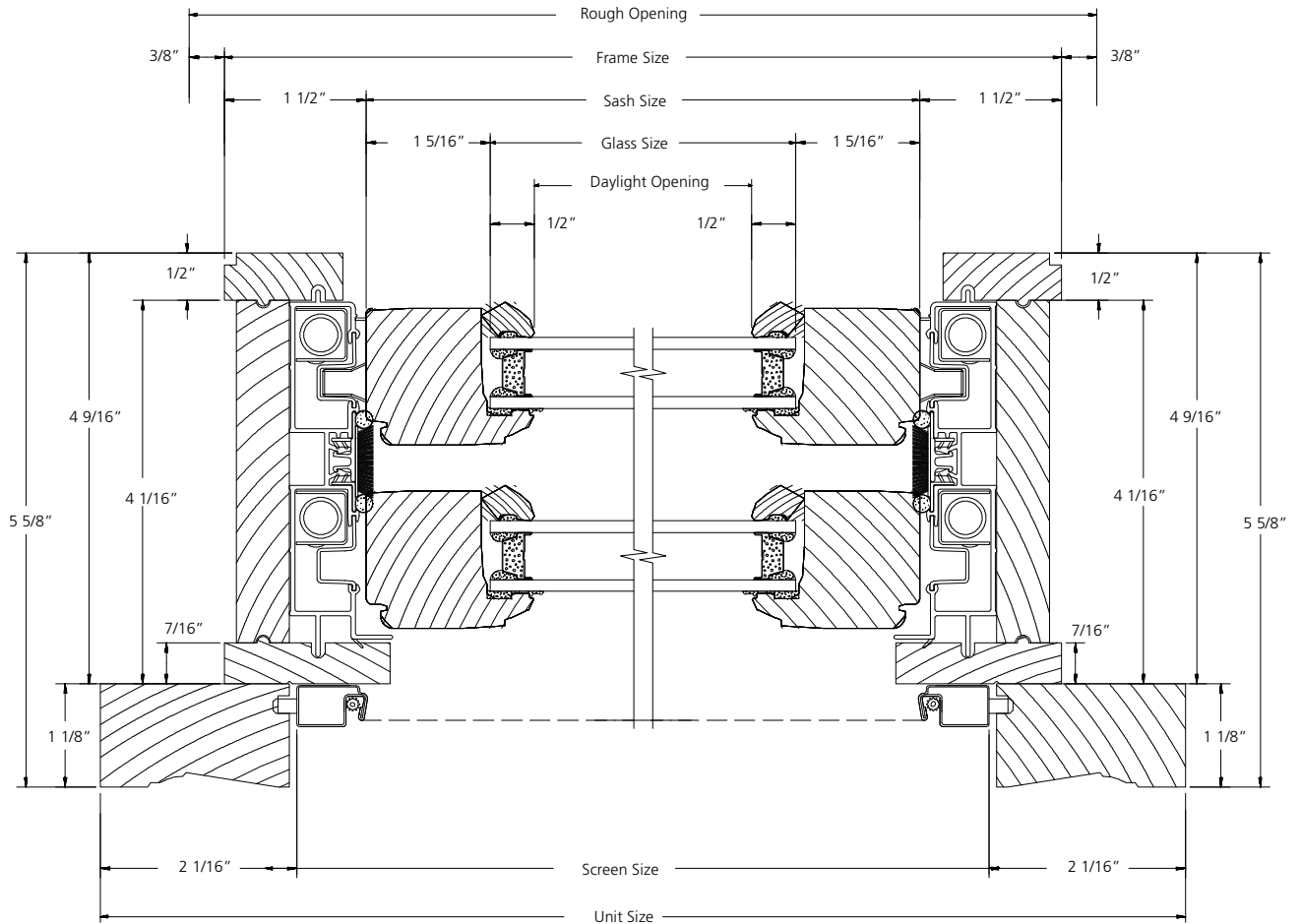

HORIZONTAL SECTION

SCALE: 6" = 1'

TRANSOM UNIT

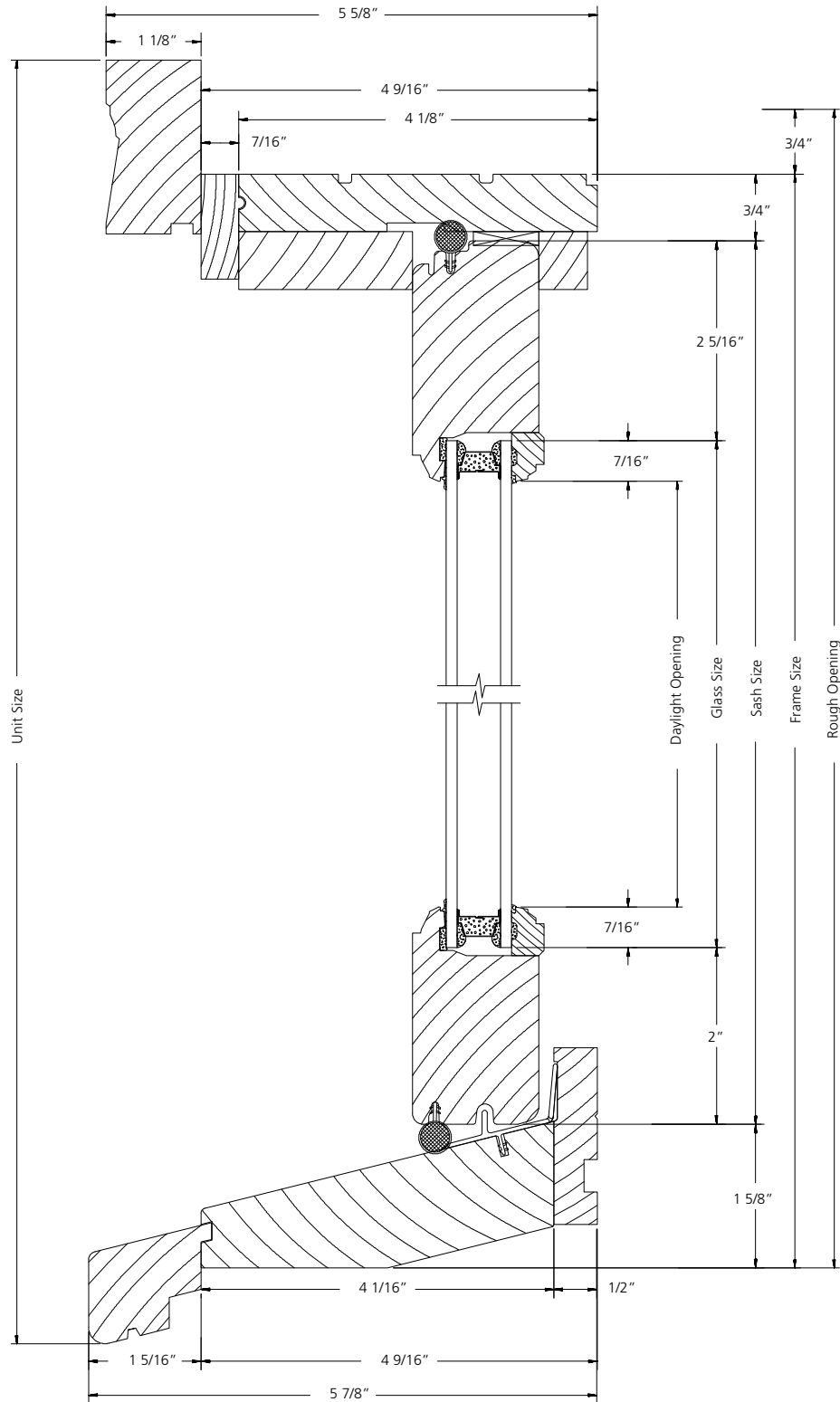

VERTICAL SECTION

SCALE: 6" = 1'

TRANSOM UNIT

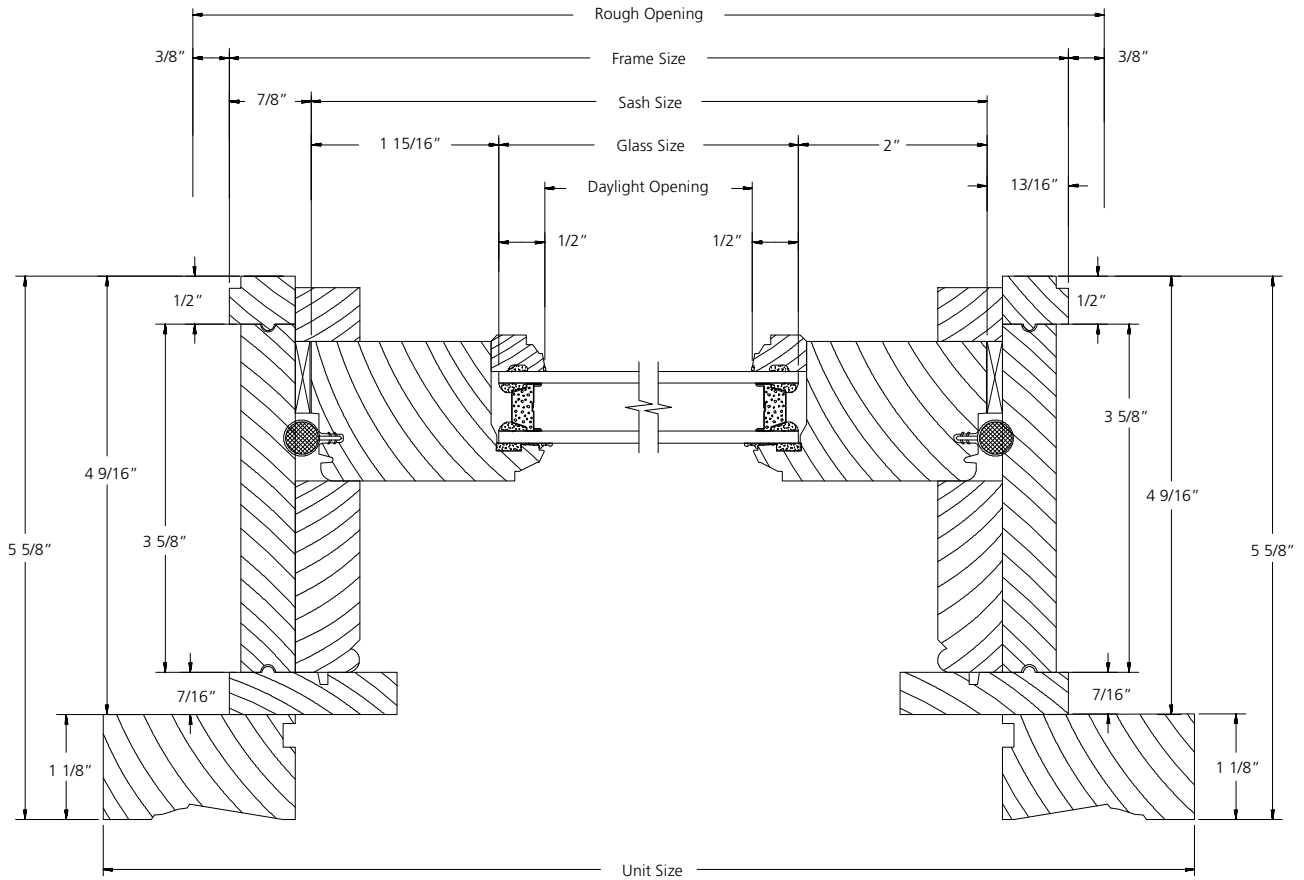

HORIZONTAL SECTION

SCALE: 6" = 1'

BAY WINDOW HORIZONTAL SPECIFICATION TABLES

30° ANGLE BAY

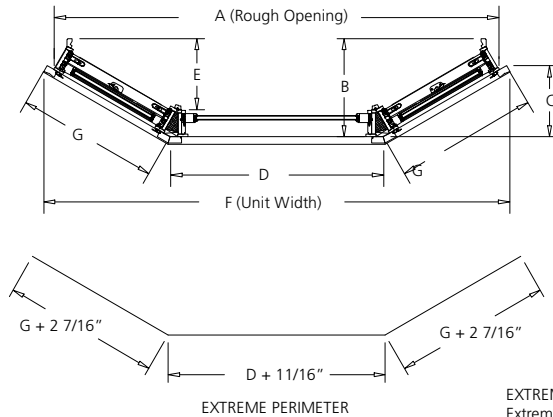

EXTREME PERIMETER
Extreme Perimeter is the distance around the face of the bay, beginning at the exterior sheathing and continuing around the assembly along the extreme face of the basic unit frame.

45° ANGLE BAY

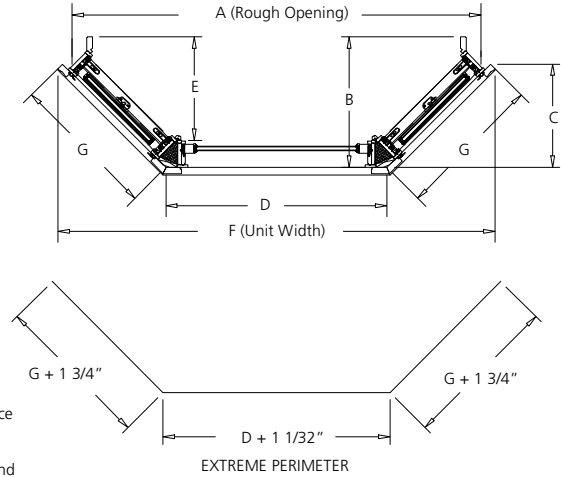

30° BAY								
		A	F	B	C	E	D	G
Flanker Width (Call Size)	Center Width (Call Size)	Rough Opening	Overall Unit Width	Overall Projection*	Projection Exterior Wall	Seating Depth*	Outside Mull to Mull	Outside Mull to Unit
21	21	62 15/16	66 5/16	16 1/2	11 15/16	11 15/16	23 13/16	23 15/16
21	41	82 15/16	86 5/16	16 1/2	11 15/16	11 15/16	43 13/16	23 15/16
21	49	90 15/16	94 5/16	16 1/2	11 15/16	11 15/16	51 13/16	23 15/16
21	53	94 15/16	98 5/16	16 1/2	11 15/16	11 15/16	55 13/16	23 15/16
21	61	102 15/16	106 5/16	16 1/2	11 15/16	11 15/16	63 13/16	23 15/16
21	69	110 15/16	114 5/16	16 1/2	11 15/16	11 15/16	71 13/16	23 15/16
25	25	73 7/8	77 1/4	18 1/2	13 15/16	13 15/16	27 13/16	27 15/16
25	41	89 7/8	93 1/4	18 1/2	13 15/16	13 15/16	43 13/16	27 15/16
25	49	97 7/8	101 1/4	18 1/2	13 15/16	13 15/16	51 13/16	27 15/16
25	53	101 7/8	105 1/4	18 1/2	13 15/16	13 15/16	55 13/16	27 15/16
25	61	109 7/8	113 1/4	18 1/2	13 15/16	13 15/16	63 13/16	27 15/16
25	69	117 7/8	121 1/4	18 1/2	13 15/16	13 15/16	71 13/16	27 15/16
29	29	84 13/16	88 3/16	20 1/2	15 15/16	15 15/16	31 13/16	31 15/16
29	41	96 13/16	100 3/16	20 1/2	15 15/16	15 15/16	43 13/16	31 15/16
29	49	104 13/16	108 3/16	20 1/2	15 15/16	15 15/16	51 13/16	31 15/16
29	53	108 13/16	112 3/16	20 1/2	15 15/16	15 15/16	55 13/16	31 15/16
29	61	116 13/16	120 3/16	20 1/2	15 15/16	15 15/16	63 13/16	31 15/16
29	69	124 13/16	128 3/16	20 1/2	15 15/16	15 15/16	71 13/16	31 15/16

45° BAY								
		A	F	B	C	E	D	G
Flanker Width (Call Size)	Center Width (Call Size)	Rough Opening	Overall Unit Width	Overall Projection*	Projection Exterior Wall	Seating Depth*	Outside Mull to Mull	Outside Mull to Unit
21	21	56 15/16	61 7/16	21 15/16	17 3/8	17 3/8	25 1/8	24 9/16
21	41	76 15/16	81 7/16	21 15/16	17 3/8	17 3/8	45 1/8	24 9/16
21	49	84 15/16	89 7/16	21 15/16	17 3/8	17 3/8	53 1/8	24 9/16
21	53	88 15/16	93 7/16	21 15/16	17 3/8	17 3/8	57 1/8	24 9/16
21	61	96 15/16	101 7/16	21 15/16	17 3/8	17 3/8	65 1/8	24 9/16
21	69	104 15/16	109 7/16	21 15/16	17 3/8	17 3/8	73 1/8	24 9/16
25	25	66 5/8	71 1/8	24 3/4	20 3/16	20 3/16	29 1/8	28 9/16
25	41	82 5/8	87 1/8	24 3/4	20 3/16	20 3/16	45 1/8	28 9/16
25	49	90 5/8	95 1/8	24 3/4	20 3/16	20 3/16	53 1/8	28 9/16
25	53	94 5/8	99 1/8	24 3/4	20 3/16	20 3/16	57 1/8	28 9/16
25	61	102 5/8	107 1/8	24 3/4	20 3/16	20 3/16	65 1/8	28 9/16
25	69	110 5/8	115 1/8	24 3/4	20 3/16	20 3/16	73 1/8	28 9/16
29	29	76 1/4	80 3/4	27 5/8	23 1/16	23 1/16	33 1/8	32 9/16
29	41	88 1/4	92 3/4	27 5/8	23 1/16	23 1/16	45 1/8	32 9/16
29	49	96 1/4	100 3/4	27 5/8	23 1/16	23 1/16	53 1/8	32 9/16
29	53	100 1/4	104 3/4	27 5/8	23 1/16	23 1/16	57 1/8	32 9/16
29	61	108 1/4	112 3/4	27 5/8	23 1/16	23 1/16	65 1/8	32 9/16
29	69	116 1/4	120 3/4	27 5/8	23 1/16	23 1/16	73 1/8	32 9/16

The tables above reflect a 4 9/16" wall application. To convert to a 6 9/16" wall application, add 2" to the figures in the columns which shown an asterisk (*), B and E. ROUGH OPENING data reflects FRAME + 3/4".

BAY WINDOW ROUGH OPENINGS

BAY WINDOW TRIM OPTIONS

The standard offerings for wood double hung bay windows is 'frame only' and brickmould and sillnose. Other trim options subject to approval.

VERTICAL ROUGH OPENING

Rough Opening typical for all Units

NO EXTERIOR TRIM

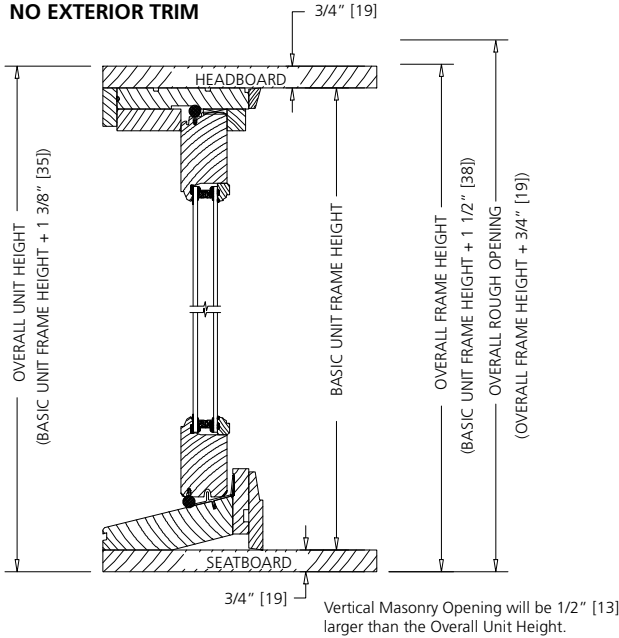

BRICKMOULD

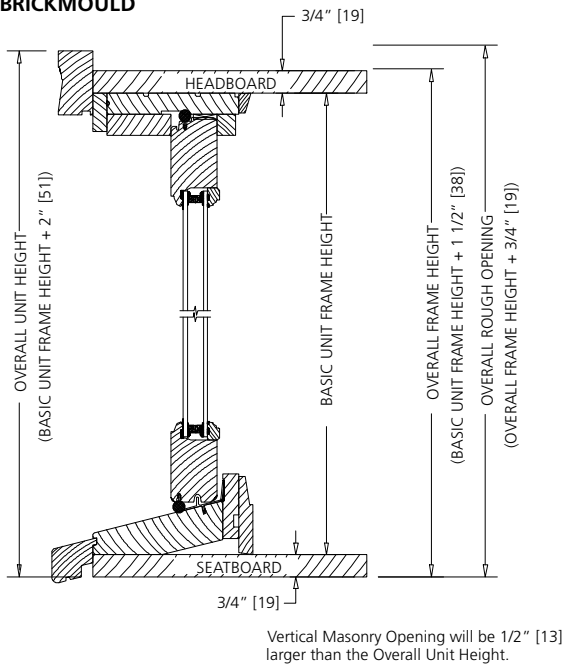

HORIZONTAL ROUGH OPENING

Rough Opening typical for all Units

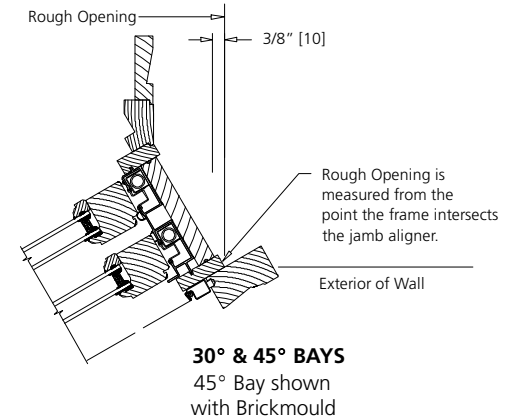
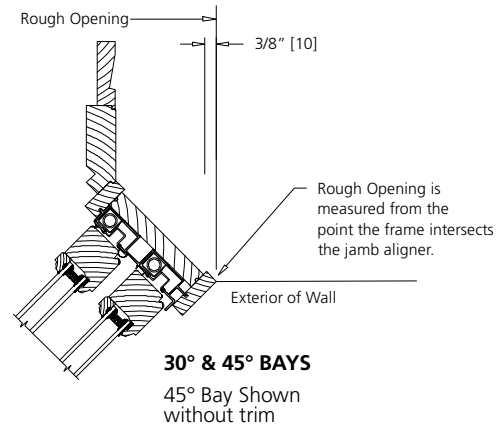

**30° ANGLE BAY UNIT
WITH NO TRIM**

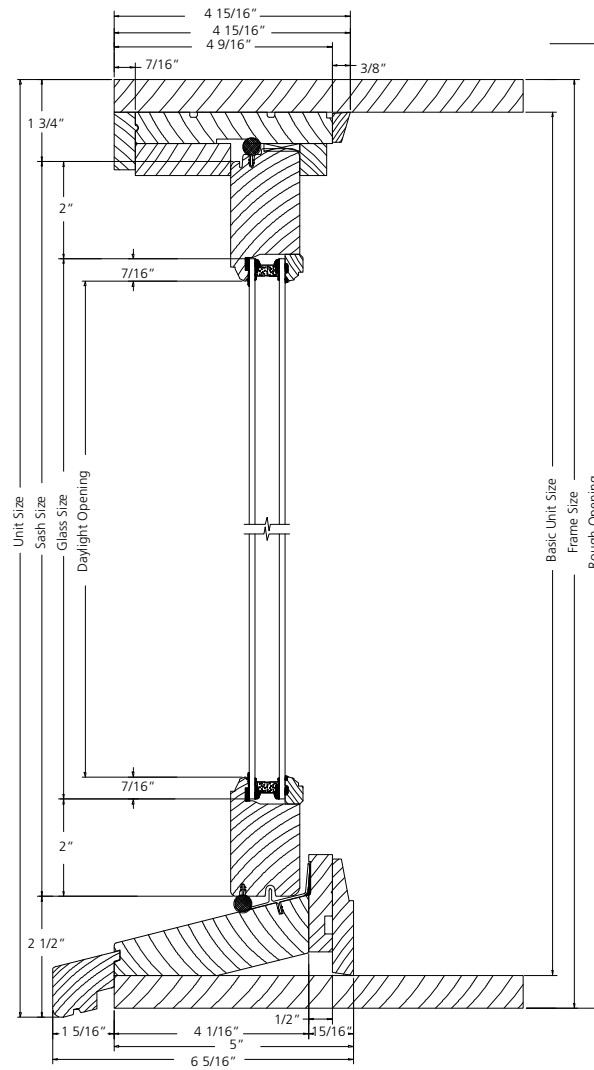

VERTICAL SECTION

SCALE: 3" = 1'

**30° ANGLE BAY UNIT
WITH STATIONARY CENTER**

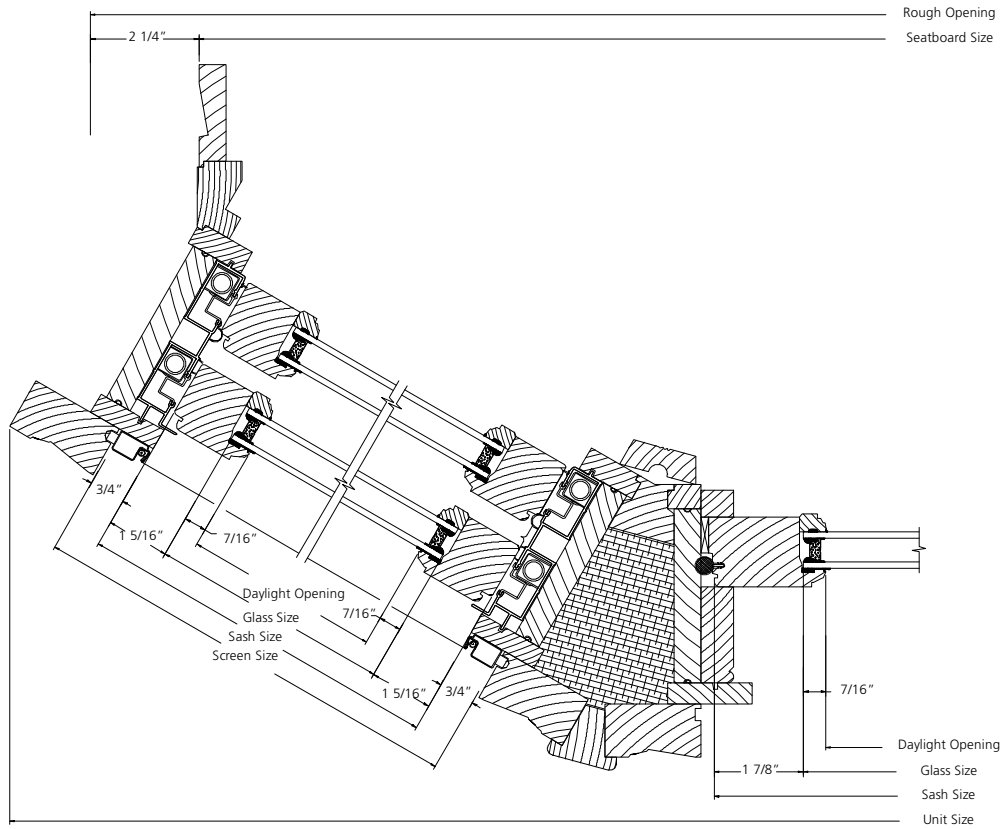

HORIZONTAL SECTION

SCALE: 3" = 1'

**30° ANGLE BAY UNIT
WITH OPERABLE CENTER**

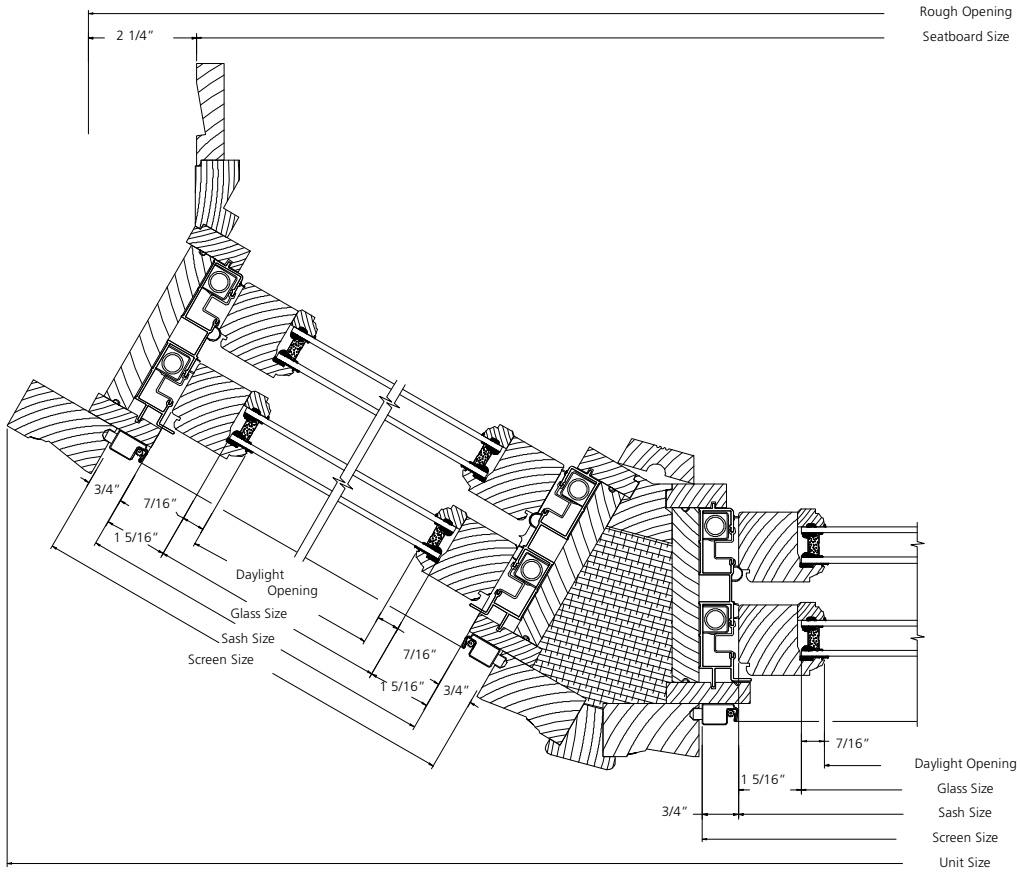

HORIZONTAL SECTION

SCALE: 3" = 1'

45° ANGLE BAY UNIT
WITH NO TRIM

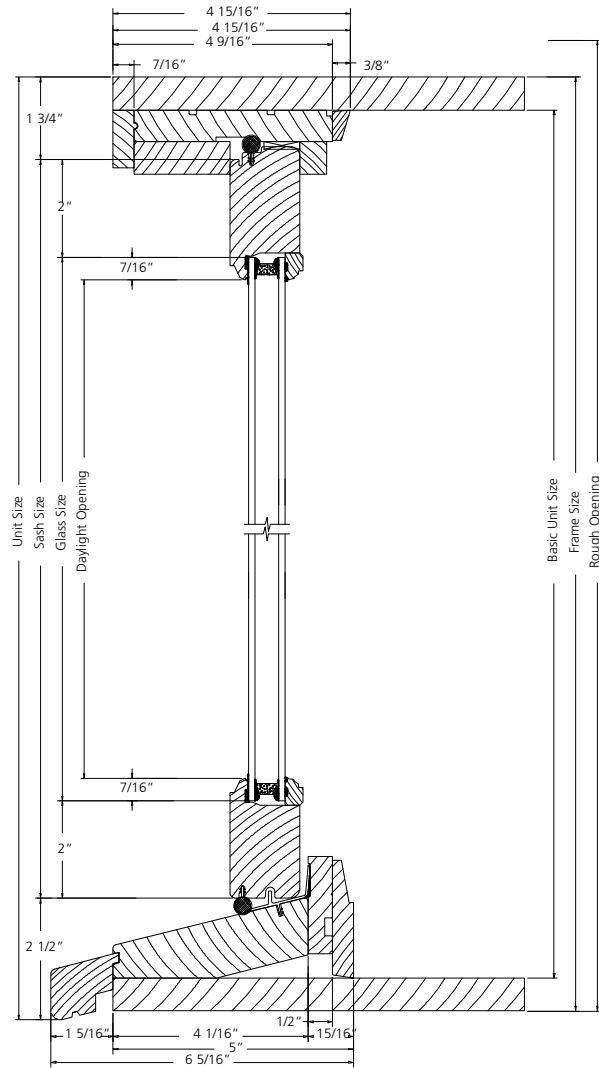

VERTICAL SECTION

SCALE: 3" = 1'

**45° ANGLE BAY UNIT
WITH STATIONARY CENTER**

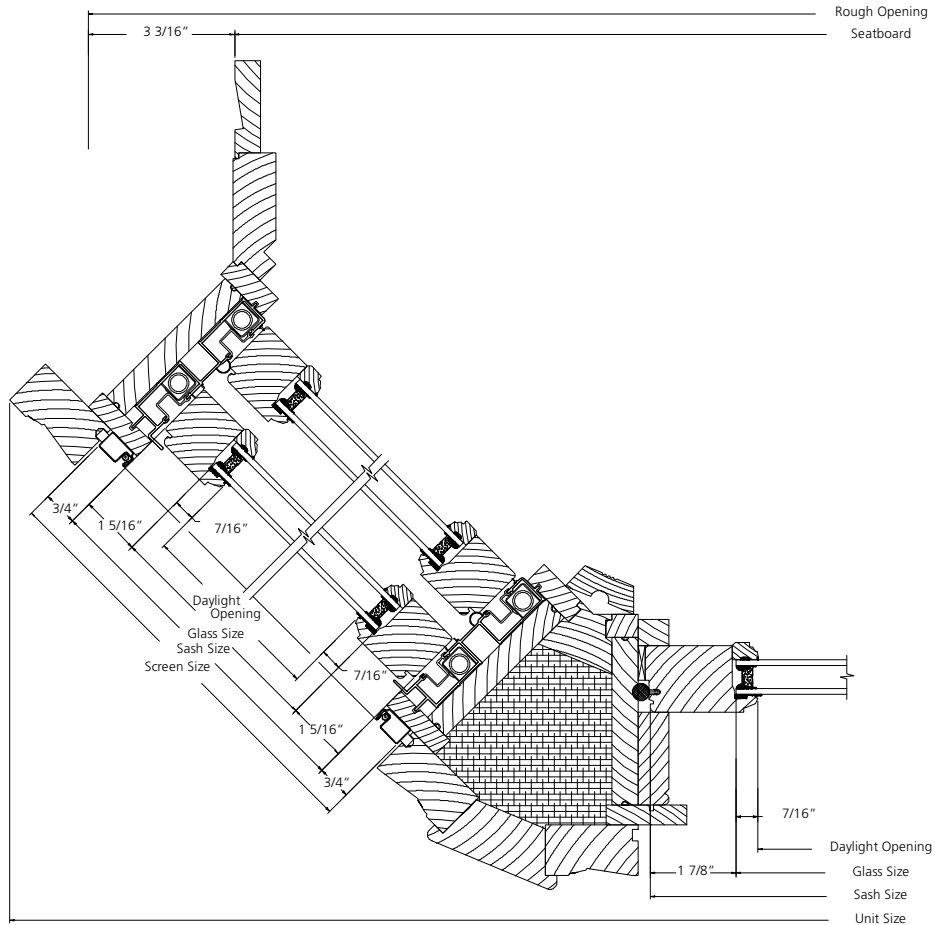

HORIZONTAL SECTION

SCALE: 3" = 1'

**45° ANGLE BAY UNIT
WITH OPERABLE CENTER**

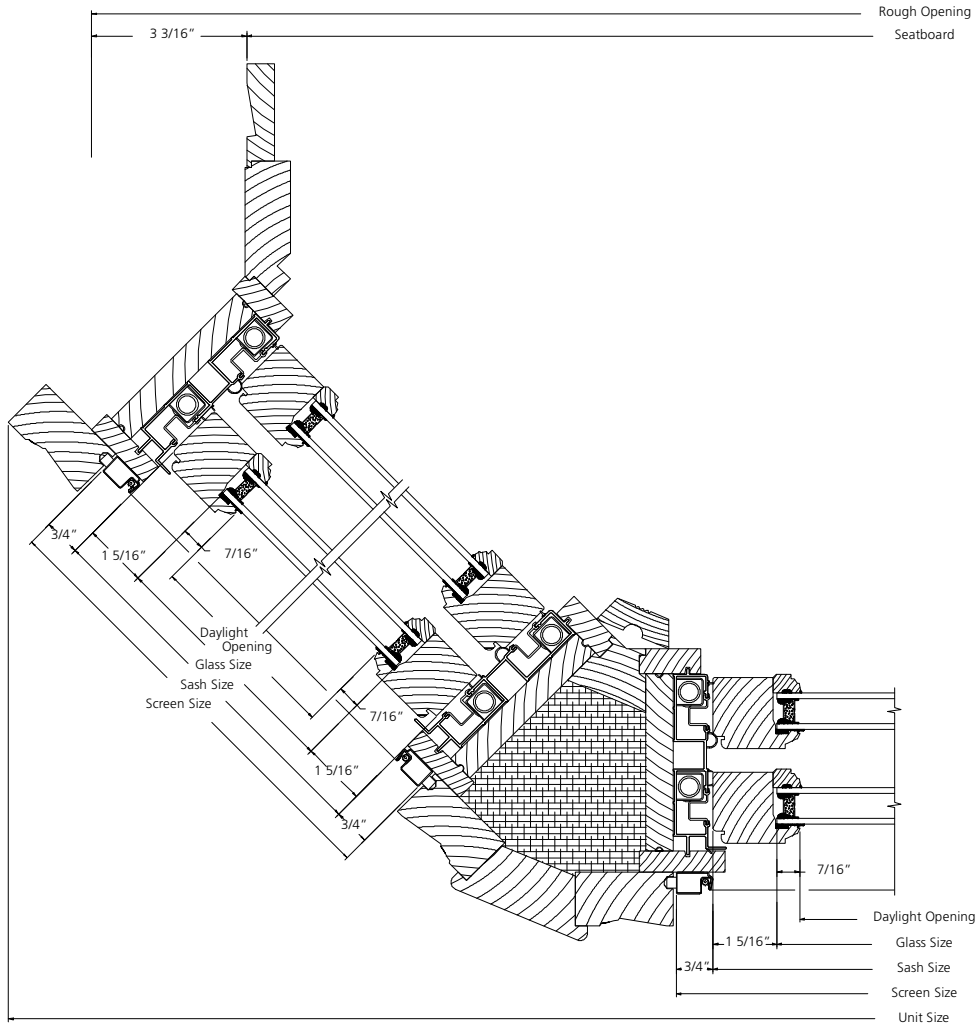

HORIZONTAL SECTION

SCALE: 3" = 1'