

TABLE OF CONTENTS

| | |
|--|------|
| Specifications | 9-2 |
| Quick Spec Guide | 9-3 |
| Elevations/Sizes: 1/4" Scale | 9-5 |
| Full Round Units | 9-8 |
| Oval Units | 9-9 |
| Ellipse Units | 9-10 |
| Casement and Door Quarter Round Units | 9-11 |
| Casement Half Round Units | 9-12 |
| Casement Extended Leg Half Round Units | 9-14 |
| Casement Extended Leg Segments | 9-21 |
| Double-Hung and Door Quarter Round Units | 9-28 |
| Double-Hung Half Round Units | 9-29 |
| Double-Hung Extended Leg Half Round Units | 9-30 |
| Double-Hung Extended Leg Segments | 9-35 |
| Swinging Patio Doors Half Round Units | 9-40 |
| Swinging Patio Doors Extended Leg Half Round Units | 9-41 |
| Swinging Patio Doors Extended Leg Segments | 9-45 |
| 300 Series Sliding Patio Doors Half Round Units | 9-49 |
| 300 Series Sliding Patio Doors Extended Leg Half Round Units | 9-50 |
| 300 Series Sliding Patio Doors Extended Leg Segments | 9-53 |
| 400 Series Sliding Patio Doors Half Round Units | 9-56 |
| 400 Series Sliding Patio Doors Extended Leg Half Round Units | 9-57 |
| 400 Series Sliding Patio Doors Extended Leg Segments | 9-60 |
| Glazing Options: 3" Scale | 9-63 |
| Trim Options: 3" Scale | 9-64 |
| Jamb Options: 3" Scale | 9-65 |
| Lite Cut Information | 9-66 |
| Layout Shapes | 9-70 |
| Unit Sizing, Rough Openings & Masonry Openings | 9-73 |
| Section Details: 6" Scale | 9-74 |

PRODUCT SPECIFICATIONS**EXTERIOR FINISH**

Exterior aluminum surfaces are low maintenance extruded aluminum coated with a thermo set polyester finish that meets or exceeds the AAMA 2603 performance standards. Standard colors include Brilliant White, Chestnut Bronze, Desert Sand, French Vanilla, Hartford Green, Mesa Red, Black, Arctic Silver and Dark Chocolate.

AURALAST® WOOD

AuraLast® wood is fundamentally different from wood resulting from traditional millwork preservation processes in that it uses a proprietary vacuum/pressure process to provide protection throughout the wood parts used to make windows and doors. AuraLast® wood is distinguished from wood using the current preservation methods by its unique ability to achieve greater penetration of the active ingredients into the wood parts, with a penetration of the treatment being a minimum of 92%.

INTERIOR FINISH

All interior surfaces are unfinished clear pine ready for on site finishing. Primed and pre-finished interiors are available in paint: Pure White, Extra White, Natural Choice, Moderate White; in stain: Wheat, Cherry, Fruitwood, Cordovan, Cider and Clear Lacquer. Optional interior wood species include mixed grain Douglas Fir and Knotty Alder.

FRAME

Frame is assembled from select kiln dried pine 1-5/32" (29.4mm) using AuraLast® wood on all exterior parts. All exposed exterior parts are completely covered with .050" extruded aluminum cladding. Basic jamb width is 2-1/2". Standard jamb width is 4-9/16" and may be extended for different wall depths. Exterior of frame is grooved to accept separate nailing fin or masonry installation clip and retrofit trim system.

SASH

Radius units may be specified as Direct Glazed or In-Sash. Sash match Casement/Awning profiles. Clad sash is covered with .047 extruded aluminum. All clad radius interiors are laminated or clear. On Direct-Set units glass is glazed into the sash with a durable clear silicone on the exterior and an acrylic sealant on the interior.

GLAZING

3/4" thick sealed insulating glass is constructed from two panes of glass, utilizing a continuous roll formed stainless steel spacer with dual seal sealant. All insulating glass units comply with the performance requirements of IGCC in accordance with either ASTM E774 or E2190.

Direct Glazed - Glass is direct glazed into the frame on the exterior with a butyl glazing tape and cap beaded with silicone. An adhesive butyl is applied to removable wood stops on the interior.

GLAZING OPTIONS

3/4" insulating glass available in Low-E with Argon, Low-E, Low-E 366, Clear, Neat Glass, reflective, tinted, or obscure, tempered or other specialty glass as specified. Preserve® film is a 0.003" thick polyethylene film with a low tack acrylic adhesive applied to the glass for protection during shipping and installation. 4,000 foot elevations and higher require a capillary tube to equalize environmental stress (otherwise known as High Altitude glazing). High Altitude glazing does not allow the use of Argon as listed under glazing options.

GRILLES

SDL (Simulated Divided Lites) - extruded aluminum muntins permanently applied to the exterior of the insulating glass unit (not available on textured glass) in 7/8" (22mm), 1-1/8" (28.5mm), or 1-3/8" (34.9mm) widths, and a putty profile in 5/8" (15.9mm), 7/8" (22mm) and 1-1/8" (28.5mm) widths only. SDL is standard with a light bronze internal shadow bar to give a true divided lite appearance. As an option, SDL may be ordered with a silver shadow bar. Clear wood interior muntin bars match the exterior muntin width and are permanently bonded to the interior of the glass. Also available is a 2-5/16" (59mm) SDL bar, which simulates a double-hung checkrail.

Wood Grilles - Rectangular unfinished clear pine wood grilles in 7/8" (22mm) are available in patterns selected by the owner. Direct-Sets are only available with KD Grilles.

GBG (Grilles between the Glass) - 5/8" (15.9mm) flat and 23/32" or 1" contour mounted between the glass panes suspended within the air cavity.

APPLIED ALUMINUM DRIP CAP (RADIUS UNITS)

Drip cap is made from .040" extruded aluminum, and is shaped by a precision bending process.

EXTENSION JAMBS

Extension jambs are factory applied to the interior on all four sides of the frame and are 4/4 standard thick pine to accommodate wall depths up to 7-1/4" with one piece, and up to 12" with two pieces. 9/16" (14.2mm) and 5/4 option also available.

RADIUS INSIDE TRIM

Laminated radius trim in Pine or Oak available in a variety of patterns. 3 x 3 Corner blocks in Pine or Oak also available.

INSTALLATION

Installation per JELD-WEN Installation Method for Metal Clad Windows JII002 or JII013. See www.jeld-wen.com/resources for instructions.

PERFORMANCE

NFRC Certified - (Rated and labeled in accordance with NFRC)

WDMA Hallmark Certified -
In accordance with **AAMA/NWWDA/101/I.S.2-97**

QUICK SPEC GUIDE

| SPECIFICATION | STANDARD FEATURES | OPTIONAL FEATURES <i>Some options may require additional lead times. Consult your JELD-WEN Sales Representative.</i> |
|------------------------|--|---|
| EXTERIOR FINISH | <ul style="list-style-type: none"> • Brilliant White • Chestnut Bronze • Desert Sand • French Vanilla • Mesa Red • Hartford Green • Black • Arctic Silver • Dark Chocolate | <ul style="list-style-type: none"> • Bronze • Heirloom White • Bone White • Dark Buckskin • Smoke • Mocha Cream • Hunter Green • Sage Brown • Redwood • Sea Foam • Ivory • Cascade |
| EXTERIOR TRIM | <ul style="list-style-type: none"> • Nailing Fin • Angle Shapes - Vinyl Drip Cap • Radius Shapes - Metal Drip Cap | <ul style="list-style-type: none"> • Aluminum 1-5/8" Brickmould with integral nailing fin • Adams or 3-1/2" Flat Casing with integral nailing fin • Angle Shapes - Clad Metal Drip Cap |
| INTERIOR WOOD | <ul style="list-style-type: none"> • Western Pine | <ul style="list-style-type: none"> • Knotty Alder • Mixed Grain Douglas Fir |
| INTERIOR FINISH | <ul style="list-style-type: none"> • Natural | <ul style="list-style-type: none"> • Priming Available • Prefinished Interior Options are: <ul style="list-style-type: none"> • Paint - Pure White, Extra White, Natural Choice, Moderate White • Stain - Wheat, Fruitwood, Cherry, Cordovan, Cider • Clear Lacquer |
| SIZE | <p>Radius Units</p> <ul style="list-style-type: none"> • Half Rounds: 26 Sizes • Quarter Rounds: 12 Sizes • Full Circles: 9 Sizes • Ellipticals: 2 Sizes • Ovals: 4 Sizes <p>Geometric Units</p> <ul style="list-style-type: none"> • All window units are made to specified Frame Dimensions, see sample elevations for required dimensions | <p>Size Limitations</p> <ul style="list-style-type: none"> • Units May Not Exceed 50 square feet • Some Sizes May Require Tempered Glazing |
| GLAZING | <ul style="list-style-type: none"> • Low-E Insulating Glass • Preserve® Protective Film | <ul style="list-style-type: none"> • Clear • Obscure • Bronze • Low-E 366 • Neat Glass • Dual Low-E • Reflective • Tempered • Decorative Glass <ul style="list-style-type: none"> ○ Craftsman ○ Classic ○ Contemporary ○ Estate • Custom Design Capability |
| | | <ul style="list-style-type: none"> • High Altitude |

Continued on next page

QUICK SPEC GUIDE

| SPECIFICATION | STANDARD FEATURES | OPTIONAL FEATURES <i>Some options may require additional lead times. Consult your JELD-WEN Sales Representative.</i> |
|-------------------------------|---|---|
| GRILLES | | <ul style="list-style-type: none"> • 5/8" Flat, 23/32" or 1" Contour GBG • Direct Glazed: 7/8" KD Wood Grilles SDL Bead Profile: <ul style="list-style-type: none"> • 7/8", 1-1/8", 1-3/8", 2-5/16" with Light Bronze Shadow Bar • 7/8", 1-1/8", 1-3/8", 2-5/16" with Silver Shadow Bar <ul style="list-style-type: none"> • Patterns may be Colonial, Renaissance, Prairie or Gothic (not limited to stated patterns) SDL Putty Profile: <ul style="list-style-type: none"> • 5/8", 7/8", 1-1/8" with Light Bronze Shadow Bar • 5/8", 7/8", 1-1/8" with Silver Shadow Bar |
| INTERIOR RADIUS CASING | | <ul style="list-style-type: none"> • Seven Patterns • Other casings may be available |
| JAMB | <ul style="list-style-type: none"> • 4-9/16" | <ul style="list-style-type: none"> • Minimum: 2-1/2" • Maximum: 7-1/4" (one piece) • Maximum: 12" (two piece) |

GENERAL INFORMATION

STANDARD SIZES & DESIGNS

Clad geometric windows are produced one-at-a-time to customer order, and are available in a nearly infinite range of sizes and shapes. Specified sizes, angles, and radii can be attained in finished units, to meet the most demanding architectural requirements.

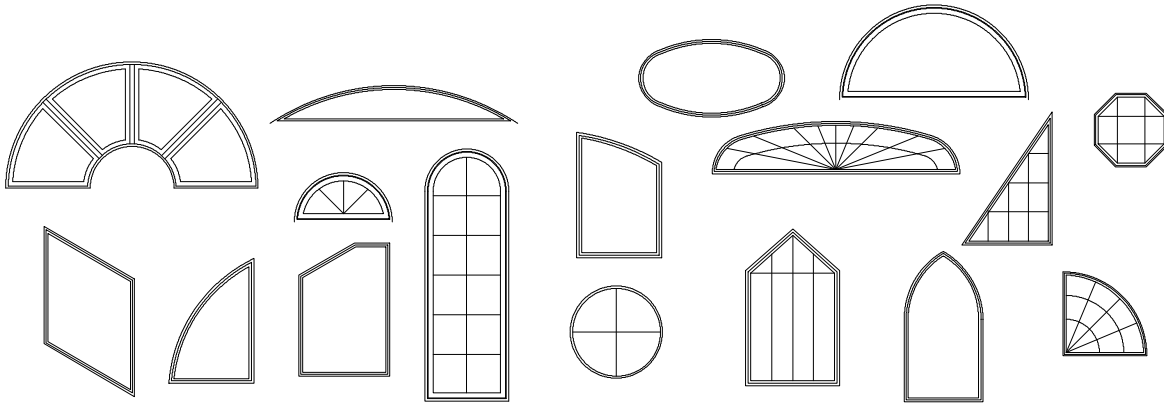

MULTIPLE ASSEMBLIES

Clad direct-set geometric windows may be mullered above, below, or beside other clad geometric windows, or other clad window or patio door products. Factory assembled mulls are limited in height (100"), width (150"), and total area (75 square feet).

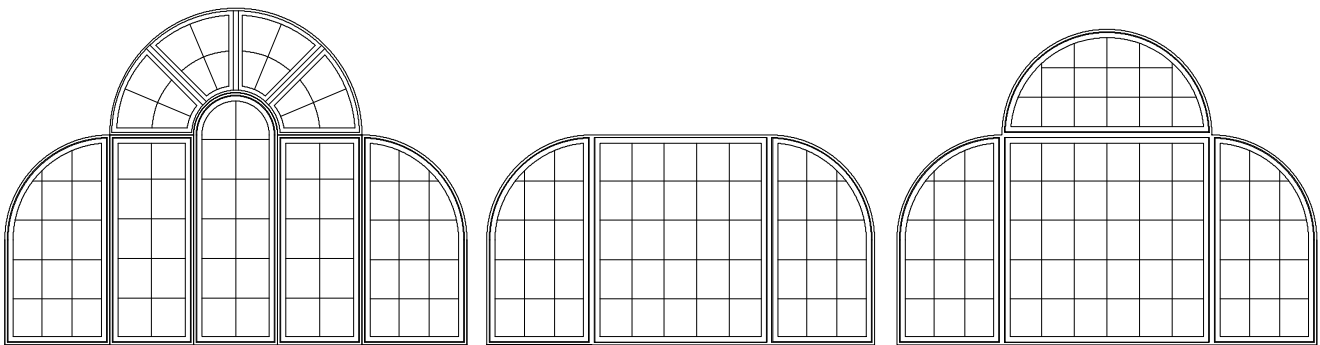

ELEVATION NOTES

ELEVATION DRAWINGS UTILIZE A LIMITED NUMBER OF PROJECTED LINES TO PRODUCE A RUDIMENTARY DRAWING INTENDED TO BE USED IN A SMALL GRAPHICAL SCALE. ELEVATIONS ARE VIEWED PERPENDICULAR FROM THE EXTERIOR OF THE STRUCTURE. IF MORE DIMENSIONS ARE NEEDED, USE THE SECTION DRAWINGS FOR MORE COMPLETE DEPICTIONS.

BOOK CODE DEFINITIONS

- | | |
|-----------------|--|
| 1. ECXXHRDS | SITELINE EX CLAD HALF ROUND DIRECT SET |
| 2. ECXXHRDS | SITELINE EX CLAD DOUBLE HUNG HALF ROUND DIRECT SET |
| 3. ECIPDXXHRDS | SITELINE EX CLAD INSWING PATIO DOOR HALF ROUND DIRECT SET |
| 4. ECIPDXXHRDS | SITELINE EX CLAD INSWING PATIO DOOR TRUE HALF ROUND DIRECT SET |
| 5. ECOPDXXHRDS | SITELINE EX CLAD OUTSWING PATIO DOOR HALF ROUND DIRECT SET |
| 6. ECOPDXXHRDS | SITELINE EXCLAD OUTSWING PATIO DOOR TRUE HALF ROUND DIRECT SET |
| 7. ECXXQRDS | SITELINE EX CLAD QUARTER ROUND DIRECT SET |
| 8. ECXXFRDS | SITELINE EX CLAD FULL ROUND DIRECT SET |
| 9. ECOCXXDS | SITELINE EX CLAD OCTAGON DIRECT SET |
| 10. ECDHRXXQRDS | SITELINE EX CLAD DOUBLE HUNG QUARTER ROUND DIRECT SET |

M.O. Brickmould
M.O. Adams/Flat Casing

Frame Size
Daylight Opening

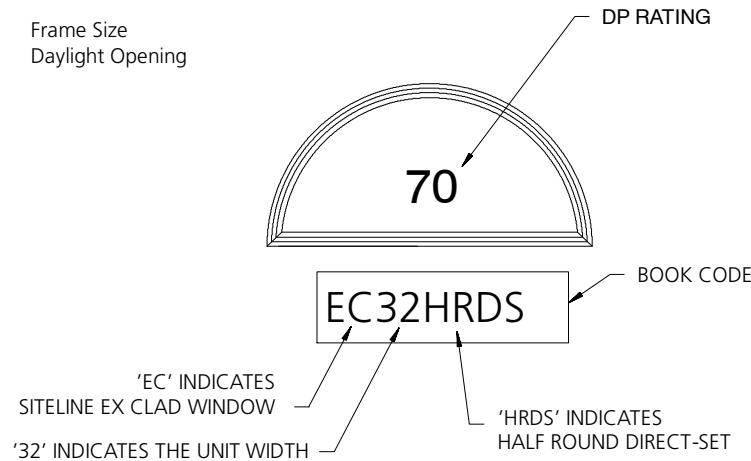

GENERAL NOTES

1. UNIT ELEVATIONS ARE SHOWN WITHOUT EXTERIOR TRIM.
2. ALL UNITS ARE SHOWN AS FIXED ONLY.
3. TO DETERMINE DAYLIGHT OPENING, DEDUCT 3 3/16" (97) FROM FRAME SIZE.
4. UNITS ARE SHOWN AS ONE LITES. SEE THE STANDARD LITE CUT PAGES FOR INFORMATION ON AVAILABLE LITE CUT CONFIGURATIONS.
5. GLASS SIZES ARE NOMINAL.
6. VALUES IN PARENTHESES ARE MILLIMETER CONVERSIONS.

ELEVATION SYMBOL LEGEND:

M.O. MASONRY OPENING

SUBSILL RESTRICTIONS

SUBSILL MAY NOT BE APPLIED TO FULL ROUND, OVAL, INVERTED HALF ROUND OR INVERTED QUARTER ROUND UNITS.

ELEVATION NOTES

GEOMETRIC ELEVATIONS:

THE POSSIBLE SHAPES AND CONFIGURATIONS OF GEOMETRIC WINDOWS ARE TOO NUMEROUS TO OFFER IN A DRAWING FORMAT. CREATE THE OUTSIDE FRAME LINES OF THE GEOMETRIC SHAPE DESIRED. REFER TO SECTION DETAILS AND DIMENSIONS TO FIND THE APPROPRIATE OFFSET DIMENSIONS FOR FRAME FEATURES AND DAYLIGHT OPENING. THE FOLLOWING INFORMATION DETAILS THE CREATION OF TRIM AND SUBSILL FOR GEOMETRIC ELEVATIONS.

STANDARD ELEVATIONS

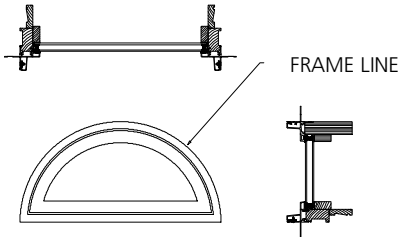

STANDARD GEOMETRIC ELEVATIONS

Geometric elevations are drawn as 'Frame Only' (without trim) to simplify mulling and multiple assemblies. Trim and subsill applications can easily be offset from frame lines to create the desired trim and finish.

MULLING CLAD UNITS

All clad elevations are shown without any exterior trim. When mulling clad units the outside line is always the frame. Refer to Mullion Details for specifications.

TRIM - ALL SIDES

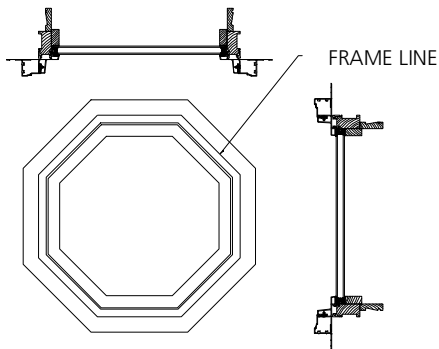

TRIM - ALL SIDES

Applying trim to all 4 sides of an elevation is an offset from the frame. See Unit Sizing, Rough Openings & Masonry Openings page for offset dimensions of various trim options.

SUBSILL

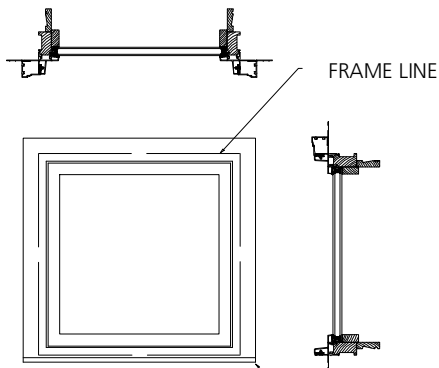

SUBSILL

Subsill is applied to the bottom of straight line portions of the window. The subsill is continuous to the outside dimensions of the units frame or trim. The application of subsill will affect the rough opening by adding 1" to the rough opening height. See Unit Sizing, Rough Opening & Masonry Openings page for more information.

SUBSILL RESTRICTIONS

Subsill may not be applied to octagon, full round, oval, inverted half round or inverted quarter round units.

SUBSILL EXTENDS TO OUTSIDE
EDGE OF THE TRIM

FULL ROUND UNITS

M.O. BRICKMOULD
M.O. ADAMS/FLAT CASING
ROUGH OPENING
FRAME SIZE
DAYLIGHT OPENING

27 1/2" (699)
30 1/2" (775)
24 3/4" (629)
24" (610)
20 3/8" (518)

31 1/2" (800)
34 1/2" (876)
28 3/4" (730)
28" (711)
24 3/8" (619)

33 1/2" (851)
36 1/2" (927)
30 3/4" (781)
30" (762)
26 3/8" (670)

39 1/2" (1003)
42 1/2" (1080)
36 3/4" (933)
36" (914)
32 3/8" (822)

45 1/2" (1156)
48 1/2" (1232)
42 3/4" (1086)
42" (1067)
38 3/8" (975)

27 1/2" (699)
30 1/2" (775)
24 3/4" (629)
24" (610)
20 3/8" (518)



EC24FRDS

31 1/2" (800)
34 1/2" (876)
28 3/4" (730)
28" (711)
24 3/8" (619)

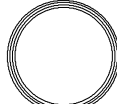

EC28FRDS

33 1/2" (851)
36 1/2" (927)
30 3/4" (781)
30" (762)
26 3/8" (670)

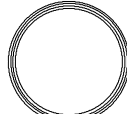

EC30FRDS

39 1/2" (1003)
42 1/2" (1080)
36 3/4" (933)
36" (914)
32 3/8" (822)

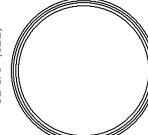

EC36FRDS

45 1/2" (1156)
48 1/2" (1232)
42 3/4" (1086)
42" (1067)
38 3/8" (975)

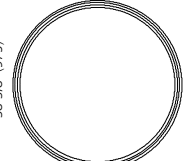

EC42FRDS

M.O. BRICKMOULD
M.O. ADAMS/FLAT CASING
ROUGH OPENING
FRAME SIZE
DAYLIGHT OPENING

51 1/2" (1308)
54 1/2" (1384)
48 3/4" (1238)
48" (1219)
44 3/8" (1127)

51 1/2" (1308)
54 1/2" (1384)
48 3/4" (1238)
48" (1219)
44 3/8" (1127)

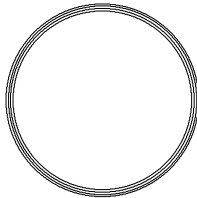

EC48FRDS

57 1/2" (1461)
60 1/2" (1537)
54 3/4" (1391)
54" (1372)
50 3/8" (1280)

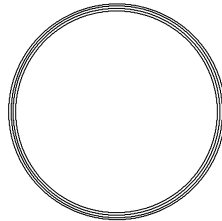

EC54FRDS

63 1/2" (1613)
66 1/2" (1689)
60 3/4" (1543)
60" (1524)
56 3/8" (1432)

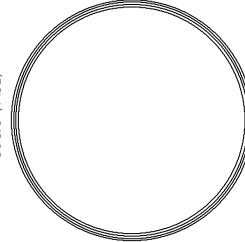

EC60FRDS

M.O. BRICKMOULD
M.O. ADAMS/FLAT CASING
ROUGH OPENING
FRAME SIZE
DAYLIGHT OPENING

75 1/2" (1918)
78 1/2" (1994)
72 3/4" (1848)
72" (1829)
68 3/8" (1737)

75 1/2" (1918)
78 1/2" (1994)
72 3/4" (1848)
72" (1829)
68 3/8" (1737)

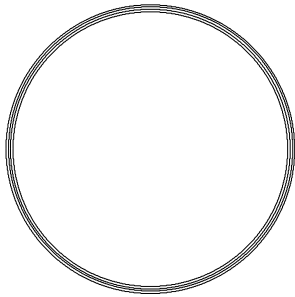

EC72FRDS

ELEVATION SYMBOL LEGEND:

M.O. = MASONRY OPENING
VALUES IN () ARE IN MILLIMETER CONVERSIONS

Note: Elevations shown DO NOT have exterior trim. Subtract 1/2" (12.7) from M.O. (Masonry Opening) for Unit Sizes. Masonry Openings above include Sill Nose, see Trim Options page for Sill Nose specifications. For other Trim Options refer to the Unit Sizing, Rough Opening & Masonry Openings page.

SCALE 1/4" = 1'

OVAL UNITS

| | | |
|-------------------------|---------------|---------------|
| ROUGH OPENING | 24 3/4" (629) | 30 3/4" (781) |
| FRAME SIZE | 24" (610) | 30" (762) |
| DAYLIGHT OPENING | 20 3/8" (518) | 26 3/8" (670) |

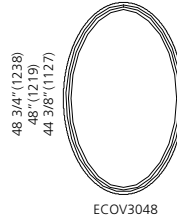
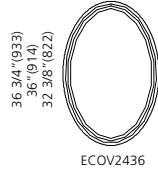

| | | |
|-------------------------|---------------|----------------|
| ROUGH OPENING | 36 3/4" (933) | 48 3/4" (1238) |
| FRAME SIZE | 36" (914) | 48" (1219) |
| DAYLIGHT OPENING | 32 3/8" (822) | 44 3/8" (1127) |

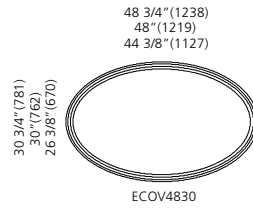
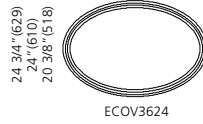

ELEVATION SYMBOL LEGEND:

VALUES IN () ARE IN MILLIMETER CONVERSIONS
UNITS UNDER 30" IN WIDTH ARE NOT OFFERED WITH BRICKMOULD TRIM.

Note: Elevations shown DO NOT have exterior trim. Subtract 1/2" (12.7) from M.O. (Masonry Opening) for Unit Sizes. Masonry Openings above include Sill Nose, see Trim Options page for Sill Nose specifications. For other Trim Options refer to the Unit Sizing, Rough Opening & Masonry Openings page.

SCALE 1/4" = 1'

ELLIPSE UNITS

M.O. BRICKMOULD
M.O. ADAMS/FLAT CASING
ROUGH OPENING
FRAME SIZE
DAYLIGHT OPENING

63 1/2" (1613)
66 1/2" (1689)
69 3/4" (1743)
60" (1524)
56 3/8" (1432)

75 1/2" (1918)
78 1/2" (1994)
72 3/4" (1848)
72" (1829)
68 3/8" (1737)

18 11/16" (475)
20 3/16" (513)
17 1/8" (435)
16 3/8" (416)
12 3/4" (324)



ECEL60



ECEL72

ELEVATION SYMBOL LEGEND:

VALUES IN () ARE IN MILLIMETER CONVERSIONS

UNITS UNDER 30" IN WIDTH ARE NOT OFFERED WITH BRICKMOULD TRIM.

Note: Elevations shown DO NOT have exterior trim. Subtract 1/2" (12.7) from M.O. (Masonry Opening) for Unit Sizes. Masonry Openings above include Sill Nose, see Trim Options page for Sill Nose specifications. For other Trim Options refer to the Unit Sizing, Rough Opening & Masonry Openings page.

CASEMENT AND DOOR QUARTER ROUND UNITS

M.O. BRICKMOULD
M.O. ADAMS/FLAT CASING
ROUGH OPENING
FRAME SIZE
DAYLIGHT OPENING

18 3/4" (476)
18" (457)
14 3/8" (365)

18 3/4" (476)
18" (457)
14 3/8" (365)



ECC18QRDS

20 3/4" (527)
20" (508)
16 3/8" (416)

20 3/4" (527)
20" (508)
16 3/8" (416)

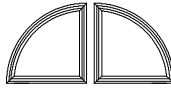

ECC20QRDS

27 1/2" (699)
30 1/2" (775)
24 3/4" (629)
24" (610)
20 3/8" (518)

26 5/16" (668)
27 13/16" (706)
24 3/4" (629)
24" (610)
20 3/8" (518)

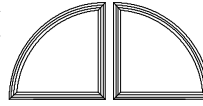

ECC24QRDS

31 1/2" (800)
34 1/2" (876)
28 3/4" (730)
28" (711)
24 3/8" (619)

30 5/16" (770)
31 13/16" (808)
28 3/4" (730)
28" (711)
24 3/8" (619)

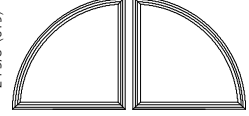

ECC28QRDS

M.O. BRICKMOULD
M.O. ADAMS/FLAT CASING
ROUGH OPENING
FRAME SIZE
DAYLIGHT OPENING

33 1/2" (851)
36 1/2" (927)
30 3/4" (781)
30" (762)
26 3/8" (670)

32 5/16" (821)
33 13/16" (859)
30 3/4" (781)
30" (762)
26 3/8" (670)

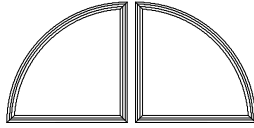

ECC30QRDS

35 1/2" (902)
38 1/2" (978)
32 3/4" (832)
32" (813)
28 3/8" (721)

34 5/16" (872)
35 1/16" (890)
32 3/4" (832)
32" (813)
28 3/8" (721)

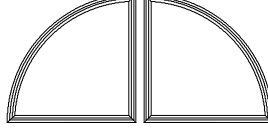

ECC32QRDS

39 1/2" (1003)
42 1/2" (1080)
36 3/4" (933)
36" (914)
32 3/8" (822)

38 5/16" (973)
39 13/16" (1011)
36 3/4" (933)
36" (914)
32 3/8" (822)

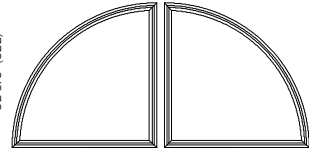

ECC36QRDS

M.O. BRICKMOULD
M.O. ADAMS/FLAT CASING
ROUGH OPENING
FRAME SIZE
DAYLIGHT OPENING

45 1/2" (1156)
48 1/2" (1232)
42 3/4" (1086)
42" (1067)
38 3/8" (975)

44 5/16" (1126)
45 13/16" (1164)
42 3/4" (1086)
42" (1067)
38 3/8" (975)

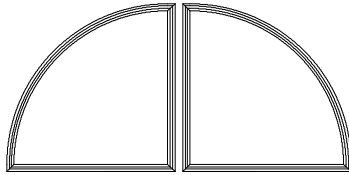

ECC42QRDS

51 1/2" (1308)
54 1/2" (1384)
48 3/4" (1238)
48" (1219)
44 3/8" (1127)

50 5/16" (1278)
51 13/16" (1316)
48 3/4" (1238)
48" (1219)
44 3/8" (1127)

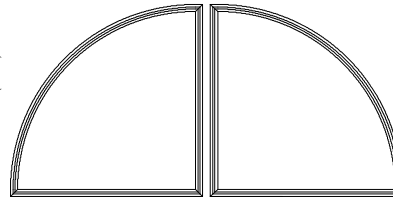

ECC48QRDS

ELEVATION SYMBOL LEGEND:

M.O. = MASONRY OPENING

VALUES IN () ARE IN MILLIMETER CONVERSIONS

UNITS UNDER 30" IN WIDTH ARE NOT OFFERED WITH BRICKMOULD TRIM.

Note: Elevations shown DO NOT have exterior trim. Subtract 1/2" (12.7) from M.O. (Masonry Opening) for Unit Sizes. Masonry Openings above include Sill Nose, see Trim Options page for Sill Nose specifications. For other Trim Options refer to the Unit Sizing, Rough Opening & Masonry Openings page.

CASEMENT HALF ROUND UNITS

M.O. BRICKMOULD
M.O. ADAMS/FLAT CASING
ROUGH OPENING
FRAME SIZE
DAYLIGHT OPENING

24 3/4" (629)
24" (610)
20 3/8" (518)

12 3/4" (324)
14" (356)
8 3/8" (213)



ECC24HRDS

28 3/4" (730)
28" (711)
24 3/8" (619)



ECC28HRDS

33 1/2" (851)
36 1/2" (927)
30 3/4" (781)
30" (762)
26 3/8" (670)



ECC30HRDS

35 1/2" (902)
38 1/2" (978)
32 3/4" (832)
32" (813)
28 3/8" (721)



ECC32HRDS

39 1/2" (1003)
42 1/2" (1080)
36 3/4" (933)
36" (914)
32 3/8" (822)



ECC36HRDS

M.O. BRICKMOULD
M.O. ADAMS/FLAT CASING
ROUGH OPENING
FRAME SIZE
DAYLIGHT OPENING

43 1/2" (1105)
46 1/2" (1181)
40 3/4" (1035)
40" (1016)
36 3/8" (924)

22 5/16" (578)
23 13/16" (605)
20 3/8" (527)
20 3/4" (530)
16 3/8" (416)



ECC40HRDS

23 5/16" (592)
24 13/16" (630)
21 3/4" (552)
21" (533)
17 3/8" (441)



ECC42HRDS

45 1/2" (1156)
48 1/2" (1232)
42 3/4" (1086)
42" (1067)
38 3/8" (975)



51 1/2" (1308)
54 1/2" (1384)
48 3/4" (1238)
48" (1219)
44 3/8" (1127)



ECC48HRDS

57 1/2" (1461)
60 1/2" (1537)
54 3/4" (1391)
54" (1372)
50 3/8" (1280)



ECC54HRDS

M.O. BRICKMOULD
M.O. ADAMS/FLAT CASING
ROUGH OPENING
FRAME SIZE
DAYLIGHT OPENING

59 1/2" (1511)
62 1/2" (1588)
56 3/4" (1441)
56" (1422)
52 3/8" (1330)

30 5/16" (770)
31 13/16" (808)
28 3/4" (730)
28 3/8" (713)
24 3/8" (619)



ECC56HRDS

32 5/16" (821)
33 13/16" (859)
30 3/4" (781)
30" (762)
26 3/8" (670)



ECC60HRDS

63 1/2" (1613)
66 1/2" (1689)
60 3/4" (1543)
60" (1524)
56 3/8" (1432)

34 5/16" (872)
35 13/16" (910)
32 3/4" (832)
32" (813)
28 3/8" (721)



ECC64HRDS

67 1/2" (1715)
70 1/2" (1791)
64 3/4" (1645)
64" (1626)
60 3/8" (1534)

M.O. BRICKMOULD
M.O. ADAMS/FLAT CASING
ROUGH OPENING
FRAME SIZE
DAYLIGHT OPENING

69 1/2" (1765)
72 1/2" (1842)
66 3/4" (1695)
66" (1676)
62 3/8" (1584)

35 5/16" (897)
36 13/16" (935)
33 3/4" (857)
33 1/8" (840)
29 3/8" (746)



ECC66HRDS

38 5/16" (973)
39 13/16" (1011)
36 3/4" (933)
36" (914)
32 3/8" (822)



ECC72HRDS

75 1/2" (1918)
78 1/2" (1994)
72 3/4" (1848)
72" (1829)
68 3/8" (1737)

41 5/16" (1049)
42 13/16" (1087)
39 3/4" (1010)
39 1/8" (993)
35 3/8" (899)



ECC78HRDS

81 1/2" (2070)
84 1/2" (2146)
78 3/4" (2000)
78" (1981)
74 3/8" (1889)

M.O. BRICKMOULD
M.O. ADAMS/FLAT CASING
ROUGH OPENING
FRAME SIZE
DAYLIGHT OPENING

87 1/2" (2223)
90 1/2" (2299)
84 3/4" (2153)
84" (2134)
80 3/8" (2042)

44 5/16" (1126)
45 13/16" (1164)
42 3/4" (1086)
42 3/8" (1069)
38 3/8" (975)



ECC84HRDS

47 5/16" (1202)
48 13/16" (1240)
45 3/4" (1162)
45" (1143)
41 3/8" (1051)



ECC90HRDS

93 1/2" (2380)
96 1/2" (2451)
90 3/4" (2305)
90" (2286)
86 3/8" (2194)

ELEVATION SYMBOL LEGEND:

M.O. = MASONRY OPENING
VALUES IN () ARE IN MILLIMETER CONVERSIONS
UNITS UNDER 30" IN WIDTH ARE NOT OFFERED WITH BRICKMOULD TRIM.

Note: Elevations shown DO NOT have exterior trim. Subtract 1/2" (12.7) from M.O. (Masonry Opening) for Unit Sizes. Masonry Openings above include Sill Nose, see Trim Options page for Sill Nose specifications. For other Trim Options refer to the Unit Sizing, Rough Opening & Masonry Openings page.

SCALE 1/4" = 1'

CASEMENT HALF ROUND UNITS

| | |
|-------------------------------|-----------------|
| M.O. BRICKMOULD | 99 1/2" (2527) |
| M.O. ADAMS/FLAT CASING | 102 1/2" (2604) |
| ROUGH OPENING | 96 3/4" (2457) |
| FRAME SIZE | 96" (2438) |
| DAYLIGHT OPENING | 92 3/8" (2346) |

| |
|------------------|
| 50 5/16" (1278) |
| 51 13/16" (1316) |
| 48 3/4" (1238) |
| 48" (1219) |
| 44 3/8" (1127) |

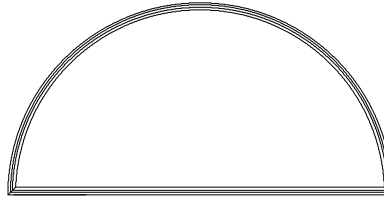

ECC96HRDS

ELEVATION SYMBOL LEGEND:

M.O. = MASONRY OPENING
VALUES IN () ARE IN MILLIMETER CONVERSIONS
UNITS UNDER 30" IN WIDTH ARE NOT OFFERED WITH BRICKMOULD TRIM.

Note: Elevations shown DO NOT have exterior trim. Subtract 1/2" (12.7) from M.O. (Masonry Opening) for Unit Sizes. Masonry Openings above include Sill Nose, see Trim Options page for Sill Nose specifications. For other Trim Options refer to the Unit Sizing, Rough Opening & Masonry Openings page.

SCALE 1/4" = 1'

CASEMENT EXTENDED LEG HALF ROUND UNITS

M.O. BRICKMOULD
M.O. ADAMS/FLAT CASING
ROUGH OPENING
FRAME SIZE
DAYLIGHT OPENING

| | | | | |
|--|--|---|---|---|
| 24 3/4" (629) 24" (610) 20 3/8" (518) | 28 3/4" (730) 28" (711) 24 3/8" (619) | 33 1/2" (851) 36 1/2" (927) 30 3/4" (781) 30" (762) 26 3/8" (670) | 39 1/2" (1003) 42 1/2" (1080) 36 3/4" (933) 36" (914) 32 3/8" (822) | 51 1/2" (1308) 54 1/2" (1384) 48 3/4" (1238) 48" (1219) 44 3/8" (1127) |
| 18 3/4" (476) 18" (457) 14 3/8" (365) | 20 3/4" (527) 20" (508) 16 3/8" (416) | 23 5/16" (592) 24 13/16" (630) 21 3/4" (552) 21" (533) 17 3/8" (441) | 26 5/16" (668) 29 13/16" (706) 24 3/4" (629) 24" (610) 20 3/8" (518) | 32 5/16" (821) 33 13/16" (859) 30 3/4" (781) 30" (762) 26 3/8" (670) |
| 24 3/4" (629) 24" (610) 20 3/8" (518) | 26 3/4" (679) 26" (660) 22 3/8" (568) | 29 5/16" (745) 30 13/16" (783) 27 3/4" (705) 27" (686) 23 3/8" (594) | 32 5/16" (831) 33 13/16" (869) 30 3/4" (781) 30" (762) 26 3/8" (670) | 38 5/16" (973) 39 13/16" (1011) 36 3/4" (933) 36" (914) 32 3/8" (822) |
| 30 3/4" (781) 30" (762) 26 3/8" (670) | 32 3/4" (832) 32" (813) 28 3/8" (721) | 35 5/16" (897) 36 13/16" (935) 33 3/4" (857) 33" (838) 29 3/8" (746) | 38 5/16" (973) 39 13/16" (1011) 36 3/4" (933) 36" (914) 32 3/8" (822) | 44 5/16" (1126) 45 13/16" (1164) 42 3/4" (1086) 42" (1067) 38 3/8" (975) |
| 36 3/4" (933) 36" (914) 32 3/8" (822) | 38 3/4" (984) 38" (965) 34 3/8" (873) | 41 5/16" (1049) 42 13/16" (1087) 39 3/4" (1010) 39" (991) 35 3/8" (899) | 44 5/16" (1126) 45 13/16" (1164) 42 3/4" (1086) 42" (1067) 38 3/8" (975) | 50 5/16" (1278) 51 13/16" (1316) 48 3/4" (1238) 48" (1219) 44 3/8" (1127) |
| 48 3/4" (1238) 48" (1219) 44 3/8" (1127) | 50 3/4" (1289) 50" (1270) 46 3/8" (1178) | 53 5/16" (1354) 54 13/16" (1392) 51 3/4" (1314) 51" (1295) 47 3/8" (1203) | 56 5/16" (1430) 57 13/16" (1468) 54 3/4" (1391) 54" (1372) 50 3/8" (1280) | 62 5/16" (1583) 63 13/16" (1621) 60 3/4" (1543) 60" (1524) 56 3/8" (1432) |
| 60 3/4" (1543) 60" (1524) 56 3/8" (1432) | 62 3/4" (1594) 62" (1575) 58 3/8" (1483) | 65 5/16" (1659) 66 13/16" (1697) 63 3/4" (1619) 63" (1600) 59 3/8" (1508) | 68 5/16" (1735) 69 13/16" (1773) 66 3/4" (1695) 66" (1676) 62 3/8" (1584) | 74 5/16" (1888) 75 13/16" (1926) 72 3/4" (1848) 72" (1829) 68 3/8" (1737) |

ELEVATION SYMBOL LEGEND:

M.O. = MASONRY OPENING
VALUES IN () ARE IN MILLIMETER CONVERSIONS
UNITS UNDER 30" IN WIDTH ARE NOT OFFERED WITH BRICKMOULD TRIM.

Note: Elevations shown DO NOT have exterior trim. Subtract 1/2" (12.7) from M.O. (Masonry Opening) for Unit Sizes. Masonry Openings above include Sill Nose, see Trim Options page for Sill Nose specifications. For other Trim Options refer to the Unit Sizing, Rough Opening & Masonry Openings page.

SCALE 1/4" = 1'

CASEMENT EXTENDED LEG HALF ROUND UNITS

M.O. BRICKMOLD
M.O. ADAMS/FLAT CASING
ROUGH OPENING
FRAME SIZE
DAYLIGHT OPENING

| | | | | |
|--|--|---|---|---|
| 24 3/4" (629) 24" (610) 20 3/8" (518) | 28 3/4" (730) 28" (711) 24 3/8" (619) | 33 1/2" (851) 36 1/2" (927) 30 3/4" (781) 30" (762) 26 3/8" (670) | 39 1/2" (1003) 42 1/2" (1080) 36 3/4" (933) 36" (914) 32 3/8" (822) | 51 1/2" (1308) 54 1/2" (1384) 48 3/4" (1238) 48" (1219) 44 3/8" (1127) |
| 72 3/4" (1848) 74" (1880) 77" (1929) 68 3/8" (1737) | 74 3/4" (1899) 74" (1880) 70 3/8" (1788) | 77 5/16" (1964) 78 13/16" (2002) 75 3/4" (1924) 75" (1905) 71 3/8" (1813) | 80 5/16" (2040) 81 13/16" (2078) 78 3/4" (2000) 78" (1981) 74 3/8" (1889) | 86 5/16" (2192) 87 13/16" (2230) 84 3/4" (2153) 84" (2134) 80 3/8" (2042) |
| EC2472ELHRDS | EC2874ELHRDS | EC3075ELHRDS | EC3678ELHRDS | EC4884ELHRDS |
| 84 3/4" (2153) 84" (2134) 80 3/8" (2042) | 86 3/4" (2203) 86" (2184) 82 3/8" (2092) | 89 5/16" (2269) 90 13/16" (2307) 87 3/4" (2229) 87" (2210) 83 3/8" (2118) | 92 5/16" (2345) 93 13/16" (2383) 90 3/4" (2305) 90" (2286) 86 3/8" (2194) | 98 5/16" (2497) 99 13/16" (2535) 96 3/4" (2457) 96" (2438) 92 3/8" (2346) |
| EC2484ELHRDS | EC2886ELHRDS | EC3087ELHRDS | EC3690ELHRDS | EC4896ELHRDS |

ELEVATION SYMBOL LEGEND:
M.O. = MASONRY OPENING
VALUES IN () ARE IN MILLIMETER CONVERSIONS
UNITS UNDER 30" IN WIDTH ARE NOT OFFERED WITH BRICKMOLD TRIM.

Note: Elevations shown DO NOT have exterior trim. Subtract 1/2" (12.7) from M.O. (Masonry Opening) for Unit Sizes. Masonry Openings above include Sill Nose, see Trim Options page for Sill Nose specifications. For other Trim Options refer to the Unit Sizing, Rough Opening & Masonry Openings page.

SCALE 1/4" = 1'

CASEMENT EXTENDED LEG HALF ROUND UNITS

M.O. BRICKMOULD
M.O. ADAMS/FLAT CASING
ROUGH OPENING
FRAME SIZE
DAYLIGHT OPENING

59 1/2" (1511)
62 1/2" (1588)
56 3/4" (1441)
56" (1422)
52 3/8" (1330)

63 1/2" (1613)
66 1/2" (1689)
60 3/4" (1543)
60" (1524)
56 3/8" (1432)

69 1/2" (1765)
72 1/2" (1842)
66 3/4" (1695)
66" (1676)
62 3/8" (1584)

36 5/16" (922)
37 13/16" (960)
34 3/4" (883)
34" (864)
30 3/8" (772)

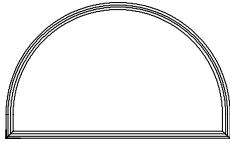

EC5634ELHRDS

38 5/16" (973)
39 13/16" (1011)
36 3/4" (933)
36" (914)
32 3/8" (822)

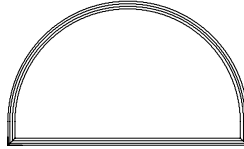

EC6036ELHRDS

41 5/16" (1049)
42 13/16" (1087)
39 3/4" (1010)
39" (991)
35 3/8" (899)

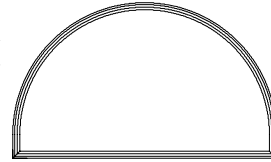

EC6639ELHRDS

42 5/16" (1075)
43 13/16" (1113)
40 3/4" (1035)
40" (1016)
36 3/8" (924)

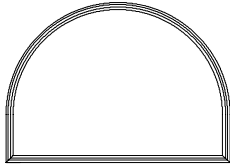

EC5640ELHRDS

44 5/16" (1126)
45 13/16" (1164)
42 3/4" (1086)
42" (1067)
38 3/8" (975)

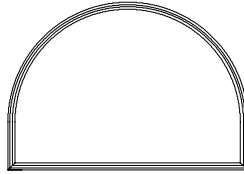

EC6042ELHRDS

47 5/16" (1202)
48 13/16" (1240)
45 3/4" (1162)
45" (1143)
41 3/8" (1051)

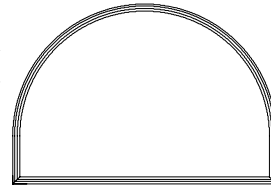

EC6645ELHRDS

48 5/16" (1227)
49 13/16" (1265)
46 3/4" (1187)
46" (1168)
42 3/8" (1076)

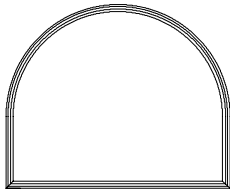

EC5646ELHRDS

50 5/16" (1278)
51 13/16" (1316)
48 3/4" (1238)
48" (1219)
44 3/8" (1127)

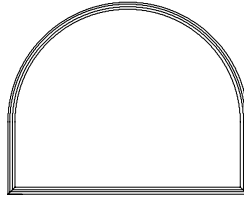

EC6048ELHRDS

53 5/16" (1354)
54 13/16" (1392)
51 3/4" (1314)
51" (1295)
47 3/8" (1203)

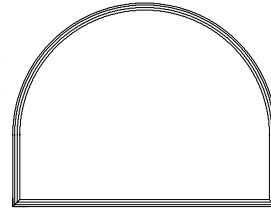

EC6651ELHRDS

54 5/16" (1380)
55 13/16" (1418)
52 3/4" (1340)
52" (1321)
48 3/8" (1229)

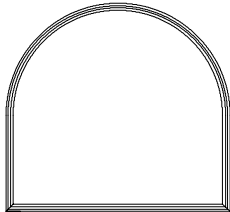

EC5652ELHRDS

56 5/16" (1430)
57 13/16" (1468)
54 3/4" (1391)
54" (1372)
50 3/8" (1280)

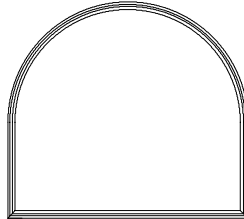

EC6054ELHRDS

59 5/16" (1507)
60 13/16" (1545)
57 3/4" (1467)
57" (1448)
53 3/8" (1356)

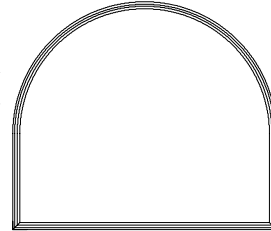

EC6657ELHRDS

66 5/16" (1684)
67 13/16" (1722)
64 3/4" (1645)
64" (1626)
60 3/8" (1534)

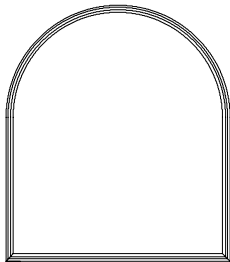

EC5664ELHRDS

68 5/16" (1735)
69 13/16" (1773)
66 3/4" (1695)
66" (1676)
62 3/8" (1584)

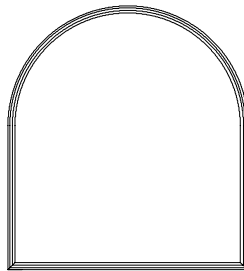

EC6066ELHRDS

71 5/16" (1811)
72 13/16" (1849)
69 3/4" (1772)
69" (1753)
65 3/8" (1661)

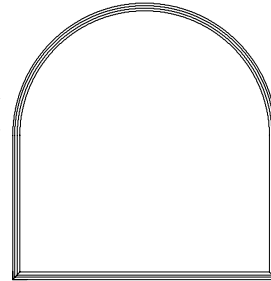

EC6669ELHRDS

78 5/16" (1989)
79 13/16" (2027)
76 3/4" (1949)
76" (1930)
72 3/8" (1838)

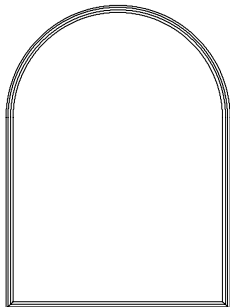

EC5676ELHRDS

80 5/16" (2040)
81 13/16" (2078)
78 3/4" (2000)
78" (1981)
74 3/8" (1889)

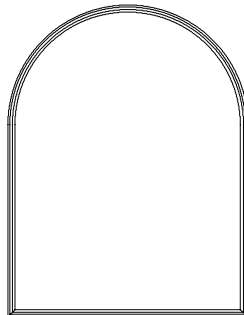

EC6078ELHRDS

83 5/16" (2116)
84 13/16" (2154)
81 3/4" (2076)
81" (2057)
77 3/8" (1965)

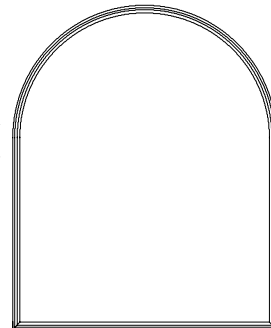

EC6681ELHRDS

SCALE 1/4" = 1'

CASEMENT EXTENDED LEG HALF ROUND UNITS

M.O. BRICKMOULD
M.O. ADAMS/FLAT CASING
ROUGH OPENING
FRAME SIZE
DAYLIGHT OPENING

59 1/2" (1511)
62 1/2" (1588)
56 3/4" (1441)
56" (1422)
52 3/8" (1330)

63 1/2" (1613)
66 1/2" (1689)
60 3/4" (1543)
60" (1524)
56 3/8" (1432)

69 1/2" (1765)
72 1/2" (1842)
66 3/4" (1695)
66" (1676)
62 3/8" (1584)

90 5/16" (2294)
91 13/16" (2332)
88 3/4" (2254)
88" (2235)
84 3/8" (2143)

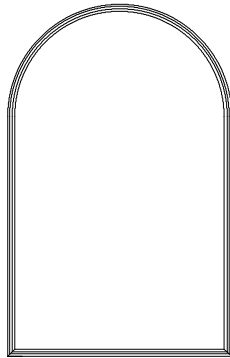

EC5688ELHRDS

92 5/16" (2345)
93 13/16" (2383)
90 3/4" (2305)
90" (2286)
86 3/8" (2194)

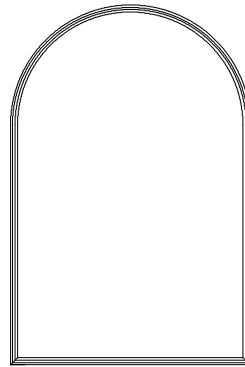

EC6090ELHRDS

95 5/16" (2421)
96 13/16" (2459)
93 3/4" (2381)
93" (2362)
89 3/8" (2270)

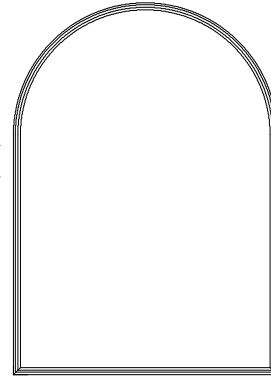

EC6693ELHRDS

102 5/16" (2599)
103 13/16" (2637)
100 3/4" (2559)
100" (2540)
96 3/8" (2448)

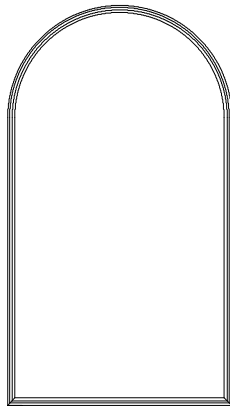

EC56100ELHRDS

104 5/16" (2650)
105 13/16" (2688)
102 3/4" (2610)
102" (2591)
98 3/8" (2499)

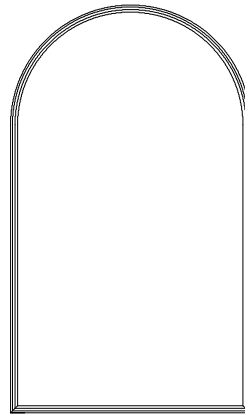

EC60102ELHRDS

107 5/16" (2726)
108 13/16" (2764)
105 3/4" (2686)
105" (2667)
101 3/8" (2575)

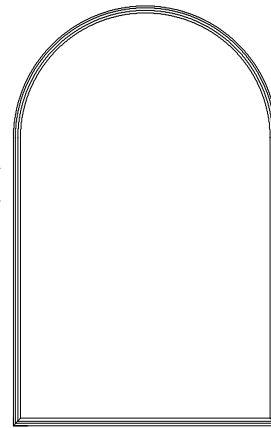

EC66105ELHRDS

ELEVATION SYMBOL LEGEND:

M.O. = MASONRY OPENING
VALUES IN () ARE IN MILLIMETER CONVERSIONS

Note: Elevations shown DO NOT have exterior trim. Subtract 1/2" (12.7) from M.O. (Masonry Opening) for Unit Sizes. Masonry Openings above include Sill Nose, see Trim Options page for Sill Nose specifications. For other Trim Options refer to the Unit Sizing, Rough Opening & Masonry Openings page.

SCALE 1/4" = 1'

CASEMENT EXTENDED LEG HALF ROUND UNITS

**M.O. BRICKMOULD
M.O. ADAMS/FLAT CASING
ROUGH OPENING
FRAME SIZE
DAYLIGHT OPENING**

75 1/2" (1918)
78 1/2" (1994)
72 3/4" (1848)
72" (1829)
68 3/8" (1737)

87 1/2" (2223)
90 1/2" (2299)
84 3/4" (2153)
84" (2134)
80 3/8" (2042)

44 5/16" (1126)
45 13/16" (1164)
42 3/4" (1086)
42" (1067)
38 3/8" (975)

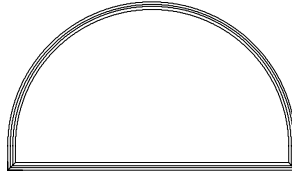

EC7242ELHRDS

50 5/16" (1278)
51 13/16" (1316)
48 3/4" (1238)
48" (1219)
44 3/8" (1127)

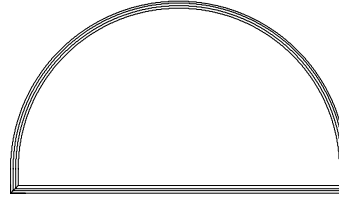

EC8448ELHRDS

50 5/16" (1278)
51 13/16" (1316)
48 3/4" (1238)
48" (1219)
44 3/8" (1127)

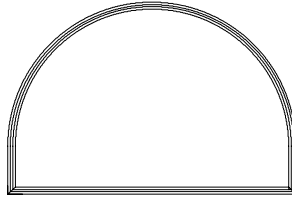

EC7248ELHRDS

56 5/16" (1430)
57 13/16" (1468)
54 3/4" (1391)
54" (1372)
50 3/8" (1280)

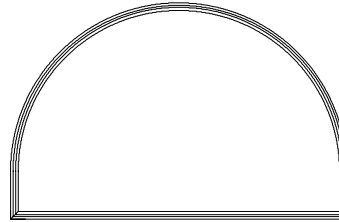

EC8454ELHRDS

56 5/16" (1430)
57 13/16" (1468)
54 3/4" (1391)
54" (1372)
50 3/8" (1280)

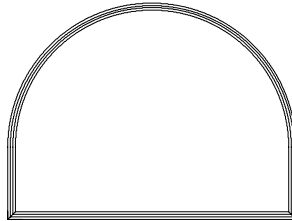

EC7254ELHRDS

62 5/16" (1583)
63 13/16" (1621)
60 3/4" (1543)
60" (1524)
56 3/8" (1432)

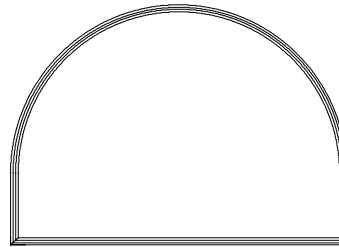

EC8460ELHRDS

62 5/16" (1583)
63 13/16" (1621)
60 3/4" (1543)
60" (1524)
56 3/8" (1432)

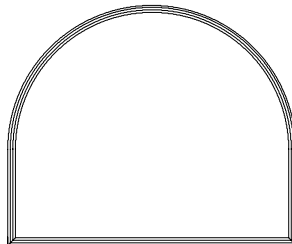

EC7260ELHRDS

86 5/16" (2192)
87 13/16" (2230)
84 3/4" (2153)
84" (2134)
80 3/8" (2042)

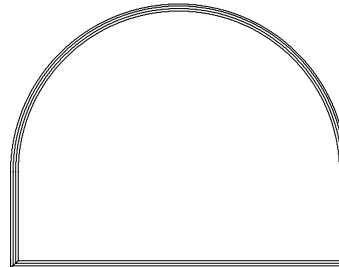

EC8466ELHRDS

74 5/16" (1888)
75 13/16" (1926)
72 3/4" (1848)
72" (1829)
68 3/8" (1737)

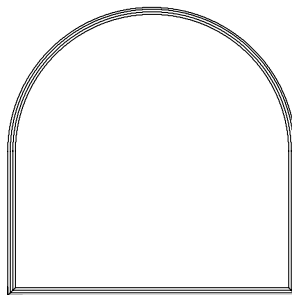

EC7272ELHRDS

80 5/16" (2040)
81 13/16" (2078)
78 3/4" (2000)
78" (1981)
74 3/8" (1889)

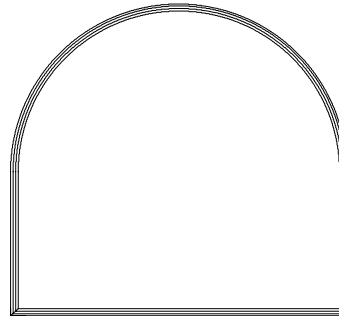

EC8478ELHRDS

ELEVATION SYMBOL LEGEND:
M.O. = MASONRY OPENING
VALUES IN () ARE IN MILLIMETER CONVERSIONS

Note: Elevations shown DO NOT have exterior trim. Subtract 1/2" (12.7) from M.O. (Masonry Opening) for Unit Sizes. Masonry Openings above include Sill Nose, see Trim Options page for Sill Nose specifications. For other Trim Options refer to the Unit Sizing, Rough Opening & Masonry Openings page.

SCALE 1/4" = 1'

CASEMENT EXTENDED LEG HALF ROUND UNITS

| | |
|-------------------------------|----------------|
| M.O. BRICKMOULD | 75 1/2" (1918) |
| M.O. ADAMS/FLAT CASING | 78 1/2" (1994) |
| ROUGH OPENING | 72 3/4" (1848) |
| FRAME SIZE | 72" (1829) |
| DAYLIGHT OPENING | 68 3/8" (1737) |

86 5/16" (2192)
87 13/16" (2230)
84 3/4" (2153)
84" (2134)
80 3/8" (2042)

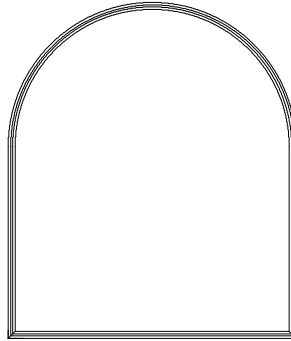

EC7284ELHRDS

98 5/16" (2497)
99 13/16" (2535)
96 3/4" (2457)
96" (2438)
92 3/8" (2346)

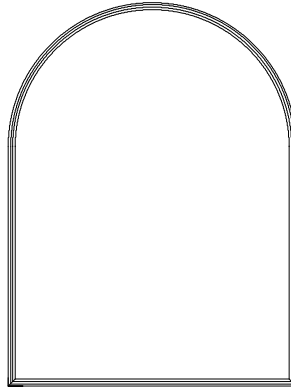

EC7296ELHRDS

ELEVATION SYMBOL LEGEND:
M.O. = MASONRY OPENING
VALUES IN () ARE IN MILLIMETER CONVERSIONS

Note: Elevations shown DO NOT have exterior trim. Subtract 1/2" (12.7) from M.O. (Masonry Opening) for Unit Sizes. Masonry Openings above include Sill Nose, see Trim Options page for Sill Nose specifications. For other Trim Options refer to the Unit Sizing, Rough Opening & Masonry Openings page.

SCALE 1/4" = 1'

CASEMENT EXTENDED LEG HALF ROUND UNITS

**M.O. BRICKMOULD
M.O. ADAMS/FLAT CASING
ROUGH OPENING
FRAME SIZE
DAYLIGHT OPENING**

93 1/2" (2380)
96 1/2" (2451)
90 3/4" (2305)
90" (2286)
86 3/8" (2194)

**M.O. BRICKMOULD
M.O. ADAMS/FLAT CASING
ROUGH OPENING
FRAME SIZE
DAYLIGHT OPENING**

111 1/2" (2832)
114 1/2" (2908)
108 3/4" (2762)
108" (2743)
104 3/8" (2651)

53 5/16" (1354)
54 13/16" (1392)
51 3/4" (1314)
51" (1295)
47 3/8" (1203)

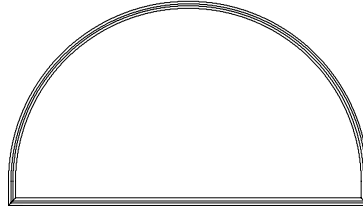

EC9051ELHRDS

62 5/16" (1583)
63 13/16" (1621)
60 3/4" (1543)
60" (1524)
56 3/8" (1432)

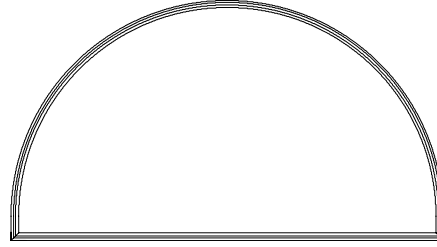

EC10860ELHRDS

59 5/16" (1507)
60 13/16" (1545)
57 3/4" (1467)
57" (1448)
53 3/8" (1356)

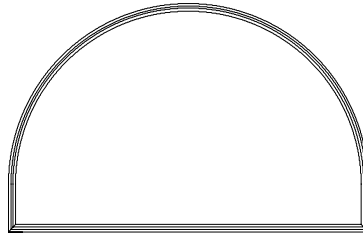

EC9057ELHRDS

68 5/16" (1735)
69 13/16" (1773)
66 3/4" (1695)
66" (1676)
62 3/8" (1584)

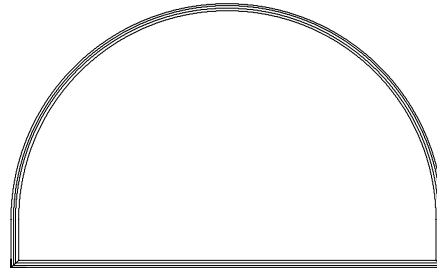

EC10866ELHRDS

65 5/16" (1659)
66 13/16" (1697)
63 3/4" (1619)
63" (1600)
59 3/8" (1508)

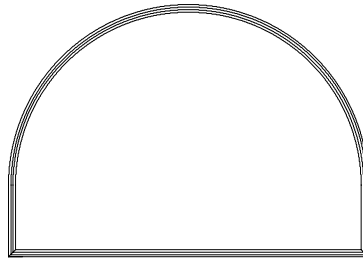

EC9063ELHRDS

71 5/16" (1811)
72 13/16" (1849)
69 3/4" (1772)
69" (1753)
65 3/8" (1661)

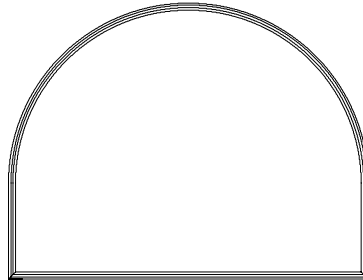

EC9069ELHRDS

83 5/16" (2116)
84 13/16" (2154)
81 3/4" (2076)
81" (2057)
77 3/8" (1965)

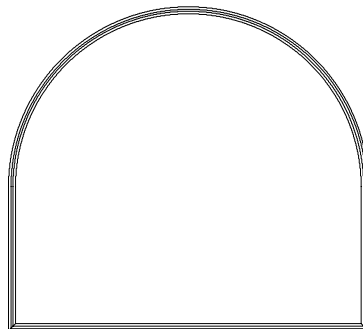

EC9081ELHRDS

ELEVATION SYMBOL LEGEND:
M.O. = MASONRY OPENING
VALUES IN () ARE IN MILLIMETER CONVERSIONS

Note: Elevations shown DO NOT have exterior trim. Subtract 1/2" (12.7) from M.O. (Masonry Opening) for Unit Sizes. Masonry Openings above include Sill Nose, see Trim Options page for Sill Nose specifications. For other Trim Options refer to the Unit Sizing, Rough Opening & Masonry Openings page.

SCALE 1/4" = 1'

CASEMENT EXTENDED LEG SEGMENT TOP UNITS

M.O. BRICKMOUND 27 1/2" (699)
M.O. ADAMS/FLAT CASING 30 1/2" (775)
ROUGH OPENING 24 3/4" (629)
FRAME SIZE 24" (610)
DAYLIGHT OPENING 20 3/8" (518)

31 1/2" (800)
34 1/2" (876)
28 3/4" (730)
28" (711)
24 3/8" (619)

33 1/2" (851)
36 1/2" (927)
30 3/4" (781)
30" (762)
26 3/8" (670)

39 1/2" (1003)
42 1/2" (1080)
36 3/4" (933)
36" (914)
32 3/8" (822)

51 1/2" (1308)
54 1/2" (1384)
48 3/4" (1238)
48" (1219)
44 3/8" (1127)

10 13/16" (275)
12 5/16" (313)
9 1/4" (236)
8 1/2" (216)
4 7/8" (124)



EC248ELSHDS

11 15/16" (300)
13 5/16" (338)
10 1/4" (266)
9 1/2" (241)
5 7/8" (149)



EC289ELSHDS

12 5/16" (313)
13 13/16" (351)
10 3/4" (273)
10" (254)
6 3/8" (162)



EC3010ELSHDS

14 5/16" (364)
15 13/16" (402)
12 3/4" (324)
12" (305)
8 3/8" (213)



EC3612ELSHDS

13 1/2" (343)
15" (381)
11 15/16" (303)
11 3/16" (284)
7 9/16" (192)



EC4811ELSHDS

16 13/16" (427)
18 5/16" (465)
15 1/4" (388)
14 1/2" (368)
10 7/8" (276)



EC2414ELSHDS

17 13/16" (452)
19 5/16" (491)
16 1/4" (413)
15 1/2" (394)
11 7/8" (302)



EC2815ELSHDS

18 5/16" (465)
19 13/16" (503)
16 3/4" (425)
16" (406)
12 3/8" (314)



EC3016ELSHDS

20 5/16" (516)
21 13/16" (554)
18 3/4" (476)
18" (457)
14 3/8" (365)



EC3618ELSHDS

19 1/2" (495)
21" (533)
17 15/16" (455)
17 3/16" (437)
13 9/16" (344)



EC4817ELSHDS

22 13/16" (579)
24 5/16" (618)
21 1/4" (541)
20 1/2" (521)
16 7/8" (429)



EC2420ELSHDS

23 13/16" (605)
25 5/16" (643)
22 1/4" (566)
21 1/2" (546)
17 7/8" (454)



EC2821ELSHDS

24 5/16" (618)
25 13/16" (656)
22 3/4" (578)
22" (559)
18 3/8" (467)



EC3022ELSHDS

26 5/16" (668)
27 13/16" (706)
24 3/4" (629)
24" (610)
20 3/8" (518)



EC3624ELSHDS

25 1/2" (648)
27" (686)
23 15/16" (608)
23 3/16" (589)
19 9/16" (497)



EC4823ELSHDS

28 13/16" (732)
31 5/16" (770)
27 1/4" (693)
26 1/2" (673)
22 7/8" (581)



EC2426ELSHDS

29 13/16" (757)
31 5/16" (795)
28 1/4" (718)
27 1/2" (699)
23 7/8" (606)



EC2827ELSHDS

30 5/16" (770)
31 13/16" (808)
28 3/4" (730)
28" (711)
24 3/8" (619)



EC3028ELSHDS

32 5/16" (821)
33 13/16" (859)
30 3/4" (781)
30" (762)
26 3/8" (670)



EC3630ELSHDS

31 1/2" (800)
33" (838)
29 15/16" (760)
29 3/16" (741)
25 9/16" (649)



EC4829ELSHDS

40 13/16" (1037)
43 5/16" (1075)
39 1/4" (997)
38 1/2" (978)
34 7/8" (886)



EC2438ELSHDS

41 13/16" (1062)
43 5/16" (1100)
40 1/4" (1022)
39 1/2" (1003)
35 7/8" (911)



EC2839ELSHDS

42 5/16" (1075)
43 13/16" (1113)
40 3/4" (1035)
40" (1016)
36 3/8" (924)



EC3040ELSHDS

44 5/16" (1126)
45 13/16" (1164)
42 3/4" (1086)
42" (1067)
38 3/8" (975)



EC3642ELSHDS

43 1/2" (1105)
45" (1143)
41 15/16" (1065)
41 3/16" (1046)
37 9/16" (954)



EC4841ELSHDS

52 13/16" (1341)
55 5/16" (1380)
51 1/4" (1302)
50 1/2" (1283)
46 7/8" (1191)



EC2450ELSHDS

53 13/16" (1367)
55 5/16" (1405)
52 1/4" (1327)
51 1/2" (1308)
47 7/8" (1216)



EC2851ELSHDS

54 5/16" (1380)
55 13/16" (1418)
52 3/4" (1340)
52" (1321)
48 3/8" (1229)



EC3052ELSHDS

56 5/16" (1430)
57 13/16" (1468)
54 3/4" (1391)
54" (1372)
50 3/8" (1280)



EC3654ELSHDS

55 1/2" (1410)
57" (1448)
53 15/16" (1370)
53 3/16" (1351)
49 9/16" (1259)



EC4853ELSHDS

64 13/16" (1646)
66 5/16" (1684)
63 1/4" (1607)
63 1/2" (1588)
58 7/8" (1495)



EC2462ELSHDS

65 13/16" (1672)
67 13/16" (1710)
64 1/4" (1632)
63 1/2" (1613)
59 7/8" (1581)



EC2863ELSHDS

66 5/16" (1684)
67 13/16" (1722)
64 3/4" (1645)
64" (1626)
60 3/8" (1534)



EC3064ELSHDS

68 5/16" (1735)
69 13/16" (1773)
66 3/4" (1695)
66" (1676)
62 3/8" (1584)



EC3666ELSHDS

67 1/2" (1715)
69" (1753)
65 15/16" (1675)
65 3/16" (1656)
61 9/16" (1564)



EC4865ELSHDS

ELEVATION SYMBOL LEGEND:
M.O. = MASONRY OPENING
VALUES IN () ARE IN MILLIMETER CONVERSIONS

Note: Elevations shown DO NOT have exterior trim. Subtract 1/2" (12.7) from M.O. (Masonry Opening) for Unit Sizes. Masonry Openings above include Sill Nose, see Trim Options page for Sill Nose specifications. For other Trim Options refer to the Unit Sizing, Rough Opening & Masonry Openings page.

SCALE 1/4" = 1'

CASEMENT EXTENDED LEG SEGMENT TOP UNITS

M.O. BRICKMOULD 27 1/2"(699)
M.O. ADAMS/FLAT CASING 30 1/2"(775)
ROUGH OPENING 24 3/4"(629)
FRAME SIZE 24"(610)
DAYLIGHT OPENING 20 3/8"(518)

31 1/2"(800)
34 1/2"(876)
28 3/4"(730)
28"(711)
24 3/8"(619)

33 1/2"(851)
36 1/2"(927)
30 3/4"(781)
30"(762)
26 3/8"(670)

39 1/2"(1003)
42 1/2"(1080)
36 3/4"(933)
36"(914)
32 3/8"(822)

51 1/2"(1308)
54 1/2"(1384)
48 3/4"(1238)
48"(1219)
44 3/8"(1127)

76 13/16"(1951)
78 5/16"(1989)
75 1/4"(1911)
74 1/2"(1892)
70 7/8"(1800)

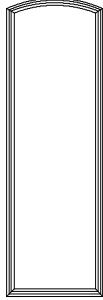

EC2474ELSHDS

77 13/16"(1976)
79 5/16"(2015)
76 1/4"(1937)
75 1/2"(1918)
71 7/8"(1826)

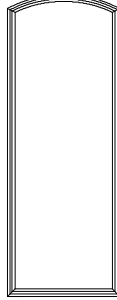

EC2875ELSHDS

78 5/16"(1989)
79 13/16"(2027)
76 3/4"(1949)
75 1/2"(1930)
72 3/8"(1838)

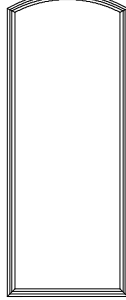

EC3076ELSHDS

80 5/16"(2040)
81 13/16"(2078)
78 3/4"(2000)
78"(1981)
74 3/8"(1889)

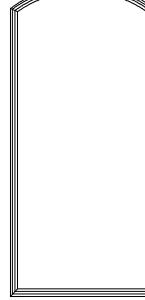

EC3678ELSHDS

79 1/2"(2019)
81"(2037)
77 5/16"(1979)
77 3/16"(1961)
73 9/16"(1868)

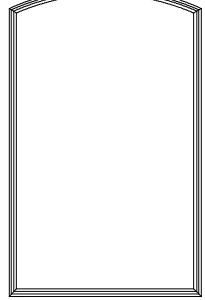

EC4877ELSHDS

ELEVATION SYMBOL LEGEND:

M.O. = MASONRY OPENING
VALUES IN () ARE IN MILLIMETER CONVERSIONS

Note: Elevations shown DO NOT have exterior trim. Subtract 1/2" (12.7) from M.O. (Masonry Opening) for Unit Sizes. Masonry Openings above include Sill Nose, see Trim Options page for Sill Nose specifications. For other Trim Options refer to the Unit Sizing, Rough Opening & Masonry Openings page.

CASEMENT EXTENDED LEG SEGMENT TOP UNITS

**M.O. BRICKMOULD
M.O. ADAMS/FLAT CASING
ROUGH OPENING
FRAME SIZE
DAYLIGHT OPENING**

59 1/2" (1511)
62 1/2" (1588)
56 3/4" (1441)
56" (1422)
52 3/8" (1330)

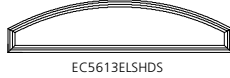

EC5613ELSHDS

15 1/2" (394)
17" (432)
13 15/16" (354)
13 3/16" (335)
9 9/16" (243)

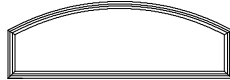

EC5619ELSHDS

21 1/2" (546)
23" (584)
19 15/16" (506)
19 3/16" (487)
15 9/16" (395)



EC5625ELSHDS

27 1/2" (699)
29" (737)
25 15/16" (659)
25 3/16" (640)
21 9/16" (548)



EC5631ELSHDS

33 1/2" (851)
35" (889)
31 15/16" (811)
31 3/16" (792)
27 9/16" (700)



EC5643ELSHDS

45 1/2" (1156)
47" (1194)
43 15/16" (1116)
43 3/16" (1097)
39 9/16" (1005)



EC5655ELSHDS

57 1/2" (1461)
59" (1499)
55 15/16" (1421)
55 3/16" (1402)
51 9/16" (1310)



EC5667ELSHDS

63 1/2" (1613)
66 1/2" (1689)
60 3/4" (1543)
60" (1524)
56 3/8" (1432)

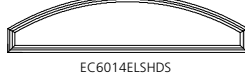

EC6014ELSHDS

16 11/16" (424)
18 3/16" (462)
15 1/8" (384)
14 3/8" (365)
10 3/4" (273)



EC6020ELSHDS

22 11/16" (576)
24 3/16" (614)
21 1/8" (537)
20 3/8" (518)
16 3/4" (425)



EC6026ELSHDS

28 11/16" (729)
30 3/16" (767)
27 1/8" (689)
26 3/8" (670)
22 3/4" (578)

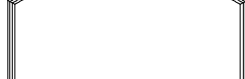

EC6032ELSHDS

34 11/16" (881)
36 3/16" (919)
33 1/8" (841)
32 3/8" (822)
28 3/4" (730)



EC6044ELSHDS

46 11/16" (1186)
48 3/16" (1224)
45 1/8" (1146)
44 3/8" (1127)
40 3/4" (1035)



EC6056ELSHDS

58 11/16" (1491)
60 3/16" (1529)
57 1/8" (1451)
56 3/8" (1432)
52 3/4" (1340)



EC6068ELSHDS

69 1/2" (1765)
72 1/2" (1842)
66 3/4" (1695)
66" (1676)
62 3/8" (1584)



EC6616ELSHDS

18 15/16" (481)
21 7/16" (513)
17 3/8" (443)
16 5/8" (422)
13" (330)



EC6622ELSHDS

24 15/16" (633)
26 7/16" (672)
23 3/8" (592)
22 5/8" (575)
19" (483)



EC6628ELSHDS

30 15/16" (786)
32 7/16" (824)
29 3/8" (744)
28 5/8" (727)
25" (635)



EC6634ELSHDS

36 15/16" (938)
38 7/16" (976)
35 3/8" (896)
34 5/8" (879)
31" (787)



EC6646ELSHDS

48 15/16" (1243)
50 7/16" (1281)
47 3/8" (1201)
46 5/8" (1184)
43" (1092)



EC6658ELSHDS

60 15/16" (1548)
62 7/16" (1586)
59 3/8" (1506)
58 5/8" (1489)
55" (1397)



EC6670ELSHDS

ELEVATION SYMBOL LEGEND:
M.O. = MASONRY OPENING
VALUES IN () ARE IN MILLIMETER CONVERSIONS

Note: Elevations shown DO NOT have exterior trim. Subtract 1/2" (12.7) from M.O. (Masonry Opening) for Unit Sizes. Masonry Openings above include Sill Nose, see Trim Options page for Sill Nose specifications. For other Trim Options refer to the Unit Sizing, Rough Opening & Masonry Openings page.

SCALE 1/4" = 1'

CASEMENT EXTENDED LEG SEGMENT TOP UNITS

M.O. BRICKMOULD
M.O. ADAMS/FLAT CASING
ROUGH OPENING
FRAME SIZE
DAYLIGHT OPENING

59 1/2" (1511)
62 1/2" (1588)
56 3/4" (1441)
56" (1422)
52 3/8" (1330)

63 1/2" (1613)
66 1/2" (1689)
60 3/4" (1543)
60" (1524)
56 3/8" (1432)

69 1/2" (1765)
72 1/2" (1842)
66 3/4" (1695)
66" (1676)
62 3/8" (1584)

81 1/2" (2070)
83" (2108)
79 15/16" (2030)
79 3/16" (2011)
75 9/16" (1919)

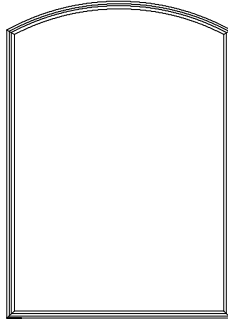

EC5679ELSHDS

82 11/16" (2100)
84 3/16" (2138)
81 1/8" (2061)
80 3/8" (2042)
76 3/4" (1949)

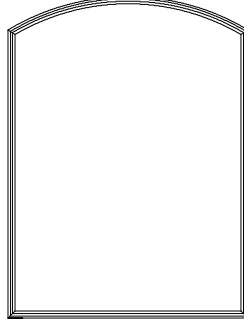

EC6080ELSHDS

84 15/16" (2157)
86 7/16" (2196)
83 3/8" (2118)
82 5/8" (2099)
79" (2007)

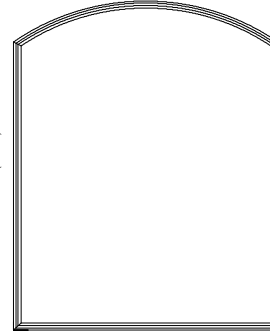

EC6682ELSHDS

ELEVATION SYMBOL LEGEND:

M.O. = MASONRY OPENING
VALUES IN () ARE IN MILLIMETER CONVERSIONS

Note: Elevations shown DO NOT have exterior trim. Subtract 1/2" (12.7) from M.O. (Masonry Opening) for Unit Sizes. Masonry Openings above include Sill Nose, see Trim Options page for Sill Nose specifications. For other Trim Options refer to the Unit Sizing, Rough Opening & Masonry Openings page.

CASEMENT EXTENDED LEG SEGMENT TOP UNITS

M.O. BRICKMOULD
M.O. ADAMS/FLAT CASING
ROUGH OPENING
FRAME SIZE
DAYLIGHT OPENING

75 1/2" (1918)
78 1/2" (1994)
72 3/4" (1848)
72" (1829)
68 3/8" (1737)

87 1/2" (2223)
90 1/2" (2299)
84 3/4" (2153)
84" (2134)
80 3/8" (2042)

16 7/16" (418)
17 15/16" (455)
14 7/8" (378)
14 1/8" (359)
10 1/2" (267)

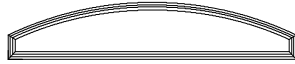

EC7214ELSHDS

19 9/16" (497)
21 1/16" (535)
18" (457)
17 1/4" (438)
13 5/8" (346)

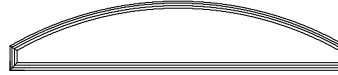

EC8417ELSHDS

22 7/16" (570)
23 15/16" (608)
20 7/8" (530)
20 1/8" (511)
16 1/2" (419)



EC7220ELSHDS

25 9/16" (649)
27 1/16" (687)
24" (610)
23 1/4" (591)
19 5/8" (498)

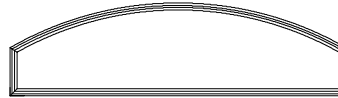

EC8423ELSHDS

28 7/16" (722)
29 15/16" (760)
26 7/8" (683)
26 1/8" (664)
22 1/2" (572)



EC7226ELSHDS

31 9/16" (802)
33 1/16" (840)
30" (762)
29 1/4" (743)
25 5/8" (651)

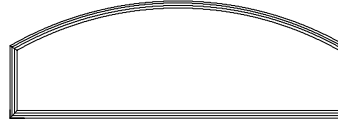

EC8429ELSHDS

34 7/16" (875)
35 15/16" (913)
32 7/8" (835)
32 1/8" (816)
28 1/2" (724)

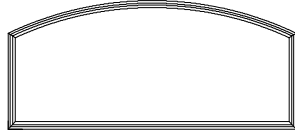

EC7232ELSHDS

37 9/16" (954)
39 1/16" (992)
36" (914)
35 1/4" (895)
31 5/8" (803)

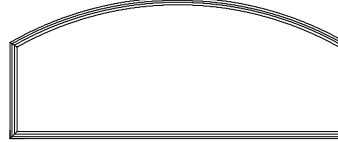

EC8435ELSHDS

46 7/16" (1180)
47 15/16" (1217)
44 7/8" (1140)
44 1/8" (1121)
40 1/2" (1029)

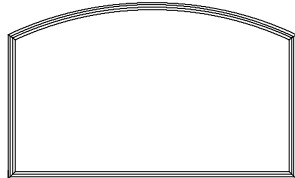

EC7244ELSHDS

49 9/16" (1259)
51 1/16" (1297)
48" (1219)
47 1/4" (1200)
43 5/8" (1108)

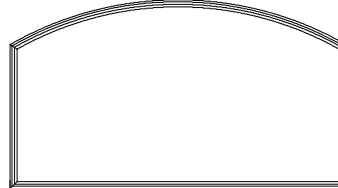

EC8447ELSHDS

58 7/16" (1484)
59 15/16" (1522)
56 7/8" (1445)
56 1/8" (1426)
52 1/2" (1334)

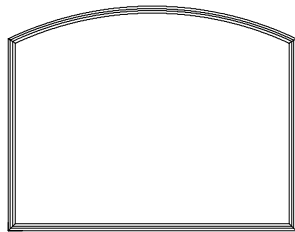

EC7256ELSHDS

61 9/16" (1564)
63 1/16" (1602)
60" (1524)
59 1/4" (1505)
55 5/8" (1413)

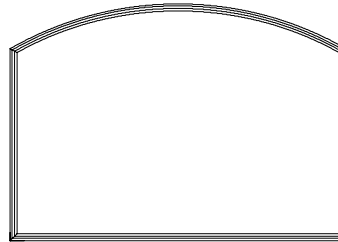

EC8459ELSHDS

70 7/16" (1789)
71 15/16" (1827)
68 7/8" (1749)
68 1/8" (1730)
64 1/2" (1638)

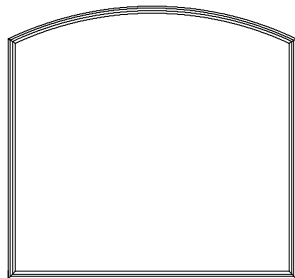

EC7268ELSHDS

73 9/16" (1868)
75 1/16" (1907)
72" (1829)
71 1/4" (1810)
67 5/8" (1718)

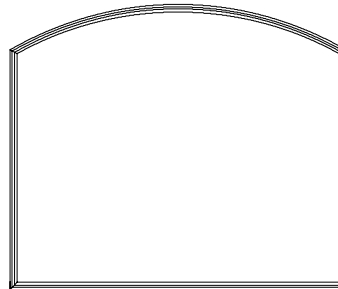

EC8471ELSHDS

ELEVATION SYMBOL LEGEND:
M.O. = MASONRY OPENING
VALUES IN () ARE IN MILLIMETER CONVERSIONS

Note: Elevations shown DO NOT have exterior trim. Subtract 1/2" (12.7) from M.O. (Masonry Opening) for Unit Sizes. Masonry Openings above include Sill Nose, see Trim Options page for Sill Nose specifications. For other Trim Options refer to the Unit Sizing, Rough Opening & Masonry Openings page.

SCALE 1/4" = 1'

CASEMENT EXTENDED LEG SEGMENT TOP UNITS

M.O. BRICKMOULD
M.O. ADAMS/FLAT CASING
ROUGH OPENING
FRAME SIZE
DAYLIGHT OPENING

75 1/2" (1918)
78 1/2" (1994)
72 3/4" (1848)
72" (1829)
68 3/8" (1737)

87 1/2" (2223)
90 1/2" (2299)
84 3/4" (2153)
84" (2134)
80 3/8" (2042)

82 7/16" (2094)
83 15/16" (2132)
80 7/8" (2054)
80 1/8" (2035)
76 1/2" (1943)

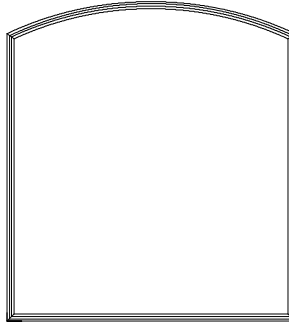

EC7280ELSHDS

85 9/16" (2173)
87 1/16" (2211)
84" (2134)
83 1/4" (2115)
79 5/8" (2022)

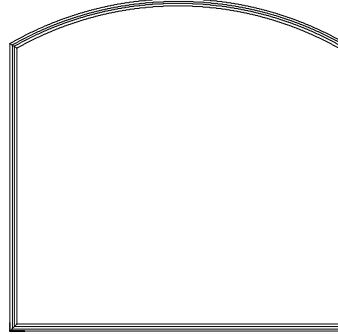

EC8483ELSHDS

ELEVATION SYMBOL LEGEND:

M.O. = MASONRY OPENING
VALUES IN () ARE IN MILLIMETER CONVERSIONS

Note: Elevations shown DO NOT have exterior trim. Subtract 1/2" (12.7) from M.O. (Masonry Opening) for Unit Sizes. Masonry Openings above include Sill Nose, see Trim Options page for Sill Nose specifications. For other Trim Options refer to the Unit Sizing, Rough Opening & Masonry Openings page.

CASEMENT EXTENDED LEG SEGMENT TOP UNITS

M.O. BRICKMOULD
M.O. ADAMS/FLAT CASING
ROUGH OPENING
FRAME SIZE
DAYLIGHT OPENING

93 1/2" (2380)
96 1/2" (2451)
90 3/4" (2305)
90" (2286)
86 3/8" (2194)

111 1/2" (2832)
114 1/2" (2908)
108 3/4" (2762)
108" (2743)
104 3/8" (2651)

21 3/8" (543)
22 7/8" (581)
19 13/16" (503)
19 1/16" (484)
15 7/16" (392)

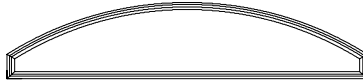

EC9019ELSHDS

28" (711)
29 1/2" (749)
26 7/16" (672)
25 1/16" (652)
22 1/16" (560)

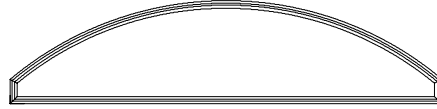

EC10825ELSHDS

27 3/8" (695)
28 7/8" (733)
25 13/16" (656)
25 1/16" (637)
21 7/16" (545)

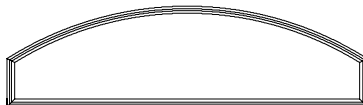

EC9025ELSHDS

34" (864)
35 1/2" (902)
32 7/16" (824)
31 1/16" (805)
28 1/16" (713)



EC10831ELSHDS

33 3/8" (848)
34 7/8" (886)
31 13/16" (808)
31 1/16" (789)
27 7/16" (697)

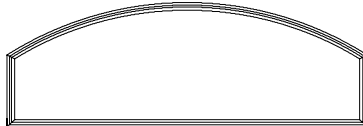

EC9031ELSHDS

40" (1016)
41 1/2" (1054)
38 7/16" (976)
37 1/16" (957)
34 1/16" (865)

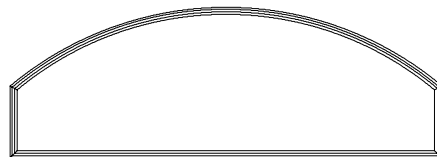

EC10837ELSHDS

39 3/8" (1000)
40 7/8" (1038)
37 13/16" (960)
37 1/16" (941)
33 7/16" (849)

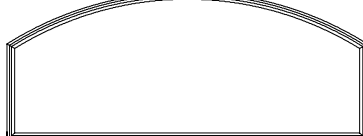

EC9037ELSHDS

46" (1168)
47 1/2" (1207)
44 7/16" (1129)
43 1/16" (1110)
40 1/16" (1018)

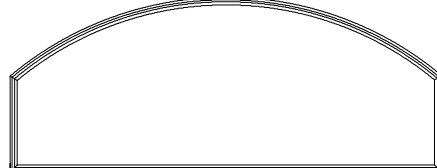

EC10843ELSHDS

51 3/8" (1305)
52 7/8" (1343)
49 13/16" (1265)
49 1/16" (1246)
45 7/16" (1154)

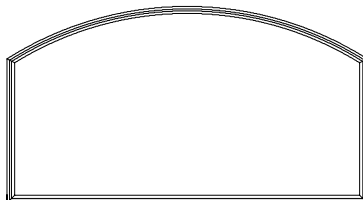

EC9049ELSHDS

58" (1473)
59 1/2" (1511)
56 7/16" (1434)
55 1/16" (1414)
52 1/16" (1322)

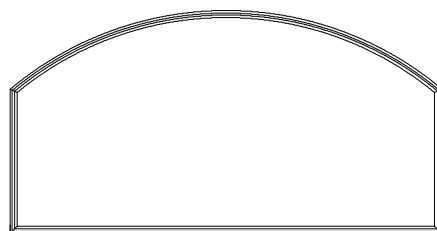

EC10855ELSHDS

63 3/8" (1609)
64 7/8" (1648)
61 13/16" (1570)
61 1/16" (1551)
57 7/16" (1459)

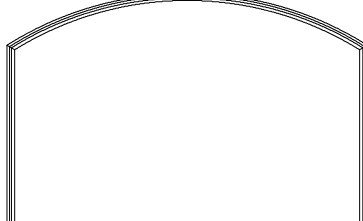

EC9061ELSHDS

75 3/8" (1915)
76 7/8" (1953)
73 13/16" (1875)
73 1/16" (1856)
69 7/16" (1764)

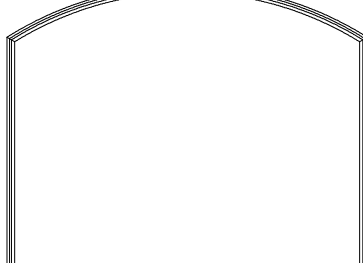

EC9073ELSHDS

ELEVATION SYMBOL LEGEND:

M.O. = MASONRY OPENING
VALUES IN () ARE IN MILLIMETER CONVERSIONS

Note: Elevations shown DO NOT have exterior trim. Subtract 1/2" (12.7) from M.O. (Masonry Opening) for Unit Sizes. Masonry Openings above include Sill Nose, see Trim Options page for Sill Nose specifications. For other Trim Options refer to the Unit Sizing, Rough Opening & Masonry Openings page.

SCALE 1/4" = 1'

DOUBLE-HUNG AND DOORS QUARTER ROUND UNITS

| | |
|-------------------------------|-----------------|
| M.O. BRICKMOULD | 32 7/8" (835) |
| M.O. ADAMS/FLAT CASING | 35 7/8" (911) |
| ROUGH OPENING | 30 1/8" (765) |
| FRAME SIZE | 29 3/8" (746) |
| DAYLIGHT OPENING | 25 13/16" (656) |

32" (813)
33 1/2" (851)
35 7/8" (911)
39 3/8" (998)
25 13/16" (656)

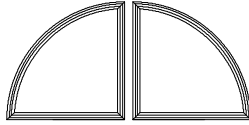

ECD29QRDS

36" (914)
37 1/2" (953)
34 1/8" (867)
33 3/8" (848)
29 13/16" (757)

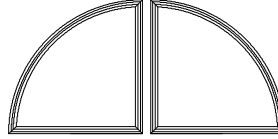

ECD33QRDS

40" (1016)
41 1/2" (1054)
38 1/8" (968)
37 3/8" (949)
33 13/16" (859)

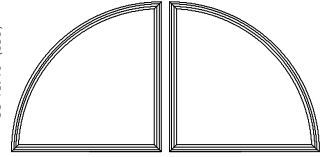

ECD37QRDS

| |
|-----------------|
| 40 7/8" (1038) |
| 43 7/8" (1114) |
| 38 1/8" (968) |
| 37 3/8" (949) |
| 33 13/16" (859) |

ELEVATION SYMBOL LEGEND:
M.O. = MASONRY OPENING
VALUES IN () ARE IN MILLIMETER CONVERSIONS

Note: Elevations shown DO NOT have exterior trim. Subtract 1/2" (12.7) from M.O. (Masonry Opening) for Unit Sizes. Masonry Openings above include Sill Nose, see Trim Options page for Sill Nose specifications. For other Trim Options refer to the Unit Sizing, Rough Opening & Masonry Openings page.

DOUBLE-HUNG HALF ROUND UNITS

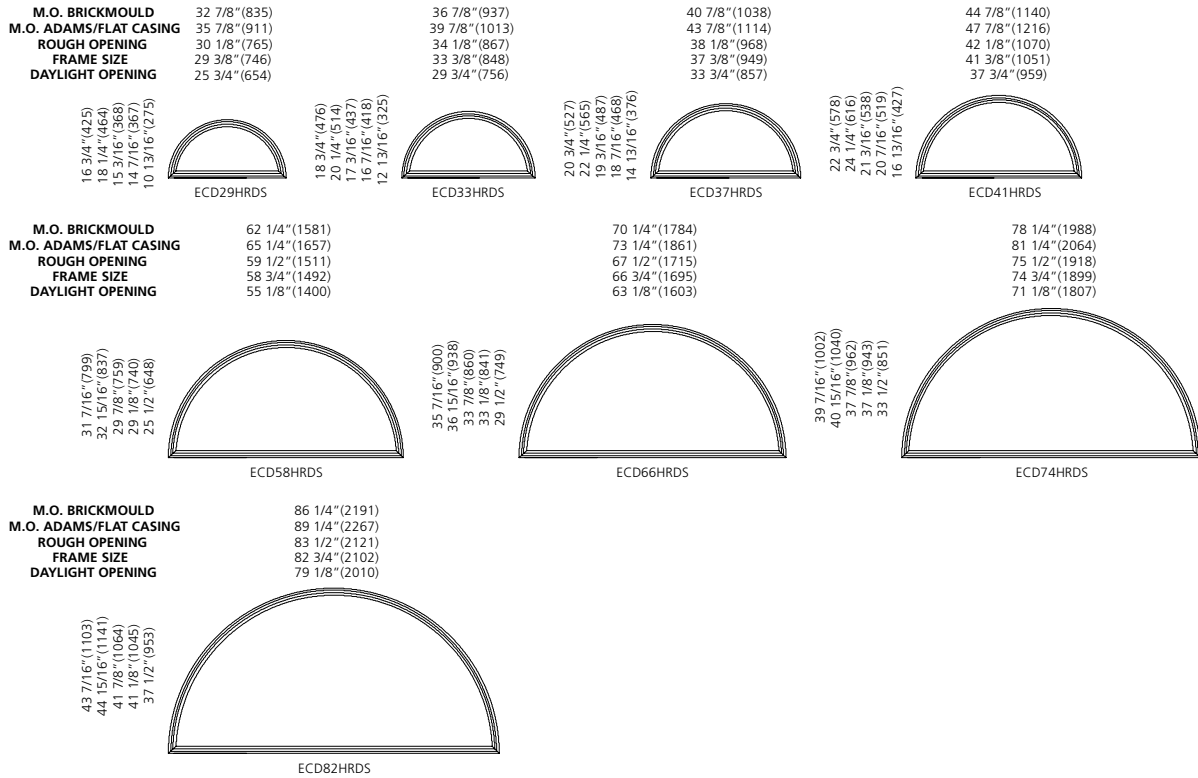





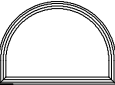

ELEVATION SYMBOL LEGEND:

M.O. = MASONRY OPENING
VALUES IN () ARE IN MILLIMETER CONVERSIONS

Note: Elevations shown DO NOT have exterior trim. Subtract 1/2" (12.7) from M.O. (Masonry Opening) for Unit Sizes. Masonry Openings above include Sill Nose, see Trim Options page for Sill Nose specifications. For other Trim Options refer to the Unit Sizing, Rough Opening & Masonry Openings page.

DOUBLE-HUNG EXTENDED LEG HALF ROUND UNITS

| M.O. BRICKMOULD | 32 7/8" (835) | 36 7/8" (937) | 40 7/8" (1038) | 44 7/8" (1140) |
|--|--|--|--|--|
| M.O. ADAMS/FLAT CASING | 35 7/8" (911) | 39 7/8" (1013) | 43 7/8" (1114) | 47 7/8" (1216) |
| ROUGH OPENING | 30 1/8" (765) | 34 1/8" (867) | 38 1/8" (968) | 42 1/8" (1070) |
| FRAME SIZE | 29 3/8" (746) | 33 3/8" (848) | 37 3/8" (949) | 41 3/8" (1051) |
| DAYLIGHT OPENING | 25 3/4" (654) | 29 3/4" (756) | 33 3/4" (857) | 37 3/4" (959) |
| 23" (584) 24 1/2" (622) 21 7/16" (545) 20 11/16" (525) 17 1/16" (433) |  ECD2920ELHRDS | 25" (635) 26 1/2" (673) 23 7/16" (595) 22 11/16" (576) 19 1/16" (484) | 27" (686) 28 1/2" (724) 25 7/16" (646) 24 11/16" (627) 21 1/16" (535) | 29" (737) 30 1/2" (775) 27 7/16" (697) 26 11/16" (678) 23 1/16" (586) |
| 29" (737) 30 1/2" (775) 27 7/16" (697) 26 11/16" (678) 23 1/16" (586) |  ECD2926ELHRDS | 31" (787) 32 1/2" (826) 29 7/16" (748) 28 11/16" (729) 25 1/16" (637) | 33" (838) 34 1/2" (876) 31 7/16" (799) 30 11/16" (779) 27 1/16" (687) | 35" (889) 36 1/2" (927) 33 7/16" (849) 32 11/16" (830) 29 1/16" (738) |
| 35" (889) 36 1/2" (927) 33 7/16" (849) 32 11/16" (830) 29 1/16" (738) |  ECD2932ELHRDS | 37" (940) 38 1/2" (978) 35 7/16" (900) 34 11/16" (881) 31 1/16" (789) | 39" (991) 40 1/2" (1029) 37 7/16" (951) 36 11/16" (932) 33 1/16" (840) | 41" (1041) 42 1/2" (1080) 39 7/16" (1002) 38 11/16" (983) 35 1/16" (891) |
| 41" (1041) 42 1/2" (1080) 39 7/16" (1002) 38 11/16" (983) 35 1/16" (891) |  ECD2938ELHRDS | 43" (1092) 44 1/2" (1130) 41 7/16" (1053) 40 11/16" (1033) 37 1/16" (941) | 45" (1143) 46 1/2" (1181) 43 7/16" (1103) 42 11/16" (1084) 39 1/16" (992) | 47" (1194) 48 1/2" (1232) 45 7/16" (1154) 44 11/16" (1135) 41 1/16" (1043) |
| 53" (1346) 54 1/2" (1384) 51 7/16" (1306) 50 11/16" (1287) 47 1/16" (1195) |  ECD2950ELHRDS | 55" (1397) 56 1/2" (1435) 53 7/16" (1357) 52 11/16" (1338) 49 1/16" (1246) | 57" (1449) 58 1/2" (1486) 55 7/16" (1408) 54 11/16" (1389) 51 1/16" (1297) | 59" (1499) 60 1/2" (1537) 57 7/16" (1459) 56 11/16" (1440) 53 1/16" (1348) |
| 65" (1651) 66 1/2" (1689) 63 7/16" (1611) 62 11/16" (1592) 59 1/16" (1500) |  ECD2962ELHRDS | 67" (1702) 68 1/2" (1740) 65 7/16" (1662) 64 11/16" (1643) 61 1/16" (1551) | 69" (1753) 70 1/2" (1791) 67 7/16" (1713) 66 11/16" (1694) 63 1/16" (1602) | 71" (1803) 72 1/2" (1842) 69 7/16" (1764) 68 11/16" (1745) 65 1/16" (1653) |
| 65" (1651) 66 1/2" (1689) 63 7/16" (1611) 62 11/16" (1592) 59 1/16" (1500) |  ECD3364ELHRDS | 67" (1702) 68 1/2" (1740) 65 7/16" (1662) 64 11/16" (1643) 61 1/16" (1551) | 69" (1753) 70 1/2" (1791) 67 7/16" (1713) 66 11/16" (1694) 63 1/16" (1602) | 71" (1803) 72 1/2" (1842) 69 7/16" (1764) 68 11/16" (1745) 65 1/16" (1653) |

ELEVATION SYMBOL LEGEND:
M.O. = MASONRY OPENING
VALUES IN () ARE IN MILLIMETER CONVERSIONS

Note: Elevations shown DO NOT have exterior trim. Subtract 1/2" (12.7) from M.O. (Masonry Opening) for Unit Sizes. Masonry Openings above include Sill Nose, see Trim Options page for Sill Nose specifications. For other Trim Options refer to the Unit Sizing, Rough Opening & Masonry Openings page.

SCALE 1/4" = 1'

DOUBLE-HUNG EXTENDED LEG HALF ROUND UNITS

M.O. BRICKMOULD 32 7/8" (835)
M.O. ADAMS/FLAT CASING 35 7/8" (911)
ROUGH OPENING 30 1/8" (765)
FRAME SIZE 29 3/8" (746)
DAYLIGHT OPENING 25 3/4" (654)

36 7/8" (937)
39 7/8" (1013)
34 1/8" (867)
33 3/8" (848)
29 3/4" (756)

40 7/8" (1038)
43 7/8" (1114)
38 1/8" (968)
37 3/8" (949)
33 3/4" (857)

44 7/8" (1140)
47 7/8" (1216)
42 1/8" (1070)
41 3/8" (1051)
37 3/4" (959)

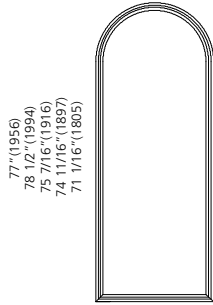

ECD2974ELHRDS

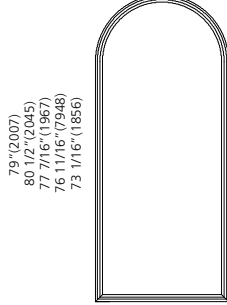

ECD3376ELHRDS

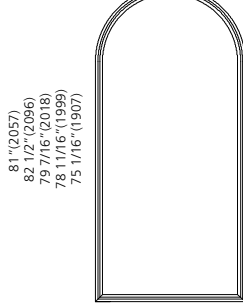

ECD3778ELHRDS

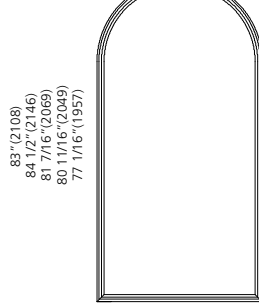

ECD4180ELHRDS

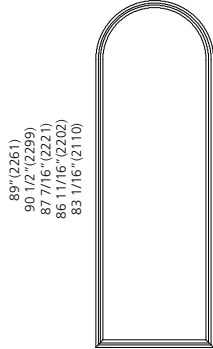

ECD2986ELHRDS



ECD3388ELHRDS

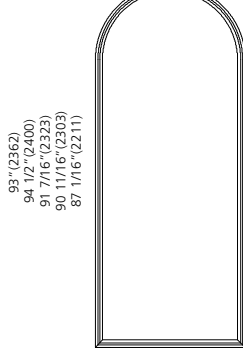

ECD3790ELHRDS

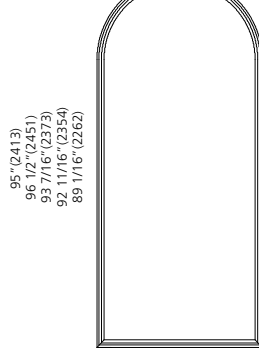

ECD4192ELHRDS

ELEVATION SYMBOL LEGEND:
M.O. = MASONRY OPENING
VALUES IN () ARE IN MILLIMETER CONVERSIONS

Note: Elevations shown DO NOT have exterior trim. Subtract 1/2" (12.7) from M.O. (Masonry Opening) for Unit Sizes. Masonry Openings above include Sill Nose, see Trim Options page for Sill Nose specifications. For other Trim Options refer to the Unit Sizing, Rough Opening & Masonry Openings page.

SCALE 1/4" = 1'

DOUBLE-HUNG EXTENDED LEG HALF ROUND UNITS

M.O. BRICKMOUND
M.O. ADAMS/FLAT CASING
ROUGH OPENING
FRAME SIZE
DAYLIGHT OPENING

62 1/4"(1581)
65 1/4"(1657)
59 1/2"(1511)
58 3/4"(1492)
55 1/8"(1400)

70 1/4"(1784)
73 1/4"(1861)
67 1/2"(1715)
66 3/4"(1695)
63 1/8"(1603)

78 1/4"(1988)
81 1/4"(2064)
75 1/2"(1918)
74 3/4"(1899)
71 1/8"(1807)

37 11/16"(957)
38 3/16"(970)
36 1/8"(918)
35 3/8"(899)
31 3/4"(806)

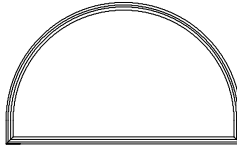

ECD5835ELHRDS

41 11/16"(1059)
42 3/16"(1072)
40 1/8"(1019)
39 3/8"(1000)
35 3/4"(908)

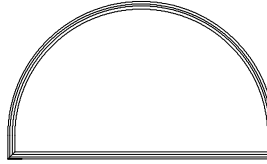

ECD6639ELHRDS

45 11/16"(1160)
46 3/16"(1173)
44 1/8"(1121)
43 3/8"(1102)
39 3/4"(1010)

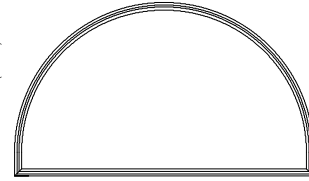

ECD7443ELHRDS

43 11/16"(1110)
44 3/16"(1122)
42 1/8"(1070)
41 3/8"(1051)
37 3/4"(959)

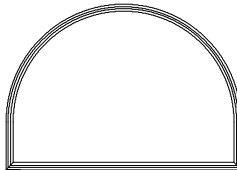

ECD5841ELHRDS

47 11/16"(1211)
48 3/16"(1224)
46 1/8"(1172)
45 3/8"(1153)
41 3/4"(1060)

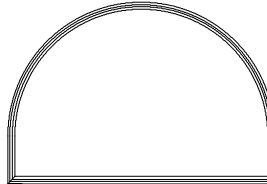

ECD6645ELHRDS

51 11/16"(1312)
52 3/16"(1326)
50 1/8"(1273)
49 3/8"(1254)
45 3/4"(1162)

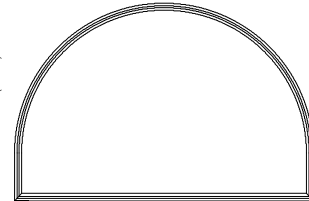

ECD7449ELHRDS

49 11/16"(1262)
50 3/16"(1275)
48 1/8"(1222)
47 3/8"(1203)
43 3/4"(1111)

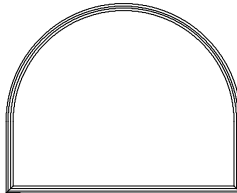

ECD5847ELHRDS

53 11/16"(1364)
54 3/16"(1376)
52 1/8"(1324)
51 3/8"(1305)
47 3/4"(1213)

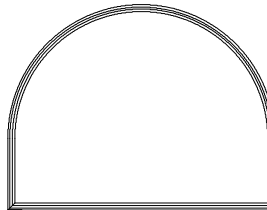

ECD6651ELHRDS

57 11/16"(1465)
58 3/16"(1478)
56 1/8"(1426)
55 3/8"(1407)
51 3/4"(1314)

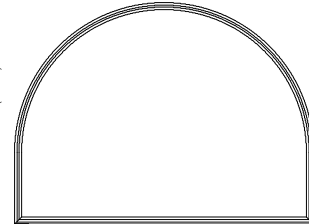

ECD7455ELHRDS

55 11/16"(1414)
56 3/16"(1427)
54 1/8"(1375)
53 3/8"(1356)
49 3/4"(1264)

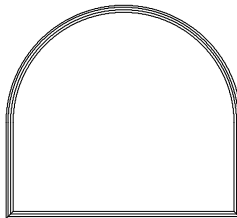

ECD5853ELHRDS

59 11/16"(1516)
60 3/16"(1529)
58 1/8"(1476)
57 3/8"(1457)
53 3/4"(1365)

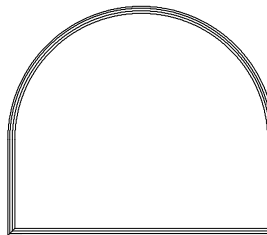

ECD6657ELHRDS

63 11/16"(1618)
64 3/16"(1630)
62 1/8"(1578)
61 3/8"(1559)
57 3/4"(1467)

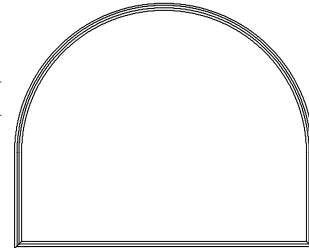

ECD7461ELHRDS

67 11/16"(1719)
68 3/16"(1732)
66 1/8"(1680)
65 3/8"(1661)
61 3/4"(1568)

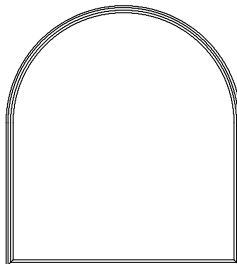

ECD5865ELHRDS

71 11/16"(1821)
72 3/16"(1834)
70 1/8"(1781)
69 3/8"(1762)
65 3/4"(1670)

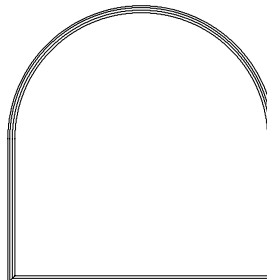

ECD6669ELHRDS

75 11/16"(1922)
76 3/16"(1935)
74 1/8"(1883)
73 3/8"(1864)
69 3/4"(1772)

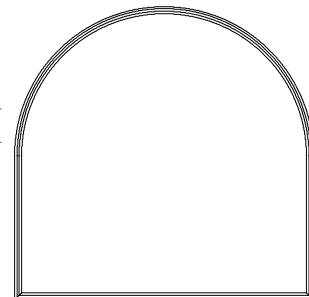

ECD7473ELHRDS

ELEVATION SYMBOL LEGEND:

M.O. = MASONRY OPENING
VALUES IN () ARE IN MILLIMETER CONVERSIONS

Note: Elevations shown DO NOT have exterior trim. Subtract 1/2" (12.7) from M.O. (Masonry Opening) for Unit Sizes. Masonry Openings above include Sill Nose, see Trim Options page for Sill Nose specifications. For other Trim Options refer to the Unit Sizing, Rough Opening & Masonry Openings page.

SCALE 1/4" = 1'

DOUBLE-HUNG EXTENDED LEG HALF ROUND UNITS

M.O. BRICKMOUND
M.O. ADAMS/FLAT CASING
ROUGH OPENING
FRAME SIZE
DAYLIGHT OPENING

62 1/4"(1581)
65 1/4"(1657)
59 1/2"(1511)
58 3/4"(1492)
55 1/8"(1400)

70 1/4"(1784)
73 1/4"(1861)
67 1/2"(1715)
66 3/4"(1695)
63 1/8"(1603)

78 1/4"(1988)
81 1/4"(2064)
75 1/2"(1918)
74 3/4"(1899)
71 1/8"(1807)

79 11/16"(2024)
80 3/16"(2037)
78 1/8"(1984)
77 3/8"(1965)
73 3/4"(1873)

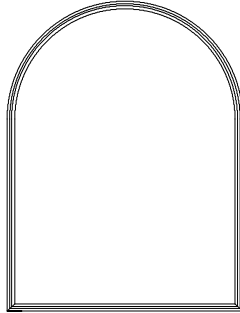

ECD5877ELHRDS

83 11/16"(2126)
84 3/16"(2138)
82 1/8"(1902)
81 3/8"(2067)
77 3/4"(1975)

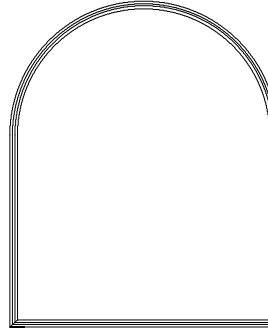

ECD6681ELHRDS

87 1/16"(2227)
88 3/16"(2240)
86 1/8"(2188)
85 3/8"(2169)
81 3/4"(2076)

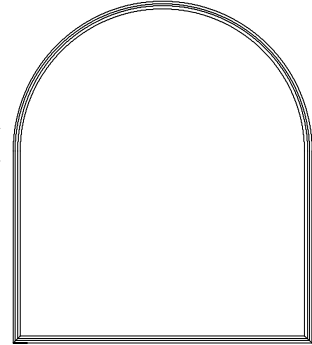

ECD7485ELHRDS

91 11/16"(2329)
92 3/16"(2342)
90 1/8"(2289)
89 3/8"(2270)
85 3/4"(2178)

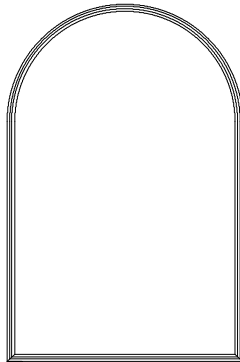

ECD5889ELHRDS

95 11/16"(2430)
96 3/16"(2443)
94 1/8"(2391)
93 3/8"(2372)
89 3/4"(2280)

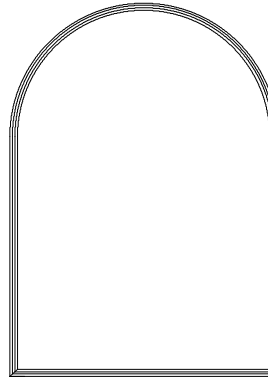

ECD6693ELHRDS

103 11/16"(2634)
104 3/16"(2646)
102 1/8"(2594)
101 3/8"(2575)
97 3/4"(2483)

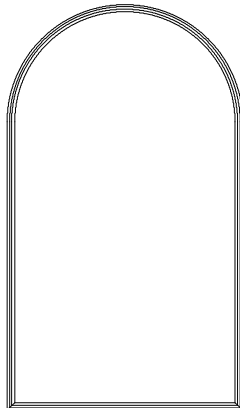

ECD58101ELHRDS

107 11/16"(2735)
108 3/16"(2748)
106 1/8"(2696)
105 3/8"(2677)
101 3/4"(2584)

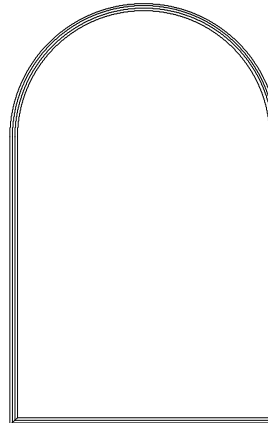

ECD66105ELHRDS

ELEVATION SYMBOL LEGEND:

M.O. = MASONRY OPENING
VALUES IN () ARE IN MILLIMETER CONVERSIONS

Note: Elevations shown DO NOT have exterior trim. Subtract 1/2" (12.7) from M.O. (Masonry Opening) for Unit Sizes. Masonry Openings above include Sill Nose, see Trim Options page for Sill Nose specifications. For other Trim Options refer to the Unit Sizing, Rough Opening & Masonry Openings page.

SCALE 1/4" = 1'

DOUBLE-HUNG EXTENDED LEG HALF ROUND UNITS

| | |
|-------------------------------|----------------|
| M.O. BRICKMOULD | 86 1/4" (2191) |
| M.O. ADAMS/FLAT CASING | 89 1/4" (2267) |
| ROUGH OPENING | 83 1/2" (2121) |
| FRAME SIZE | 82 3/4" (2102) |
| DAYLIGHT OPENING | 79 1/8" (2010) |

49 11/16" (1262)
50 3/16" (1275)
48 1/8" (1222)
47 3/8" (1203)
43 3/4" (1111)

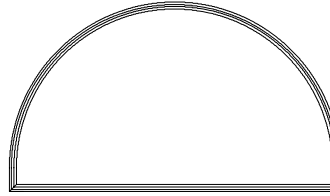

ECD8247ELHRDS

55 11/16" (1414)
56 3/16" (1427)
54 1/8" (1375)
53 3/8" (1356)
49 3/4" (1264)

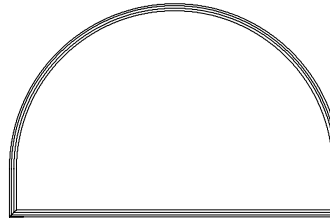

ECD8253ELHRDS

61 11/16" (1567)
62 3/16" (1580)
60 1/8" (1527)
59 3/8" (1508)
55 3/4" (1416)

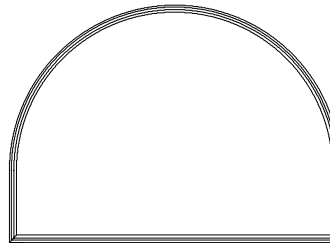

ECD8259ELHRDS

67 11/16" (1719)
68 3/16" (1732)
66 1/8" (1680)
65 3/8" (1584)
61 3/4" (1568)

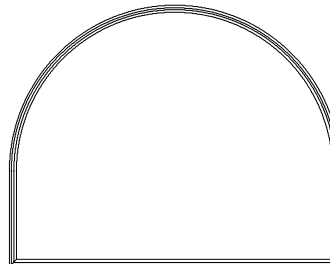

ECD8265ELHRDS

79 11/16" (2024)
80 3/16" (2037)
78 1/8" (1984)
77 3/8" (1965)
73 3/4" (1873)

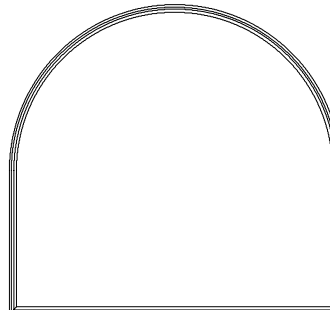

ECD8277ELHRDS

ELEVATION SYMBOL LEGEND:
M.O. = MASONRY OPENING
VALUES IN () ARE IN MILLIMETER CONVERSIONS

Note: Elevations shown DO NOT have exterior trim. Subtract 1/2" (12.7) from M.O. (Masonry Opening) for Unit Sizes. Masonry Openings above include Sill Nose, see Trim Options page for Sill Nose specifications. For other Trim Options refer to the Unit Sizing, Rough Opening & Masonry Openings page.

SCALE 1/4" = 1'

DOUBLE-HUNG EXTENDED LEG SEGMENT TOP UNITS

| M.O. BRICKMOLD | 32 7/8" (835) | 36 7/8" (937) | 40 7/8" (1038) | 44 7/8" (1140) |
|--|---------------|--|---|--|
| M.O. ADAMS/FLAT CASING | 35 7/8" (911) | 39 7/8" (1013) | 43 7/8" (1114) | 47 7/8" (1216) |
| ROUGH OPENING | 30 1/8" (765) | 34 1/8" (867) | 38 1/8" (968) | 42 1/8" (1070) |
| FRAME SIZE | 29 3/8" (746) | 33 3/8" (848) | 37 3/8" (949) | 41 3/8" (1051) |
| DAYLIGHT OPENING | 25 3/4" (654) | 29 3/4" (756) | 33 3/4" (857) | 37 3/4" (959) |
| 12 1/8" (308) 13 3/8" (346) 15 1/16" (388) 9 3/16" (249) 6 3/16" (157) | | 13 3/8" (340) 14 7/8" (378) 11 13/16" (300) 11 1/16" (281) 7 7/16" (189) | 14 13/16" (376) 16 5/16" (414) 13 1/4" (337) 12 1/2" (318) 8 7/8" (225) | 16 9/16" (421) 18 1/16" (459) 15" (381) 14 1/4" (362) 10 5/8" (270) |
| 18 1/8" (460) 19 5/8" (498) 16 3/16" (421) 15 13/16" (402) 12 3/16" (310) | | 19 3/8" (492) 20 7/8" (530) 17 13/16" (452) 17 1/16" (433) 13 7/16" (341) | 20 13/16" (529) 22 5/16" (567) 19 1/4" (489) 18 1/2" (470) 14 7/8" (378) | 22 9/16" (573) 24 1/16" (611) 21" (533) 20 1/4" (514) 16 5/8" (422) |
| 24 1/8" (613) 25 5/8" (651) 22 3/16" (573) 21 13/16" (554) 18 3/16" (462) | | 25 3/8" (645) 26 7/8" (683) 23 13/16" (605) 23 1/16" (586) 19 7/16" (494) | 26 13/16" (681) 28 5/16" (719) 25 1/4" (641) 24 1/2" (622) 20 7/8" (530) | 28 9/16" (725) 30 1/16" (764) 27" (686) 26 1/4" (667) 22 5/8" (575) |
| 30 1/8" (765) 31 5/8" (803) 29 9/16" (725) 27 3/16" (706) 24 3/16" (614) | | 31 3/8" (797) 32 7/8" (835) 29 13/16" (757) 29 1/16" (738) 25 7/16" (646) | 32 13/16" (833) 34 5/16" (872) 31 1/4" (794) 30 1/2" (775) 26 7/8" (683) | 34 9/16" (878) 36 1/16" (916) 33" (838) 32 1/4" (819) 28 5/8" (727) |
| 42 1/8" (1070) 43 5/8" (1108) 40 16" (1030) 39 3/16" (1011) 36 3/16" (919) | | 43 3/8" (1102) 44 7/8" (1140) 41 13/16" (1062) 41 1/16" (1043) 37 7/16" (951) | 44 13/16" (1138) 46 5/16" (1176) 43 1/4" (1099) 42 1/2" (1080) 38 7/8" (987) | 46 9/16" (1183) 48 1/16" (1221) 45" (1143) 44 1/4" (1124) 40 5/8" (1032) |
| 54 1/8" (1375) 55 5/8" (1413) 52 1/16" (1335) 51 13/16" (1316) 48 3/16" (1224) | | 55 3/8" (1407) 56 7/8" (1445) 53 13/16" (1367) 53 1/16" (1348) 49 7/16" (1256) | 56 13/16" (1443) 58 5/16" (1481) 55 1/4" (1403) 54 1/2" (1384) 50 7/8" (1292) | 58 9/16" (1487) 60 1/16" (1526) 57" (1449) 56 1/4" (1429) 52 5/8" (1337) |
| 66 1/8" (1680) 67 5/8" (1718) 64 9/16" (1640) 63 1/16" (1621) 60 3/16" (1529) | | 67 3/8" (1711) 68 7/8" (1749) 65 13/16" (1672) 65 1/16" (1653) 61 7/16" (1561) | 68 13/16" (1697) 68 5/16" (1735) 65 1/4" (1657) 64 1/2" (1638) 60 7/8" (1546) | 70 9/16" (1792) 72 1/16" (1830) 69" (1753) 68 1/4" (1734) 64 5/8" (1641) |
| | | | | |
| | | | | |
| | | | | |
| | | | | |
| | | | | |
| | | | | |
| | | | | |
| | | | | |
| | | | | |
| | | | | |
| | | | | |
| | | | | |
| | | | | |
| | | | | |
| | | | | |
| | | | | |

ELEVATION SYMBOL LEGEND:
M.O. = MASONRY OPENING
VALUES IN () ARE IN MILLIMETER CONVERSIONS

Note: Elevations shown DO NOT have exterior trim. Subtract 1/2" (12.7) from M.O. (Masonry Opening) for Unit Sizes. Masonry Openings above include Sill Nose, see Trim Options page for Sill Nose specifications. For other Trim Options refer to the Unit Sizing, Rough Opening & Masonry Openings page.

SCALE 1/4" = 1'

DOUBLE-HUNG EXTENDED LEG SEGMENT TOP UNITS

| | | | | |
|-------------------------------|---------------|----------------|----------------|----------------|
| M.O. BRICKMOULD | 32 7/8" (835) | 36 7/8" (937) | 40 7/8" (1038) | 44 7/8" (1140) |
| M.O. ADAMS/FLAT CASING | 35 7/8" (911) | 39 7/8" (1013) | 43 7/8" (1114) | 47 7/8" (1216) |
| ROUGH OPENING | 30 1/8" (765) | 34 1/8" (867) | 38 1/8" (968) | 42 1/8" (1070) |
| FRAME SIZE | 29 3/8" (746) | 33 3/8" (848) | 37 3/8" (949) | 41 3/8" (1051) |
| DAYLIGHT OPENING | 25 3/4" (654) | 29 3/4" (756) | 33 3/4" (857) | 37 3/4" (959) |

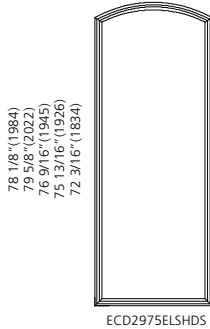

ECD2975ELSHDS



ECD3377ELSHDS

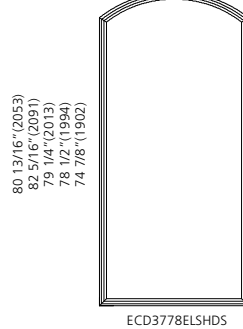

ECD3778ELSHDS

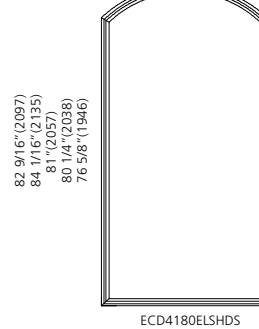

ECD4180ELSHDS

ELEVATION SYMBOL LEGEND:
M.O. = MASONRY OPENING
VALUES IN () ARE IN MILLIMETER CONVERSIONS

Note: Elevations shown DO NOT have exterior trim. Subtract 1/2" (12.7) from M.O. (Masonry Opening) for Unit Sizes. Masonry Openings above include Sill Nose, see Trim Options page for Sill Nose specifications. For other Trim Options refer to the Unit Sizing, Rough Opening & Masonry Openings page.

DOUBLE-HUNG EXTENDED LEG SEGMENT TOP UNITS

M.O. BRICKMOULD
M.O. ADAMS/FLAT CASING
ROUGH OPENING
FRAME SIZE
DAYLIGHT OPENING

| | | |
|------------------|------------------|-----------------|
| 62 1/4" (1581) | 70 1/4" (1784) | 78 1/4" (1988) |
| 65 1/4" (1657) | 73 1/4" (1861) | 81 1/4" (2064) |
| 59 1/2" (1511) | 67 1/2" (1715) | 75 1/2" (1918) |
| 58 3/4" (1492) | 66 3/4" (1695) | 74 3/4" (1899) |
| 55 1/8" (1400) | 63 1/8" (1603) | 71 1/8" (1807) |
| 16 5/16" (414) | 18 7/8" (479) | 17 1/16" (433) |
| 17 13/16" (452) | 20 3/8" (518) | 18 9/16" (471) |
| 14 3/4" (375) | 17 5/16" (440) | 15 1/2" (394) |
| 14" (356) | 16 9/16" (421) | 14 3/4" (375) |
| 10 3/8" (264) | 12 15/16" (329) | 11 1/8" (283) |
| ECD5814ELSHDS | ECD6616ELSHDS | ECD7414ELSHDS |
| 22 5/16" (578) | 24 7/8" (632) | 23 1/16" (586) |
| 23 13/16" (605) | 26 3/8" (670) | 24 9/16" (624) |
| 20 3/4" (527) | 23 5/16" (592) | 21 1/2" (546) |
| 20" (508) | 22 9/16" (573) | 20 3/4" (527) |
| 16 3/8" (416) | 18 15/16" (481) | 17 1/8" (435) |
| ECD5820ELSHDS | ECD6622ELSHDS | ECD7420ELSHDS |
| 28 5/16" (719) | 30 7/8" (784) | 29 1/16" (738) |
| 29 13/16" (757) | 32 3/8" (822) | 30 9/16" (776) |
| 26 3/4" (679) | 29 5/16" (745) | 27 1/2" (699) |
| 26" (660) | 28 9/16" (725) | 26 3/4" (679) |
| 22 3/8" (568) | 24 15/16" (633) | 23 1/8" (587) |
| ECD5826ELSHDS | ECD6628ELSHDS | ECD7426ELSHDS |
| 34 5/16" (872) | 36 7/8" (937) | 35 1/16" (891) |
| 35 13/16" (910) | 38 3/8" (975) | 36 9/16" (929) |
| 32 3/4" (832) | 35 5/16" (897) | 33 1/2" (851) |
| 32" (813) | 34 9/16" (878) | 32 3/4" (832) |
| 28 3/8" (721) | 30 15/16" (786) | 29 1/8" (740) |
| ECD5832ELSHDS | ECD6634ELSHDS | ECD7432ELSHDS |
| 46 5/16" (1176) | 48 7/8" (1241) | 47 1/16" (1195) |
| 47 13/16" (1214) | 50 3/8" (1280) | 48 9/16" (1233) |
| 44 3/4" (1137) | 47 5/16" (1202) | 45 1/2" (1156) |
| 44" (1118) | 46 9/16" (1183) | 44 3/4" (1137) |
| 40 3/8" (1026) | 42 15/16" (1091) | 41 1/8" (1045) |
| ECD5844ELSHDS | ECD6646ELSHDS | ECD7444ELSHDS |
| 58 5/16" (1481) | 60 7/8" (1546) | 59 1/16" (1500) |
| 59 13/16" (1519) | 62 3/8" (1584) | 60 9/16" (1538) |
| 56 3/4" (1441) | 59 5/16" (1507) | 57 1/2" (1461) |
| 56" (1422) | 58 9/16" (1487) | 56 3/4" (1441) |
| 52 3/8" (1330) | 54 15/16" (1395) | 53 1/8" (1349) |
| ECD5856ELSHDS | ECD6658ELSHDS | ECD7456ELSHDS |
| 70 5/16" (1786) | 72 7/8" (1851) | 71 1/16" (1805) |
| 71 13/16" (1824) | 74 3/8" (1889) | 72 9/16" (1843) |
| 68 3/4" (1746) | 71 5/16" (1811) | 69 1/2" (1765) |
| 68" (1727) | 70 9/16" (1792) | 68 3/4" (1746) |
| 64 3/8" (1635) | 66 15/16" (1700) | 65 1/8" (1654) |
| ECD5868ELSHDS | ECD6670ELSHDS | ECD7468ELSHDS |

ELEVATION SYMBOL LEGEND:

M.O. = MASONRY OPENING
VALUES IN () ARE IN MILLIMETER CONVERSIONS

Note: Elevations shown DO NOT have exterior trim. Subtract 1/2" (12.7) from M.O. (Masonry Opening) for Unit Sizes. Masonry Openings above include Sill Nose, see Trim Options page for Sill Nose specifications. For other Trim Options refer to the Unit Sizing, Rough Opening & Masonry Openings page.

SCALE 1/4" = 1'

DOUBLE-HUNG EXTENDED LEG SEGMENT TOP UNITS

M.O. BRICKMOULD 62 1/4" (1581)
M.O. ADAMS/FLAT CASING 65 1/4" (1657)
ROUGH OPENING 59 1/2" (1511)
FRAME SIZE 58 3/4" (1492)
DAYLIGHT OPENING 55 1/8" (1400)

70 1/4" (1784)
73 1/4" (1861)
67 1/2" (1715)
66 3/4" (1695)
63 1/8" (1603)

78 1/4" (1988)
81 1/4" (2064)
75 1/2" (1918)
74 3/4" (1899)
71 1/8" (1807)

82 5/16" (2091)
83 13/16" (2129)
80 3/4" (2051)
80" (2032)
76 3/8" (1940)

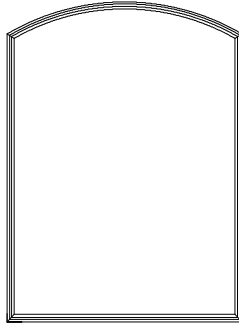

ECD5880ELSHDS

84 7/8" (2155)
86 3/8" (2194)
83 5/16" (2116)
82 9/16" (2097)
78 15/16" (2005)

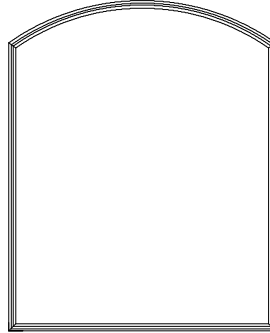

ECD6682ELSHDS

83 1/16" (2110)
84 9/16" (2148)
81 1/2" (2070)
80 3/4" (2051)
77 1/8" (1959)

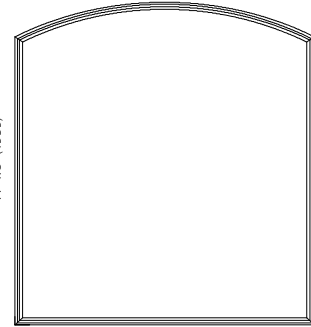

ECD7480ELSHDS

ELEVATION SYMBOL LEGEND:

M.O. = MASONRY OPENING
VALUES IN () ARE IN MILLIMETER CONVERSIONS

Note: Elevations shown DO NOT have exterior trim. Subtract 1/2" (12.7) from M.O. (Masonry Opening) for Unit Sizes. Masonry Openings above include Sill Nose, see Trim Options page for Sill Nose specifications. For other Trim Options refer to the Unit Sizing, Rough Opening & Masonry Openings page.

DOUBLE-HUNG EXTENDED LEG SEGMENT TOP UNITS

**M.O. BRICKMOULD
M.O. ADAMS/FLAT CASING
ROUGH OPENING
FRAME SIZE
DAYLIGHT OPENING**

86 1/4" (2191)
89 1/4" (2267)
83 1/2" (2121)
82 3/4" (2102)
79 1/8" (2010)

**M.O. BRICKMOULD
M.O. ADAMS/FLAT CASING
ROUGH OPENING
FRAME SIZE
DAYLIGHT OPENING**

86 1/4" (2191)
89 1/4" (2267)
83 1/2" (2121)
82 3/4" (2102)
79 1/8" (2010)

19 3/16" (487)
20 11/16" (525)
17 5/8" (448)
16 7/8" (427)
13 1/4" (337)

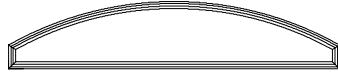

ECD8216ELSHDS

25 3/16" (640)
26 11/16" (678)
23 5/8" (600)
22 7/8" (581)
19 1/4" (489)

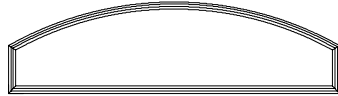

ECD8222ELSHDS

31 3/16" (792)
32 11/16" (830)
29 5/8" (752)
28 7/8" (733)
25 1/4" (641)

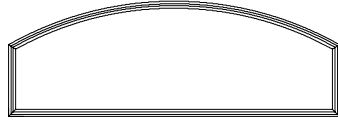

ECD8228ELSHDS

37 3/16" (945)
38 11/16" (983)
35 5/8" (905)
34 7/8" (886)
31 1/4" (794)

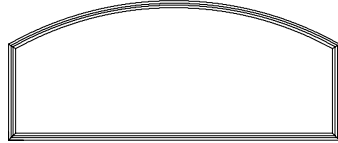

ECD8234ELSHDS

49 3/16" (1249)
50 11/16" (1287)
47 5/8" (1210)
46 7/8" (1191)
43 1/4" (1099)

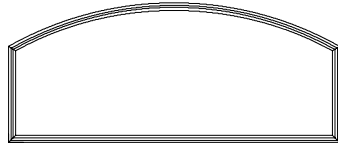

ECD8246ELSHDS

61 3/16" (1554)
62 11/16" (1592)
59 5/8" (1514)
58 7/8" (1495)
55 1/4" (1403)

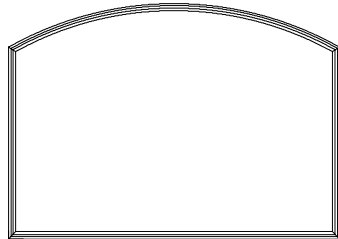

ECD8258ELSHDS

73 3/16" (1859)
74 11/16" (1897)
71 5/8" (1819)
70 7/8" (1800)
67 1/4" (1708)

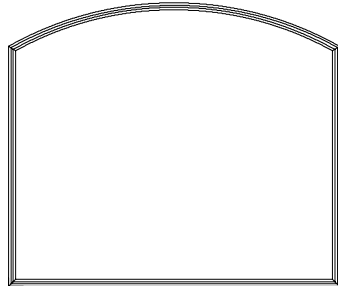

ECD8270ELSHDS

85 3/16" (2164)
86 11/16" (2202)
83 5/8" (2124)
82 7/8" (2105)
79 1/4" (2013)

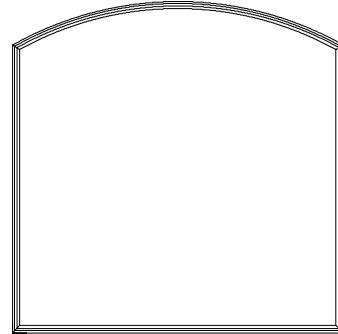

ECD8282ELSHDS

ELEVATION SYMBOL LEGEND:

M.O. = MASONRY OPENING
VALUES IN () ARE IN MILLIMETER CONVERSIONS

Note: Elevations shown DO NOT have exterior trim. Subtract 1/2" (12.7) from M.O. (Masonry Opening) for Unit Sizes. Masonry Openings above include Sill Nose, see Trim Options page for Sill Nose specifications. For other Trim Options refer to the Unit Sizing, Rough Opening & Masonry Openings page.

SCALE 1/4" = 1'

SWINGING PATIO DOOR HALF ROUND UNITS

M.O. BRICKMOULD
M.O. ADAMS/FLAT CASING
ROUGH OPENING
FRAME SIZE
DAYLIGHT OPENING

33 1/2" (851)
36 1/2" (927)
30 3/4" (781)
30" (762)
26 3/8" (670)

36 1/2" (927)
39 1/2" (1003)
33 3/4" (857)
33" (838)
29 3/8" (746)

39 1/2" (1003)
42 1/2" (1080)
36 3/4" (933)
36" (914)
32 3/8" (822)

63 1/2" (1613)
66 1/2" (1689)
60 3/4" (1543)
60" (1524)
56 3/8" (1432)

17 5/16" (440)
18 13/16" (478)
15 3/4" (400)
15" (381)
11 3/8" (289)



SDRTC-26

18 13/16" (478)
20 5/16" (516)
17 1/4" (438)
16 1/2" (419)
12 7/8" (327)



SDRTC-29

20 5/16" (516)
21 13/16" (554)
18 3/4" (476)
18" (457)
14 3/8" (365)



SDRTC-30

32 5/16" (821)
33 13/16" (859)
30 3/4" (781)
30" (762)
26 3/8" (670)



SDRTC-50

M.O. BRICKMOULD
M.O. ADAMS/FLAT CASING
ROUGH OPENING
FRAME SIZE
DAYLIGHT OPENING

69 1/2" (1765)
72 1/2" (1842)
66 3/4" (1695)
66" (1676)
62 3/8" (1584)

75 1/2" (1918)
78 1/2" (1994)
72 3/4" (1848)
72" (1829)
68 3/8" (1737)

93 1/2" (2380)
96 1/2" (2451)
90 3/4" (2305)
90" (2286)
86 3/8" (2194)

35 5/16" (897)
36 13/16" (935)
33 3/4" (857)
33" (838)
29 3/8" (746)

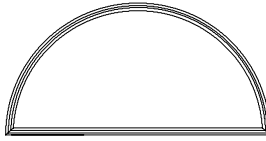

SDRTC-56

38 5/16" (973)
39 13/16" (1011)
36 3/4" (933)
36" (914)
32 3/8" (822)

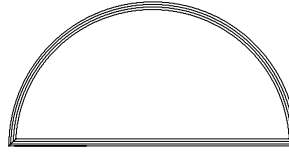

SDRTC-60

47 5/16" (1202)
48 13/16" (1240)
45 3/4" (1162)
45" (1143)
41 3/8" (1051)

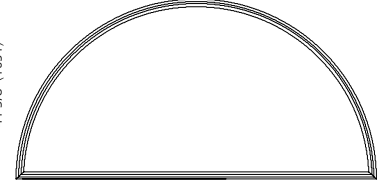

SDRTC-76

M.O. BRICKMOULD
M.O. ADAMS/FLAT CASING
ROUGH OPENING
FRAME SIZE
DAYLIGHT OPENING

102 1/2" (2604)
105 1/2" (2680)
99 3/4" (2534)
99" (2515)
95 3/8" (2423)

111 1/2" (2832)
114 1/2" (2908)
108 3/4" (2762)
108" (2743)
104 3/8" (2651)

51 13/16" (1316)
53 5/16" (1354)
50 1/4" (1276)
49 1/2" (1257)
45 7/8" (1165)

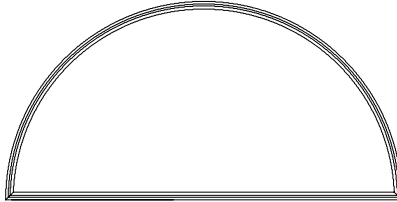

SDRTC-83

56 5/16" (1430)
57 13/16" (1468)
54 3/4" (1391)
54" (1372)
50 3/8" (1280)

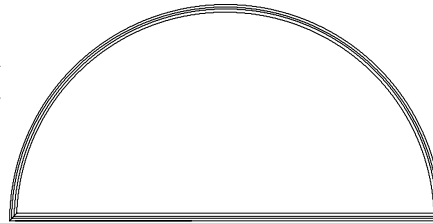

SDRTC-90

ELEVATION SYMBOL LEGEND:

M.O. = MASONRY OPENING
VALUES IN () ARE IN MILLIMETER CONVERSIONS

Note: Elevations shown DO NOT have exterior trim. Subtract 1/2" (12.7) from M.O. (Masonry Opening) for Unit Sizes. Masonry Openings above include Sill Nose, see Trim Options page for Sill Nose specifications. For other Trim Options refer to the Unit Sizing, Rough Opening & Masonry Openings page.

SWINGING PATIO DOOR EXTENDED HALF ROUND UNITS

M.O. BRICKMOULD
M.O. ADAMS/FLAT CASING
ROUGH OPENING
FRAME SIZE
DAYLIGHT OPENING

33 1/2" (851)
36 1/2" (927)
30 3/4" (781)
30" (762)
26 3/8" (670)

36 1/2" (927)
39 1/2" (1003)
33 3/4" (857)
33" (838)
29 3/8" (746)

39 1/2" (1003)
42 1/2" (1080)
36 3/4" (933)
36" (914)
32 3/8" (822)

63 1/2" (1613)
66 1/2" (1689)
60 3/4" (1543)
60" (1524)
56 3/8" (1432)

23 5/16" (592)
24 13/16" (630)
21 3/4" (552)
21" (533)
17 3/8" (441)

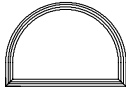

SDEHC-26L06

24 13/16" (630)
25 5/16" (643)
23 1/4" (591)
22 1/2" (572)
18 7/8" (479)

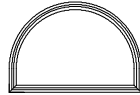

SDEHC-29L06

26 5/16" (668)
27 13/16" (706)
24 3/4" (629)
24" (610)
20 3/8" (518)



SDEHC-30L06

38 5/16" (973)
39 13/16" (1011)
36 3/4" (933)
36" (914)
32 3/8" (822)

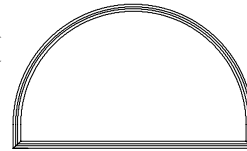

SDEHC-50L06

29 5/16" (745)
30 13/16" (783)
27 3/4" (705)
27" (686)
23 3/8" (594)

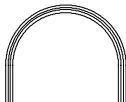

SDEHC-26L10

30 13/16" (783)
31 5/16" (795)
29 1/4" (743)
28 1/2" (724)
24 7/8" (632)



SDEHC-29L10

32 5/16" (821)
33 13/16" (859)
30 3/4" (781)
30" (762)
26 3/8" (670)



SDEHC-30L10

44 5/16" (1126)
45 13/16" (1164)
42 3/4" (1086)
42" (1067)
38 3/8" (975)

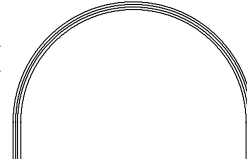

SDEHC-50L10

35 5/16" (897)
36 13/16" (935)
33 3/4" (857)
33" (838)
29 3/8" (746)

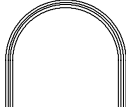

SDEHC-26L16

36 13/16" (935)
37 5/16" (948)
35 1/4" (895)
34 1/2" (876)
30 7/8" (784)

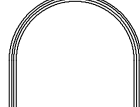

SDEHC-29L16

38 5/16" (973)
39 13/16" (1011)
36 3/4" (933)
36" (914)
32 3/8" (822)



SDEHC-30L16

50 5/16" (1278)
51 13/16" (1316)
48 3/4" (1238)
48" (1219)
44 3/8" (1127)

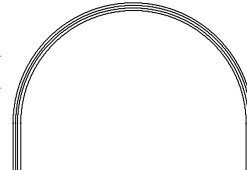

SDEHC-50L16

41 5/16" (1049)
42 13/16" (1087)
39 3/4" (1010)
39" (991)
35 3/8" (899)

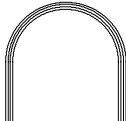

SDEHC-26L20

42 13/16" (1087)
43 5/16" (1100)
41 1/4" (1048)
40 1/2" (1029)
36 7/8" (937)

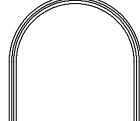

SDEHC-29L20

44 5/16" (1126)
45 13/16" (1164)
42 3/4" (1086)
42" (1067)
38 3/8" (975)

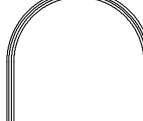

SDEHC-30L20

56 5/16" (1430)
57 13/16" (1468)
54 3/4" (1391)
54" (1372)
50 3/8" (1280)

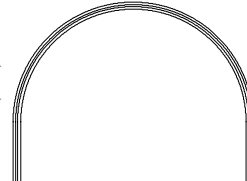

SDEHC-50L20

53 5/16" (1354)
54 13/16" (1392)
51 3/4" (1314)
51" (1295)
47 3/8" (1203)

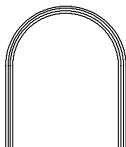

SDEHC-26L30

54 13/16" (1392)
55 5/16" (1405)
53 1/4" (1353)
52 1/2" (1334)
48 7/8" (1241)

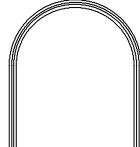

SDEHC-29L30

56 5/16" (1430)
57 13/16" (1468)
54 3/4" (1391)
54" (1372)
50 3/8" (1280)

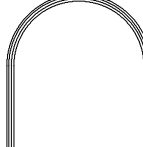

SDEHC-30L30

68 5/16" (1735)
69 13/16" (1773)
66 3/4" (1695)
66" (1676)
62 3/8" (1584)

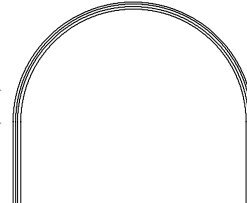

SDEHC-50L30

ELEVATION SYMBOL LEGEND:
M.O. = MASONRY OPENING
VALUES IN () ARE IN MILLIMETER CONVERSIONS

Note: Elevations shown DO NOT have exterior trim. Subtract 1/2" (12.7) from M.O. (Masonry Opening) for Unit Sizes. Masonry Openings above include Sill Nose, see Trim Options page for Sill Nose specifications. For other Trim Options refer to the Unit Sizing, Rough Opening & Masonry Openings page.

SCALE 1/4" = 1'

SWINGING PATIO DOOR EXTENDED HALF ROUND UNITS

M.O. BRICKMOULD
M.O. ADAMS/FLAT CASING
ROUGH OPENING
FRAME SIZE
DAYLIGHT OPENING

33 1/2" (851)
36 1/2" (927)
30 3/4" (781)
30" (762)
26 3/8" (670)

36 1/2" (927)
39 1/2" (1003)
33 3/4" (857)
33" (838)
29 3/8" (746)

39 1/2" (1003)
42 1/2" (1080)
36 3/4" (933)
36" (914)
32 3/8" (822)

63 1/2" (1613)
66 1/2" (1689)
60 3/4" (1543)
60" (1524)
56 3/8" (1432)

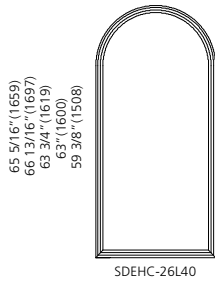

SDEHC-26L40

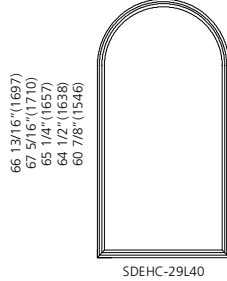

SDEHC-29L40

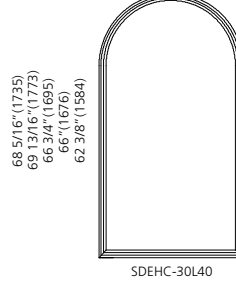

SDEHC-30L40

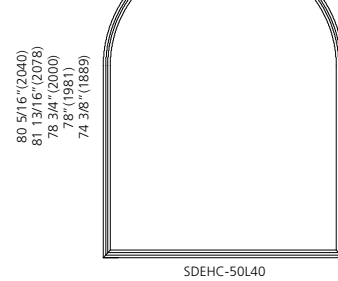

SDEHC-50L40

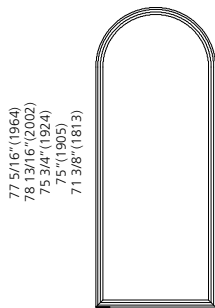

SDEHC-26L50

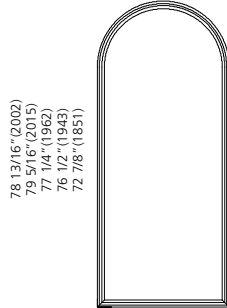

SDEHC-29L50

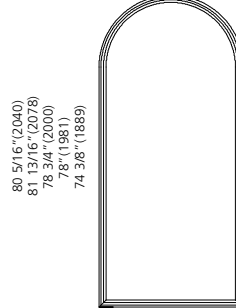

SDEHC-30L50

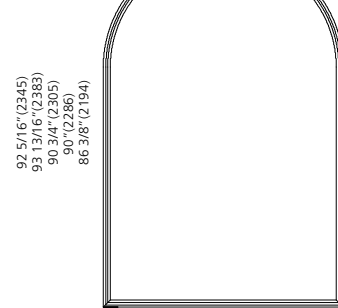

SDEHC-50L50

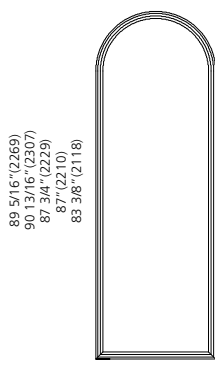

SDEHC-26L60

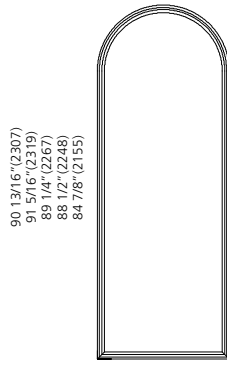

SDEHC-29L60

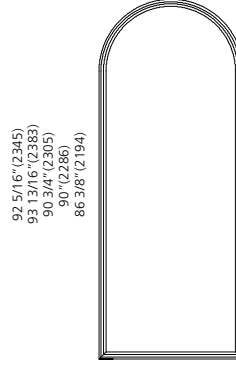

SDEHC-30L60

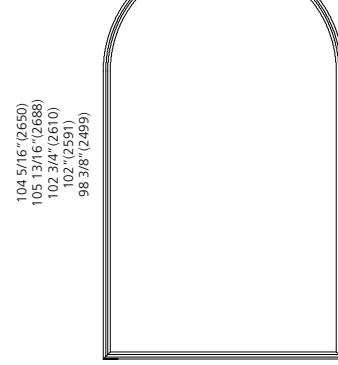

SDEHC-50L60

ELEVATION SYMBOL LEGEND:
M.O. = MASONRY OPENING
VALUES IN () ARE IN MILLIMETER CONVERSIONS

Note: Elevations shown DO NOT have exterior trim. Subtract 1/2" (12.7) from M.O. (Masonry Opening) for Unit Sizes. Masonry Openings above include Sill Nose, see Trim Options page for Sill Nose specifications. For other Trim Options refer to the Unit Sizing, Rough Opening & Masonry Openings page.

SCALE 1/4" = 1'

SWINGING PATIO DOOR EXTENDED HALF ROUND UNITS

M.O. BRICKMOULD
M.O. ADAMS/FLAT CASING
ROUGH OPENING
FRAME SIZE
DAYLIGHT OPENING

69 1/2" (1765)
72 1/2" (1842)
66 3/4" (1695)
66" (1676)
62 3/8" (1584)

75 1/2" (1918)
78 1/2" (1994)
72 3/4" (1848)
72" (1829)
68 3/8" (1737)

41 5/16" (1049)
42 13/16" (1087)
39 3/4" (1010)
39" (991)
35 3/8" (899)

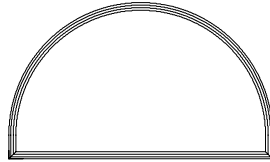

SDEHC-56L06

44 5/16" (1136)
45 13/16" (1164)
42 3/4" (1086)
42" (1067)
38 3/8" (975)

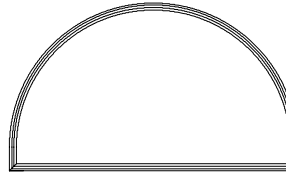

SDEHC-60L06

47 5/16" (1202)
48 13/16" (1240)
45 3/4" (1162)
45" (1143)
41 3/8" (1051)

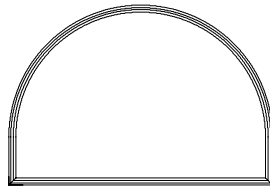

SDEHC-56L10

50 5/16" (1278)
51 13/16" (1316)
48 3/4" (1238)
48" (1219)
44 3/8" (1127)

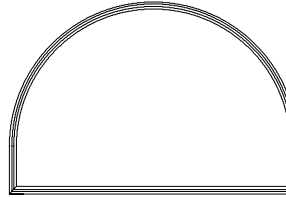

SDEHC-60L10

53 5/16" (1354)
54 13/16" (1392)
51 3/4" (1314)
51" (1295)
47 3/8" (1203)

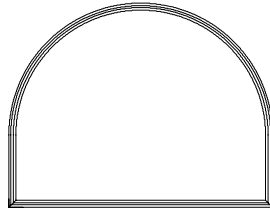

SDEHC-56L16

56 5/16" (1430)
57 13/16" (1468)
54 3/4" (1391)
54" (1372)
50 3/8" (1280)

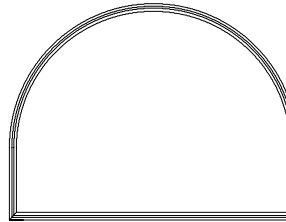

SDEHC-60L16

59 5/16" (1507)
60 13/16" (1545)
57 3/4" (1467)
57" (1448)
53 3/8" (1356)

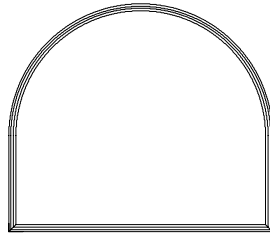

SDEHC-56L20

62 5/16" (1583)
63 13/16" (1621)
60 3/4" (1543)
60" (1524)
56 3/8" (1432)

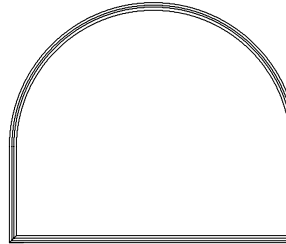

SDEHC-60L20

71 5/16" (1811)
72 13/16" (1849)
69 3/4" (1772)
69" (1753)
65 3/8" (1661)

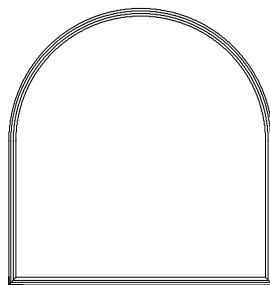

SDEHC-56L30

74 5/16" (1888)
75 13/16" (1926)
72 3/4" (1848)
72" (1829)
68 3/8" (1737)

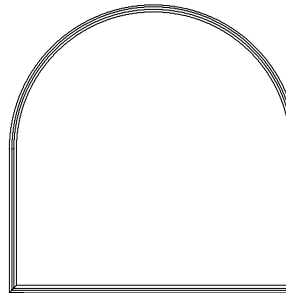

SDEHC-60L30

ELEVATION SYMBOL LEGEND:

M.O. = MASONRY OPENING
VALUES IN () ARE IN MILLIMETER CONVERSIONS

Note: Elevations shown DO NOT have exterior trim. Subtract 1/2" (12.7) from M.O. (Masonry Opening) for Unit Sizes. Masonry Openings above include Sill Nose, see Trim Options page for Sill Nose specifications. For other Trim Options refer to the Unit Sizing, Rough Opening & Masonry Openings page.

SCALE 1/4" = 1'

SWINGING PATIO DOOR EXTENDED HALF ROUND UNITS

M.O. BRICKMOULD
M.O. ADAMS/FLAT CASING
ROUGH OPENING
FRAME SIZE
DAYLIGHT OPENING

69 1/2"(1765)
72 1/2"(1842)
66 3/4"(1695)
66"(1676)
62 3/8"(1584)

75 1/2"(1918)
78 1/2"(1994)
72 3/4"(1848)
72"(1829)
68 3/8"(1737)

83 5/16"(2116)
84 13/16"(2154)
81 3/4"(2076)
81"(2057)
77 3/8"(1965)

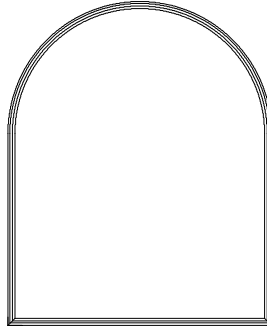

SDEHC-56L40

86 5/16"(2192)
87 13/16"(2230)
84 3/4"(2153)
84"(2134)
80 3/8"(2042)

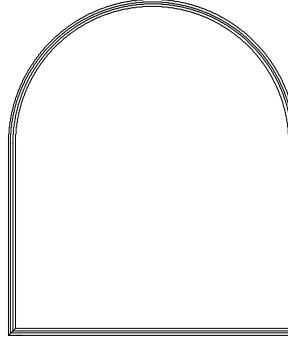

SDEHC-60L40

95 5/16"(2421)
96 13/16"(2459)
93 3/4"(2381)
93"(2362)
89 3/8"(2270)

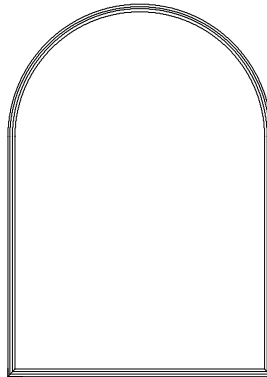

SDEHC-56L50

98 5/16"(2497)
99 13/16"(2535)
96 3/4"(2457)
96"(2438)
92 3/8"(2346)

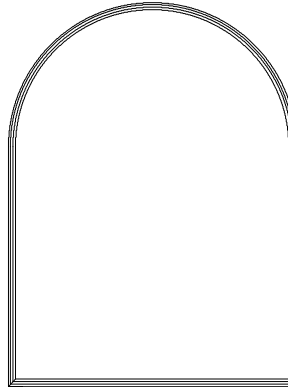

SDEHC-60L50

107 5/16"(2726)
108 13/16"(2764)
105 3/4"(2686)
105"(2667)
101 3/8"(2575)

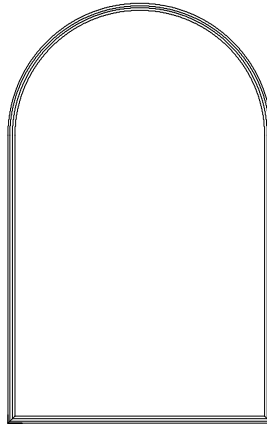

SDEHC-56L60

ELEVATION SYMBOL LEGEND:
M.O. = MASONRY OPENING
VALUES IN () ARE IN MILLIMETER CONVERSIONS

Note: Elevations shown DO NOT have exterior trim. Subtract 1/2" (12.7) from M.O. (Masonry Opening) for Unit Sizes. Masonry Openings above include Sill Nose, see Trim Options page for Sill Nose specifications. For other Trim Options refer to the Unit Sizing, Rough Opening & Masonry Openings page.

SCALE 1/4" = 1'

SWINGING PATIO DOOR EXTENDED LEG SEGMENT TOP UNITS

M.O. BRICKMOULD
M.O. ADAMS/FLAT CASING
ROUGH OPENING
FRAME SIZE
DAYLIGHT OPENING

| | | | |
|---|---|---|---|
| 33 1/2" (851) 36 1/2" (927) 30 3/4" (781) 30" (762) 26 3/8" (670) | 36 1/2" (927) 39 1/2" (1003) 33 3/4" (857) 33" (838) 29 3/8" (746) | 39 1/2" (1003) 42 1/2" (1080) 36 3/4" (933) 36" (914) 32 3/8" (822) | 63 1/2" (1613) 66 1/2" (1689) 60 3/4" (1543) 60" (1524) 56 3/8" (1432) |
| 12 5/16" (313) 13 13/16" (351) 10 3/4" (273) 10" (254) 6 3/8" (162) | 13 1/4" (337) 14 3/4" (375) 11 3/4" (297) 10 15/16" (278) 7 3/16" (186) | 14 5/16" (364) 15 13/16" (402) 12 3/4" (324) 12" (305) 8 3/8" (213) | 16 11/16" (424) 17 3/16" (437) 15 1/8" (384) 14 3/8" (365) 10 3/4" (273) |
| 18 5/16" (465) 19 13/16" (503) 16 3/4" (425) 16" (406) 12 3/8" (314) | 19 1/4" (489) 20 3/4" (527) 17 11/16" (449) 16 15/16" (430) 13 5/16" (336) | 20 5/16" (515) 21 13/16" (554) 18 3/4" (476) 18" (457) 14 3/8" (365) | 22 11/16" (576) 23 3/16" (589) 21 1/8" (537) 20 3/8" (518) 16 3/4" (425) |
| 24 5/16" (618) 25 13/16" (656) 22 3/4" (578) 22" (559) 18 3/8" (467) | 25 1/4" (641) 26 3/4" (679) 23 11/16" (591) 23 15/16" (583) 19 5/16" (491) | 26 5/16" (668) 27 13/16" (706) 24 3/4" (629) 24" (610) 20 3/8" (518) | 28 11/16" (729) 29 3/16" (741) 27 1/8" (689) 26 3/8" (670) 22 3/4" (578) |
| 30 5/16" (770) 31 13/16" (808) 28 3/4" (730) 28" (711) 24 3/8" (619) | 31 1/4" (794) 32 3/4" (832) 29 11/16" (754) 28 15/16" (735) 25 5/16" (643) | 32 5/16" (821) 33 13/16" (859) 30 3/4" (781) 30" (762) 26 3/8" (670) | 34 11/16" (881) 35 3/16" (894) 33 1/8" (841) 32 3/8" (822) 28 3/4" (730) |
| 42 5/16" (1075) 43 13/16" (1113) 40 3/4" (1035) 40" (1016) 36 3/8" (924) | 43 1/4" (1099) 44 3/4" (1137) 41 11/16" (1059) 40 15/16" (1040) 37 3/16" (948) | 44 5/16" (1126) 45 13/16" (1164) 42 3/4" (1086) 42" (1067) 38 3/8" (975) | 46 11/16" (1186) 47 3/16" (1199) 45 1/8" (1146) 44 3/8" (1127) 40 3/4" (1035) |
| 54 5/16" (1380) 55 13/16" (1418) 52 3/4" (1340) 52" (1321) 48 3/8" (1229) | 55 1/4" (1403) 56 3/4" (1441) 53 11/16" (1363) 52 15/16" (1345) 49 5/16" (1255) | 56 5/16" (1430) 57 13/16" (1468) 54 3/4" (1391) 54" (1372) 50 3/8" (1280) | 58 11/16" (1491) 59 3/16" (1503) 57 1/8" (1451) 56 3/8" (1432) 52 3/4" (1340) |
| 66 5/16" (1684) 67 13/16" (1722) 64 3/4" (1645) 64" (1626) 60 3/8" (1534) | 67 1/4" (1708) 68 3/4" (1746) 65 11/16" (1668) 64 15/16" (1650) 61 5/16" (1557) | 68 5/16" (1735) 69 13/16" (1773) 66 3/4" (1695) 66" (1676) 62 3/8" (1584) | 70 11/16" (1795) 71 3/16" (1808) 69 1/8" (1756) 68 3/8" (1737) 64 3/4" (1645) |
| SDESC-26L06 | SDESC-29L06 | SDESC-30L06 | SDESC-50L06 |
| SDESC-26L10 | SDESC-29L10 | SDESC-30L10 | SDESC-50L10 |
| SDESC-26L16 | SDESC-29L16 | SDESC-30L16 | SDESC-50L16 |
| SDESC-26L20 | SDESC-29L20 | SDESC-30L20 | SDESC-50L20 |
| SDESC-26L30 | SDESC-29L30 | SDESC-30L30 | SDESC-50L30 |
| SDESC-26L40 | SDESC-29L40 | SDESC-30L40 | SDESC-50L40 |
| SDESC-26L50 | SDESC-29L50 | SDESC-30L50 | SDESC-50L50 |

ELEVATION SYMBOL LEGEND:
M.O. = MASONRY OPENING
VALUES IN () ARE IN MILLIMETER CONVERSIONS

Note: Elevations shown DO NOT have exterior trim. Subtract 1/2" (12.7) from M.O. (Masonry Opening) for Unit Sizes. Masonry Openings above include Sill Nose, see Trim Options page for Sill Nose specifications. For other Trim Options refer to the Unit Sizing, Rough Opening & Masonry Openings page.

SCALE 1/4" = 1'

SWINGING PATIO DOOR EXTENDED LEG SEGMENT TOP UNITS

M.O. BRICKMOULD 33 1/2"(851)
M.O. ADAMS/FLAT CASING 36 1/2"(927)
ROUGH OPENING 30 3/4"(781)
FRAME SIZE 30"(762)
DAYLIGHT OPENING 26 3/8"(670)

36 1/2"(927)
39 1/2"(1003)
33 3/4"(857)
33"(838)
29 3/8"(746)

39 1/2"(1003)
42 1/2"(1080)
36 3/4"(933)
36"(914)
32 3/8"(822)

63 1/2"(1613)
66 1/2"(1689)
60 3/4"(1543)
60"(1524)
56 3/8"(1432)

78 5/16"(2002)
79 13/16"(2027)
76 3/4"(1949)
76"(1930)
72 3/8"(1838)

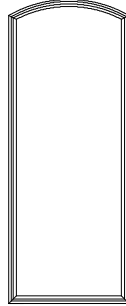

SDESC-26L60

79 1/4"(2013)
80 3/4"(2051)
77 1/16"(1973)
76 15/16"(1954)
73 5/16"(1862)

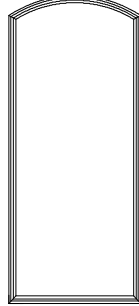

SDESC-29L60

80 5/16"(2053)
81 13/16"(2078)
78 3/4"(2000)
78"(1981)
74 3/8"(1889)

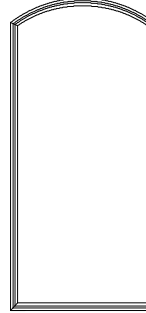

SDESC-30L60

82 11/16"(2100)
83 3/16"(2113)
81 1/8"(2061)
80 3/8"(2042)
76 3/4"(1949)

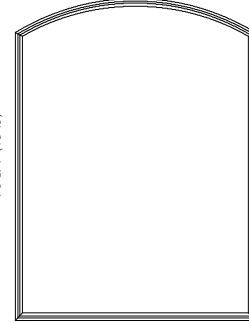

SDESC-50L60

ELEVATION SYMBOL LEGEND:

M.O. = MASONRY OPENING
VALUES IN () ARE IN MILLIMETER CONVERSIONS

Note: Elevations shown DO NOT have exterior trim. Subtract 1/2" (12.7) from M.O. (Masonry Opening) for Unit Sizes. Masonry Openings above include Sill Nose, see Trim Options page for Sill Nose specifications. For other Trim Options refer to the Unit Sizing, Rough Opening & Masonry Openings page.

SWINGING PATIO DOOR EXTENDED LEG SEGMENT TOP UNITS

**M.O. BRICKMOULD
M.O. ADAMS/FLAT CASING
ROUGH OPENING
FRAME SIZE
DAYLIGHT OPENING**

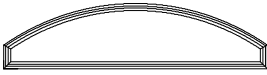
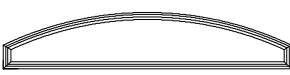
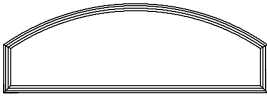
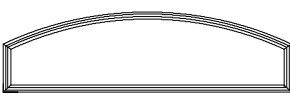
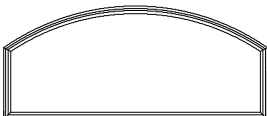
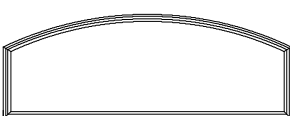
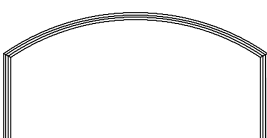
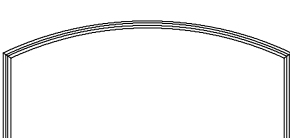
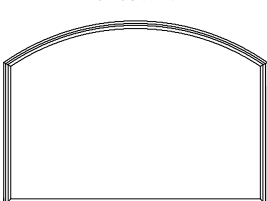
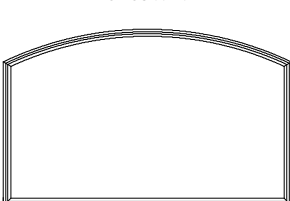
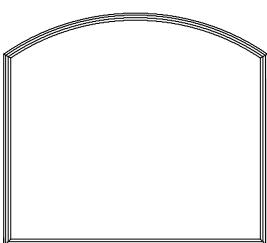
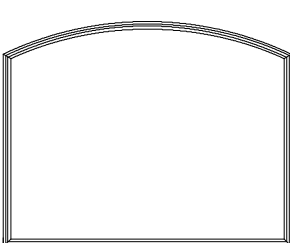
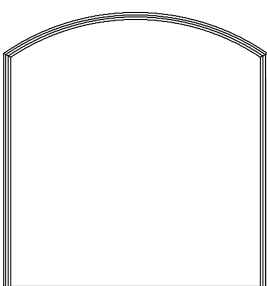
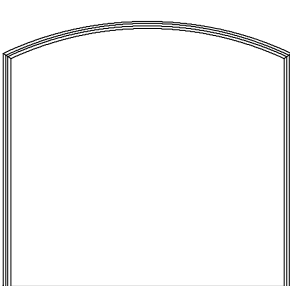
| | | | |
|--|---|---|--|
| 69 1/2" (1765) 72 1/2" (1842) 66 3/4" (1695) 66" (1676) 62 3/8" (1584) |  | 75 1/2" (1918) 78 1/2" (1994) 72 3/4" (1848) 72" (1829) 68 3/8" (1737) |  |
| 18 5/8" (473) 20 1/8" (511) 17 1/16" (433) 16 5/16" (414) 12 11/16" (322) | SDESC-56L06 | 16 7/16" (418) 17 15/16" (455) 14 7/8" (378) 14 1/8" (359) 10 1/2" (267) | SDESC-60L06 |
| 24 5/8" (625) 26 1/8" (664) 23 1/16" (586) 22 5/16" (567) 18 11/16" (475) |  | 23 7/16" (595) 24 15/16" (633) 20 7/8" (530) 20 1/8" (511) 16 1/2" (419) |  |
| SDESC-56L10 | | SDESC-60L10 | |
| 30 5/8" (778) 32 1/8" (816) 29 1/16" (738) 28 5/16" (719) 24 11/16" (627) |  | 29 7/16" (748) 30 15/16" (786) 26 7/8" (683) 26 1/8" (664) 22 1/2" (572) |  |
| SDESC-56L16 | | SDESC-60L16 | |
| 36 5/8" (930) 38 1/8" (968) 35 1/16" (891) 34 5/16" (872) 30 11/16" (779) |  | 35 7/16" (900) 36 15/16" (938) 32 7/8" (835) 32 1/8" (816) 28 1/2" (724) |  |
| SDESC-56L20 | | SDESC-60L20 | |
| 48 5/8" (1235) 50 1/8" (1273) 47 1/16" (1195) 46 5/16" (1176) 42 11/16" (1084) |  | 47 7/16" (1205) 48 15/16" (1243) 44 7/8" (1140) 44 1/8" (1121) 40 1/2" (1029) |  |
| SDESC-56L30 | | SDESC-60L30 | |
| 60 5/8" (1540) 62 1/8" (1578) 59 1/16" (1500) 58 5/16" (1481) 54 11/16" (1389) |  | 59 7/16" (1510) 60 15/16" (1548) 56 7/8" (1445) 56 1/8" (1426) 52 1/2" (1334) |  |
| SDESC-56L40 | | SDESC-60L40 | |
| 72 5/8" (1845) 74 1/8" (1883) 71 1/16" (1805) 70 5/16" (1786) 66 11/16" (1694) |  | 71 7/16" (1815) 72 15/16" (1853) 68 7/8" (1749) 68 1/8" (1730) 64 1/2" (1638) |  |
| SDESC-56L50 | | SDESC-60L50 | |

ELEVATION SYMBOL LEGEND:
M.O. = MASONRY OPENING
VALUES IN () ARE IN MILLIMETER CONVERSIONS

Note: Elevations shown DO NOT have exterior trim. Subtract 1/2" (12.7) from M.O. (Masonry Opening) for Unit Sizes. Masonry Openings above include Sill Nose, see Trim Options page for Sill Nose specifications. For other Trim Options refer to the Unit Sizing, Rough Opening & Masonry Openings page.

SCALE 1/4" = 1'

SWINGING PATIO DOOR EXTENDED LEG SEGMENT TOP UNITS

M.O. BRICKMOULD
M.O. ADAMS/FLAT CASING
ROUGH OPENING
FRAME SIZE
DAYLIGHT OPENING

69 1/2" (1765)
72 1/2" (1842)
66 3/4" (1695)
66" (1676)
62 3/8" (1584)

75 1/2" (1918)
78 1/2" (1994)
72 3/4" (1848)
72" (1829)
68 3/8" (1737)

84 5/8" (2149)
86 1/8" (2188)
83 1/16" (2110)
82 5/16" (2091)
78 11/16" (1999)

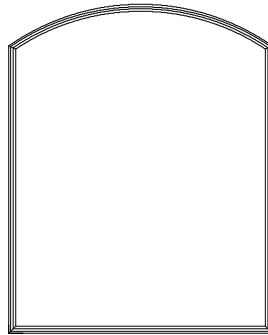

SDESC-56L60

83 7/16" (2119)
84 15/16" (2157)
80 7/8" (2054)
80 1/8" (2035)
76 1/2" (1943)

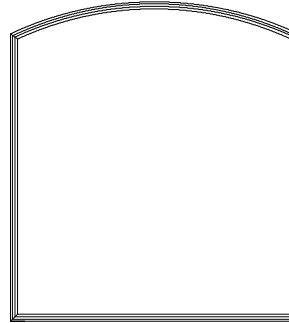

SDESC-60L60

ELEVATION SYMBOL LEGEND:

M.O. = MASONRY OPENING
VALUES IN () ARE IN MILLIMETER CONVERSIONS

Note: Elevations shown DO NOT have exterior trim. Subtract 1/2" (12.7) from M.O. (Masonry Opening) for Unit Sizes. Masonry Openings above include Sill Nose, see Trim Options page for Sill Nose specifications. For other Trim Options refer to the Unit Sizing, Rough Opening & Masonry Openings page.

300 SERIES SLIDING PATIO DOOR HALF ROUND UNITS

M.O. BRICKMOUND
M.O. ADAMS/FLAT CASING
ROUGH OPENING
FRAME SIZE
DAYLIGHT OPENING

36 1/4"(921)
39 1/4"(997)
33 1/2"(851)
32 3/4"(832)
29 1/8"(740)

42 1/4"(1073)
45 1/4"(1149)
39 1/2"(1003)
38 3/4"(984)
35 1/8"(892)

54 1/4"(1378)
57 1/4"(1454)
51 1/2"(1308)
50 3/4"(1289)
47 1/8"(1197)

63 1/2"(1613)
66 1/2"(1689)
60 3/4"(1543)
60"(1524)
56 3/8"(1432)

18 11/16"(475)
20 3/16"(513)
17 1/8"(435)
16 3/8"(416)
12 3/4"(324)



S3RTC-26

21 11/16"(561)
23 3/16"(599)
20 1/8"(511)
19 3/8"(492)
15 3/4"(400)

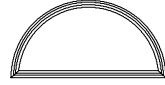

S3RTC-26

27 11/16"(703)
29 3/16"(741)
26 1/8"(664)
25 3/8"(645)
21 3/4"(552)

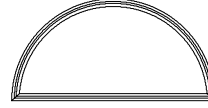

S3RTC-26

32 5/16"(821)
33 13/16"(859)
30 3/4"(781)
29 1/2"(762)
26 3/8"(670)

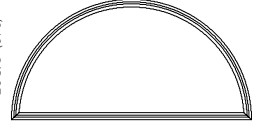

S3RTC-26

M.O. BRICKMOUND
M.O. ADAMS/FLAT CASING
ROUGH OPENING
FRAME SIZE
DAYLIGHT OPENING

75 1/2"(1918)
78 1/2"(1994)
72 3/4"(1848)
72"(1829)
68 3/8"(1737)

96 1/4"(2445)
99 1/4"(2521)
93 1/2"(2380)
92 3/4"(2356)
89 1/8"(2264)

38 5/16"(973)
39 13/16"(1011)
36 3/4"(933)
36"(914)
32 3/8"(822)

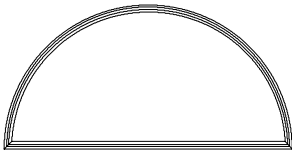

S3RTC-26

48 11/16"(1237)
50 3/16"(1275)
47 1/8"(1197)
46 3/8"(1178)
42 3/4"(1086)

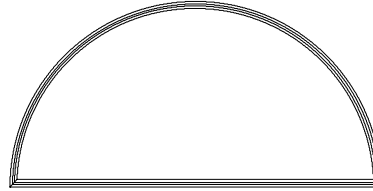

S3RTC-76

M.O. BRICKMOUND
M.O. ADAMS/FLAT CASING
ROUGH OPENING
FRAME SIZE
DAYLIGHT OPENING

99 1/2"(2527)
102 1/2"(2604)
96 3/4"(2457)
96"(2438)
92 3/8"(2346)

114 1/4"(2902)
117 1/4"(2978)
111 1/2"(2832)
110 3/4"(2813)
107 1/8"(2721)

50 5/16"(1278)
51 13/16"(1316)
48 3/4"(1238)
48"(1219)
44 3/8"(1127)

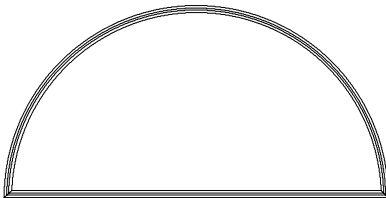

S3RTC-80

57 11/16"(1465)
59 3/16"(1503)
56 1/8"(1426)
55 3/8"(1407)
51 3/4"(1314)

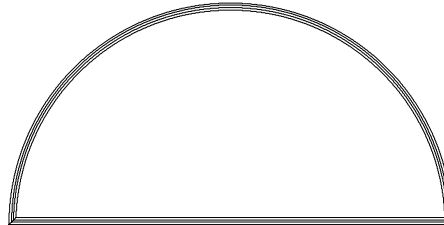

S3RTC-90

ELEVATION SYMBOL LEGEND:

M.O. = MASONRY OPENING
VALUES IN () ARE IN MILLIMETER CONVERSIONS

Note: Elevations shown DO NOT have exterior trim. Subtract 1/2" (12.7) from M.O. (Masonry Opening) for Unit Sizes. Masonry Openings above include Sill Nose, see Trim Options page for Sill Nose specifications. For other Trim Options refer to the Unit Sizing, Rough Opening & Masonry Openings page.

300 SERIES SLIDING PATIO DOOR EXTENDED HALF ROUND UNITS

M.O. BRICKMOULD
M.O. ADAMS/FLAT CASING
ROUGH OPENING
FRAME SIZE
DAYLIGHT OPENING

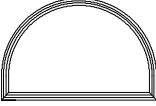
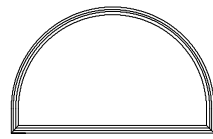
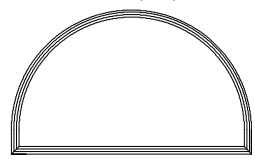
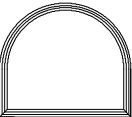
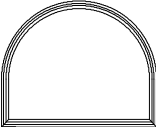
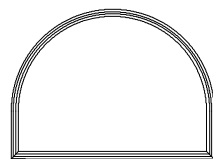
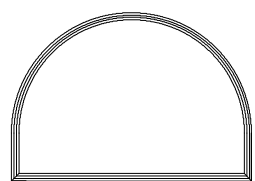
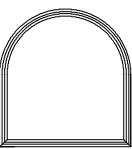
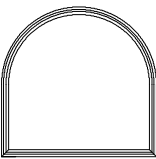
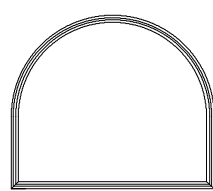
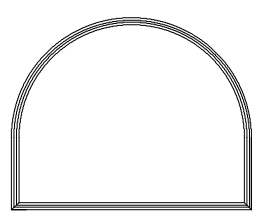
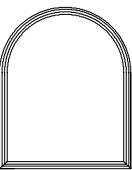
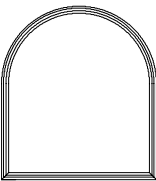
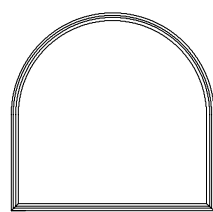
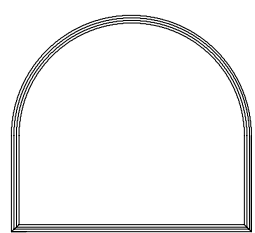
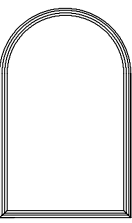
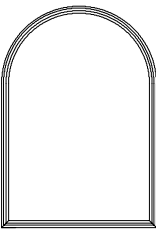
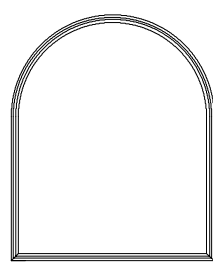
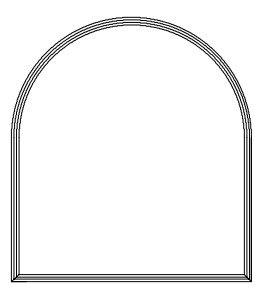
| | | | |
|---|---|--|---|
| <p>24 11/16" (627) 26 3/16" (665) 23 1/8" (587) 22 3/8" (568) 18 3/4" (476)</p>  <p>S3EHC-26L06</p> | <p>27 11/16" (703) 29 3/16" (741) 26 1/8" (664) 25 3/8" (645) 21 3/4" (552)</p>  <p>S3EHC-30L06</p> | <p>33 11/16" (856) 35 3/16" (894) 34 1/8" (816) 31 3/8" (797) 27 3/4" (705)</p>  <p>S3EHC-40L06</p> | <p>38 5/16" (973) 39 13/16" (1011) 36 3/4" (933) 36" (914) 32 3/8" (822)</p>  <p>S3EHC-50L06</p> |
| <p>30 11/16" (779) 32 3/16" (818) 29 1/8" (740) 28 3/8" (721) 24 3/4" (629)</p>  <p>S3EHC-26L10</p> | <p>33 11/16" (856) 35 3/16" (894) 32 1/8" (816) 31 3/8" (797) 27 3/4" (705)</p>  <p>S3EHC-30L10</p> | <p>39 11/16" (1008) 41 3/16" (1046) 39 1/8" (968) 37 3/8" (949) 33 3/4" (857)</p>  <p>S3EHC-40L10</p> | <p>44 5/16" (1126) 45 13/16" (1164) 42 3/4" (1086) 42" (1067) 38 3/8" (975)</p>  <p>S3EHC-50L10</p> |
| <p>36 11/16" (932) 38 3/16" (970) 35 1/8" (892) 34 3/8" (873) 30 3/4" (781)</p>  <p>S3EHC-26L16</p> | <p>39 11/16" (1008) 41 3/16" (1046) 38 1/8" (968) 37 3/8" (949) 33 3/4" (857)</p>  <p>S3EHC-30L16</p> | <p>45 11/16" (1160) 47 3/16" (1199) 45 1/8" (1121) 43 3/8" (1102) 39 3/4" (1010)</p>  <p>S3EHC-40L16</p> | <p>50 5/16" (1278) 51 13/16" (1316) 48 3/4" (1238) 48" (1219) 44 3/8" (1127)</p>  <p>S3EHC-50L16</p> |
| <p>42 11/16" (1084) 44 3/16" (1122) 41 1/8" (1045) 40 3/8" (1026) 36 3/4" (933)</p>  <p>S3EHC-26L20</p> | <p>45 11/16" (1160) 47 3/16" (1199) 44 1/8" (1121) 43 3/8" (1102) 39 3/4" (1010)</p>  <p>S3EHC-30L20</p> | <p>51 11/16" (1312) 53 3/16" (1351) 50 1/8" (1273) 48 3/8" (1254) 45 3/4" (1162)</p>  <p>S3EHC-40L20</p> | <p>56 5/16" (1430) 57 13/16" (1468) 54 3/4" (1391) 54" (1372) 50 3/8" (1280)</p>  <p>S3EHC-50L20</p> |
| <p>54 11/16" (1389) 56 3/16" (1427) 53 1/8" (1349) 52 3/8" (1330) 48 3/4" (1238)</p>  <p>S3EHC-26L30</p> | <p>57 11/16" (1465) 59 3/16" (1503) 56 1/8" (1426) 55 3/8" (1407) 51 3/4" (1314)</p>  <p>S3EHC-30L30</p> | <p>63 11/16" (1618) 65 3/16" (1656) 62 1/8" (1578) 60 3/8" (1559) 57 3/4" (1467)</p>  <p>S3EHC-40L30</p> | <p>68 5/16" (1735) 69 13/16" (1773) 66 3/4" (1695) 66" (1676) 62 3/8" (1584)</p>  <p>S3EHC-50L30</p> |

ELEVATION SYMBOL LEGEND:
M.O. = MASONRY OPENING
VALUES IN () ARE IN MILLIMETER CONVERSIONS

Note: Elevations shown DO NOT have exterior trim. Subtract 1/2" (12.7) from M.O. (Masonry Opening) for Unit Sizes. Masonry Openings above include Sill Nose, see Trim Options page for Sill Nose specifications. For other Trim Options refer to the Unit Sizing, Rough Opening & Masonry Openings page.

SCALE 1/4" = 1'

300 SERIES SLIDING PATIO DOOR EXTENDED HALF ROUND UNITS

M.O. BRICKMOLD
M.O. ADAMS/FLAT CASING
ROUGH OPENING
FRAME SIZE
DAYLIGHT OPENING

36 1/4" (921)
39 1/4" (997)
33 1/2" (851)
32 3/4" (832)
29 1/8" (740)

42 1/4" (1073)
45 1/4" (1149)
39 1/2" (1003)
38 3/4" (984)
35 1/8" (892)

54 1/4" (1378)
57 1/4" (1454)
51 1/2" (1308)
50 3/4" (1289)
47 1/8" (1197)

63 1/2" (1613)
66 1/2" (1689)
60 3/4" (1543)
60" (1524)
56 3/8" (1432)

66 11/16" (1694)
68 3/16" (1732)
65 1/8" (1654)
64 3/8" (1635)
60 3/4" (1543)

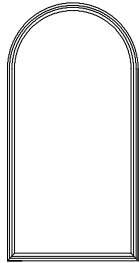

S3EHC-26L40

69 11/16" (1770)
71 3/16" (1808)
68 1/8" (1730)
67 3/8" (1711)
63 3/4" (1619)

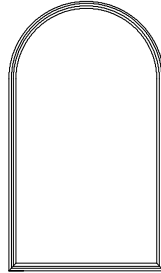

S3EHC-30L40

75 11/16" (1922)
77 3/16" (1961)
74 1/8" (1883)
73 3/8" (1864)
69 3/4" (1772)

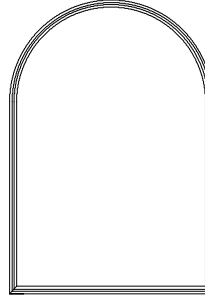

S3EHC-40L40

80 5/16" (2040)
81 13/16" (2078)
78 3/4" (2000)
78" (1981)
74 3/8" (1889)

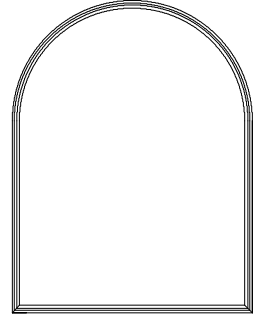

S3EHC-50L40

78 11/16" (1999)
80 3/16" (2037)
77 1/8" (1959)
76 3/8" (1940)
72 3/4" (1848)

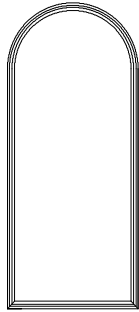

S3EHC-26L50

81 11/16" (2075)
83 3/16" (2113)
80 1/8" (2035)
79 3/8" (2016)
75 3/4" (1924)

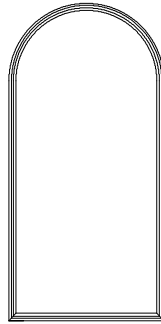

S3EHC-30L50

87 11/16" (2227)
89 3/16" (2265)
86 1/8" (2188)
85 3/8" (2169)
81 3/4" (2076)

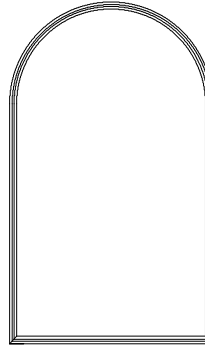

S3EHC-40L50

92 5/16" (2345)
93 13/16" (2383)
90 3/4" (2305)
90" (2286)
86 3/8" (2194)

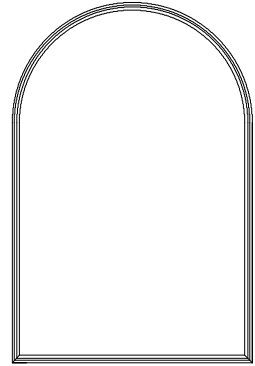

S3EHC-50L50

90 11/16" (2303)
92 3/16" (2342)
89 1/8" (2264)
88 3/8" (2245)
84 3/4" (2153)

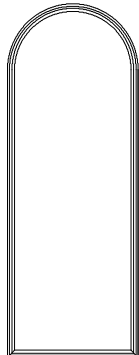

S3EHC-26L60

93 11/16" (2380)
95 3/16" (2418)
92 1/8" (2340)
91 3/8" (2321)
87 3/4" (2229)

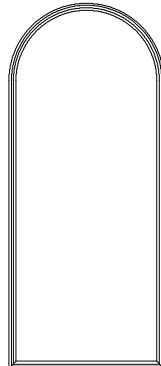

S3EHC-30L60

99 11/16" (2532)
101 3/16" (2570)
98 1/8" (2492)
97 3/8" (2473)
93 3/4" (2381)

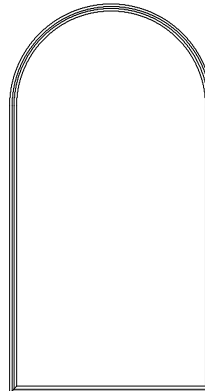

S3EHC-40L60

104 5/16" (2650)
105 13/16" (2688)
102 3/4" (2610)
102" (2591)
98 3/8" (2499)

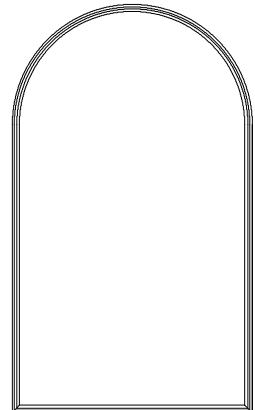

S3EHC-50L60

ELEVATION SYMBOL LEGEND:

M.O. = MASONRY OPENING
VALUES IN () ARE IN MILLIMETER CONVERSIONS

Note: Elevations shown DO NOT have exterior trim. Subtract 1/2" (12.7) from M.O. (Masonry Opening) for Unit Sizes. Masonry Openings above include Sill Nose, see Trim Options page for Sill Nose specifications. For other Trim Options refer to the Unit Sizing, Rough Opening & Masonry Openings page.

SCALE 1/4" = 1'

300 SERIES SLIDING PATIO DOOR EXTENDED HALF ROUND UNITS

M.O. BRICKMOULD
M.O. ADAMS/FLAT CASING
ROUGH OPENING
FRAME SIZE
DAYLIGHT OPENING

75 1/2" (1918)
78 1/2" (1994)
72 3/4" (1848)
72" (1829)
68 3/8" (1737)

44 5/16" (1126)
45 13/16" (1164)
42 3/4" (1086)
42" (1067)
38 3/8" (975)

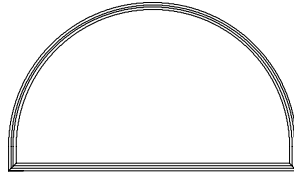

S3EHC-60L06

50 5/16" (1278)
51 13/16" (1316)
48 3/4" (1238)
48" (1219)
44 3/8" (1127)

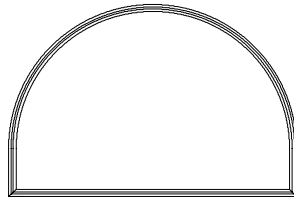

S3EHC-60L10

56 5/16" (1430)
57 13/16" (1468)
54 3/4" (1391)
54" (1372)
50 3/8" (1280)

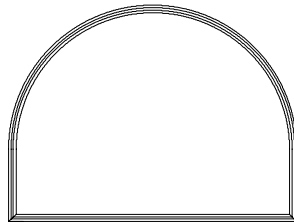

S3EHC-60L16

62 5/16" (1583)
63 13/16" (1621)
60 3/4" (1543)
60" (1524)
56 3/8" (1432)

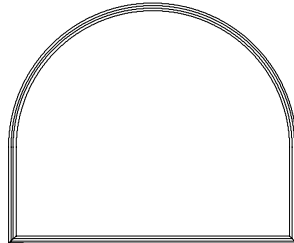

S3EHC-60L20

74 5/16" (1888)
75 13/16" (1926)
72 3/4" (1848)
72" (1829)
68 3/8" (1737)

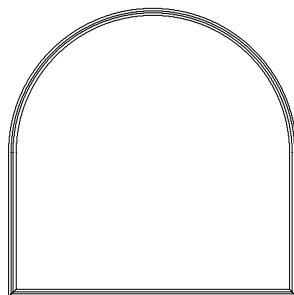

S3EHC-60L30

M.O. BRICKMOULD
M.O. ADAMS/FLAT CASING
ROUGH OPENING
FRAME SIZE
DAYLIGHT OPENING

75 1/2" (1918)
78 1/2" (1994)
72 3/4" (1848)
72" (1829)
68 3/8" (1737)

86 5/16" (2192)
87 13/16" (2230)
84 3/4" (2153)
84" (2134)
80 3/8" (2042)

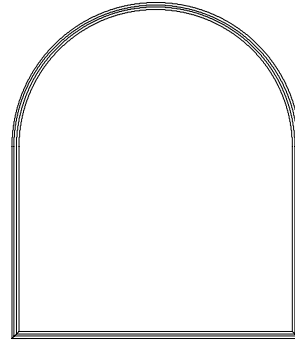

S3EHC-60L40

98 5/16" (2497)
99 13/16" (2535)
96 3/4" (2457)
96" (2438)
92 3/8" (2346)

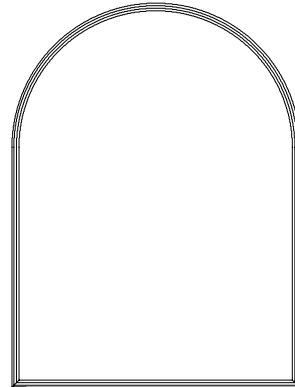

S3EHC-60L50

ELEVATION SYMBOL LEGEND:
M.O. = MASONRY OPENING
VALUES IN () ARE IN MILLIMETER CONVERSIONS

Note: Elevations shown DO NOT have exterior trim. Subtract 1/2" (12.7) from M.O. (Masonry Opening) for Unit Sizes. Masonry Openings above include Sill Nose, see Trim Options page for Sill Nose specifications. For other Trim Options refer to the Unit Sizing, Rough Opening & Masonry Openings page.

SCALE 1/4" = 1'

300 SERIES SLIDING PATIO DOOR EXTENDED LEG SEGMENT TOP UNITS

M.O. BRICKMOULD
M.O. ADAMS/FLAT CASING
ROUGH OPENING
FRAME SIZE
DAYLIGHT OPENING

36 1/4" (921)
39 1/4" (997)
33 1/2" (851)
32 3/4" (832)
29 1/8" (740)

42 1/4" (1073)
45 1/4" (1149)
39 1/2" (1003)
38 3/4" (984)
35 1/8" (892)

54 1/4" (1378)
57 1/4" (1454)
51 1/2" (1308)
50 3/4" (1289)
47 1/8" (1197)

63 1/2" (1613)
66 1/2" (1689)
60 3/4" (1543)
60" (1524)
56 3/8" (1432)



S3ESC-26L06



S3ESC-30L06

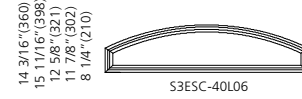

S3ESC-40L06



S3ESC-50L06

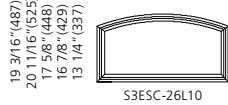

S3ESC-26L10

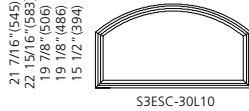

S3ESC-30L10

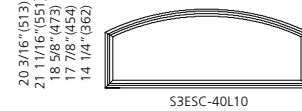

S3ESC-40L10

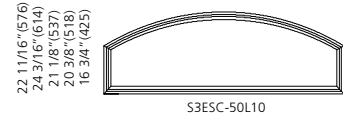

S3ESC-50L10

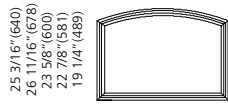

S3ESC-26L16

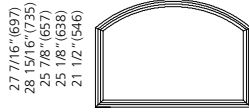

S3ESC-30L16

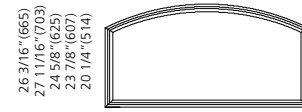

S3ESC-40L16

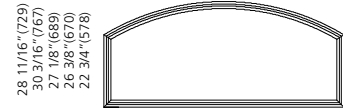

S3ESC-50L16

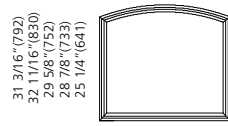

S3ESC-26L20

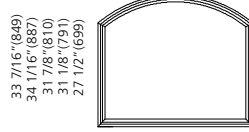

S3ESC-30L20

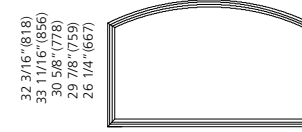

S3ESC-40L20

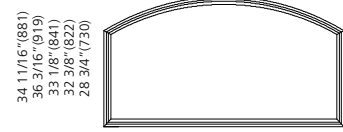

S3ESC-50L20

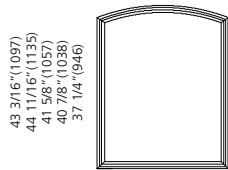

S3ESC-26L30

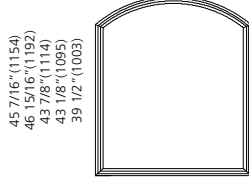

S3ESC-30L30

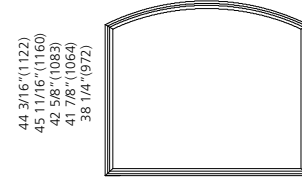

S3ESC-40L30

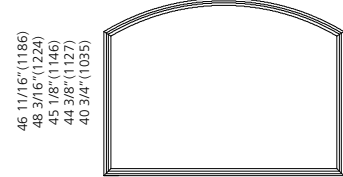

S3ESC-50L30

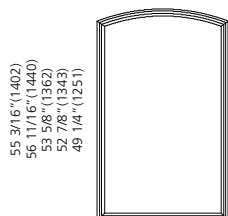

S3ESC-26L40

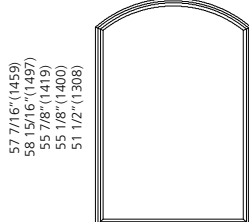

S3ESC-30L40

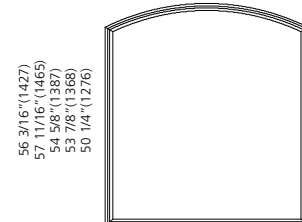

S3ESC-40L40

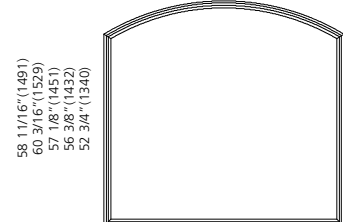

S3ESC-50L40

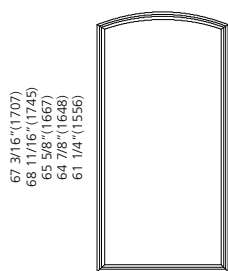

S3ESC-26L50

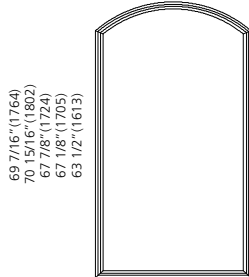

S3ESC-30L50

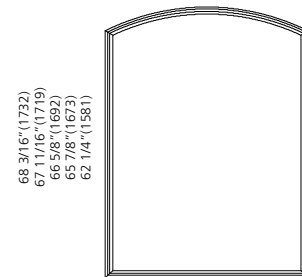

S3ESC-40L50

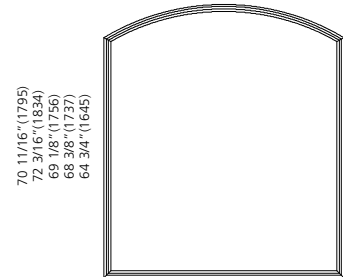

S3ESC-50L50

ELEVATION SYMBOL LEGEND:
M.O. = MASONRY OPENING
VALUES IN () ARE IN MILLIMETER CONVERSIONS

Note: Elevations shown DO NOT have exterior trim. Subtract 1/2" (12.7) from M.O. (Masonry Opening) for Unit Sizes. Masonry Openings above include Sill Nose, see Trim Options page for Sill Nose specifications. For other Trim Options refer to the Unit Sizing, Rough Opening & Masonry Openings page.

SCALE 1/4" = 1'

300 SERIES SLIDING PATIO DOOR EXTENDED LEG SEGMENT TOP UNITS

| | |
|-------------------------------|---------------|
| M.O. BRICKMOULD | 36 1/4" (921) |
| M.O. ADAMS/FLAT CASING | 39 1/4" (997) |
| ROUGH OPENING | 33 1/2" (851) |
| FRAME SIZE | 32 3/4" (832) |
| DAYLIGHT OPENING | 29 1/8" (740) |

| |
|----------------|
| 42 1/4" (1073) |
| 45 1/4" (1149) |
| 39 1/2" (1003) |
| 38 3/4" (984) |
| 35 1/8" (892) |

| |
|----------------|
| 54 1/4" (1378) |
| 57 1/4" (1454) |
| 51 1/2" (1308) |
| 50 3/4" (1289) |
| 47 1/8" (1197) |

| |
|----------------|
| 63 1/2" (1613) |
| 66 1/2" (1689) |
| 60 3/4" (1543) |
| 60" (1524) |
| 56 3/8" (1432) |

79 3/16" (2011)
80 11/16" (2049)
77 5/8" (1972)
76 7/8" (1953)
73 1/4" (1861)

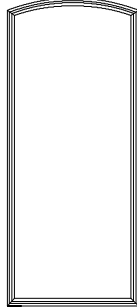

S3ESC-26L60

81 7/16" (2069)
82 15/16" (2107)
79 7/8" (2029)
79 1/8" (2010)
75 1/2" (1918)

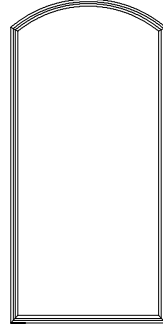

S3ESC-30L60

80 3/16" (2037)
81 11/16" (2075)
78 5/8" (1997)
77 7/8" (1978)
74 1/4" (1886)

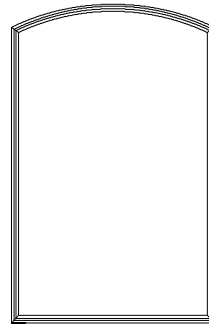

S3ESC-40L60

82 11/16" (2100)
84 3/16" (2138)
81 1/8" (2061)
80 3/8" (2042)
76 3/4" (1949)

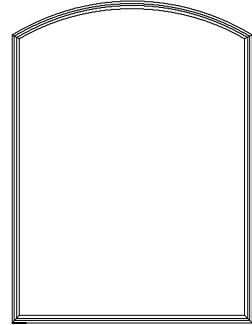

S3ESC-50L60

ELEVATION SYMBOL LEGEND:

M.O. = MASONRY OPENING
VALUES IN () ARE IN MILLIMETER CONVERSIONS

Note: Elevations shown DO NOT have exterior trim. Subtract 1/2" (12.7) from M.O. (Masonry Opening) for Unit Sizes. Masonry Openings above include Sill Nose, see Trim Options page for Sill Nose specifications. For other Trim Options refer to the Unit Sizing, Rough Opening & Masonry Openings page.

300 SERIES SLIDING PATIO DOOR EXTENDED LEG SEGMENT TOP UNITS

M.O. BRICKMOULD
M.O. ADAMS/FLAT CASING
ROUGH OPENING
FRAME SIZE
DAYLIGHT OPENING

75 1/2"(1918)
78 1/2"(1994)
72 3/4"(1848)
72"(1829)
68 3/8"(1737)

M.O. BRICKMOULD
M.O. ADAMS/FLAT CASING
ROUGH OPENING
FRAME SIZE
DAYLIGHT OPENING

75 1/2"(1918)
78 1/2"(1994)
72 3/4"(1848)
72"(1829)
68 3/8"(1737)

16 7/16"(418)
17 15/16"(455)
14 7/8"(378)
14 1/8"(359)
10 1/2"(267)



S3ESC-60L06

22 7/16"(570)
23 15/16"(608)
20 7/8"(530)
20 1/8"(511)
16 1/2"(419)



S3ESC-60L10

28 7/16"(722)
29 15/16"(760)
26 7/8"(683)
26 1/8"(664)
22 1/2"(572)



S3ESC-60L16

34 7/16"(875)
35 15/16"(913)
32 7/8"(835)
32 1/8"(816)
28 1/2"(724)

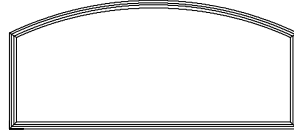

S3ESC-60L20

46 7/16"(1180)
47 15/16"(1217)
44 7/8"(1140)
44 1/8"(1121)
40 1/2"(1029)

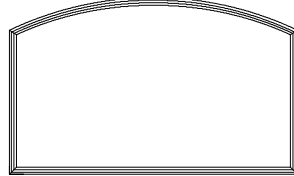

S3ESC-60L30

58 7/16"(1484)
59 15/16"(1522)
56 7/8"(1445)
56 1/8"(1426)
52 1/2"(1334)

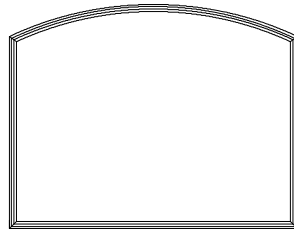

S3ESC-60L40

70 7/16"(1789)
71 15/16"(1827)
68 7/8"(1749)
68 1/8"(1730)
64 1/2"(1638)

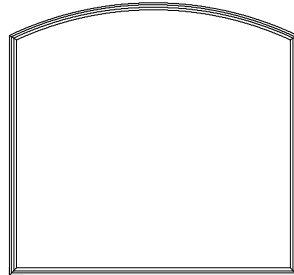

S3ESC-60L50

82 7/16"(2094)
83 15/16"(2132)
80 7/8"(2054)
80 1/8"(2035)
76 1/2"(1943)

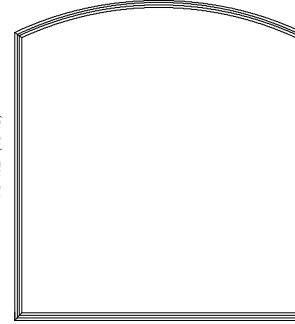

S3ESC-60L60

ELEVATION SYMBOL LEGEND:
M.O. = MASONRY OPENING
VALUES IN () ARE IN MILLIMETER CONVERSIONS

Note: Elevations shown DO NOT have exterior trim. Subtract 1/2" (12.7) from M.O. (Masonry Opening) for Unit Sizes. Masonry Openings above include Sill Nose, see Trim Options page for Sill Nose specifications. For other Trim Options refer to the Unit Sizing, Rough Opening & Masonry Openings page.

SCALE 1/4" = 1'

400 SERIES SLIDING PATIO DOOR HALF ROUND UNITS

M.O. BRICKMOULD
M.O. ADAMS/FLAT CASING
ROUGH OPENING
FRAME SIZE
DAYLIGHT OPENING

36 15/16" (938)
39 15/16" (1014)
34 3/16" (868)
33 7/16" (849)
29 13/16" (757)

42 15/16" (1091)
45 15/16" (1169)
40 3/16" (1021)
39 7/16" (1002)
35 13/16" (910)

54 15/16" (1395)
57 15/16" (1471)
52 3/16" (1326)
51 7/16" (1306)
47 13/16" (1214)

63 1/2" (1613)
66 1/2" (1689)
60 3/4" (1543)
60" (1524)
56 3/8" (1432)

19 1/16" (484)
20 9/16" (522)
17 1/2" (445)
16 3/4" (423)
13 1/8" (333)



S4RTC-26

22 1/16" (560)
23 9/16" (598)
20 1/2" (521)
19 3/4" (502)
16 1/8" (410)



S4RTC-30

28 1/16" (713)
29 9/16" (751)
26 1/2" (673)
25 3/4" (654)
22 1/8" (562)

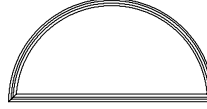

S4RTC-40

32 5/16" (821)
33 13/16" (859)
30 3/4" (781)
30" (762)
26 3/8" (670)

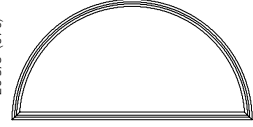

S4RTC-50

M.O. BRICKMOULD
M.O. ADAMS/FLAT CASING
ROUGH OPENING
FRAME SIZE
DAYLIGHT OPENING

75 1/2" (1918)
78 1/2" (1994)
72 3/4" (1848)
72" (1829)
68 3/8" (1737)

96 15/16" (2462)
99 15/16" (2538)
94 3/16" (2392)
93 7/16" (2373)
89 13/16" (2281)

38 5/16" (973)
39 13/16" (1011)
36 3/4" (933)
36" (914)
32 3/8" (822)

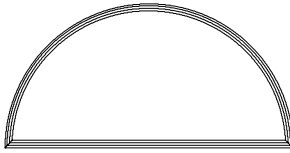

S4RTC-60

49 1/16" (1246)
50 9/16" (1284)
47 1/2" (1207)
46 3/4" (1187)
43 1/8" (1095)

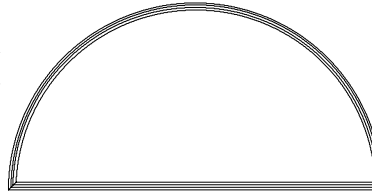

S4RTC-76

M.O. BRICKMOULD
M.O. ADAMS/FLAT CASING
ROUGH OPENING
FRAME SIZE
DAYLIGHT OPENING

99 1/2" (2527)
102 1/2" (2604)
96 3/4" (2457)
96" (2438)
92 3/8" (2346)

114 15/16" (2919)
117 15/16" (2996)
112 3/16" (2850)
111 7/16" (2831)
107 13/16" (2738)

50 5/16" (1278)
51 13/16" (1316)
48 3/4" (1238)
48" (1219)
44 3/8" (1127)

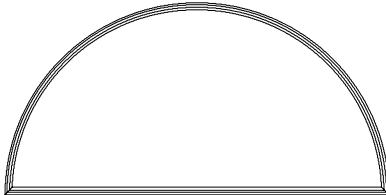

S4RTC-80

58 1/16" (1475)
59 9/16" (1513)
56 3/4" (1435)
55 3/8" (1416)
52 1/8" (1324)

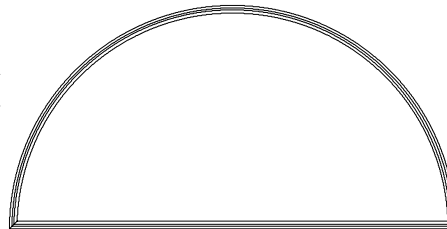

S4RTC-90

ELEVATION SYMBOL LEGEND:

M.O. = MASONRY OPENING
VALUES IN () ARE IN MILLIMETER CONVERSIONS

Note: Elevations shown DO NOT have exterior trim. Subtract 1/2" (12.7) from M.O. (Masonry Opening) for Unit Sizes. Masonry Openings above include Sill Nose, see Trim Options page for Sill Nose specifications. For other Trim Options refer to the Unit Sizing, Rough Opening & Masonry Openings page.

400 SERIES SLIDING PATIO DOOR EXTENDED HALF ROUND UNITS

M.O. BRICKMOUND
M.O. ADAMS/FLAT CASING
ROUGH OPENING
FRAME SIZE
DAYLIGHT OPENING

36 15/16" (938)
39 15/16" (1014)
34 3/16" (868)
33 7/16" (849)
29 13/16" (757)

42 15/16" (1091)
45 15/16" (1169)
40 3/16" (1021)
39 7/16" (1002)
35 13/16" (910)

54 15/16" (1395)
57 15/16" (1471)
52 3/16" (1326)
51 7/16" (1306)
47 13/16" (1214)

63 1/2" (1613)
66 1/2" (1689)
60 3/4" (1543)
60" (1524)
56 3/8" (1432)

25 1/16" (637)
26 9/16" (672)
23 1/2" (597)
22 3/4" (578)
19 1/8" (486)

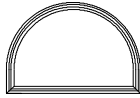

S4EHC-26L06

28 1/16" (713)
29 9/16" (751)
26 1/2" (673)
25 3/4" (654)
22 1/8" (562)



S4EHC-30L06

34 1/16" (865)
35 9/16" (903)
32 1/2" (826)
31 3/4" (806)
28 1/8" (714)

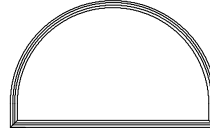

S4EHC-40L06

38 5/16" (973)
39 13/16" (1011)
36 3/4" (933)
36" (914)
32 3/8" (822)

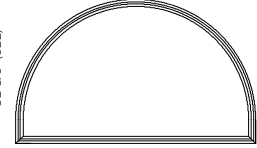

S4EHC-50L06

31 1/16" (789)
32 9/16" (827)
29 1/2" (749)
28 3/4" (730)
25 1/8" (638)

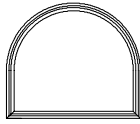

S4EHC-26L10

34 1/16" (865)
35 9/16" (903)
32 1/2" (826)
31 3/4" (806)
28 1/8" (714)

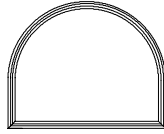

S4EHC-30L10

40 1/16" (1018)
41 9/16" (1056)
38 1/2" (978)
37 3/4" (959)
34 1/8" (867)

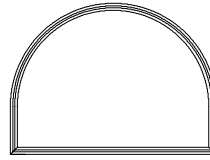

S4EHC-40L10

44 5/16" (1126)
45 13/16" (1164)
42 3/4" (1086)
42" (1067)
38 3/8" (975)

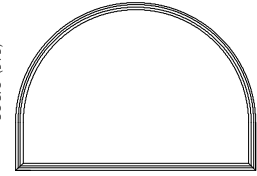

S4EHC-50L10

37 1/16" (941)
38 9/16" (979)
35 1/2" (902)
34 3/4" (883)
31 1/8" (791)

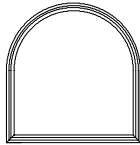

S4EHC-26L16

40 1/16" (1018)
41 9/16" (1056)
38 1/2" (978)
37 3/4" (959)
34 1/8" (867)

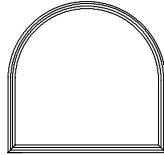

S4EHC-30L16

46 1/16" (1170)
47 9/16" (1208)
44 1/2" (1130)
43 3/4" (1111)
40 1/8" (1019)

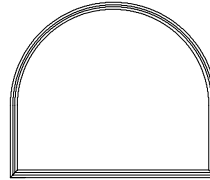

S4EHC-40L16

50 5/16" (1278)
51 13/16" (1316)
48 3/4" (1238)
48" (1219)
44 3/8" (1127)

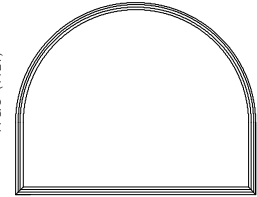

S4EHC-50L16

43 1/16" (1094)
44 9/16" (1132)
41 1/2" (1054)
40 3/4" (1035)
37 1/8" (943)

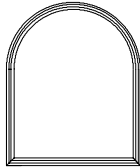

S4EHC-26L20

46 1/16" (1170)
47 9/16" (1208)
44 1/2" (1130)
43 3/4" (1111)
40 1/8" (1019)

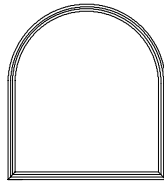

S4EHC-30L20

52 1/16" (1322)
53 9/16" (1360)
50 1/2" (1283)
49 3/4" (1264)
46 1/8" (1172)

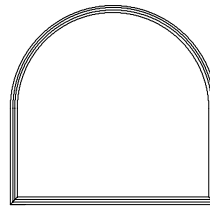

S4EHC-40L20

56 5/16" (1430)
57 13/16" (1468)
54 3/4" (1391)
54" (1372)
50 3/8" (1280)

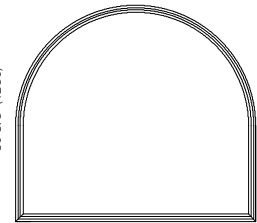

S4EHC-50L20

55 1/16" (1399)
56 9/16" (1437)
53 1/2" (1359)
52 3/4" (1340)
49 1/8" (1248)

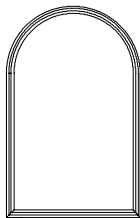

S4EHC-26L30

58 1/16" (1475)
59 9/16" (1513)
56 1/2" (1435)
55 3/4" (1416)
52 1/8" (1324)

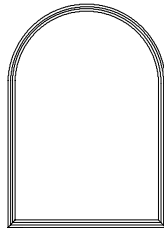

S4EHC-30L30

64 1/16" (1627)
65 9/16" (1665)
62 1/2" (1588)
61 3/4" (1568)
58 1/8" (1476)

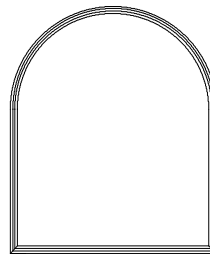

S4EHC-40L30

68 5/16" (1735)
69 13/16" (1773)
66 3/4" (1695)
66" (1676)
62 3/8" (1584)

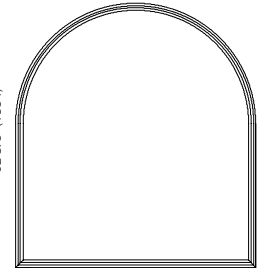

S4EHC-50L30

ELEVATION SYMBOL LEGEND:

M.O. = MASONRY OPENING
VALUES IN () ARE IN MILLIMETER CONVERSIONS

Note: Elevations shown DO NOT have exterior trim. Subtract 1/2" (12.7) from M.O. (Masonry Opening) for Unit Sizes. Masonry Openings above include Sill Nose, see Trim Options page for Sill Nose specifications. For other Trim Options refer to the Unit Sizing, Rough Opening & Masonry Openings page.

SCALE 1/4" = 1'

400 SERIES SLIDING PATIO DOOR EXTENDED HALF ROUND UNITS

M.O. BRICKMOULD
M.O. ADAMS/FLAT CASING
ROUGH OPENING
FRAME SIZE
DAYLIGHT OPENING

36 15/16" (938)
 39 15/16" (1014)
 34 3/16" (868)
 33 7/16" (849)
 29 13/16" (757)

42 15/16" (1091)
 45 15/16" (1169)
 40 3/16" (1021)
 39 7/16" (1002)
 35 13/16" (910)

54 15/16" (1395)
 57 15/16" (1472)
 52 3/16" (1326)
 51 7/16" (1307)
 47 13/16" (1214)

63 1/2" (1613)
 66 1/2" (1689)
 60 3/4" (1543)
 60" (1524)
 56 3/8" (1432)

67 1/16" (1703)
 68 9/16" (1741)
 65 1/2" (1664)
 64 3/4" (1645)
 61 1/8" (1553)

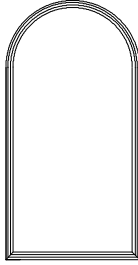

S4EHC-26L40

70 1/16" (1780)
 71 9/16" (1818)
 68 1/2" (1740)
 67 3/4" (1721)
 64 1/8" (1629)

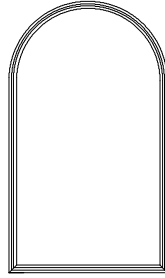

S4EHC-30L40

76 1/16" (1932)
 77 9/16" (1970)
 74 1/2" (1892)
 73 3/4" (1873)
 70 1/8" (1781)

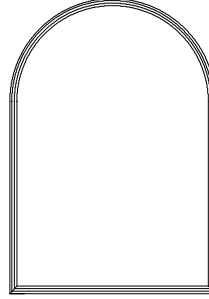

S4EHC-40L40

80 5/16" (2040)
 81 13/16" (2078)
 78 3/4" (2000)
 78" (1981)
 74 3/8" (1889)

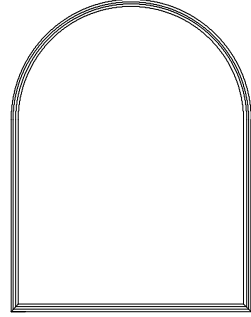

S4EHC-50L40

79 1/16" (2008)
 80 9/16" (2046)
 77 1/2" (1969)
 76 3/4" (1949)
 73 1/8" (1857)

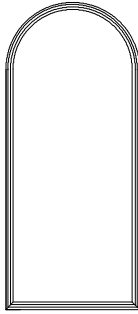

S4EHC-26L50

82 1/16" (2084)
 83 9/16" (2122)
 80 1/2" (2045)
 79 3/4" (2026)
 76 1/8" (1934)

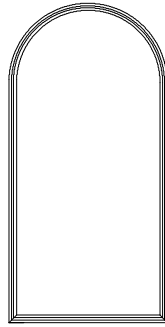

S4EHC-30L50

88 1/16" (2237)
 89 9/16" (2275)
 86 1/2" (2197)
 85 3/4" (2178)
 82 1/8" (2086)

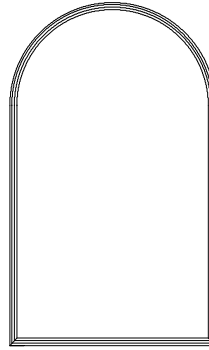

S4EHC-40L50

92 5/16" (2345)
 93 13/16" (2383)
 90 3/4" (2305)
 90" (2286)
 86 3/8" (2194)

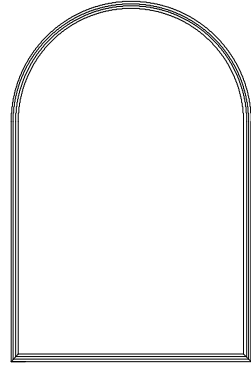

S4EHC-50L50

91 1/16" (2313)
 92 9/16" (2351)
 89 1/2" (2273)
 88 3/4" (2254)
 85 1/8" (2162)

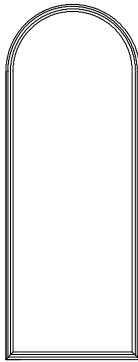

S4EHC-26L60

94 1/16" (2389)
 95 9/16" (2427)
 92 1/2" (2350)
 91 3/4" (2330)
 88 1/8" (2238)

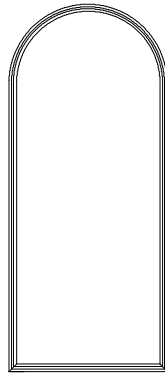

S4EHC-30L60

100 1/16" (2542)
 101 9/16" (2580)
 98 1/2" (2502)
 97 3/4" (2483)
 94 1/8" (2391)

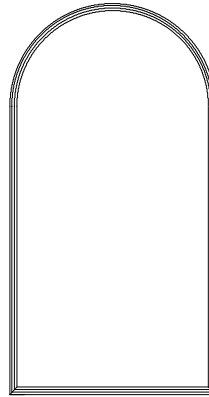

S4EHC-40L60

104 5/16" (2650)
 105 13/16" (2688)
 102 3/4" (2610)
 102" (2591)
 98 3/8" (2499)

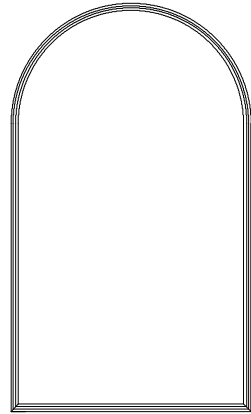

S4EHC-50L60

ELEVATION SYMBOL LEGEND:

M.O. = MASONRY OPENING
 VALUES IN () ARE IN MILLIMETER CONVERSIONS

Note: Elevations shown DO NOT have exterior trim. Subtract 1/2" (12.7) from M.O. (Masonry Opening) for Unit Sizes. Masonry Openings above include Sill Nose, see Trim Options page for Sill Nose specifications. For other Trim Options refer to the Unit Sizing, Rough Opening & Masonry Openings page.

SCALE 1/4" = 1'

400 SERIES SLIDING PATIO DOOR EXTENDED HALF ROUND UNITS

M.O. BRICKMOULD
M.O. ADAMS/FLAT CASING
ROUGH OPENING
FRAME SIZE
DAYLIGHT OPENING

75 1/2" (1918)
78 1/2" (1994)
72 3/4" (1848)
72" (1829)
68 3/8" (1737)

44 5/16" (1126)
45 13/16" (1164)
42 3/4" (1086)
42" (1067)
38 3/8" (975)

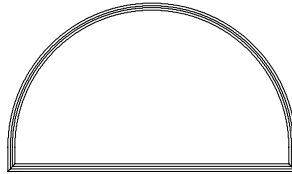

S4EHC-60L06

50 5/16" (1278)
51 13/16" (1316)
48 3/4" (1238)
48" (1219)
44 3/8" (1127)

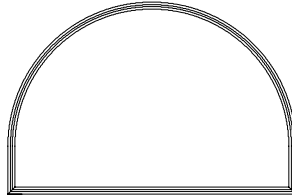

S4EHC-60L10

56 5/16" (1430)
57 13/16" (1468)
54 3/4" (1391)
54" (1372)
50 3/8" (1280)

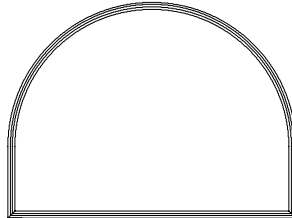

S4EHC-60L16

62 5/16" (1583)
63 13/16" (1621)
60 3/4" (1543)
60" (1524)
56 3/8" (1432)

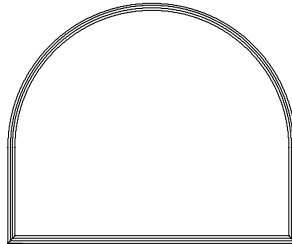

S4EHC-60L20

74 5/16" (1888)
75 13/16" (1926)
72 3/4" (1848)
72" (1829)
68 3/8" (1737)

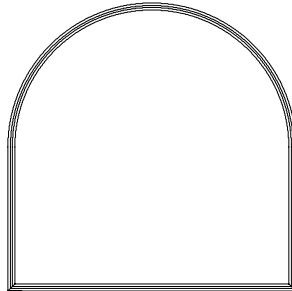

S4EHC-60L30

M.O. BRICKMOULD
M.O. ADAMS/FLAT CASING
ROUGH OPENING
FRAME SIZE
DAYLIGHT OPENING

75 1/2" (1918)
78 1/2" (1994)
72 3/4" (1848)
72" (1829)
68 3/8" (1737)

86 5/16" (2192)
87 13/16" (2230)
84 3/4" (2153)
84" (2134)
80 3/8" (2042)

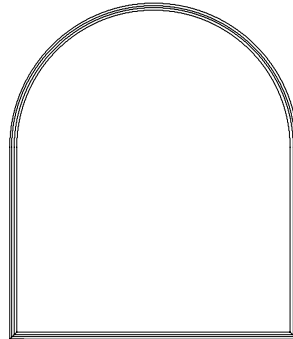

S4EHC-60L40

98 5/16" (2497)
99 13/16" (2535)
96 3/4" (2457)
96" (2438)
92 3/8" (2346)

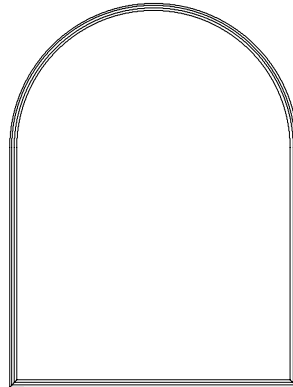

S4EHC-60L50

ELEVATION SYMBOL LEGEND:
M.O. = MASONRY OPENING
VALUES IN () ARE IN MILLIMETER CONVERSIONS

Note: Elevations shown DO NOT have exterior trim. Subtract 1/2" (12.7) from M.O. (Masonry Opening) for Unit Sizes. Masonry Openings above include Sill Nose, see Trim Options page for Sill Nose specifications. For other Trim Options refer to the Unit Sizing, Rough Opening & Masonry Openings page.

SCALE 1/4" = 1'

400 SERIES SLIDING PATIO DOOR EXTENDED LEG SEGMENT TOP UNITS

M.O. BRICKMOULD
M.O. ADAMS/FLAT CASING
ROUGH OPENING
FRAME SIZE
DAYLIGHT OPENING

| | | | | |
|--|--|---|--|--|
| 13 3/8" (340) 14 7/8" (378) 11 13/16" (300) 11 1/16" (281) 7 7/16" (189) | 36 15/16" (938) 39 15/16" (1014) 34 3/16" (868) 33 7/16" (849) 29 13/16" (757) | 42 15/16" (1091) 45 15/16" (1169) 40 3/16" (1021) 39 7/16" (1002) 35 13/16" (910) | 54 15/16" (1395) 57 15/16" (1471) 52 3/16" (1326) 51 7/16" (1306) 47 13/16" (1214) | 63 1/2" (1613) 66 1/2" (1689) 60 3/4" (1543) 60" (1524) 56 3/8" (1432) |
| S4ESC-26L06 | S4ESC-30L06 | S4ESC-40L06 | S4ESC-50L06 | |
| 19 3/8" (492) 20 7/8" (530) 17 13/16" (452) 17 1/16" (433) 13 7/16" (341) | 15 11/16" (398) 17 3/16" (437) 14 1/8" (359) 13 3/8" (340) 9 3/4" (248) | 21 11/16" (551) 23 3/16" (589) 20 1/8" (511) 19 3/8" (492) 15 3/4" (400) | 20 5/16" (515) 21 13/16" (554) 18 3/4" (476) 18" (457) 14 3/8" (365) | 16 11/16" (424) 18 3/16" (462) 24 3/16" (614) 21 1/8" (537) 15 1/8" (384) 20 3/8" (518) 14 3/8" (365) 10 3/4" (273) |
| S4ESC-26L10 | S4ESC-30L10 | S4ESC-40L10 | S4ESC-50L10 | |
| 25 3/8" (645) 26 7/8" (683) 23 13/16" (605) 23 1/16" (586) 19 7/16" (494) | 27 11/16" (703) 29 3/16" (741) 26 1/8" (664) 25 3/8" (645) 21 3/4" (552) | 26 5/16" (668) 27 13/16" (706) 24 3/4" (629) 24" (610) 20 3/8" (518) | 28 11/16" (729) 30 3/16" (767) 27 1/8" (689) 26 3/8" (670) 22 3/4" (578) | |
| S4ESC-26L16 | S4ESC-30L16 | S4ESC-40L16 | S4ESC-50L16 | |
| 31 3/8" (797) 32 7/8" (835) 29 13/16" (757) 29 1/16" (738) 25 7/16" (646) | 33 11/16" (856) 35 3/16" (894) 32 1/8" (816) 31 3/8" (797) 27 3/4" (705) | 32 5/16" (821) 33 13/16" (859) 30 3/4" (781) 30" (610) 26 3/8" (670) | 34 11/16" (881) 36 3/16" (919) 33 1/8" (841) 32 3/8" (822) 28 3/4" (730) | |
| S4ESC-26L20 | S4ESC-30L20 | S4ESC-40L20 | S4ESC-50L20 | |
| 43 3/8" (1102) 44 7/8" (1140) 41 13/16" (1062) 41 1/16" (1043) 37 7/16" (951) | 45 11/16" (1160) 47 3/16" (1199) 44 1/8" (1121) 43 3/8" (1102) 39 3/4" (1010) | 44 5/16" (1126) 45 13/16" (1164) 42 3/4" (1086) 42" (1067) 38 3/8" (975) | 46 11/16" (1186) 48 3/16" (1224) 45 1/8" (1146) 44 3/8" (1127) 40 3/4" (1035) | |
| S4ESC-26L30 | S4ESC-30L30 | S4ESC-40L30 | S4ESC-50L30 | |
| 55 3/8" (1407) 56 7/8" (1445) 53 13/16" (1367) 53 1/16" (1348) 49 7/16" (1256) | 57 11/16" (1465) 59 3/16" (1503) 56 1/8" (1426) 55 3/8" (1407) 51 3/4" (1314) | 56 5/16" (1430) 57 13/16" (1468) 54 3/4" (1391) 54" (1372) 50 3/8" (1280) | 58 11/16" (1491) 60 3/16" (1529) 57 1/8" (1451) 56 3/8" (1432) 52 3/4" (1340) | |
| S4ESC-26L40 | S4ESC-30L40 | S4ESC-40L40 | S4ESC-50L40 | |
| 67 3/8" (1711) 68 7/8" (1749) 65 13/16" (1672) 65 1/16" (1653) 61 7/16" (1561) | 69 11/16" (1770) 71 3/16" (1808) 68 1/8" (1730) 67 3/8" (1711) 63 3/4" (1619) | 68 5/16" (1735) 69 13/16" (1773) 66 3/4" (1695) 66" (1676) 62 3/8" (1584) | 70 11/16" (1795) 72 3/16" (1834) 69 1/8" (1756) 68 3/8" (1737) 64 3/4" (1645) | |
| S4ESC-26L50 | S4ESC-30L50 | S4ESC-40L50 | S4ESC-50L50 | |

ELEVATION SYMBOL LEGEND:
M.O. = MASONRY OPENING
VALUES IN () ARE IN MILLIMETER CONVERSIONS

Note: Elevations shown DO NOT have exterior trim. Subtract 1/2" (12.7) from M.O. (Masonry Opening) for Unit Sizes. Masonry Openings above include Sill Nose, see Trim Options page for Sill Nose specifications. For other Trim Options refer to the Unit Sizing, Rough Opening & Masonry Openings page.

SCALE 1/4" = 1'

400 SERIES SLIDING PATIO DOOR EXTENDED LEG SEGMENT TOP UNITS

M.O. BRICKMOUND 36 15/16" (938)
M.O. ADAMS/FLAT CASING 39 15/16" (1014)
ROUGH OPENING 34 3/16" (868)
FRAME SIZE 33 7/16" (849)
DAYLIGHT OPENING 29 13/16" (757)

42 15/16" (1091)
 45 15/16" (1169)
 40 3/16" (1021)
 39 7/16" (1002)
 35 13/16" (910)

54 15/16" (1395)
 57 15/16" (1471)
 52 3/16" (1326)
 51 7/16" (1306)
 47 13/16" (1214)

63 1/2" (1613)
 66 1/2" (1689)
 60 3/4" (1543)
 60" (1524)
 56 3/8" (1432)

79 3/8" (2016)
 80 7/8" (2054)
 77 13/16" (1976)
 77 1/16" (1957)
 73 7/16" (1865)

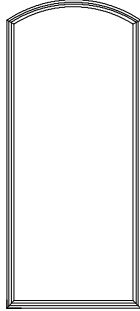

S4ESC-26L60

81 11/16" (2075)
 83 3/16" (2113)
 80 1/8" (2035)
 79 3/8" (2016)
 75 3/4" (1924)

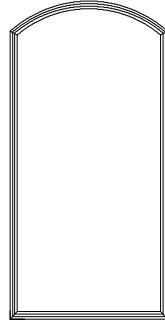

S4ESC-30L60

80 5/16" (2040)
 81 13/16" (2078)
 78 3/4" (2000)
 78" (1981)
 74 3/8" (1889)

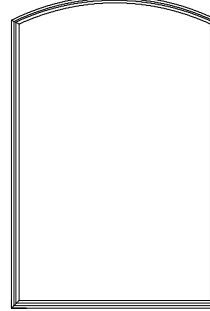

S4ESC-40L60

82 11/16" (2100)
 84 3/16" (2138)
 81 1/8" (2061)
 80 3/8" (2042)
 76 3/4" (1949)

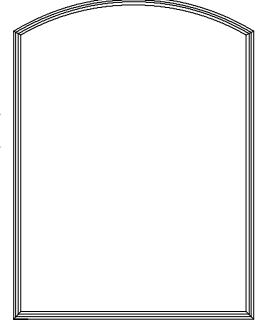

S4ESC-50L60

ELEVATION SYMBOL LEGEND:
M.O. = MASONRY OPENING
 VALUES IN () ARE IN MILLIMETER CONVERSIONS

Note: Elevations shown DO NOT have exterior trim. Subtract 1/2" (12.7) from M.O. (Masonry Opening) for Unit Sizes. Masonry Openings above include Sill Nose, see Trim Options page for Sill Nose specifications. For other Trim Options refer to the Unit Sizing, Rough Opening & Masonry Openings page.

400 SERIES SLIDING PATIO DOOR EXTENDED LEG SEGMENT TOP UNITS

M.O. BRICKMOULD
M.O. ADAMS/FLAT CASING
ROUGH OPENING
FRAME SIZE
DAYLIGHT OPENING

75 1/2" (1918)
78 1/2" (1994)
72 3/4" (1848)
72" (1829)
68 3/8" (1737)

M.O. BRICKMOULD
M.O. ADAMS/FLAT CASING
ROUGH OPENING
FRAME SIZE
DAYLIGHT OPENING

75 1/2" (1918)
78 1/2" (1994)
72 3/4" (1848)
72" (1829)
68 3/8" (1737)

16 7/16" (418)
17 15/16" (456)
14 7/8" (378)
14 1/8" (359)
10 1/2" (267)



S4ESC-60L06

22 7/16" (570)
23 15/16" (608)
20 7/8" (530)
20 1/8" (511)
16 1/2" (419)

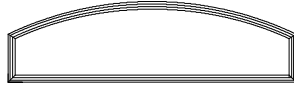

S4ESC-60L10

28 7/16" (722)
29 15/16" (760)
26 7/8" (683)
26 1/8" (664)
22 1/2" (572)



S4ESC-60L16

34 7/16" (875)
35 15/16" (913)
32 7/8" (835)
32 1/8" (816)
28 1/2" (724)

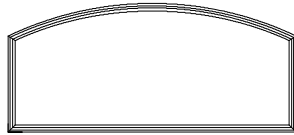

S4ESC-60L20

46 7/16" (1180)
47 15/16" (1217)
44 7/8" (1140)
44 1/8" (1121)
40 1/2" (1029)

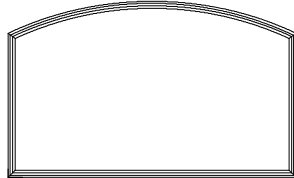

S4ESC-60L30

58 7/16" (1484)
59 15/16" (1522)
56 7/8" (1445)
56 1/8" (1426)
52 1/2" (1334)

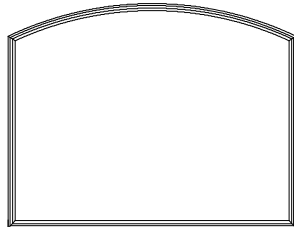

S4ESC-60L40

70 7/16" (1789)
71 15/16" (1827)
68 7/8" (1749)
68 1/8" (1730)
64 1/2" (1638)

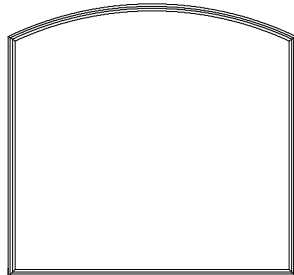

S4ESC-60L50

82 7/16" (2094)
83 15/16" (2132)
80 7/8" (2054)
80 1/8" (2035)
76 1/2" (1943)

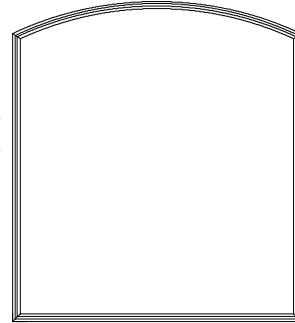

S4ESC-60L60

ELEVATION SYMBOL LEGEND:
M.O. = MASONRY OPENING
VALUES IN () ARE IN MILLIMETER CONVERSIONS

Note: Elevations shown DO NOT have exterior trim. Subtract 1/2" (12.7) from M.O. (Masonry Opening) for Unit Sizes. Masonry Openings above include Sill Nose, see Trim Options page for Sill Nose specifications. For other Trim Options refer to the Unit Sizing, Rough Opening & Masonry Openings page.

SCALE 1/4" = 1'

GLAZING OPTIONS

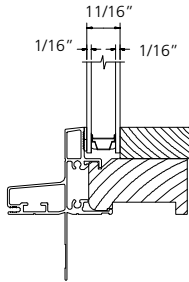

STANDARD INSULATED GLASS

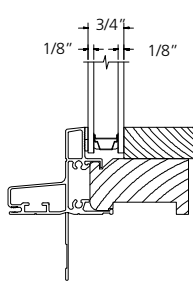

STANDARD INSULATED GLASS

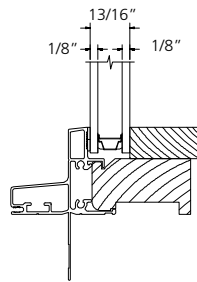

STANDARD INSULATED GLASS

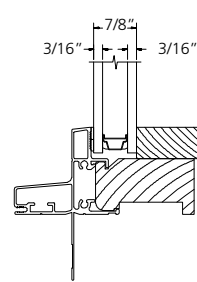

STANDARD INSULATED GLASS

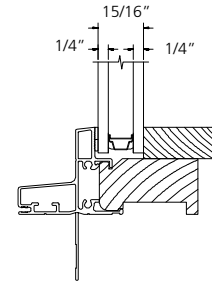

STANDARD INSULATED GLASS

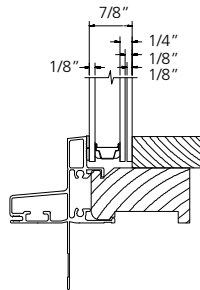

LAMINATED INSULATED CLEAR OR LOW E GLASS

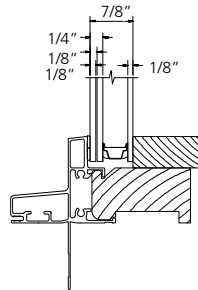

LAMINATED INSULATED TINTED GLASS

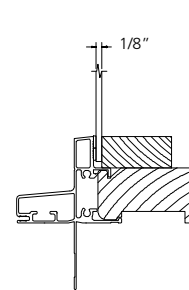

LAMINATED INSULATED SINGLE GLASS

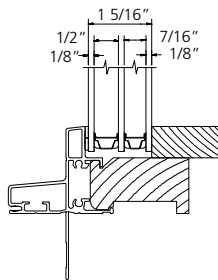

DS TRIPANE INSULATED GLASS

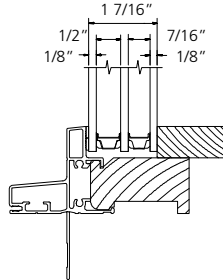

5/32" TRIPANE INSULATED GLASS

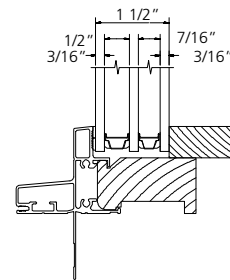

3/16" TRIPANE INSULATED GLASS

Note: Glazing options shown are available in Clad Geometric Direct-Set Windows with frame as shown and also in Clad Radius Direct-Set Windows and Wood Geometric and Radius Direct-Set Windows. See pages 9-74 to 9-77 for Clad Radius window frame and pages 11-73 to 11-76 for Wood Geometric and Radius frame details.

Note: Dual pane and tripane Insulated Glass shown with stainless steel warm edge spacer may also be built with aluminum box spacer depending on shape, glass type, or special grille bar pattern.

TRIM OPTIONS

STRAIGHTLINE EXTERIOR TRIM

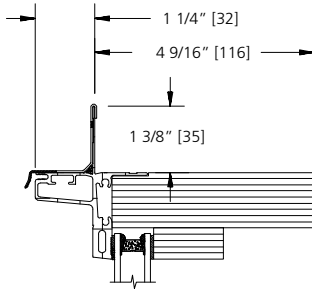

STANDARD

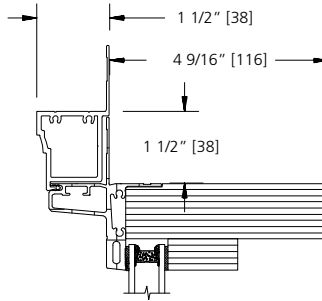

BRICKMOULD

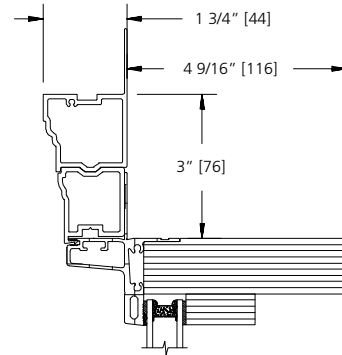

ADAMS CASING

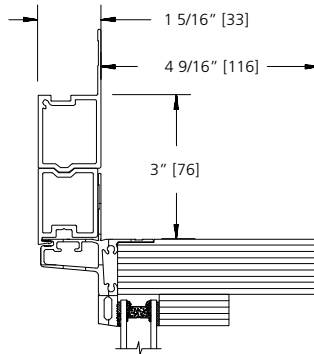

3 1/2\"/>

SILL OPTIONS

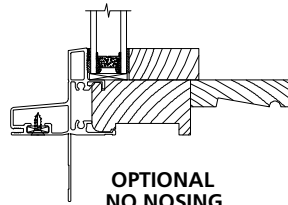

**OPTIONAL
NO NOSING**

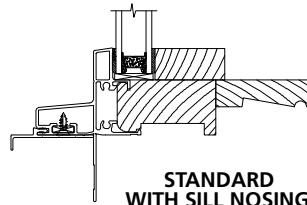

**STANDARD
WITH SILL NOSING**

SCALE: 3" = 1'

JAMB EXTENDER OPTIONS

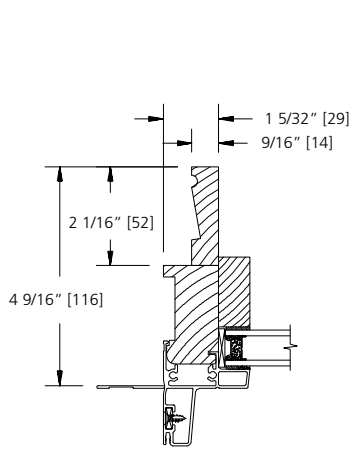

4 9/16" WALL
9/16" JAMB THICKNESS (OPTION)

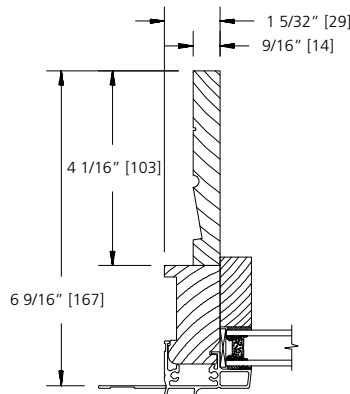

6 9/16" WALL

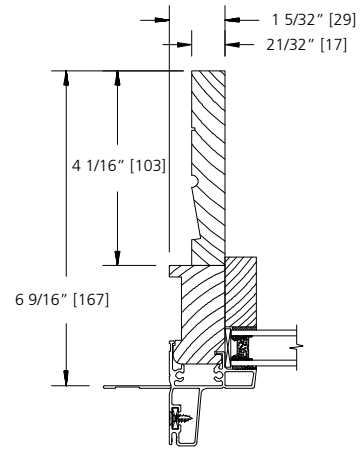

6 9/16" WALL
4/4 JAMB THICKNESS (STANDARD)

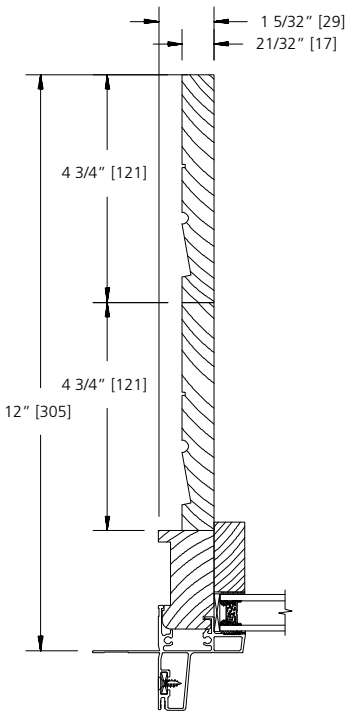

12" WALL
4/4 JAMB THICKNESS (STANDARD)
2 PC JAMB EXTENSION SHOWN

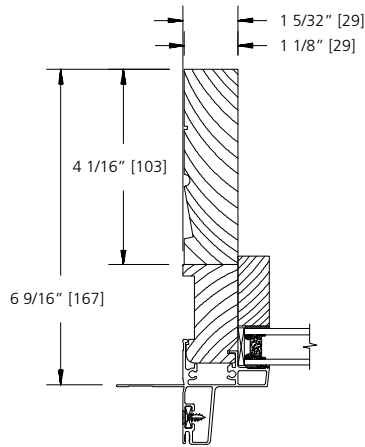

6 9/16" WALL
5/4 JAMB THICKNESS (OPTION)

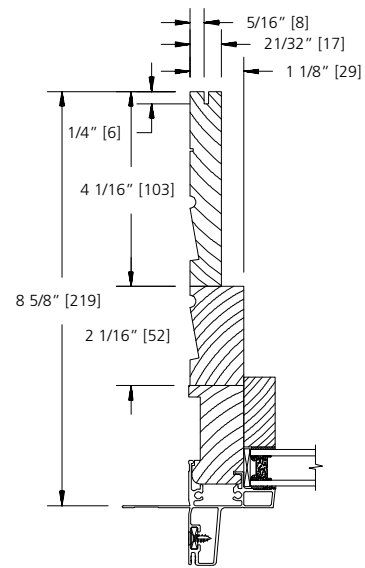

8 5/8" WALL
5/4-4/4 STACKED KERFED
JAMB OPTION

Notes:

Jamb Extension (9/16" thick) only available on Jambs up to 6 9/16".
Jambs over 6 9/16" will only have a 4/4 or 5/4 option.
Jambs over 7 1/4" up to 12" will be 2 layers.
Kerfed Jamb Extension only available on 4/4 or 5/4 options.

SCALE: 3" = 1'

LITE CUT INFORMATION

Clad direct-set geometric windows are available in 7/8", 1-1/8" and 1-3/8" widths for SDL (Simulated Divided Lites); 5/8" Flat, 23/32" and 1" Contour GBG (Grilles between the Glass); and 7/8", 1-1/8" and 1-3/8" Full Surround removable grilles. Standard lite cuts are rectangular. They conform to the layouts noted on the following pages.

LITE CUT OPTIONS

Special lite cut patterns can include a wide variety of straight line and radius patterns. The illustrations shown here represent just a few of the possibilities. Rectangular, horizontal, vertical and Prairie lite patterns are available in all standard size clad direct-set geometric windows. Uneven, diamond, radius and Gothic lite cuts are available, subject to approval. Approvals are based on the ability to fulfill the design requirement while maintaining the construction integrity of the finished product.

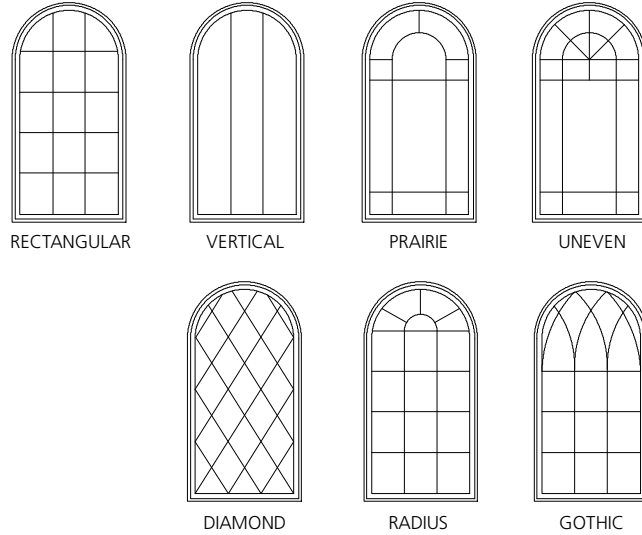

BAR ALIGNMENT

Alignment of divided lite muntin bars from one window to the next is often required by fine architectural design. Wood grilles, GBG (Grilles between the Glass), and Simulated Divided Lites may be specified with muntin bars aligned.

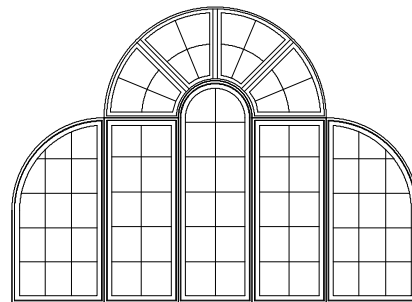

Continued on next page

LITE CUT INFORMATION

HALF ROUND LITE PATTERNS

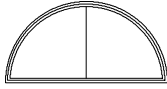

200 SERIES

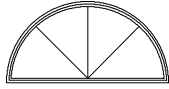

400 SERIES

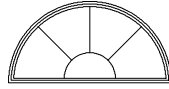

500 SERIES

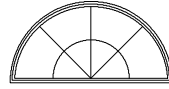

800 SERIES

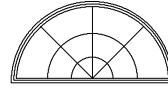

1200 SERIES

QUARTER ROUND LITE PATTERNS



200 SERIES



400 SERIES



600 SERIES

FULL ROUND LITE PATTERNS

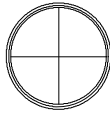

400 SERIES

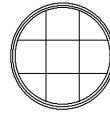

900 SERIES

OCTAGON LITE PATTERNS



400 SERIES



900 SERIES

Continued on next page

LITE CUT INFORMATION

INVERTED RADIUS SILL NOTE:

Windows with inverted radius sills have continuous head and sill configurations. The twin, triple and quad units utilize a mullion post as part of a single unit. Single lines represent grille and thermal bar lite break ups. Twin, triple and quad units are single units with mullion posts being represented by several lines.

INVERTED HALF ROUND LITE PATTERNS

INVERTED HALF ROUND SILL

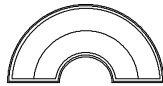

200 SERIES
RADIUS HUB

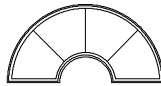

400 SERIES

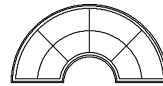

800 SERIES

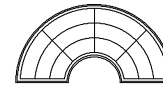

1200 SERIES

INVERTED HALF ROUND SILL - TWIN

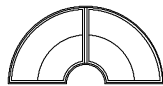

200 SERIES
RADIUS HUB

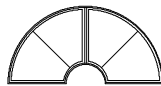

200 SERIES

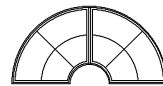

400 SERIES

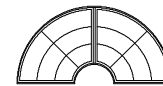

600 SERIES

INVERTED HALF ROUND SILL - TRIPLE



200 SERIES
RADIUS HUB

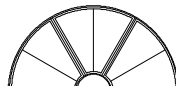

200 SERIES

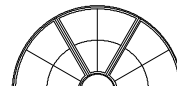

400 SERIES

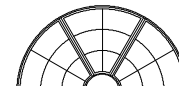

600 SERIES

INVERTED HALF ROUND SILL - QUAD



200 SERIES
RADIUS HUB



200 SERIES



400 SERIES



600 SERIES

INVERTED QUARTER ROUND LITE PATTERNS

INVERTED QUARTER ROUND SILL



200 SERIES
RADIUS HUB



200 SERIES



400 SERIES



600 SERIES

INVERTED QUARTER ROUND SILL - TWIN



200 SERIES
RADIUS HUB



200 SERIES



400 SERIES



600 SERIES

INVERTED QUARTER ROUND SILL - TRIPLE



200 SERIES
RADIUS HUB



200 SERIES



400 SERIES



600 SERIES

DIVIDED LITE OPTIONS

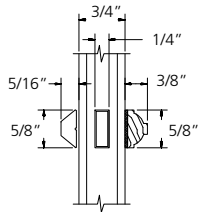

5/8" PUTTY/BEAD SDL

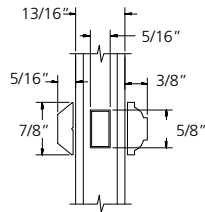

7/8" PUTTY/BEAD SDL

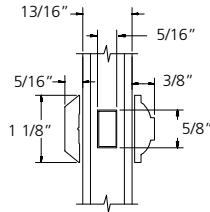

1 1/8" PUTTY/BEAD SDL

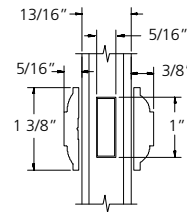

1 3/8" SDL

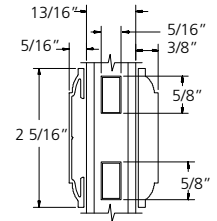

2 5/16" SDL

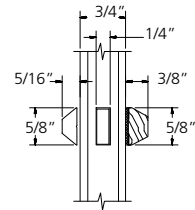

5/8" PUTTY/PUTTY SDL

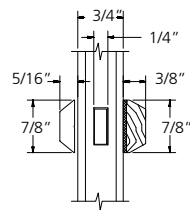

7/8" PUTTY/PUTTY SDL

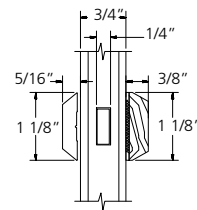

1 1/8" PUTTY/PUTTY SDL

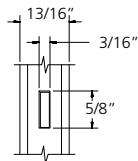

5/8" GRILLE

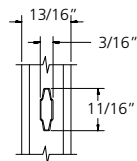

23/32" GRILLE

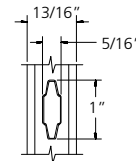

1" GRILLE

GRILLES MEETING
NFRC 3mm RULE

GRILLE PROFILES

| | |
|----------------------|--------------------------|
| 3/16" X 5/8" | ALLMETAL 1021101018XX140 |
| 1/4" X 5/8" | ALLMETAL 1020102018XX140 |
| 1/4" X 1" | ALLMETAL 1020102018XX164 |
| .325" X 5/8" | ALLMETAL 1020106018XX140 |
| .325" x 1" | ALLMETAL 1020103018XX164 |
| 5.5mm X 18mm Contour | ALLMETAL 1020301010XX255 |
| 8mm X 25mm Contour | ALLMETAL 1020301018XX380 |

SCALE: NTS

STRAIGHT LINE SHAPES

ALL GEOMETRIC WINDOW SHAPES ARE VIEWED FROM THE EXTERIOR.

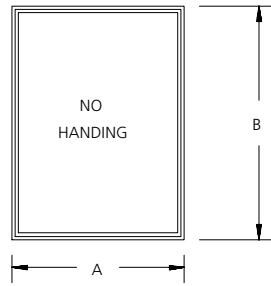

RECTANGLE

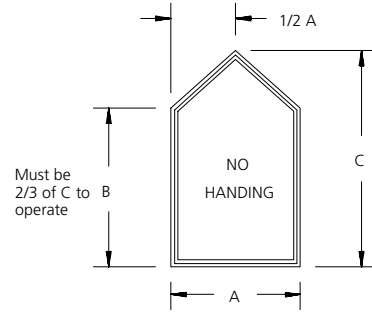

PENTOID

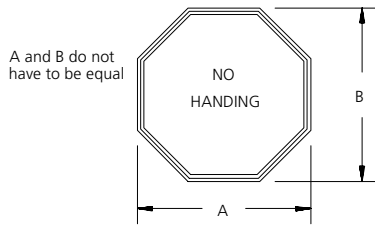

OCTAGON

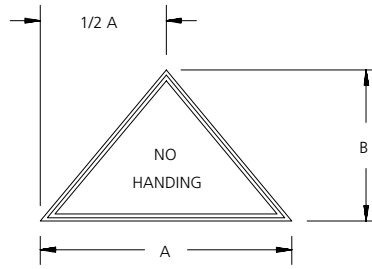

**TRIANGLE
(EQUILATERAL - ISOCELES)**

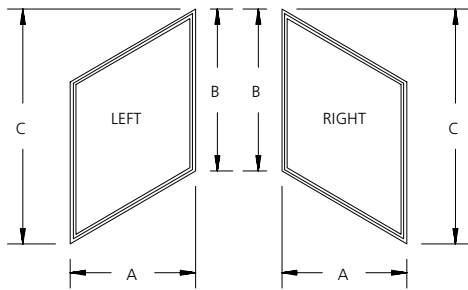

PARALLELOGRAM

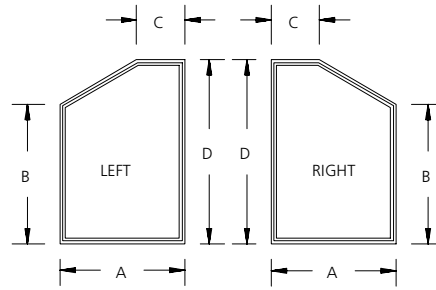

**PENTOID
(ASYMMETRICAL)**

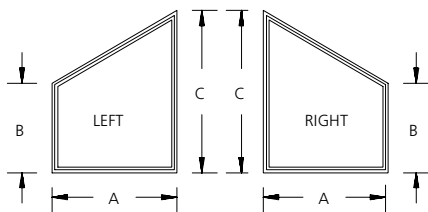

TRAPEZOID

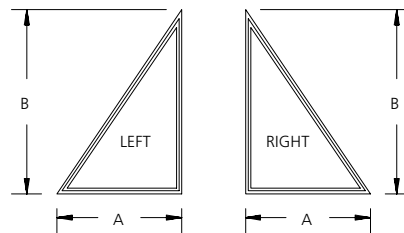

RIGHT TRIANGLE

SCALE: NTS

RADIUS SHAPES

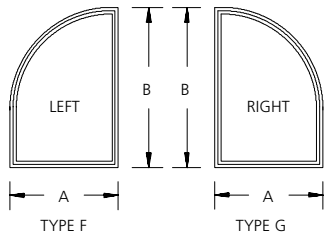

**OPEN BOTTOM
QUARTER ROUND**

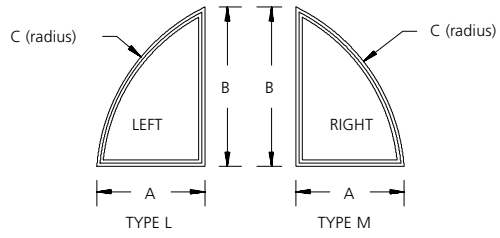

**HANDED
SECTOR**

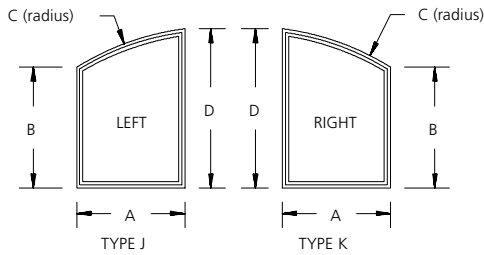

**OPEN BOTTOM
HANDED SECTOR**

ALL GEOMETRIC WINDOW SHAPES ARE VIEWED FROM THE EXTERIOR.

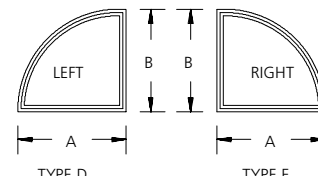

QUARTER ROUND

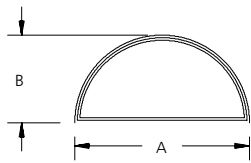

HALF ROUND

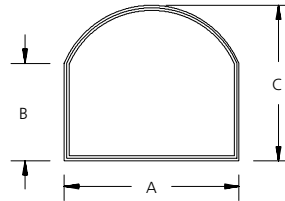

**OPEN BOTTOM
SECTOR**

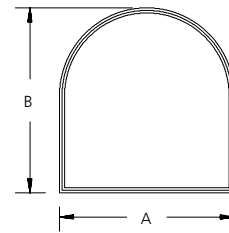

**OPEN BOTTOM
HALF ROUND**

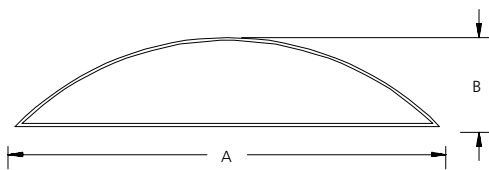

SECTOR

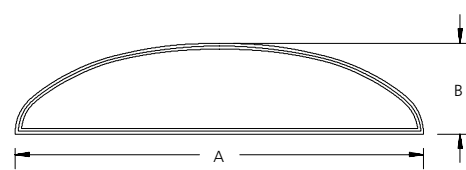

ELLIPSE

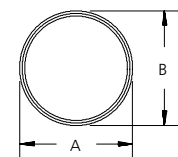

FULL ROUND

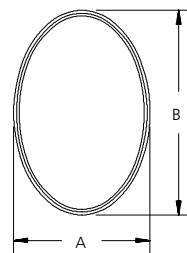

OVAL

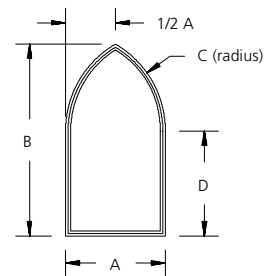

GOTHIC

Continued on next page
SCALE: NTS

RADIUS SHAPES

ALL GEOMETRIC WINDOW SHAPES ARE VIEWED FROM THE EXTERIOR.

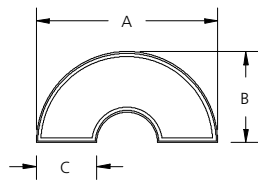

INVERTED HALF ROUND
TYPE BI - 1

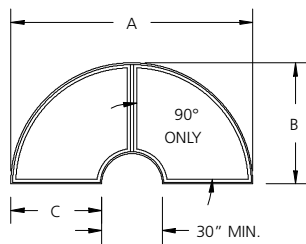

INVERTED HALF ROUND - TWIN
TYPE BI - 2

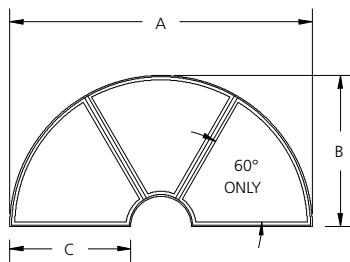

INVERTED HALF ROUND - TRIPLE
TYPE BI - 3

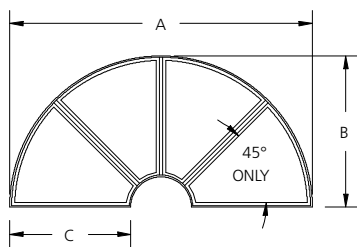

INVERTED HALF ROUND - QUAD
TYPE BI - 4

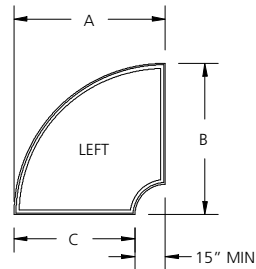

TYPE DI - 1

INVERTED QUARTER ROUND

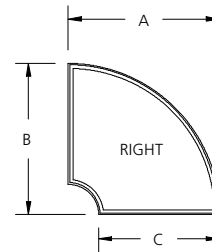

TYPE EI - 1

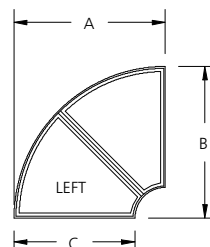

TYPE DI - 2

INVERTED QUARTER ROUND - TWIN

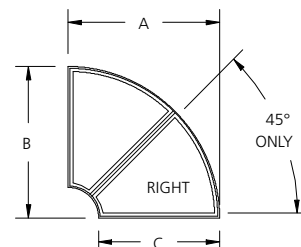

TYPE EI - 2

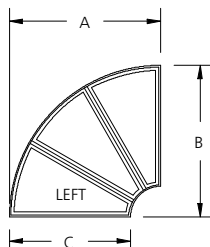

TYPE DI - 3

INVERTED QUARTER ROUND - TRIPLE

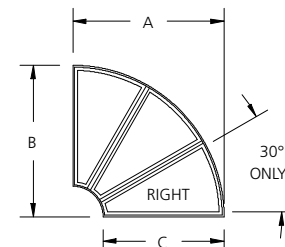

TYPE EI - 3

INVERTED HALF ROUND AND QUARTER ROUND UNITS

Inverted half round and quarter round units have continuous head and sill configurations which utilize mullion posts from frame to frame. See page 9-74 (Section Details & Dimensions) for mullion post specifications. The mullion posts are positioned radially from the center point of the sill radius.

SCALE: NTS

**UNIT SIZING, ROUGH OPENINGS
& MASONRY OPENINGS**

STANDARD OFFERING

DRIP CAP & INTEGRAL NAILING FLANGE

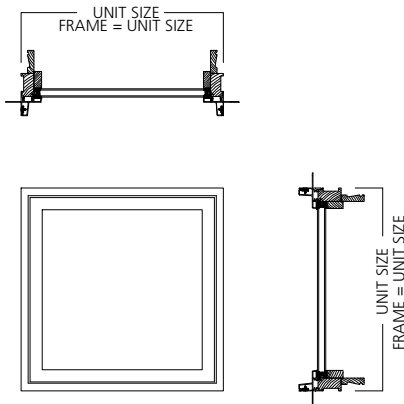

GENERAL NOTES:

UNITS WITH NO TRIM AND SILL NOSE:
UNIT SIZE = FRAME SIZE

UNIT SIZE IS ALWAYS THE
EXTREME SIZE OF THE WINDOW
WITH OR WITHOUT TRIM
(DRIP CAP & NAILING FLANGE ARE
NOT ADDED TO ANY UNIT SIZING)

MASONRY OPENING:
MASONRY OPENING IS ALWAYS 1/2" OVER
THE UNIT SIZE OF THE WINDOW

ROUGH OPENING:

ROUGH OPENING IS ALWAYS 3/4" OVER
FRAME SIZE OF THE WINDOW

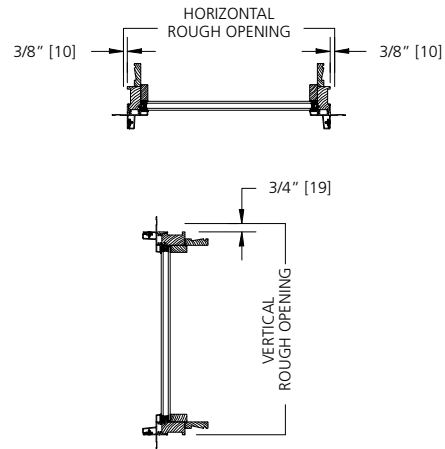

NON-STANDARD UNIT SIZING

EXTERIOR TRIM OFFERINGS WITH SILL NOSE

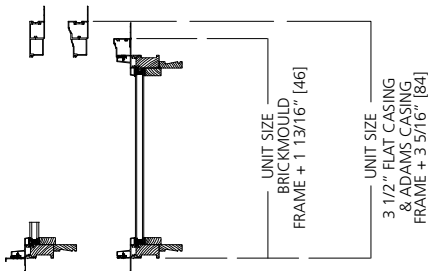

EXTERIOR TRIM OFFERINGS WITHOUT SILL NOSE
EXTERIOR TRIM ON ALL 4 SIDES

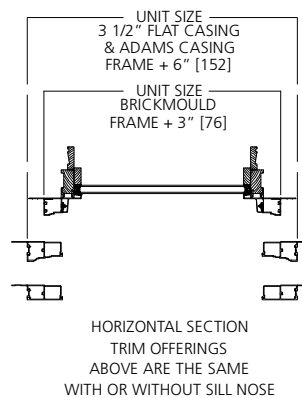
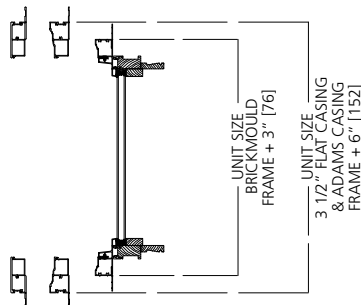

**FRAME TO TRIM
DIMENSIONS**

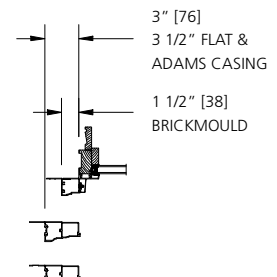

TYPICAL FOR HEAD, SILL & SIDE

DIRECT-SET UNIT

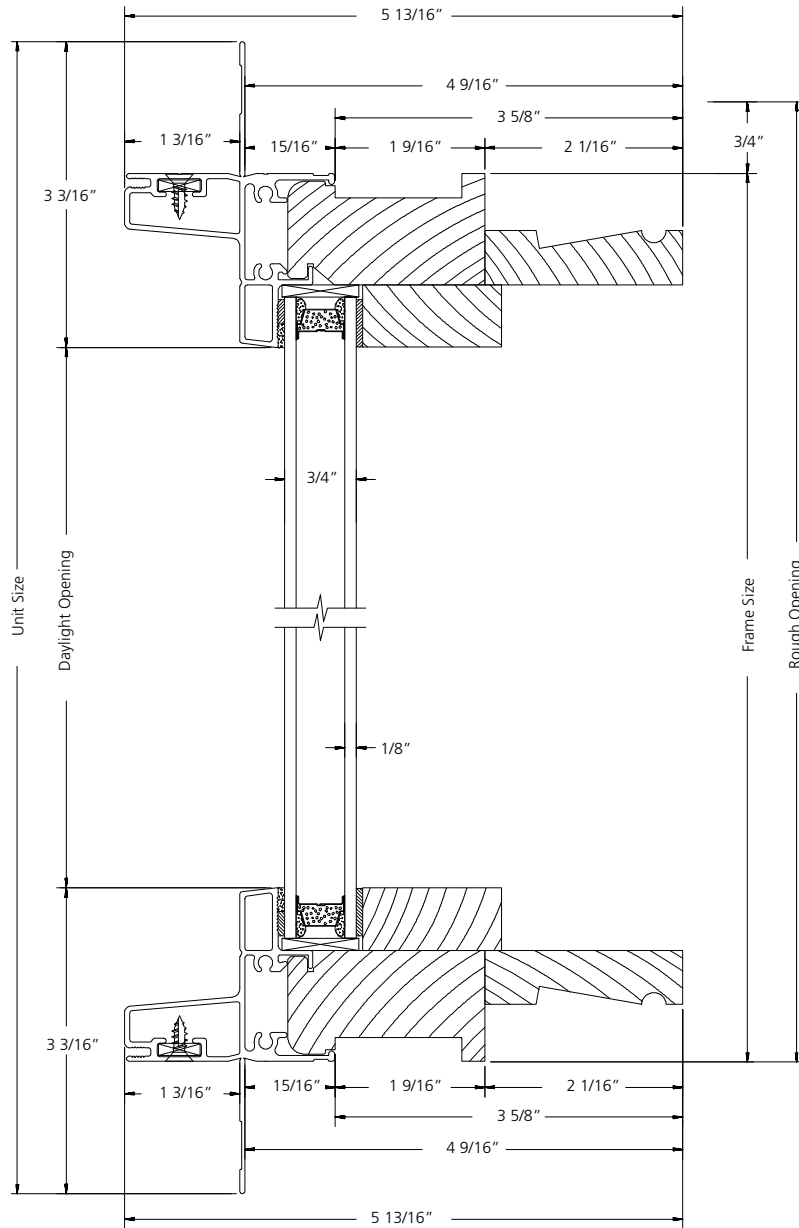

VERTICAL SECTION

SCALE: 6" = 1'

DIRECT-SET UNIT

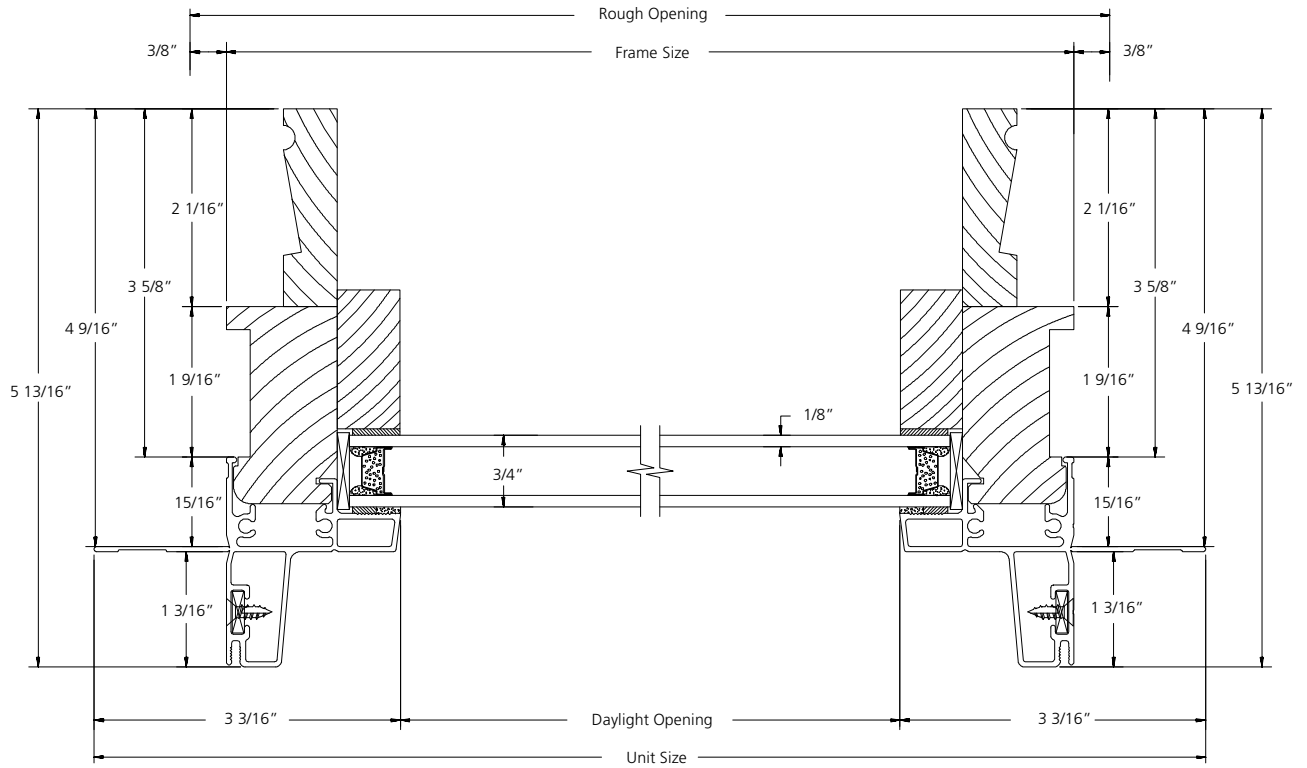

HORIZONTAL SECTION

SCALE: 6" = 1'

DIRECT-SET RADIUS UNIT

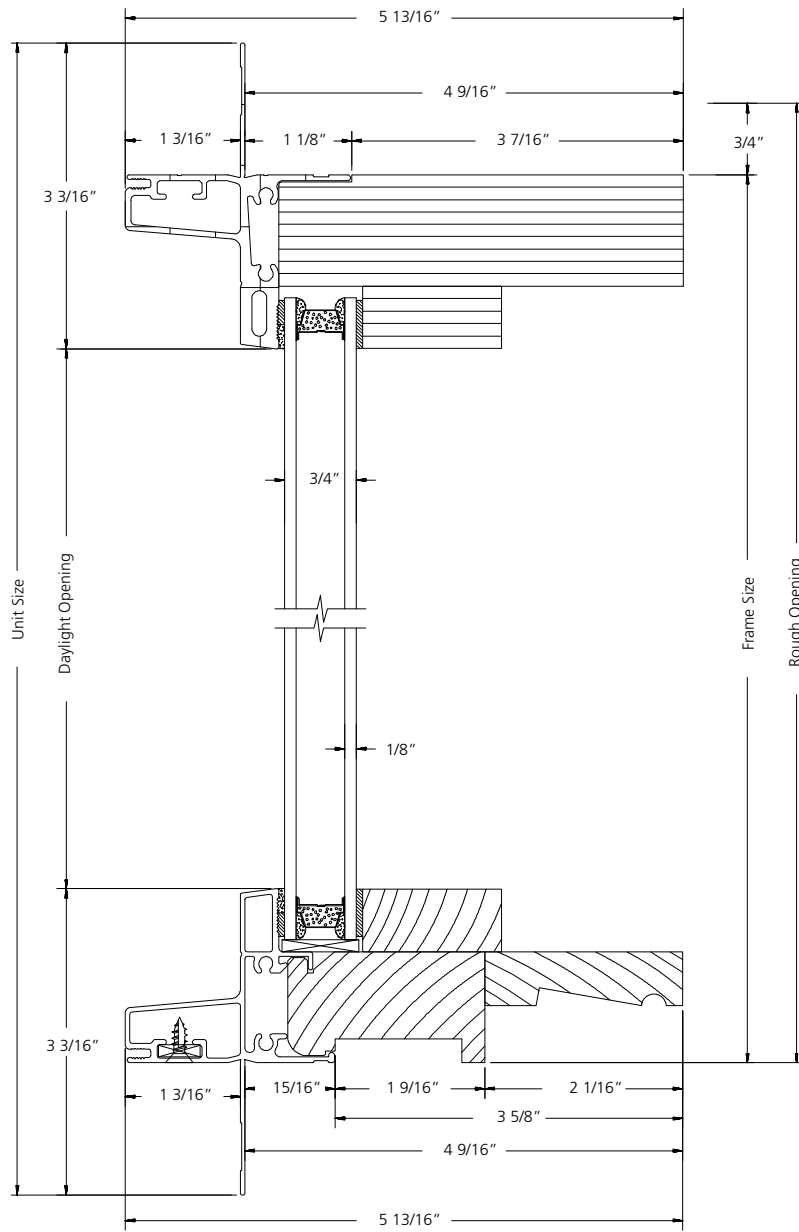

VERTICAL SECTION

SCALE: 6" = 1'

DIRECT-SET RADIUS UNIT

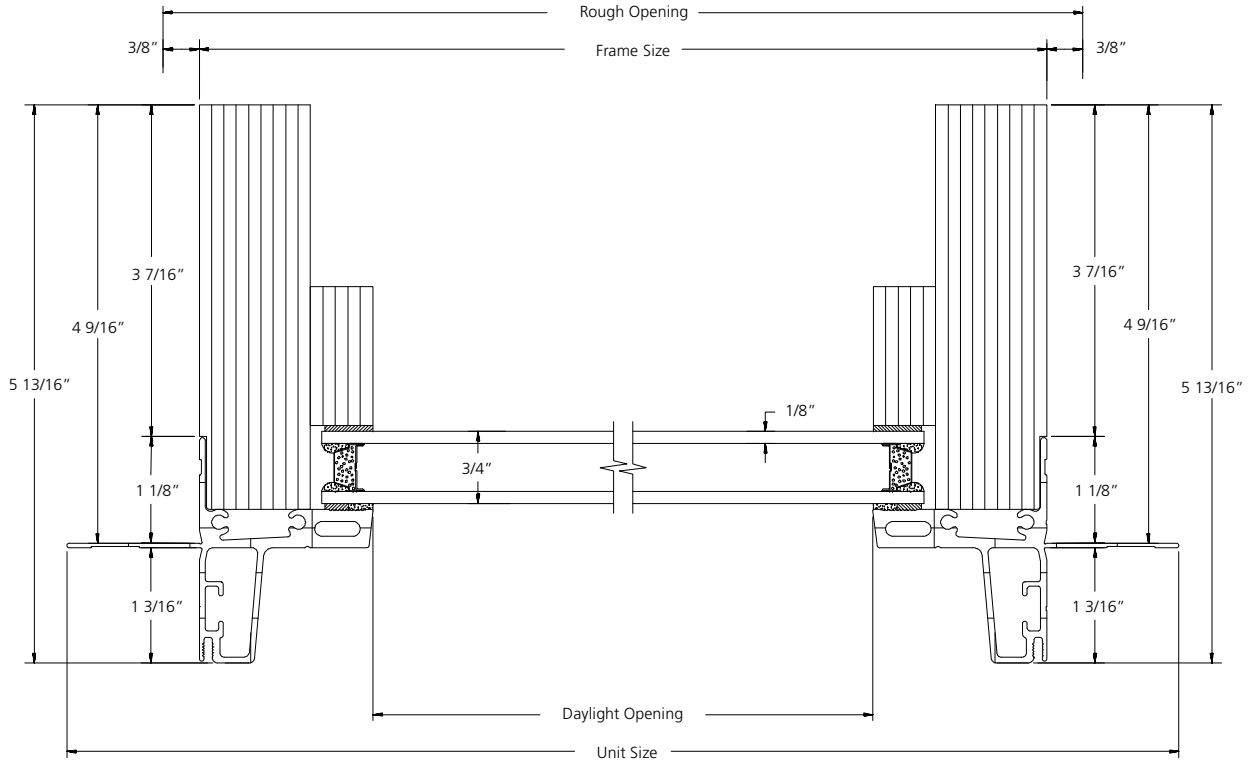

HORIZONTAL SECTION

SCALE: 6" = 1'