

TABLE OF CONTENTS

Specifications	11-2
Quick Spec Guide	11-3
Elevations/Sizes: 1/4" Scale	11-4
Full Round Units	11-7
Oval Units	11-8
Ellipse Units	11-9
Casement and Door Quarter Round Units	11-10
Casement Half Round Units	11-11
Casement Extended Half Round Units	11-13
Casement Extended Leg Segments	11-20
Double-Hung and Door Quarter Round Units	11-27
Double-Hung Half Round Units	11-28
Double-Hung Extended Half Round Units	11-29
Double-Hung Extended Leg Segments	11-34
Swinging Patio Doors Half Round Units	11-39
Swinging Patio Doors Extended Half Round Units	11-40
Swinging Patio Door Extended Leg Segments	11-44
300 Series Sliding Patio Doors Half Round Units	11-48
300 Series Sliding Patio Doors Extended Half Round Units	11-49
300 Series Sliding Patio Door Extended Leg Segments	11-52
400 Series Sliding Patio Doors Half Round Units	11-55
400 Series Sliding Patio Doors Extended Half Round Units	11-56
400 Series Sliding Patio Door Extended Leg Segments	11-59
Glazing Options: 3" Scale	11-62
Trim Options: 3" Scale	11-63
Jamb Options: 3" Scale	11-64
Lite Cut Information	11-65
Layout Shapes	11-69
Unit Sizing, Rough Openings & Masonry Openings	11-72
Section Details: 6" Scale	11-73

PRODUCT SPECIFICATIONS**EXTERIOR FINISH**

All exterior surfaces are covered with a factory-applied latex primer.

AURALAST® WOOD

AuraLast® wood is fundamentally different from wood treated in traditional millwork preservation processes in that it uses a proprietary vacuum/pressure process to provide protection throughout the wood parts used to make windows and doors. AuraLast® wood is distinguished from wood using traditional preservation methods by its unique ability to achieve greater penetration of the active ingredients into the wood parts, with a minimum treatment penetration of 92%.

INTERIOR FINISH

All interior surfaces are unfinished clear pine ready for on site finishing. Primed and pre-finished interiors are available in paint: Pure White, Extra White, Natural Choice, Moderate White; in stain: Wheat, Cherry, Fruitwood, Cordovan, Cider and Clear Lacquer.

FRAME (RADIUS UNITS)

Frame is assembled from select kiln dried pine using AuraLast® wood on all exterior parts. 1-5/32" curved head member consists of multiple layer premium grade soft wood veneers laminated and bonded together with water-resistant glue. 11/16 laminated interior stop back screwed to frame. Head member assembly joined to the sill with rabbeted construction, sealed with butyl sealant and secured with screws. Assembled units include brickmould casing and sill nosing. Basic jamb width is 3-3/4". Standard jamb width is 4-9/16" and may be extended for different wall depths. Sill is 1-5/32" thick.

FRAME (GEOMETRIC UNITS)

Frame is assembled from select kiln dried pine 1-5/32" (29.4mm) using AuraLast® wood on all exterior parts. Corners are sealed with silicone sealant. Basic jamb width is 3-3/4" and may be extended for different wall depths. Sill is 1-5/32" (29.4mm) thick.

SASH

Radius units may be specified as Direct Glazed or In-Sash. Sash match Casement/Awning profiles. Wood exterior sash are latex primed or may be specified natural. All Radius sash exteriors are laminated or fingerjointed. All Geometric sash are exteriors are fingerjointed and interiors are clear. On Direct-Set units glass is glazed into the sash with a durable clear silicone on the exterior and an acrylic sealant on the interior.

GLAZING

3/4" thick sealed insulating glass is constructed from two panes of glass, utilizing a continuous roll formed stainless steel spacer with dual seal sealant. All insulating glass units comply with the performance requirements of IGCC in accordance with either ASTM E774 or E2190.

Direct Glazed - Glass is direct glazed into the frame on the exterior with a butyl glazing tape and cap beaded with silicone. An adhesive butyl is applied to removable wood stops on the interior.

GLAZING OPTIONS

3/4" insulating glass available in Low-E with Argon, Low-E, Low-E 366, Clear, Neat Glass, reflective, tinted, or obscure, tempered or other specialty glass as specified. Preserve® film is a 0.003" thick polyethylene film with a low tack acrylic adhesive applied to the glass for protection during shipping and installation. 4,000 foot elevations and higher require a capillary tube to equalize environmental stress (otherwise known as High Altitude glazing). High Altitude glazing does not allow the use of Argon as listed under glazing options.

GRILLES

SDL (Simulated Divided Lites) - wood muntins permanently applied to the exterior of the insulating glass unit (not available on textured glass) in 7/8" (22mm), 1-1/8" (28.5mm), or 1-3/8" (34.9mm) widths, and a putty profile in 5/8" (15.9mm), 7/8" (22mm) and 1-1/8" (28.5mm) widths only. SDL is standard with a light bronze internal shadow bar to give a true divided lite appearance. As an option, SDL may be ordered with a silver shadow bar. Clear wood interior muntin bars match the exterior muntin width and are permanently bonded to the interior of the glass. Also available is a 2-5/16" (59mm) SDL bar, which simulates a double-hung checkrail.

Wood Grilles - Rectangular unfinished clear pine wood grilles in 7/8" (22mm) are available in patterns selected by the owner. Direct-Sets are only available with KD Grilles.

GBG (Grilles between the Glass) - 5/8" (15.9mm) flat and 23/32" or 1" contour mounted between the glass panes suspended within the air cavity.

APPLIED ALUMINUM DRIP CAP (RADIUS UNITS)

Drip cap is made from .040" extruded aluminum, and is shaped by a precision bending process (optional).

EXTERIOR TRIM

1-3/32" (27.8mm) x 2" (50.8mm) brickmould with 1-1/16" (27mm) x 1-3/4" (44.5mm) nosing is standard. Flat casing is available as 1-3/32" (27.8mm) x 2" (50.8mm), 1-3/32" (27.8mm) x 3-1/2" (89mm), 1-3/32" (27.8mm) x 4-1/2" (114.3mm), and 1-3/32" (27.8mm) x 5-1/2" (139.7mm). The following profiled casings are available: RB-3 and Adams as 1-1/16" x 3-1/2" (89mm), and Williamsburg 1-3/16" x 3-1/4".

EXTENSION JAMBS

Extension jambs are factory applied to the interior on all four sides of the frame and are 4/4 standard thick pine to accommodate wall depths up to 8-1/2" with one piece, and up to 12" with two pieces. 9/16" (14.2mm) and 5/4 option also available.

RADIUS INSIDE TRIM

Laminated radius trim in Pine or Oak available in a variety of patterns. 3 x 3 Corner blocks in Pine or Oak also available.

INSTALLATION

Installation per JELD-WEN Installation Method for Wood Windows JII003 or JII012. See www.jeld-wen.com/resources for instructions.

PERFORMANCE

NFRC Certified - (Rated and labeled in accordance with NFRC)

WDMA Hallmark Certified -
In accordance with **AAMA/NWWDA/101/I.S.2-97**

QUICK SPEC GUIDE

SPECIFICATION	STANDARD FEATURES	OPTIONAL FEATURES <i>Some options may require additional lead times. Consult your JELD-WEN Sales Representative.</i>		
EXTERIOR FINISH	<ul style="list-style-type: none"> • Primed 	<ul style="list-style-type: none"> • Natural (some visible finger joints) 		
PRIMED EXTERIOR TRIM	<ul style="list-style-type: none"> • 2" Brickmould • Wood Sill Nose • Drip Cap 	<ul style="list-style-type: none"> • Flat Casing: 1-3/32" x 2", 3-1/2", 4-1/2", and 5-1/2" • Heritage Casing: 1-3/16" x 3-1/4" • Adams Casing: 1-1/16" x 3-1/2" • RB3 Casing: 1-1/16" x 3-1/12" • 1-7/32" x 4-1/2" Backband • No Brickmould Option • Historical Sill Nose 		
INTERIOR FINISH	<ul style="list-style-type: none"> • Natural 	<ul style="list-style-type: none"> • Priming Available <p>Pre-finished Interior Options are:</p> <ul style="list-style-type: none"> • Paint - Pure White, Extra White, Natural Choice, Moderate White • Stain - Wheat, Fruitwood, Cherry, Cordovan, Cider • Clear Lacquer 		
SIZE	<p>Radius Units</p> <ul style="list-style-type: none"> • Half Rounds: 26 Sizes • Quarter Rounds: 12 Sizes • Full Circles: 9 Sizes • Ellipticals: 2 Sizes • Ovals: 4 Sizes <p>Geometric Units</p> <ul style="list-style-type: none"> • All window units are made to specified Frame Dimensions, see sample elevations for required dimensions 	<p>Size Limitations</p> <ul style="list-style-type: none"> • Units May Not Exceed 50 square feet • Some Sizes May Require Tempered Glazing 		
GLAZING	<ul style="list-style-type: none"> • Low-E Insulating Glass • Preserve® Protective Film 	<table border="0"> <tr> <td> <ul style="list-style-type: none"> • Clear • Obscure • Bronze • Low-E 366 • Neat Glass • Dual Low-E • Reflective </td> <td> <ul style="list-style-type: none"> • Tempered • Decorative Glass <ul style="list-style-type: none"> ○ Craftsman ○ Classic ○ Contemporary ○ Estate • Custom Design Capability </td> </tr> </table> <ul style="list-style-type: none"> • High Altitude 	<ul style="list-style-type: none"> • Clear • Obscure • Bronze • Low-E 366 • Neat Glass • Dual Low-E • Reflective 	<ul style="list-style-type: none"> • Tempered • Decorative Glass <ul style="list-style-type: none"> ○ Craftsman ○ Classic ○ Contemporary ○ Estate • Custom Design Capability
<ul style="list-style-type: none"> • Clear • Obscure • Bronze • Low-E 366 • Neat Glass • Dual Low-E • Reflective 	<ul style="list-style-type: none"> • Tempered • Decorative Glass <ul style="list-style-type: none"> ○ Craftsman ○ Classic ○ Contemporary ○ Estate • Custom Design Capability 			
GRILLES		<ul style="list-style-type: none"> • 5/8" Flat, 23/32" or 1" Contour GBG • Direct Set: 7/8" KD Wood Grilles <p>SDL Bead Profile:</p> <ul style="list-style-type: none"> • 7/8", 1-1/8", 1-3/8", 2-5/16" with Light Bronze Shadow Bar • 7/8", 1-1/8", 1-3/8", 2-5/16" with Silver Shadow Bar <p>Patterns may be Colonial, Renaissance, Prairie or Gothic (not limited to stated patterns)</p> <p>SDL Putty Profile:</p> <ul style="list-style-type: none"> • 5/8", 7/8", 1-1/8" with Light Bronze Shadow Bar • 5/8", 7/8", 1-1/8" with Silver Shadow Bar 		
INTERIOR RADIUS CASING		<ul style="list-style-type: none"> • Seven Patterns • Other casings may be available 		
JAMB	<ul style="list-style-type: none"> • 4-9/16" 	<ul style="list-style-type: none"> • Minimum: 3-3/4" • Maximum: 8-1/2" (one piece) • Maximum: 12" (two piece) 		

GENERAL INFORMATION

STANDARD SIZES & DESIGNS

Wood geometric windows are produced one-at-a-time to customer order, and are available in a nearly infinite range of sizes and shapes. Specified sizes, angles, and radii can be attained in finished units, to meet the most demanding architectural requirements.

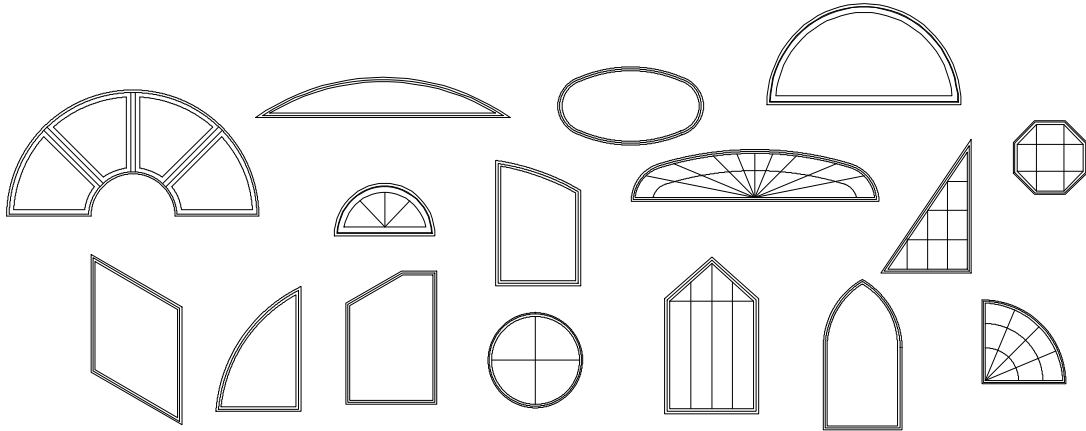

MULTIPLE ASSEMBLIES

Wood direct-set geometric windows may be mullied above, below, or beside other wood geometric windows, or other wood window or patio door products. Factory assembled mulls are limited in height (100"), width (150"), and a total area (75 square feet).

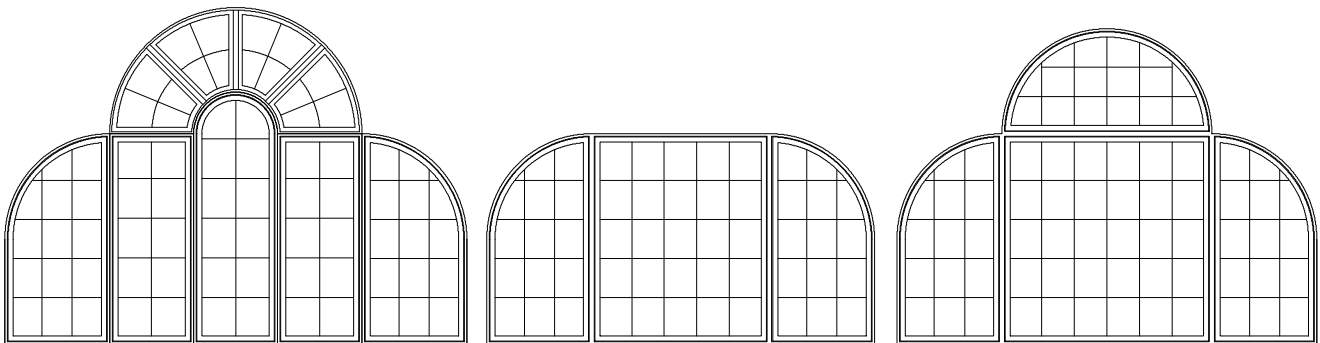

ELEVATION NOTES

ELEVATION DRAWINGS UTILIZE A LIMITED NUMBER OF PROJECTED LINES TO PRODUCE A RUDIMENTARY DRAWING INTENDED TO BE USED IN A SMALL GRAPHICAL SCALE. ELEVATIONS ARE VIEWED PERPENDICULAR FROM THE EXTERIOR OF THE STRUCTURE. IF MORE DIMENSIONS ARE NEEDED, USE THE SECTION DRAWINGS FOR MORE COMPLETE DEPICTIONS.

BOOK CODE DEFINITIONS

- | | |
|--------------|---|
| 1. EWXXHRDS | SITELINE EX WOOD CASEMENT HALF ROUND DIRECT-SET |
| 2. EWDXXHRDS | SITELINE EX WOOD DOUBLE-HUNG HALF ROUND DIRECT-SET |
| 3. EWXXQRDS | SITELINE EX WOOD CASEMENT QUARTER ROUND DIRECT-SET |
| 4. EWXXFRDS | SITELINE EX WOOD FULL ROUND DIRECT-SET |
| 5. EWQVXXXX | SITELINE EX WOOD OVAL DIRECT-SET |
| 6. EWDXXQRDS | SITELINE EX WOOD DOUBLE-HUNG QUARTER ROUND DIRECT-SET |
| 7. EWELXX | SITELINE EX WOOD ELLIPSE DIRECT-SET |

M.O. Brickmould	27 1/2" (699)	Masonry Openings for Brickmould, Flat & Adams Casing. Vertical measurements include subsill. (Subtract 1/2" from Masonry Opening for Unit Size)
M.O. Adams/Flat Casing	30 1/2" (775)	
Rough Opening	24 3/4" (629)	
Frame Size	24" (610)	
Daylight Opening	20 3/8" (518)	

- 15 1/8" (384)
- 16 5/8" (422)
- 12 3/4" (324)
- 12" (305)
- 8 3/8" (213)

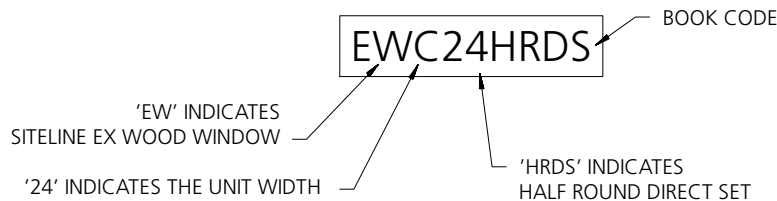
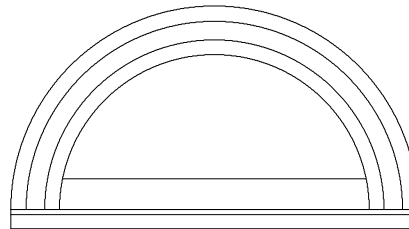

GENERAL NOTES

- UNIT ELEVATIONS ARE SHOWN WITHOUT EXTERIOR TRIM. MASONRY OPENING & ROUGH OPENING ARE EQUAL. UNIT SIZE AND FRAME SIZE ARE EQUAL.
- ALL UNITS SHOWN ARE AVAILABLE AS FIXED ONLY.
- TO DETERMINE DAYLIGHT OPENING DEDUCT 3-7/16" [87] FROM FRAME SIZE
- UNITS ARE SHOWN AS ONE LITES. SEE THE STANDARD LITE CUT PAGES FOR INFORMATION ON AVAILABLE LITE CUT CONFIGURATIONS.
- GLASS SIZES ARE NOMINAL.
- VALUES IN BRACKETS ARE MILLIMETER CONVERSIONS.

ELEVATION SYMBOL LEGEND:

M.O. MASONRY OPENING

ELEVATION NOTES

GEOMETRIC ELEVATIONS:

THE POSSIBLE SHAPES AND CONFIGURATIONS OF GEOMETRIC WINDOWS ARE TOO NUMEROUS TO OFFER IN A DRAWING FORMAT. CREATE THE OUTSIDE FRAME LINES OF THE GEOMETRIC WINDOW SHAPE DESIRED. REFER TO PAGE 11-72 TO 11-75 (SECTION DETAILS AND DIMENSIONS) TO FIND THE APPROPRIATE OFFSET DIMENSIONS FOR FRAME FEATURES AND DAYLIGHT OPENING. THE FOLLOWING INFORMATION DETAILS THE CREATION OF TRIM AND SUBSILL FOR GEOMETRIC ELEVATIONS.

STANDARD ELEVATIONS

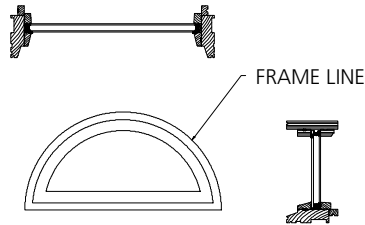

STANDARD GEOMETRIC ELEVATIONS

Geometric elevations (pages 11-7 to NO TAG) are drawn as 'Frame Only' (without trim) to simplify mulling and multiple assemblies. Trim and subsill applications can easily be offset from frame lines to create the desired trim and finish.

MULLING WOOD UNITS

Wood elevations from other product lines have brickmould shown as the standard offering. Refer to the Section Details & Dimensions page of that product type to determine the offset from brickmould to frame. This will show the outside frame line hidden by the brickmould.

TRIM - ALL SIDES

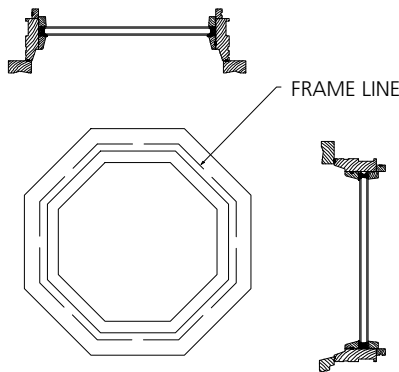

TRIM - ALL SIDES

Applying trim to all 4 sides of an elevation is an offset from the frame. See page 11-71 (Unit Sizing, Rough Openings & Masonry Openings) for offset dimensions of various trim options. Available on octagon and full circle units only.

SUBSILL

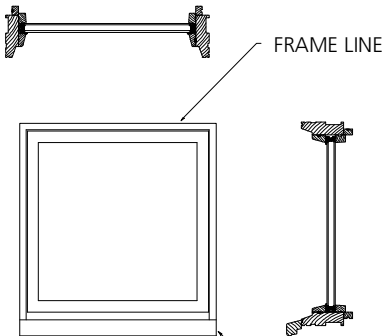

SUBSILL

Subsill is applied to the bottom of straight line portions of the window. The subsill is continuous to the outside dimensions of the units frame or trim. The application of subsill will affect the rough opening by adding 1" to the rough opening height. See page 11-71 (Unit Sizing, Rough Opening & Masonry Openings) for more information.

SUBSILL RESTRICTIONS

Subsill may not be applied to octagon, full round, oval, inverted half round and inverted quarter round units.

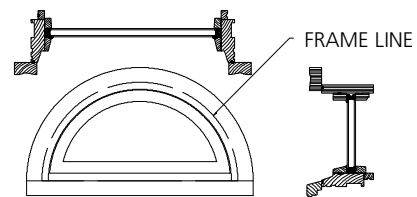

SUBSILL EXTENDS TO OUTSIDE EDGE OF THE FRAME

SUBSILL EXTENDS TO OUTSIDE EDGE OF THE BRICKMOULD

FULL ROUND UNITS

M.O. BRICKMOULD 27 1/2"(699)
M.O. ADAMS/FLAT CASING 30 1/2"(775)
ROUGH OPENING 24 3/4"(629)
FRAME SIZE 24"(610)
DAYLIGHT OPENING 20 3/8"(518)

31 1/2"(800)
34 1/2"(876)
28 3/4"(730)
28"(711)
24 3/8"(619)

33 1/2"(851)
36 1/2"(927)
30 3/4"(781)
30"(762)
26 3/8"(670)

39 1/2"(1003)
42 1/2"(1080)
36 3/4"(933)
36"(914)
32 3/8"(822)

45 1/2"(1156)
48 1/2"(1232)
42 3/4"(1086)
42"(1067)
38 3/8"(975)

27 1/2"(699)
30 1/2"(775)
24 3/4"(629)
24"(610)
20 3/8"(518)



EW24FRDS

31 1/2"(800)
34 1/2"(876)
28 3/4"(730)
28"(711)
24 3/8"(619)



EW28FRDS

33 1/2"(851)
36 1/2"(927)
30 3/4"(781)
30"(762)
26 3/8"(670)

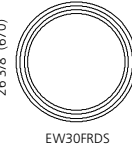

EW30FRDS

39 1/2"(1003)
42 1/2"(1080)
36 3/4"(933)
36"(914)
32 3/8"(822)

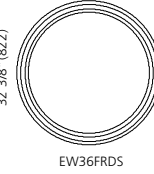

EW36FRDS

45 1/2"(1156)
48 1/2"(1232)
42 3/4"(1086)
42"(1067)
38 3/8"(975)

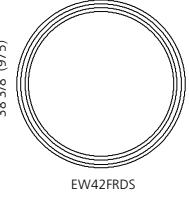

EW42FRDS

M.O. BRICKMOULD 51 1/2"(1308)
M.O. ADAMS/FLAT CASING 54 1/2"(1384)
ROUGH OPENING 48 3/4"(1238)
FRAME SIZE 48"(1219)
DAYLIGHT OPENING 44 3/8"(1127)

51 1/2"(1308)
54 1/2"(1384)
48 3/4"(1238)
48"(1219)
44 3/8"(1127)

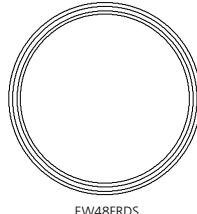

EW48FRDS

57 1/2"(1461)
60 1/2"(1537)
54 3/4"(1391)
54"(1372)
50 3/8"(1280)

57 1/2"(1461)
60 1/2"(1537)
54 3/4"(1391)
54"(1372)
50 3/8"(1280)

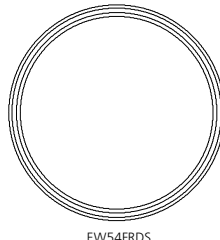

EW54FRDS

63 1/2"(1613)
66 1/2"(1689)
60 3/4"(1543)
60"(1524)
56 3/8"(1432)

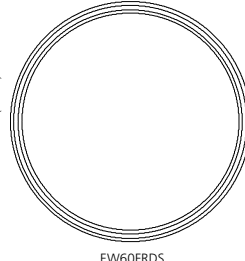

EW60FRDS

M.O. BRICKMOULD 75 1/2"(1918)
M.O. ADAMS/FLAT CASING 78 1/2"(1994)
ROUGH OPENING 72 3/4"(1848)
FRAME SIZE 72"(1829)
DAYLIGHT OPENING 68 3/8"(1737)

75 1/2"(1918)
78 1/2"(1994)
72 3/4"(1848)
72"(1829)
68 3/8"(1737)

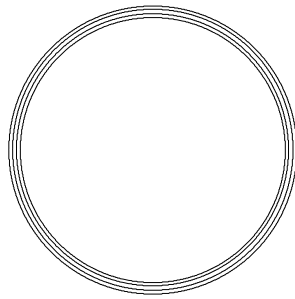

EW72FRDS

ELEVATION SYMBOL LEGEND:

M.O. = MASONRY OPENING
VALUES IN () ARE IN MILLIMETER CONVERSIONS

Note: Elevations shown DO NOT have exterior trim. Subtract 1/2" (12.7) from M.O. (Masonry Opening) for Unit Sizes. Masonry Openings above include Sill Nose, see Trim Options page for Sill Nose specifications. For other Trim Options refer to the Unit Sizing, Rough Opening & Masonry Openings page.

SCALE 1/4" = 1'

OVAL UNITS

M.O. BRICKMOULD
M.O. ADAMS/FLAT CASING
ROUGH OPENING
FRAME SIZE
DAYLIGHT OPENING

27 1/2" (699)
30 1/2" (775)
24 3/4" (629)
24" (610)
20 3/8" (518)

33 1/2" (851)
36 1/2" (927)
30 3/4" (781)
30" (762)
26 3/8" (670)

39 1/2" (1003)
42 1/2" (1080)
36 3/4" (933)
36" (914)
32 3/8" (822)

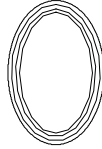

EWOV2436

51 1/2" (1308)
54 1/2" (1384)
48 3/4" (1238)
48" (1219)
44 3/8" (1127)

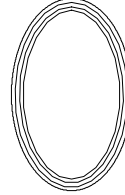

EWOV3048

M.O. BRICKMOULD
M.O. ADAMS/FLAT CASING
ROUGH OPENING
FRAME SIZE
DAYLIGHT OPENING

39 1/2" (1003)
42 1/2" (1080)
36 3/4" (933)
36" (914)
32 3/8" (822)

51 1/2" (1308)
54 1/2" (1384)
48 3/4" (1238)
48" (1219)
44 3/8" (1127)

27 1/2" (699)
30 1/2" (775)
24 3/4" (629)
24" (610)
20 3/8" (518)



EWOV3624

33 1/2" (851)
36 1/2" (927)
30 3/4" (781)
30" (762)
26 3/8" (670)



EWOV4830

ELEVATION SYMBOL LEGEND:

M.O. = MASONRY OPENING
VALUES IN () ARE IN MILLIMETER CONVERSIONS

Note: Elevations shown DO NOT have exterior trim. Subtract 1/2" (12.7) from M.O. (Masonry Opening) for Unit Sizes. Masonry Openings above include Sill Nose, see Trim Options page for Sill Nose specifications. For other Trim Options refer to the Unit Sizing, Rough Opening & Masonry Openings page.

ELLIPSE UNITS

M.O. BRICKMOULD
M.O. ADAMS/FLAT CASING
ROUGH OPENING
FRAME SIZE
DAYLIGHT OPENING

63 1/2" (1613)
66 1/2" (1689)
60 3/4" (1543)
60" (1524)
56 3/8" (1432)

75 1/2" (1918)
78 1/2" (1994)
72 3/4" (1848)
72" (1829)
68 3/8" (1737)

19 5/16" (491)
20 13/16" (529)
17 1/8" (435)
16 3/8" (416)
12 3/4" (324)



EWEL60



EWEL72

ELEVATION SYMBOL LEGEND:

M.O. = MASONRY OPENING

VALUES IN () ARE IN MILLIMETER CONVERSIONS

Note: Elevations shown DO NOT have exterior trim. Subtract 1/2" (12.7) from M.O. (Masonry Opening) for Unit Sizes. Masonry Openings above include Sill Nose, see Trim Options page for Sill Nose specifications. For other Trim Options refer to the Unit Sizing, Rough Opening & Masonry Openings page.

CASEMENT AND DOORS QUARTER ROUND UNITS

M.O. BRICKMOULD 21 1/2" (546)
M.O. ADAMS/FLAT CASING 24 1/2" (622)
ROUGH OPENING 18 3/4" (476)
FRAME SIZE 18" (457)
DAYLIGHT OPENING 14 3/8" (365)

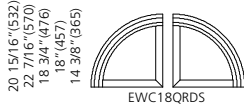

EWC18QRDS

23 1/2" (597)
26 1/2" (673)
20 3/4" (527)
20" (508)
16 3/8" (416)



EWC20QRDS

27 1/2" (699)
30 1/2" (775)
24 3/4" (629)
24" (610)
20 3/8" (518)

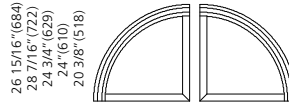

EWC24QRDS

31 1/2" (800)
34 1/2" (876)
28 3/4" (730)
28" (711)
24 3/8" (619)

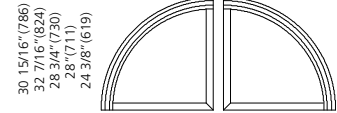

EWC28QRDS

M.O. BRICKMOULD 33 1/2" (851)
M.O. ADAMS/FLAT CASING 36 1/2" (927)
ROUGH OPENING 30 3/4" (781)
FRAME SIZE 30" (762)
DAYLIGHT OPENING 26 3/8" (670)

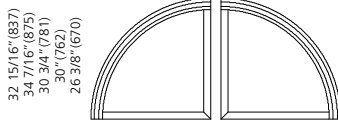

EWC30QRDS

35 1/2" (902)
38 1/2" (978)
32 3/4" (832)
32" (813)
28 3/8" (721)

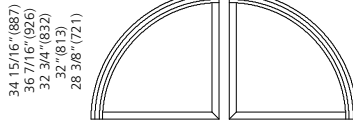

EWC32QRDS

39 1/2" (1003)
42 1/2" (1080)
36 3/4" (933)
36" (914)
32 3/8" (822)

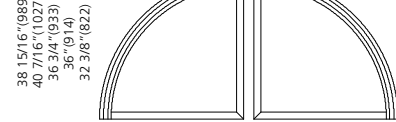

EWC36QRDS

M.O. BRICKMOULD 45 1/2" (1156)
M.O. ADAMS/FLAT CASING 48 1/2" (1232)
ROUGH OPENING 42 3/4" (1086)
FRAME SIZE 42" (1067)
DAYLIGHT OPENING 38 3/8" (975)

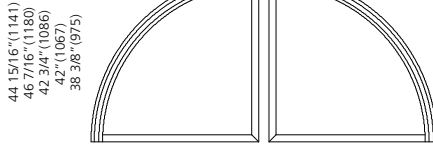

EWC42QRDS

51 1/2" (1308)
54 1/2" (1384)
48 3/4" (1238)
48" (1219)
44 3/8" (1127)

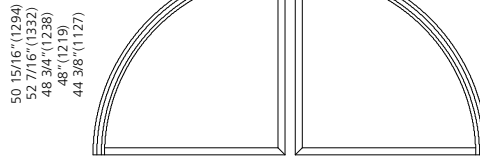

EWC48QRDS





ELEVATION SYMBOL LEGEND:





M.O. = MASONRY OPENING



VALUES IN () ARE IN MILLIMETER CONVERSIONS



Note: Elevations shown DO NOT have exterior trim. Subtract 1/2" (12.7) from M.O. (Masonry Opening) for Unit Sizes. Masonry Openings above include Sill Nose, see Trim Options page for Sill Nose specifications. For other Trim Options refer to the Unit Sizing, Rough Opening & Masonry Openings page.



CASEMENT HALF ROUND UNITS

M.O. BRICKMOULD	27 1/2" (699)	31 1/2" (800)	33 1/2" (851)	35 1/2" (902)	39 1/2" (1003)
M.O. ADAMS/FLAT CASING	30 1/2" (775)	34 1/2" (876)	36 1/2" (927)	38 1/2" (978)	42 1/2" (1080)
ROUGH OPENING	24 3/4" (629)	28 3/4" (730)	30 3/4" (781)	32 3/4" (832)	36 3/4" (933)
FRAME SIZE	24" (610)	28" (711)	30" (762)	32" (813)	36" (914)
DAYLIGHT OPENING	20 3/8" (518)	24 3/8" (619)	26 3/8" (670)	28 3/8" (721)	32 3/8" (822)
	14 15/16" (379) 16 7/16" (418) 19 3/4" (502) 12" (305) 8 3/8" (213)	16 15/16" (430) 18 7/16" (469) 14 3/4" (375) 14" (356) 10 3/8" (264)	17 15/16" (455) 19 7/16" (494) 15 3/4" (400) 15" (381) 11 3/8" (289)	18 15/16" (481) 20 7/16" (519) 16 3/4" (425) 16" (406) 12 3/8" (314)	20 15/16" (532) 22 7/16" (570) 18 3/4" (476) 18" (457) 14 3/8" (365)
					
	EWC24HRDS	EWC28HRDS	EWC30HRDS	EWC32HRDS	EWC36HRDS

M.O. BRICKMOULD	43 1/2" (1105)	45 1/2" (1156)	51 1/2" (1308)	57 1/2" (1461)
M.O. ADAMS/FLAT CASING	46 1/2" (1181)	48 1/2" (1232)	54 1/2" (1384)	60 1/2" (1537)
ROUGH OPENING	40 3/4" (1035)	42 3/4" (1086)	48 3/4" (1238)	54 3/4" (1391)
FRAME SIZE	40" (1016)	42" (1067)	48" (1219)	54" (1372)
DAYLIGHT OPENING	36 3/8" (924)	38 3/8" (975)	44 3/8" (1127)	50 3/8" (1280)
	22 15/16" (583) 24 7/16" (621) 20 3/4" (527) 20" (508) 16 3/8" (416)	23 15/16" (608) 25 7/16" (646) 21 3/4" (552) 17 3/8" (441)	26 15/16" (684) 28 7/16" (722) 24 3/4" (629) 24" (610) 20 3/8" (518)	29 15/16" (760) 31 7/16" (799) 27 3/4" (705) 27" (686) 23 3/8" (594)
				
	EWC40HRDS	EWC42HRDS	EWC48HRDS	EWC54HRDS

M.O. BRICKMOULD	59 1/2" (1511)	63 1/2" (1613)	67 1/2" (1715)
M.O. ADAMS/FLAT CASING	62 1/2" (1588)	66 1/2" (1689)	70 1/2" (1791)
ROUGH OPENING	56 3/4" (1441)	60 3/4" (1543)	64 3/4" (1645)
FRAME SIZE	56" (1422)	60" (1524)	64" (1626)
DAYLIGHT OPENING	52 3/8" (1330)	56 3/8" (1432)	60 3/8" (1534)
	30 15/16" (786) 32 7/16" (824) 28 3/4" (730) 28" (711) 24 3/8" (619)	32 15/16" (837) 34 7/16" (875) 30 3/4" (781) 30" (762) 26 3/8" (670)	34 15/16" (887) 36 7/16" (926) 32 3/4" (832) 32" (813) 28 3/8" (721)
			
	EWC56HRDS	EWC60HRDS	EWC64HRDS

M.O. BRICKMOULD	69 1/2" (1765)	75 1/2" (1918)
M.O. ADAMS/FLAT CASING	72 1/2" (1842)	78 1/2" (1994)
ROUGH OPENING	66 3/4" (1695)	72 3/4" (1848)
FRAME SIZE	66" (1676)	72" (1829)
DAYLIGHT OPENING	62 3/8" (1584)	68 3/8" (1737)
	35 15/16" (913) 37 7/16" (951) 33 3/4" (857) 33" (838) 29 3/8" (746)	38 15/16" (989) 40 7/16" (1027) 36 3/4" (933) 36" (914) 32 3/8" (822)
		
	EWC66HRDS	EWC72HRDS

M.O. BRICKMOULD	81 1/2" (2070)	87 1/2" (2223)
M.O. ADAMS/FLAT CASING	84 1/2" (2146)	90 1/2" (2299)
ROUGH OPENING	78 3/4" (2000)	84 3/4" (2153)
FRAME SIZE	78" (1981)	84" (2134)
DAYLIGHT OPENING	74 3/8" (1889)	80 3/8" (2042)
	41 15/16" (1065) 43 7/16" (1103) 39 3/4" (1010) 39 3/8" (991) 35 3/8" (899)	44 15/16" (1141) 46 7/16" (1180) 42 3/4" (1086) 42" (1067) 38 3/8" (975)
		
	EWC78HRDS	EWC84HRDS

ELEVATION SYMBOL LEGEND:

M.O. = MASONRY OPENING

VALUES IN () ARE IN MILLIMETER CONVERSIONS

Note: Elevations shown DO NOT have exterior trim. Subtract 1/2" (12.7) from M.O. (Masonry Opening) for Unit Sizes. Masonry Openings above include Sill Nose, see Trim Options page for Sill Nose specifications. For other Trim Options refer to the Unit Sizing, Rough Opening & Masonry Openings page.

SCALE 1/4" = 1'

CASEMENT HALF ROUND UNITS

M.O. BRICKMOULD
M.O. ADAMS/FLAT CASING
ROUGH OPENING
FRAME SIZE
DAYLIGHT OPENING

93 1/2" (2380)
96 1/2" (2451)
90 3/4" (2305)
90" (2286)
86 3/8" (2194)

99 1/2" (2527)
102 1/2" (2604)
96 3/4" (2457)
96" (2438)
92 3/8" (2346)

47 15/16" (1217)
49 7/16" (1256)
45 3/4" (1162)
45" (1143)
41 3/8" (1051)

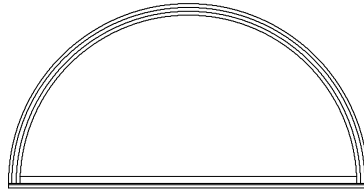

EWC90HRDS

50 15/16" (1294)
52 7/16" (1332)
48 3/4" (1238)
48" (1219)
44 3/8" (1127)

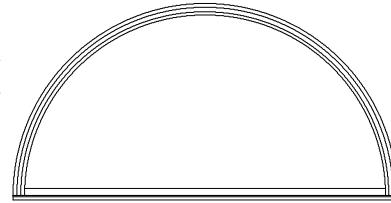

EWC96HRDS

ELEVATION SYMBOL LEGEND:

M.O. = MASONRY OPENING

VALUES IN () ARE IN MILLIMETER CONVERSIONS

Note: Elevations shown DO NOT have exterior trim. Subtract 1/2" (12.7) from M.O. (Masonry Opening) for Unit Sizes. Masonry Openings above include Sill Nose, see Trim Options page for Sill Nose specifications. For other Trim Options refer to the Unit Sizing, Rough Opening & Masonry Openings page.

SCALE 1/4" = 1'

CASEMENT EXTENDED HALF ROUND UNITS

M.O. BRICKMOULD 27 1/2" (699)
M.O. ADAMS/FLAT CASING 30 1/2" (775)
ROUGH OPENING 24 3/4" (629)
FRAME SIZE 24" (610)
DAYLIGHT OPENING 20 3/8" (518)

31 1/2" (800)
 34 1/2" (876)
 28 3/4" (730)
 28" (711)
 24 3/8" (619)

33 1/2" (851)
 36 1/2" (927)
 30 3/4" (781)
 30" (762)
 26 3/8" (670)

39 1/2" (1003)
 42 1/2" (1080)
 36 3/4" (933)
 36" (914)
 32 3/8" (822)

51 1/2" (1308)
 54 1/2" (1384)
 48 3/4" (1238)
 48" (1219)
 44 3/8" (1127)

20 15/16" (532)
 22 7/16" (570)
 18 3/4" (476)
 18" (457)
 14 3/8" (365)

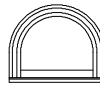

EW2418ELHRDS

22 15/16" (583)
 24 7/16" (621)
 20 3/4" (527)
 20" (508)
 16 3/8" (416)

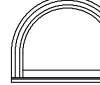

EW2820ELHRDS

23 15/16" (608)
 25 7/16" (646)
 21 3/4" (552)
 21" (533)
 17 3/8" (441)



EW3021ELHRDS

26 15/16" (684)
 28 7/16" (722)
 24 3/4" (629)
 24" (610)
 20 3/8" (518)



EW3624ELHRDS

32 15/16" (837)
 34 7/16" (875)
 30 3/4" (781)
 30" (762)
 26 3/8" (670)

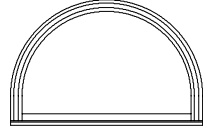

EW4830ELHRDS

26 15/16" (684)
 28 7/16" (722)
 24 3/4" (629)
 24" (610)
 20 3/8" (518)



EW2424ELHRDS

28 15/16" (735)
 30 7/16" (773)
 26 3/4" (679)
 26" (660)
 22 3/8" (568)



EW2826ELHRDS

29 15/16" (760)
 31 7/16" (799)
 27 3/4" (705)
 27" (686)
 23 3/8" (594)



EW3027ELHRDS

32 15/16" (837)
 34 7/16" (875)
 30 3/4" (781)
 30" (762)
 26 3/8" (670)



EW3630ELHRDS

38 15/16" (989)
 40 7/16" (1027)
 36 3/4" (933)
 36" (914)
 32 3/8" (822)

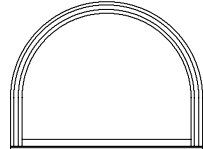

EW4836ELHRDS

32 15/16" (837)
 34 7/16" (875)
 30 3/4" (781)
 30" (762)
 26 3/8" (670)

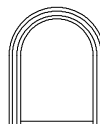

EW2430ELHRDS

34 15/16" (887)
 36 7/16" (926)
 32 3/4" (832)
 32" (813)
 28 3/8" (721)



EW2832ELHRDS

35 15/16" (913)
 37 7/16" (951)
 33 3/4" (857)
 33" (838)
 29 3/8" (746)

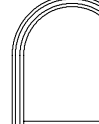

EW3033ELHRDS

38 15/16" (989)
 40 7/16" (1027)
 36 3/4" (933)
 36" (914)
 32 3/8" (822)



EW3636ELHRDS

44 15/16" (1141)
 46 7/16" (1180)
 42 3/4" (1086)
 42" (1067)
 38 3/8" (975)

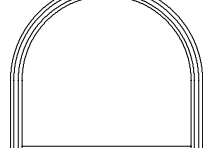

EW4842ELHRDS

38 15/16" (989)
 40 7/16" (1027)
 36 3/4" (933)
 36" (914)
 32 3/8" (822)

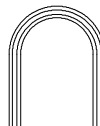

EW2436ELHRDS

40 15/16" (1040)
 42 7/16" (1078)
 38 3/4" (984)
 38" (965)
 34 3/8" (873)



EW2838ELHRDS

41 15/16" (1065)
 43 7/16" (1103)
 39 3/4" (1010)
 39" (991)
 35 3/8" (899)

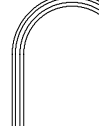

EW3039ELHRDS

44 15/16" (1141)
 46 7/16" (1180)
 42 3/4" (1086)
 42" (1067)
 38 3/8" (975)



EW3642ELHRDS

50 15/16" (1294)
 52 7/16" (1332)
 48 3/4" (1238)
 48" (1219)
 44 3/8" (1127)

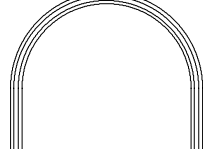

EW4848ELHRDS

50 15/16" (1294)
 52 7/16" (1332)
 48 3/4" (1238)
 48" (1219)
 44 3/8" (1127)

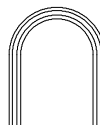

EW2448ELHRDS

52 15/16" (1345)
 54 7/16" (1383)
 50 3/4" (1289)
 50" (1270)
 46 3/8" (1178)



EW2850ELHRDS

53 15/16" (1370)
 55 7/16" (1408)
 51 3/4" (1314)
 51" (1295)
 47 3/8" (1203)

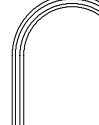

EW3051ELHRDS

56 15/16" (1446)
 58 7/16" (1484)
 54 3/4" (1391)
 54" (1372)
 50 3/8" (1280)



EW3654ELHRDS

62 15/16" (1599)
 64 7/16" (1637)
 60 3/4" (1543)
 60" (1524)
 56 3/8" (1432)

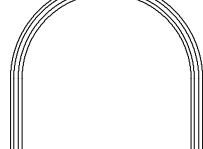

EW4860ELHRDS

62 15/16" (1599)
 64 7/16" (1637)
 60 3/4" (1543)
 60" (1524)
 56 3/8" (1432)

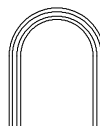

EW2460ELHRDS

64 15/16" (1649)
 66 7/16" (1688)
 62 3/4" (1594)
 62" (1575)
 58 3/8" (1483)



EW2862ELHRDS

65 15/16" (1675)
 67 7/16" (1713)
 63 3/4" (1619)
 63" (1600)
 59 3/8" (1508)

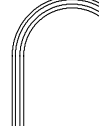

EW3063ELHRDS

68 15/16" (1751)
 70 7/16" (1789)
 66 3/4" (1695)
 66" (1676)
 62 3/8" (1584)



EW3666ELHRDS

74 15/16" (1903)
 76 7/16" (1942)
 72 3/4" (1848)
 72" (1829)
 68 3/8" (1737)

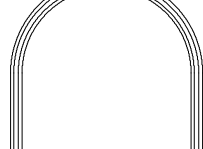

EW4872ELHRDS

ELEVATION SYMBOL LEGEND:
M.O. = MASONRY OPENING
 VALUES IN () ARE IN MILLIMETER CONVERSIONS

Note: Elevations shown DO NOT have exterior trim. Subtract 1/2" (12.7) from M.O. (Masonry Opening) for Unit Sizes. Masonry Openings above include Sill Nose, see Trim Options page for Sill Nose specifications. For other Trim Options refer to the Unit Sizing, Rough Opening & Masonry Openings page.

SCALE 1/4" = 1'

CASEMENT EXTENDED HALF ROUND UNITS

M.O. BRICKMOULD 27 1/2" (699)
M.O. ADAMS/FLAT CASING 30 1/2" (775)
ROUGH OPENING 24 3/4" (629)
FRAME SIZE 24" (610)
DAYLIGHT OPENING 20 3/8" (518)

31 1/2" (800)
34 1/2" (876)
28 3/4" (730)
28" (711)
24 3/8" (619)

33 1/2" (851)
36 1/2" (927)
30 3/4" (781)
30" (762)
26 3/8" (670)

39 1/2" (1003)
42 1/2" (1080)
36 3/4" (933)
36" (914)
32 3/8" (822)

51 1/2" (1308)
54 1/2" (1384)
48 3/4" (1238)
48" (1219)
44 3/8" (1127)

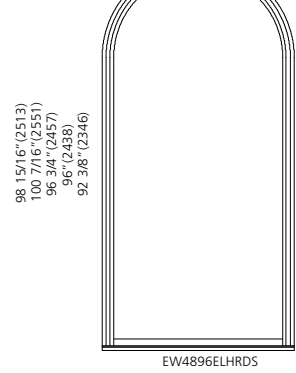
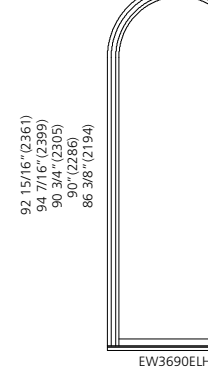
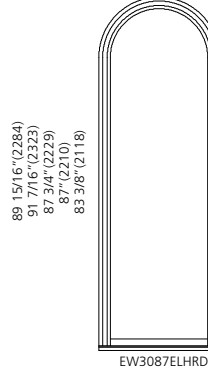
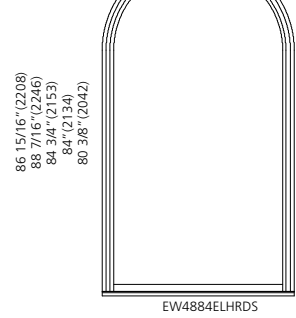
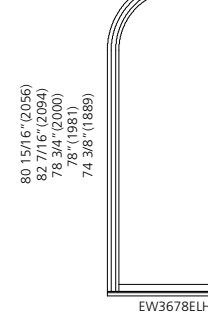
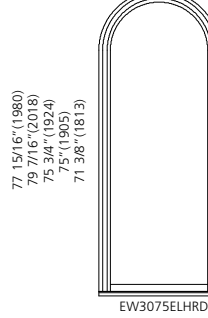
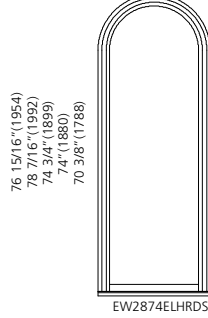
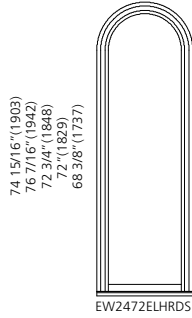

ELEVATION SYMBOL LEGEND:
M.O. = MASONRY OPENING
VALUES IN () ARE IN MILLIMETER CONVERSIONS

Note: Elevations shown DO NOT have exterior trim. Subtract 1/2" (12.7) from M.O. (Masonry Opening) for Unit Sizes. Masonry Openings above include Sill Nose, see Trim Options page for Sill Nose specifications. For other Trim Options refer to the Unit Sizing, Rough Opening & Masonry Openings page.

SCALE 1/4" = 1'

CASEMENT EXTENDED HALF ROUND UNITS

M.O. BRICKMOULD
M.O. ADAMS/FLAT CASING
ROUGH OPENING
FRAME SIZE
DAYLIGHT OPENING

59 1/2" (1511)
62 1/2" (1588)
56 3/4" (1441)
56" (1422)
52 3/8" (1330)

63 1/2" (1613)
66 1/2" (1689)
60 3/4" (1543)
60" (1524)
56 3/8" (1432)

69 1/2" (1765)
72 1/2" (1842)
66 3/4" (1695)
66" (1676)
62 3/8" (1584)

36 15/16" (938)
38 7/16" (976)
34 3/4" (883)
34" (864)
30 3/8" (772)

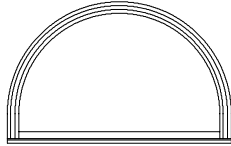

EW5634ELHRDS

38 15/16" (989)
40 7/16" (1027)
36 3/4" (933)
36" (914)
32 3/8" (822)

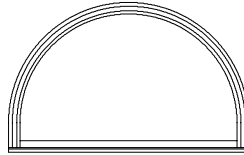

EW6036ELHRDS

41 15/16" (1065)
43 7/16" (1103)
39 3/4" (1010)
39" (991)
35 3/8" (899)

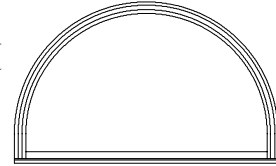

EW6639ELHRDS

42 15/16" (1091)
44 7/16" (1129)
40 3/4" (1035)
40" (1016)
36 3/8" (924)

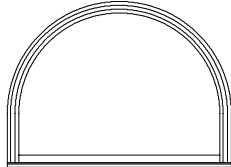

EW5640ELHRDS

44 15/16" (1141)
46 7/16" (1180)
42 3/4" (1086)
42" (1067)
38 3/8" (975)

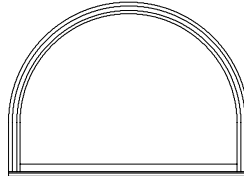

EW6042ELHRDS

47 15/16" (1217)
49 7/16" (1256)
45 3/4" (1162)
45" (1143)
41 3/8" (1051)

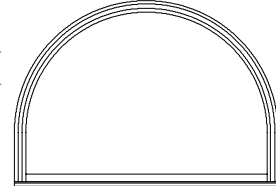

EW6645ELHRDS

48 15/16" (1243)
50 7/16" (1281)
46 3/4" (1187)
46" (1168)
42 3/8" (1076)

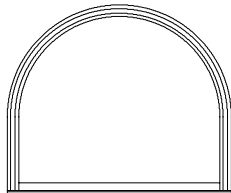

EW5646ELHRDS

50 15/16" (1294)
52 7/16" (1332)
48 3/4" (1238)
48" (1219)
44 3/8" (1127)

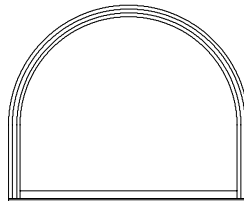

EW6048ELHRDS

53 15/16" (1370)
55 7/16" (1408)
51 3/4" (1314)
51" (1295)
47 3/8" (1203)

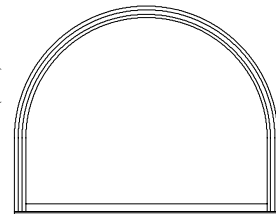

EW6651ELHRDS

54 15/16" (1395)
56 7/16" (1433)
52 3/4" (1340)
52" (1321)
48 3/8" (1229)

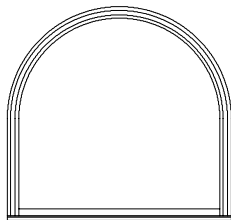

EW5652ELHRDS

56 15/16" (1446)
58 7/16" (1484)
54 3/4" (1391)
54" (1372)
50 3/8" (1280)

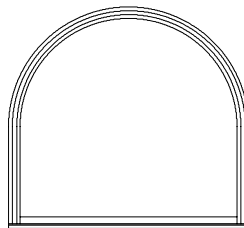

EW6054ELHRDS

59 15/16" (1522)
61 7/16" (1560)
57 3/4" (1467)
57" (1448)
53 3/8" (1356)

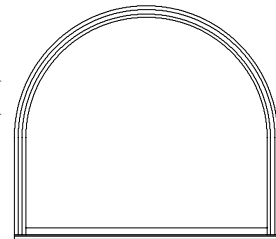

EW6657ELHRDS

66 15/16" (1700)
68 7/16" (1738)
64 3/4" (1645)
64" (1626)
60 3/8" (1534)

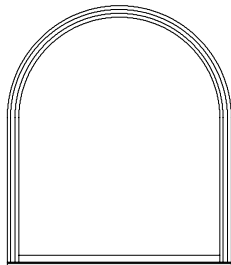

EW5664ELHRDS

68 15/16" (1751)
70 7/16" (1789)
66 3/4" (1695)
66" (1676)
62 3/8" (1584)

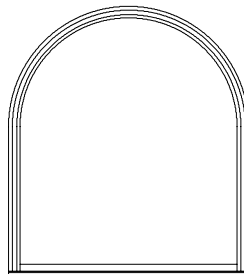

EW6066ELHRDS

71 15/16" (1827)
73 7/16" (1865)
69 3/4" (1772)
69" (1753)
65 3/8" (1661)

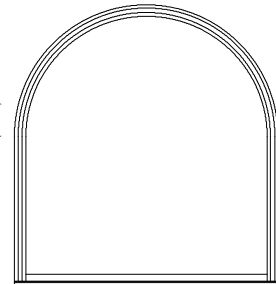

EW6669ELHRDS

ELEVATION SYMBOL LEGEND:

M.O. = MASONRY OPENING
VALUES IN () ARE IN MILLIMETER CONVERSIONS

Note: Elevations shown DO NOT have exterior trim. Subtract 1/2" (12.7) from M.O. (Masonry Opening) for Unit Sizes. Masonry Openings above include Sill Nose, see Trim Options page for Sill Nose specifications. For other Trim Options refer to the Unit Sizing, Rough Opening & Masonry Openings page.

SCALE 1/4" = 1'

CASEMENT EXTENDED HALF ROUND UNITS

M.O. BRICKMOULD
M.O. ADAMS/FLAT CASING
ROUGH OPENING
FRAME SIZE
DAYLIGHT OPENING

59 1/2"(1511)
62 1/2"(1588)
56 3/4"(1441)
56"(1422)
52 3/8"(1330)

63 1/2"(1613)
66 1/2"(1689)
60 3/4"(1543)
60"(1524)
56 3/8"(1432)

69 1/2"(1765)
72 1/2"(1842)
66 3/4"(1695)
66"(1676)
62 3/8"(1584)

78 15/16"(2005)
80 7/16"(2043)
76 3/4"(1949)
76"(1930)
72 3/8"(1838)

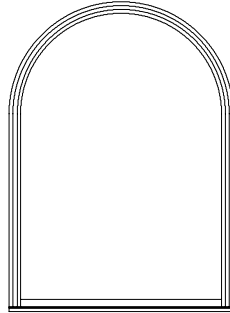

EW5676ELHRDS

80 15/16"(2056)
82 7/16"(2094)
78 3/4"(2000)
78"(1981)
74 3/8"(1889)

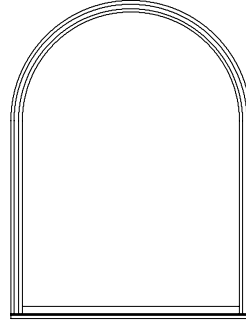

EW6078ELHRDS

83 15/16"(2132)
85 7/16"(2170)
81 3/4"(2076)
81"(2057)
77 3/8"(1965)

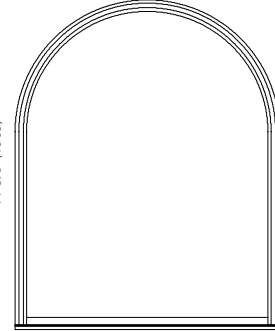

EW6681ELHRDS

90 15/16"(2310)
92 7/16"(2348)
88 3/4"(2254)
88"(2235)
84 3/8"(2143)

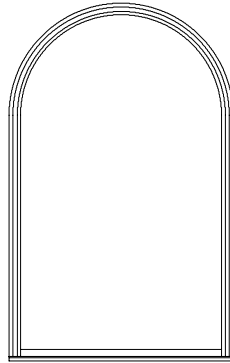

EW5688ELHRDS

92 15/16"(2361)
94 7/16"(2399)
90 3/4"(2305)
90"(2286)
86 3/8"(2194)

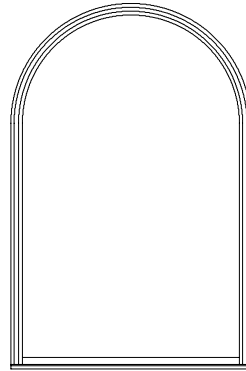

EW6090ELHRDS

95 15/16"(2437)
97 7/16"(2475)
93 3/4"(2381)
93"(2362)
89 3/8"(2270)

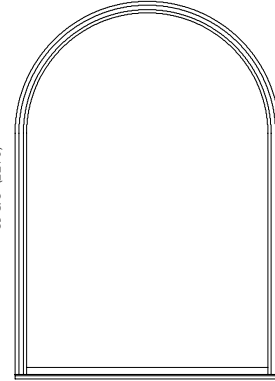

EW6693ELHRDS

102 15/16"(2615)
104 7/16"(2653)
100 3/4"(2559)
100"(2540)
96 3/8"(2448)

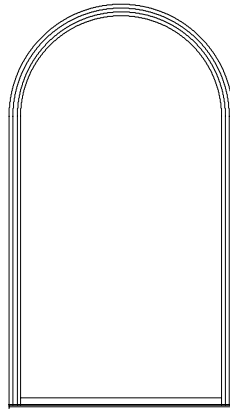

EW56100ELHRDS

104 15/16"(2665)
106 7/16"(2704)
102 3/4"(2610)
102"(2591)
98 3/8"(2499)

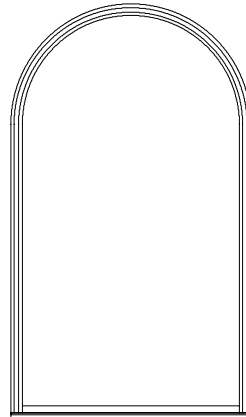

EW60102ELHRDS

107 15/16"(2742)
109 7/16"(2780)
105 3/4"(2686)
105"(2667)
101 3/8"(2575)

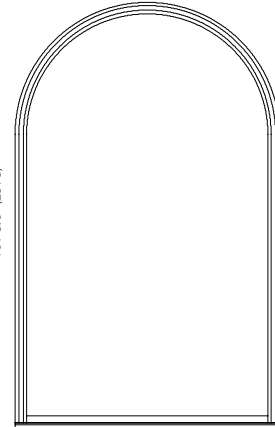

EW66105ELHRDS

ELEVATION SYMBOL LEGEND:

M.O. = MASONRY OPENING
VALUES IN () ARE IN MILLIMETER CONVERSIONS

Note: Elevations shown DO NOT have exterior trim. Subtract 1/2" (12.7) from M.O. (Masonry Opening) for Unit Sizes. Masonry Openings above include Sill Nose, see Trim Options page for Sill Nose specifications. For other Trim Options refer to the Unit Sizing, Rough Opening & Masonry Openings page.

SCALE 1/4" = 1'

CASEMENT EXTENDED HALF ROUND UNITS

M.O. BRICKMOULD
M.O. ADAMS/FLAT CASING
ROUGH OPENING
FRAME SIZE
DAYLIGHT OPENING

75 1/2" (1918)
78 1/2" (1994)
72 3/4" (1848)
72" (1829)
68 3/8" (1737)

87 1/2" (2223)
90 1/2" (2299)
84 3/4" (2153)
84" (2134)
80 3/8" (2042)

44 15/16" (1141)
46 7/16" (1180)
42 3/4" (1086)
42" (1067)
38 3/8" (975)

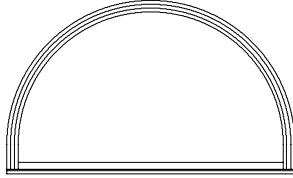

EW7242ELHRDS

50 15/16" (1294)
52 7/16" (1332)
48 3/4" (1238)
48" (1219)
44 3/8" (1127)

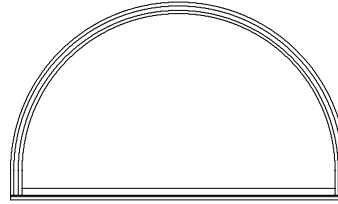

EW8448ELHRDS

50 15/16" (1294)
52 7/16" (1332)
48 3/4" (1238)
48" (1219)
44 3/8" (1127)

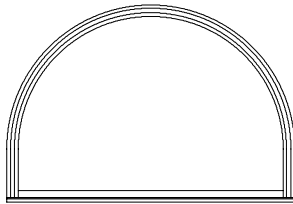

EW7248ELHRDS

56 15/16" (1446)
58 7/16" (1484)
54 3/4" (1391)
54" (1372)
50 3/8" (1280)

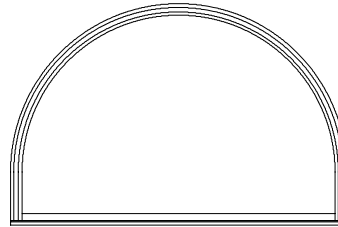

EW8454ELHRDS

56 15/16" (1446)
58 7/16" (1484)
54 3/4" (1391)
54" (1372)
50 3/8" (1280)

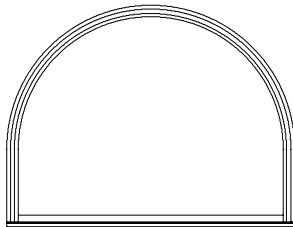

EW7254ELHRDS

62 15/16" (1599)
64 7/16" (1637)
60 3/4" (1543)
60" (1524)
56 3/8" (1432)

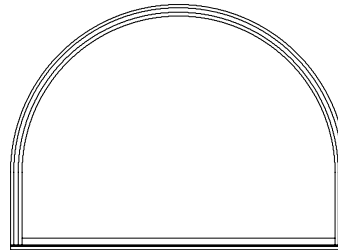

EW8460ELHRDS

62 15/16" (1599)
64 7/16" (1637)
60 3/4" (1543)
60" (1524)
56 3/8" (1432)

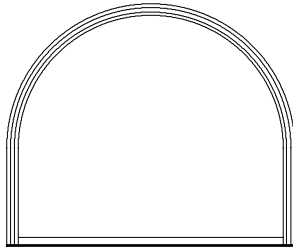

EW7260ELHRDS

68 15/16" (1751)
70 7/16" (1789)
66 3/4" (1695)
66" (1676)
62 3/8" (1584)

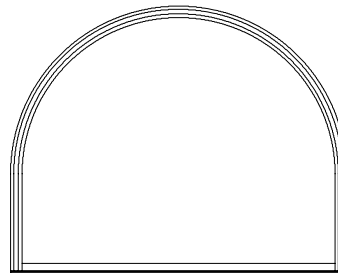

EW8466ELHRDS

74 15/16" (1903)
76 7/16" (1942)
72 3/4" (1848)
72" (1829)
68 3/8" (1737)

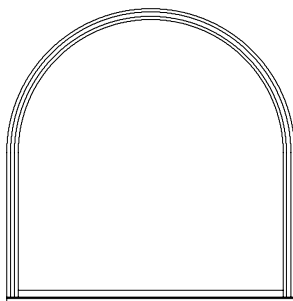

EW7272ELHRDS

80 15/16" (2056)
82 7/16" (2094)
78 3/4" (2000)
78" (1981)
74 3/8" (1889)

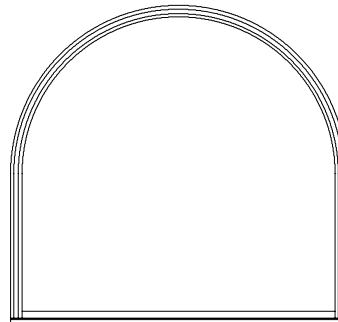

EW8478ELHRDS

ELEVATION SYMBOL LEGEND:
M.O. = MASONRY OPENING
VALUES IN () ARE IN MILLIMETER CONVERSIONS

Note: Elevations shown DO NOT have exterior trim. Subtract 1/2" (12.7) from M.O. (Masonry Opening) for Unit Sizes. Masonry Openings above include Sill Nose, see Trim Options page for Sill Nose specifications. For other Trim Options refer to the Unit Sizing, Rough Opening & Masonry Openings page.

SCALE 1/4" = 1'

CASEMENT EXTENDED HALF ROUND UNITS

M.O. BRICKMOULD	75 1/2" (1918)
M.O. ADAMS/FLAT CASING	78 1/2" (1994)
ROUGH OPENING	72 3/4" (1848)
FRAME SIZE	72" (1829)
DAYLIGHT OPENING	68 3/8" (1737)

86 15/16" (2208)
88 7/16" (2246)
84 3/4" (2153)
84" (2134)
80 3/8" (2042)

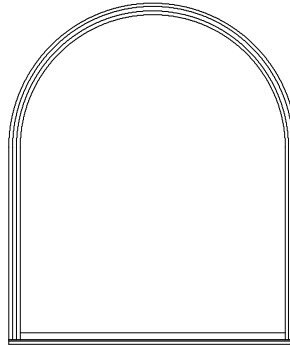

98 15/16" (2513)
100 7/16" (2551)
96 3/4" (2457)
96" (2438)
92 3/8" (2346)

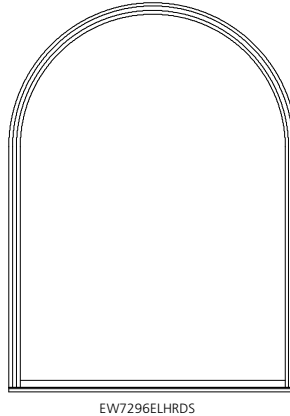

ELEVATION SYMBOL LEGEND:
M.O. = MASONRY OPENING
VALUES IN () ARE IN MILLIMETER CONVERSIONS

Note: Elevations shown DO NOT have exterior trim. Subtract 1/2" (12.7) from M.O. (Masonry Opening) for Unit Sizes. Masonry Openings above include Sill Nose, see Trim Options page for Sill Nose specifications. For other Trim Options refer to the Unit Sizing, Rough Opening & Masonry Openings page.

CASEMENT EXTENDED HALF ROUND UNITS

M.O. BRICKMOULD
M.O. ADAMS/FLAT CASING
ROUGH OPENING
FRAME SIZE
DAYLIGHT OPENING

93 1/2" (2380)
96 1/2" (2451)
90 3/4" (2305)
90" (2286)
86 3/8" (2194)

111 1/2" (2832)
114 1/2" (2908)
108 3/4" (2762)
108" (2743)
104 3/8" (2651)

53 15/16" (1370)
55 7/16" (1408)
51 3/4" (1314)
51" (1295)
47 3/8" (1203)

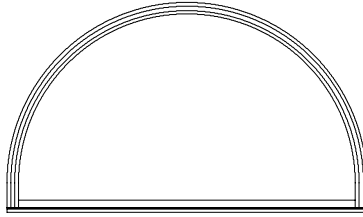

EW9051ELHRDS

62 15/16" (1599)
64 7/16" (1637)
60 3/4" (1543)
60" (1524)
56 3/8" (1432)

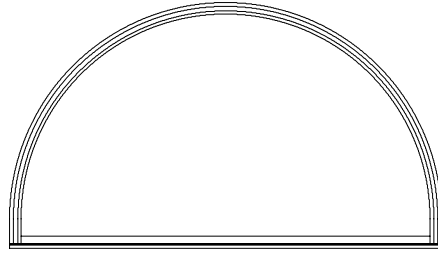

EW10860ELHRDS

59 15/16" (1522)
61 7/16" (1560)
57 3/4" (1467)
57" (1448)
53 3/8" (1356)

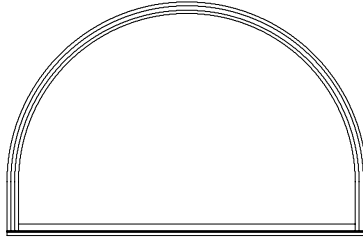

EW9057ELHRDS

68 15/16" (1751)
70 7/16" (1789)
66 3/4" (1695)
66" (1676)
62 3/8" (1584)

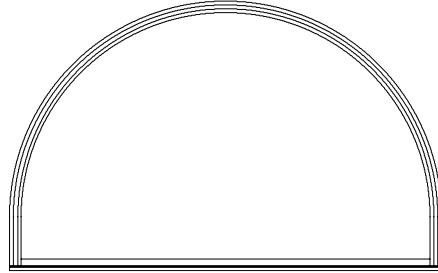

EW10866ELHRDS

65 15/16" (1675)
67 7/16" (1713)
63 3/4" (1619)
63" (1600)
59 3/8" (1508)

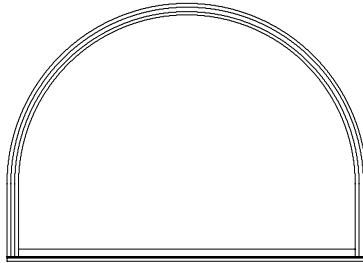

EW9063ELHRDS

71 15/16" (1827)
73 7/16" (1865)
69 3/4" (1772)
69" (1753)
65 3/8" (1661)

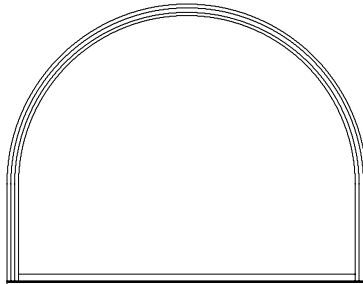

EW9069ELHRDS

83 15/16" (2132)
85 7/16" (2170)
81 3/4" (2076)
81" (2057)
77 3/8" (1965)

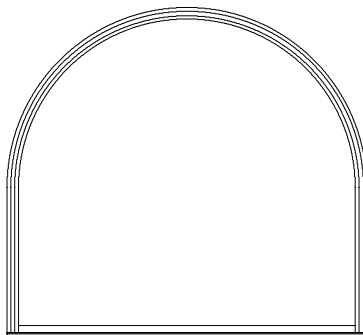

EW9081ELHRDS

SCALE 1/4" = 1'

CASEMENT EXTENDED LEG SEGMENT TOP UNITS

M.O. BRICKMOULD M.O. ADAMS/FLAT CASING ROUGH OPENING FRAME SIZE DAYLIGHT OPENING	27 1/2" (699) 30 1/2" (775) 24 3/4" (629) 24" (610) 20 3/8" (518)	31 1/2" (800) 34 1/2" (876) 28 3/4" (730) 28" (711) 24 3/8" (619)	33 1/2" (851) 36 1/2" (927) 30 3/4" (781) 30" (762) 26 3/8" (670)	39 1/2" (1003) 42 1/2" (1080) 36 3/4" (933) 36" (914) 32 3/8" (822)	51 1/2" (1308) 54 1/2" (1384) 48 3/4" (1238) 48" (1219) 44 3/8" (1127)
11 3/4" (298) 13 1/4" (337) 9 9/16" (243) 8 13/16" (224) 5 3/16" (132)		12 3/4" (324) 14 1/4" (362) 10 9/16" (268) 9 13/16" (249) 6 3/16" (157)		13 1/4" (337) 14 3/4" (375) 11 1/16" (281) 10 5/16" (262) 6 1/16" (170)	
17 3/4" (451) 19 1/4" (489) 15 9/16" (395) 14 13/16" (376) 11 3/16" (284)		18 3/4" (476) 20 1/4" (514) 16 9/16" (421) 15 13/16" (402) 12 3/16" (310)		19 1/4" (489) 20 3/4" (527) 17 1/16" (433) 16 5/16" (414) 12 11/16" (322)	
23 3/4" (603) 25 1/4" (641) 21 9/16" (547) 20 13/16" (529) 17 3/16" (437)		24 3/4" (629) 26 1/4" (667) 22 9/16" (573) 21 13/16" (554) 18 3/16" (462)		25 1/4" (641) 26 3/4" (679) 23 1/16" (585) 22 5/16" (567) 18 11/16" (475)	
29 3/4" (756) 31 1/4" (794) 27 9/16" (700) 26 13/16" (681) 23 3/16" (589)		30 3/4" (781) 32 1/4" (819) 28 9/16" (725) 27 13/16" (706) 24 3/16" (614)		31 1/4" (794) 32 3/4" (832) 29 1/16" (738) 28 5/16" (719) 24 11/16" (627)	
41 3/4" (1060) 43 1/4" (1099) 39 9/16" (1005) 38 13/16" (986) 35 3/16" (894)		42 3/4" (1088) 44 1/4" (1126) 40 9/16" (1030) 39 13/16" (1011) 36 3/16" (919)		43 1/4" (1099) 44 3/4" (1137) 41 1/16" (1043) 40 5/16" (1024) 36 11/16" (932)	
53 3/4" (1365) 55 1/4" (1403) 51 9/16" (1310) 50 13/16" (1291) 47 3/16" (1199)		54 3/4" (1391) 56 1/4" (1429) 52 9/16" (1335) 51 13/16" (1316) 48 3/16" (1224)		55 1/4" (1403) 56 3/4" (1441) 53 1/16" (1348) 52 5/16" (1329) 48 11/16" (1237)	
65 3/4" (1670) 67 1/4" (1708) 63 9/16" (1614) 62 13/16" (1595) 59 3/16" (1503)		66 3/4" (1695) 68 1/4" (1734) 64 9/16" (1640) 63 13/16" (1621) 60 3/16" (1529)		67 1/4" (1708) 68 3/4" (1746) 65 1/16" (1663) 64 5/16" (1634) 60 11/16" (1541)	
				57 1/4" (1454) 58 3/4" (1492) 55 1/16" (1399) 54 5/16" (1380) 50 11/16" (1287)	
				69 1/4" (1759) 70 3/4" (1797) 67 1/16" (1703) 66 5/16" (1684) 62 11/16" (1592)	
				68 7/16" (1738) 69 15/16" (1776) 66 1/4" (1683) 65 1/2" (1664) 61 7/8" (1572)	
				27 1/4" (692) 28 3/4" (730) 25 1/16" (637) 24 5/16" (618) 20 11/16" (525)	
				33 1/4" (845) 34 3/4" (883) 31 1/16" (789) 30 5/16" (770) 26 11/16" (678)	
				45 1/4" (1149) 46 3/4" (1187) 43 1/16" (1094) 42 5/16" (1075) 38 11/16" (983)	
				44 7/16" (1129) 45 15/16" (1169) 42 1/4" (1073) 41 1/2" (1054) 37 7/8" (962)	
				32 7/16" (824) 33 15/16" (862) 30 1/4" (768) 29 1/2" (749) 25 7/8" (657)	
				20 7/16" (519) 21 15/16" (557) 18 1/4" (464) 17 1/2" (445) 13 7/8" (352)	
				14 7/16" (367) 15 15/16" (405) 12 1/4" (311) 11 1/2" (292) 7 7/8" (200)	

ELEVATION SYMBOL LEGEND:
M.O. = MASONRY OPENING
 VALUES IN () ARE IN MILLIMETER CONVERSIONS

Note: Elevations shown DO NOT have exterior trim. Subtract 1/2" (12.7) from M.O. (Masonry Opening) for Unit Sizes. Masonry Openings above include Sill Nose, see Trim Options page for Sill Nose specifications. For other Trim Options refer to the Unit Sizing, Rough Opening & Masonry Openings page.

SCALE 1/4" = 1'

CASEMENT EXTENDED LEG SEGMENT TOP UNITS

M.O. BRICKMOULD	27 1/2" (699)	31 1/2" (800)	33 1/2" (851)	39 1/2" (1003)	51 1/2" (1308)
M.O. ADAMS/FLAT CASING	30 1/2" (775)	34 1/2" (876)	36 1/2" (927)	42 1/2" (1080)	54 1/2" (1384)
ROUGH OPENING	24 3/4" (629)	28 3/4" (730)	30 3/4" (781)	36 3/4" (933)	48 3/4" (1238)
FRAME SIZE	24" (610)	28" (711)	30" (762)	36" (914)	48" (1219)
DAYLIGHT OPENING	20 3/8" (518)	24 3/8" (619)	26 3/8" (670)	32 3/8" (822)	44 3/8" (1127)

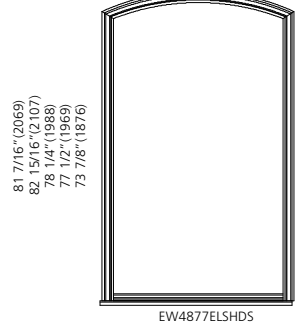
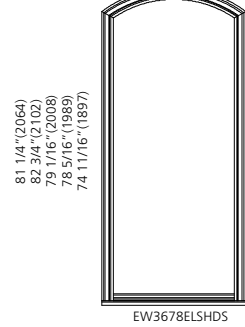
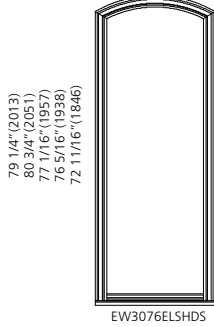
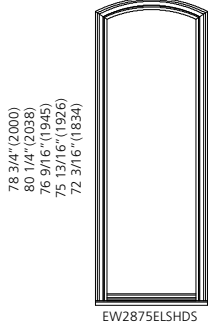
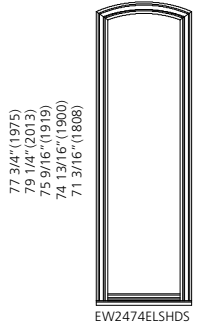

ELEVATION SYMBOL LEGEND:
M.O. = MASONRY OPENING
VALUES IN () ARE IN MILLIMETER CONVERSIONS

Note: Elevations shown DO NOT have exterior trim. Subtract 1/2" (12.7) from M.O. (Masonry Opening) for Unit Sizes. Masonry Openings above include Sill Nose, see Trim Options page for Sill Nose specifications. For other Trim Options refer to the Unit Sizing, Rough Opening & Masonry Openings page.

CASEMENT EXTENDED LEG SEGMENT TOP UNITS

**M.O. BRICKMOULD
M.O. ADAMS/FLAT CASING
ROUGH OPENING
FRAME SIZE
DAYLIGHT OPENING**

59 1/2" (1511)
62 1/2" (1588)
56 3/4" (1441)
56" (1422)
52 3/8" (1330)

63 1/2" (1613)
66 1/2" (1689)
60 3/4" (1543)
60" (1524)
56 3/8" (1432)

69 1/2" (1765)
72 1/2" (1842)
66 3/4" (1695)
66" (1676)
62 3/8" (1584)

16 7/16" (418)
17 15/16" (456)
14 1/4" (362)
13 1/2" (343)
9 7/8" (251)



EW5613ELSHDS

17 5/8" (448)
19 1/8" (486)
15 7/16" (392)
14 1/16" (373)
11 1/16" (281)



EW6014ELSHDS

19 9/16" (497)
21 1/16" (535)
17 3/8" (441)
16 5/8" (422)
13" (330)



EW6616ELSHDS

22 7/16" (570)
23 15/16" (608)
20 1/4" (514)
19 1/2" (495)
15 7/8" (403)

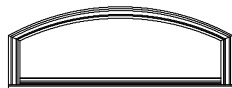

EW5619ELSHDS

23 5/8" (600)
25 1/8" (638)
21 7/16" (545)
20 1/16" (525)
17 1/16" (433)



EW6020ELSHDS

25 9/16" (649)
27 1/16" (687)
23 3/8" (594)
22 5/8" (575)
19" (483)



EW6622ELSHDS

28 7/16" (722)
29 15/16" (760)
26 1/4" (667)
25 1/2" (648)
21 7/8" (556)



EW5625ELSHDS

29 5/8" (752)
31 1/8" (791)
27 7/16" (697)
26 11/16" (678)
23 1/16" (586)



EW6026ELSHDS

31 9/16" (802)
33 1/16" (840)
29 3/8" (746)
28 5/8" (727)
25" (635)



EW6628ELSHDS

34 7/16" (875)
35 15/16" (913)
32 1/4" (819)
31 1/2" (800)
27 7/8" (708)



EW5631ELSHDS

35 5/8" (905)
37 1/8" (943)
33 7/16" (849)
32 11/16" (830)
29 1/16" (738)



EW6032ELSHDS

37 9/16" (954)
39 1/16" (992)
35 3/8" (899)
34 5/8" (879)
31" (787)



EW6634ELSHDS

46 7/16" (1180)
47 15/16" (1217)
44 1/4" (1124)
43 1/2" (1105)
39 7/8" (1013)



EW5643ELSHDS

47 5/8" (1210)
49 1/8" (1248)
45 7/16" (1154)
44 1/16" (1135)
41 1/16" (1043)



EW6044ELSHDS

49 9/16" (1259)
51 1/16" (1297)
47 3/8" (1203)
46 5/8" (1184)
43" (1092)



EW6646ELSHDS

58 7/16" (1484)
59 15/16" (1522)
56 1/4" (1429)
55 1/2" (1410)
51 7/8" (1318)



EW5655ELSHDS

59 5/8" (1514)
61 1/8" (1553)
57 7/16" (1459)
56 11/16" (1440)
53 1/16" (1348)



EW6056ELSHDS

61 9/16" (1564)
63 1/16" (1602)
59 3/8" (1508)
58 5/8" (1489)
55" (1397)



EW6658ELSHDS

70 7/16" (1789)
71 15/16" (1827)
68 1/4" (1734)
67 1/2" (1715)
63 7/8" (1622)



EW5667ELSHDS

71 5/8" (1819)
73 1/8" (1857)
69 7/16" (1764)
68 11/16" (1745)
65 1/16" (1653)

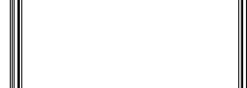

EW6068ELSHDS

73 9/16" (1868)
75 1/16" (1907)
71 3/8" (1813)
70 5/8" (1794)
67" (1702)



EW6670ELSHDS

ELEVATION SYMBOL LEGEND:

M.O. = MASONRY OPENING
VALUES IN () ARE IN MILLIMETER CONVERSIONS

Note: Elevations shown DO NOT have exterior trim. Subtract 1/2" (12.7) from M.O. (Masonry Opening) for Unit Sizes. Masonry Openings above include Sill Nose, see Trim Options page for Sill Nose specifications. For other Trim Options refer to the Unit Sizing, Rough Opening & Masonry Openings page.

SCALE 1/4" = 1'

CASEMENT EXTENDED LEG SEGMENT TOP UNITS

M.O. BRICKMOUND
M.O. ADAMS/FLAT CASING
ROUGH OPENING
FRAME SIZE
DAYLIGHT OPENING

59 1/2" (1511)
62 1/2" (1588)
56 3/4" (1441)
56" (1422)
52 3/8" (1330)

63 1/2" (1613)
66 1/2" (1689)
60 3/4" (1543)
60" (1524)
56 3/8" (1432)

69 1/2" (1765)
72 1/2" (1842)
66 3/4" (1695)
66" (1676)
62 3/8" (1584)

82 7/16" (2094)
83 15/16" (2132)
80 1/4" (2038)
79 1/2" (2019)
75 7/8" (1927)

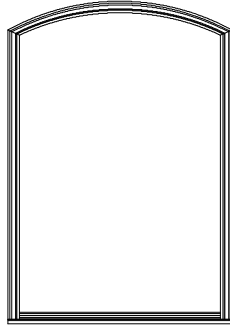

EW5679ELSHDS

83 5/8" (2124)
85 1/8" (2161)
81 7/16" (2069)
80 11/16" (2049)
77 1/16" (1957)

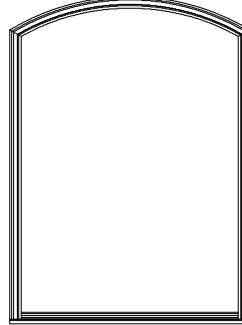

EW6080ELSHDS

85 9/16" (2173)
87 1/16" (2211)
83 3/8" (2118)
82 3/8" (2099)
79" (2007)

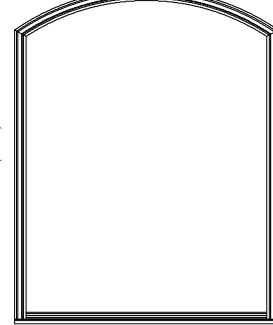

EW6682ELSHDS

ELEVATION SYMBOL LEGEND:

M.O. = MASONRY OPENING

VALUES IN () ARE IN MILLIMETER CONVERSIONS

Note: Elevations shown DO NOT have exterior trim. Subtract 1/2" (12.7) from M.O. (Masonry Opening) for Unit Sizes. Masonry Openings above include Sill Nose, see Trim Options page for Sill Nose specifications. For other Trim Options refer to the Unit Sizing, Rough Opening & Masonry Openings page.

CASEMENT EXTENDED LEG SEGMENT TOP UNITS

**M.O. BRICKMOULD
M.O. ADAMS/FLAT CASING
ROUGH OPENING
FRAME SIZE
DAYLIGHT OPENING**

17 3/8" (441) 18 7/8" (479) 15 3/16" (386) 14 7/16" (367) 10 13/16" (275)	75 1/2" (1918) 78 1/2" (1994) 72 3/4" (1848) 72" (1829) 68 3/8" (1737)	87 1/2" (2223) 90 1/2" (2299) 84 3/4" (2153) 84" (2134) 80 3/8" (2042)		20 1/2" (521) 22" (559) 18 5/16" (465) 17 9/16" (446) 13 15/16" (354)	
23 3/8" (594) 24 7/8" (632) 21 3/16" (538) 20 7/16" (519) 16 13/16" (427)				26 1/2" (673) 28" (711) 24 5/16" (618) 23 9/16" (598) 19 15/16" (506)	
29 3/8" (746) 30 7/8" (784) 27 3/16" (691) 26 7/16" (672) 22 13/16" (579)				32 1/2" (826) 34" (864) 30 5/16" (770) 29 9/16" (751) 25 15/16" (659)	
35 3/8" (899) 36 7/8" (937) 33 3/16" (843) 32 7/16" (824) 28 13/16" (732)				38 1/2" (978) 40" (1016) 36 5/16" (922) 35 9/16" (903) 31 15/16" (811)	
47 3/8" (1203) 48 7/8" (1241) 45 3/16" (1148) 44 7/16" (1129) 40 13/16" (1037)				50 1/2" (1283) 52" (1321) 48 5/16" (1227) 47 9/16" (1208) 43 15/16" (1116)	
59 3/8" (1508) 60 7/8" (1546) 57 3/16" (1453) 56 7/16" (1434) 52 13/16" (1341)				62 1/2" (1588) 64" (1626) 60 5/16" (1532) 59 9/16" (1513) 55 15/16" (1421)	
71 3/8" (1813) 72 7/8" (1851) 69 3/16" (1757) 68 7/16" (1738) 64 13/16" (1646)				74 1/2" (1892) 76" (1930) 72 5/16" (1837) 71 9/16" (1818) 67 15/16" (1726)	

ELEVATION SYMBOL LEGEND:

M.O. = MASONRY OPENING
VALUES IN () ARE IN MILLIMETER CONVERSIONS

Note: Elevations shown DO NOT have exterior trim. Subtract 1/2" (12.7) from M.O. (Masonry Opening) for Unit Sizes. Masonry Openings above include Sill Nose, see Trim Options page for Sill Nose specifications. For other Trim Options refer to the Unit Sizing, Rough Opening & Masonry Openings page.

SCALE 1/4" = 1'

CASEMENT EXTENDED LEG SEGMENT TOP UNITS

M.O. BRICKMOULD
M.O. ADAMS/FLAT CASING
ROUGH OPENING
FRAME SIZE
DAYLIGHT OPENING

75 1/2" (1918)
78 1/2" (1994)
72 3/4" (1848)
72" (1829)
68 3/8" (1737)

87 1/2" (2223)
90 1/2" (2299)
84 3/4" (2153)
84" (2134)
80 3/8" (2042)

83 3/8" (2118)
84 7/8" (2155)
81 3/16" (2062)
80 7/16" (2043)
76 13/16" (1951)

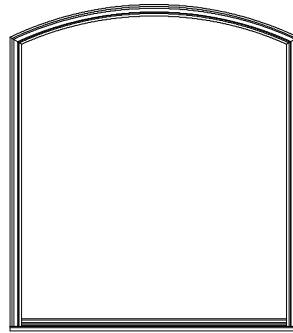

EW7280ELSHDS

86 1/2" (2197)
88" (2235)
84 5/16" (2142)
83 9/16" (2122)
79 15/16" (2030)

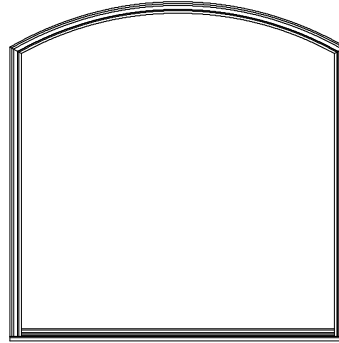

EW8483ELSHDS

ELEVATION SYMBOL LEGEND:

M.O. = MASONRY OPENING

VALUES IN () ARE IN MILLIMETER CONVERSIONS

Note: Elevations shown DO NOT have exterior trim. Subtract 1/2" (12.7) from M.O. (Masonry Opening) for Unit Sizes. Masonry Openings above include Sill Nose, see Trim Options page for Sill Nose specifications. For other Trim Options refer to the Unit Sizing, Rough Opening & Masonry Openings page.

CASEMENT EXTENDED LEG SEGMENT TOP UNITS

M.O. BRICKMOULD
M.O. ADAMS/FLAT CASING
ROUGH OPENING
FRAME SIZE
DAYLIGHT OPENING

93 1/2" (2380)
96 1/2" (2451)
90 3/4" (2305)
90" (2286)
86 3/8" (2194)

111 1/2" (2832)
114 1/2" (2908)
108 3/4" (2762)
108" (2743)
104 3/8" (2651)

22 5/16" (567)
23 13/16" (605)
20 1/8" (511)
19 3/8" (492)
15 3/4" (400)



EW9019ELSHDS

28 15/16" (735)
30 7/16" (773)
26 3/4" (679)
26" (660)
22 3/8" (568)



EW10825ELSHDS

28 5/16" (719)
29 13/16" (757)
26 1/8" (664)
25 3/8" (645)
21 3/4" (552)



EW9025ELSHDS

36 15/16" (938)
36 7/16" (926)
32 3/4" (832)
32" (813)
28 3/8" (721)



EW10831ELSHDS

34 5/16" (872)
35 13/16" (910)
32 1/8" (816)
31 3/8" (797)
27 3/4" (705)

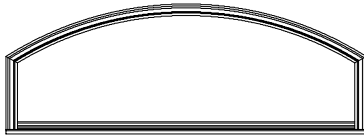

EW9031ELSHDS

40 15/16" (1040)
42 7/16" (1078)
38 3/4" (984)
38" (965)
34 3/8" (873)

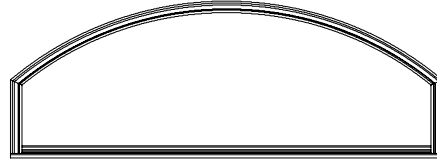

EW10837ELSHDS

40 5/16" (1024)
41 13/16" (1062)
38 1/8" (968)
37 3/8" (949)
33 3/4" (857)



EW9037ELSHDS

46 15/16" (1192)
48 7/16" (1230)
44 3/4" (1137)
44" (1118)
40 3/8" (1026)

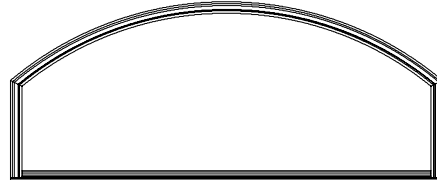

EW10843ELSHDS

52 5/16" (1329)
53 13/16" (1367)
50 1/8" (1273)
49 3/8" (1254)
45 3/4" (1162)

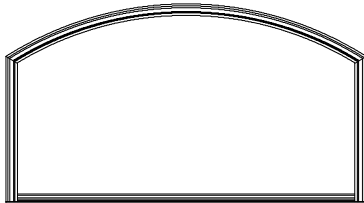

EW9049ELSHDS

58 15/16" (1497)
60 7/16" (1535)
56 3/4" (1441)
56" (1422)
52 3/8" (1330)

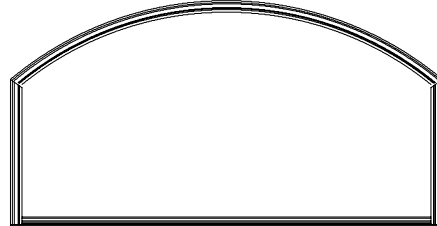

EW10855ELSHDS

64 5/16" (1634)
65 13/16" (1672)
61 1/8" (1553)
61 3/8" (1539)
57 3/4" (1467)

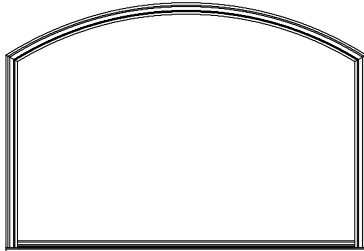

EW9061ELSHDS

76 5/16" (1938)
77 13/16" (1976)
74 1/8" (1883)
73 3/8" (1864)
69 3/4" (1772)

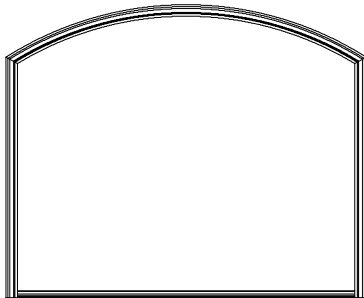

EW9073ELSHDS

SCALE 1/4" = 1'

DOUBLE-HUNG QUARTER ROUND UNITS

M.O. BRICKMOULD 32 7/8" (835)
M.O. ADAMS/FLAT CASING 35 7/8" (911)
ROUGH OPENING 30 1/8" (765)
FRAME SIZE 29 3/8" (746)
DAYLIGHT OPENING 25 3/4" (654)

36 7/8" (937)
 39 7/8" (1013)
 34 1/8" (867)
 33 3/8" (848)
 29 3/4" (756)

40 7/8" (1038)
 43 7/8" (1114)
 38 1/8" (968)
 37 3/8" (949)
 33 3/4" (857)

31 13/16" (808)
 33 5/16" (846)
 30 1/8" (765)
 29 3/8" (746)
 25 3/4" (654)

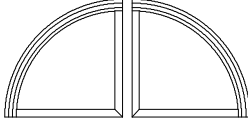

EWD29QRDS

35 13/16" (910)
 37 5/16" (948)
 34 1/8" (867)
 33 3/8" (848)
 29 3/4" (756)

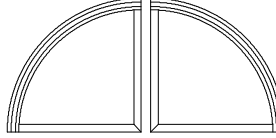

EWD33QRDS

39 13/16" (1011)
 41 5/16" (1049)
 36 1/8" (968)
 37 3/8" (949)
 33 3/4" (857)

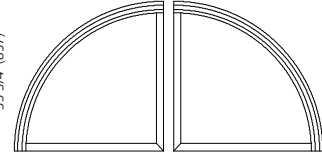

EWD37QRDS

ELEVATION SYMBOL LEGEND:

M.O. = MASONRY OPENING

VALUES IN () ARE IN MILLIMETER CONVERSIONS

Note: Elevations shown DO NOT have exterior trim. Subtract 1/2" (12.7) from M.O. (Masonry Opening) for Unit Sizes. Masonry Openings above include Sill Nose, see Trim Options page for Sill Nose specifications. For other Trim Options refer to the Unit Sizing, Rough Opening & Masonry Openings page.

SCALE 1/4" = 1'

DOUBLE-HUNG HALF ROUND UNITS

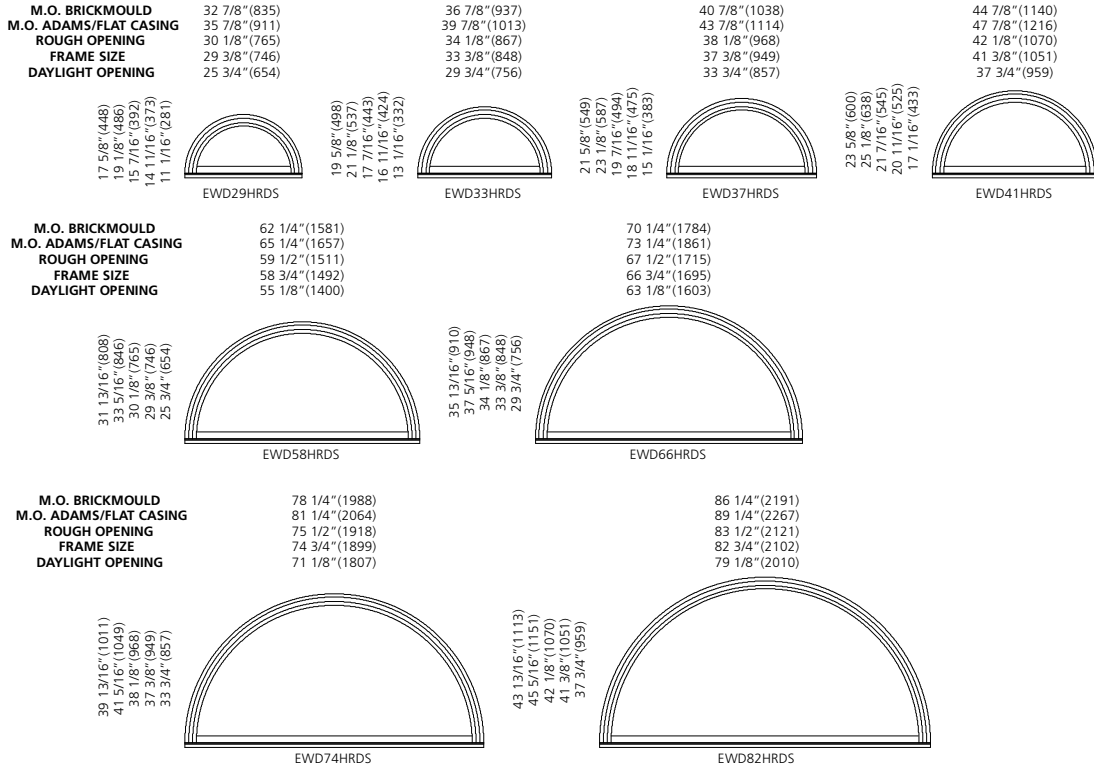











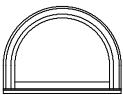

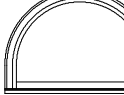
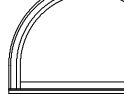
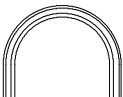
ELEVATION SYMBOL LEGEND:
M.O. = MASONRY OPENING
 VALUES IN () ARE IN MILLIMETER CONVERSIONS

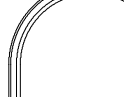
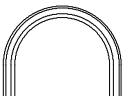
Note: Elevations shown DO NOT have exterior trim. Subtract 1/2" (12.7) from M.O. (Masonry Opening) for Unit Sizes. Masonry Openings above include Sill Nose, see Trim Options page for Sill Nose specifications. For other Trim Options refer to the Unit Sizing, Rough Opening & Masonry Openings page.

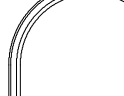
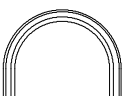
SCALE 1/4" = 1'

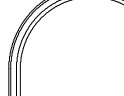
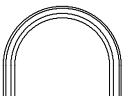
DOUBLE-HUNG EXTENDED HALF ROUND UNITS

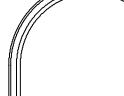
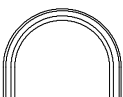
M.O. BRICKMOULD
M.O. ADAMS/FLAT CASING
ROUGH OPENING
FRAME SIZE
DAYLIGHT OPENING

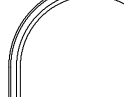
23 5/8" (600) 25 1/8" (638) 21 7/16" (545) 20 11/16" (525) 17 1/16" (433)		25 5/8" (651) 27 1/8" (689) 23 7/16" (595) 22 11/16" (576) 19 1/16" (484)		27 5/8" (702) 29 1/8" (740) 25 7/16" (646) 24 11/16" (627) 21 1/16" (535)		29 5/8" (752) 31 1/8" (791) 27 7/16" (697) 26 11/16" (678) 23 1/16" (586)	
29 5/8" (752) 31 1/8" (791) 27 7/16" (697) 26 11/16" (678) 23 1/16" (586)		31 5/8" (803) 33 1/8" (841) 29 7/16" (748) 28 11/16" (729) 25 1/16" (637)		33 5/8" (854) 35 1/8" (892) 31 7/16" (799) 30 11/16" (779) 27 1/16" (687)		35 5/8" (905) 37 1/8" (943) 33 7/16" (849) 32 11/16" (830) 29 1/16" (738)	
35 5/8" (905) 37 1/8" (943) 33 7/16" (849) 32 11/16" (830) 29 1/16" (738)		37 5/8" (956) 39 1/8" (994) 35 7/16" (900) 34 11/16" (881) 31 1/16" (789)		39 5/8" (1006) 41 1/8" (1045) 37 7/16" (951) 36 11/16" (932) 33 1/16" (840)		41 5/8" (1057) 43 1/8" (1095) 39 7/16" (1002) 38 11/16" (983) 35 1/16" (891)	
41 5/8" (1057) 43 1/8" (1095) 39 7/16" (1002) 38 11/16" (983) 35 1/16" (891)		43 5/8" (1108) 45 1/8" (1146) 41 7/16" (1053) 40 11/16" (1033) 37 1/16" (941)		45 5/8" (1159) 47 1/8" (1197) 43 7/16" (1103) 42 11/16" (1084) 39 1/16" (992)		47 5/8" (1210) 49 1/8" (1248) 45 7/16" (1154) 44 11/16" (1135) 41 1/16" (1043)	
53 5/8" (1362) 55 1/8" (1400) 51 7/16" (1307) 50 11/16" (1287) 47 1/16" (1195)		55 5/8" (1413) 57 1/8" (1451) 53 7/16" (1357) 52 11/16" (1338) 49 1/16" (1246)		57 5/8" (1464) 59 1/8" (1502) 55 7/16" (1408) 54 11/16" (1389) 51 1/16" (1297)		59 5/8" (1514) 61 1/8" (1553) 57 7/16" (1459) 56 11/16" (1440) 53 1/16" (1348)	
65 5/8" (1667) 67 1/8" (1705) 63 7/16" (1611) 62 11/16" (1592) 59 1/16" (1500)		67 5/8" (1718) 69 1/8" (1756) 65 7/16" (1662) 64 11/16" (1643) 61 1/16" (1551)		69 5/8" (1768) 71 1/8" (1807) 67 7/16" (1713) 66 11/16" (1694) 63 1/16" (1602)		71 5/8" (1819) 73 1/8" (1857) 69 7/16" (1764) 68 11/16" (1745) 65 1/16" (1653)	

ELEVATION SYMBOL LEGEND:

M.O. = MASONRY OPENING
VALUES IN () ARE IN MILLIMETER CONVERSIONS

Note: Elevations shown DO NOT have exterior trim. Subtract 1/2" (12.7) from M.O. (Masonry Opening) for Unit Sizes. Masonry Openings above include Sill Nose, see Trim Options page for Sill Nose specifications. For other Trim Options refer to the Unit Sizing, Rough Opening & Masonry Openings page.

SCALE 1/4" = 1'

DOUBLE-HUNG EXTENDED HALF ROUND UNITS

M.O. BRICKMOULD 32 7/8" (835)
M.O. ADAMS/FLAT CASING 35 7/8" (911)
ROUGH OPENING 30 1/8" (765)
FRAME SIZE 29 3/8" (746)
DAYLIGHT OPENING 25 3/4" (654)

36 7/8" (937)
39 7/8" (1013)
34 1/8" (867)
33 3/8" (848)
29 3/4" (756)

40 7/8" (1038)
43 7/8" (1114)
38 1/8" (968)
37 3/8" (949)
33 3/4" (857)

44 7/8" (1140)
47 7/8" (1216)
42 1/8" (1070)
41 3/8" (1051)
37 3/4" (959)

77 5/8" (1972)
79 1/8" (2016)
75 7/16" (1916)
74 1/16" (1897)
71 1/16" (1805)

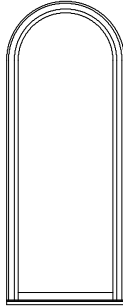

EWD2974ELHRDS

79 5/8" (2022)
81 1/8" (2061)
77 7/16" (1967)
76 11/16" (1948)
73 1/16" (1856)

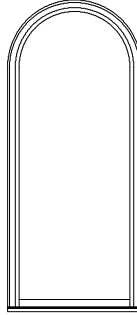

EWD3376ELHRDS

81 5/8" (2073)
83 1/8" (2111)
79 7/16" (2018)
78 1/16" (1999)
75 1/16" (1907)

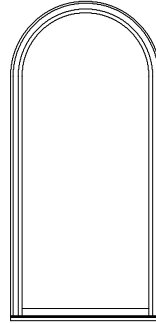

EWD3778ELHRDS

83 5/8" (2124)
85 1/8" (2162)
81 7/16" (2069)
80 11/16" (2049)
77 1/16" (1957)

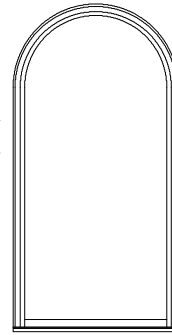

EWD4180ELHRDS

89 5/8" (2276)
91 1/8" (2316)
87 7/16" (2231)
86 11/16" (2202)
83 1/16" (2110)

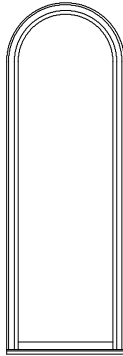

EWD2986ELHRDS

91 5/8" (2327)
93 1/8" (2365)
89 7/16" (2272)
88 11/16" (2253)
85 1/16" (2161)

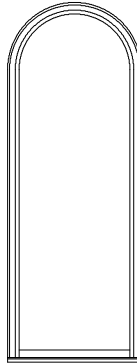

EWD3388ELHRDS

93 5/8" (2378)
95 1/8" (2416)
91 7/16" (2323)
90 1/16" (2303)
87 1/16" (2211)

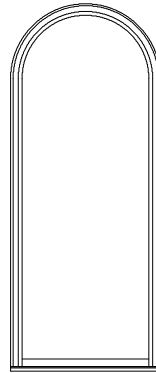

EWD3790ELHRDS

95 5/8" (2429)
97 1/8" (2467)
93 7/16" (2373)
92 11/16" (2354)
89 1/16" (2262)

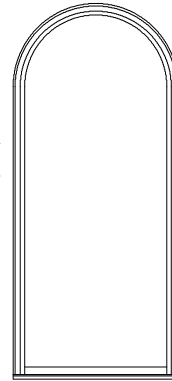

EWD4192ELHRDS

ELEVATION SYMBOL LEGEND:
M.O. = MASONRY OPENING
VALUES IN () ARE IN MILLIMETER CONVERSIONS

Note: Elevations shown DO NOT have exterior trim. Subtract 1/2" (12.7) from M.O. (Masonry Opening) for Unit Sizes. Masonry Openings above include Sill Nose, see Trim Options page for Sill Nose specifications. For other Trim Options refer to the Unit Sizing, Rough Opening & Masonry Openings page.

DOUBLE-HUNG EXTENDED HALF ROUND UNITS

M.O. BRICKMOULD
M.O. ADAMS/FLAT CASING
ROUGH OPENING
FRAME SIZE
DAYLIGHT OPENING

62 1/4" (1581)
65 1/4" (1657)
59 1/2" (1511)
58 3/4" (1492)
55 1/8" (1400)

70 1/4" (1784)
73 1/4" (1861)
67 1/2" (1715)
66 3/4" (1695)
63 1/8" (1603)

78 1/4" (1988)
81 1/4" (2064)
75 1/2" (1918)
74 3/4" (1899)
71 1/8" (1807)

38 5/16" (973)
39 13/16" (1011)
36 1/8" (918)
35 3/8" (899)
31 3/4" (806)

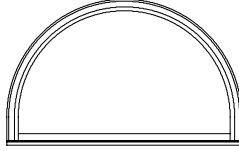

EWD5835ELHRDS

42 5/16" (1075)
43 13/16" (1113)
40 1/8" (1019)
39 3/8" (1000)
35 3/4" (908)

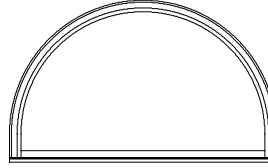

EWD6639ELHRDS

46 5/16" (1176)
47 13/16" (1214)
44 1/8" (1121)
43 3/8" (1102)
39 3/4" (1010)

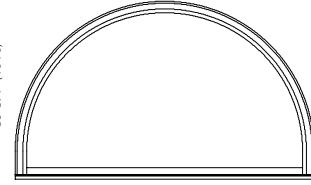

EWD7443ELHRDS

44 5/16" (1126)
45 13/16" (1164)
42 1/8" (1070)
41 3/8" (1051)
37 3/4" (959)

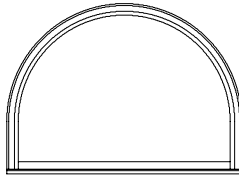

EWD5841ELHRDS

48 5/16" (1227)
49 13/16" (1265)
46 1/8" (1172)
45 3/8" (1153)
41 3/4" (1060)

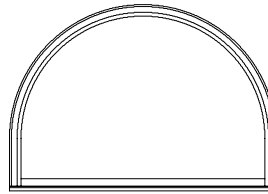

EWD6645ELHRDS

52 5/16" (1329)
53 13/16" (1367)
50 1/8" (1273)
49 3/8" (1254)
45 3/4" (1162)

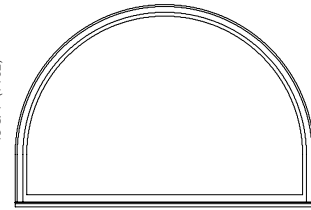

EWD7449ELHRDS

50 5/16" (1278)
51 13/16" (1316)
48 1/8" (1222)
47 3/8" (1203)
43 3/4" (1111)

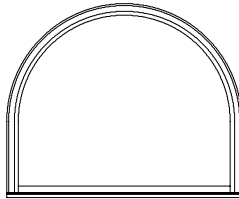

EWD5847ELHRDS

54 5/16" (1380)
55 13/16" (1418)
52 1/8" (1324)
51 3/8" (1305)
47 3/4" (1213)

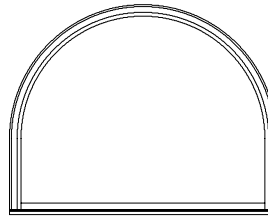

EWD6651ELHRDS

58 5/16" (1481)
59 13/16" (1519)
56 1/8" (1426)
55 3/8" (1407)
51 3/4" (1314)

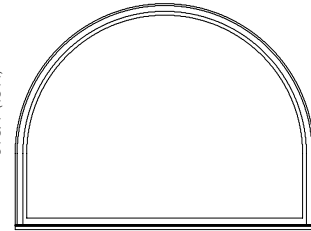

EWD7455ELHRDS

56 5/16" (1430)
57 13/16" (1468)
54 1/8" (1375)
53 3/8" (1356)
49 3/4" (1264)

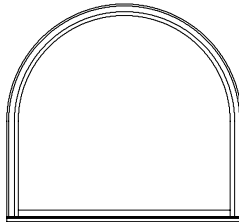

EWD5853ELHRDS

60 5/16" (1532)
61 13/16" (1570)
58 1/8" (1476)
57 3/8" (1457)
53 3/4" (1365)

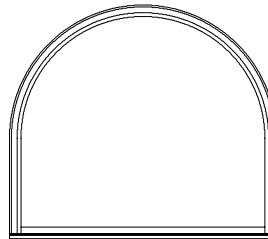

EWD6657ELHRDS

64 5/16" (1634)
65 13/16" (1672)
62 1/8" (1578)
61 3/8" (1559)
57 3/4" (1467)

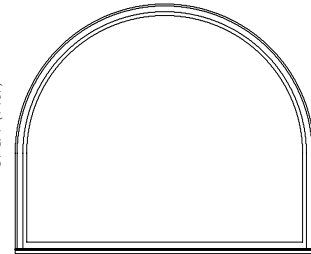

EWD7461ELHRDS

68 5/16" (1735)
69 13/16" (1773)
66 1/8" (1680)
65 3/8" (1661)
61 3/4" (1568)

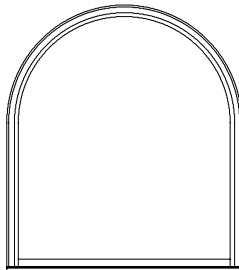

EWD5865ELHRDS

72 5/16" (1837)
73 13/16" (1875)
70 1/8" (1781)
69 3/8" (1762)
65 3/4" (1670)

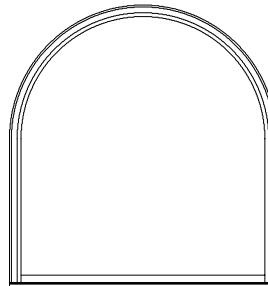

EWD6669ELHRDS

76 5/16" (1938)
77 13/16" (1976)
74 1/8" (1883)
73 3/8" (1864)
69 3/4" (1772)

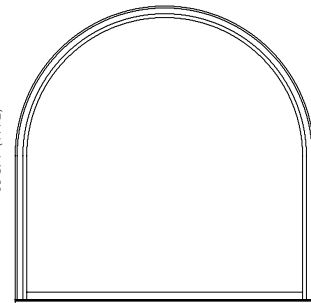

EWD7473ELHRDS

ELEVATION SYMBOL LEGEND:

M.O. = MASONRY OPENING

VALUES IN () ARE IN MILLIMETER CONVERSIONS

Note: Elevations shown DO NOT have exterior trim. Subtract 1/2" (12.7) from M.O. (Masonry Opening) for Unit Sizes. Masonry Openings above include Sill Nose, see Trim Options page for Sill Nose specifications. For other Trim Options refer to the Unit Sizing, Rough Opening & Masonry Openings page.

SCALE 1/4" = 1'

DOUBLE-HUNG EXTENDED HALF ROUND UNITS

M.O. BRICKMOULD
M.O. ADAMS/FLAT CASING
ROUGH OPENING
FRAME SIZE
DAYLIGHT OPENING

62 1/4"(1581)
65 1/4"(1657)
59 1/2"(1511)
58 3/4"(1492)
55 1/8"(1400)

70 1/4"(1784)
73 1/4"(1861)
67 1/2"(1715)
66 3/4"(1695)
63 1/8"(1603)

78 1/4"(1988)
81 1/4"(2064)
75 1/2"(1918)
74 3/4"(1899)
71 1/8"(1807)

80 5/16"(2040)
81 13/16"(2078)
78 1/8"(1984)
77 3/8"(1965)
73 13/4"(1873)

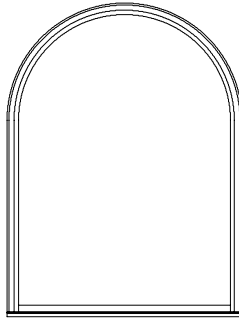

EWD5877ELHRDS

84 5/16"(2142)
85 13/16"(2180)
82 1/8"(2086)
81 3/8"(2067)
77 3/4"(1975)

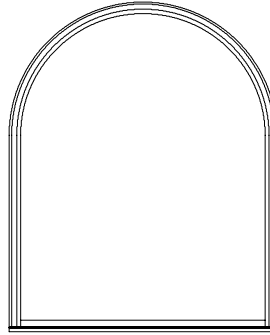

EWD6681ELHRDS

88 5/16"(2243)
89 13/16"(2281)
86 1/8"(2188)
85 3/8"(2169)
81 3/4"(2076)

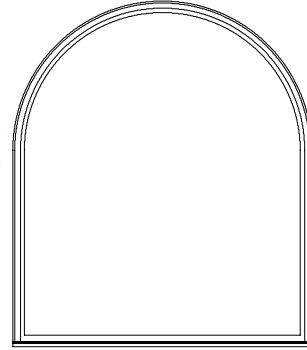

EWD7485ELHRDS

92 5/16"(2345)
93 13/16"(2383)
90 1/8"(2289)
89 3/8"(2270)
85 13/4"(2178)

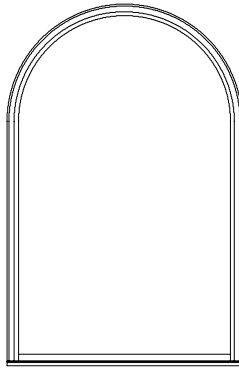

EWD5889ELHRDS

96 5/16"(2446)
97 13/16"(2484)
94 1/8"(2391)
93 3/8"(2372)
89 3/4"(2280)

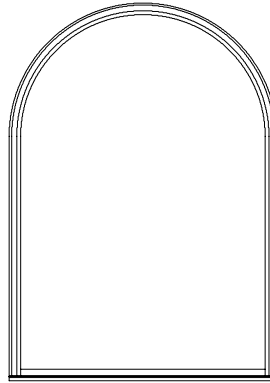

EWD6693ELHRDS

104 5/16"(2650)
105 13/16"(2688)
102 1/8"(2594)
101 3/8"(2575)
97 3/4"(2483)

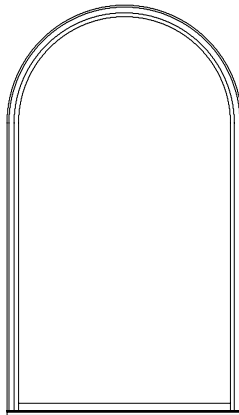

EWD58101ELHRDS

108 5/16"(2751)
109 13/16"(2789)
106 1/8"(2696)
105 3/8"(2677)
101 3/4"(2584)

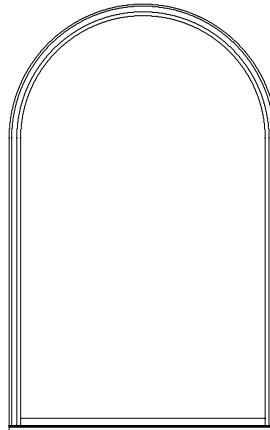

EWD66105ELHRDS

ELEVATION SYMBOL LEGEND:

M.O. = MASONRY OPENING

VALUES IN () ARE IN MILLIMETER CONVERSIONS

Note: Elevations shown DO NOT have exterior trim. Subtract 1/2" (12.7) from M.O. (Masonry Opening) for Unit Sizes. Masonry Openings above include Sill Nose, see Trim Options page for Sill Nose specifications. For other Trim Options refer to the Unit Sizing, Rough Opening & Masonry Openings page.

SCALE 1/4" = 1'

DOUBLE-HUNG EXTENDED HALF ROUND UNITS

M.O. BRICKMOULD	86 1/4" (2191)
M.O. ADAMS/FLAT CASING	89 1/4" (2267)
ROUGH OPENING	83 1/2" (2121)
FRAME SIZE	82 3/4" (2102)
DAYLIGHT OPENING	79 1/8" (2010)

50 5/16" (1278)
51 13/16" (1316)
48 1/8" (1222)
47 3/8" (1203)
43 3/4" (1111)

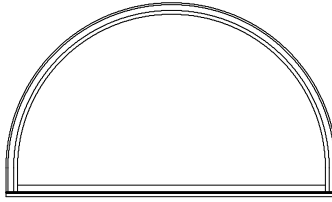

EWD8247ELHRDS

56 5/16" (1430)
57 3/16" (1468)
54 1/8" (1375)
53 3/8" (1356)
49 3/4" (1264)

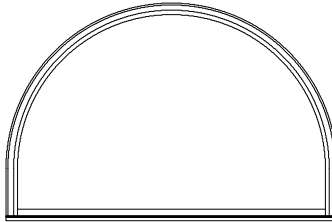

EWD8253ELHRDS

62 5/16" (1583)
63 13/16" (1621)
60 1/8" (1527)
59 3/8" (1508)
55 3/4" (1416)

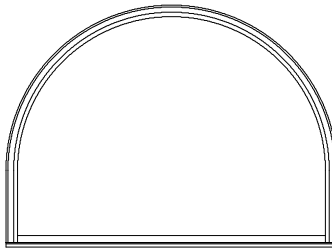

EWD8259ELHRDS

68 5/16" (1735)
69 13/16" (1773)
66 1/8" (1680)
65 3/8" (1661)
61 3/4" (1568)

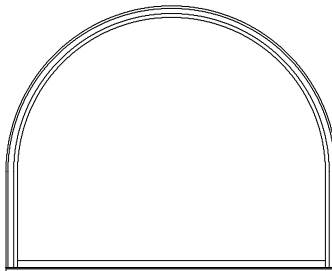

EWD8265ELHRDS

80 5/16" (2040)
81 13/16" (2078)
78 1/8" (1984)
77 3/8" (1965)
73 3/4" (1873)

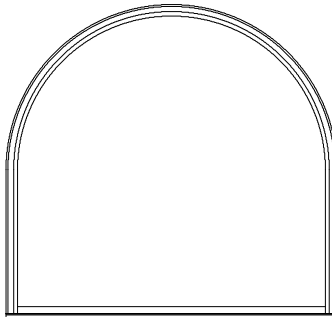

EWD8277ELHRDS

ELEVATION SYMBOL LEGEND:













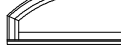



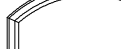











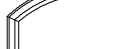

M.O. = MASONRY OPENING
VALUES IN () ARE IN MILLIMETER CONVERSIONS

Note: Elevations shown DO NOT have exterior trim. Subtract 1/2" (12.7) from M.O. (Masonry Opening) for Unit Sizes. Masonry Openings above include Sill Nose, see Trim Options page for Sill Nose specifications. For other Trim Options refer to the Unit Sizing, Rough Opening & Masonry Openings page.

SCALE 1/4" = 1'

DOUBLE-HUNG EXTENDED LEG SEGMENT TOP UNITS

M.O. BRICKMOULD
M.O. ADAMS/FLAT CASING
ROUGH OPENING
FRAME SIZE
DAYLIGHT OPENING

32 7/8" (835) 35 7/8" (911) 30 1/8" (765) 29 3/8" (746) 25 3/4" (654)		36 7/8" (937) 39 7/8" (1013) 34 1/8" (867) 33 3/8" (848) 29 3/4" (756)		40 7/8" (1038) 43 7/8" (1114) 38 1/8" (968) 37 3/8" (949) 33 3/4" (857)		44 7/8" (1140) 47 7/8" (1216) 42 1/8" (1070) 41 3/8" (1051) 37 3/4" (959)	
12 3/4" (324) 14 1/4" (362) 10 9/16" (268) 9 13/16" (249) 6 3/16" (157)		14 1/16" (357) 15 9/16" (395) 11 13/16" (300) 11 1/16" (281) 7 7/16" (189)		16 7/16" (418) 16 15/16" (430) 13 1/4" (337) 11 1/16" (281) 8 7/8" (225)		17 3/16" (437) 18 1/16" (475) 15" (381) 14 1/4" (362) 10 5/8" (270)	
18 3/4" (476) 20 1/4" (514) 16 9/16" (421) 15 13/16" (402) 12 3/16" (310)		20 1/16" (510) 21 9/16" (547) 17 13/16" (452) 17 1/16" (433) 13 7/16" (341)		22 7/16" (570) 22 15/16" (583) 19 1/4" (489) 18 1/2" (470) 14 7/8" (378)		23 3/16" (589) 24 1/16" (627) 21" (533) 20 1/4" (514) 16 5/8" (422)	
24 3/4" (629) 26 1/4" (667) 22 9/16" (573) 21 13/16" (554) 18 3/16" (462)		26 1/16" (662) 27 9/16" (700) 23 13/16" (605) 23 1/16" (586) 19 7/16" (494)		28 7/16" (722) 28 15/16" (735) 25 1/4" (641) 24 1/2" (622) 20 7/8" (530)		29 3/16" (741) 30 1/16" (779) 27" (686) 26 1/4" (667) 22 5/8" (575)	
30 3/4" (781) 32 1/4" (819) 28 9/16" (725) 27 13/16" (706) 24 3/16" (614)		32 1/16" (814) 33 9/16" (852) 29 13/16" (757) 29 1/16" (738) 25 7/16" (646)		34 7/16" (875) 34 15/16" (887) 31 1/4" (794) 30 1/2" (775) 26 7/8" (683)		35 3/16" (894) 36 1/16" (932) 33" (838) 32 1/4" (819) 28 5/8" (727)	
42 3/4" (1086) 44 1/4" (1124) 40 9/16" (1030) 39 13/16" (1011) 36 3/16" (919)		44 1/16" (1119) 45 9/16" (1157) 41 13/16" (1062) 41 1/16" (1043) 37 7/16" (951)		46 7/16" (1180) 46 15/16" (1192) 43 1/4" (1099) 42 1/2" (1080) 38 7/8" (987)		47 3/16" (1199) 48 1/16" (1237) 45" (1143) 44 1/4" (1124) 40 5/8" (1032)	
54 3/4" (1391) 56 1/4" (1429) 52 9/16" (1335) 51 13/16" (1316) 48 3/16" (1224)		56 1/16" (1424) 57 9/16" (1462) 53 13/16" (1367) 53 1/16" (1348) 49 7/16" (1256)		58 7/16" (1484) 58 15/16" (1497) 55 1/4" (1403) 54 1/2" (1384) 50 7/8" (1292)		59 3/16" (1503) 60 1/16" (1541) 57" (1449) 56 1/4" (1429) 52 5/8" (1337)	
66 3/4" (1695) 68 1/4" (1734) 64 9/16" (1640) 63 13/16" (1621) 60 3/16" (1529)		68 1/16" (1729) 69 9/16" (1767) 65 13/16" (1672) 65 1/16" (1653) 61 7/16" (1561)		69 7/16" (1764) 70 13/16" (1799) 67 1/4" (1708) 66 1/2" (1689) 62 7/8" (1597)		71 3/16" (1808) 72 1/16" (1846) 69" (1753) 68 1/4" (1734) 64 5/8" (1641)	

ELEVATION SYMBOL LEGEND:

M.O. = MASONRY OPENING

VALUES IN () ARE IN MILLIMETER CONVERSIONS

Note: Elevations shown DO NOT have exterior trim. Subtract 1/2" (12.7) from M.O. (Masonry Opening) for Unit Sizes. Masonry Openings above include Sill Nose, see Trim Options page for Sill Nose specifications. For other Trim Options refer to the Unit Sizing, Rough Opening & Masonry Openings page.

SCALE 1/4" = 1'

DOUBLE-HUNG EXTENDED LEG SEGMENT TOP UNITS

M.O. BRICKMOULD	32 7/8" (835)	36 7/8" (937)	40 7/8" (1038)	44 7/8" (1140)
M.O. ADAMS/FLAT CASING	35 7/8" (911)	39 7/8" (1013)	43 7/8" (1114)	47 7/8" (1216)
ROUGH OPENING	30 1/8" (765)	34 1/8" (867)	38 1/8" (968)	42 1/8" (1070)
FRAME SIZE	29 3/8" (746)	33 3/8" (848)	37 3/8" (949)	41 3/8" (1051)
DAYLIGHT OPENING	25 3/4" (654)	29 3/4" (756)	33 3/4" (857)	37 3/4" (959)

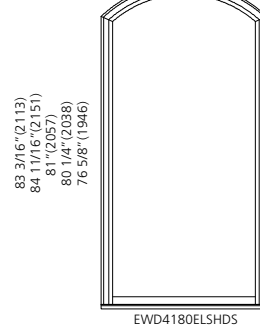
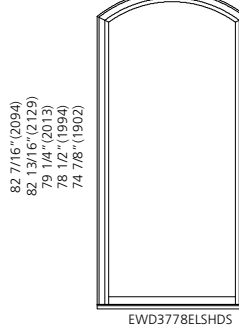
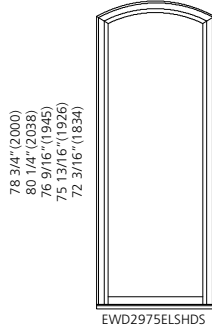

ELEVATION SYMBOL LEGEND:
M.O. = MASONRY OPENING
VALUES IN () ARE IN MILLIMETER CONVERSIONS

Note: Elevations shown DO NOT have exterior trim. Subtract 1/2" (12.7) from M.O. (Masonry Opening) for Unit Sizes. Masonry Openings above include Sill Nose, see Trim Options page for Sill Nose specifications. For other Trim Options refer to the Unit Sizing, Rough Opening & Masonry Openings page.

DOUBLE-HUNG EXTENDED LEG SEGMENT TOP UNITS

M.O. BRICKMOUND
M.O. ADAMS/FLAT CASING
ROUGH OPENING
FRAME SIZE
DAYLIGHT OPENING

62 1/4" (1581)
65 1/4" (1657)
59 1/2" (1511)
58 3/4" (1492)
55 1/8" (1400)

70 1/4" (1784)
73 1/4" (1861)
67 1/2" (1715)
66 3/4" (1695)
63 1/8" (1603)

78 1/4" (1988)
81 1/4" (2064)
75 1/2" (1918)
74 3/4" (1899)
71 1/8" (1807)

16 15/16" (430)
18 7/16" (468)
14 3/4" (375)
14" (356)
10 3/8" (264)



EWD5814ELSHDS

19 1/2" (495)
21" (533)
17 5/16" (440)
16 9/16" (421)
12 15/16" (329)



EWD6616ELSHDS

17 11/16" (449)
19 3/16" (487)
15 1/2" (394)
14 3/4" (375)
11 1/8" (283)



EWD7414ELSHDS

22 15/16" (583)
24 7/16" (621)
20 3/4" (527)
20" (508)
16 3/8" (416)



EWD5820ELSHDS

25 1/2" (648)
27" (686)
23 5/16" (592)
22 9/16" (573)
18 15/16" (481)



EWD6622ELSHDS

23 11/16" (602)
25 3/16" (640)
21 1/2" (546)
20 3/4" (527)
17 1/8" (435)



EWD7420ELSHDS

28 15/16" (735)
30 7/16" (773)
26 3/4" (679)
26" (660)
22 3/8" (568)



EWD5826ELSHDS

31 1/2" (800)
33" (838)
29 5/16" (745)
28 9/16" (725)
24 15/16" (633)



EWD6628ELSHDS

29 11/16" (754)
31 3/16" (792)
27 1/2" (699)
26 3/4" (679)
23 1/8" (587)



EWD7426ELSHDS

34 15/16" (887)
36 7/16" (926)
32 3/4" (832)
32" (813)
28 3/8" (721)



EWD5832ELSHDS

37 1/2" (953)
39" (991)
35 5/16" (897)
34 9/16" (878)
30 15/16" (786)



EWD6634ELSHDS

35 11/16" (906)
37 3/16" (945)
33 1/2" (851)
32 3/4" (832)
29 1/8" (740)



EWD7432ELSHDS

46 15/16" (1192)
48 7/16" (1230)
44 3/4" (1137)
44" (1118)
40 3/8" (1026)



EWD5844ELSHDS

49 1/2" (1257)
51" (1295)
47 5/16" (1202)
46 9/16" (1183)
42 15/16" (1091)

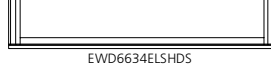

EWD6646ELSHDS

47 11/16" (1211)
49 3/16" (1249)
45 1/2" (1156)
44 3/4" (1137)
41 1/8" (1045)

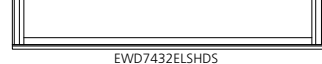

EWD7444ELSHDS

58 15/16" (1497)
60 7/16" (1535)
56 3/4" (1441)
56" (1422)
52 3/8" (1330)



EWD5856ELSHDS

61 1/2" (1562)
63" (1600)
59 5/16" (1507)
58 9/16" (1487)
54 15/16" (1395)



EWD6658ELSHDS

59 11/16" (1516)
61 3/16" (1554)
57 1/2" (1461)
56 3/4" (1441)
53 1/8" (1349)



EWD7456ELSHDS

70 15/16" (1802)
72 7/16" (1840)
68 3/4" (1746)
68" (1727)
64 3/8" (1635)

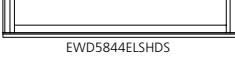

EWD5868ELSHDS

73 1/2" (1867)
75" (1905)
71 5/16" (1811)
70 9/16" (1792)
66 15/16" (1700)

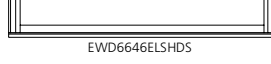

EWD6670ELSHDS

71 11/16" (1821)
73 3/16" (1859)
69 1/2" (1765)
68 3/4" (1746)
65 1/8" (1654)

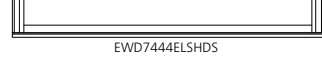

EWD7468ELSHDS

ELEVATION SYMBOL LEGEND:

M.O. = MASONRY OPENING

VALUES IN () ARE IN MILLIMETER CONVERSIONS

Note: Elevations shown DO NOT have exterior trim. Subtract 1/2" (12.7) from M.O. (Masonry Opening) for Unit Sizes. Masonry Openings above include Sill Nose, see Trim Options page for Sill Nose specifications. For other Trim Options refer to the Unit Sizing, Rough Opening & Masonry Openings page.

SCALE 1/4" = 1'

DOUBLE-HUNG EXTENDED LEG SEGMENT TOP UNITS

M.O. BRICKMOULD
M.O. ADAMS/FLAT CASING
ROUGH OPENING
FRAME SIZE
DAYLIGHT OPENING

62 1/4"(1581)
65 1/4"(1657)
59 1/2"(1511)
58 3/4"(1492)
55 1/8"(1400)

70 1/4"(1784)
73 1/4"(1861)
67 1/2"(1715)
66 3/4"(1695)
63 1/8"(1603)

78 1/4"(1988)
81 1/4"(2064)
75 1/2"(1918)
74 3/4"(1899)
71 1/8"(1807)

82 15/16"(2107)
84 7/16"(2145)
80 3/4"(2051)
80"(2032)
76 3/8"(1940)

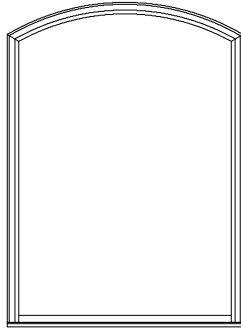

EWD5880ELSHDS

85 1/2"(2172)
87"(2210)
83 5/16"(2116)
82 9/16"(2097)
78 15/16"(2005)

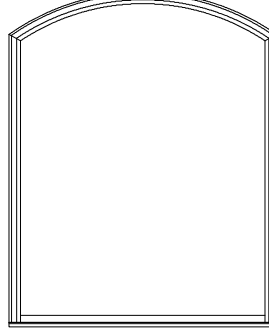

EWD6682ELSHDS

83 11/16"(2126)
85 3/16"(2164)
81 1/2"(2070)
80 3/4"(2051)
77 31/8"(1959)

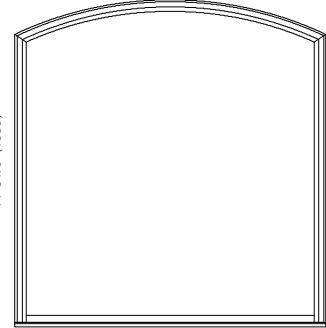

EWD7480ELSHDS

ELEVATION SYMBOL LEGEND:

M.O. = MASONRY OPENING

VALUES IN () ARE IN MILLIMETER CONVERSIONS

Note: Elevations shown DO NOT have exterior trim. Subtract 1/2" (12.7) from M.O. (Masonry Opening) for Unit Sizes. Masonry Openings above include Sill Nose, see Trim Options page for Sill Nose specifications. For other Trim Options refer to the Unit Sizing, Rough Opening & Masonry Openings page.

DOUBLE-HUNG EXTENDED LEG SEGMENT TOP UNITS

**M.O. BRICKMOULD
M.O. ADAMS/FLAT CASING
ROUGH OPENING
FRAME SIZE
DAYLIGHT OPENING**

86 1/4" (2191)
89 1/4" (2267)
83 1/2" (2121)
82 3/4" (2102)
79 1/8" (2010)

**M.O. BRICKMOULD
M.O. ADAMS/FLAT CASING
ROUGH OPENING
FRAME SIZE
DAYLIGHT OPENING**

86 1/4" (2191)
89 1/4" (2267)
83 1/2" (2121)
82 3/4" (2102)
79 1/8" (2010)

19 13/16" (503)
21 5/16" (541)
17 5/8" (448)
16 7/8" (427)
13 1/4" (337)

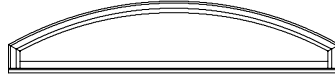

EWD8216ELSHDS

25 13/16" (656)
27 5/16" (694)
23 5/8" (600)
22 7/8" (581)
19 1/4" (489)

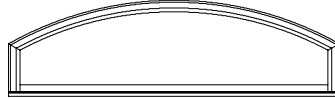

EWD8222ELSHDS

31 13/16" (808)
33 5/16" (846)
29 5/8" (752)
28 7/8" (733)
25 1/4" (641)



EWD8228ELSHDS

37 13/16" (960)
39 5/16" (999)
35 5/8" (905)
34 7/8" (886)
31 1/4" (794)

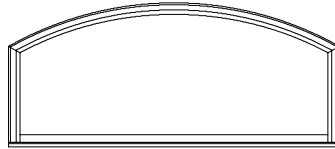

EWD8234ELSHDS

49 13/16" (1265)
51 5/16" (1303)
47 5/8" (1210)
46 7/8" (1191)
43 1/4" (1099)

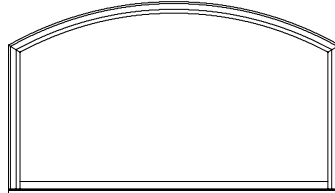

EWD8246ELSHDS

61 13/16" (1570)
63 5/16" (1608)
59 5/8" (1514)
58 7/8" (1495)
55 1/4" (1403)

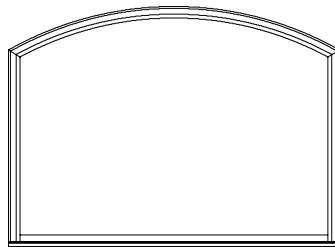

EWD8258ELSHDS

73 13/16" (1875)
75 5/16" (1913)
71 5/8" (1819)
70 7/8" (1800)
67 1/4" (1708)

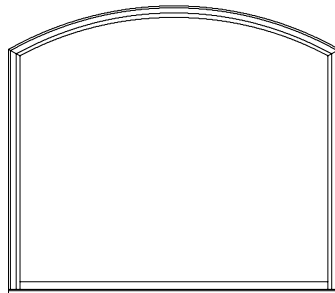

EWD8270ELSHDS

86 13/16" (2180)
87 5/16" (2218)
83 5/8" (2124)
82 7/8" (2105)
79 1/4" (2013)

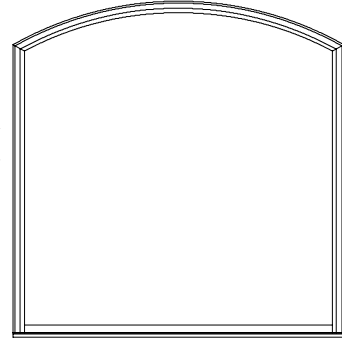

EWD8282ELSHDS

ELEVATION SYMBOL LEGEND:
M.O. = MASONRY OPENING
VALUES IN () ARE IN MILLIMETER CONVERSIONS

Note: Elevations shown DO NOT have exterior trim. Subtract 1/2" (12.7) from M.O. (Masonry Opening) for Unit Sizes. Masonry Openings above include Sill Nose, see Trim Options page for Sill Nose specifications. For other Trim Options refer to the Unit Sizing, Rough Opening & Masonry Openings page.

SCALE 1/4" = 1'

SWINGING PATIO DOOR HALF ROUND UNITS

M.O. BRICKMOULD	30 1/2" (775)
M.O. ADAMS/FLAT CASING	33 1/2" (851)
ROUGH OPENING	27 3/4" (705)
FRAME SIZE	27" (686)
DAYLIGHT OPENING	23 3/8" (594)

33 1/2" (851)
36 1/2" (927)
30 3/4" (781)
30" (762)
26 3/8" (670)

36 1/2" (927)
39 1/2" (1003)
33 3/4" (857)
33" (838)
29 3/8" (746)

60 1/2" (1537)
63 1/2" (1613)
57 3/4" (1467)
57" (1449)
53 3/8" (1356)

16 7/16" (418)
17 15/16" (456)
14 1/4" (362)
13 1/2" (343)
9 7/8" (251)



SDRTP-26

17 15/16" (456)
19 7/16" (494)
15 3/4" (400)
15" (381)
11 3/8" (289)



SDRTP-29

19 7/16" (494)
20 15/16" (532)
17 1/4" (438)
16 1/2" (419)
12 7/8" (327)



SDRTP-30

31 7/16" (799)
32 15/16" (837)
29 1/4" (743)
28 1/2" (724)
24 7/8" (632)



SDRTP-50

M.O. BRICKMOULD	66 1/2" (1689)
M.O. ADAMS/FLAT CASING	69 1/2" (1765)
ROUGH OPENING	63 3/4" (1619)
FRAME SIZE	63" (1600)
DAYLIGHT OPENING	59 3/8" (1508)

66 1/2" (1689)
69 1/2" (1765)
63 3/4" (1619)
63" (1600)
59 3/8" (1508)

72 1/2" (1842)
75 1/2" (1918)
69 3/4" (1772)
69" (1753)
65 3/8" (1661)

90 1/2" (2299)
93 1/2" (2375)
87 3/4" (2229)
87" (2210)
83 3/8" (2118)

34 7/16" (875)
35 15/16" (913)
32 1/4" (819)
31 1/2" (800)
27 7/8" (708)

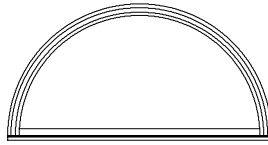

SDRTP-56

37 7/16" (951)
38 15/16" (989)
35 1/4" (895)
34 1/2" (876)
30 7/8" (784)

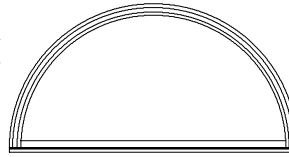

SDRTP-60

45 7/16" (1154)
47 15/16" (1217)
44 1/4" (1124)
43 1/2" (1105)
39 7/8" (1013)

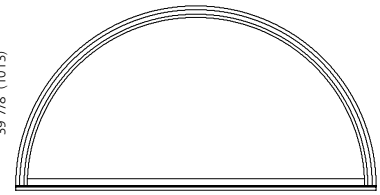

SDRTP-76

M.O. BRICKMOULD	99 1/2" (2527)
M.O. ADAMS/FLAT CASING	102 1/2" (2604)
ROUGH OPENING	96 3/4" (2457)
FRAME SIZE	96" (2438)
DAYLIGHT OPENING	92 3/8" (2346)

99 1/2" (2527)
102 1/2" (2604)
96 3/4" (2457)
96" (2438)
92 3/8" (2346)

108 1/2" (2756)
111 1/2" (2832)
105 3/4" (2686)
105" (2667)
101 3/8" (2575)

50 15/16" (1294)
52 7/16" (1332)
48 3/4" (1238)
48" (1219)
44 3/8" (1127)

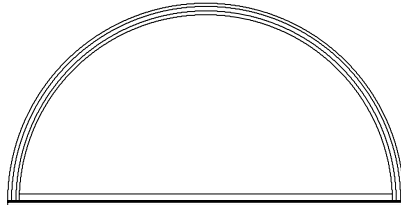

SDRTP-83

55 7/16" (1408)
56 15/16" (1446)
53 1/4" (1353)
52 1/2" (1334)
48 7/8" (1241)

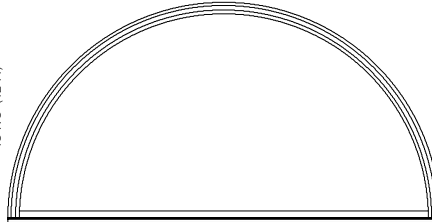

SDRTP-90

ELEVATION SYMBOL LEGEND:

M.O. = MASONRY OPENING

VALUES IN () ARE IN MILLIMETER CONVERSIONS

Note: Elevations shown DO NOT have exterior trim. Subtract 1/2" (12.7) from M.O. (Masonry Opening) for Unit Sizes. Masonry Openings above include Sill Nose, see Trim Options page for Sill Nose specifications. For other Trim Options refer to the Unit Sizing, Rough Opening & Masonry Openings page.

SWINGING PATIO DOOR EXTENDED HALF ROUND UNITS

M.O. BRICKMOULD 33 1/2" (851)
M.O. ADAMS/FLAT CASING 36 1/2" (927)
ROUGH OPENING 30 3/4" (781)
FRAME SIZE 30" (762)
DAYLIGHT OPENING 26 3/8" (670)

36 1/2" (927)
 39 1/2" (1003)
 33 3/4" (857)
 33" (838)
 29 3/8" (746)

39 1/2" (1003)
 42 1/2" (1080)
 36 3/4" (933)
 36" (914)
 32 3/8" (822)

63 1/2" (1613)
 66 1/2" (1689)
 60 3/4" (1543)
 60" (1524)
 56 3/8" (1432)

23 15/16" (608)
 25 7/16" (646)
 21 3/4" (552)
 21" (533)
 17 3/8" (441)

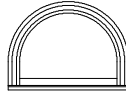

SDEHP-26L06

25 7/16" (646)
 26 15/16" (684)
 23 1/4" (591)
 22 1/2" (572)
 18 7/8" (479)

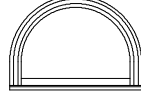

SDEHP-29L06

26 15/16" (684)
 28 7/16" (722)
 24 3/4" (629)
 24" (610)
 20 3/8" (518)



SDEHP-30L06

38 15/16" (989)
 40 7/16" (1027)
 36 3/4" (933)
 36" (914)
 32 3/8" (822)

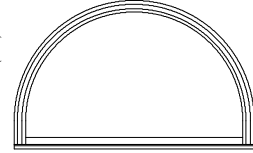

SDEHP-50L06

29 15/16" (760)
 31 7/16" (799)
 27 3/4" (705)
 27" (686)
 23 3/8" (594)



SDEHP-26L10

31 7/16" (799)
 32 15/16" (837)
 29 1/4" (743)
 28 1/2" (724)
 24 17/8" (632)



SDEHP-29L10

32 15/16" (837)
 34 7/16" (875)
 30 3/4" (781)
 30" (762)
 26 3/8" (670)



SDEHP-30L10

44 15/16" (1141)
 46 7/16" (1180)
 42 3/4" (1086)
 42" (1067)
 38 3/8" (975)

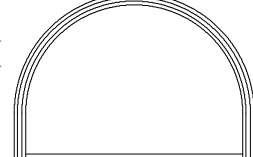

SDEHP-50L10

35 15/16" (913)
 37 7/16" (951)
 33 3/4" (857)
 33" (838)
 29 3/8" (746)

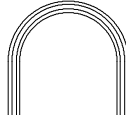

SDEHP-26L16

37 7/16" (951)
 38 15/16" (989)
 35 1/4" (895)
 34 1/2" (876)
 30 7/8" (784)

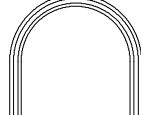

SDEHP-29L16

38 15/16" (989)
 40 7/16" (1027)
 36 3/4" (933)
 36" (914)
 32 3/8" (822)



SDEHP-30L16

50 15/16" (1294)
 52 7/16" (1332)
 48 3/4" (1238)
 48" (1219)
 44 3/8" (1127)

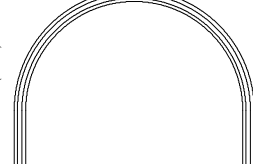

SDEHP-50L16

41 15/16" (1065)
 43 7/16" (1103)
 39 3/4" (1010)
 39" (991)
 35 3/8" (899)

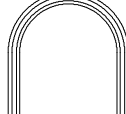

SDEHP-26L20

43 7/16" (1103)
 44 15/16" (1141)
 41 1/4" (1048)
 40 1/2" (1029)
 36 7/8" (937)

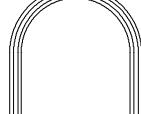

SDEHP-29L20

44 15/16" (1141)
 46 7/16" (1180)
 42 3/4" (1086)
 42" (1067)
 38 3/8" (975)



SDEHP-30L20

56 15/16" (1446)
 58 7/16" (1484)
 54 3/4" (1391)
 54" (1372)
 50 3/8" (1280)

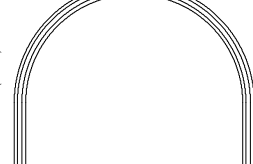

SDEHP-50L20

53 15/16" (1370)
 55 7/16" (1408)
 51 3/4" (1314)
 51" (1295)
 47 3/8" (1203)

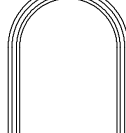

SDEHP-26L30

55 7/16" (1408)
 56 15/16" (1446)
 53 1/4" (1353)
 52 1/2" (1334)
 48 7/8" (1241)

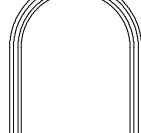

SDEHP-29L30

56 15/16" (1446)
 58 7/16" (1484)
 54 3/4" (1391)
 54" (1372)
 50 3/8" (1280)

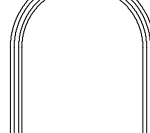

SDEHP-30L30

68 15/16" (1751)
 70 7/16" (1789)
 66 3/4" (1695)
 66" (1676)
 62 3/8" (1584)

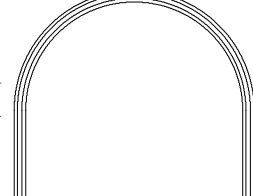

SDEHP-50L30

ELEVATION SYMBOL LEGEND:
M.O. = MASONRY OPENING
 VALUES IN () ARE IN MILLIMETER CONVERSIONS

Note: Elevations shown DO NOT have exterior trim. Subtract 1/2" (12.7) from M.O. (Masonry Opening) for Unit Sizes. Masonry Openings above include Sill Nose, see Trim Options page for Sill Nose specifications. For other Trim Options refer to the Unit Sizing, Rough Opening & Masonry Openings page.

SCALE 1/4" = 1'

SWINGING PATIO DOOR EXTENDED HALF ROUND UNITS

M.O. BRICKMOULD
M.O. ADAMS/FLAT CASING
ROUGH OPENING
FRAME SIZE
DAYLIGHT OPENING

33 1/2"(851)
36 1/2"(927)
30 3/4"(781)
30"(762)
26 3/8"(670)

36 1/2"(927)
39 1/2"(1003)
33 3/4"(857)
33"(838)
29 3/8"(746)

39 1/2"(1003)
42 1/2"(1080)
36 3/4"(933)
36"(914)
32 3/8"(822)

63 1/2"(1613)
66 1/2"(1689)
60 3/4"(1543)
60"(1524)
56 3/8"(1432)

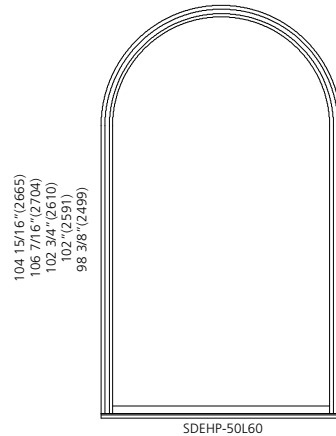
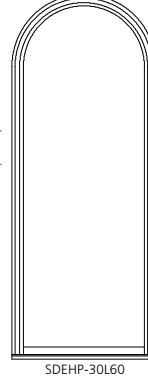
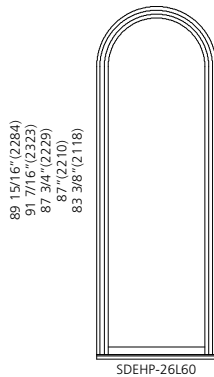
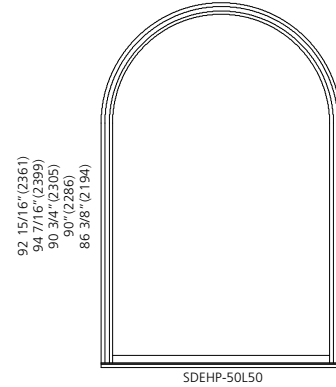
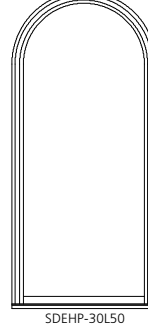
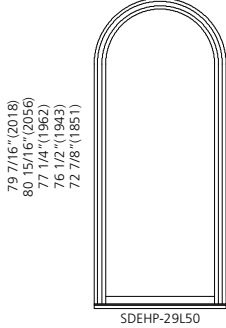
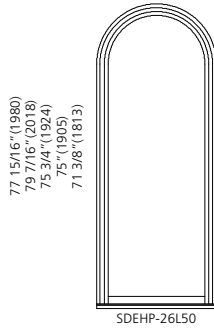
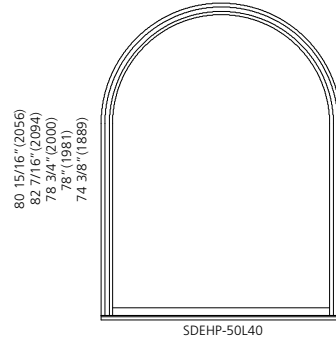
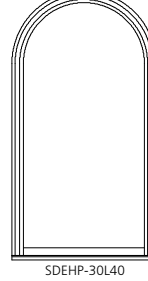
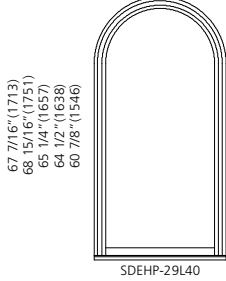
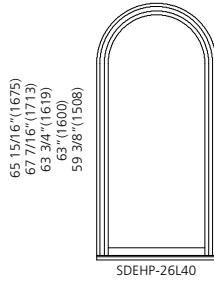

ELEVATION SYMBOL LEGEND:

M.O. = MASONRY OPENING

VALUES IN () ARE IN MILLIMETER CONVERSIONS

Note: Elevations shown DO NOT have exterior trim. Subtract 1/2" (12.7) from M.O. (Masonry Opening) for Unit Sizes. Masonry Openings above include Sill Nose, see Trim Options page for Sill Nose specifications. For other Trim Options refer to the Unit Sizing, Rough Opening & Masonry Openings page.

SCALE 1/4" = 1'

SWINGING PATIO DOOR EXTENDED HALF ROUND UNITS

M.O. BRICKMOULD
M.O. ADAMS/FLAT CASING
ROUGH OPENING
FRAME SIZE
DAYLIGHT OPENING

69 1/2"(1765)
72 1/2"(1842)
66 3/4"(1695)
66"(1676)
62 3/8"(1584)

75 1/2"(1918)
78 1/2"(1994)
72 3/4"(1848)
72"(1829)
68 3/8"(1737)

41 15/16"(1065)
43 7/16"(1103)
39 3/4"(1010)
39"(991)
35 3/8"(899)

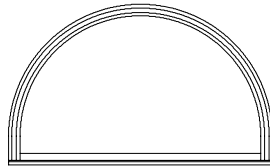

SDEHP-56L06

44 15/16"(1141)
46 7/16"(1180)
42 3/4"(1086)
42"(1067)
38 3/8"(975)

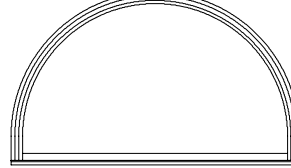

SDEHP-60L06

47 15/16"(1218)
49 7/16"(1256)
45 3/4"(1162)
45"(1143)
41 3/8"(1051)

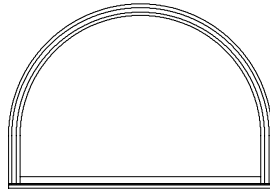

SDEHP-56L10

50 15/16"(1294)
52 7/16"(1332)
48 3/4"(1238)
48"(1219)
44 3/8"(1127)

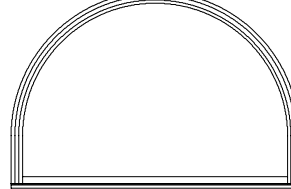

SDEHP-60L10

53 15/16"(1370)
55 7/16"(1408)
51 3/4"(1314)
51"(1295)
47 3/8"(1203)

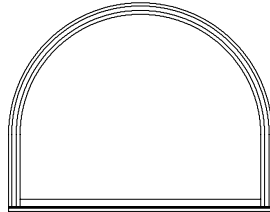

SDEHP-56L16

56 15/16"(1446)
58 7/16"(1484)
54 3/4"(1391)
54"(1372)
50 3/8"(1280)

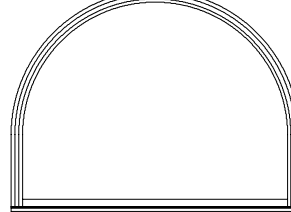

SDEHP-60L16

59 15/16"(1522)
61 7/16"(1560)
57 3/4"(1467)
57"(1448)
53 3/8"(1356)

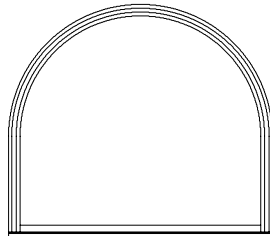

SDEHP-56L20

62 15/16"(1599)
64 7/16"(1637)
60 3/4"(1543)
60"(1524)
56 3/8"(1432)

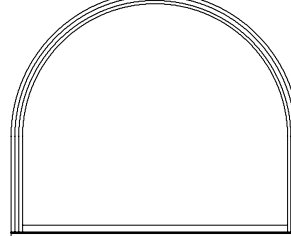

SDEHP-60L20

71 15/16"(1827)
73 7/16"(1865)
69 3/4"(1772)
69"(1753)
65 3/8"(1661)

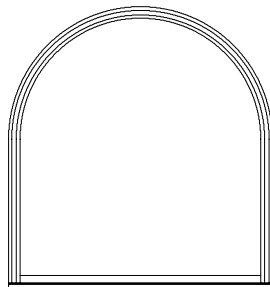

SDEHP-56L30

74 15/16"(1903)
76 7/16"(1942)
72 3/4"(1848)
72"(1829)
68 3/8"(1737)

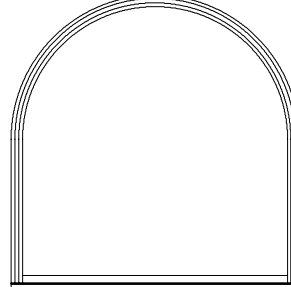

SDEHP-60L30

ELEVATION SYMBOL LEGEND:

M.O. = MASONRY OPENING

VALUES IN () ARE IN MILLIMETER CONVERSIONS

Note: Elevations shown DO NOT have exterior trim. Subtract 1/2" (12.7) from M.O. (Masonry Opening) for Unit Sizes. Masonry Openings above include Sill Nose, see Trim Options page for Sill Nose specifications. For other Trim Options refer to the Unit Sizing, Rough Opening & Masonry Openings page.

SCALE 1/4" = 1'

SWINGING PATIO DOOR EXTENDED HALF ROUND UNITS

M.O. BRICKMOUND
M.O. ADAMS/FLAT CASING
ROUGH OPENING
FRAME SIZE
DAYLIGHT OPENING

69 1/2" (1765)
72 1/2" (1842)
66 3/4" (1695)
66" (1676)
62 3/8" (1584)

75 1/2" (1918)
78 1/2" (1994)
72 3/4" (1848)
72" (1829)
68 3/8" (1737)

83 15/16" (2132)
85 7/16" (2170)
81 3/4" (2076)
81" (2057)
77 3/8" (1965)

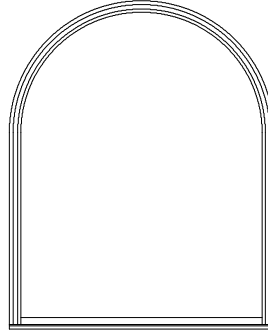

SDEHP-56L40

86 15/16" (2208)
88 7/16" (2246)
84 3/4" (2153)
84" (2134)
80 3/8" (2042)

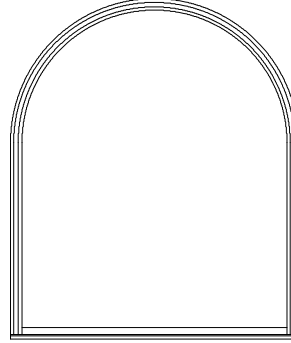

SDEHP-60L40

95 15/16" (2437)
97 7/16" (2475)
93 3/4" (2381)
93" (2362)
89 3/8" (2270)

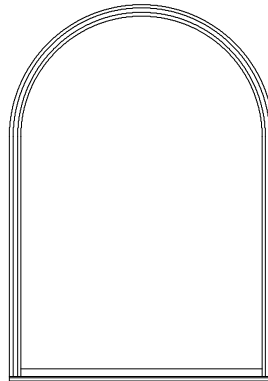

SDEHP-56L50

98 15/16" (2513)
100 7/16" (2551)
96 3/4" (2457)
96" (2438)
92 3/8" (2346)

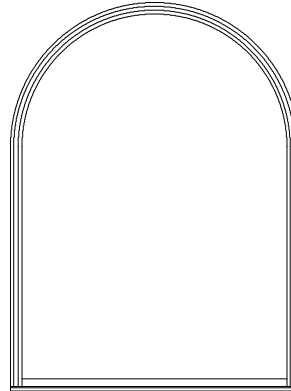

SDEHP-60L50

107 15/16" (2742)
109 7/16" (2780)
105 3/4" (2686)
105" (2667)
101 3/8" (2575)

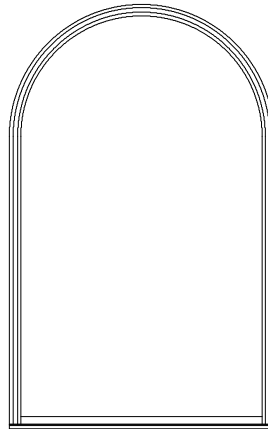

SDEHP-56L60

ELEVATION SYMBOL LEGEND:
M.O. = MASONRY OPENING
VALUES IN () ARE IN MILLIMETER CONVERSIONS

Note: Elevations shown DO NOT have exterior trim. Subtract 1/2" (12.7) from M.O. (Masonry Opening) for Unit Sizes. Masonry Openings above include Sill Nose, see Trim Options page for Sill Nose specifications. For other Trim Options refer to the Unit Sizing, Rough Opening & Masonry Openings page.

SCALE 1/4" = 1'

SWINGING PATIO DOOR EXTENDED LEG SEGMENT TOP UNITS

M.O. BRICKMOUND
M.O. ADAMS/FLAT CASING
ROUGH OPENING
FRAME SIZE
DAYLIGHT OPENING

33 1/2" (851) 36 1/2" (927) 30 3/4" (781) 30" (762) 26 3/8" (670)		36 1/2" (927) 39 1/2" (1003) 33 3/4" (857) 33" (838) 29 3/8" (746)		39 1/2" (1003) 42 1/2" (1080) 36 3/4" (933) 36" (914) 32 3/8" (822)		63 1/2" (1613) 66 1/2" (1689) 60 3/4" (1543) 60" (1524) 56 3/8" (1432)	
12 15/16" (329) 14 7/16" (367) 10 3/4" (273) 10" (254) 6 3/8" (162)		13 7/8" (352) 15 3/8" (391) 11 11/16" (297) 10 15/16" (276) 7 5/16" (186)		14 15/16" (379) 16 7/16" (418) 12 3/4" (324) 12 (305) 8 3/8" (215)		17 5/16" (440) 18 13/16" (478) 15 1/8" (384) 14 3/8" (365) 10 3/4" (273)	
18 15/16" (481) 20 7/16" (519) 16 3/4" (425) 16" (406) 12 3/8" (314)		19 7/8" (505) 21 3/8" (543) 17 11/16" (449) 16 15/16" (430) 13 5/16" (338)		20 15/16" (532) 22 7/16" (570) 18 3/4" (476) 18 (457) 14 3/8" (365)		23 5/16" (592) 24 13/16" (630) 21 1/8" (537) 20 3/8" (518) 16 3/4" (425)	
24 15/16" (633) 26 7/16" (672) 22 3/4" (578) 22" (559) 18 3/8" (467)		25 7/8" (657) 27 3/8" (695) 23 11/16" (602) 22 15/16" (583) 19 5/16" (491)		26 15/16" (684) 28 7/16" (722) 24 3/4" (629) 24 (610) 20 3/8" (518)		29 5/16" (745) 30 13/16" (783) 27 1/8" (689) 26 3/8" (670) 22 3/4" (578)	
30 15/16" (786) 32 7/16" (824) 28 3/4" (730) 28" (711) 24 7/8" (619)		31 7/8" (810) 33 3/8" (848) 29 11/16" (754) 28 15/16" (735) 25 5/16" (643)		32 15/16" (837) 34 7/16" (875) 30 3/4" (781) 30" (762) 26 3/8" (670)		35 5/16" (897) 36 13/16" (935) 33 1/8" (841) 32 3/8" (822) 28 3/4" (730)	
42 15/16" (1091) 44 7/16" (1129) 40 3/4" (1035) 40" (1016) 36 7/8" (924)		43 7/8" (1114) 45 3/8" (1153) 41 11/16" (1059) 40 15/16" (1040) 37 5/16" (948)		44 15/16" (1141) 46 7/16" (1180) 42 3/4" (1086) 42" (1067) 38 3/8" (975)		47 5/16" (1202) 48 13/16" (1240) 45 1/8" (1146) 44 3/8" (1127) 40 13/4" (1035)	
54 15/16" (1395) 56 7/16" (1434) 52 3/4" (1340) 52" (1321) 48 3/8" (1229)		55 7/8" (1419) 57 3/8" (1457) 53 11/16" (1364) 52 15/16" (1345) 49 5/16" (1253)		56 15/16" (1446) 58 7/16" (1484) 54 3/4" (1391) 54" (1372) 50 3/8" (1280)		59 5/16" (1507) 60 13/16" (1545) 57 1/8" (1451) 56 3/8" (1432) 52 3/4" (1340)	
66 15/16" (1700) 68 7/16" (1738) 64 3/4" (1645) 64" (1626) 60 3/8" (1534)		67 7/8" (1724) 69 3/8" (1762) 65 11/16" (1668) 64 15/16" (1649) 61 5/16" (1557)		68 15/16" (1751) 70 7/16" (1789) 66 3/4" (1695) 66" (1676) 62 3/8" (1584)		71 5/16" (1811) 72 13/16" (1849) 69 1/8" (1756) 68 3/8" (1737) 64 3/4" (1645)	

ELEVATION SYMBOL LEGEND:

M.O. = MASONRY OPENING

VALUES IN () ARE IN MILLIMETER CONVERSIONS

Note: Elevations shown DO NOT have exterior trim. Subtract 1/2" (12.7) from M.O. (Masonry Opening) for Unit Sizes. Masonry Openings above include Sill Nose, see Trim Options page for Sill Nose specifications. For other Trim Options refer to the Unit Sizing, Rough Opening & Masonry Openings page.

SCALE 1/4" = 1'

SWINGING PATIO DOOR EXTENDED LEG SEGMENT TOP UNITS

M.O. BRICKMOULD 33 1/2" (851)
M.O. ADAMS/FLAT CASING 36 1/2" (927)
ROUGH OPENING 30 3/4" (781)
FRAME SIZE 30" (762)
DAYLIGHT OPENING 26 3/8" (670)

36 1/2" (927)
39 1/2" (1003)
33 3/4" (857)
33" (838)
29 3/8" (746)

39 1/2" (1003)
42 1/2" (1080)
36 3/4" (933)
36" (914)
32 3/8" (822)

63 1/2" (1613)
66 1/2" (1689)
60 3/4" (1543)
60" (1524)
56 3/8" (1432)

78 15/16" (2005)
80 7/16" (2043)
76 3/4" (1949)
76" (1930)
72 3/8" (1858)

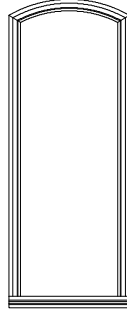

SDESP-26L60

79 7/8" (2029)
81 3/8" (2067)
77 11/16" (1973)
76 15/16" (1954)
73 5/16" (1862)

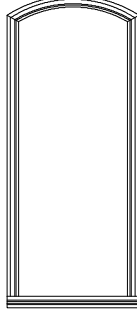

SDESP-29L60

80 15/16" (2056)
82 7/16" (2094)
78 3/4" (2000)
78" (1981)
74 3/8" (1889)

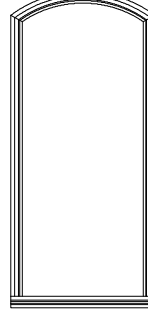

SDESP-30L60

83 5/16" (2116)
84 13/16" (2154)
81 1/8" (2061)
80 3/8" (2042)
76 3/4" (1949)

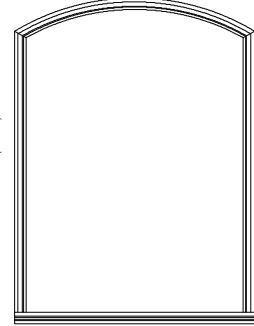

SDESP-50L60

ELEVATION SYMBOL LEGEND:

M.O. = MASONRY OPENING

VALUES IN () ARE IN MILLIMETER CONVERSIONS

Note: Elevations shown DO NOT have exterior trim. Subtract 1/2" (12.7) from M.O. (Masonry Opening) for Unit Sizes. Masonry Openings above include Sill Nose, see Trim Options page for Sill Nose specifications. For other Trim Options refer to the Unit Sizing, Rough Opening & Masonry Openings page.

SWINGING PATIO DOOR EXTENDED LEG SEGMENT TOP UNITS

**M.O. BRICKMOUND
M.O. ADAMS/FLAT CASING
ROUGH OPENING
FRAME SIZE
DAYLIGHT OPENING**

19 1/4" (489) 20 3/4" (527) 17 1/16" (433) 16 5/16" (414) 12 11/16" (322)	69 1/2" (1765) 72 1/2" (1842) 66 3/4" (1695) 66" (1676) 62 3/8" (1584)	75 1/2" (1918) 78 1/2" (1994) 72 3/4" (1848) 72" (1829) 68 3/8" (1737)		17 1/16" (433) 18 9/16" (471) 14 7/8" (378) 14 1/8" (359) 10 1/2" (267)	
25 1/4" (641) 26 3/4" (679) 23 1/16" (586) 22 5/16" (567) 18 11/16" (475)				23 1/16" (586) 24 9/16" (624) 20 7/8" (530) 20 1/8" (511) 16 1/2" (419)	
31 1/4" (794) 32 3/4" (832) 29 1/16" (738) 28 5/16" (719) 24 11/16" (627)				29 1/16" (738) 30 9/16" (776) 26 7/8" (683) 26 1/8" (664) 22 1/2" (572)	
37 1/4" (946) 38 3/4" (984) 35 1/16" (891) 34 5/16" (872) 30 11/16" (779)				35 1/16" (891) 36 9/16" (929) 32 7/8" (835) 32 1/8" (816) 28 1/2" (724)	
49 1/4" (1251) 50 3/4" (1289) 47 1/16" (1195) 46 5/16" (1176) 42 11/16" (1084)				47 1/16" (1195) 48 9/16" (1233) 44 7/8" (1140) 44 1/8" (1121) 40 1/2" (1029)	
61 1/4" (1556) 62 3/4" (1594) 59 1/16" (1500) 58 5/16" (1481) 54 11/16" (1389)				59 1/16" (1500) 60 9/16" (1538) 56 7/8" (1445) 56 1/8" (1426) 52 1/2" (1334)	
73 1/4" (1861) 74 3/4" (1899) 71 1/16" (1805) 70 5/16" (1786) 66 11/16" (1694)				71 1/16" (1805) 72 9/16" (1843) 68 7/8" (1749) 68 1/8" (1730) 64 1/2" (1638)	

ELEVATION SYMBOL LEGEND:

M.O. = MASONRY OPENING

VALUES IN () ARE IN MILLIMETER CONVERSIONS

Note: Elevations shown DO NOT have exterior trim. Subtract 1/2" (12.7) from M.O. (Masonry Opening) for Unit Sizes. Masonry Openings above include Sill Nose, see Trim Options page for Sill Nose specifications. For other Trim Options refer to the Unit Sizing, Rough Opening & Masonry Openings page.

SCALE 1/4" = 1'

SWINGING PATIO DOOR EXTENDED LEG SEGMENT TOP UNITS

M.O. BRICKMOULD	69 1/2" (1765)	75 1/2" (1918)
M.O. ADAMS/FLAT CASING	72 1/2" (1842)	78 1/2" (1994)
ROUGH OPENING	66 3/4" (1695)	72 3/4" (1848)
FRAME SIZE	66" (1676)	72" (1829)
DAYLIGHT OPENING	62 3/8" (1584)	68 3/8" (1737)

85 1/4" (2165)
86 3/4" (2203)
83 1/16" (2110)
82 5/16" (2091)
78 11/16" (1999)

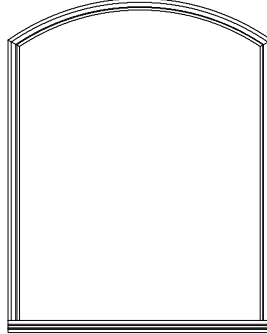

SDESP-56L60

83 1/16" (2110)
84 9/16" (2148)
80 7/8" (2054)
80 1/8" (2035)
76 1/2" (1943)

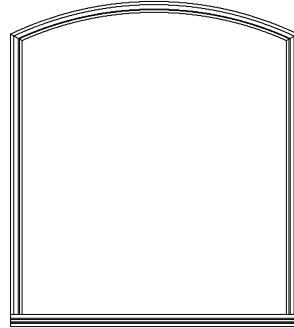

SDESP-60L60

ELEVATION SYMBOL LEGEND:

M.O. = MASONRY OPENING

VALUES IN () ARE IN MILLIMETER CONVERSIONS

Note: Elevations shown DO NOT have exterior trim. Subtract 1/2" (12.7) from M.O. (Masonry Opening) for Unit Sizes. Masonry Openings above include Sill Nose, see Trim Options page for Sill Nose specifications. For other Trim Options refer to the Unit Sizing, Rough Opening & Masonry Openings page.

300 SERIES SLIDING PATIO DOOR HALF ROUND UNITS

M.O. BRICKMOULD
M.O. ADAMS/FLAT CASING
ROUGH OPENING
FRAME SIZE
DAYLIGHT OPENING

33 1/4" (845)
36 1/4" (921)
30 1/2" (775)
29 3/4" (756)
26 1/8" (664)

39 1/4" (997)
42 1/4" (1073)
36 1/2" (927)
35 3/4" (908)
32 1/8" (816)

51 1/4" (1302)
54 1/4" (1378)
48 1/2" (1232)
47 3/4" (1213)
44 1/8" (1121)

60 1/2" (1537)
63 1/2" (1613)
57 3/4" (1467)
57" (1448)
53 3/8" (1356)

17 13/16" (452)
19 5/16" (491)
15 5/8" (395)
14 7/8" (378)
11 1/4" (286)



S3RTP-26

20 13/16" (529)
22 3/16" (567)
19 9/16" (513)
17 9/8" (454)
14 1/4" (362)

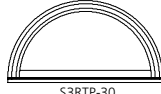

S3RTP-30

26 13/16" (681)
28 5/16" (719)
24 5/8" (625)
23 7/8" (606)
20 1/4" (514)



S3RTP-40

31 7/16" (799)
32 15/16" (837)
29 1/4" (743)
28 1/2" (724)
24 7/8" (632)

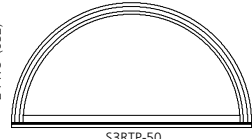

S3RTP-50

M.O. BRICKMOULD
M.O. ADAMS/FLAT CASING
ROUGH OPENING
FRAME SIZE
DAYLIGHT OPENING

72 1/2" (1842)
75 1/2" (1918)
69 3/4" (1772)
69" (1753)
65 3/8" (1661)

93 1/4" (2369)
96 1/4" (2445)
90 1/2" (2299)
89 3/4" (2280)
86 1/8" (2188)

37 7/16" (951)
38 15/16" (989)
35 1/4" (895)
34 1/2" (876)
30 7/8" (784)

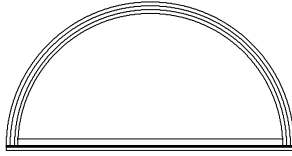

S3RTP-60

47 13/16" (1214)
49 5/16" (1253)
45 5/8" (1159)
44 7/8" (1140)
41 1/4" (1048)

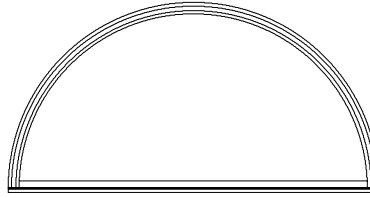

S3RTP-76

M.O. BRICKMOULD
M.O. ADAMS/FLAT CASING
ROUGH OPENING
FRAME SIZE
DAYLIGHT OPENING

96 1/2" (2451)
99 1/2" (2527)
93 3/4" (2381)
93" (2362)
89 3/8" (2270)

111 1/4" (2826)
114 1/4" (2902)
108 1/2" (2756)
107 3/4" (2737)
104 1/8" (2645)

49 7/16" (1256)
50 15/16" (1294)
47 1/4" (1200)
46 1/2" (1181)
42 7/8" (1089)

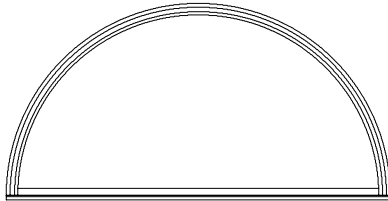

S3RTP-80

56 13/16" (1443)
58 5/16" (1481)
54 5/8" (1387)
53 7/8" (1368)
50 1/4" (1276)

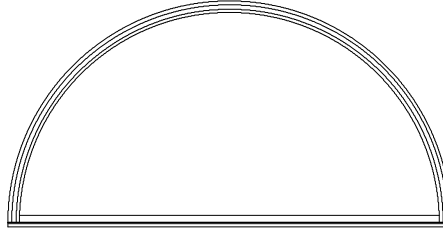

S3RTP-90

ELEVATION SYMBOL LEGEND:

M.O. = MASONRY OPENING

VALUES IN () ARE IN MILLIMETER CONVERSIONS

Note: Elevations shown DO NOT have exterior trim. Subtract 1/2" (12.7) from M.O. (Masonry Opening) for Unit Sizes. Masonry Openings above include Sill Nose, see Trim Options page for Sill Nose specifications. For other Trim Options refer to the Unit Sizing, Rough Opening & Masonry Openings page.





300 SERIES SLIDING PATIO DOOR EXTENDED HALF ROUND UNITS

M.O. BRICKMOUND 36 1/4"(921)
M.O. ADAMS/FLAT CASING 39 1/4"(997)
ROUGH OPENING 33 1/2"(851)
FRAME SIZE 32 3/4"(832)
DAYLIGHT OPENING 29 1/8"(740)

42 1/4"(1073)
 45 1/4"(1149)
 39 1/2"(1003)
 38 3/4"(984)
 35 1/8"(892)

54 1/4"(1378)
 57 1/4"(1454)
 51 1/2"(1308)
 50 3/4"(1289)
 47 1/8"(1197)

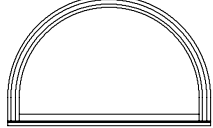
63 1/2"(1613)
 66 1/2"(1689)
 60 3/4"(1543)
 60"(1524)
 56 3/8"(1432)

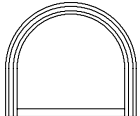
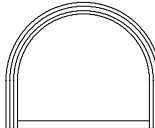
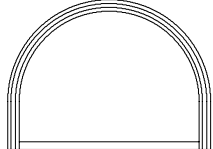
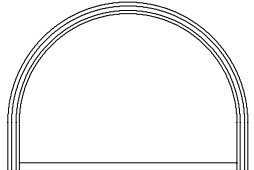
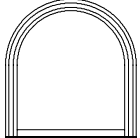
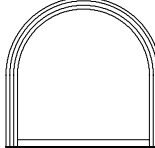
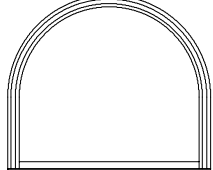
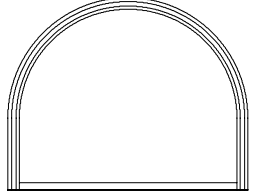
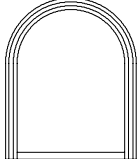
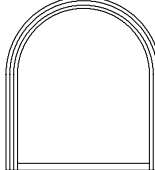
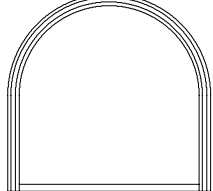
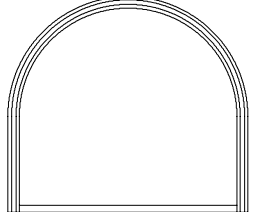
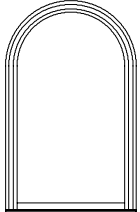
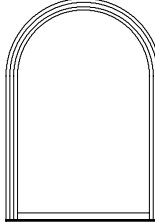
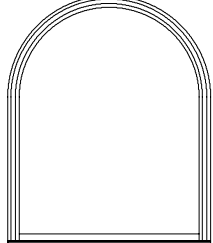
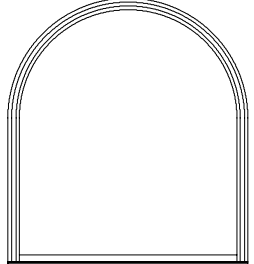
<p>25 5/16"(643) 26 13/16"(681) 23 1/8"(587) 22 3/8"(568) 18 3/4"(476)</p>  <p>S3EHP-26L06</p>	<p>38 5/16"(719) 29 13/16"(757) 26 1/8"(664) 25 3/8"(645) 21 3/4"(552)</p>  <p>S3EHP-30L06</p>	<p>34 5/16"(872) 35 13/16"(910) 32 1/8"(816) 31 3/8"(797) 27 3/4"(705)</p>  <p>S3EHP-40L06</p>	<p>38 15/16"(989) 40 7/16"(1027) 36 3/4"(933) 36"(914) 32 3/8"(822)</p>  <p>S3EHP-50L06</p>
<p>31 5/16"(795) 32 13/16"(833) 29 1/8"(740) 28 3/8"(721) 24 3/4"(629)</p>  <p>S3EHP-26L10</p>	<p>34 5/16"(872) 35 13/16"(910) 32 1/8"(816) 31 3/8"(797) 27 3/4"(705)</p>  <p>S3EHP-30L10</p>	<p>40 5/16"(1024) 41 13/16"(1062) 38 1/8"(968) 37 3/8"(949) 33 3/4"(857)</p>  <p>S3EHP-40L10</p>	<p>44 15/16"(1141) 46 7/16"(1180) 42 3/4"(1086) 42"(1067) 38 3/8"(975)</p>  <p>S3EHP-50L10</p>
<p>37 5/16"(948) 38 13/16"(986) 35 1/8"(892) 34 3/8"(873) 30 3/4"(781)</p>  <p>S3EHP-26L16</p>	<p>40 5/16"(1024) 41 13/16"(1062) 38 1/8"(968) 37 3/8"(949) 33 3/4"(857)</p>  <p>S3EHP-30L16</p>	<p>46 5/16"(1176) 47 13/16"(1214) 44 1/8"(1121) 43 3/8"(1102) 39 3/4"(1010)</p>  <p>S3EHP-40L16</p>	<p>50 15/16"(1294) 52 7/16"(1332) 48 3/4"(1238) 48"(1219) 44 3/8"(1127)</p>  <p>S3EHP-50L16</p>
<p>43 5/16"(1100) 44 13/16"(1138) 41 1/8"(1045) 40 3/8"(1026) 36 3/4"(933)</p>  <p>S3EHP-26L20</p>	<p>46 5/16"(1176) 47 13/16"(1214) 44 1/8"(1121) 43 3/8"(1102) 39 3/4"(1010)</p>  <p>S3EHP-30L20</p>	<p>52 5/16"(1329) 53 13/16"(1367) 50 1/8"(1273) 49 3/8"(1254) 45 3/4"(1162)</p>  <p>S3EHP-40L20</p>	<p>56 15/16"(1446) 58 7/16"(1484) 54 3/4"(1391) 54"(1372) 50 3/8"(1280)</p>  <p>S3EHP-50L20</p>
<p>55 5/16"(1405) 56 13/16"(1443) 53 1/8"(1349) 52 3/8"(1330) 48 3/4"(1238)</p>  <p>S3EHP-26L30</p>	<p>58 5/16"(1481) 59 13/16"(1519) 56 1/8"(1426) 55 3/8"(1407) 51 3/4"(1314)</p>  <p>S3EHP-30L30</p>	<p>64 5/16"(1634) 65 13/16"(1672) 62 1/8"(1578) 61 3/8"(1559) 57 3/4"(1467)</p>  <p>S3EHP-40L30</p>	<p>68 15/16"(1751) 70 7/16"(1789) 66 3/4"(1695) 66"(1676) 62 3/8"(1584)</p>  <p>S3EHP-50L30</p>

ELEVATION SYMBOL LEGEND:
M.O. = MASONRY OPENING
 VALUES IN () ARE IN MILLIMETER CONVERSIONS

Note: Elevations shown DO NOT have exterior trim. Subtract 1/2" (12.7) from M.O. (Masonry Opening) for Unit Sizes. Masonry Openings above include Sill Nose, see Trim Options page for Sill Nose specifications. For other Trim Options refer to the Unit Sizing, Rough Opening & Masonry Openings page.

SCALE 1/4" = 1'

300 SERIES SLIDING PATIO DOOR EXTENDED HALF ROUND UNITS

M.O. BRICKMOULD
M.O. ADAMS/FLAT CASING
ROUGH OPENING
FRAME SIZE
DAYLIGHT OPENING

36 1/4"(921)
39 1/4"(997)
33 1/2"(851)
32 3/4"(832)
29 1/8"(740)

42 1/4"(1073)
45 1/4"(1149)
39 1/2"(1003)
38 3/4"(984)
35 1/8"(892)

54 1/4"(1378)
57 1/4"(1454)
51 1/2"(1308)
50 3/4"(1289)
47 1/8"(1197)

63 1/2"(1613)
66 1/2"(1689)
60 3/4"(1543)
60"(1524)
56 3/8"(1432)

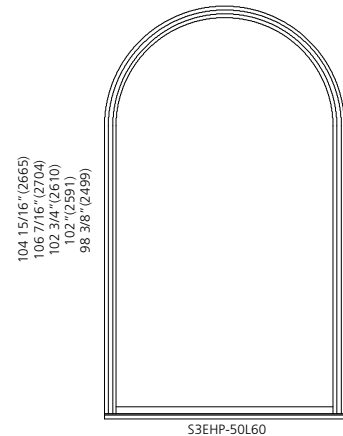
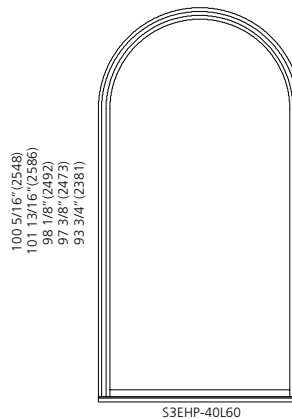
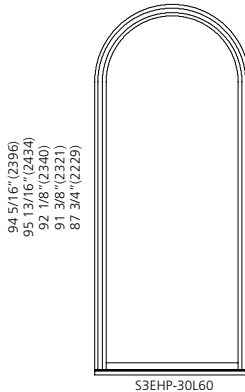
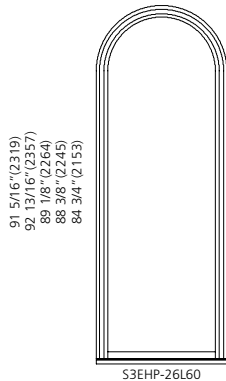
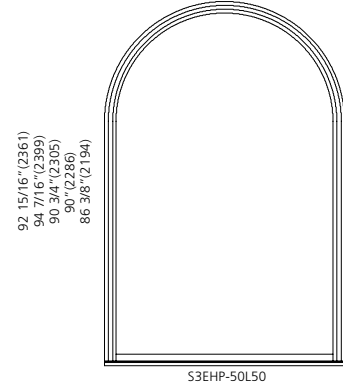
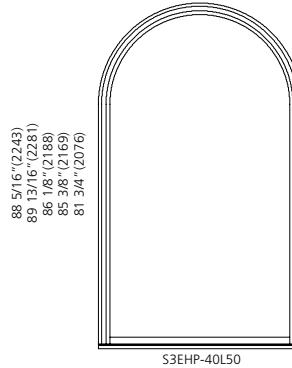
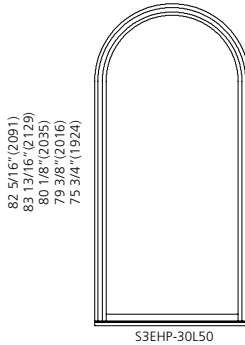
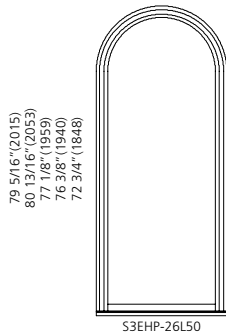
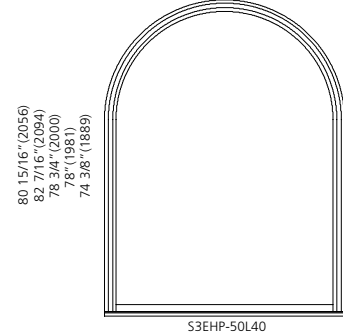
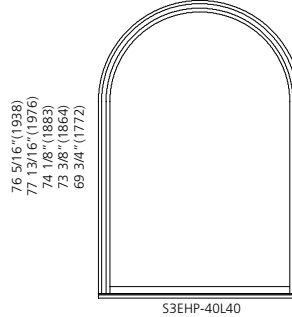
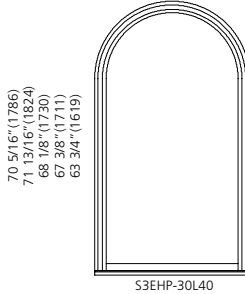
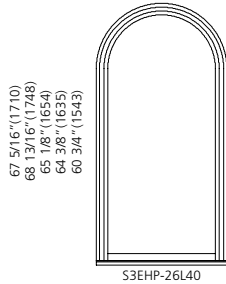

ELEVATION SYMBOL LEGEND:

M.O. = MASONRY OPENING
VALUES IN () ARE IN MILLIMETER CONVERSIONS

Note: Elevations shown DO NOT have exterior trim. Subtract 1/2" (12.7) from M.O. (Masonry Opening) for Unit Sizes. Masonry Openings above include Sill Nose, see Trim Options page for Sill Nose specifications. For other Trim Options refer to the Unit Sizing, Rough Opening & Masonry Openings page.

SCALE 1/4" = 1'

300 SERIES SLIDING PATIO DOOR EXTENDED HALF ROUND UNITS

M.O. BRICKMOULD
M.O. ADAMS/FLAT CASING
ROUGH OPENING
FRAME SIZE
DAYLIGHT OPENING

75 1/2" (1918)
78 1/2" (1994)
72 3/4" (1848)
72" (1829)
68 3/8" (1737)

44 15/16" (1141)
46 7/16" (1180)
42 3/4" (1086)
42" (1067)
38 3/8" (975)

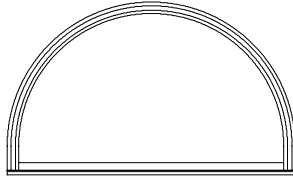

S3EHP-60L06

50 15/16" (1294)
52 7/16" (1332)
48 3/4" (1238)
48" (1219)
44 3/8" (1127)

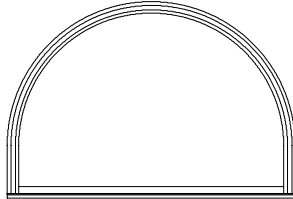

S3EHP-60L10

56 15/16" (1446)
58 7/16" (1484)
54 3/4" (1391)
54" (1372)
50 3/8" (1280)

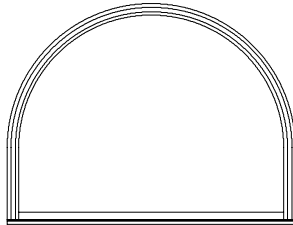

S3EHP-60L16

62 15/16" (1599)
64 7/16" (1637)
60 3/4" (1543)
60" (1524)
56 3/8" (1432)

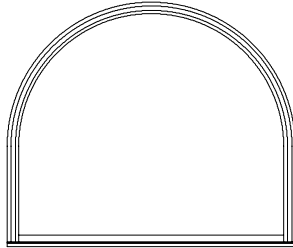

S3EHP-60L20

74 15/16" (1903)
76 7/16" (1942)
72 3/4" (1848)
72" (1829)
68 3/8" (1737)

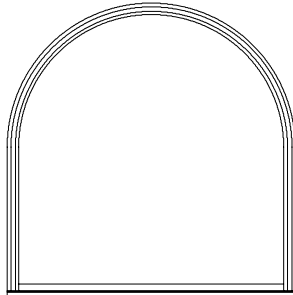

S3EHP-60L30

M.O. BRICKMOULD
M.O. ADAMS/FLAT CASING
ROUGH OPENING
FRAME SIZE
DAYLIGHT OPENING

75 1/2" (1918)
78 1/2" (1994)
72 3/4" (1848)
72" (1829)
68 3/8" (1737)

86 15/16" (2259)
88 7/16" (2246)
84 3/4" (2153)
84" (2134)
80 3/8" (2042)

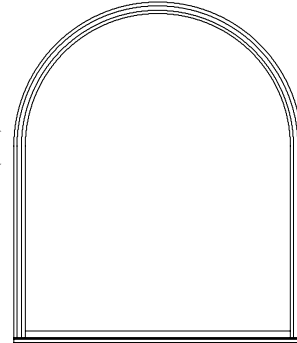

S3EHP-60L40

98 15/16" (2513)
100 7/16" (2551)
96 3/4" (2457)
96" (2438)
92 3/8" (2346)

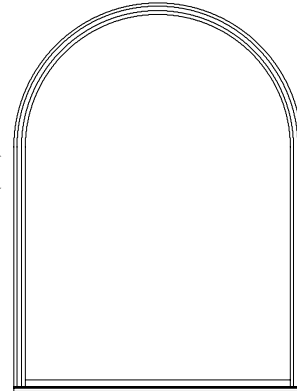

S3EHP-60L50





























ELEVATION SYMBOL LEGEND:

M.O. = MASONRY OPENING
VALUES IN () ARE IN MILLIMETER CONVERSIONS

Note: Elevations shown DO NOT have exterior trim. Subtract 1/2" (12.7) from M.O. (Masonry Opening) for Unit Sizes. Masonry Openings above include Sill Nose, see Trim Options page for Sill Nose specifications. For other Trim Options refer to the Unit Sizing, Rough Opening & Masonry Openings page.

SCALE 1/4" = 1'

300 SERIES SLIDING PATIO DOOR EXTENDED LEG SEGMENT TOP UNITS

M.O. BRICKMOULD	36 1/4" (921)	42 1/4" (1073)	54 1/4" (1378)	63 1/2" (1613)
M.O. ADAMS/FLAT CASING	39 1/4" (997)	45 1/4" (1149)	57 1/4" (1454)	66 1/2" (1689)
ROUGH OPENING	33 1/2" (851)	39 1/2" (1003)	51 1/2" (1308)	60 3/4" (1543)
FRAME SIZE	32 3/4" (832)	38 3/4" (984)	50 3/4" (1289)	60" (1524)
DAYLIGHT OPENING	29 1/8" (740)	35 1/8" (892)	47 1/8" (1197)	56 3/8" (1432)
13 13/16" (351) 15 7/16" (392) 11 5/8" (295) 17 5/8" (448) 10 7/8" (276) 7 1/4" (184)	 S3ESP-26L06	 S3ESP-30L06	 S3ESP-40L06	 S3ESP-50L06
19 13/16" (503) 21 7/16" (545) 17 5/8" (448) 16 7/8" (427) 13 1/4" (337)	 S3ESP-26L10	 S3ESP-30L10	 S3ESP-40L10	 S3ESP-50L10
25 13/16" (656) 27 7/16" (697) 23 5/8" (600) 22 7/8" (581) 19 1/4" (489)	 S3ESP-26L16	 S3ESP-30L16	 S3ESP-40L16	 S3ESP-50L16
31 13/16" (808) 33 7/16" (849) 29 5/8" (752) 28 7/8" (733) 25 1/4" (641)	 S3ESP-26L20	 S3ESP-30L20	 S3ESP-40L20	 S3ESP-50L20
43 13/16" (1113) 45 7/16" (1154) 41 5/8" (1057) 40 7/8" (1038) 37 1/4" (946)	 S3ESP-26L30	 S3ESP-30L30	 S3ESP-40L30	 S3ESP-50L30
55 13/16" (1418) 57 7/16" (1459) 53 5/8" (1362) 52 7/8" (1343) 49 1/4" (1251)	 S3ESP-26L40	 S3ESP-30L40	 S3ESP-40L40	 S3ESP-50L40
67 13/16" (1722) 69 7/16" (1764) 65 5/8" (1667) 64 7/8" (1648) 61 1/4" (1556)	 S3ESP-26L50	 S3ESP-30L50	 S3ESP-40L50	 S3ESP-50L50
14 13/16" (376) 16 7/16" (418) 12 5/8" (321) 11 7/8" (302) 8 1/4" (210)	16 1/16" (408) 17 9/16" (446) 13 7/8" (352) 13 1/8" (333) 9 1/2" (241)	20 13/16" (529) 22 7/16" (570) 18 5/8" (473) 17 7/8" (454) 14 1/4" (362)	28 7/16" (722) 24 5/8" (625) 23 7/8" (607) 20 1/4" (514)	23 7/16" (595) 24 13/16" (630) 21 1/8" (537) 20 3/8" (518) 16 3/4" (425)
32 13/16" (833) 34 7/16" (875) 30 5/8" (778) 29 7/8" (759) 26 1/4" (667)	34 1/16" (865) 35 9/16" (903) 31 7/8" (810) 31 1/8" (791) 27 1/2" (699)	44 13/16" (1138) 46 7/16" (1180) 42 5/8" (1083) 41 7/8" (1064) 38 1/4" (972)	47 7/16" (1205) 48 13/16" (1240) 45 1/8" (1146) 44 3/8" (1127) 40 3/4" (1035)	35 7/16" (900) 36 13/16" (935) 33 1/8" (841) 32 3/8" (822) 28 3/4" (730)
58 13/16" (1443) 58 7/16" (1484) 54 5/8" (1387) 53 7/8" (1368) 50 1/4" (1276)	58 1/16" (1475) 59 9/16" (1513) 55 7/8" (1419) 55 1/8" (1400) 51 1/2" (1308)	68 13/16" (1748) 70 7/16" (1789) 66 5/8" (1692) 65 7/8" (1673) 62 1/4" (1581)	59 7/16" (1510) 60 13/16" (1545) 57 1/8" (1451) 56 3/8" (1432) 52 3/4" (1340)	71 7/16" (1815) 72 13/16" (1849) 69 1/8" (1756) 68 3/8" (1737) 64 3/4" (1645)

ELEVATION SYMBOL LEGEND:

M.O. = MASONRY OPENING

VALUES IN () ARE IN MILLIMETER CONVERSIONS

Note: Elevations shown DO NOT have exterior trim. Subtract 1/2" (12.7) from M.O. (Masonry Opening) for Unit Sizes. Masonry Openings above include Sill Nose, see Trim Options page for Sill Nose specifications. For other Trim Options refer to the Unit Sizing, Rough Opening & Masonry Openings page.

SCALE 1/4" = 1'

300 SERIES SLIDING PATIO DOOR EXTENDED LEG SEGMENT TOP UNITS

M.O. BRICKMOULD 36 1/4" (921)
M.O. ADAMS/FLAT CASING 39 1/4" (997)
ROUGH OPENING 33 1/2" (851)
FRAME SIZE 32 3/4" (832)
DAYLIGHT OPENING 29 1/8" (740)

42 1/4" (1073)
45 1/4" (1149)
39 1/2" (1003)
38 3/4" (984)
35 1/8" (892)

54 1/4" (1378)
57 1/4" (1454)
51 1/2" (1308)
50 3/4" (1289)
47 1/8" (1197)

63 1/2" (1613)
66 1/2" (1689)
60 3/4" (1543)
60" (1524)
56 3/8" (1432)

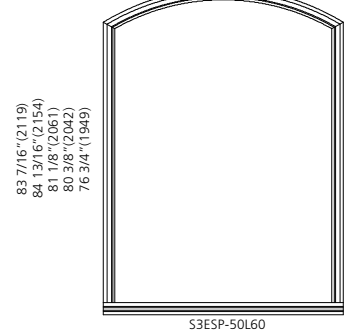
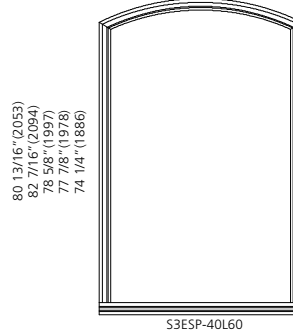
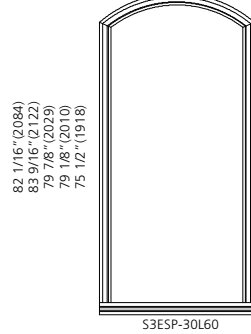
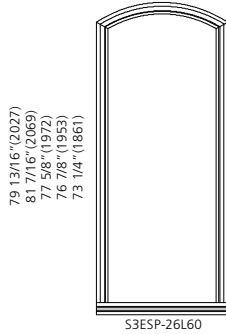

ELEVATION SYMBOL LEGEND:

M.O. = MASONRY OPENING

VALUES IN () ARE IN MILLIMETER CONVERSIONS

Note: Elevations shown DO NOT have exterior trim. Subtract 1/2" (12.7) from M.O. (Masonry Opening) for Unit Sizes. Masonry Openings above include Sill Nose, see Trim Options page for Sill Nose specifications. For other Trim Options refer to the Unit Sizing, Rough Opening & Masonry Openings page.

300 SERIES SLIDING PATIO DOOR EXTENDED LEG SEGMENT TOP UNITS

M.O. BRICKMOULD 75 1/2" (1918)
M.O. ADAMS/FLAT CASING 78 1/2" (1994)
ROUGH OPENING 72 3/4" (1848)
FRAME SIZE 72" (1829)
DAYLIGHT OPENING 68 3/8" (1737)

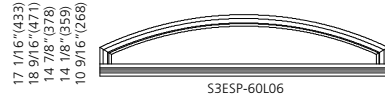

S3ESP-60L06



S3ESP-60L10



S3ESP-60L16



S3ESP-60L20

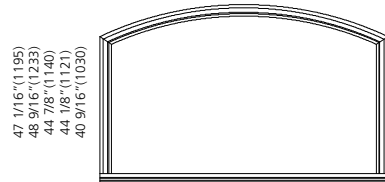

S3ESP-60L30

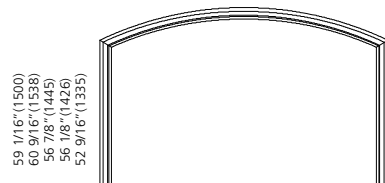

S3ESP-60L40

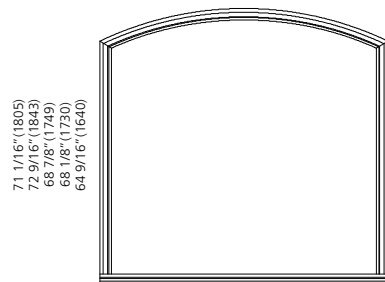

S3ESP-60L50

M.O. BRICKMOULD 75 1/2" (1918)
M.O. ADAMS/FLAT CASING 78 1/2" (1994)
ROUGH OPENING 72 3/4" (1848)
FRAME SIZE 72" (1829)
DAYLIGHT OPENING 68 3/8" (1737)

83 1/16" (2110)
84 9/16" (2148)
80 7/8" (2051)
80 1/8" (2035)
76 9/16" (1945)

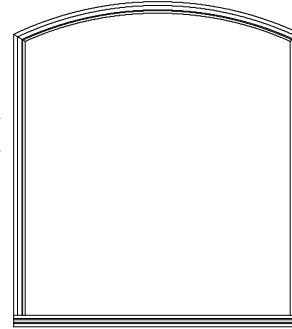

S3ESP-60L60

ELEVATION SYMBOL LEGEND:
M.O. = MASONRY OPENING
VALUES IN () ARE IN MILLIMETER CONVERSIONS

Note: Elevations shown DO NOT have exterior trim. Subtract 1/2" (12.7) from M.O. (Masonry Opening) for Unit Sizes. Masonry Openings above include Sill Nose, see Trim Options page for Sill Nose specifications. For other Trim Options refer to the Unit Sizing, Rough Opening & Masonry Openings page.

SCALE 1/4" = 1'

400 SERIES SLIDING PATIO DOOR HALF ROUND UNITS

M.O. BRICKMOUND
M.O. ADAMS/FLAT CASING
ROUGH OPENING
FRAME SIZE
DAYLIGHT OPENING

34"(864)
37"(940)
31 1/4"(794)
30 1/2"(775)
26 7/8"(683)

40"(1016)
43"(1092)
37 1/4"(946)
36 1/2"(927)
32 7/8"(835)

52"(1321)
55"(1397)
49 1/4"(1251)
48 1/2"(1232)
44 7/8"(1140)

60 1/2"(1537)
63 1/2"(1642)
57 3/4"(1467)
57"(1449)
53 3/8"(1356)

18 3/16"(462)
19 1/16"(500)
16"(406)
15 1/4"(387)
11 5/8"(295)



S4RTP-26

21 3/16"(538)
22 1/16"(576)
19 1/4"(496)
18 1/4"(464)
14 5/8"(371)



S4RTP-30

27 3/16"(691)
28 1/16"(729)
25"(635)
24 1/4"(616)
20 5/8"(524)



S4RTP-40

31 7/16"(799)
32 15/16"(837)
29 1/4"(743)
28 1/2"(724)
24 7/8"(632)



S4RTP-50

M.O. BRICKMOUND
M.O. ADAMS/FLAT CASING
ROUGH OPENING
FRAME SIZE
DAYLIGHT OPENING

72 1/2"(1842)
75 1/2"(1918)
69 3/4"(1772)
69"(1753)
65 3/8"(1584)

94"(2388)
97"(2464)
91 1/4"(2318)
90 1/2"(2299)
86 7/8"(2207)

37 7/16"(951)
38 15/16"(989)
35 1/4"(895)
34 1/2"(876)
30 7/8"(784)

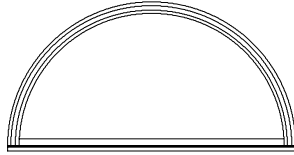

S4RTP-60

48 3/16"(1224)
49 1/16"(1262)
46"(1168)
45 1/4"(1149)
44 5/8"(1133)

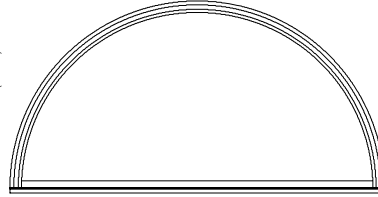

S4RTP-76

M.O. BRICKMOUND
M.O. ADAMS/FLAT CASING
ROUGH OPENING
FRAME SIZE
DAYLIGHT OPENING

96 1/2"(2451)
99 1/2"(2527)
93 3/4"(2381)
93"(2362)
89 3/8"(2270)

112"(2849)
115"(2921)
109 1/4"(2775)
108 1/2"(2756)
104 7/8"(2664)

49 7/16"(1256)
50 15/16"(1294)
47 1/4"(1200)
46 1/2"(1181)
42 7/8"(1089)

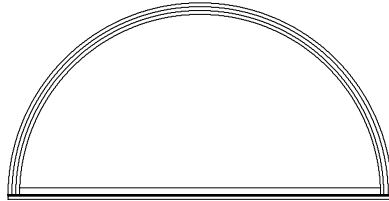

S4RTP-80

57 3/16"(1453)
58 1/16"(1491)
55"(1397)
54 1/4"(1378)
54 5/8"(1387)

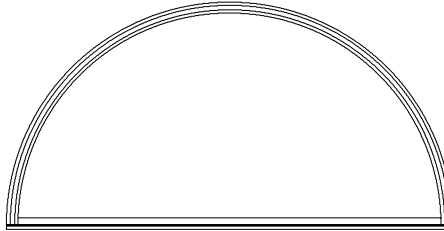

S4RTP-90

ELEVATION SYMBOL LEGEND:

M.O. = MASONRY OPENING

VALUES IN () ARE IN MILLIMETER CONVERSIONS

Note: Elevations shown DO NOT have exterior trim. Subtract 1/2" (12.7) from M.O. (Masonry Opening) for Unit Sizes. Masonry Openings above include Sill Nose, see Trim Options page for Sill Nose specifications. For other Trim Options refer to the Unit Sizing, Rough Opening & Masonry Openings page.

400 SERIES SLIDING PATIO DOOR EXTENDED HALF ROUND UNITS

M.O. BRICKMOULD 36 15/16" (938)
M.O. ADAMS/FLAT CASING 39 15/16" (1014)
ROUGH OPENING 34 3/16" (868)
FRAME SIZE 33 7/16" (849)
DAYLIGHT OPENING 29 13/16" (757)

42 15/16" (1091)
 45 15/16" (1169)
 40 3/16" (1021)
 39 7/16" (1002)
 35 13/16" (910)

54 15/16" (1395)
 57 15/16" (1472)
 52 3/16" (1326)
 51 7/16" (1307)
 47 13/16" (1214)

63 1/2" (1613)
 66 1/2" (1689)
 60 3/4" (1543)
 60" (1524)
 56 3/8" (1432)

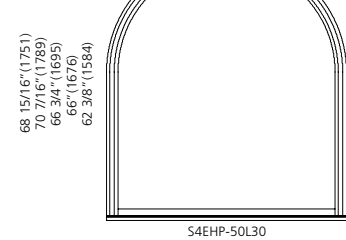
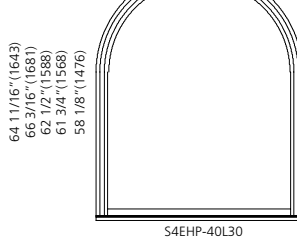
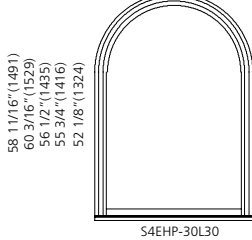
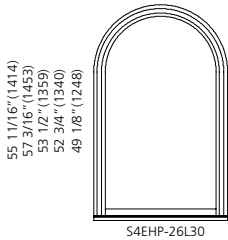
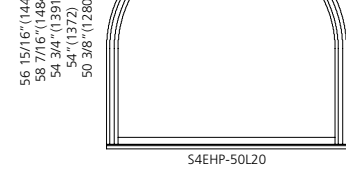
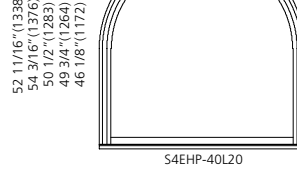
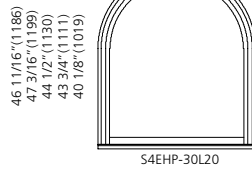
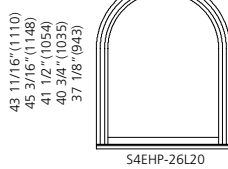
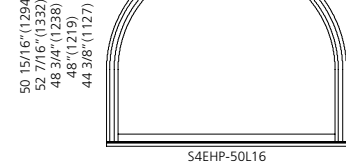
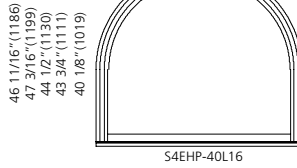
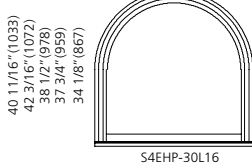
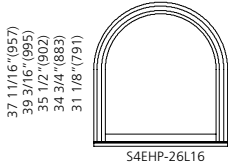
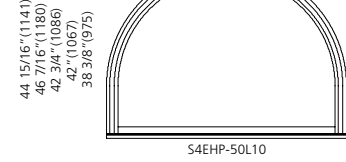
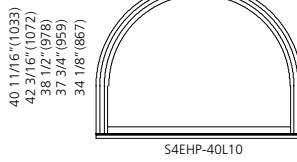
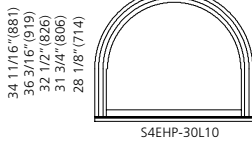
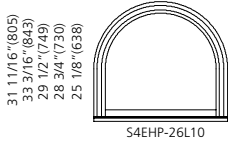
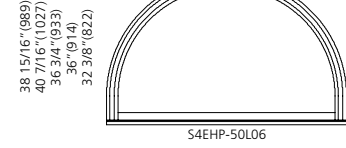
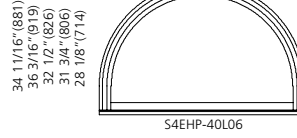
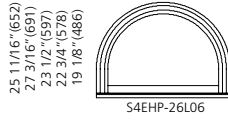

ELEVATION SYMBOL LEGEND:

M.O. = MASONRY OPENING

VALUES IN () ARE IN MILLIMETER CONVERSIONS

Note: Elevations shown DO NOT have exterior trim. Subtract 1/2" (12.7) from M.O. (Masonry Opening) for Unit Sizes. Masonry Openings above include Sill Nose, see Trim Options page for Sill Nose specifications. For other Trim Options refer to the Unit Sizing, Rough Opening & Masonry Openings page.

SCALE 1/4" = 1'

400 SERIES SLIDING PATIO DOOR EXTENDED HALF ROUND UNITS

M.O. BRICKMOUND 36 15/16" (938)
 M.O. ADAMS/FLAT CASING 39 15/16" (1014)
 ROUGH OPENING 34 3/16" (868)
 FRAME SIZE 33 7/16" (849)
 DAYLIGHT OPENING 29 13/16" (757)

42 15/16" (1091)
 45 15/16" (1169)
 40 3/16" (1021)
 39 7/16" (1002)
 35 13/16" (910)

54 15/16" (1395)
 57 15/16" (1472)
 52 3/16" (1326)
 51 7/16" (1307)
 47 13/16" (1214)

63 1/2" (1613)
 66 1/2" (1689)
 60 3/4" (1543)
 60" (1524)
 56 3/8" (1432)

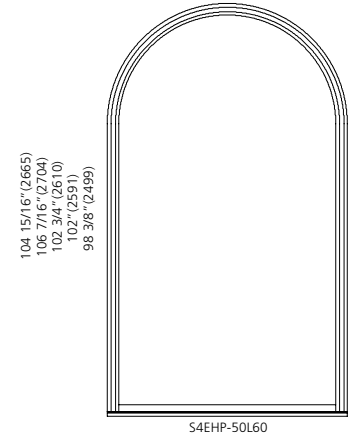
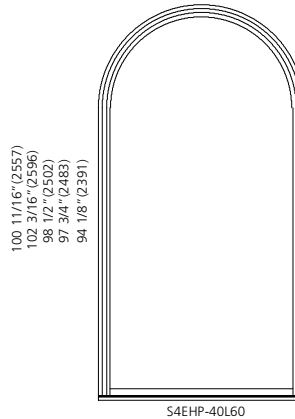
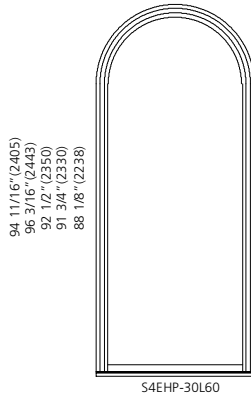
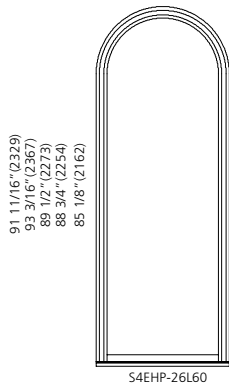
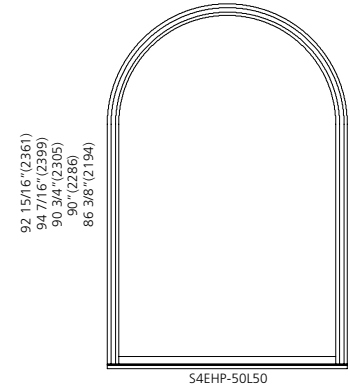
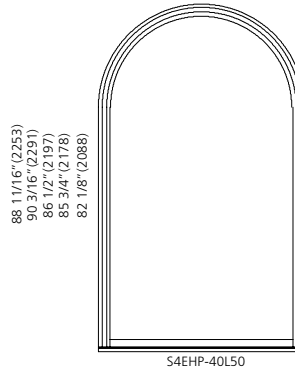
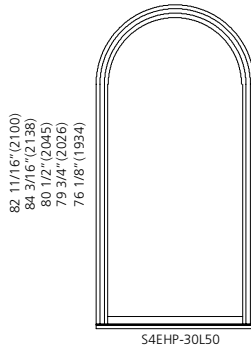
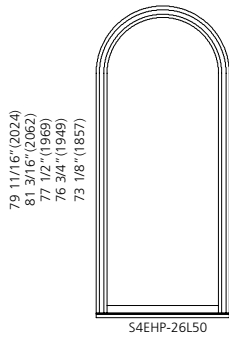
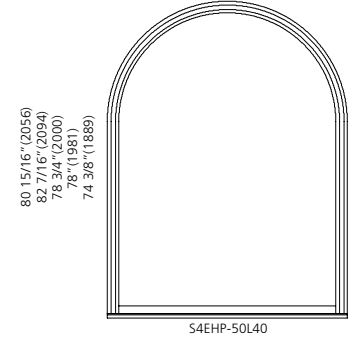
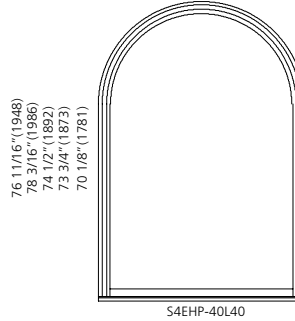
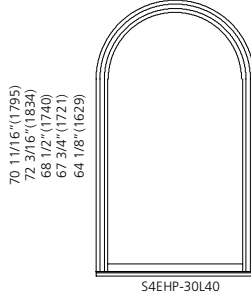
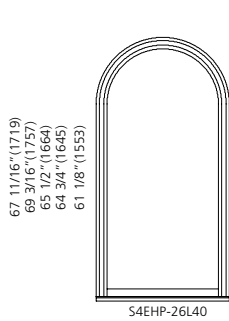

ELEVATION SYMBOL LEGEND:
 M.O. = MASONRY OPENING
 VALUES IN () ARE IN MILLIMETER CONVERSIONS

Note: Elevations shown DO NOT have exterior trim. Subtract 1/2" (12.7) from M.O. (Masonry Opening) for Unit Sizes. Masonry Openings above include Sill Nose, see Trim Options page for Sill Nose specifications. For other Trim Options refer to the Unit Sizing, Rough Opening & Masonry Openings page.

SCALE 1/4" = 1'

400 SERIES SLIDING PATIO DOOR EXTENDED HALF ROUND UNITS

M.O. BRICKMOULD 75 1/2" (1918)
M.O. ADAMS/FLAT CASING 78 1/2" (1994)
ROUGH OPENING 72 3/4" (1848)
FRAME SIZE 72" (1829)
DAYLIGHT OPENING 68 3/8" (1737)

44 15/16" (1141)
46 7/16" (1180)
42 3/4" (1086)
42" (1067)
38 3/8" (975)

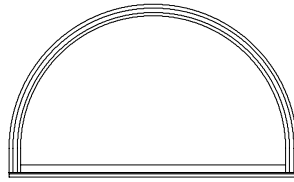

S4EHP-60L06

50 15/16" (1294)
52 7/16" (1332)
48 3/4" (1238)
48" (1219)
44 3/8" (1127)

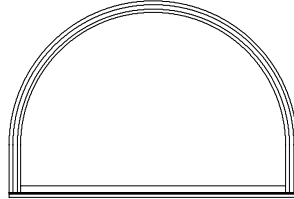

S4EHP-60L10

56 15/16" (1446)
58 7/16" (1484)
54 3/4" (1391)
54" (1372)
50 3/8" (1280)

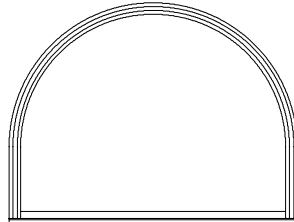

S4EHP-60L16

62 15/16" (1599)
64 7/16" (1637)
60 3/4" (1543)
60" (1524)
56 3/8" (1432)

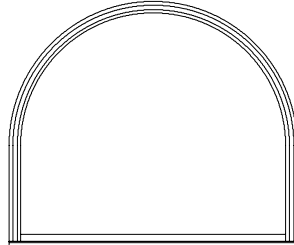

S4EHP-60L20

74 15/16" (1903)
76 7/16" (1942)
72 3/4" (1848)
72" (1829)
68 3/8" (1737)

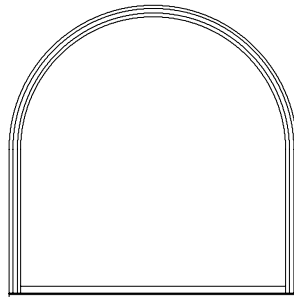

S4EHP-60L30

M.O. BRICKMOULD 75 1/2" (1918)
M.O. ADAMS/FLAT CASING 78 1/2" (1994)
ROUGH OPENING 72 3/4" (1848)
FRAME SIZE 72" (1829)
DAYLIGHT OPENING 68 3/8" (1737)

86 15/16" (2208)
88 7/16" (2246)
84 3/4" (2153)
84" (2134)
80 3/8" (2042)

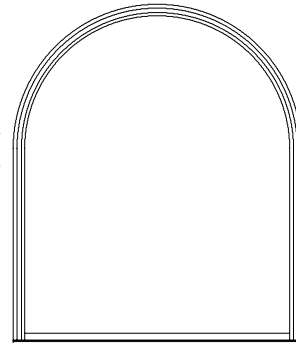

S4EHP-60L40

98 15/16" (2513)
100 7/16" (2551)
96 3/4" (2457)
96" (2438)
92 3/8" (2346)

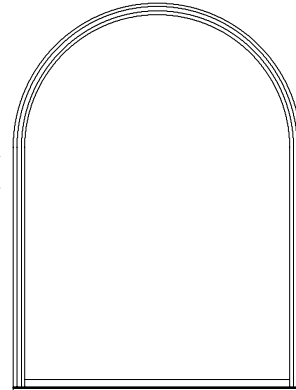

S4EHP-60L50

ELEVATION SYMBOL LEGEND:
M.O. = MASONRY OPENING
VALUES IN () ARE IN MILLIMETER CONVERSIONS

Note: Elevations shown DO NOT have exterior trim. Subtract 1/2" (12.7) from M.O. (Masonry Opening) for Unit Sizes. Masonry Openings above include Sill Nose, see Trim Options page for Sill Nose specifications. For other Trim Options refer to the Unit Sizing, Rough Opening & Masonry Openings page.

SCALE 1/4" = 1'

400 SERIES SLIDING PATIO DOOR EXTENDED LEG SEGMENT TOP UNITS

M.O. BRICKMOULD
M.O. ADAMS/FLAT CASING
ROUGH OPENING
FRAME SIZE
DAYLIGHT OPENING

36 15/16" (938)
39 15/16" (1014)
34 3/16" (868)
33 7/16" (849)
29 13/16" (757)

42 15/16" (1091)
45 15/16" (1169)
40 3/16" (1021)
39 7/16" (1002)
35 13/16" (910)

54 15/16" (1395)
57 15/16" (1471)
52 3/16" (1326)
51 7/16" (1306)
47 13/16" (1214)

63 1/2" (1613)
66 1/2" (1689)
60 3/4" (1543)
60" (1524)
56 3/8" (1432)

14" (356)
15 1/2" (394)
11 13/16" (300)
17 1/16" (281)
7 7/16" (189)



S4ESP-26L06

15 13/16" (402)
17 5/16" (440)
14 1 8/8" (359)
13 3/8" (340)
9 3/4" (248)



S4ESP-30L06

14 15/16" (379)
15 7/16" (418)
12 3/4" (324)
12" (305)
8 3/8" (213)

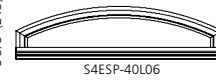

S4ESP-40L06

17 5/16" (440)
18 13/16" (478)
15 3/8" (384)
15 1/8" (367)
14 3/8" (365)
10 3/4" (273)



S4ESP-50L06

20" (508)
21 1/2" (546)
17 13/16" (452)
17 1/16" (433)
13 7/16" (341)



S4ESP-26L10

21 13/16" (554)
23 5/16" (592)
20 1/8" (511)
19 3/8" (492)
15 3/4" (400)



S4ESP-30L10

20 15/16" (532)
22 7/16" (570)
18 3/4" (476)
18" (457)
14 3/8" (365)



S4ESP-40L10

23 5/16" (592)
24 13/16" (630)
21 1/8" (537)
20 3/8" (518)
16 3/4" (425)



S4ESP-50L10

26" (660)
27 1/2" (699)
23 13/16" (605)
23 1/16" (586)
19 7/16" (494)

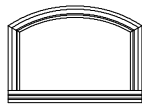

S4ESP-26L16

27 13/16" (706)
29 5/16" (745)
26 1/8" (664)
25 3/8" (645)
21 3/4" (552)



S4ESP-30L16

26 15/16" (684)
28 7/16" (722)
24 3/4" (629)
24" (610)
20 3/8" (518)

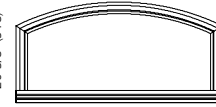

S4ESP-40L16

29 5/16" (745)
30 13/16" (783)
27 1/8" (690)
26 3/8" (671)
22 3/4" (578)



S4ESP-50L16

32" (813)
33 1/2" (851)
29 13/16" (757)
29 1/16" (738)
25 7/16" (646)

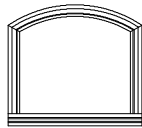

S4ESP-26L20

33 13/16" (859)
35 5/16" (897)
32 1/8" (816)
31 3/8" (797)
27 3/4" (705)

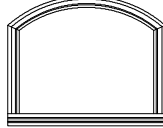

S4ESP-30L20

32 15/16" (837)
34 7/16" (875)
30 3/4" (781)
30" (762)
26 3/8" (670)



S4ESP-40L20

35 5/16" (897)
36 13/16" (935)
33 1/8" (841)
32 3/8" (822)
28 3/4" (730)



S4ESP-50L20

44" (1118)
45 1/2" (1156)
41 13/16" (1062)
41 1/16" (1043)
37 7/16" (951)

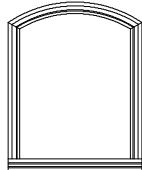

S4ESP-26L30

45 13/16" (1164)
47 5/16" (1202)
44 1/8" (1121)
43 3/8" (1102)
39 3/4" (1010)

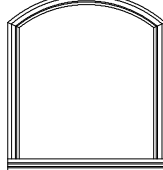

S4ESP-30L30

44 15/16" (1141)
46 7/16" (1180)
42 3/4" (1086)
42" (1067)
38 3/8" (975)

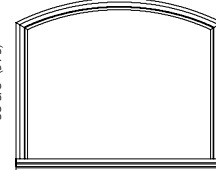

S4ESP-40L30

47 5/16" (1202)
48 13/16" (1240)
45 1/8" (1146)
44 3/8" (1127)
40 3/4" (1035)



S4ESP-50L30

56" (1422)
57 1/2" (1461)
53 13/16" (1367)
53 1/16" (1348)
49 7/16" (1256)

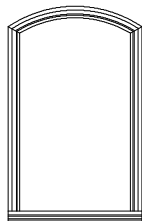

S4ESP-26L40

57 13/16" (1468)
59 5/16" (1507)
56 1/8" (1426)
55 3/8" (1407)
51 3/4" (1314)

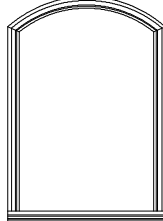

S4ESP-30L40

56 15/16" (1446)
58 7/16" (1484)
54 3/4" (1391)
54" (1372)
50 3/8" (1280)

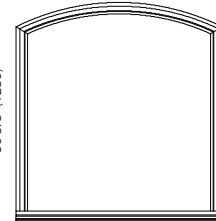

S4ESP-40L40

59 5/16" (1507)
60 13/16" (1545)
57 1/8" (1451)
56 3/8" (1432)
52 3/4" (1340)

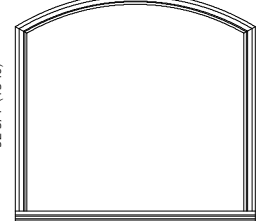

S4ESP-50L40

68" (1727)
69 1/2" (1765)
65 13/16" (1672)
65 1/16" (1653)
61 7/16" (1561)

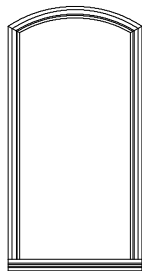

S4ESP-26L50

69 13/16" (1773)
71 5/16" (1811)
68 1/8" (1730)
67 3/8" (1711)
63 3/4" (1619)

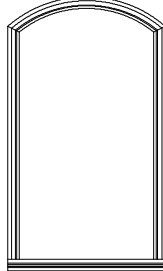

S4ESP-30L50

68 15/16" (1751)
70 7/16" (1789)
66 3/4" (1695)
66" (1676)
62 3/8" (1584)

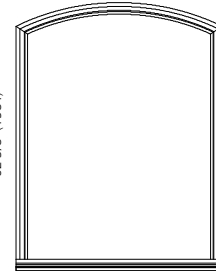

S4ESP-40L50

71 5/16" (1811)
72 13/16" (1849)
69 3/8" (1756)
68 3/8" (1737)
64 3/4" (1645)

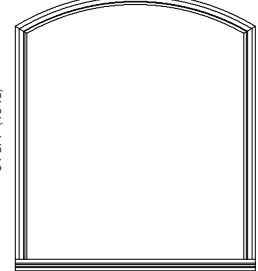

S4ESP-50L50

ELEVATION SYMBOL LEGEND:

M.O. = MASONRY OPENING

VALUES IN () ARE IN MILLIMETER CONVERSIONS

Note: Elevations shown DO NOT have exterior trim. Subtract 1/2" (12.7) from M.O. (Masonry Opening) for Unit Sizes. Masonry Openings above include Sill Nose, see Trim Options page for Sill Nose specifications. For other Trim Options refer to the Unit Sizing, Rough Opening & Masonry Openings page.

SCALE 1/4" = 1'

400 SERIES SLIDING PATIO DOOR EXTENDED LEG SEGMENT TOP UNITS

M.O. BRICKMOULD
M.O. ADAMS/FLAT CASING
ROUGH OPENING
FRAME SIZE
DAYLIGHT OPENING

36 15/16" (938)
39 15/16" (1014)
34 3/16" (868)
33 7/16" (849)
29 13/16" (757)

42 15/16" (1091)
45 15/16" (1169)
40 3/16" (1021)
39 7/16" (1002)
35 13/16" (910)

54 15/16" (1395)
57 15/16" (1471)
52 3/16" (1326)
51 7/16" (1306)
47 13/16" (1214)

63 1/2" (1613)
66 1/2" (1689)
60 3/4" (1543)
60" (1524)
56 3/8" (1432)

80" (2032)
81 1/2" (2070)
77 13/16" (1976)
77 1/16" (1957)
73 7/16" (1865)

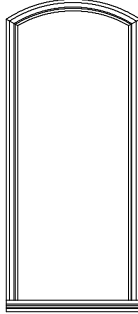

S4ESP-26L60

81 13/16" (2078)
83 5/16" (2116)
80 1/8" (2035)
79 3/8" (2016)
75 3/4" (1924)

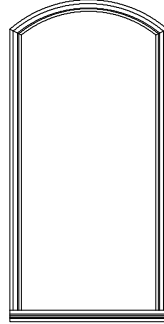

S4ESP-30L60

80 15/16" (2056)
82 7/16" (2094)
78 3/4" (2000)
78" (1981)
74 3/8" (1889)

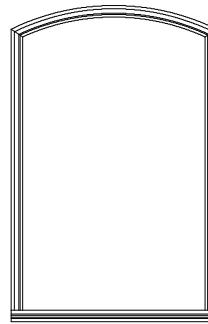

S4ESP-40L60

83 5/16" (2116)
84 13/16" (2154)
81 1/8" (2061)
80 3/8" (2042)
76 3/4" (1949)

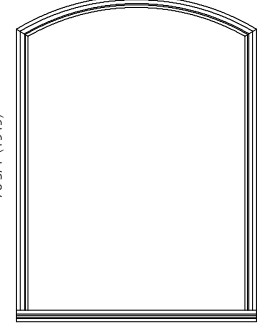

S4ESP-50L60

ELEVATION SYMBOL LEGEND:

M.O. = MASONRY OPENING

VALUES IN () ARE IN MILLIMETER CONVERSIONS

Note: Elevations shown DO NOT have exterior trim. Subtract 1/2" (12.7) from M.O. (Masonry Opening) for Unit Sizes. Masonry Openings above include Sill Nose, see Trim Options page for Sill Nose specifications. For other Trim Options refer to the Unit Sizing, Rough Opening & Masonry Openings page.

SCALE 1/4" = 1'

400 SERIES SLIDING PATIO DOOR EXTENDED LEG SEGMENT TOP UNITS

M.O. BRICKMOULD
M.O. ADAMS/FLAT CASING
ROUGH OPENING
FRAME SIZE
DAYLIGHT OPENING

75 1/2" (1918)
78 1/2" (1994)
72 3/4" (1848)
72" (1829)
68 3/8" (1737)

17 1/16" (433)
18 9/16" (471)
20 7/8" (378)
14 7/8" (359)
10 1/2" (267)

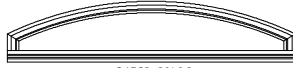

S4ESP-60L06

23 1/16" (586)
24 9/16" (624)
20 7/8" (530)
20 1/8" (511)
16 1/2" (419)



S4ESP-60L10

29 1/16" (738)
30 9/16" (776)
26 7/8" (683)
26 1/8" (664)
22 1/2" (572)



S4ESP-60L16

35 1/16" (891)
36 9/16" (929)
32 7/8" (835)
32 1/8" (816)
28 1/2" (724)



S4ESP-60L20

47 1/16" (1195)
48 9/16" (1233)
44 7/8" (1140)
44 1/8" (1121)
40 1/2" (1029)

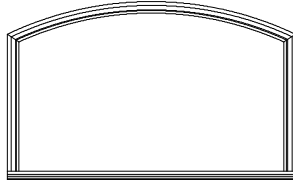

S4ESP-60L30

59 1/16" (1500)
60 9/16" (1538)
56 7/8" (1445)
56 1/8" (1426)
52 1/2" (1334)

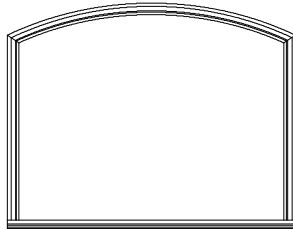

S4ESP-60L40

71 1/16" (1805)
72 9/16" (1843)
68 7/8" (1749)
68 1/8" (1730)
64 1/2" (1638)

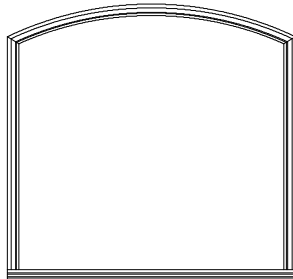

S4ESP-60L50

M.O. BRICKMOULD
M.O. ADAMS/FLAT CASING
ROUGH OPENING
FRAME SIZE
DAYLIGHT OPENING

75 1/2" (1918)
78 1/2" (1994)
72 3/4" (1848)
72" (1829)
68 3/8" (1737)

83 1/16" (2110)
84 9/16" (2148)
80 7/8" (2054)
80 1/8" (2035)
76 1/2" (1943)

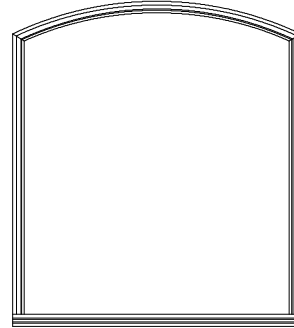

S4ESP-60L60

ELEVATION SYMBOL LEGEND:
M.O. = MASONRY OPENING
VALUES IN () ARE IN MILLIMETER CONVERSIONS

Note: Elevations shown DO NOT have exterior trim. Subtract 1/2" (12.7) from M.O. (Masonry Opening) for Unit Sizes. Masonry Openings above include Sill Nose, see Trim Options page for Sill Nose specifications. For other Trim Options refer to the Unit Sizing, Rough Opening & Masonry Openings page.

SCALE 1/4" = 1'

GLAZING OPTIONS

DIRECT-SET CASEMENT GLAZING OPTIONS

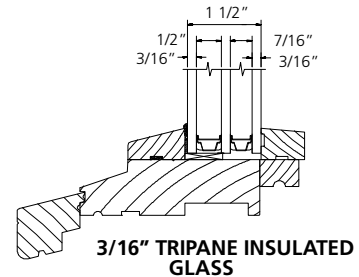
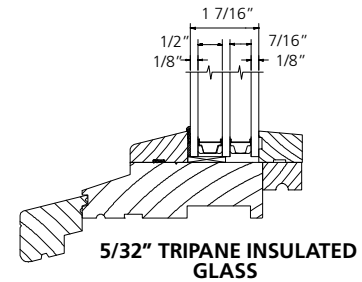
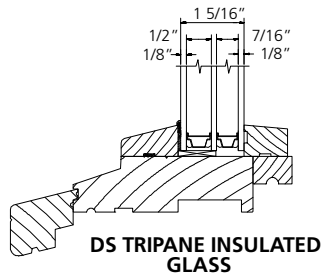
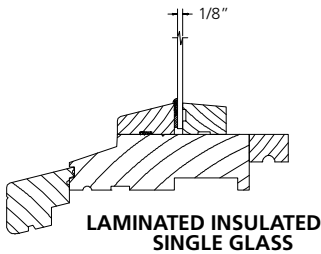
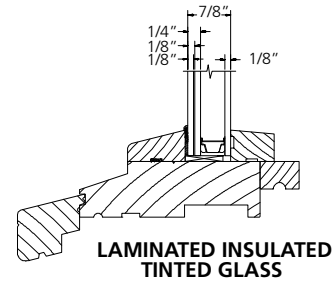
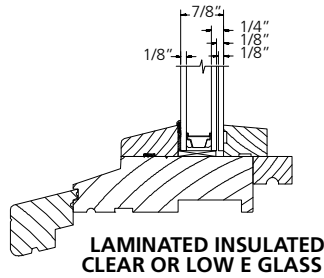
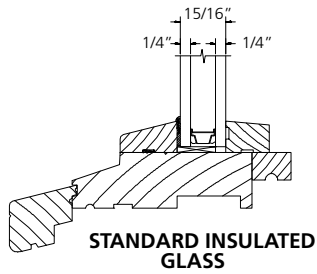
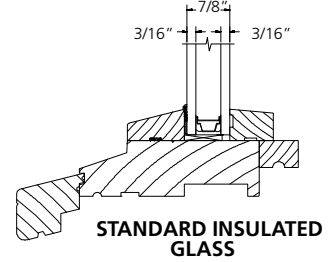
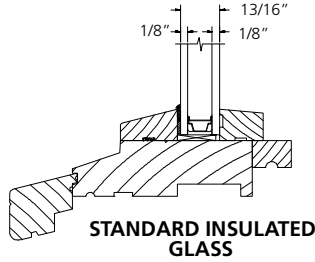
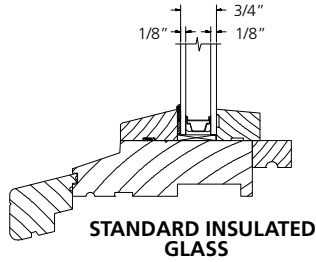
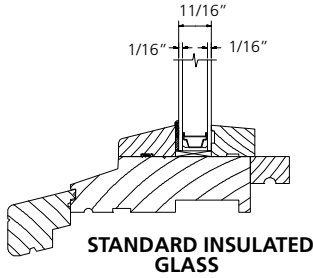

Note: Glazing options shown are available in Clad Geometric Direct-Set Windows with frame as shown and also in Clad Radius Direct-Set Windows and Wood Geometric and Radius Direct-Set Windows. See pages 9-74 to 9-77 for Clad Radius window frame and pages 11-73 to 11-76 for Wood Geometric and Radius frame details.

Note: Dual pane and tripane Insulated Glass shown with stainless steel warm edge spacer may also be built with aluminum box spacer depending on shape, glass type, or special grille bar pattern.

SCALE: 3" = 1'

TRIM OPTIONS

WOOD EXTERIOR TRIM

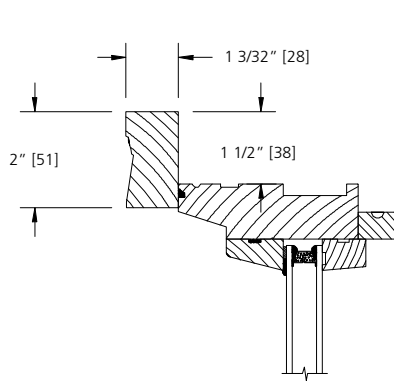

BRICKMOULD

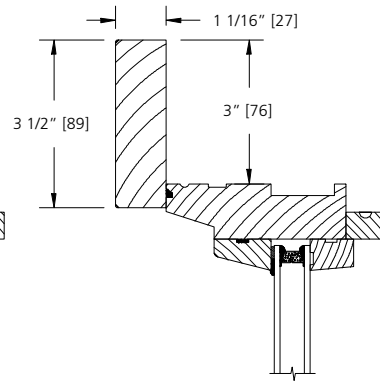

FLAT CASING

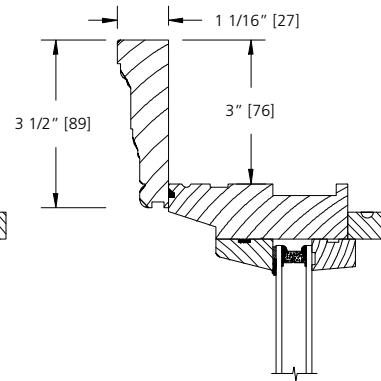

ADAMS CASING

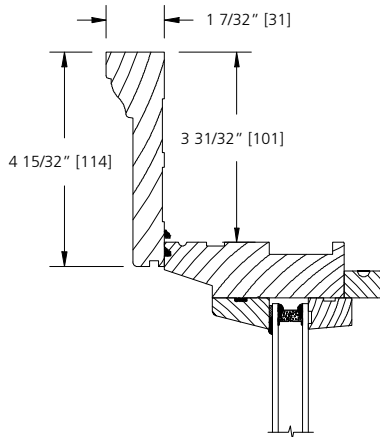

1 X 4 BACK BAND

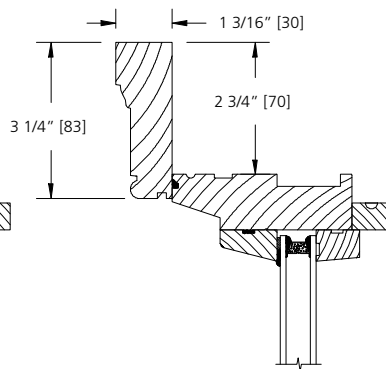

WILLIAMSBURG

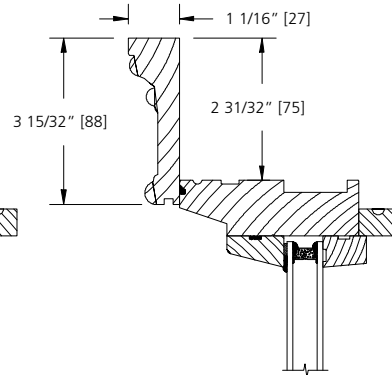

RG 3 CASING

WOOD SUBSILL OPTIONS

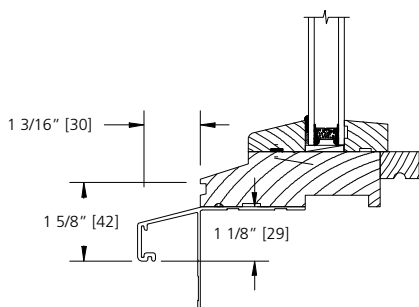

**OPTIONAL
(ALUMINUM)**

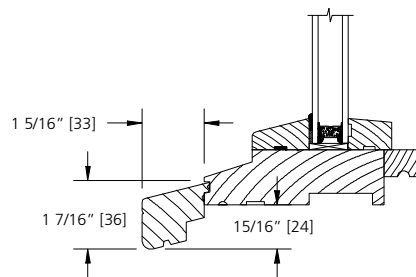

STANDARD

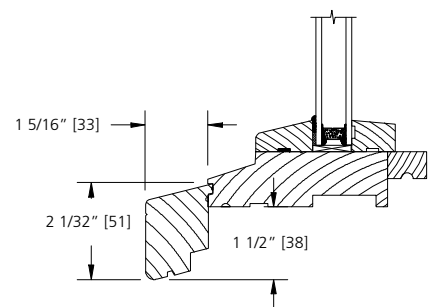

2" OPTION

SCALE: 3" = 1'

JAMB EXTENDER OPTIONS

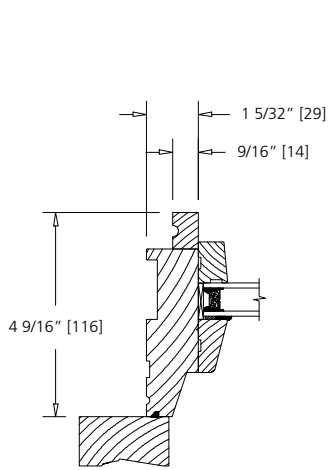

4 9/16" WALL

9/16" JAMB THICKNESS (OPTION)

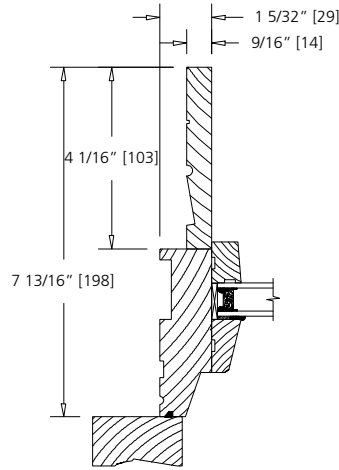

7 13/16" WALL

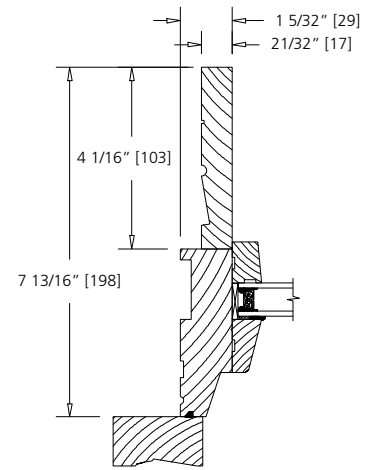

7 13/16" WALL

4/4 JAMB THICKNESS (STANDARD)

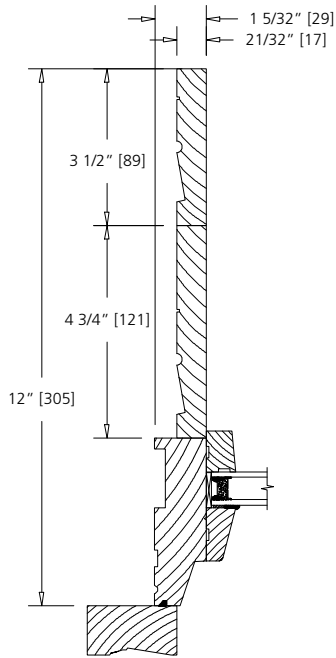

12" WALL

4/4 JAMB THICKNESS (STANDARD)
2 PC JAMB EXTENSION SHOWN

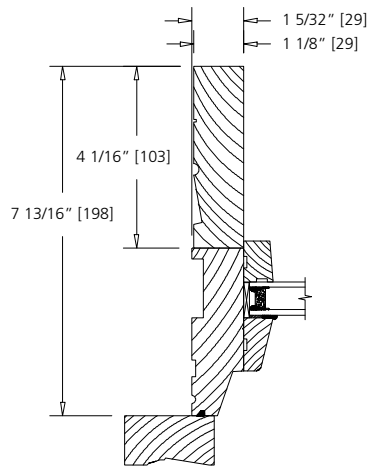

7 13/16" WALL

5/4 JAMB THICKNESS (OPTION)

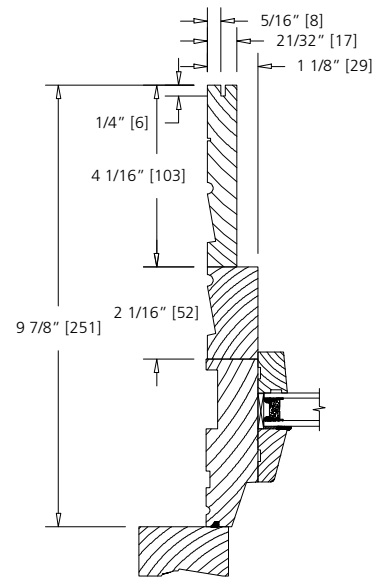

9 7/8" WALL

5/4-4/4 STACKED KERFED
JAMB OPTION

Notes:

Jamb Extension (9/16" thick) only available on jambs up to 6 9/16".
Jambs over 6 9/16" will only have a 4/4 or 5/4 option.
Jambs over 8 1/2" up to 12" will be 2 layers.
Kerfed Jamb Extension only available on 4/4 or 5/4 options.

SCALE: 3" = 1'

LITE CUT INFORMATION

Wood direct-set geometric windows are available in 7/8", 1-1/8" and 1-3/8" widths for SDL (Simulated Divided Lites); 5/8" Flat, 23/32" and 1" Contour GBG (Grilles between the Glass); and 7/8", 1-1/8" and 1-3/8" Full Surround removable grilles. Standard lite cuts are rectangular.

LITE CUT OPTIONS

Special lite cut patterns can include a wide variety of straight line and radius patterns. The illustrations shown here represent just a few of the possibilities. Rectangular, horizontal, vertical and Prairie lite patterns are available in all standard size wood direct set geometric windows. Uneven, diamond, radius and Gothic lite cuts are available, subject to approval. Approvals are based on the ability to fulfill the design requirement while maintaining the construction integrity of the finished product.

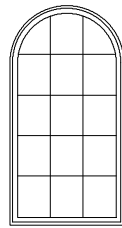

RECTANGULAR

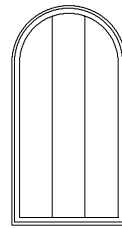

VERTICAL

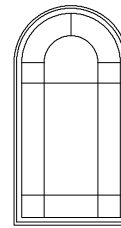

PRAIRIE

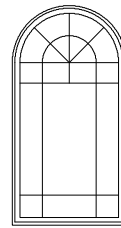

UNEVEN

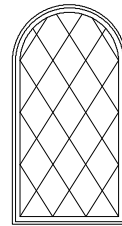

DIAMOND

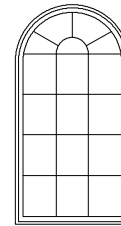

RADIUS

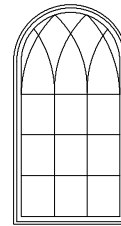

GOTHIC

BAR ALIGNMENT

Alignment of divided lite muntin bars from one window to the next is often required by fine architectural design. Wood grilles, GBG (Grilles between the Glass), and Simulated Divided Lites may be specified with muntin bars aligned.

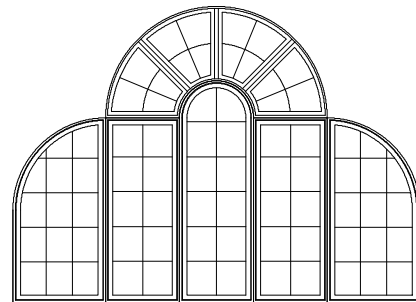

Continued on next page

LITE CUT INFORMATION

HALF ROUND LITE PATTERNS

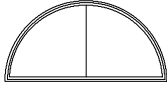

200 SERIES

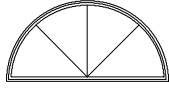

400 SERIES

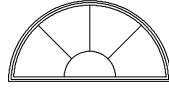

500 SERIES

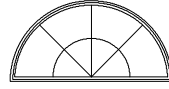

800 SERIES

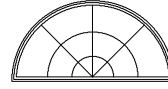

1200 SERIES

QUARTER ROUND LITE PATTERNS



200 SERIES



400 SERIES



600 SERIES

FULL ROUND LITE PATTERNS

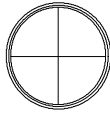

400 SERIES

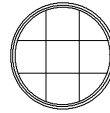

900 SERIES

OCTAGON LITE PATTERNS

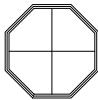

400 SERIES

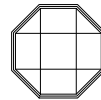

900 SERIES

LITE CUT INFORMATION

INVERTED RADIUS SILL NOTE:

Windows with inverted radius sills have continuous head and sill configurations. The twin, triple and quad units utilize a mullion post as part of a single unit. Single lines represent grille and thermal bar lite break ups. Twin, triple and quad units are single units with mullion posts being represented by several lines.

INVERTED HALF ROUND LITE PATTERNS

INVERTED HALF ROUND SILL



200 SERIES
RADIUS HUB

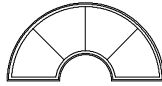

400 SERIES

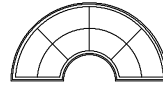

800 SERIES

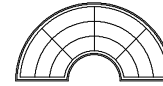

1200 SERIES

INVERTED HALF ROUND SILL - TWIN

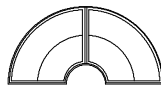

200 SERIES
RADIUS HUB

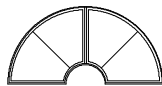

200 SERIES

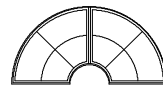

400 SERIES

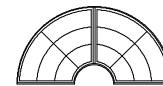

600 SERIES

INVERTED HALF ROUND SILL - TRIPLE

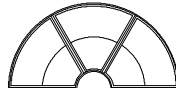

200 SERIES
RADIUS HUB

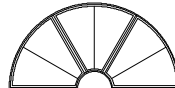

200 SERIES

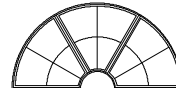

400 SERIES

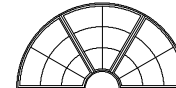

600 SERIES

INVERTED HALF ROUND SILL - QUAD

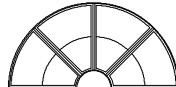

200 SERIES
RADIUS HUB

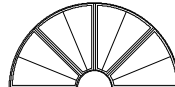

200 SERIES

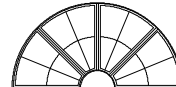

400 SERIES

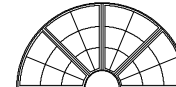

600 SERIES

INVERTED QUARTER ROUND LITE PATTERNS

INVERTED QUARTER ROUND SILL



200 SERIES
RADIUS HUB



200 SERIES



400 SERIES



600 SERIES

INVERTED QUARTER ROUND SILL - TWIN



200 SERIES
RADIUS HUB



200 SERIES



400 SERIES



600 SERIES

INVERTED QUARTER ROUND SILL - TRIPLE



200 SERIES
RADIUS HUB



200 SERIES



400 SERIES



600 SERIES

DIVIDED LITE OPTIONS

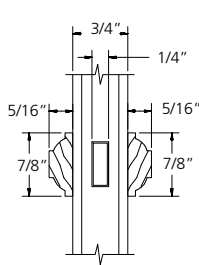

7/8" SDL

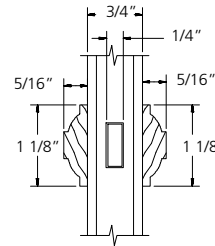

1 1/8" SDL

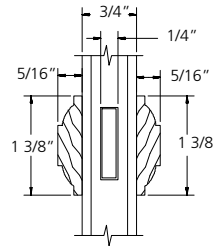

1 3/8" SDL

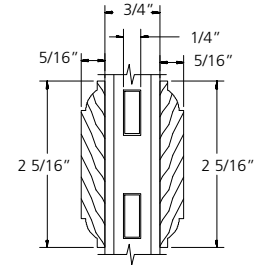

2 5/16" SDL

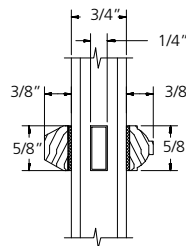

5/8" PUTTY/BEAD SDL

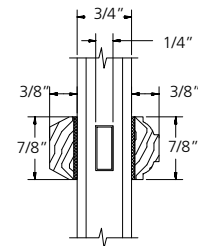

7/8" PUTTY/BEAD SDL

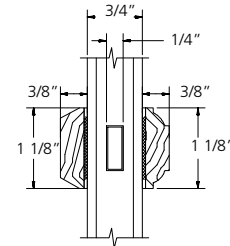

1 1/8" PUTTY/BEAD SDL

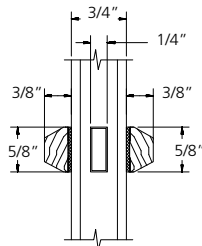

5/8" PUTTY/PUTTY SDL

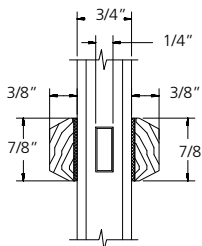

7/8" PUTTY/PUTTY SDL

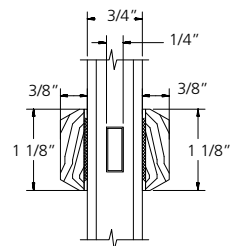

1 1/8" PUTTY/PUTTY SDL

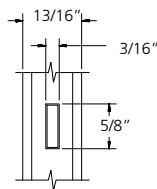

5/8" GRILLE

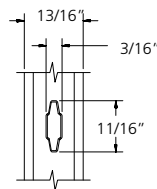

23/32" GRILLE

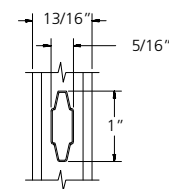

1" GRILLE

**GRILLES MEETING
NFRC 3mm RULE**

GRILLE PROFILES

3/16" X 5/8"	ALLMETAL 1021101018XX140
1/4" X 5/8"	ALLMETAL 1020102018XX140
1/4" X 1"	ALLMETAL 1020102018XX164
.325" X 5/8"	ALLMETAL 1020106018XX140
.325" x 1"	ALLMETAL 1020103018XX164
5.5mm X 18mm Contour	ALLMETAL 1020301010XX255
8mm X 25mm Contour	ALLMETAL 1020301018XX380

SCALE: NTS

STRAIGHT LINE SHAPES

ALL GEOMETRIC WINDOW SHAPES ARE VIEWED FROM THE EXTERIOR.

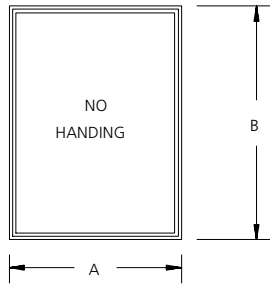

RECTANGLE

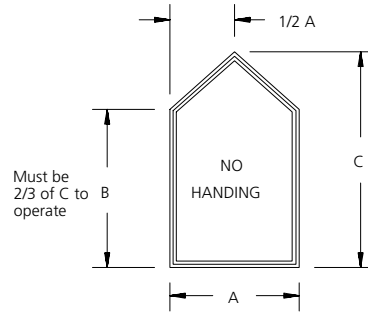

PENTOID

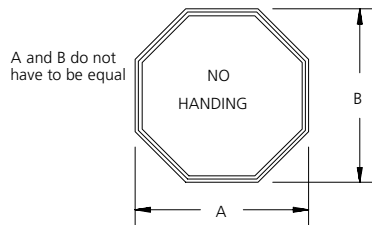

OCTAGON

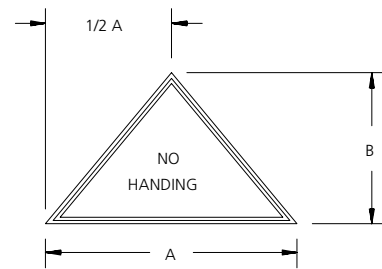

**TRIANGLE
(EQUILATERAL - ISOCELES)**

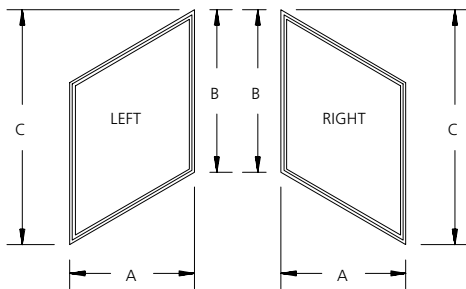

PARALLELOGRAM

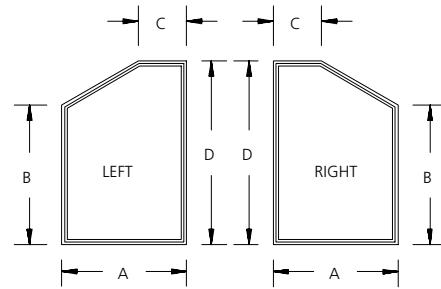

**PENTOID
(ASYMMETRICAL)**

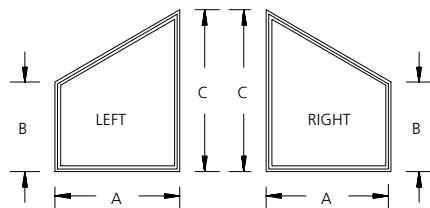

TRAPEZOID

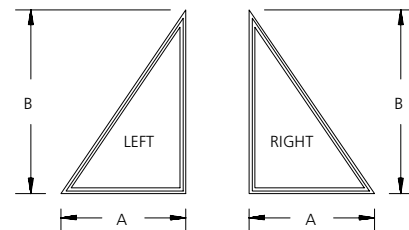

RIGHT TRIANGLE

SCALE: NTS

RADIUS SHAPES

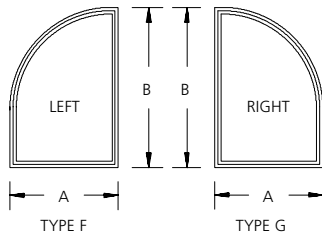

**EXTENDED
QUARTER ROUND**

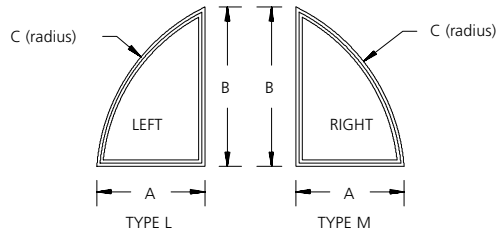

**HANDED
SECTOR**

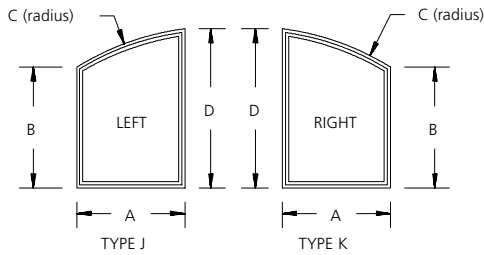

**EXTENDED - HANDED
SECTOR**

ALL GEOMETRIC WINDOW SHAPES ARE VIEWED FROM THE EXTERIOR.

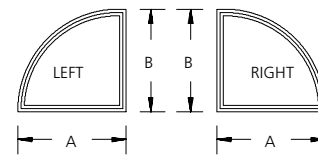

QUARTER ROUND

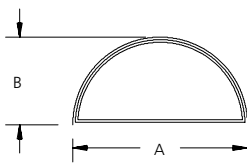

HALF ROUND

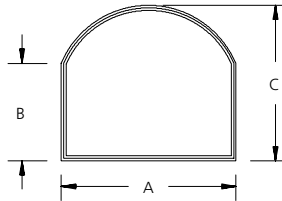

**EXTENDED
SECTOR**

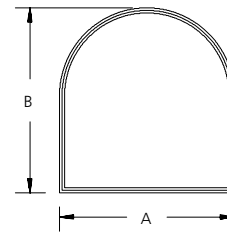

**EXTENDED
HALF ROUND**

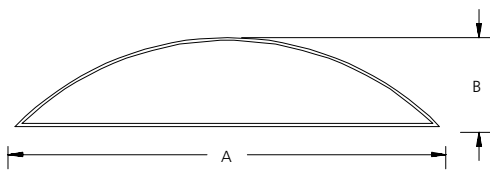

SECTOR

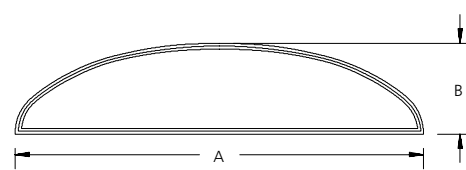

ELLIPSE

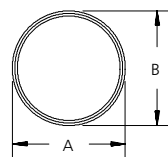

FULL ROUND

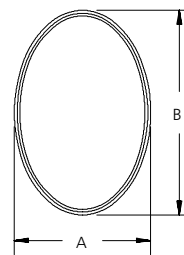

OVAL

Continued on next page

SCALE: NTS

RADIUS SHAPES

ALL GEOMETRIC WINDOW SHAPES ARE VIEWED FROM THE EXTERIOR.

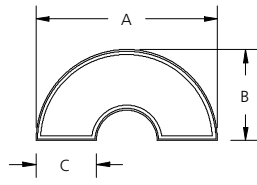

TYPE BI - 1
INVERTED HALF ROUND

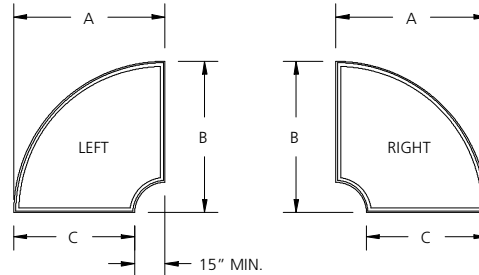

TYPE DI - 1 TYPE EI - 1
INVERTED QUARTER ROUND

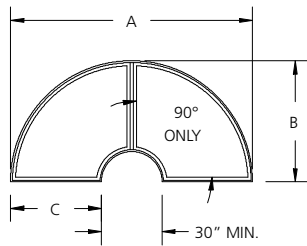

TYPE BI - 2
INVERTED HALF ROUND - TWIN

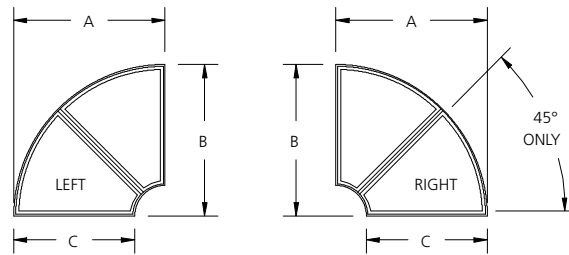

TYPE DI - 2 TYPE EI - 2
INVERTED QUARTER ROUND - TWIN

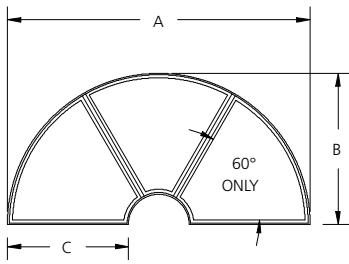

TYPE BI - 3
INVERTED HALF ROUND - TRIPLE

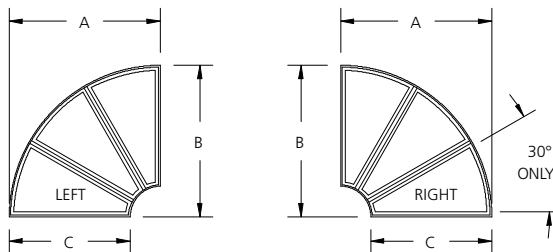

TYPE DI - 3 TYPE EI - 3
INVERTED QUARTER ROUND - TRIPLE

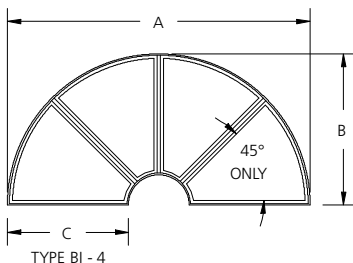

TYPE BI - 4
INVERTED HALF ROUND - QUAD

INVERTED HALF ROUND AND QUARTER ROUND UNITS

Inverted half round and quarter round units have continuous head and sill configurations which utilize mullion posts from frame to frame. See page 11-73 (Section Details & Dimensions) for mullion post specifications. The mullion posts are positioned radially from the center point of the sill radius.

SCALE: NTS

**UNIT SIZING, ROUGH OPENINGS
& MASONRY OPENINGS**

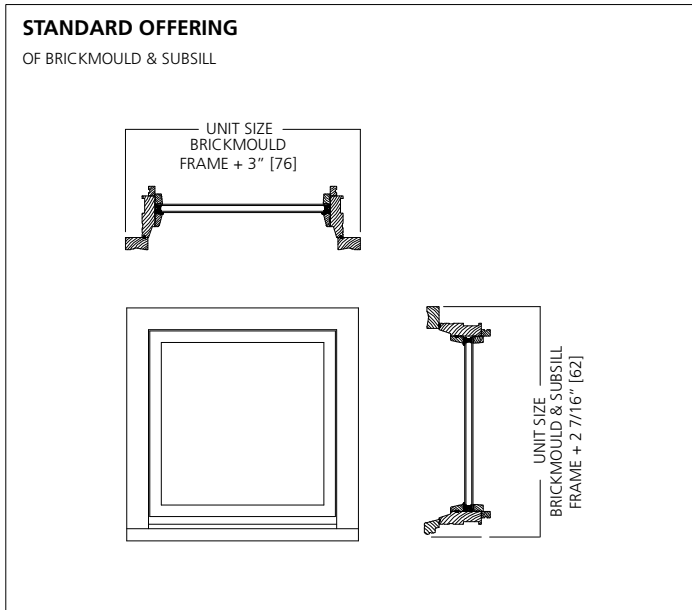

GENERAL NOTES:

UNITS WITH NO TRIM AND SUBSILL:
UNIT SIZE = FRAME SIZE

UNIT SIZE IS ALWAYS THE
EXTREME SIZE OF THE WINDOW
WITH OR WITHOUT TRIM

MASONRY OPENING:
MASONRY OPENING IS ALWAYS 1/2" OVER
THE UNIT SIZE OF THE WINDOW

ROUGH OPENING:

ROUGH OPENING IS ALWAYS 1/2" OVER
FRAME SIZE OF THE WINDOW

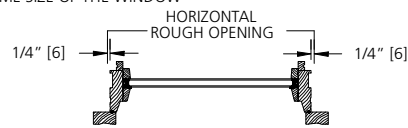

EXCEPTION: SEE DRAWING BELOW

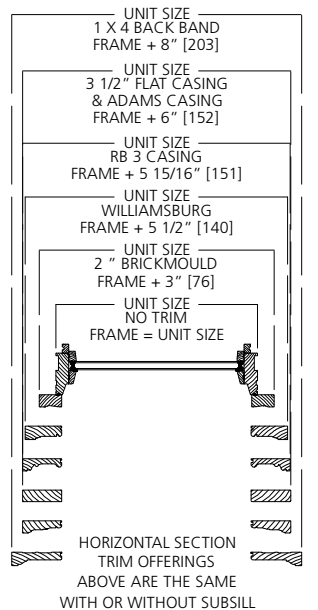
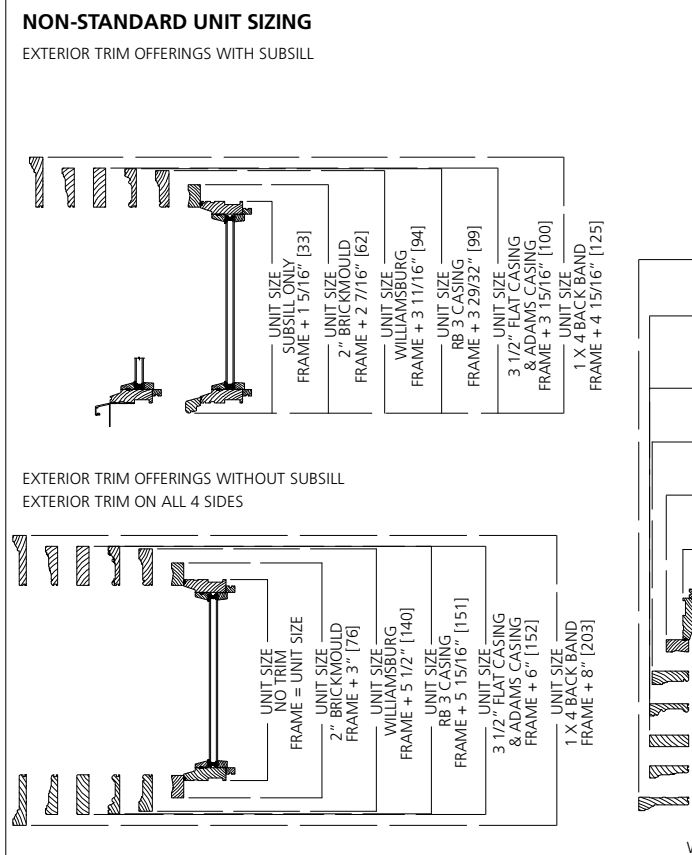
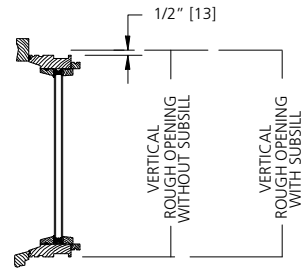

**FRAME TO TRIM
DIMENSIONS**

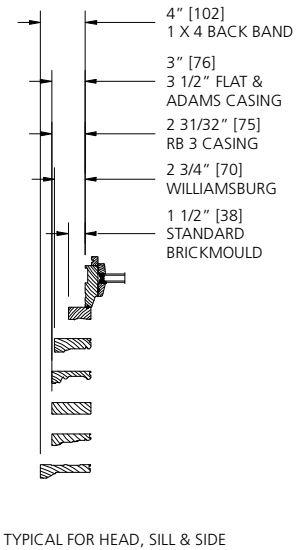

DIRECT-SET UNIT

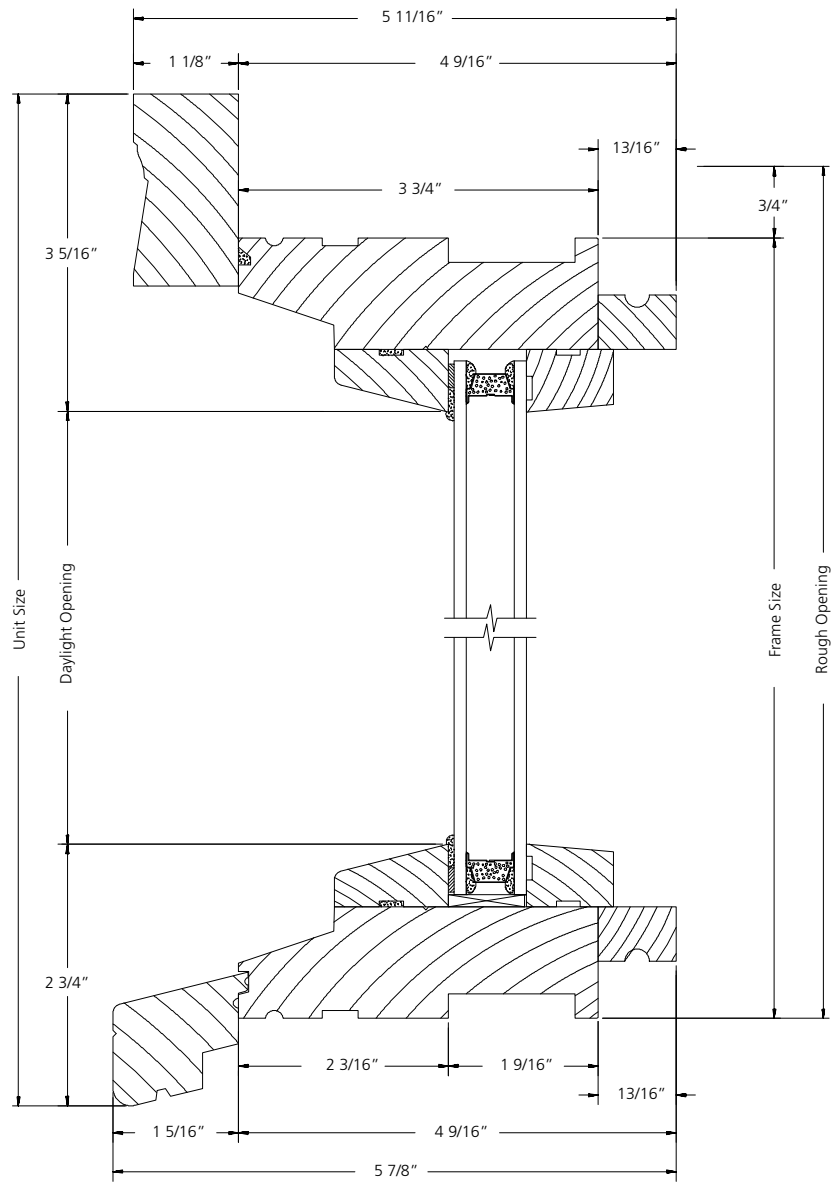

VERTICAL SECTION

SCALE: 6" = 1'

DIRECT-SET UNIT

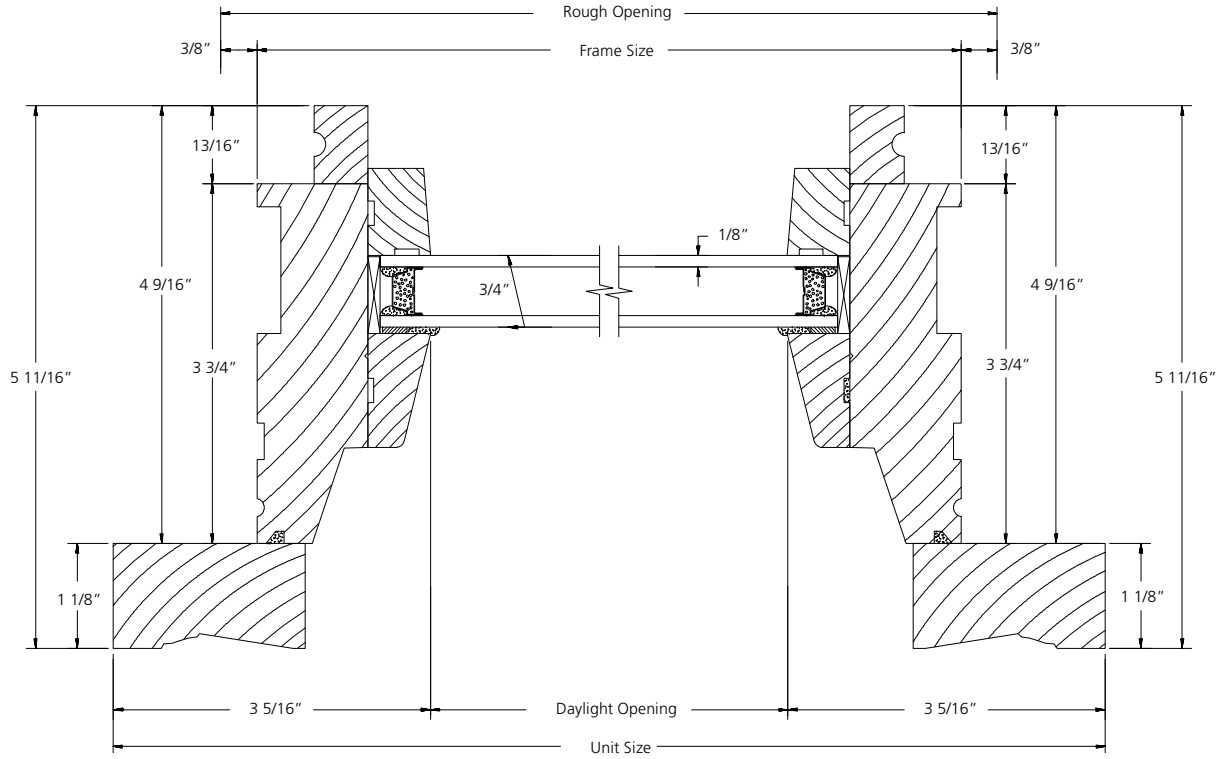

HORIZONTAL SECTION

SCALE: 6" = 1'

DIRECT-SET RADIUS UNIT

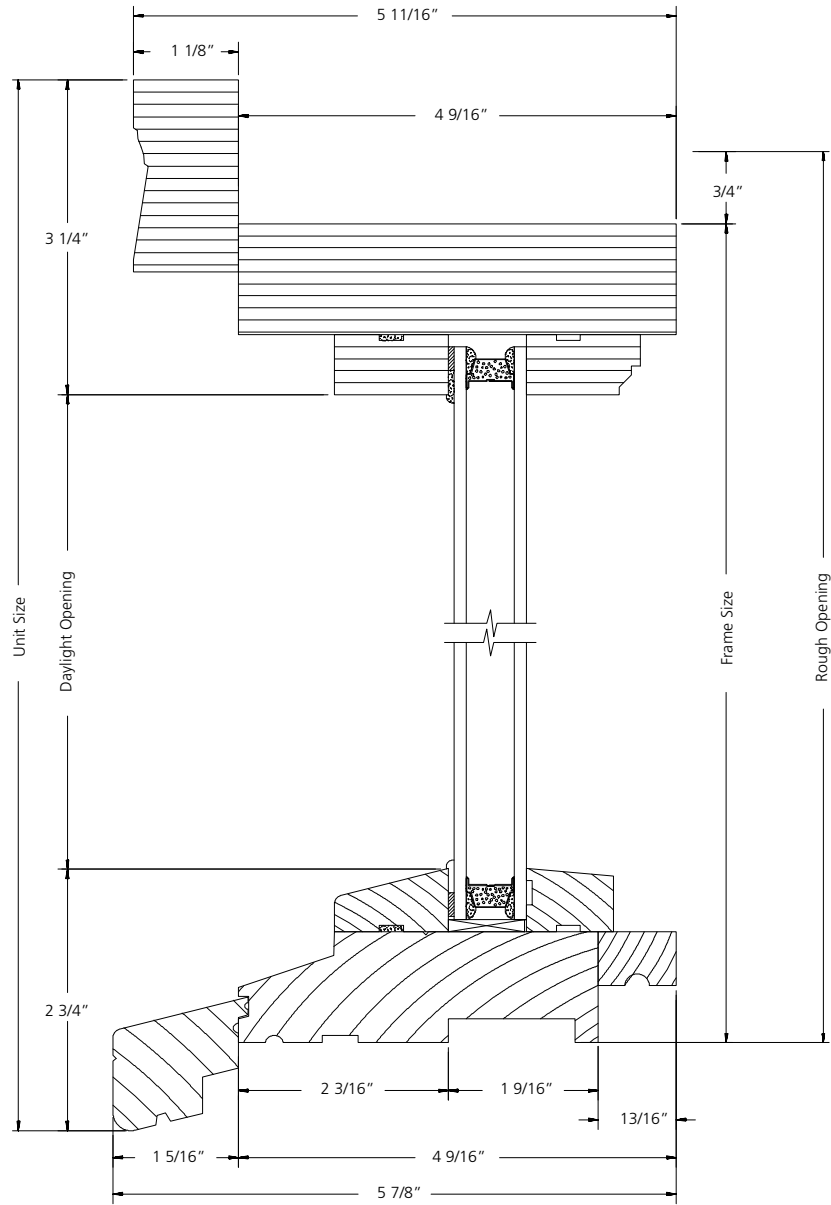

VERTICAL SECTION

SCALE: 6" = 1'

DIRECT-SET RADIUS UNIT

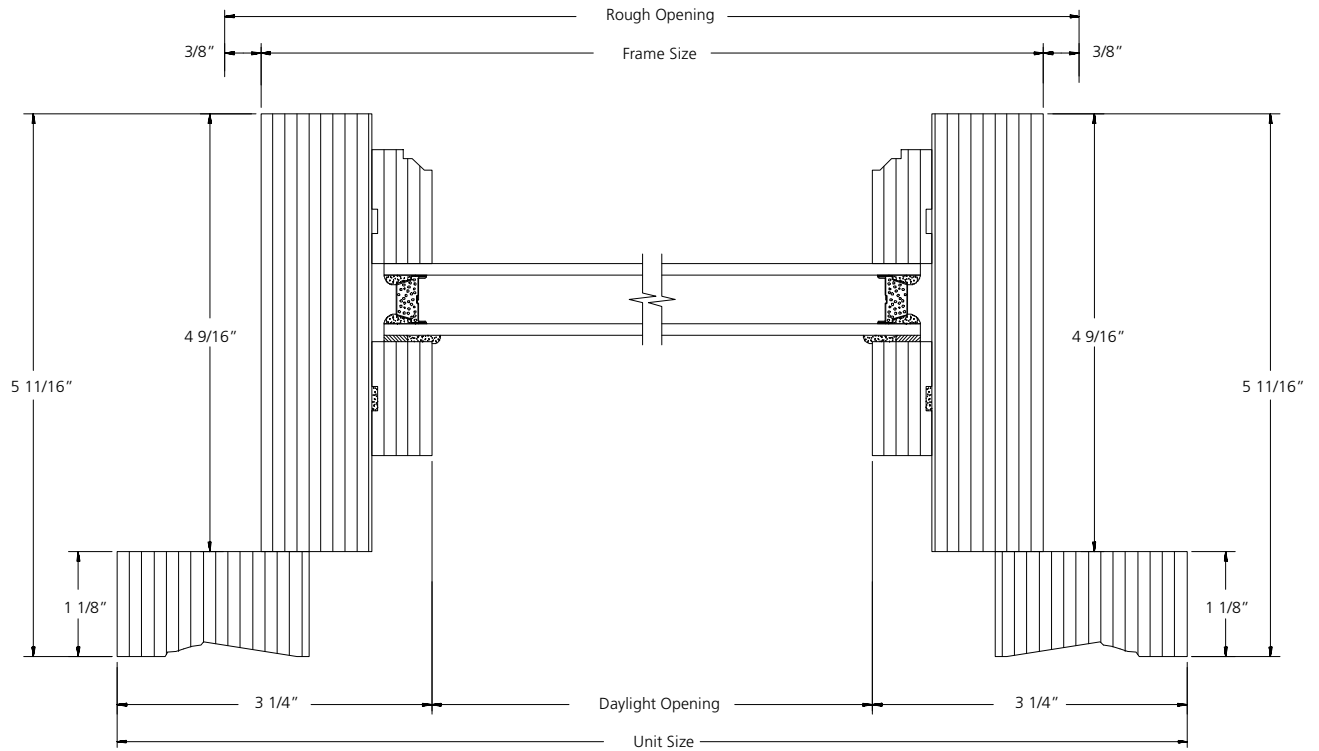

HORIZONTAL SECTION

SCALE: 6" = 1'