



Thank you for selecting JELD-WEN products. Attached are JELD-WEN's recommended installation instructions for Aluminum Clad Wood Windows with Nailing Fin or Primed Wood Windows with Exterior Trim. Not all window types may be installed into every wall condition in all areas. Consult your local building code official for applicable building codes and regulations. Local building code requirements supersede recommended installation instructions. Areas such as Florida and the Texas TDI region have different anchoring requirements based on product certification. For information on specific products, visit www.floridabuilding.org or www.tdi.texas.gov and follow the anchoring schedule given in the drawings for the product instead of the anchoring schedule in this document.

Newer construction methods have led to an increase in air and water tightness in buildings. This frequently leads to negative air pressure inside the home, which can draw water through very small openings. Our installation method integrates the window with the weather barrier of the structure (typically building wrap).

IMPORTANT INFORMATION, TABLE OF CONTENTS AND GLOSSARY

Please Note! These instructions do not apply to bow and bay windows and apply only to windows with a horizontal flat sill. Installations where the sill is higher than 35 feet above ground level, or any product installation into a wall condition not specifically addressed in these instructions must be designed by an architect or structural engineer. Failure to install windows into square, level and plumb openings could result in denial of warranty claims for operational or performance problems.

Note to Installer: Provide a copy of these instructions to the building owner. By installing this product, you acknowledge the terms and conditions of the limited product warranty as part of the terms of the sale.

Table of Contents

| | |
|--|-----|
| Rough Openings | 2 |
| Safety and Handling | 2 |
| Materials and Tools | 3 |
| Remove Packaging and Inspect Window | 3 |
| Inspect Rough Opening | 4 |
| Prepare Buck | 4 |
| Prepare Stud-Framed Wall | 5 |
| Prepare Window | 6 |
| Install Window | 6-8 |
| Flash Window - | |
| Windows with a Nail Fin Installed into Stud-Framing Only | 8 |
| Complete Installation | 9 |

Glossary

Applied Nailing Fin

A mechanically attached vinyl fin that creates a flange around the perimeter of the window and is used to attach the window to the rough opening. These products usually require fastening through the jambs.

Buck

A wood framework attached to the masonry inside a window or patio door rough opening.

Integral Nailing Fin

A fin that is part of the extruded aluminum cladding and used to attach the window to the rough opening.

Masonry Clip

A galvanized metal strap that secures the window to the structure.

Mulled Unit

Two or more window units structurally joined together.

Precast Sill

A pre-formed concrete block placed in the sill of a masonry/block wall to support a window.

Self-Adhered Flashing (SAF)

An adhesive backed tape material, generally not requiring mechanical fasteners, used to waterproof the rough opening and/or used to seal a window to the building's weather barrier. SAF should be applied in a manner that directs the moisture out of the wall cavity to the exterior.

Shi lap

The layering method in which each layer overlaps the layer below it so that water runs down the outside.



ROUGH OPENINGS

This installation guide specifically addresses masonry/block wall, sheathed wall and open-stud construction.

Masonry/Block Wall Construction

This installation assumes that a framework of studs (often called a buck) has already been properly fastened and sealed to the concrete/masonry wall by a building professional.

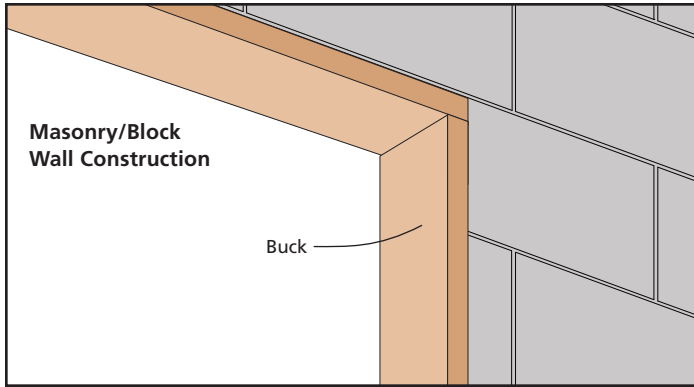

Fully Sheathed Wall Construction

The wall framing is covered by sheathing. Windows will be mounted flush against the sheathing. This installation assumes building wrap is properly installed prior to installation.

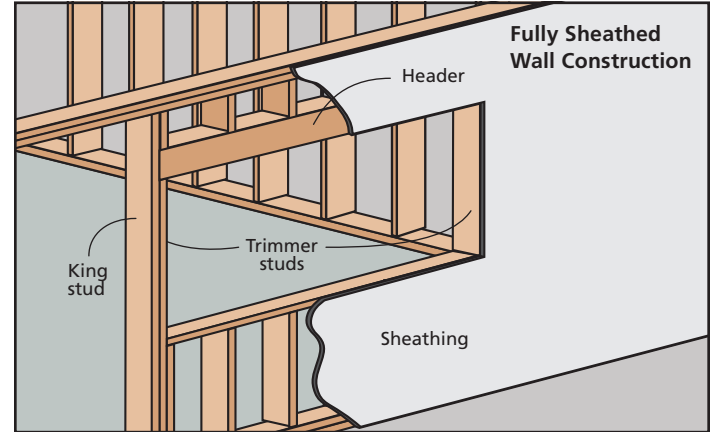

Open-Stud Construction

If self-adhered flashing is to be applied so that it is wider than the framing of the wall, it may be necessary to cover the wall with backing support sufficient to support the entire width of the flashing.

This backing support should be a non-water degradable, thin (max. 1/8" thick) sheet material such as fiber reinforced plastic, lauan or plywood. Completely surround the rough opening with the backing support. Backing support must be applied before building wrap.

The window will be mounted with the nailing fin flush against the applied backing support.

SAFETY AND HANDLING

Safety

- Read and fully understand ALL manufacturer's instructions before beginning. Failure to follow proper installation instructions may result in the denial of warranty claims for operational or performance problems.
- Do not work alone. Two or more people are required. Use safe lifting techniques.
- Use caution when handling glass. Broken or cracked glass can cause serious injury.
- Wear protective gear (e.g. safety glasses, gloves, ear protection, etc.).
- Operate hand/power tools safely and follow manufacturer's operating instructions.
- Use caution when working at elevated heights.
- If disturbing existing paint, take proper precautions if lead paint is suspected (commonly used before 1979). Your regional EPA (www.epa.gov/lead) or Consumer Product Safety Commission offices provide information regarding regulations and lead protection.
- **WARNING:** Drilling, sawing, sanding or machining wood products generates wood dust, a substance known to the State of California to cause cancer. Use a respirator or other safeguards to avoid inhaling wood dust.

Materials and Window Handling

- Make sure operable windows are locked prior to installation.
- Heed material manufacturer's handling and application instructions.
- Protect adhesive surfaces from dirt, moisture, direct sunlight and folding over onto themselves.
- Handle in vertical position; do not carry flat or drag on floor.
- Do not put stress on joints, corners or frames.
- Store window in dry, well-ventilated area in vertical, leaning position to allow air circulation; do not stack horizontally.
- Protect from exposure to direct sunlight during storage.
- Install only into vertical walls and when conditions and sheathing are dry.

**IF INJURY OCCURS,
IMMEDIATELY SEEK MEDICAL ATTENTION!**

MATERIALS AND TOOLS

Needed Materials

Note! JELD-WEN exterior window and door products should be installed in accordance with JELD-WEN's recommended installation and flashing directions, which are shipped with the products or can be found on our website: www.jeld-wen.com. Note that alternative installation methods and flashing systems may be utilized at the installer's or owner's discretion and, in such situations the installation should be done in accordance with the flashing manufacturer's instructions. Follow all material manufacturer's instructions for proper use and compatibility. When using flashing, spray adhesive/primer, sealant and foam products, we recommend using the same manufacturer and verifying compatibility. It is the End User's responsibility to determine if dissimilar materials are compatible to the substrates in the application.

Note: On Siteline Impact casement and awning windows, fasten through the provided clip and nail fin with (1) #8 x 1-1/2" screw that penetrates into the structural member.

- 1-3/4" galvanized roofing nails (nailing fin windows). Nails must penetrate at least 1-1/4" into framing (or as required by local code).
- #8 x 1-1/2" corrosion-resistant, pan head screws. Screws must penetrate at least 1" into framing (or as required by local code).
- Galvanized drip cap (or factory supplied).
- Sealant: We recommend OSI® QUAD® Max Sealant or equivalent. This can be used in any application and can be painted or ordered in a color matched product, if desired.
- Backer rod 1/8" larger than the widest portion of the gap (used in conjunction with sealant bead).
- Polyurethane low expansion Window and Door foam: We recommend OSI® QUAD® Foam or equivalent.
- Non-compressible or non-water degradable shims.

For mulled units on the sill:

- Masonry clips.
- #8 x 1/2" screws for fastening masonry clips to the window.
- #8 screws for attaching masonry clips to structure. Screws must penetrate at least 1" into framing.

For installations into a stud-framed wall:

- 4", 6", or 9" (as required by local code and window configuration) wide self-adhered flashing: We recommend OSI® Butyl Flash Tape or equivalent.
- Spray adhesive/primer for self-adhered flashing. Such as Loctite® 300 or equivalent. Follow manufacturer's instructions for application methods.

For installations into a buck:

- Liquid applied flashing (Protecto Wrap LWM 200 or equivalent).

Needed Tools

- Utility knife
- J-roller
- Hammer
- Tape measure
- Caulking gun
- Level (4' minimum recommended)
- Drill with 1/8" tapered bit and 3/8" countersink
- Screwdrivers
- Finish hammer or pneumatic finish nail gun
- Carpenter's glue
- Pencil
- Nail set
- Miter saw

1

REMOVE PACKAGING AND INSPECT WINDOW

Remove Packaging

Remove shipping materials such as corner covers, shipping blocks or pads. If there is a protective film on the glass, do not remove it until installation and construction are complete. Cut off any staple legs exposed on the side of the frame.

Note! Double-hung windows may have banding on the interior of the unit. Do not remove until the window is secured in the opening to help keep the sash in place and the unit square.

Inspect Window

- Cosmetic damage.
- Product squareness (diagonal measurements not more than 1/4" different).
- Correct product (size, color, grid pattern, handing, glazing, energy-efficiency requirements, etc.).
- Drip cap that extends the length of the exterior trim plus 1/8" overhang on each end (all units require a drip cap); drip cap may or may not be pre-installed.
- Splits, cracks, holes, missing sections or other damage to the nailing fin longer than 6" and/or within 1/2" of window frame.
- If any of the above conditions represent a concern, or if you expect environmental conditions to exceed the window's performance rating, do not install the window. Contact your dealer or distributor for recommendations.

2 INSPECT ROUGH OPENING

- Verify the width and height of the window are each 1/2"-5/8" smaller than the rough opening width and height. Mulled units should be 3/4" narrower.
- Verify the rough opening is square. The (A) and (B) measurements should be the same. Maximum allowable deviation from square is 1/8" for windows 20 sq. ft. and smaller, and 1/4" for windows larger than 20 sq. ft.

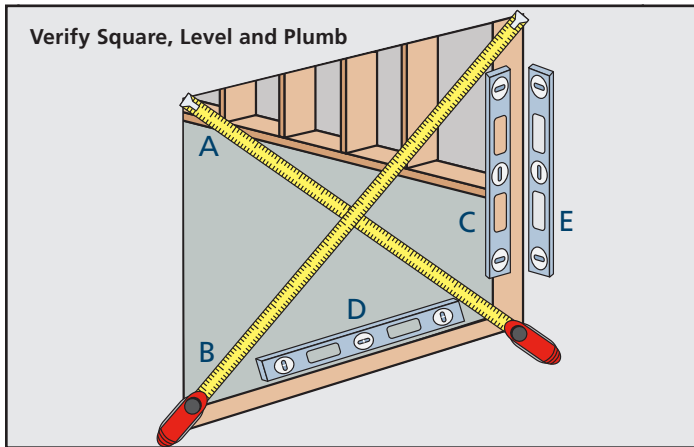

- Verify the rough opening is plumb and level (C, E and D). The maximum allowable deviation is 1/16" for every 2' of rough opening (not to exceed 1/8").
- The rough opening sill must not be crowned or sagged (D), but rather level or sloped (positive slope) to the exterior.
- The exterior face of the rough opening must be in a single plane (E) with less than 1/8" twist from corner to corner.
- Minimum double studs (king and jack/trimmer) should be used to support the header at all rough openings.

For Retrofit Installations

After removing the old window, remove sufficient cladding (siding, stucco, etc.) to expose enough intact building wrap to properly seal the window to the opening. If damaged, apply new building wrap in shiplap manner. Verify the rough opening framing is structurally sound. Contact your local waste management entities for proper disposal or recycling of products being removed.

3 PREPARE BUCK

Note! This section applies to installations into a masonry wall only. For installations into a stud-framed wall, begin with **section 4, "PREPARE STUD-FRAMED WALL."**

1. Seal any joint larger than 1/16" in the buck and between the buck and the concrete/masonry with sealant.

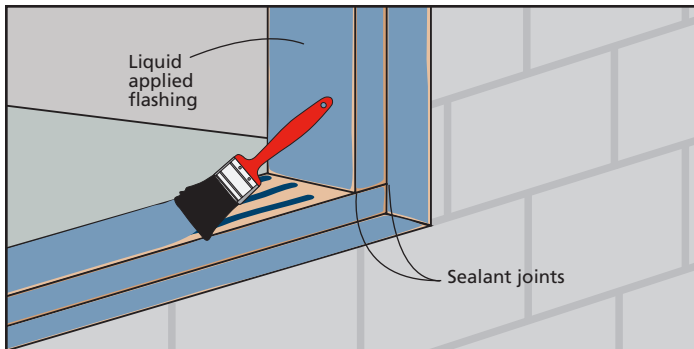

2. Cover the buck and the surrounding concrete/masonry at the head and jambs with liquid applied flashing as shown.
3. If installing into a four-sided buck, seal the sill in a similar manner.

Note! Where the window will sit on the sill, shim to provide continuous-support to the sill. This shimming must be a minimum of the width of the window frame and a minimum of 1/4" narrower than the depth of the window frame sill, should level the rough opening sill and be no more than 1/4" thick.

4. Align the shimming on the sill flush with the exterior and centered between the side jambs. If installing a mulled unit, shim under the mull joint(s) and tack into place or secure with sealant. **SKIP to section 5, "PREPARE WINDOW."**

4 PREPARE STUD-FRAMED WALL

Prepare Building Wrap

Note! Check with the building wrap manufacturer to verify the following steps will not void their product warranty.

1. Trim building wrap flush with the rough opening.
2. At the head, cut building wrap at 45° and tape up as shown.
3. Trim the sides sufficiently to allow the nailing fin to be mounted against the sheathing.

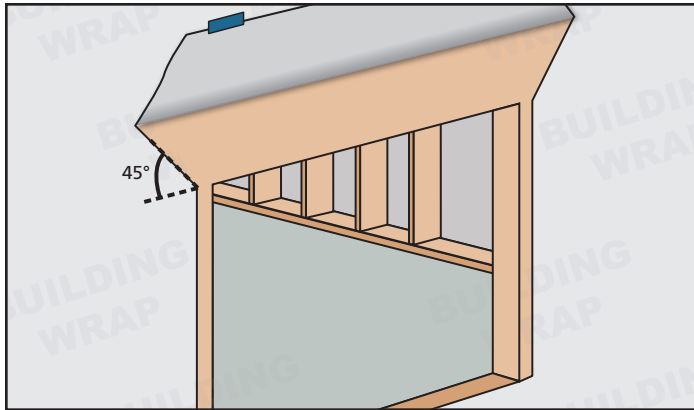

Prepare/Shim the Sill

1. Use self-adhered flashing to waterproof the sill.
2. Flashing must have at least 2" of visible material below nail fin. Flashing width must be at least measurement A + B + 1-3/4" (**Fig. A**).
3. Measure the width of the frame from the interior to the nail fin/trim (measurement A) and subtract 1/4". Transfer this measurement from the outside edge of the rough opening sill and draw a line all along the rough opening sill. This is where the back of the flashing will sit (**Fig. B**).
4. Cut a piece of flashing the length of the sill plus 12" (**Fig. B**).

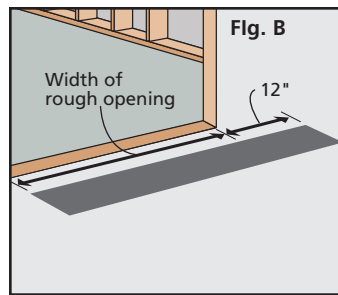
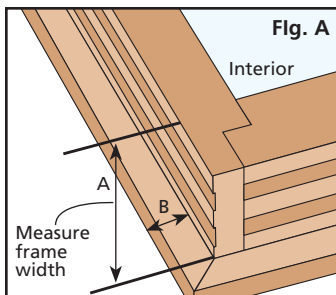

5. Place flashing on rough opening sill, wrapping the flashing up 6" on each jamb as shown.
6. Pull release tape and set flashing into place.
7. Fold the flashing down onto the wall. Mechanically fasten if necessary.

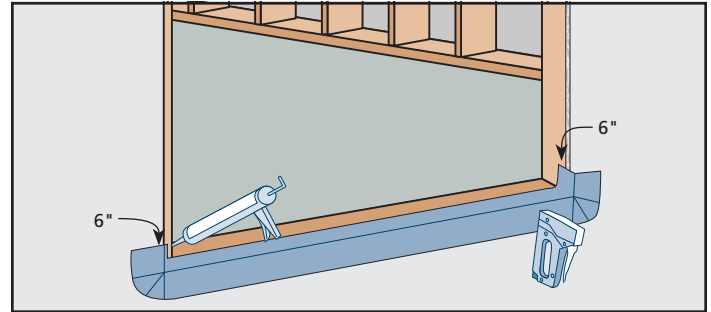

8. Smooth out any bubbles or creases with a J-roller. Remove and replace if necessary.
9. Install the continuous support as follows:

Note! Where the window will sit on the sill, shim to provide continuous support to the sill. This shimming must be a minimum of the width of the window frame and a minimum of 1/4" narrower than the depth of the window frame sill, should level the rough opening sill and be no more than 1/4" thick.

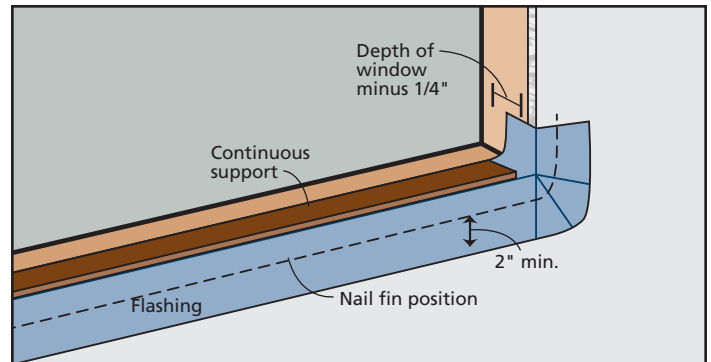

10. Align the shimming on the sill flush with the exterior and centered between the side jambs. If installing a mullied unit, shim under the mull joint(s) and tack into place or secure with sealant.

5 PREPARE WINDOW

Separately Supplied Drip Cap

This step applies to nail fin units only, windows with exterior trim will install drip cap in **section 6, "INSTALL WINDOW."**

Lay a 1/4" bead of sealant across the header as shown, and tap the drip cap into the groove with a wood block.

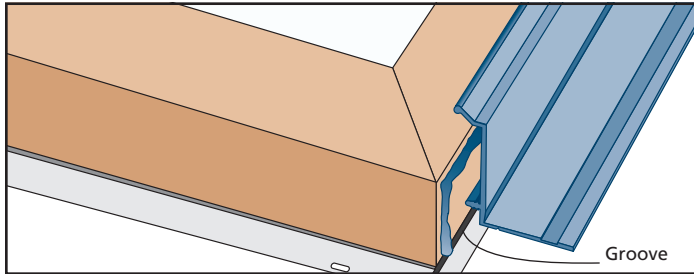

Seal Window

- For units with exterior trim: inspect the bead of sealant around the interior of the window where the trim meets the window frame. Add more sealant as necessary to ensure a water tight seam.

6 INSTALL WINDOW

WARNING! To avoid injury, use at least two people to install. Adequately support the window until completely fastened. Areas such as Florida and the Texas TDI region have different anchoring requirements based on product certification. For information on specific products, visit www.floridabuilding.org or www.tdi.texas.gov and follow the anchoring schedule given in the drawings for the product instead of the anchoring schedule in this document.

Note! Fastener (anchor) heads must be flush. Do not dent nailing fin.

1. Run a continuous 3/8" bead of sealant around the interior side of the nail fin/trim on the side jambs and head. On the sill, leave at least a 2" gap every 8" where it will contact the rough opening (**Fig. A**).
2. Place window onto the shimming support and tilt into the rough opening. The window sill must rest on and be fully supported by the shimming support.
3. Fasten window through the nailing fin/trim between 3"-7" from one upper corner (**Fig. B**).

4. Shim at each interlock, or in the center, and within 4"-6" of each corner on the side and head jambs. Apply additional shims to the side and head jambs as necessary to ensure window position within the opening is plumb, level and square. Larger windows usually need additional shims. Shims can be secured with sealant or adhesive.
5. Inspect window for square, level and plumb. Test for proper operation (remove and reinstall if necessary).

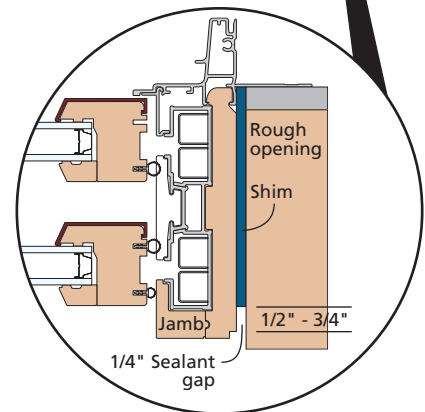
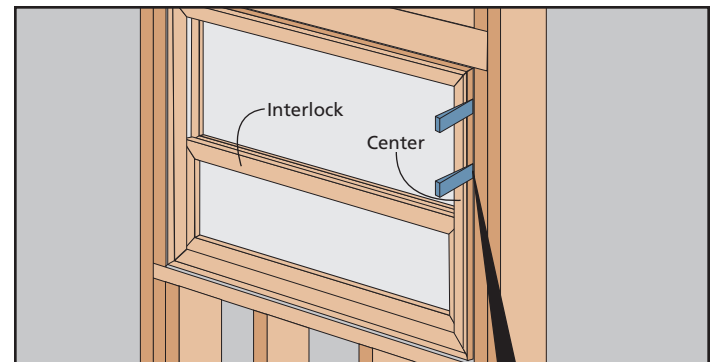
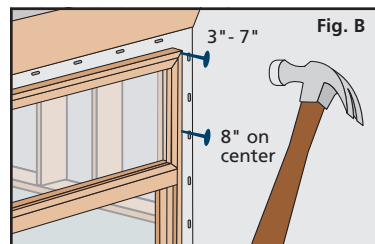
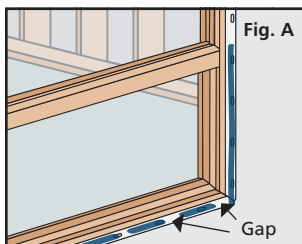

6 INSTALL WINDOW CONTINUED

Secure Window

1. Fasten window through the exterior trim/fin 4" from the corners and 8" apart all the way around the window.

For units with applied clad trim that covers the fin:

2. From the interior, fasten the window through the jambs as follows:
 - Mark fastener locations 4" from the corners and 14" apart all the way around the window.
 - At each marked location, drill a pilot hole through the side jamb and into the framing. Countersink for wood putty or for plug covers.
 - Apply sealant to the threads of a #8 x 3" screw and drive through the side jamb into the framing.

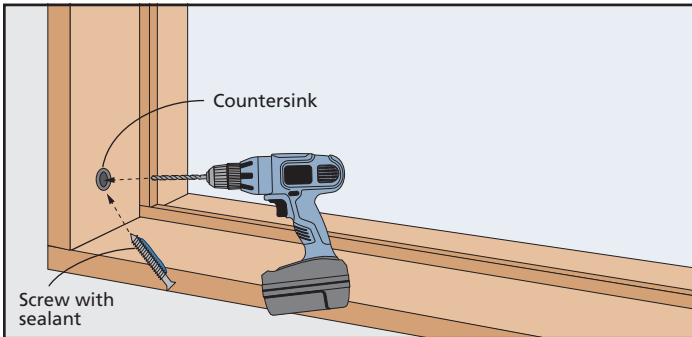

3. If applicable, install #8 screw through each masonry clip and into the framing. Screws must be long enough to penetrate framing by at least 1".
4. Hung windows must be fastened through the jamb adjusters with #8 x 2" screws provided. Straighten the jambs per the instructions provided with the screws.

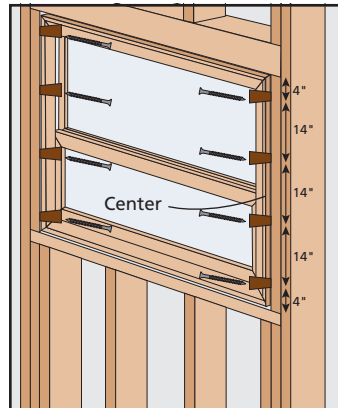
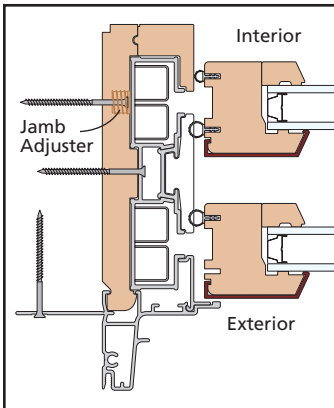

Interior Trim on Primed/Siteline Single/Double-Hung Windows

Warning: This product has a jamb liner cover that cannot be nailed through. Pay close attention to where you nail the interior jamb leg trim. If you cover the jamb liner cover with trim, you will have to remove the trim to replace the jamb liner.

How to install interior trim/casing:

1. Mark a reveal line around the jamb; this is typically 1/8" to 1/4" around the frame (make sure not to nail into the jamb liner cover). Use a straight edge or square, to mark the line around the perimeter of the head, jambs and sill. To insure you do not nail through the jamb liner, measure from the outside edge of the frame to the edge of the jamb liner cover, this should be approximately 1/2". Place intended fastener in the center of the 1/2" space for a clad wood window (Fig. A and B). On an all wood window this measurement should be 5/8" from the outside edge of the frame. Place intended fastener in the center of the 5/8" space (Fig. C).
2. Cut the trim/casing with a 45 degree miter (measurements should be taken at the intersecting lines that are marked on the window frame). Start with the head cut, proceed to the sill cut, temporarily install both of these pieces.
3. Cut each jamb piece to fit in between the head and sill. Once you have all pieces cut, work them together for a perfect fit.

Note: There are other installation types for installing trim/casing. Consult a professional if your installation types differ from the above method.

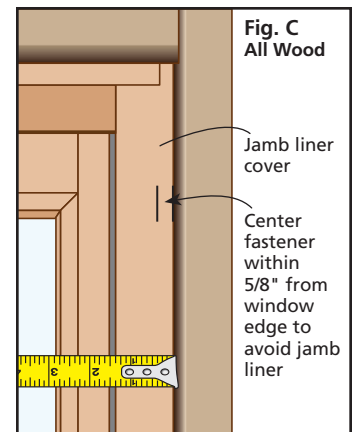
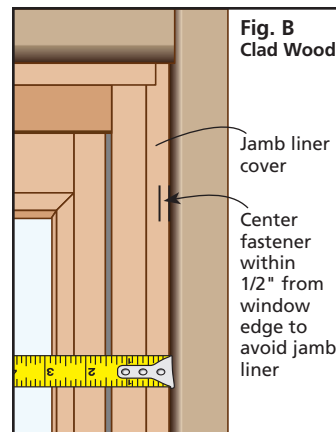
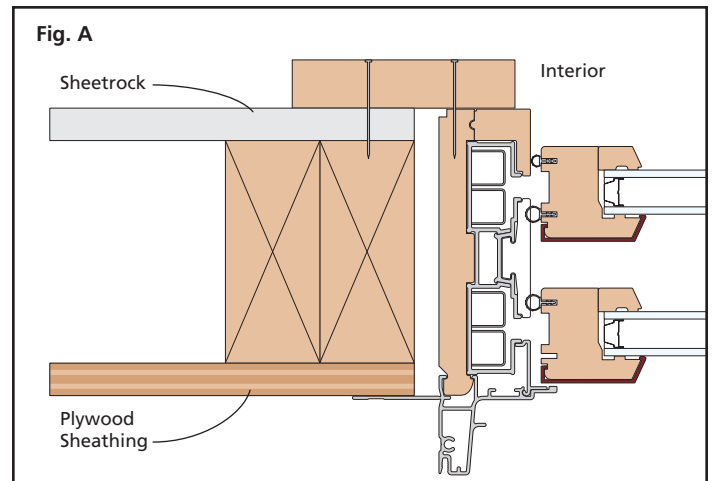

6 INSTALL WINDOW CONTINUED

Apply Drip Cap to Windows with Exterior Trim

1. Cut a piece of drip cap the length of the header trim + 1/4" to allow for 1/8" overlap past the ends of the trim.
2. Apply 1/4" bead of sealant to header trim as shown.
3. Center the drip cap on the trim and nail in place as shown.
4. Apply sealant underneath the drip cap where it meets both ends of the trim.
5. Fasten the drip cap through the upturned leg as shown.

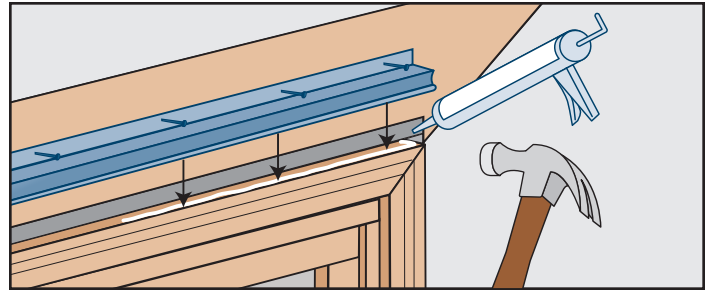

7 FLASH WINDOW - WINDOWS WITH A NAIL FIN INSTALLED INTO STUD-FRAMING ONLY

Cut pieces of self-adhered flashing as follows:

| MIN. SIZES OR OTHER SPECIFIED | PG50 or below (4" flashing) | Above PG50 (6" flashing) |
|-------------------------------|-----------------------------|----------------------------|
| One header piece | 10" longer than the header | 14" longer than the header |
| Two side pieces | 8" longer than the jamb | 12" longer than the jamb |

Spray Adhesive/Primer

Spray adhesive/primer may be required in certain situations, refer to manufacturer's instructions for appropriate applications. Protect window from overspray and apply spray adhesive according to instructions on the product to nailing fin and building wrap around the window as shown.

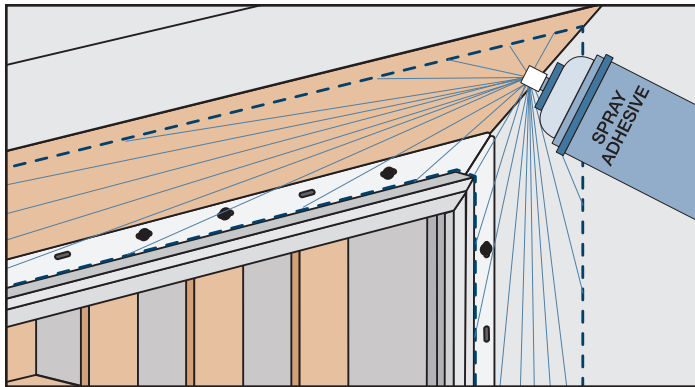

Apply the Self-Adhered Flashing

Note! Keep the edge of the self-adhered flashing as close to the window frame as possible and apply over the nail fin.

Note! The following dimensions are based on 4" wide tape, adjust accordingly for wider tape.

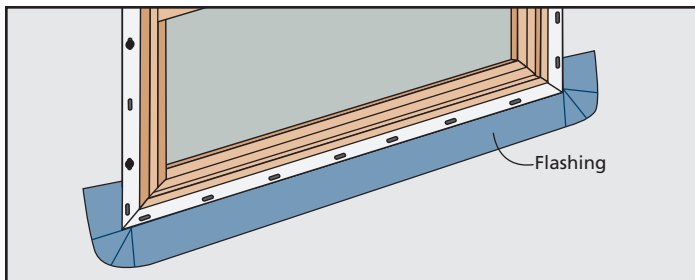

1. Apply the side pieces starting 3" above the header and overlap the flashing on the sill as shown.
2. Install drip cap if required. Pre-drill through the nailing fin if required.

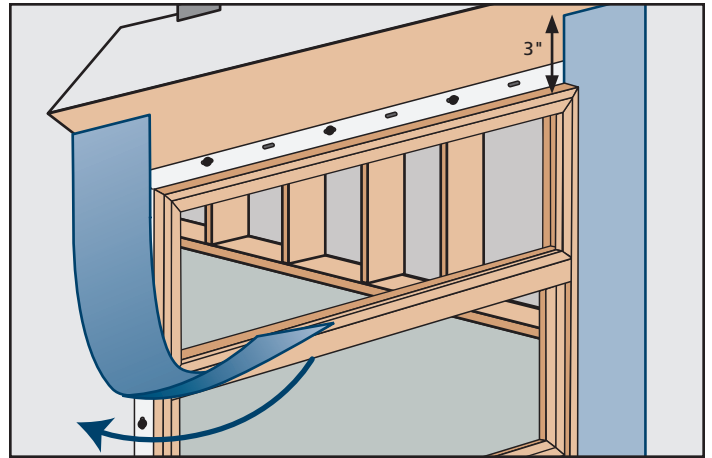

3. Center and apply the header piece above the header, overlapping the side pieces as shown.
4. Press the flashing down with a J-roller, being careful to remove any gaps or bubbles beneath self-adhered flashing (remove and replace if necessary).

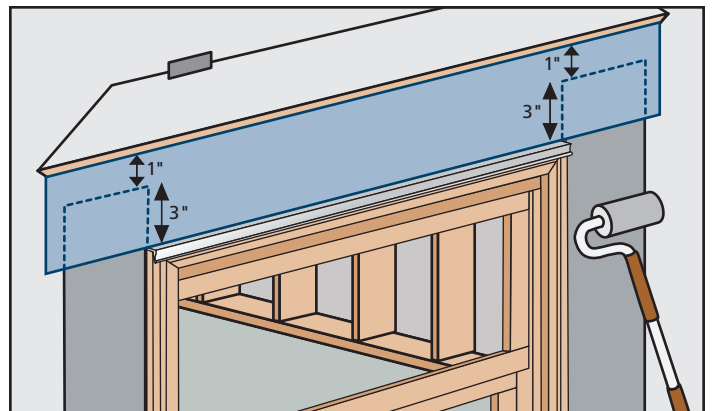

8

COMPLETE INSTALLATION

1. Release the building wrap from above the header (previously taped up) and overlap the header flashing. Seal the ends with self-adhered flashing or building wrap tape.
2. Seal all four corners of the window with a 3/8" bead of sealant. Tool into a fillet shape.
3. Seal any gaps or openings at end of horizontal mull joints with sealant.

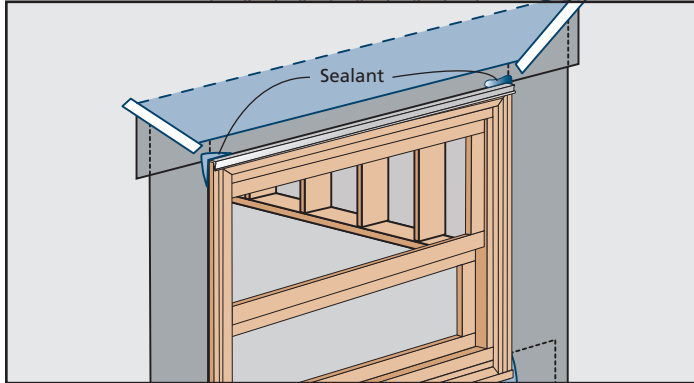

After Installation

- Install exterior wall surface per manufacturer's guidelines.
- Leave an expansion/contraction gap of approximately 3/8" between window frame and final exterior wall surface (siding, stucco, etc.). For a finished look and additional protection, seal this gap on the sides with backer rod and sealant. If sealant is applied above the drip cap ensure the sealant bead is discontinuous to allow for drainage.
- Remove protective film from cladding (if present) immediately after installation; remove from glass within one year.
- Protect recently installed units from damage from plaster, paint, etc. by covering the unit with plastic.
- Finish all exposed wood surfaces immediately following installation.

Continuous Air Seal

Create a continuous air seal on the interior by integrating the rough opening and the window frame with low expansion polyurethane foam or backer rod and sealant.

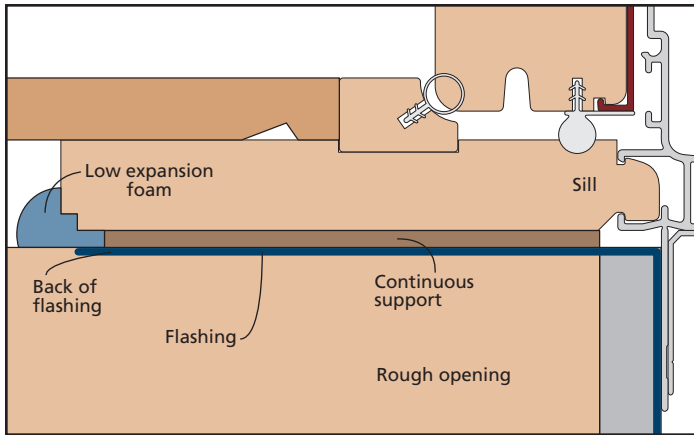

Please visit jeld-wen.com for warranty and care and maintenance information.

Thank you for choosing

