

Contours All-Panel Door Sections

Table of Contents

CT-20 2-Panel Arch Top	2
CT-22 2-Panel Square Top	3
CT-24 2-Panel V-Groove Arch Top	4
CT-30 3-Panel	5
CT-40BT 4-Panel Blank Top	6
CT-60 6-Panel	7
CT-80 8-Panel Center Arch	8
CT-90 9-Panel	9
CT8-60 8ft. 6-Panel	10

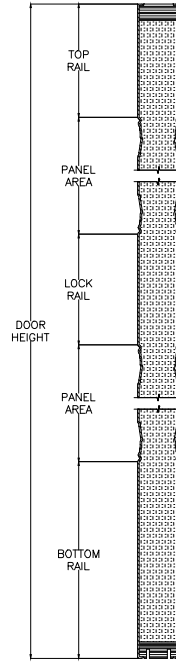
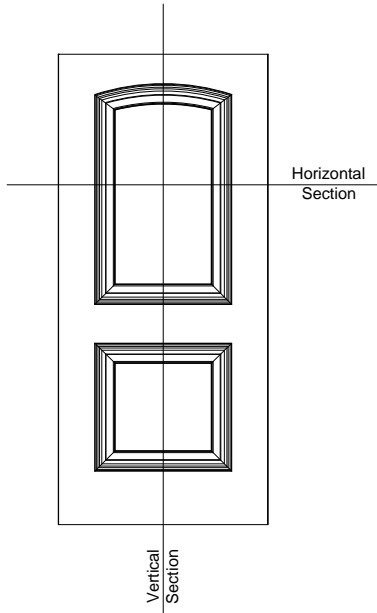

VERTICAL CROSS SECTION

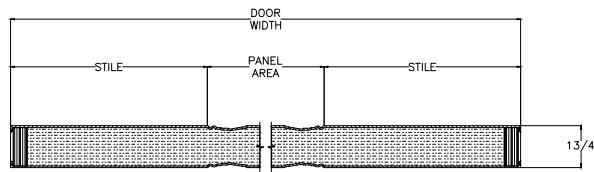

PANEL HORIZONTAL CROSS SECTION

Elevation Notes: • Door Size = Book Size Before Prefit • Daylight Opening (DLO) = Visible Glass. • Moulding Profile = n/a • Panel Profile = JW2
• Values in brackets [] are in millimeters • Wood grain = n/a

Scale: 1/4" = NTS

JELD-WEN reserves the right to change specifications without notice.

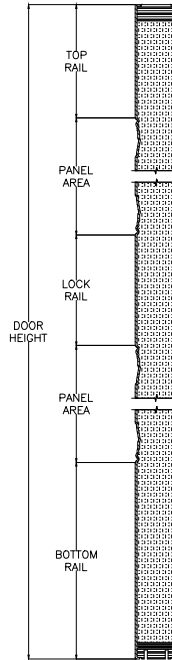
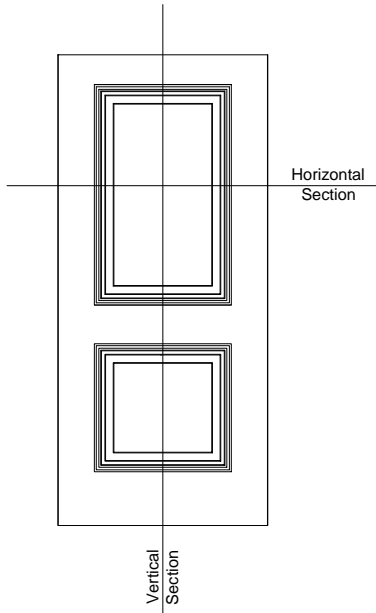

VERTICAL CROSS SECTION

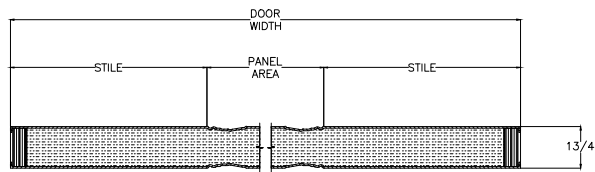

PANEL HORIZONTAL CROSS SECTION

Elevation Notes: • Door Size = Book Size Before Prefit • Daylight Opening (DLO) = Visible Glass. • Moulding Profile = n/a • Panel Profile = JW2
• Values in brackets [] are in millimeters • Wood grain = n/a

Scale: 1/4" = NTS

JELD-WEN reserves the right to change specifications without notice.

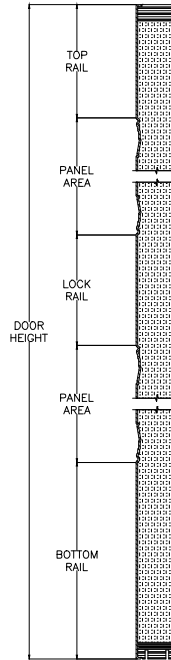
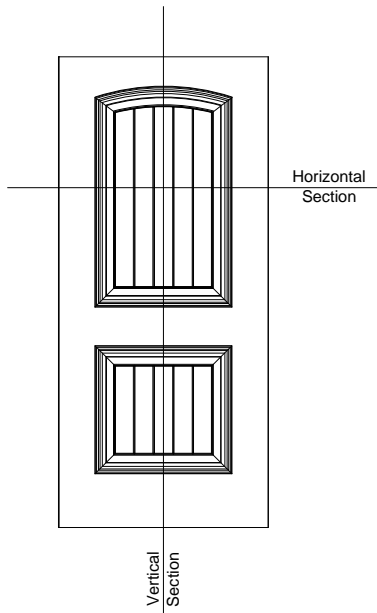

VERTICAL CROSS SECTION

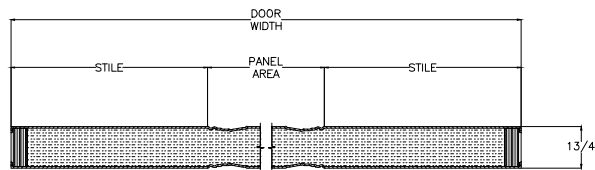

PANEL HORIZONTAL CROSS SECTION

Elevation Notes: • Door Size = Book Size Before Prefit • Daylight Opening (DLO) = Visible Glass. • Moulding Profile = n/a • Panel Profile = JW2
• Values in brackets [] are in millimeters • Wood grain = n/a

Door Cross-Section: • Moulding Profile = n/a • Panel Profile = JW2

Scale: 1/4" = NTS

JELD-WEN reserves the right to change specifications without notice.

STEEL - EXTERIOR DOORS
CT-30
3-PANEL

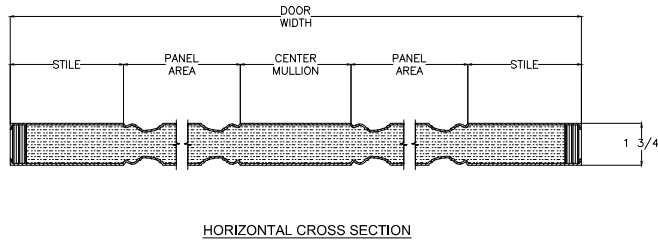
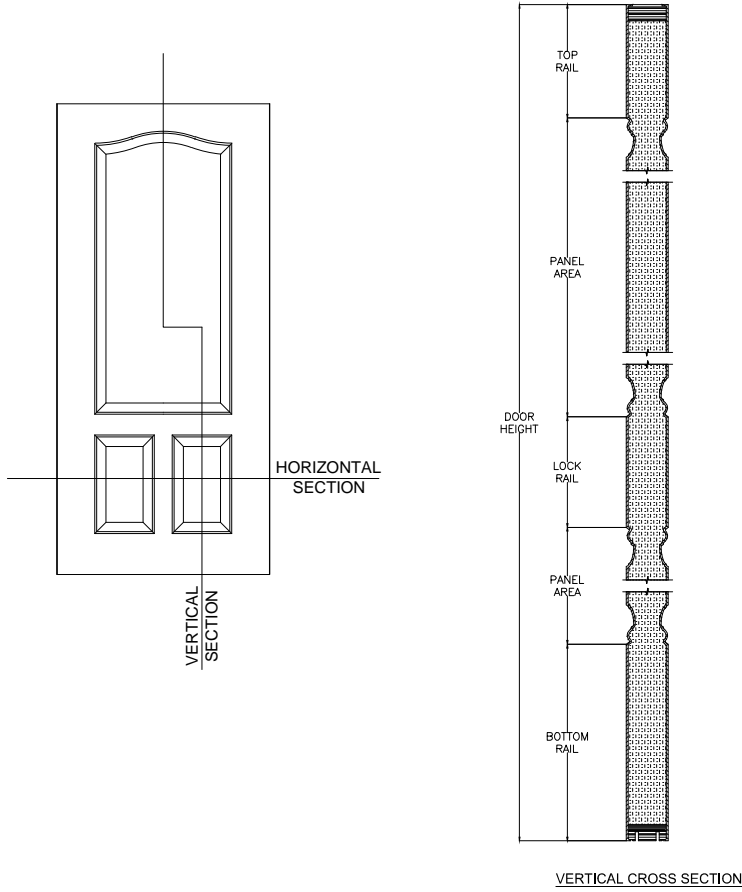

Elevation Notes: • Door Size = Book Size Before Prefit • Daylight Opening (DLO) = Visible Glass. **Door Cross-Section:** • Moulding Profile = n/a Scale: NTS
• Values in brackets [] are in millimeters • Wood grain = n/a • Panel Profile = JWBP

JELD-WEN reserves the right to change specifications without notice.

STEEL - EXTERIOR DOORS
CT-40BT
4-PANEL BLANK TOP

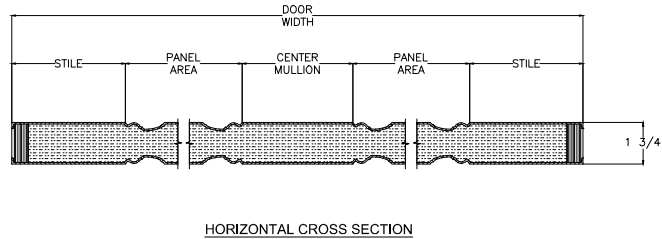
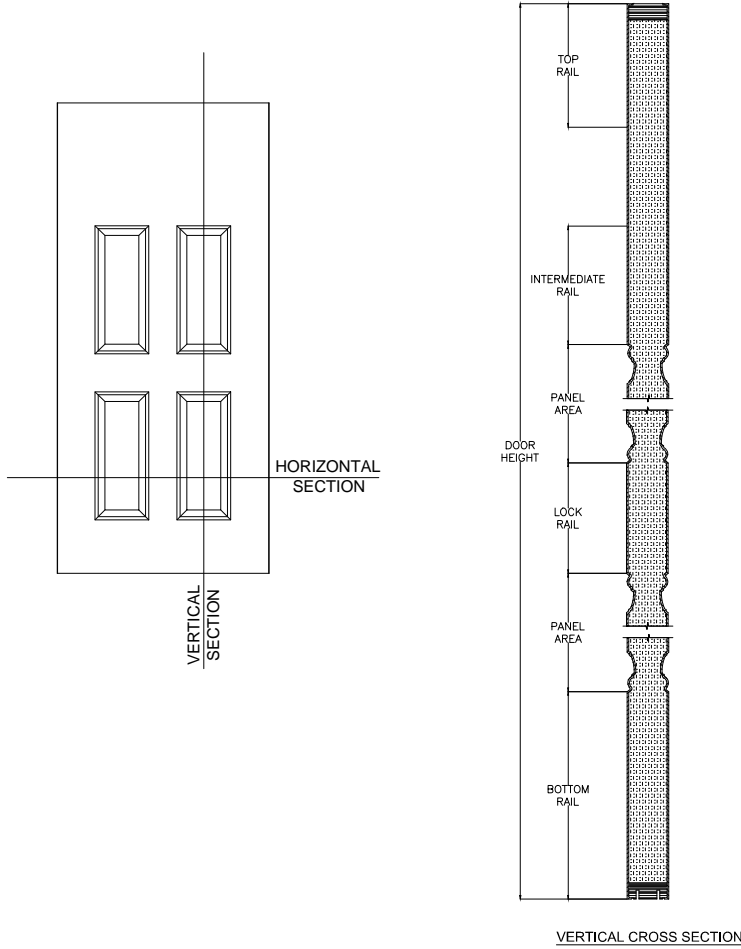

Elevation Notes: • Door Size = Book Size Before Prefit • Daylight Opening (DLO) = Visible Glass. • Moulding Profile = n/a • Panel Profile = JWPB
• Values in brackets [] are in millimeters • Wood grain = n/a

JELD-WEN reserves the right to change specifications without notice.

STEEL - EXTERIOR DOORS
CT-60
6-PANEL

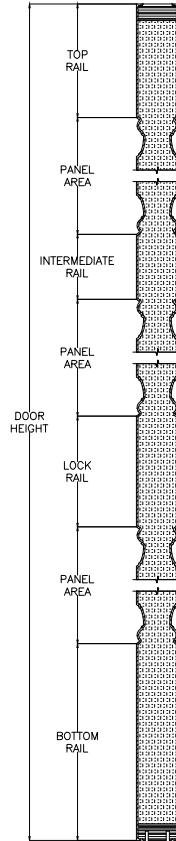
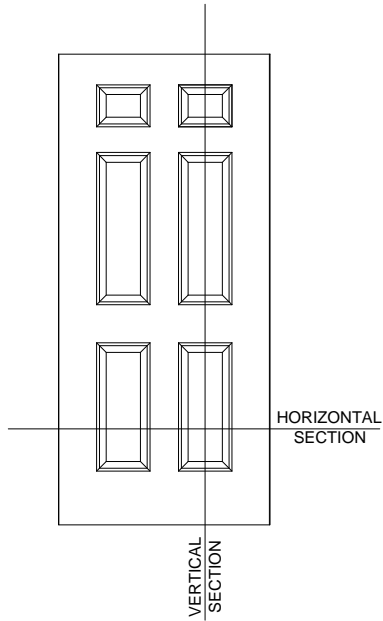

VERTICAL CROSS SECTION

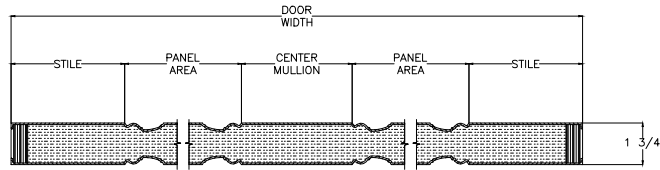

HORIZONTAL CROSS SECTION

Elevation Notes: • Door Size = Book Size Before Prefit • Daylight Opening (DLO) = Visible Glass. • **Door Cross-Section:** • Moulding Profile = n/a
• Values in brackets [] are in millimeters • Wood grain = n/a • Panel Profile = JWBP

Scale: NTS

JELD-WEN reserves the right to change specifications without notice.

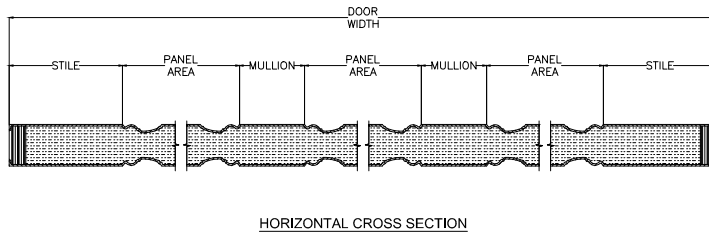
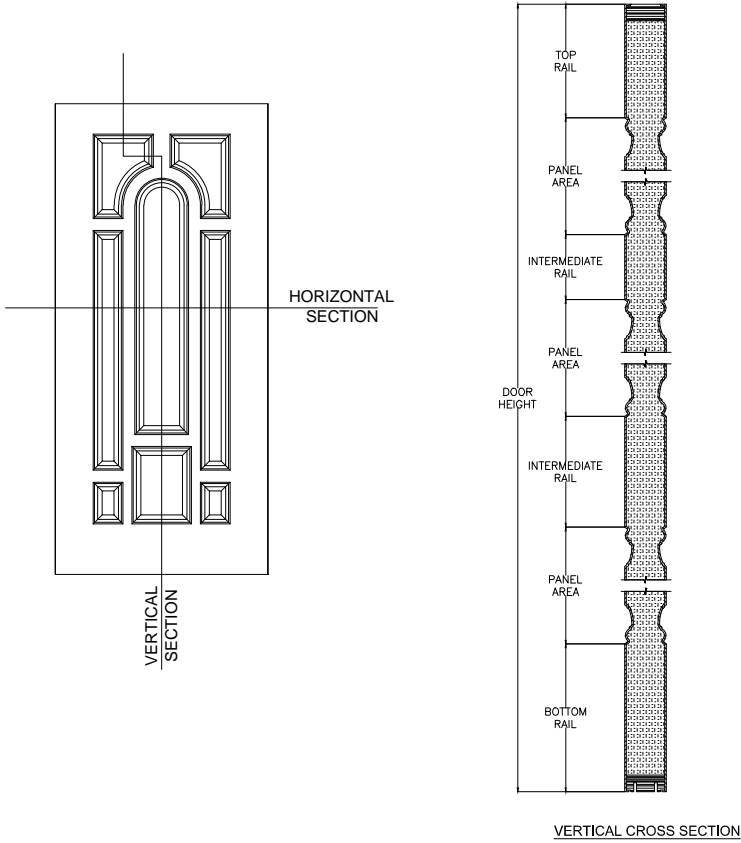

Elevation Notes: • Door Size = Book Size Before Prefit • Daylight Opening (DLO) = Visible Glass. **Door Cross-Section:** • Moulding Profile = n/a Scale: NTS
• Values in brackets [] are in millimeters • Wood grain = n/a • Panel Profile = JWBP

JELD-WEN reserves the right to change specifications without notice.

STEEL - EXTERIOR DOORS
CT-90
9-PANEL

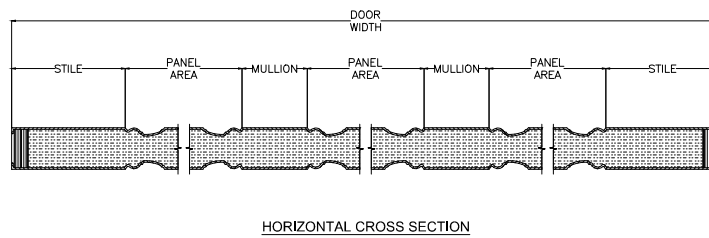
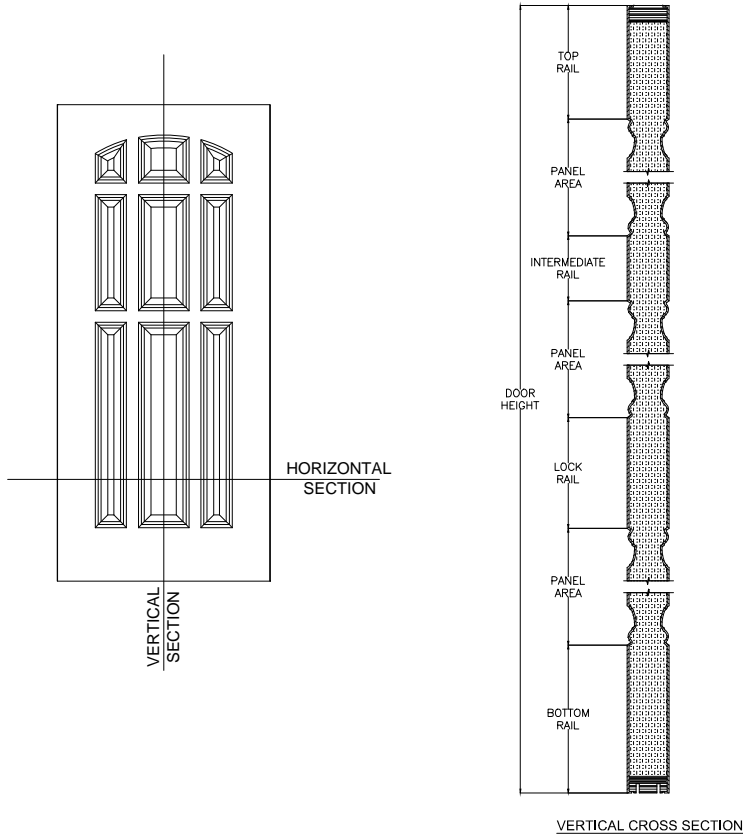

Elevation Notes: • Door Size = Book Size Before Prefit • Daylight Opening (DLO) = Visible Glass. • Moulding Profile = n/a • Panel Profile = JWBP
• Values in brackets [] are in millimeters • Wood grain = n/a

JELD-WEN reserves the right to change specifications without notice.

STEEL - EXTERIOR DOORS
CT8-60
8' 6-PANEL

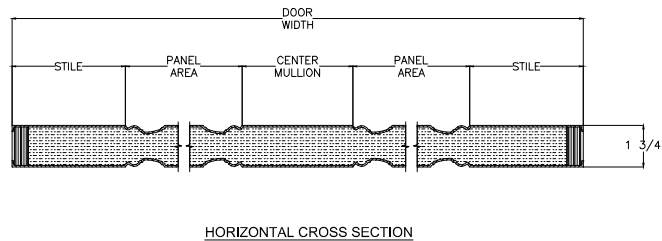
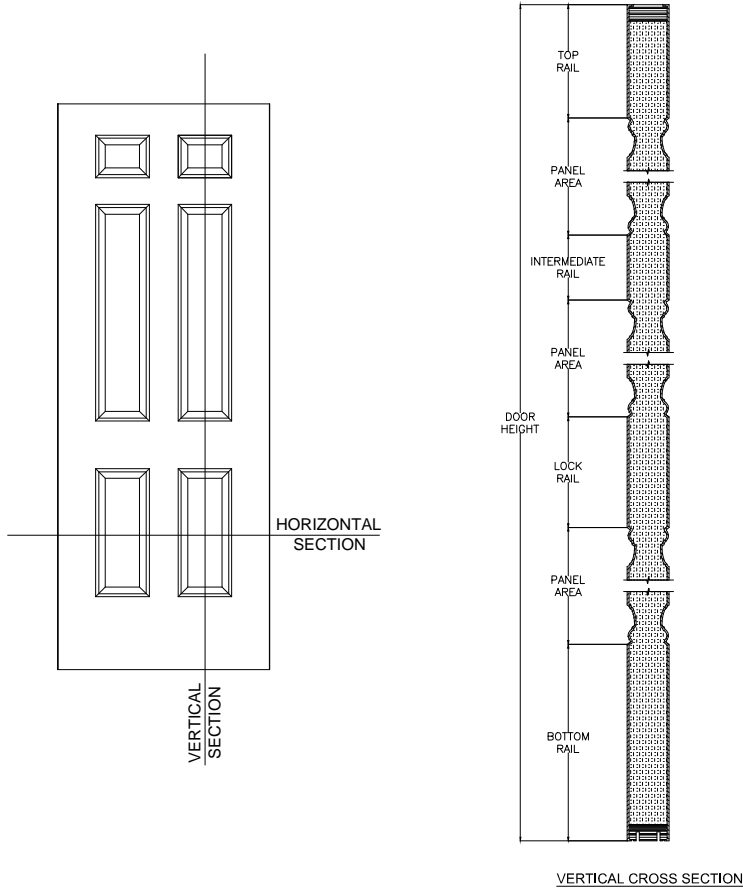

Elevation Notes: • Door Size = Book Size Before Prefit • Daylight Opening (DLO) = Visible Glass. • Moulding Profile = n/a
• Values in brackets [] are in millimeters • Wood grain = n/a • Panel Profile = JWPB

Scale: NTS

JELD-WEN reserves the right to change specifications without notice.