

## **Finishield All-Panel Door Sections**

### **Table of Contents**

FS-30 3-Panel .....	2
FS-60 6-Panel .....	3
FS-80 8-Panel Center Arch .....	4
FS-90 9-Panel .....	5
FS-100 Flush.....	6
FS8-60 8ft. 6-Panel.....	7
FS8-100 8ft. Flush.....	8

STEEL - EXTERIOR DOORS  
FS-30  
3-PANEL

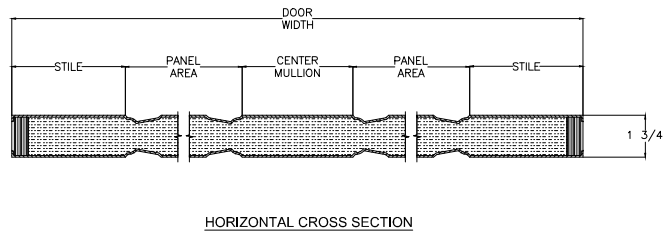
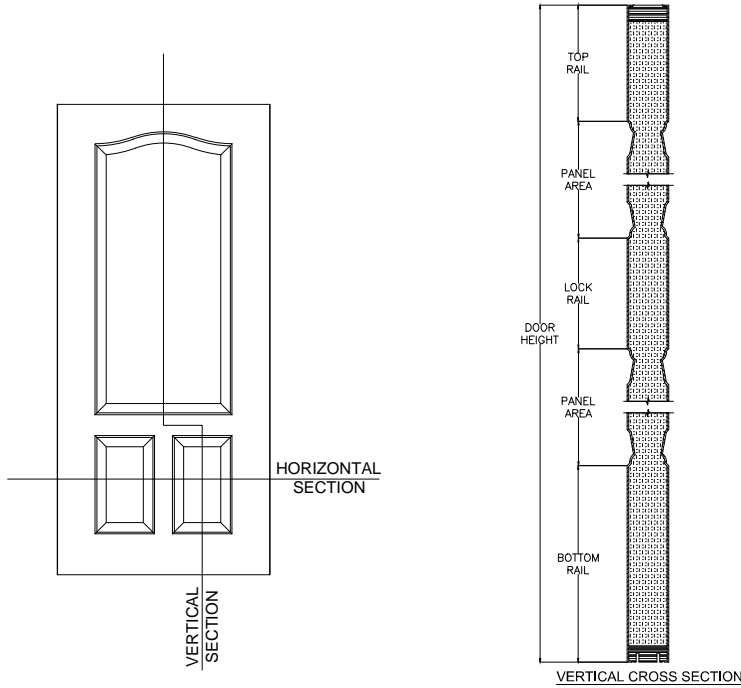

**Elevation Notes:** • Door Size = Book Size Before Prefit • Daylight Opening (DLO) = Visible Glass. • Moulding Profile = n/a  
 • Values in brackets [ ] are in millimeters • Wood grain = Oak • Panel Profile = "Ovolo" Scale: 1 1/2" = 1'-0"  
 Rev. A 11/24/10

JELD-WEN reserves the right to change specifications without notice.

STEEL - EXTERIOR DOORS

FS-60  
6-PANEL

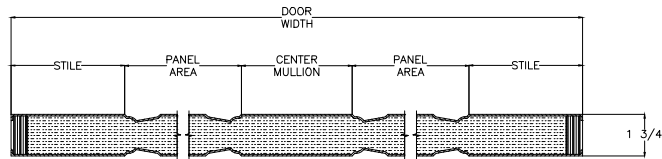
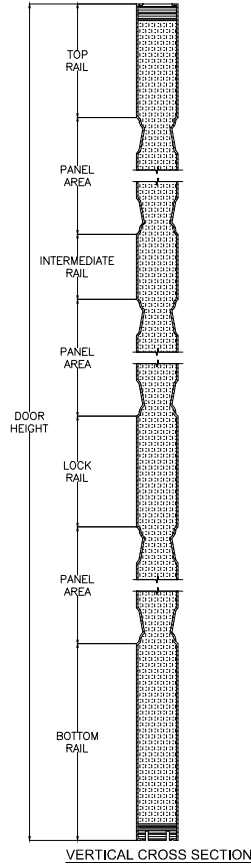
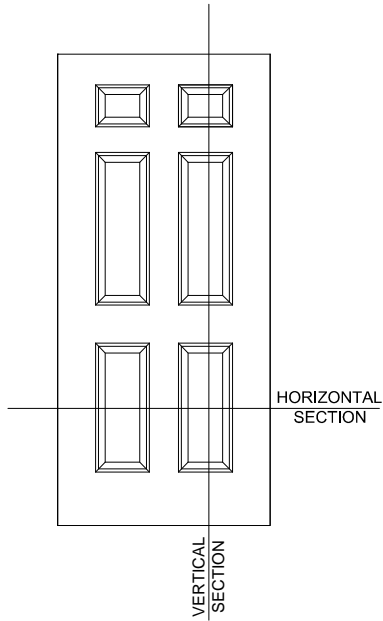

HORIZONTAL CROSS SECTION

**Elevation Notes:** • Door Size = Book Size Before Prefit • Daylight Opening (DLO) = Visible Glass. • Moulding Profile = n/a • Panel Profile = "Ovolo"  
• Values in brackets [ ] are in millimeters • Wood grain = Oak

**Door Cross-Section:** • Moulding Profile = n/a • Panel Profile = "Ovolo"

Scale: 1 1/2" = 1'-0"  
Rev. A 11/24/10

JELD-WEN reserves the right to change specifications without notice.

STEEL - EXTERIOR DOORS  
FS-80  
8-PANEL CENTER ARCH

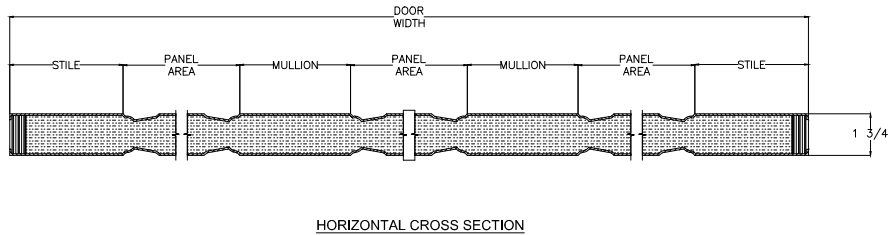
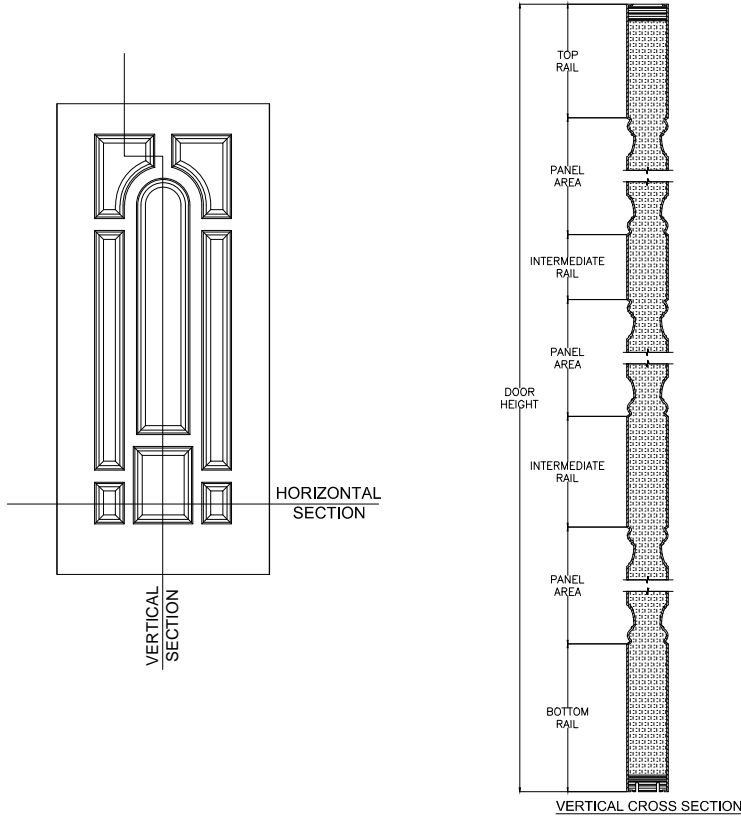

**Elevation Notes:**

- Door Size = Book Size Before Prefit
- Daylight Opening (DLO) = Visible Glass.
- Values in brackets [ ] are in millimeters
- Wood grain = Oak

**Door Cross-Section:**

- Moulding Profile = n/a
- Panel Profile = "Ovolo"

Scale: 1 1/2" = 1'-0"  
Rev. A 11/24/10

JELD-WEN reserves the right to change specifications without notice.

STEEL - EXTERIOR DOORS  
FS-90  
9-PANEL

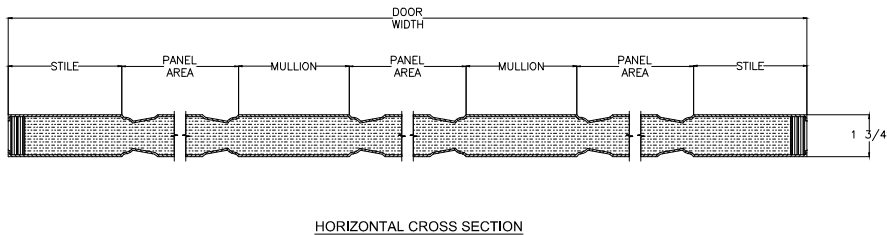
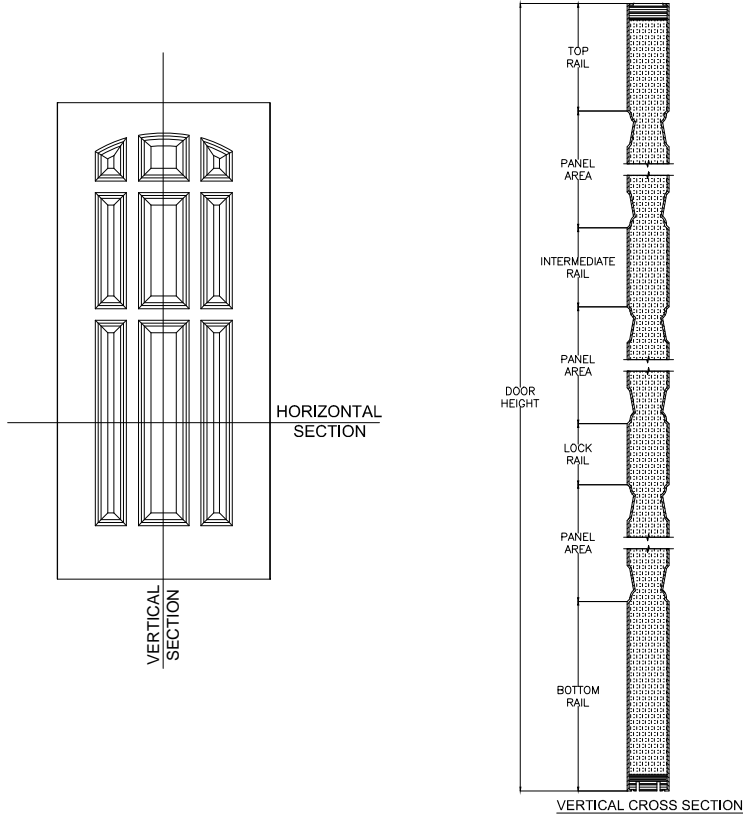

**Elevation Notes:** • Door Size = Book Size Before Prefit • Daylight Opening (DLO) = Visible Glass. • Moulding Profile = n/a • Panel Profile = "Ovolo"  
• Values in brackets [ ] are in millimeters • Wood grain = Oak

**Door Cross-Section:** • Moulding Profile = n/a • Panel Profile = "Ovolo"  
• Values in brackets [ ] are in millimeters • Wood grain = Oak

Scale: 1 1/2" = 1'-0"  
Rev. A 11/24/10

JELD-WEN reserves the right to change specifications without notice.

STEEL - EXTERIOR DOORS  
FS-100  
FLUSH

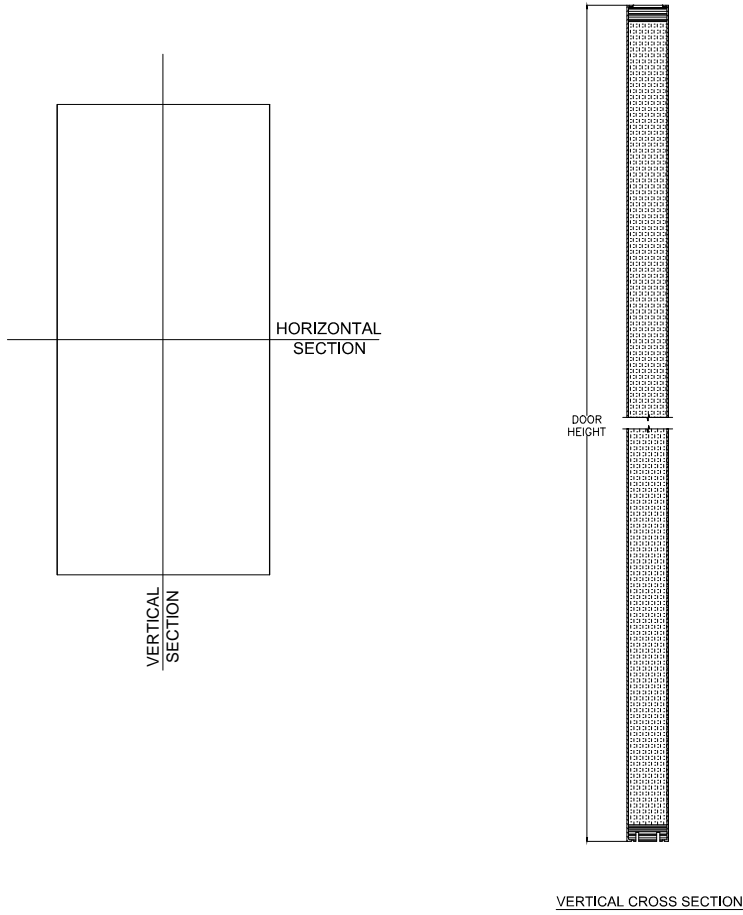

VERTICAL CROSS SECTION

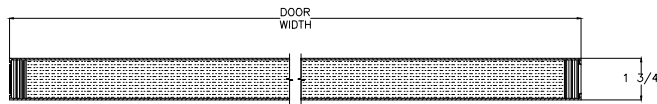

HORIZONTAL CROSS SECTION

Elevation Notes: • Door Size = Book Size Before Prefit • Daylight Opening (DLO) = Visible Glass. • Door Cross-Section: • Moulding Profile = n/a • Panel Profile = n/a  
• Values in brackets [ ] are in millimeters • Wood grain = n/a

JELD-WEN reserves the right to change specifications without notice.

Scale: 1 1/2" = 1'-0"  
Rev. A 11/24/10

STEEL - EXTERIOR DOORS  
FS8-60  
8' 6-PANEL

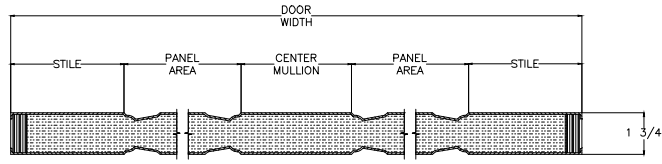
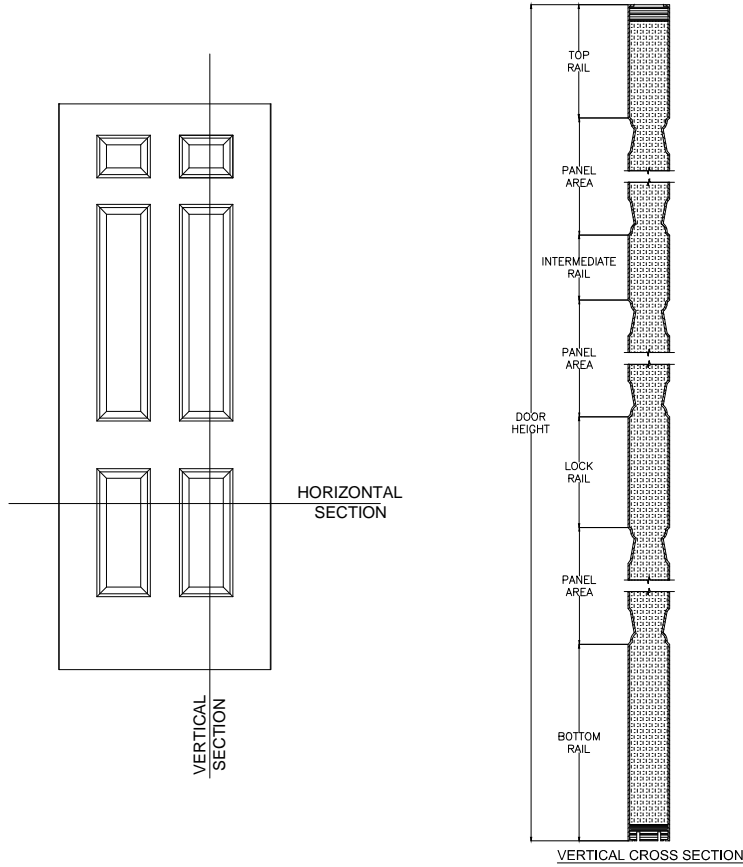

HORIZONTAL CROSS SECTION

**Elevation Notes:** • Door Size = Book Size Before Prefit • Daylight Opening (DLO) = Visible Glass. **Door Cross-Section:** • Moulding Profile = n/a • Panel Profile = "Ovolo"

• Values in brackets [ ] are in millimeters • Wood grain = n/a

Scale: 1 1/2" = 1'-0"  
Rev. A 11/24/10

JELD-WEN reserves the right to change specifications without notice.

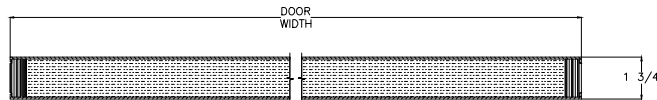
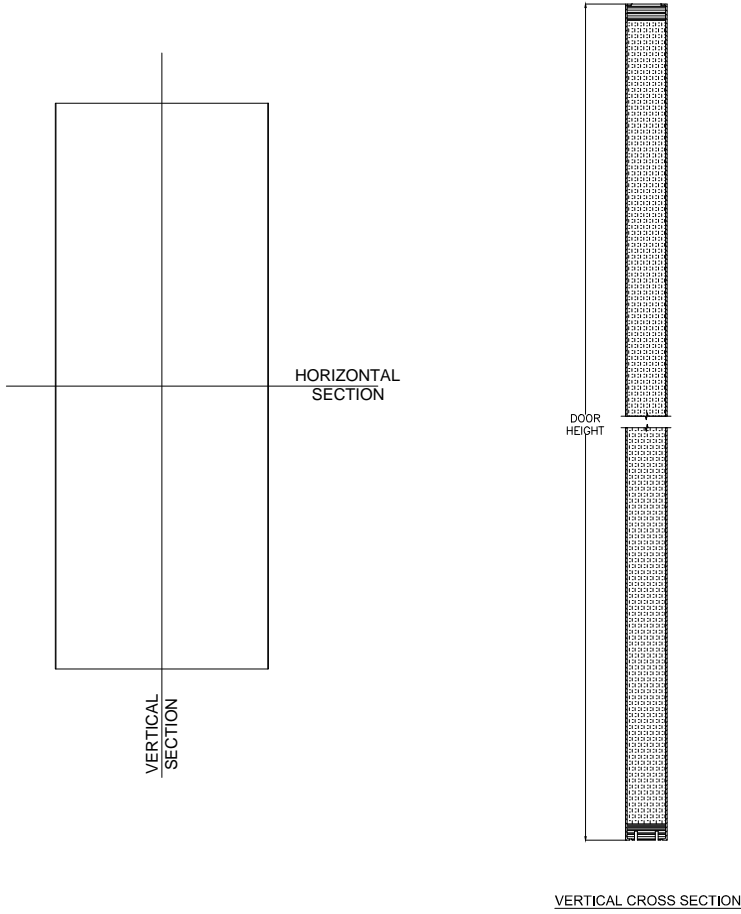

HORIZONTAL CROSS SECTION

**Elevation Notes:**

- Door Size = Book Size Before Prefit
- Daylight Opening (DLO) = Visible Glass.
- Values in brackets [ ] are in millimeters
- Wood grain = n/a

**Door Cross-Section:**

- Moulding Profile = n/a
- Panel Profile = n/a

Scale: 1 1/2" = 1'-0"  
Rev. A 11/24/10

JELD-WEN reserves the right to change specifications without notice.