



Premium Atlantic Aluminum
Roller

Table of Contents

Sections..... 2-13

- Slip on Nail Fin Vertical Section 2
- Slip on Nail Fin Horizontal Section..... 3
- Flange Frame Vertical Section..... 4
- Flange Frame Horizontal Section 5
- Slip on Nail Fin Single Pane Vertical Section 6
- Slip on Nail Fin Single Pane Horizontal Section..... 7
- Flange Frame Single Pane Vertical Section..... 8
- Flange Frame Single Pane Horizontal Section 9
- Slip on Nail Fin Impact Vertical Section 10
- Slip on Nail Fin Impact Horizontal Section..... 11
- Flange Frame Impact Vertical Section..... 12
- Flange Frame Impact Horizontal Section 13

Elevations 14-18

- Single Unit..... 14
- Single Unit Florida..... 18

PREMIUM ATLANTIC ALUMINUM
ROLLER WINDOW
SLIP ON NAIL FIN VERTICAL SECTION

• Scale: 1:2

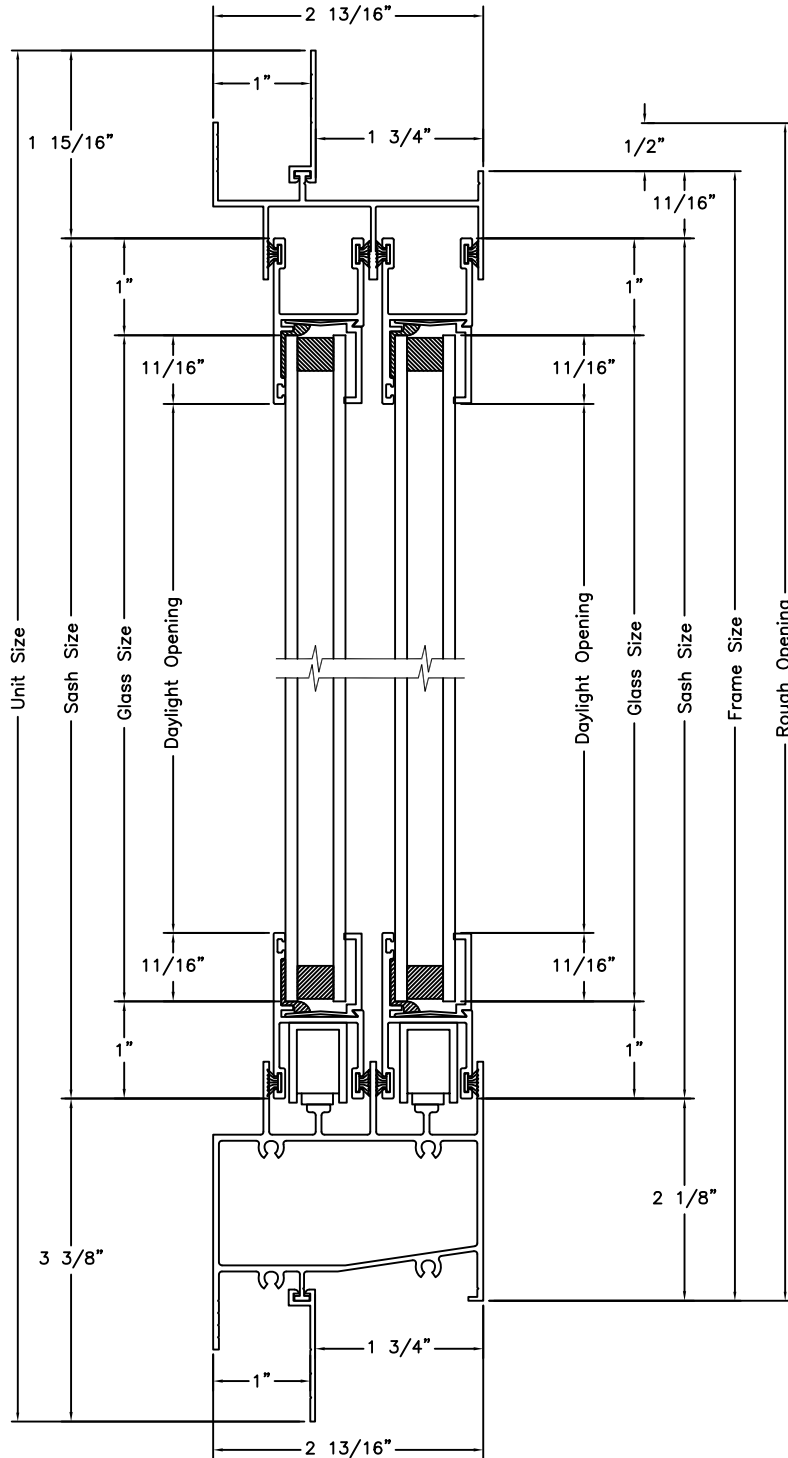

Vertical Section

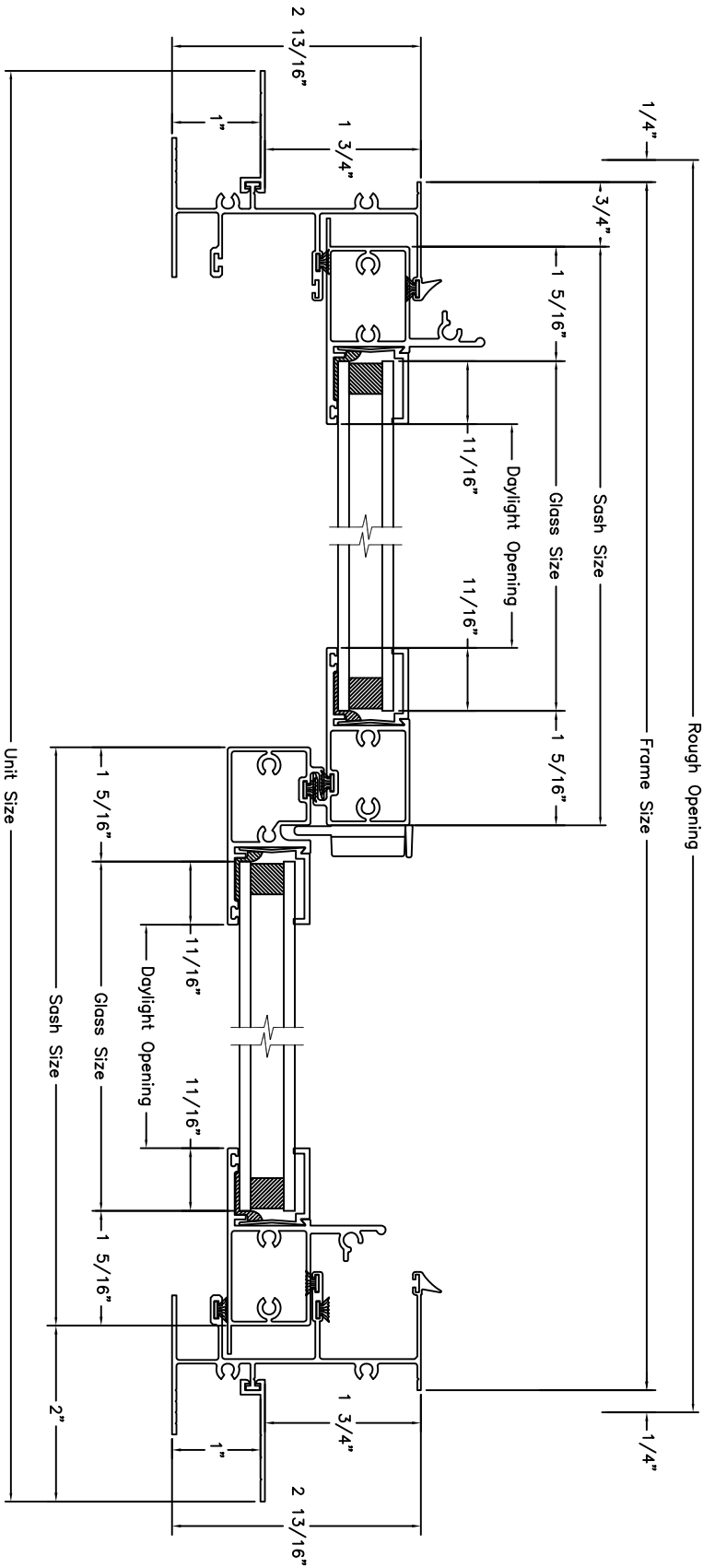

Horizontal Section

PREMIUM ATLANTIC ALUMINUM
ROLLER WINDOW
FLANGE FRAME VERTICAL SECTION

• Scale: 1:2

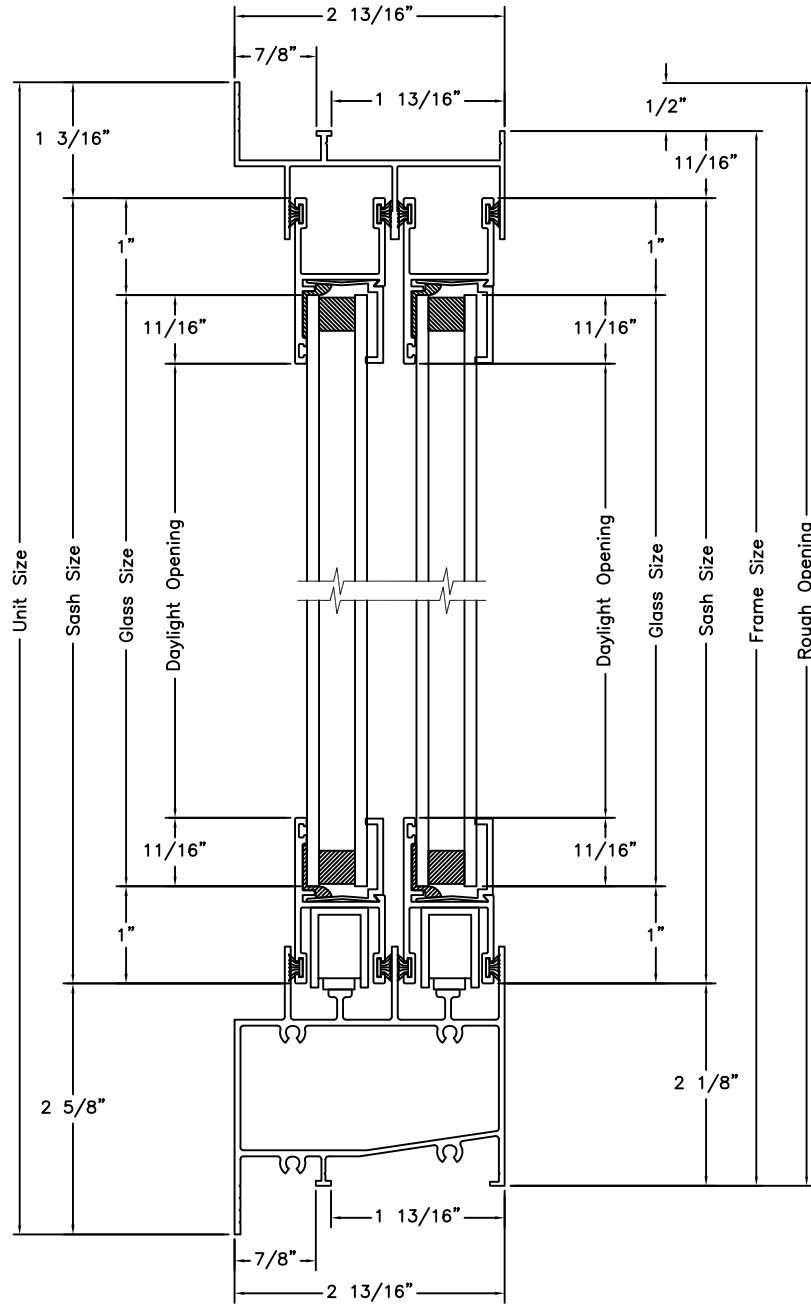

Vertical Section

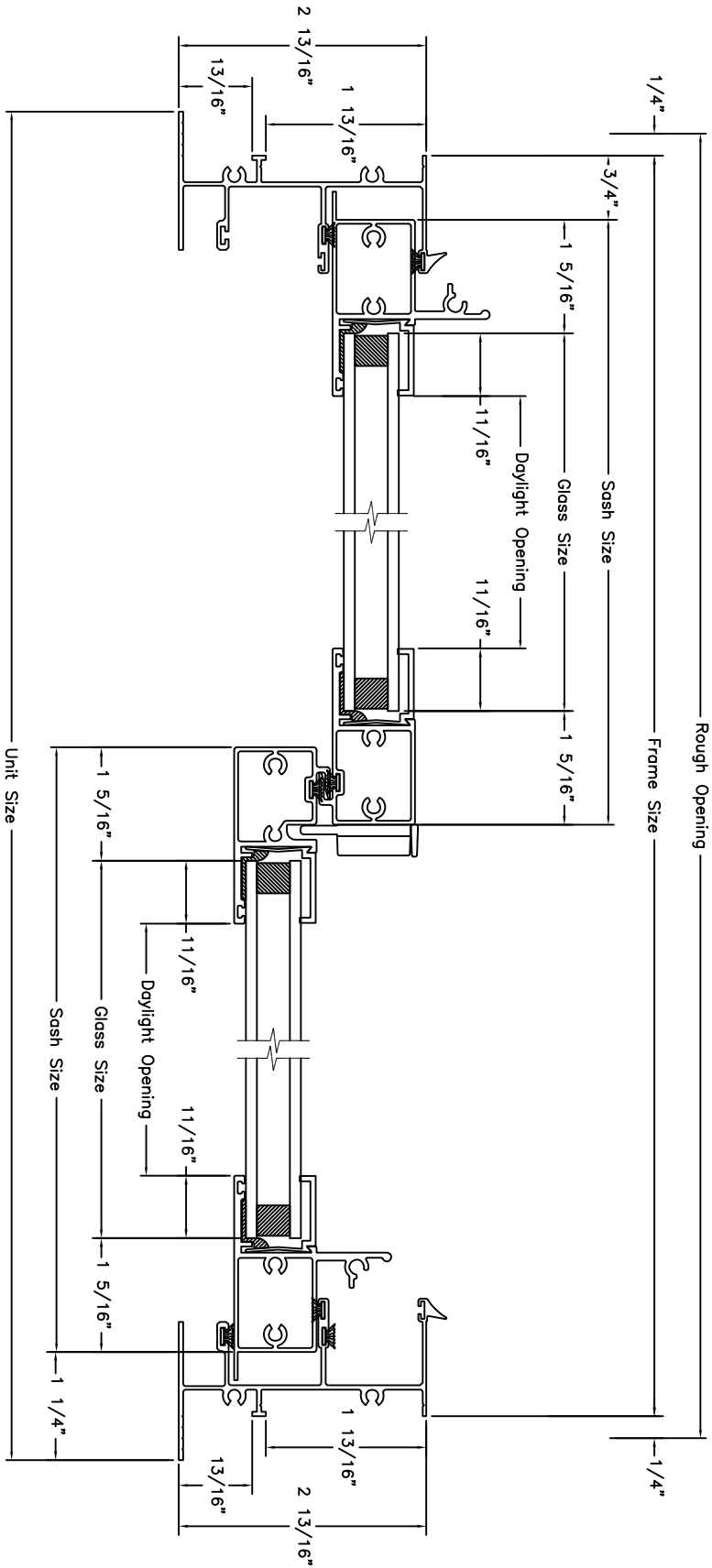

Horizontal Section

PREMIUM ATLANTIC ALUMINUM
ROLLER WINDOW
SLIP ON NAIL FIN SINGLE PANE VERTICAL SECTION

• Scale: 1:2

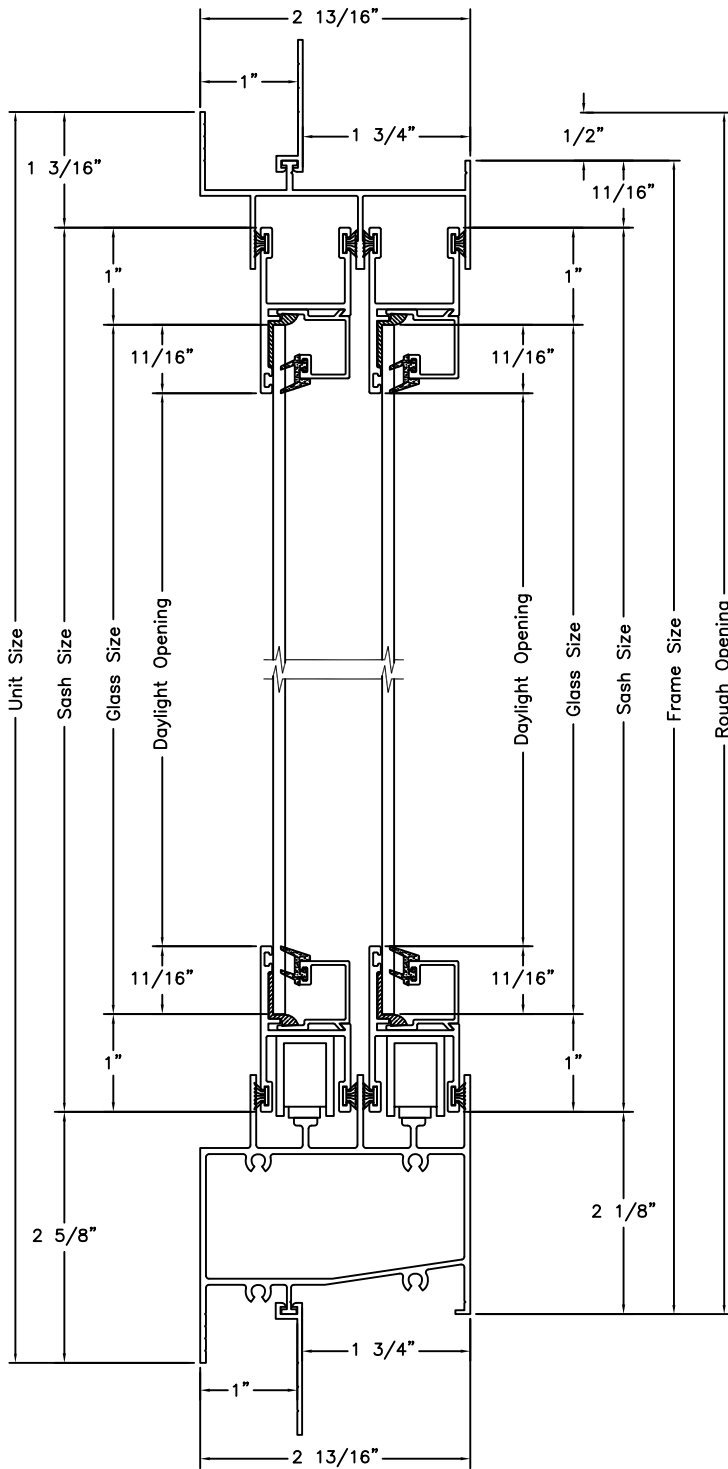

Vertical Section

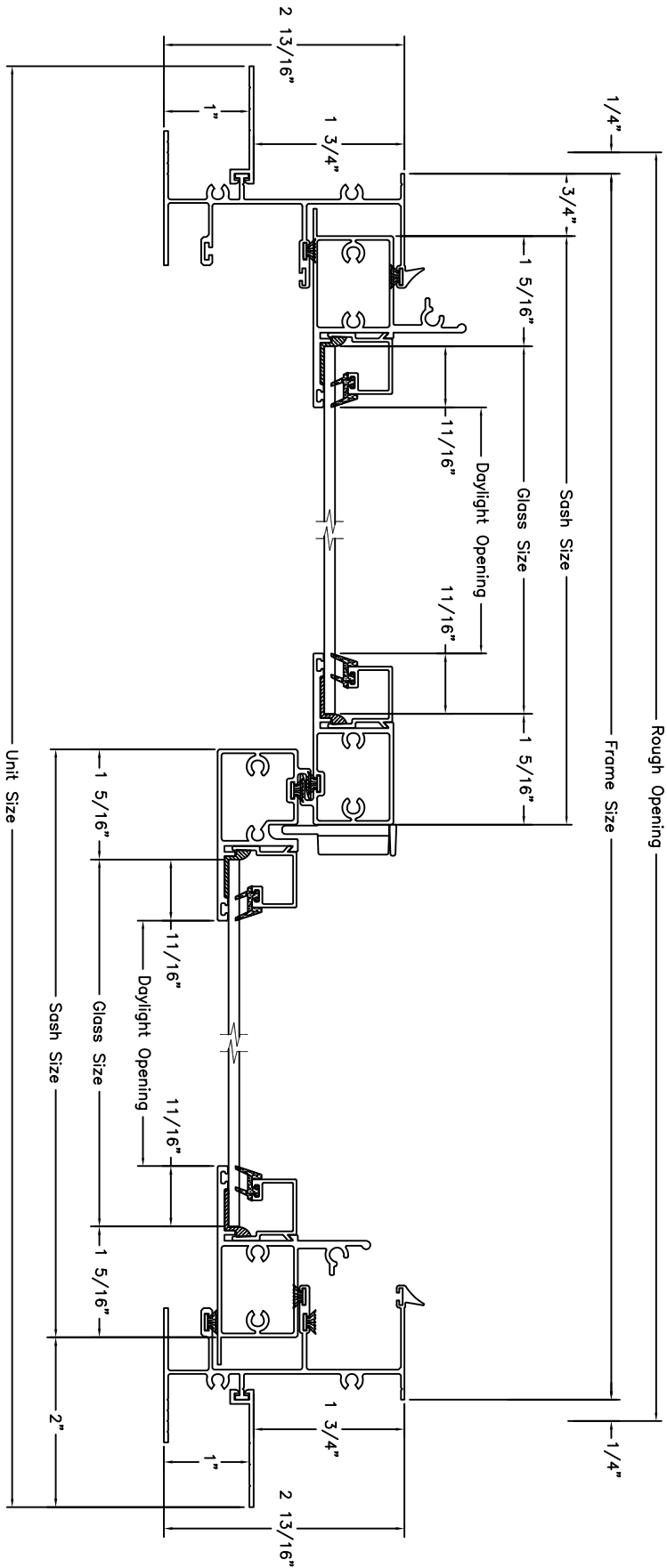

Horizontal Section

PREMIUM ATLANTIC ALUMINUM
ROLLER WINDOW
FLANGE FRAME SINGLE PANE VERTICAL SECTION

• Scale: 1:2

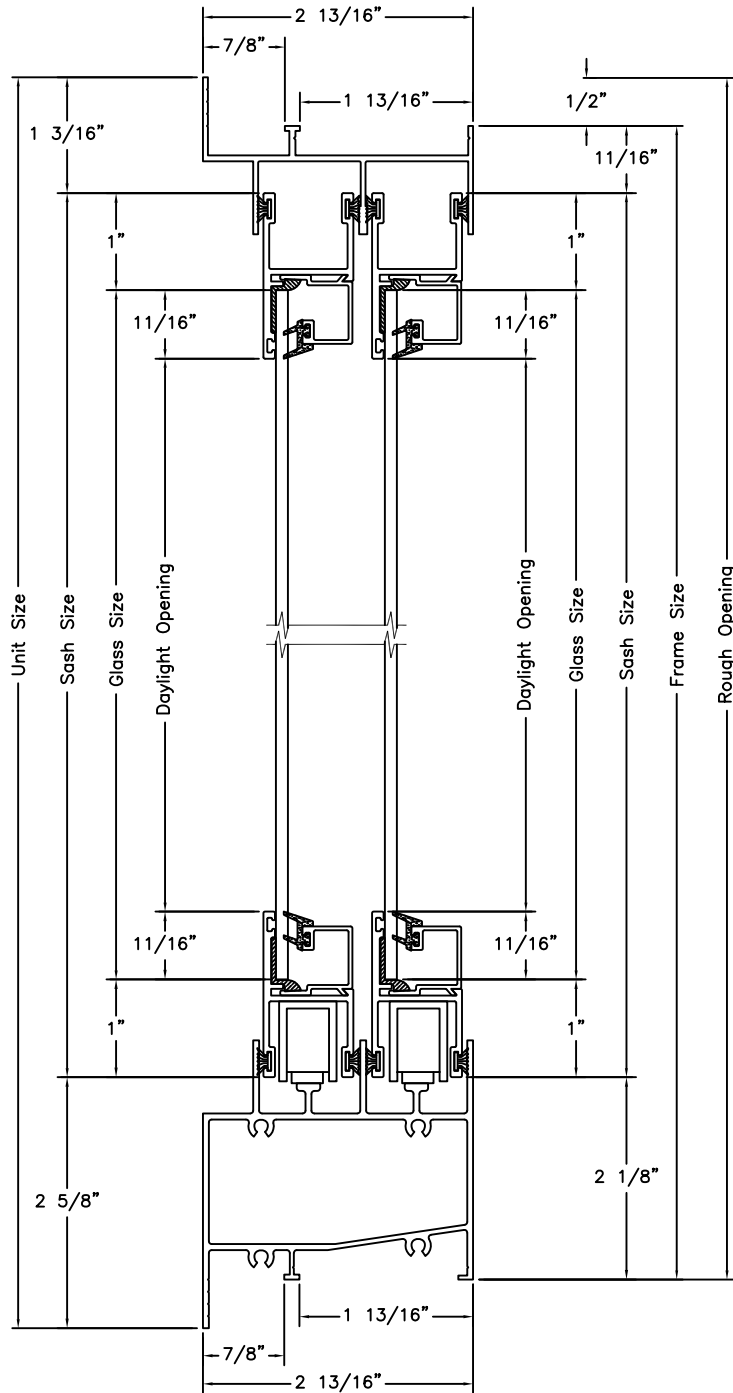

Vertical Section

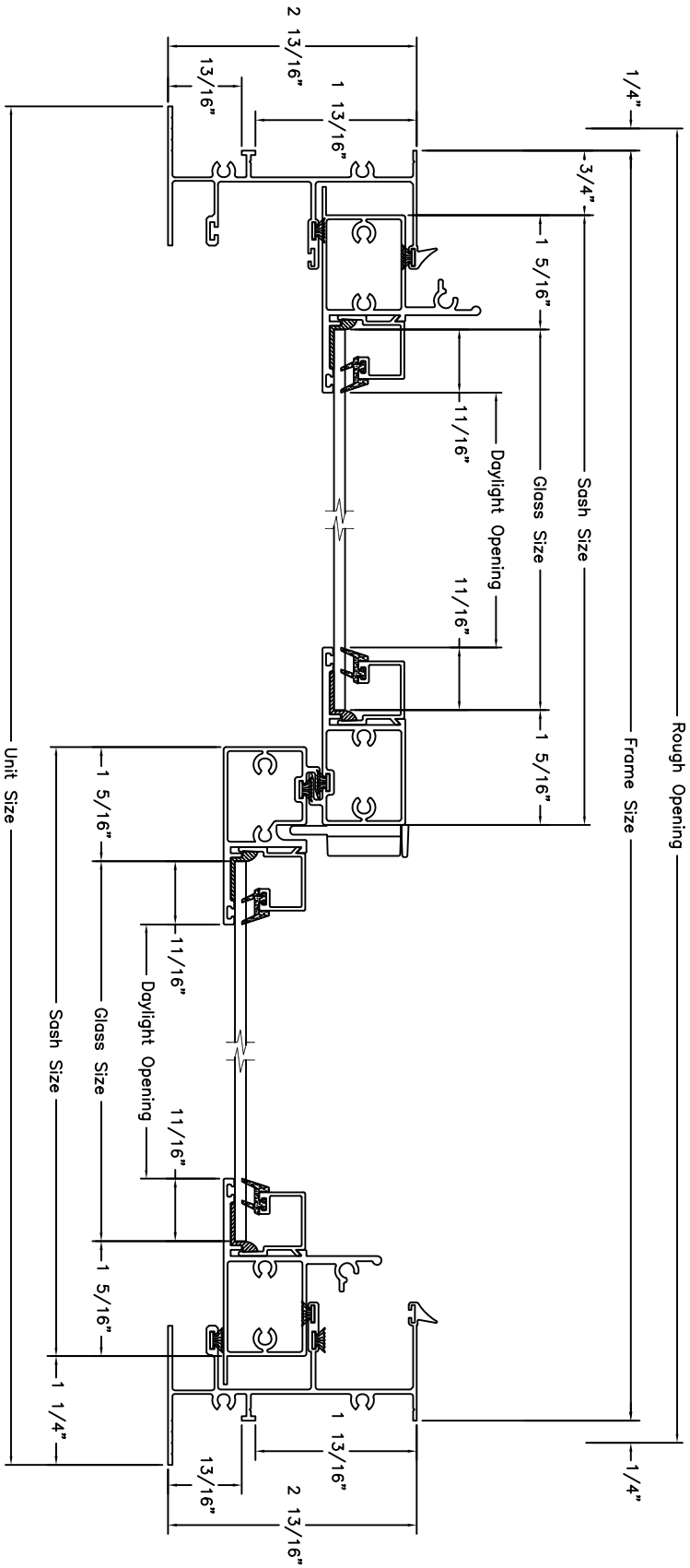

Horizontal Section

PREMIUM ATLANTIC ALUMINUM
ROLLER WINDOW
SLIP ON NAIL FIN IMPACT VERTICAL SECTION

• Scale: 1:2

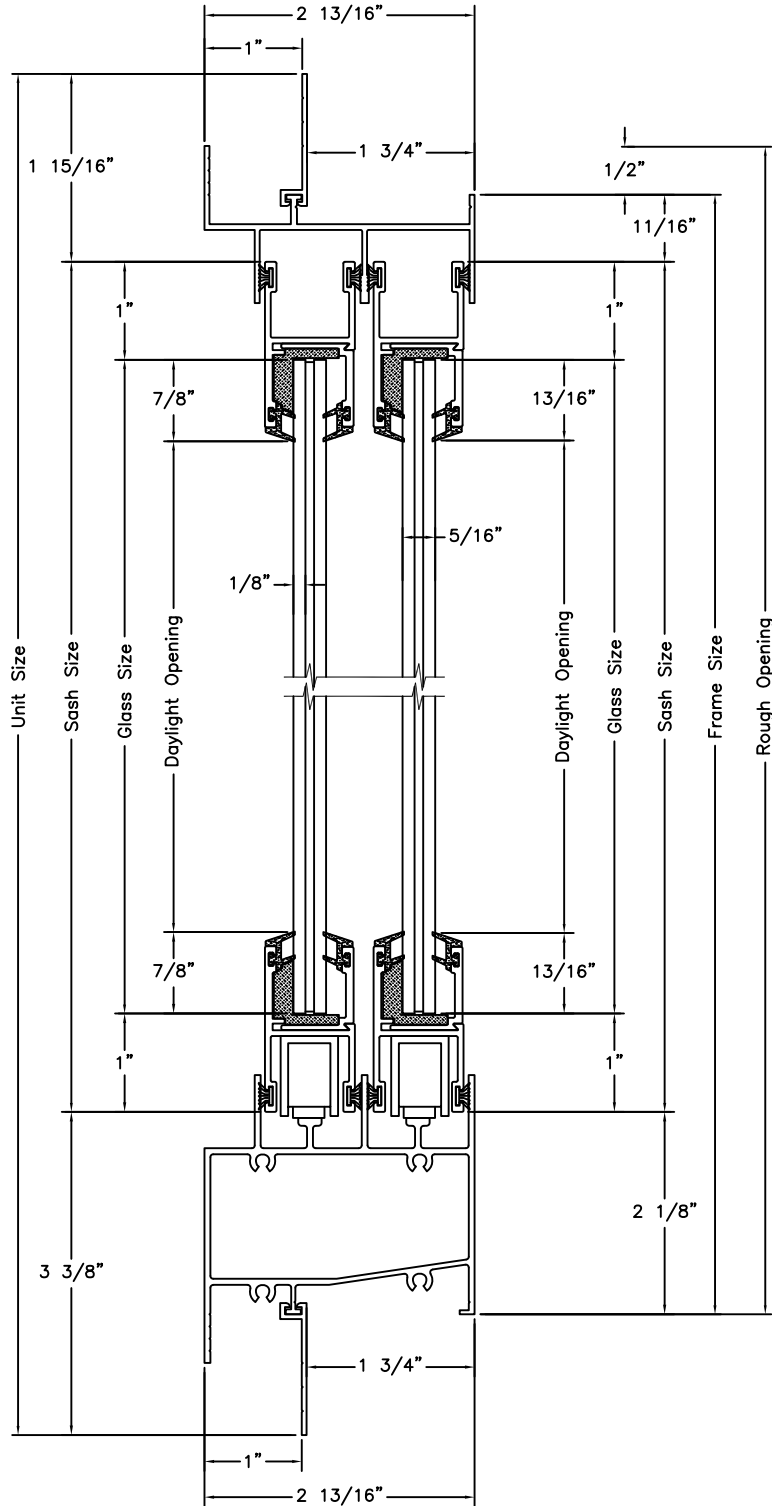

Vertical Section

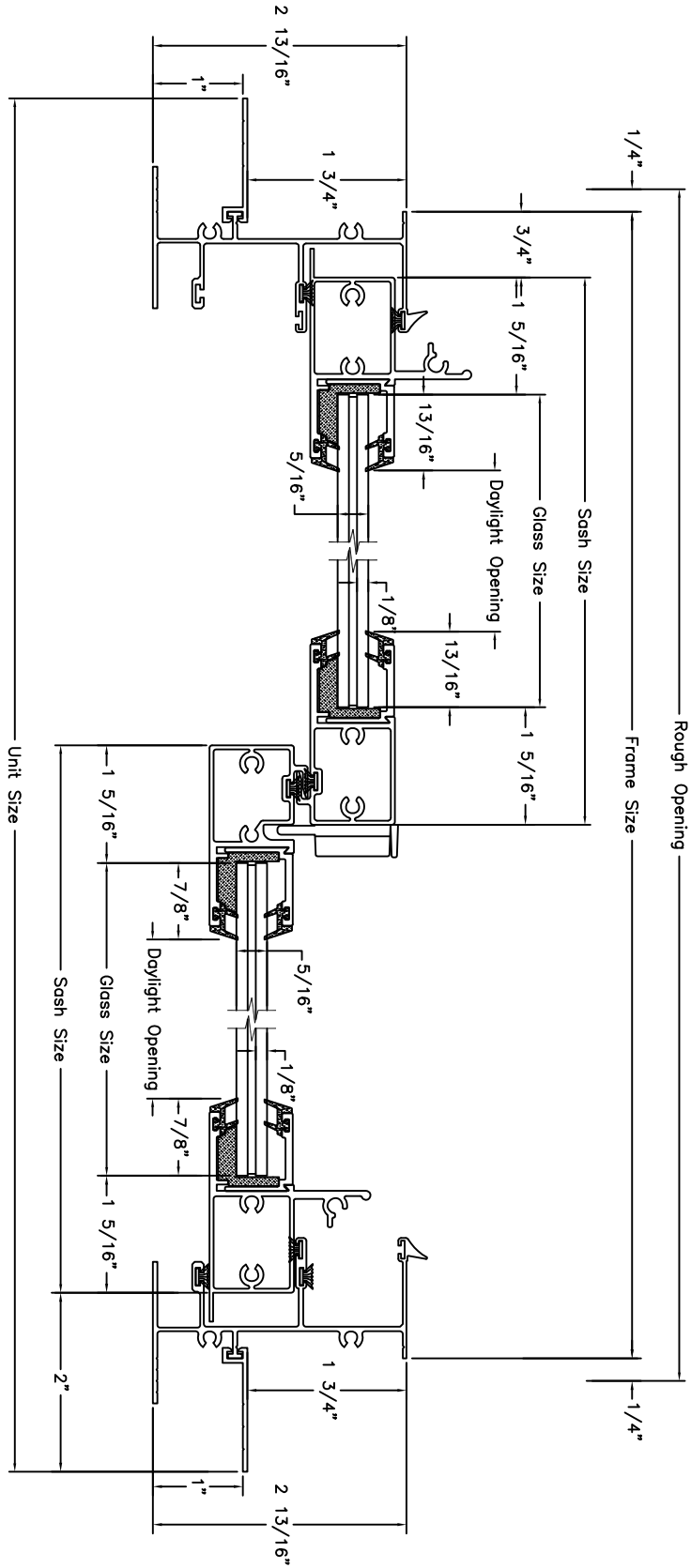

Horizontal Section

PREMIUM ATLANTIC ALUMINUM
ROLLER WINDOW
FLANGE FRAME IMPACT VERTICAL SECTION

• Scale: 1:2

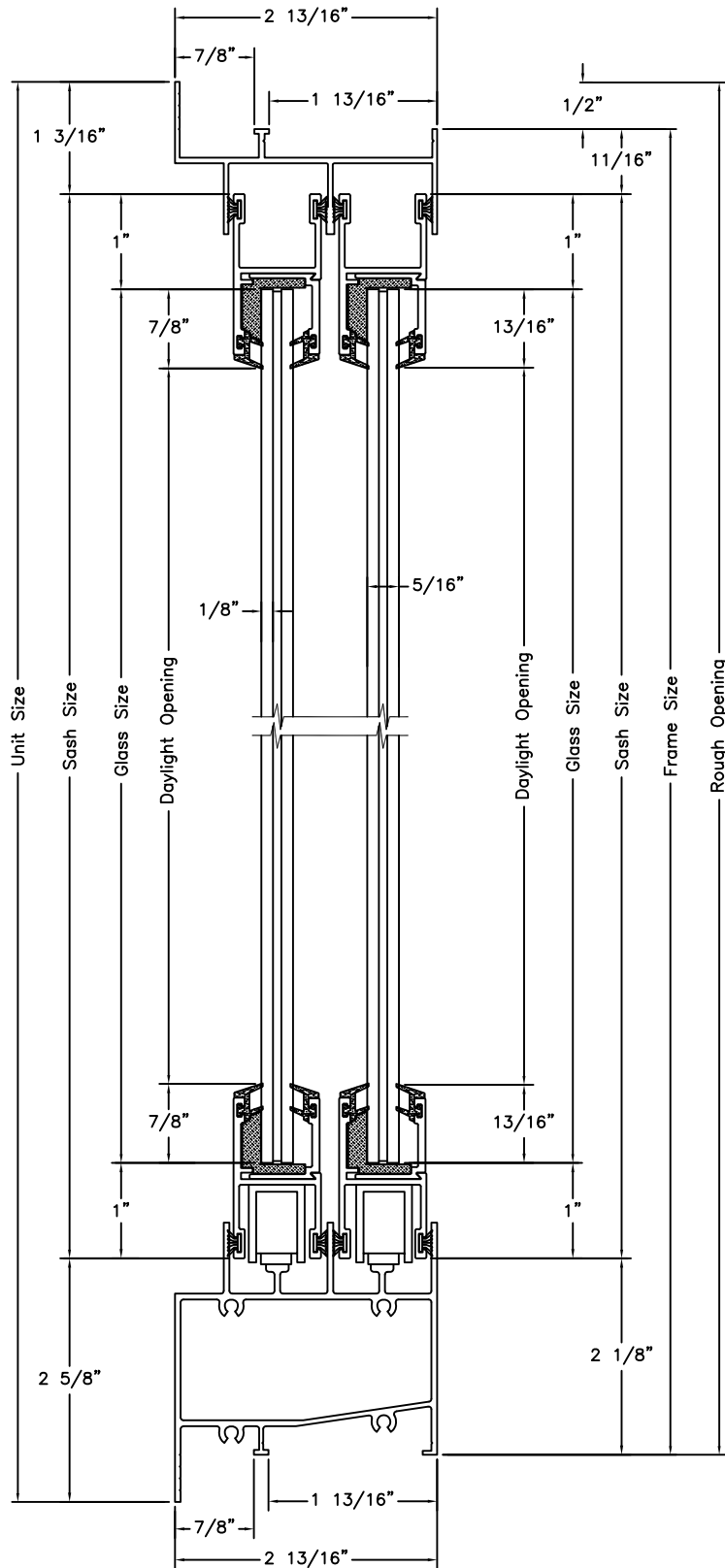

Vertical Section

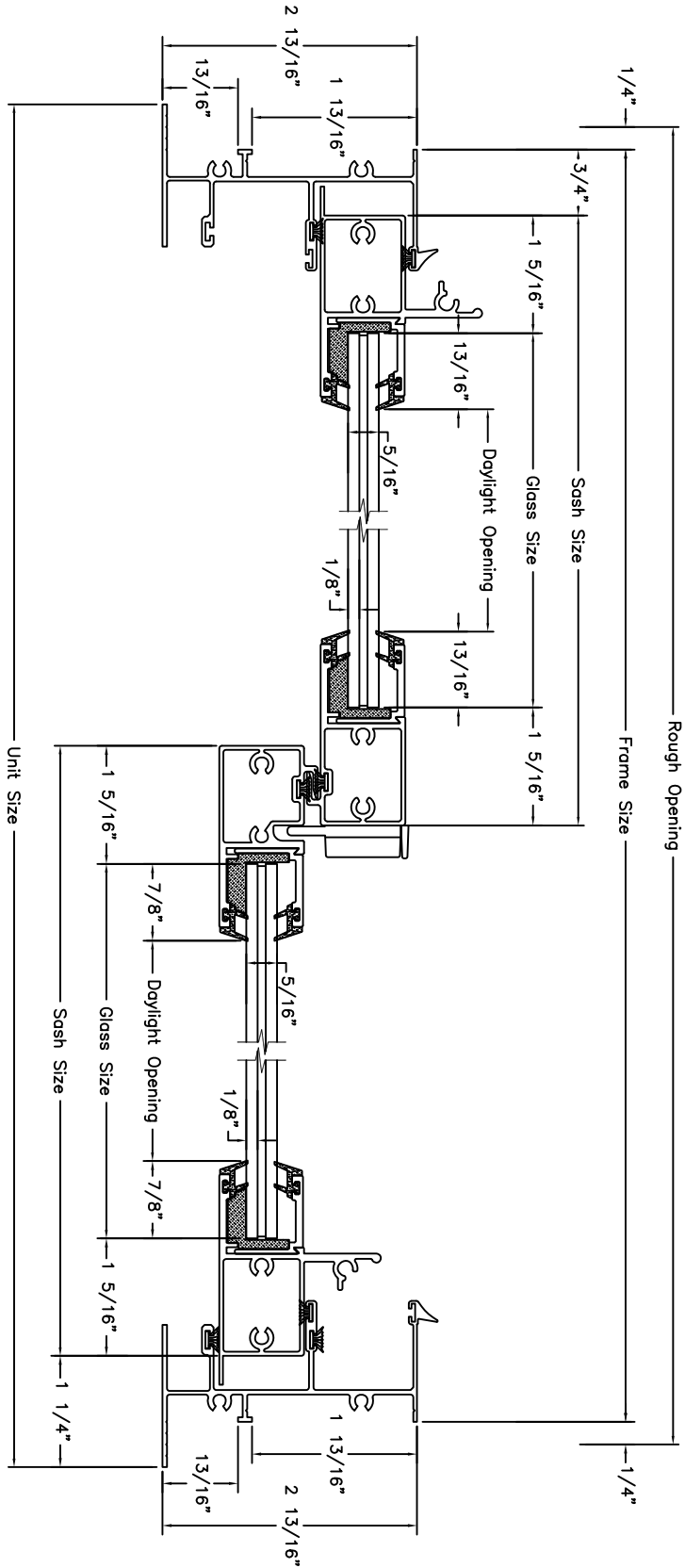

Horizontal Section

PREMIUM ATLANTIC ALUMINUM ROLLER WINDOW SINGLE UNIT ELEVATIONS

• Scale: 1/4"=1'-0"

UNIT SIZE	24"(610)	30"(762)	36"(914)	42"(1067)	48"(1219)	54"(1372)
ROUGH OPENING	23 1/2"(597)	29 1/2"(749)	35 1/2"(902)	41 1/2"(1054)	47 1/2"(1207)	53 1/2"(1359)
FRAME SIZE	23"(584)	29"(737)	35"(889)	41"(1041)	47"(1194)	53"(1346)
DAYLIGHT OPENING	7 3/16"[2](183)	10 3/16"[2](259)	13 3/16"[2](335)	16 3/16"[2](411)	19 3/16"[2](487)	22 3/16"[2](564)
18"(457) 17 1/2"(445) 17"(432) 10 3/4"(273)						
24"(610) 23 1/2"(597) 23"(584) 16 3/4"(425)						
30"(762) 29 1/2"(749) 29 1/4"(737) 22 3/4"(578)						
36"(914) 35 1/2"(902) 35"(889) 28 3/4"(730)						
42"(1067) 41 1/2"(1054) 41 1/4"(1041) 34 3/4"(883)						
48"(1219) 47 1/2"(1207) 47 1/4"(1194) 40 3/4"(1035)						
54"(1372) 53 1/2"(1359) 53"(1346) 46 3/4"(1187)						
60"(1524) 59 1/2"(1511) 59"(1499) 52 3/4"(1340)						

ELEVATION SYMBOL LEGEND:
 VALUES IN () ARE IN MILLIMETER CONVERSIONS
E BASIC UNIT CLEAR OPENING EXCEEDS 20" IN WIDTH, 24" IN HEIGHT & A MINIMUM OF 5.7 SQ. FT.
NUMBER INDICATES DESIGN PRESSURE (DP) RATING WITH STANDARD GLAZING

Note: Elevations shown DO NOT have exterior trim. Subtract 1/2"(12.7) from M.O.(Masonry Opening) for Unit Sizes. Masonry openings above include Sill Nose, see Trim Options page for Sill Nose specifications. For other Trim Options refer to the Unit Sizing, Rough Opening & Masonry Openings page.

PREMIUM ATLANTIC ALUMINUM
ROLLER WINDOW
SINGLE UNIT ELEVATIONS

• Scale: 1/4"=1'-0"

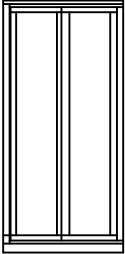
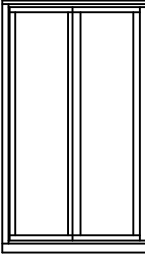
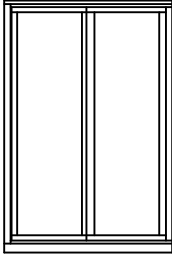
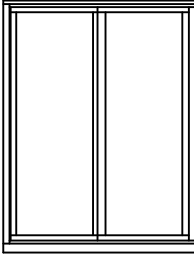
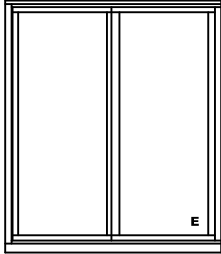

	24"(610)	30"(762)	36"(914)	42"(1067)	48"(1219)	54"(1372)
UNIT SIZE	24"(610)	30"(762)	36"(914)	42"(1067)	48"(1219)	54"(1372)
ROUGH OPENING	23 1/2"(597)	29 1/2"(749)	35 1/2"(902)	41 1/2"(1054)	47 1/2"(1207)	53 1/2"(1359)
FRAME SIZE	23"(584)	29"(737)	35"(889)	41"(1041)	47"(1194)	53"(1346)
DAYLIGHT OPENING	7 3/16"[2](183)	10 3/16"[2](259)	13 3/16"[2](335)	16 3/16"[2](411)	19 3/16"[2](487)	22 3/16"[2](564)
						
	6RW2463	6RW3063	6RW3663	6RW4263	6RW4863	6RW5463

63"(1600)
62 1/2"(1588)
62"(1575)
55 3/4"(1416)

E

PREMIUM ATLANTIC ALUMINUM ROLLER WINDOW SINGLE UNIT ELEVATIONS

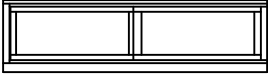
• Scale: 1/4"=1'-0"

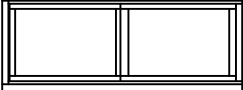
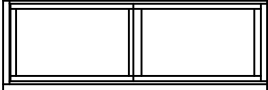
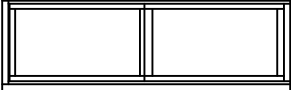
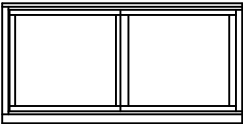
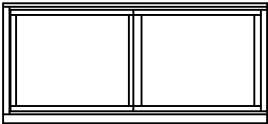
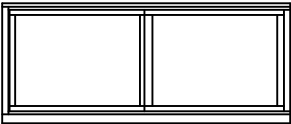
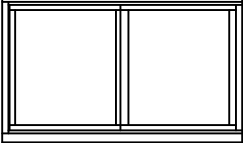
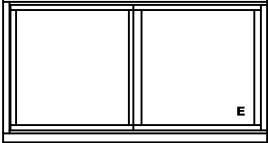
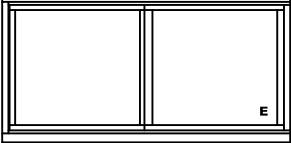
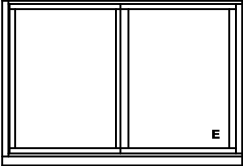
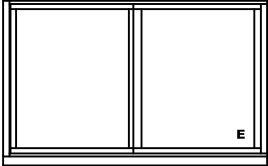
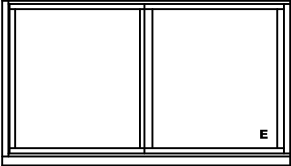
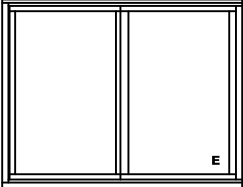
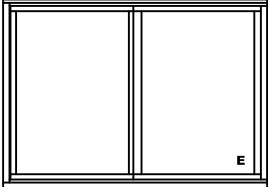
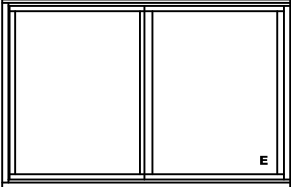
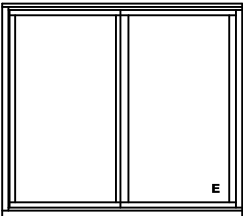
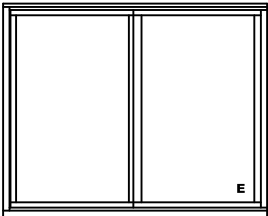
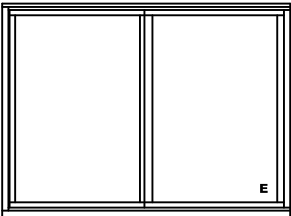
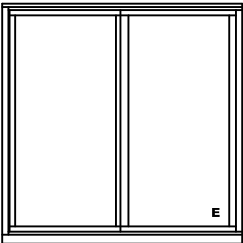
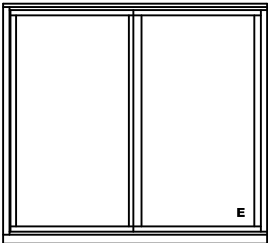
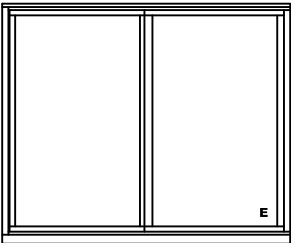
UNIT SIZE	60"(1524)	66"(1676)	72"(1829)
ROUGH OPENING	59 1/2"(1511)	65 1/2"(1664)	71 1/2"(1861)
FRAME SIZE	59"(1499)	65"(1651)	71"(1803)
DAYLIGHT OPENING	25 3/16"(2)(640)	28 3/16"(2)(716)	31 3/16"(2)(792)
18"(457) 17 1/2"(445) 17"(432) 10 3/4"(273)	 6RW6018	 6RW6618	 6RW7218
24"(610) 23 1/2"(597) 23"(584) 16 3/4"(425)	 6RW6024	 6RW6624	 6RW7224
30"(762) 29 1/2"(749) 29"(737) 22 3/4"(578)	 6RW6030	 6RW6630	 6RW7230
36"(914) 35 1/2"(902) 35"(889) 28 3/4"(730)	 6RW6036	 6RW6636	 6RW7236
42"(1067) 41 1/2"(1054) 41"(1041) 34 3/4"(883)	 6RW6042	 6RW6642	 6RW7242
48"(1219) 47 1/2"(1207) 47"(1194) 40 3/4"(1035)	 6RW6048	 6RW6648	 6RW7248
54"(1372) 53 1/2"(1359) 53"(1346) 46 3/4"(1187)	 6RW6054	 6RW6654	 6RW7254
60"(1524) 59 1/2"(1511) 59"(1499) 52 3/4"(1340)	 6RW6060	 6RW6660	 6RW7260

PREMIUM ATLANTIC ALUMINUM
ROLLER WINDOW
SINGLE UNIT ELEVATIONS

• Scale: 1/4"=1'-0"

UNIT SIZE
ROUGH OPENING
FRAME SIZE
DAYLIGHT OPENING

60"(1524)
59 1/2"(1511)
59"(1499)
25 3/16"[2](640)

66"(1676)
65 1/2"(1664)
65"(1651)
28 3/16"[2](716)

72"(1829)
71 1/2"(1861)
71"(1803)
31 3/16"[2](792)

63"(1600)
62 1/2"(1588)
62"(1575)
55 3/4"(1416)

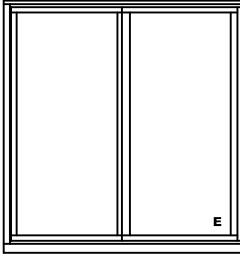

6RW6063

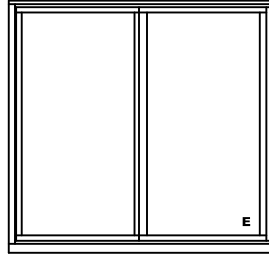

6RW6663

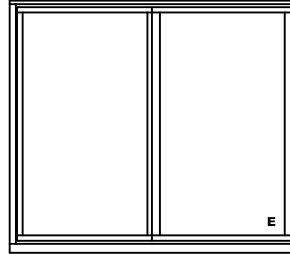

6RW7263

PREMIUM ATLANTIC ALUMINUM ROLLER WINDOW SINGLE UNIT FLORIDA ELEVATIONS

• Scale: 1/4"=1'-0"

UNIT SIZE	26 1/2"(673)	37"(940)	53 1/8"(1349)	74"(1880)
ROUGH OPENING	26"(660)	36 1/2"(927)	52 5/8"(1337)	73 1/2"(1867)
FRAME SIZE	25 1/2"(648)	36"(914)	52 1/8"(1324)	73"(1854)
DAYLIGHT OPENING	8 5/32"[2](207)	13 13/32"[2](341)	21 15/32"[2](545)	31 29/32"[2](810)
26"(660) 26 1/2"(673) 25"(635) 18 7/16"(468)				
38 3/8"(975) 37 7/8"(962) 37 3/8"(949) 30 13/16"(783)				
50 5/8"(1286) 50 1/8"(1273) 49 5/8"(1260) 43 1/16"(1094)				
63"(1600) 62 1/2"(1588) 62"(1575) 55 7/16"(1408)				

ELEVATION SYMBOL LEGEND:
 VALUES IN () ARE IN MILLIMETER CONVERSIONS
E BASIC UNIT CLEAR OPENING EXCEEDS 20" IN WIDTH, 24" IN HEIGHT & A MINIMUM OF 5.7 SQ. FT.
NUMBER INDICATES DESIGN PRESSURE (DP) RATING WITH STANDARD GLAZING

Note: Elevations shown DO NOT have exterior trim. Subtract 1/2"(12.7) from M.O. (Masonry Opening) for Unit Sizes. Masonry openings above include Sill Nose, see Trim Options page for Sill Nose specifications. For other Trim Options refer to the Unit Sizing, Rough Opening & Masonry Openings page.